



AIR-COOLED SPLIT-TYPE  
PACKAGED AIR CONDITIONERS

*Changes for the Better*

2003

# **TECHNICAL & SERVICE MANUAL**

---

<Outdoor unit>

**HEAT PUMP** Models **PUH-P8MYA, PUH-P10MYA**  
*(Single and Twin/Triple/Four)*

**For use with the R407C**

# Contents

	Page
<b>1 PRECAUTIONS FOR DEVICES THAT USE R407C REFRIGERANT</b> .....	1
[1] Storage of Piping Material .....	2
[2] Piping Machining .....	3
[3] Necessary Apparatus and Materials and Notes on Their Handling .....	4
[4] Brazing .....	5
[5] Airtightness Test .....	6
[6] Vacuuming .....	6
[7] Charging of Refrigerant .....	7
<b>2 SPECIFICATIONS</b> .....	8
<b>3 EXTERNAL DIMENSIONS</b> .....	10
<b>4 ELECTRICAL WIRING DIAGRAM</b> .....	11
[1] Outdoor Unit .....	11
[2] Skelton of Indoor/Outdoor Connection .....	12
<b>5 Technical Data of PUH-8/10YD to Meet LVD</b> .....	13
[1] Standard Operation Data .....	13
[2] Cooling Capacity Curves .....	15
[3] Heating Capacity Curves .....	15
[4] Capacity Reduction Ratio due to Changes in Piping Length .....	16
[5] Center of Gravity (Outdoor unit) .....	17
[6] NC Curve (Outdoor unit) .....	18
<b>6 SERVICE DATA</b> .....	19
[1] Appearance of Equipment .....	19
[2] Refrigerant Circuit .....	21
[3] Limitation of Refrigerant Piping Length .....	21
[4] Refrigerant Piping .....	22
[5] Refrigerant Charge .....	22
[6] Operation Range .....	22
<b>7 CONTROL</b> .....	23
[1] Composition of Control .....	23
[2] Control specifications .....	24
[3] Function of switches and connectors (outdoor unit) .....	28
[4] Simple parts check method .....	36
[5] Reference Data .....	37
[6] Troubleshooting of each part .....	38
[7] Emergency operation .....	41
[8] Self-diagnosis and troubleshooting .....	43
<b>8 Test run</b> .....	53

## 1 PRECAUTIONS FOR DEVICES THAT USE R407C REFRIGERANT

### Caution

#### **Do not use the existing refrigerant piping.**

- The old refrigerant and refrigerator oil in the existing piping contains a large amount of chlorine which may cause the refrigerator oil of the new unit to deteriorate.

**Use refrigerant piping made of phosphorus deoxidized copper and copper alloy seamless pipes and tubes". In addition, be sure that the inner and outer surfaces of the pipes are clean and free of hazardous sulphur, oxides, dust/dirt, shaving particles, oils, moisture, or any other contaminant.**

- Contaminants on the inside of the refrigerant piping may cause the refrigerant residual oil to deteriorate.

**Store the piping to be used during installation indoors and keep both ends of the piping sealed until just before brazing. (Store elbows and other joints in a plastic bag.)**

- If dust, dirt, or water enters the refrigerant cycle, deterioration of the oil and compressor trouble may result.

**Use ester oil, ether oil or alkylbenzene (small amount) as the refrigerator oil to coat flares and flange connections.**

- The refrigerator oil will degrade if it is mixed with a large amount of mineral oil.

#### **Use liquid refrigerant to seal the system.**

- If gas refrigerant is used to seal the system, the composition of the refrigerant in the cylinder will change and performance may drop.

#### **Do not use a refrigerant other than R407C.**

- If another refrigerant (R22, etc.) is used, the chlorine in the refrigerant may cause the refrigerator oil to deteriorate.

#### **Use a vacuum pump with a reverse flow check valve.**

- The vacuum pump oil may flow back into the refrigerant cycle and cause the refrigerator oil to deteriorate.

#### **Do not use the following tools that have been used with conventional refrigerants.**

**(Gauge manifold, charge hose, gas leak detector, reverse flow check valve, refrigerant charge base, vacuum gauge, refrigerant recovery equipment)**

- If the conventional refrigerant and refrigerator oil are mixed in the R407C, the refrigerant may deteriorate.
- If water is mixed in the R407C, the refrigerator oil may deteriorate.
- Since R407C does not contain any chlorine, gas leak detectors for conventional refrigerants will not react to it.

#### **Do not use a charging cylinder.**

- Using a charging cylinder may cause the refrigerant to deteriorate.

#### **Be especially careful when managing the tools.**

- If dust, dirt, or water gets in the refrigerant cycle, the refrigerant may deteriorate.

**If the refrigerant leaks, recover the refrigerant in the refrigerant cycle, then recharge the cycle with the specified amount of the liquid refrigerant indicated on the air conditioner.**

- Since R407C is a nonazeotropic refrigerant, if additionally charged when the refrigerant leaked, the composition of the refrigerant in the refrigerant cycle will change and result in a drop in performance or abnormal stopping.

## [1] Storage of Piping Material

### (1) Storage location



Store the pipes to be used indoors. (Warehouse at site or owner's warehouse)  
Storing them outdoors may cause dirt, waste, or water to infiltrate.

### (2) Pipe sealing before storage

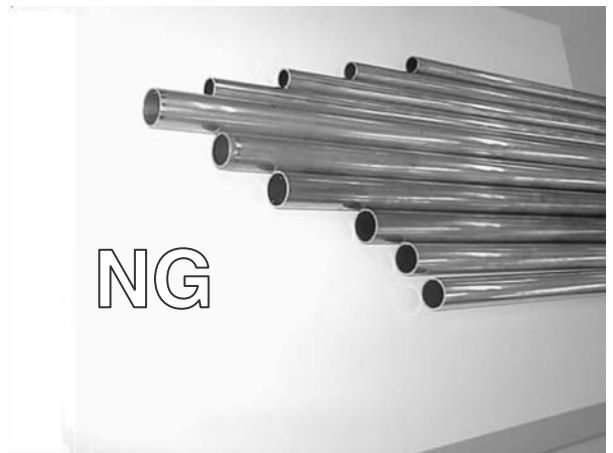
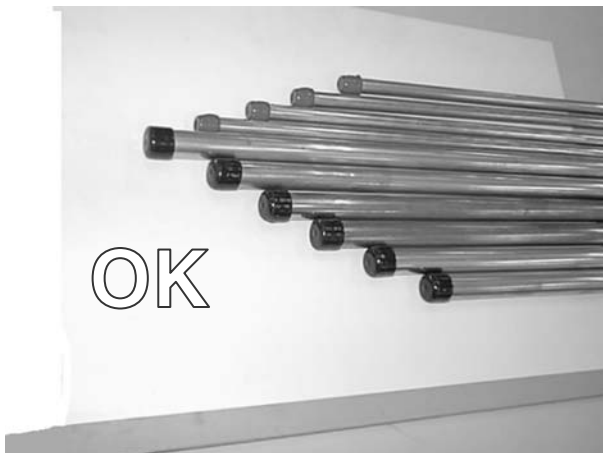

Both ends of the pipes should be sealed until immediately before brazing.  
Wrap elbows and T's in plastic bags for storage.

\* The new refrigerator oil is 10 times more hygroscopic than the conventional refrigerator oil (such as Suniso). Water infiltration in the refrigerant circuit may deteriorate the oil or cause a compressor failure. Piping materials must be stored with more care than with the conventional refrigerant pipes.

## [2] Piping Machining

Use ester oil, ether oil or alkylbenzene (small amount) as the refrigerator oil to coat flares and flange connections.



Use only the necessary minimum quantity of oil.

### Reason:

1. The refrigerator oil used for the equipment is highly hygroscopic and may introduce water inside.

### Notes:

- Introducing a great quantity of mineral oil into the refrigerant circuit may also cause a compressor failure.
- Do not use oils other than ester oil, ether oil or alkylbenzene.

### [3] Necessary Apparatus and Materials and Notes on Their Handling

The following tools should be marked as dedicated tools for R407C.

<<Comparison of apparatus and materials used for R407C and for R22>>

Apparatus Used	Use	R22	R407C
Gauge manifold	Evacuating, refrigerant filling	Current product	⊙
Charging hose	Operation check	Current product	⊙
Charging cylinder	Refrigerant charging	Current product	⊙ Do not use
Gas leakage detector	Gas leakage check	Current product	⊙ Shared with R134a
Refrigerant collector	Refrigerant collection	R22	⊙ For R407C use only
Refrigerant cylinder	Refrigerant filling	R22	⊙ Identification of dedicated use for R407C: Record refrigerant name and put brown belt on upper part of cylinder.
Vacuum pump	Vacuum drying	Current product	△ Can be used by attaching an adapter with a check valve.
Vacuum pump with a check valve		Current product	△
Flare tool	Flaring of pipes	Current product	△
Bender	Bending of pipes	Current product	△
Application oil	Applied to flared parts	Current product	⊙ Ester oil or Ether oil or Alkybenzene (Small amount)
Torque wrench	Tightening of flare nuts	Current product	△
Pipe cutter	Cutting of pipes	Current product	△
Welder and nitrogen cylinder	Welding of pipes	Current product	△
Refrigerant charging meter	Refrigerant charging	Current product	△
Vacuum gauge	Checking the vacuum degree	Current product	△

Symbols: ⊙ To be used for R407C only.

△ Can also be used for conventional refrigerants.

Tools for R407C must be handled with more care than those for conventional refrigerants. They must not come into contact with any water or dirt.

## [4] Brazing

No changes from the conventional method, but special care is required so that foreign matter (ie. oxide scale, water, dirt, etc.) does not enter the refrigerant circuit.

Example: Inner state of brazed section

When non-oxide brazing was not used

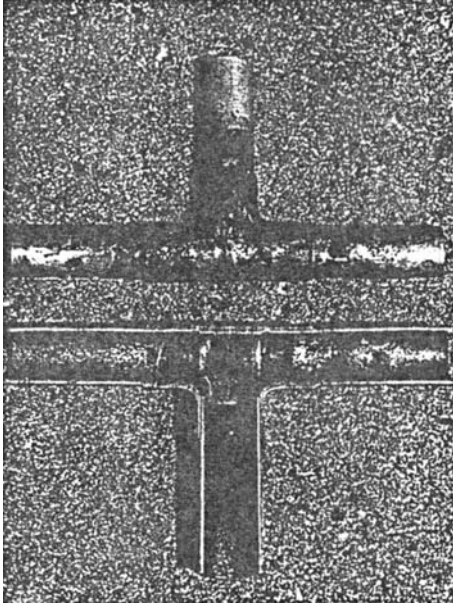

When non-oxide brazing was used

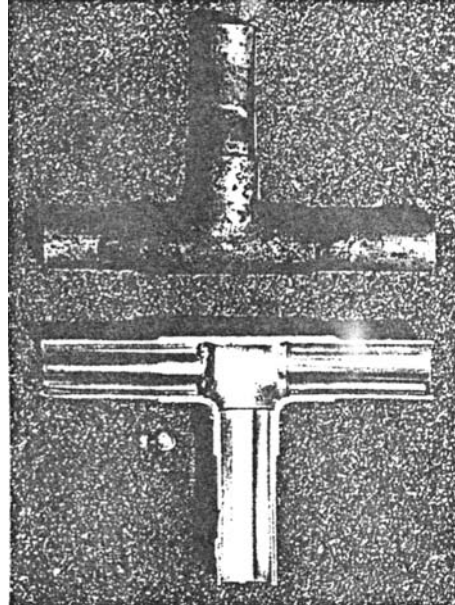

### Items to be strictly observed:

1. Do not conduct refrigerant piping work outdoors on a rainy day.
2. Apply non-oxide brazing.
3. Use a brazing material (BCuP-3) which requires no flux when brazing between copper pipes or between a copper pipe and copper coupling.
4. If installed refrigerant pipes are not immediately connected to the equipment, then braze and seal both ends of them.

### Reasons:

1. The new refrigerant oil is 10 times more hygroscopic than the conventional oil. The probability of a machine failure if water infiltrates is higher than with conventional refrigerant oil.
2. A flux generally contains chlorine. A residual flux in the refrigerant circuit may generate sludge.

### Note:

- Commercially available antioxidants may have adverse effects on the equipment due to its residue, etc. When applying non-oxide brazing, use nitrogen.

## [5] Airtightness Test

No changes from the conventional method. Note that a refrigerant leakage detector for R22 cannot detect R407C leakage.

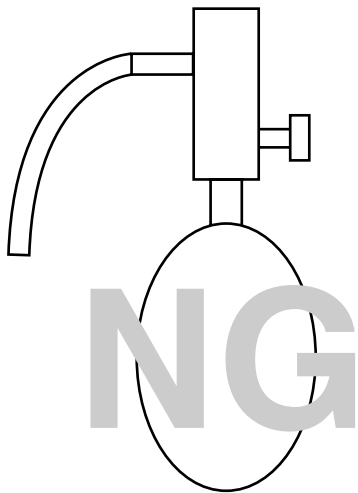

Halide torch

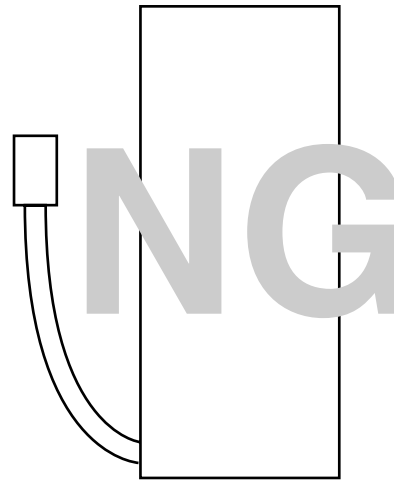

R22 leakage detector

### Items to be strictly observed:

1. Pressurize the equipment with nitrogen up to the design pressure and then judge the equipment's airtightness, taking temperature variations into account.
2. When investigating leakage locations using a refrigerant, be sure to use R407C.
3. Ensure that R407C is in a liquid state when charging.

### Reasons:

1. Use of oxygen as the pressurized gas may cause an explosion.
2. Charging with R407C gas will lead the composition of the remaining refrigerant in the cylinder to change and this refrigerant can then not be used.

### Note:

- A leakage detector for R407C is sold commercially and it should be purchased.

## [6] Vacuuming

1. Vacuum pump with check valve

A vacuum pump with a check valve is required to prevent the vacuum pump oil from flowing back into the refrigerant circuit when the vacuum pump power is turned off (power failure).

It is also possible to attach a check valve to the actual vacuum pump afterwards.

2. Standard degree of vacuum for the vacuum pump

Use a pump which reaches 0.5 Torr (500 MICRON) or below after 5 minutes of operation.

In addition, be sure to use a vacuum pump that has been properly maintained and oiled using the specified oil. If the vacuum pump is not properly maintained, the degree of vacuum may be too low.

3. Required accuracy of the vacuum gauge

Use a vacuum gauge that can measure up to 5 Torr. Do not use a general gauge manifold since it cannot measure a vacuum of 5 Torr.

4. Evacuating time

- Evacuate the equipment for 1 hour after  $-755$  mmHg (5 Torr) has been reached.
- After evacuating, leave the equipment for 1 hour and make sure the that vacuum is not lost.

5. Operating procedure when the vacuum pump is stopped

In order to prevent a backflow of the vacuum pump oil, open the relief valve on the vacuum pump side or loosen the charge hose to drawn in air before stopping operation.

The same operating procedure should be used when using a vacuum pump with a check valve.



## [7] Charging of Refrigerant

R407C must be in a liquid state when charging, because it is a non-azeotropic refrigerant.

For a cylinder with a syphon attached

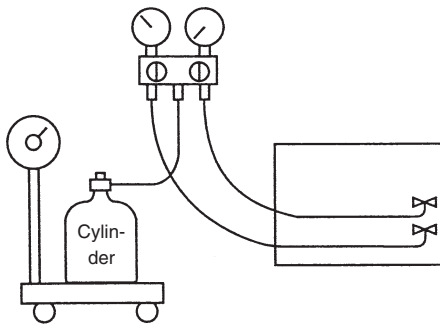

For a cylinder without a syphon attached

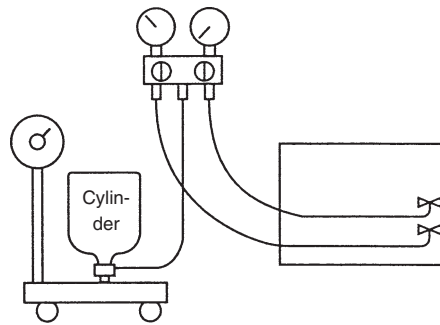

Cylinder color identification R407C-Gray  
R410A-Pink

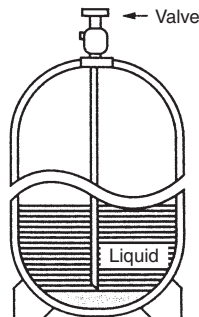

Charged with liquid refrigerant

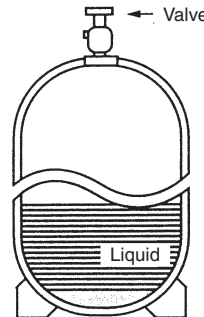

### Reasons:

1. R407C is a mixture of 3 refrigerants, each with a different evaporation temperature. Therefore, if the equipment is charged with R407C gas, then the refrigerant whose evaporation temperature is closest to the outside temperature is charged first while the rest of refrigerants remain in the cylinder.

### Note:

- In the case of a cylinder with a syphon, liquid R407C is charged without turning the cylinder up side down. Check the type of cylinder before charging.

## 2 SPECIFICATIONS

Specifications of air-source heat pump type packaged air conditioner (Outdoor unit)												
Model name	PUH-P8MYA		Quantity									
		Cooling	Heating									
Capacity	kcal/h	18,000	20,400									
	kW	20.9	23.7									
Power source	3N~ 380/400/415 V 50 Hz											
Power input	kW	7.27	7.17									
Current	A	13.0	12.8									
Fan	Type x Quantity	Propeller fan × 1										
	Airflow rate	m <sup>3</sup> /min	185									
	Motor output	kW	0.38									
Compressor	Type	Hermetic										
	Motor output	kW	5.5									
	Crankcase heater	kW	0.05 (240V)									
Refrigerant/Lubricant	R407C/FVC68D											
External finish	Steel plate painting with polyester powder (MUNSELL 5Y8/1 or similar)											
External dimension	mm	1,715(H) × 990(W) × 840(L)										
Protection device	High pressure protection	MPa	3.3									
	Compressor/Fan	Overcurrent protection/Thermal switch										
Refrigerant piping diameter	Liquid/Gas	mm	ø12.7 Flare / ø25.4 Flange									
Indoor unit	PEH-P8MYA											
Noise level	dB (A)	56										
Net weight	kg	215										
Operating temperature range	Indoor: 15 °CWB~24 °CWB Outdoor: -5 °CDB~46 °CDB		Indoor: 15 °CDB~27 °CDB Outdoor: -12 °CWB~18 °CWB									
Notes:	<p>1. Cooling/Heating capacity indicates the maximum value at operation under the following condition.</p> <table border="0"> <tr> <td><b>Cooling</b></td> <td>Indoor: 27 °CDB/19 °CWB</td> <td>Outdoor: 35 °CDB</td> </tr> <tr> <td><b>Heating</b></td> <td>Indoor: 20 °CDB</td> <td>Outdoor: 7 °CDB/6 °CWB</td> </tr> <tr> <td></td> <td>Pipe length: 7.5m</td> <td>Height difference: 0m</td> </tr> </table> <p>2. Works not included: Installation/Foundation work, Electrical connection work, Duct work, Insulation work, Power source switch, and other items not specified in this specifications.</p>			<b>Cooling</b>	Indoor: 27 °CDB/19 °CWB	Outdoor: 35 °CDB	<b>Heating</b>	Indoor: 20 °CDB	Outdoor: 7 °CDB/6 °CWB		Pipe length: 7.5m	Height difference: 0m
<b>Cooling</b>	Indoor: 27 °CDB/19 °CWB	Outdoor: 35 °CDB										
<b>Heating</b>	Indoor: 20 °CDB	Outdoor: 7 °CDB/6 °CWB										
	Pipe length: 7.5m	Height difference: 0m										

**Specifications of air-source heat pump type packaged air conditioner  
(Outdoor unit)**

Model name	<b>PUH-P10MYA</b>	Quantity	
------------	-------------------	----------	--

			Cooling	Heating
Capacity	kcal/h		22,400	26,200
	kW		26.0	30.5
Power source			3N~ 380/400/415V 50Hz	
Power input	kW		9.02	8.62
Current	A		16.0	15.4
Fan	Type x Quantity		Propeller fan × 1	
	Airflow rate	m <sup>3</sup> /min	185	
	Motor output	kW	0.38	
Compressor	Type		Hermetic	
	Motor output	kW	7.5	
	Crankcase heater	kW	0.05 (240V)	
Refrigerant/Lubricant			R407C/FVC68D	
External finish			Steel plate painting with polyester powder (MUNSEL 5Y8/1 or similar)	
External dimension	mm		1,715(H) × 990(W) × 840(L)	
Protection device	High pressure protection	MPa	3.3	
	Compressor/Fan		Overcurrent protection/Thermal switch	
Refrigerant piping diameter	Liquid/Gas	mm	ø12.7 Flare / ø28.6 Flange	
Indoor unit			PEH-P10MYA	
Noise level		dB (A)	57	
Net weight		kg	220	
Operating temperature range			Indoor: 15 °CWB~24 °CWB Outdoor: -5 °CDB~46 °CDB	Indoor: 15 °CDB~27 °CDB Outdoor: -12 °CWB~18 °CWB

Notes:	<p>1. Cooling/Heating capacity indicates the maximum value at operation under the following condition.</p> <table border="0"> <tr> <td><b>Cooling</b></td> <td>Indoor: 27 °CDB/19 °CWB</td> <td>Outdoor: 35 °CDB</td> </tr> <tr> <td><b>Heating</b></td> <td>Indoor: 20 °CDB</td> <td>Outdoor: 7 °CDB/6 °CWB</td> </tr> <tr> <td></td> <td>Pipe length: 7.5 m</td> <td>Height difference: 0 m</td> </tr> </table>				<b>Cooling</b>	Indoor: 27 °CDB/19 °CWB	Outdoor: 35 °CDB	<b>Heating</b>	Indoor: 20 °CDB	Outdoor: 7 °CDB/6 °CWB		Pipe length: 7.5 m	Height difference: 0 m
	<b>Cooling</b>	Indoor: 27 °CDB/19 °CWB	Outdoor: 35 °CDB										
<b>Heating</b>	Indoor: 20 °CDB	Outdoor: 7 °CDB/6 °CWB											
	Pipe length: 7.5 m	Height difference: 0 m											
	<p>2. Works not included: Installation/Foundation work, Electrical connection work, Duct work, Insulation work, Power source switch, and other items not specified in this specifications.</p>												

### 3 EXTERNAL DIMENSIONS

• Models PUH-P8MYA/P10MYA

- <Accessory>
- Refrigerant connecting pipe ..... 1pc.  
(The connecting pipe is fixed with the unit)
- Packing for connecting pipe ..... 1pc.  
(It is attached control box cover)
- Conduit mounting plate  
(Painted the same color as the unit body)  
  - φ27 ..... 1pc.
  - φ34 ..... 1pc.
  - φ40 ..... 1pc.
- Tapping screw 4 x 12 ..... 4pcs.

Note: 1. Please leave a space under the outdoor unit for the piping when you connected the piping from the bottom.  
(Please be careful not to close the hole of the bottom plate by the basement.)  
 2. It is possible to change to φ27 or φ34 by selecting the conduit mounting plate.  
 3. The hole size can be selected to φ27 or φ34 or φ40 by selecting the conduit mounting plate.

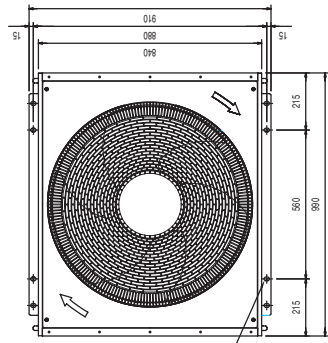

4-1x120 holes  
<For mounting  
anchor bolt M6s  
(Field supply)>

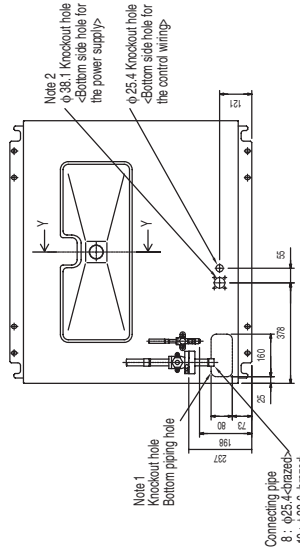
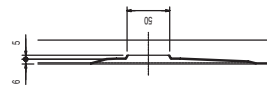

Cross section Y-Y

Cross section X-X

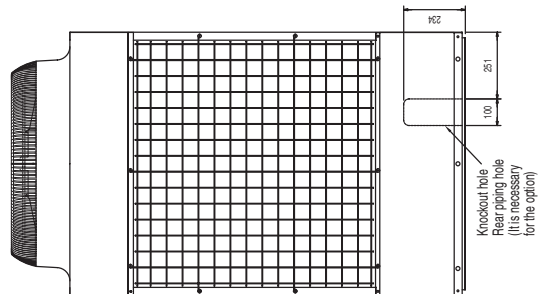
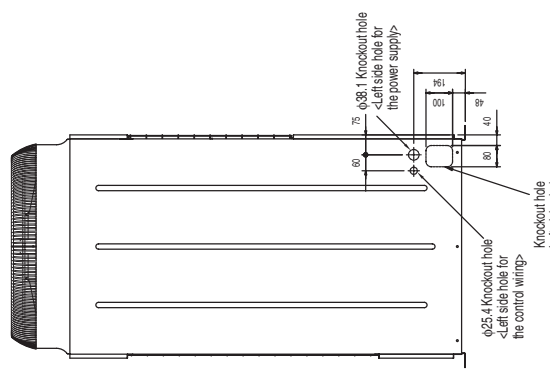
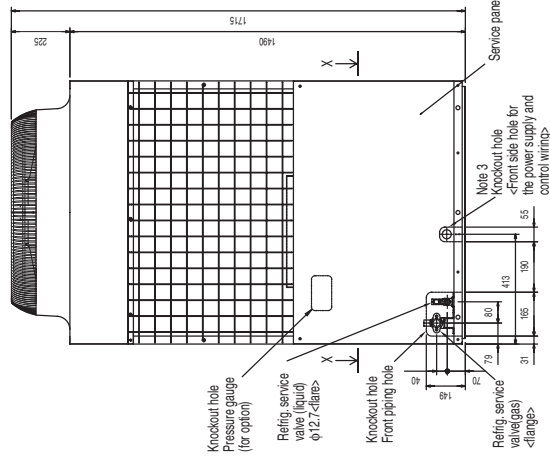
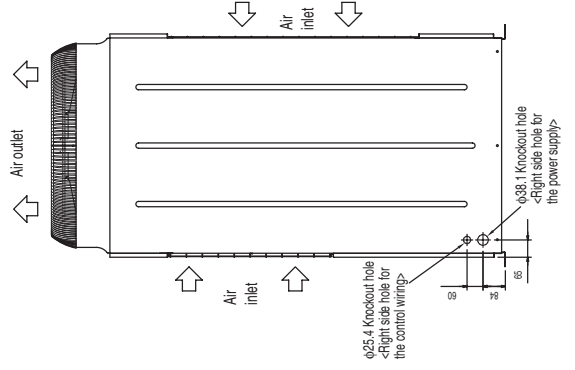

## 4 ELECTRICAL WIRING DIAGRAM

### [1] Outdoor Unit

- Model PUH-P8MYA/P10MYA

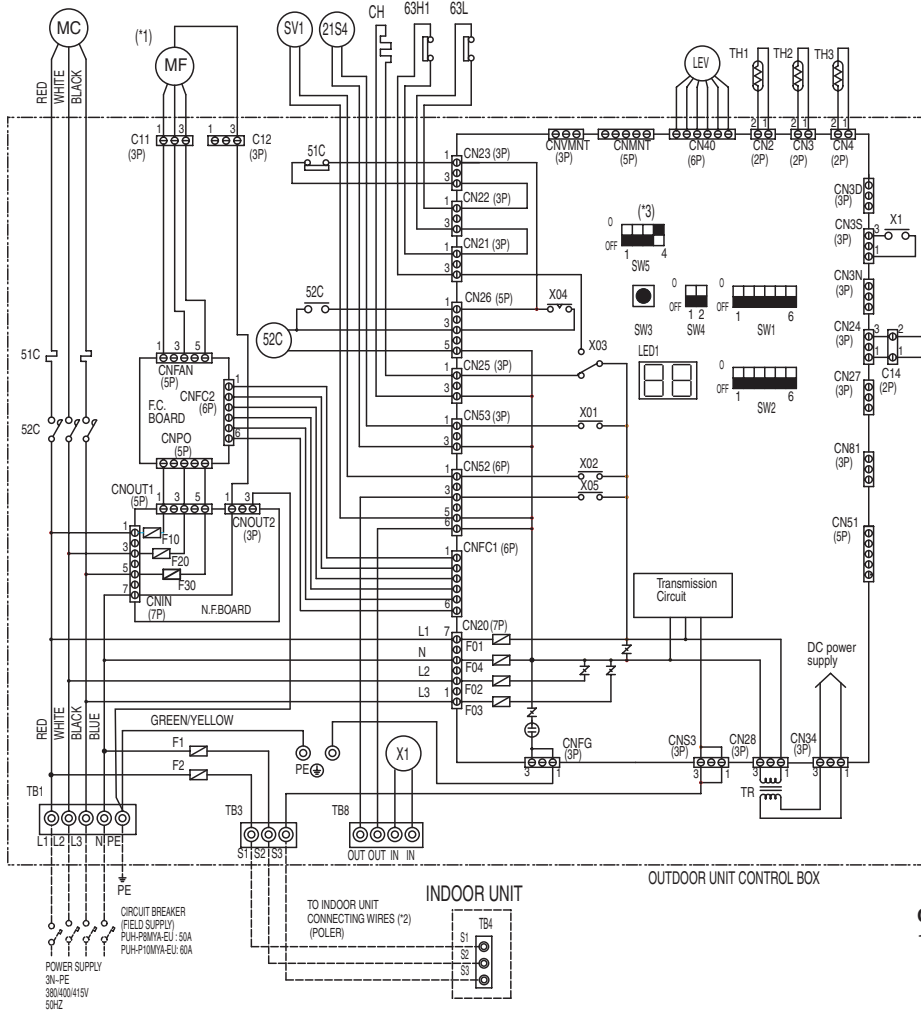

#### Note :

1. Be sure to apply earth work to the unit. (Use the earth terminal of TB1.)
2. The dotted lines show field wiring.
3. Color of earth wire is yellow and green twisting.
4. This motor (\*1) includes auto reset type internal thermostat.
5. Indoor and outdoor connecting wires (\*2) are made with polarities, make sure matching wiring and terminal.
6. SW5 (\*3) is shown as PUH-P10MYA setting. In case of PUH-P8MYA setting is shown as below.



#### Caution :

1. To protect compressor from abnormal current, over current relays is installed. Therefore, do not change factory set value of over current relays.

Symbol	Name	Symbol	Name	
F1, F2	FUSE (15A 250VAC CLASS T)	SW1~SW5	SWITCH (MAIN BORD)	
F01~F04	FUSE (6.3A 250VAC CLASS F)	21S4	4-WAY VALVE	
F10~F30	FUSE (6.3A 250VAC CLASS F)	SV1	SOLENOID VALVE	
51C	OVER CURRENT RELAY (COMPRESSOR)	CH	CRANK CASE HEATER (COMPRESSOR)	
52C	MAGNETIC CONTACTOR (COMPRESSOR)	LEV	ELECTRINIC EXPANSION VALVE	
63L	PRESSURE SWITCH (LOW PRESSURE)	TH1	THERMISTOR	
63H1	PRESSURE SWITCH (HIGH PRESSURE)	TH2		LIQUID TEMP.
63H2	PRESSURE SWITCH (FOR CONTROL)	TH3		DISCHARGE TEMP.
MC	COMPRESSOR MOTOR		COND./EVA. TEMP.	
MF	FAN MOTOR (OUTDOOR)	TB1	POWER SOURCE TERMINAL BLOCK	
TR	TRANSFORMER	TB3, 4	OUTDOOR/INDOOR CONNECTION TERMINAL BLOCK	
X1	AUXILIARY RELAY (FOR 16, 20HP)	TB8	TERMINAL BLOCK (FOR 16, 20HP)	
LED 1	LED (FOR SERVICE)	C11, C12	CONNECTOR (FAN MOTOR)	
XO1~XO5	AUXILIARY RELAY (MAIN BOARD)	C14	CONNECTOR (63H2)	
CN2,CN20~28	CONNECTOR MAIN BOARD	CAFAN, CNFC2	CONNECTOR (F. C. BOARD)	
CN3,34,30,3N,3S		CNPO	CONNECTOR (N, F. BOARD)	
CN4,40,51~53,81		CNOUT1, 2		
CNFC1, FG, S3		CNIN		
CNMT,VMNT				

## [2] Skelton of Indoor/Outdoor Connection

### (1) Applicable combinations of 8 & 10HP [PUH-P8MYA/P10MYA]

Indoor Units	Single	50 : 50	33 : 33 : 33	25 : 25 : 50	20 : 40 : 40	25 : 25 : 25 : 25	
	8HP	4HP+4HP	2.5HP+2.5HP +2.5HP	2HP+2HP +4HP	1.6HP+3HP +3HP	2HP+2HP +2HP+2HP	
PUH-P8MYA	PEH-P*MYA	○	-	-	-	-	
	PLH-P*KAH, PLH-P*AAH	-	○	○	○	○	
	PLA-P*KA, PLA-P*AA	-	○	○	○	○	
	PEHD-P*EAH, PEAD-P*EA	-	○	○	○	○	
	PCH-P*GAH, PCA-P*GA	-	○	○	○	○	
	PKH-P*GALH, PKH-P*FALH	-	○	○	○	○	
	PKA-P*GAL, PKA-P*FAL	-	○	○	○	○	
PSH-P*GAH, PSA-P*GA	-	○	-	-	-	-	
PUH-P10MYA	Indoor Units	10HP	5HP+5HP	3HP+3HP +3HP	2.5HP+2.5HP +5HP	2HP+4HP +4HP	2.5HP+2.5HP+ 2.5HP+2.5HP
	PEH-P*MYA	○	-	-	-	-	-
	PLH-P*KAH, PLH-P*AAH	-	○	○	○	○	○
	PLA-P*KA, PLA-P*AA	-	○	○	○	○	○
	PEHD-P*EAH, PEAD-P*EA	-	○	○	○	○	○
	PCH-P*GAH, PCA-P*GA	-	○	○	○	○	○
	PKH-P*GALH, PKH-P*FALH	-	-	○	-	○	○
PKA-P*GAL, PKA-P*FAL	-	○	○	-	-	-	
PSH-P*GAH, PSA-P*GA	-	○	○	-	-	-	
Indoor Units	16HP	-	-	-	-	-	
PEH-P*MYA	○	-	-	-	-	-	
Indoor Unit	20HP	-	-	-	-	-	
PEH-P*MYA	○	-	-	-	-	-	
Multi distributor pipes (Option)	-	SDD-50WSA-E	SDT-111SA-E	SDT-112SA-E	SDT-122SA-E	SDT-1111SA-E	

\* indicates applicable HP

### (2) System

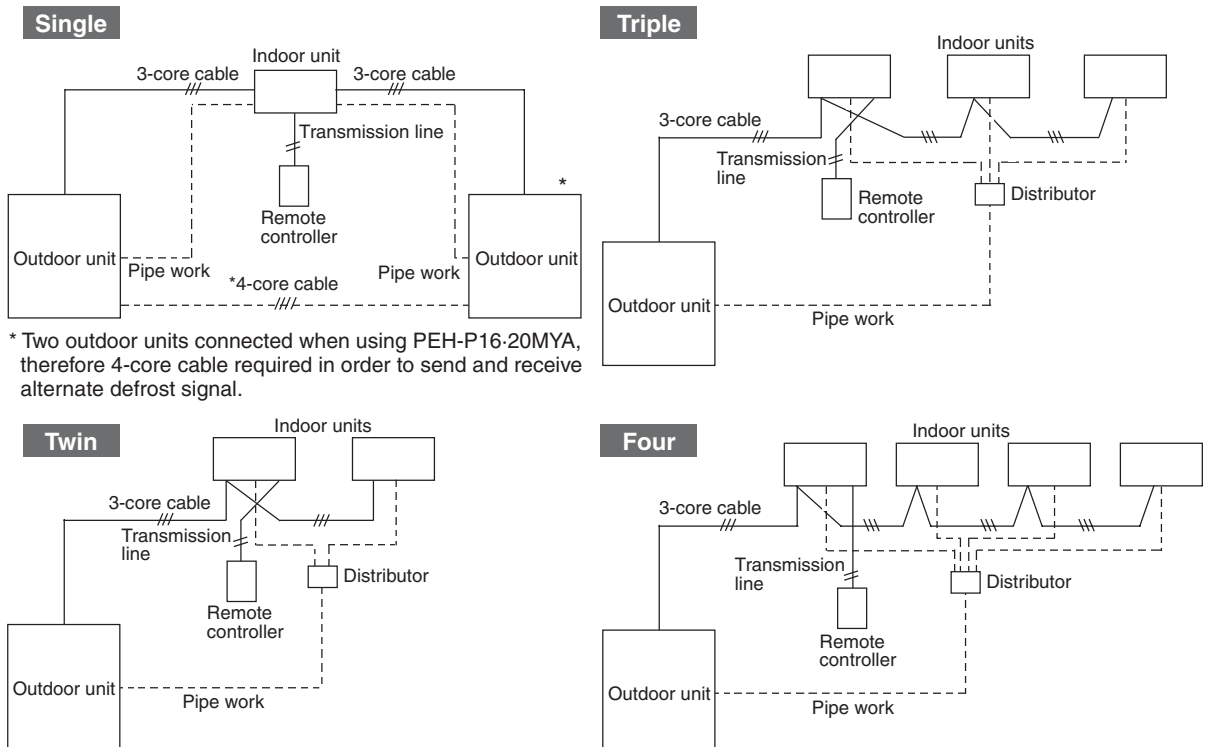

## 5 Technical Data of PUH-P8MYA/P10MYA to Meet LVD

### [1] Standard Operation Data

#### (1) PUH-P8MYA

Operating condition			Cooling			Heating			
Operating condition	Voltage	V	380	400	415	380	400	415	
	Power source frequency	Hz	50	50	50	50	50	50	
	Indoor air condition (DB/WB)	°C	27/19	27/19	27/19	20/-	20/-	20/-	
	Outdoor air condition (DB/WB)	°C	35/-	35/-	35/-	7/6	7/6	7/6	
	Piping length	m	7.5	7.5	7.5	7.5	7.5	7.5	
	Refrigerant charge	kg	7.9	7.9	7.9	7.9	7.9	7.9	
Electrical characteristics	Outdoor unit	Current	A	13.0	13.0	13.0	12.8	12.8	12.8
		Input	kW	7.27	7.27	7.27	7.17	7.17	7.17
		Compressor current	A	11.9	11.9	11.9	11.7	11.7	11.7
		Fan current	A	1.1	1.1	1.1	1.1	1.1	1.1
	Indoor unit	Current	A	1.12	1.12	1.12	1.12	1.12	1.12
		Input	kW	0.65	0.65	0.65	0.65	0.65	0.65
Refrigerant circuit	Discharge pressure	MPa	2.11	2.11	2.11	1.91	1.91	1.91	
	Suction pressure	MPa	0.48	0.48	0.48	0.40	0.40	0.40	
	Discharge refrigerant temperature	°C	75	75	75	70	70	70	
	Suction refrigerant temperature	°C	6	6	6	0	0	0	
	Liquid pipe temperature (at piping sensor)	°C	46	46	46	0	0	0	
	Compressor shell bottom temperature	°C	35	35	35	30	30	30	

Note: The values listed above indicate that when connected with the indoor unit PEH-P8MYA as representative data.

#### (2) PUH-P10MYA

Operating condition			Cooling			Heating			
Operating condition	Voltage	V	380	400	415	380	400	415	
	Power source frequency	Hz	50	50	50	50	50	50	
	Indoor air condition (DB/WB)	°C	27/19	27/19	27/19	20/-	20/-	20/-	
	Outdoor air condition (DB/WB)	°C	35/-	35/-	35/-	7/6	7/6	7/6	
	Piping length	m	7.5	7.5	7.5	7.5	7.5	7.5	
	Refrigerant charge	kg	8.4	8.4	8.4	8.4	8.4	8.4	
Electrical characteristics	Outdoor unit	Current	A	16.0	16.0	16.0	15.4	15.4	15.4
		Input	kW	9.02	9.02	9.02	8.62	8.62	8.62
		Compressor current	A	14.9	14.9	14.9	14.3	14.3	14.3
		Fan current	A	1.1	1.1	1.1	1.1	1.1	1.1
	Indoor unit	Current	A	1.64	1.64	1.64	1.64	1.64	1.64
		Input	kW	0.94	0.94	0.94	0.94	0.94	0.94
Refrigerant circuit	Discharge pressure	MPa	2.22	2.22	2.22	1.75	1.75	1.75	
	Suction pressure	MPa	0.50	0.50	0.50	0.38	0.38	0.38	
	Discharge refrigerant temperature	°C	80	80	80	65	65	65	
	Suction refrigerant temperature	°C	8	8	8	-1	-1	-1	
	Liquid pipe temperature (at piping sensor)	°C	48	48	48	0	0	0	
	Compressor shell bottom temperature	°C	30	30	30	20	20	20	

Note: The values listed above indicate that when connected with the indoor unit PEH-P10MYA as representative data.

**(3) PUH-P8MYA×2 units**

Operating condition			Cooling		Heating		
Operating condition	Voltage	V	380	415	380	415	
	Power source frequency	Hz	50	50	50	50	
	Indoor air condition(DB/WB)	°C	27/19	27/19	20/-	20/-	
	Outdoor air condition(DB/WB)	°C	35/-	35/-	7/6	7/6	
	Piping length	m	7.5	7.5	7.5	7.5	
	Refrigerant charge *1	kg	7.9	7.9	7.9	7.9	
Electrical characteristics	Outdoor unit *1	Current	A	13.0	13.0	12.8	12.8
		Input	kW	7.27	7.27	7.17	7.17
		Compressor Current	A	11.9	11.9	11.7	11.7
		Fan current	A	1.1	1.1	1.1	1.1
	Indoor unit	Current	A	4.5	4.1	4.5	4.1
		Input	kW	2.30	2.30	2.30	2.30
Refrigerant circuit	Discharge pressure	MPa	2.11	2.11	1.81	1.81	
	Suction pressure	MPa	0.52	0.52	0.40	0.40	
	Discharge refrigerant temperature	°C	75	75	70	70	
	Suction refrigerant temperature	°C	6	6	0	0	
	Liquid pipe temperature (at piping sensor)	°C	46	46	0	0	
	Compressor shell bottom temperature	°C	35	35	30	30	

Note: The values listed above indicate that when connected with the indoor unit PEH-P16MYA as representative data.

\*1: Value for one outdoor unit.

**(4) PUH-P10MYA×2 units**

Operating condition			Cooling		Heating		
Operating condition	Voltage	V	380	415	380	415	
	Power source frequency	Hz	50	50	50	50	
	Indoor air condition(DB/WB)	°C	27/19	27/19	20/-	20/-	
	Outdoor air condition(DB/WB)	°C	35/-	35/-	7/6	7/6	
	Piping length	m	7.5	7.5	7.5	7.5	
	Refrigerant charge *1	kg	8.4	8.4	8.4	8.4	
Electrical characteristics	Outdoor unit *1	Current	A	16.0	16.0	15.4	15.4
		Input	kW	9.02	9.02	8.62	8.62
		Compressor Current	A	14.9	14.9	14.3	14.3
		Fan current	A	1.1	1.1	1.1	1.1
	Indoor unit	Current	A	5.1	4.7	5.1	4.7
		Input	kW	2.50	2.50	2.50	2.50
Refrigerant circuit	Discharge pressure	MPa	2.22	2.22	1.75	1.75	
	Suction pressure	MPa	0.50	0.50	0.38	0.38	
	Discharge refrigerant temperature	°C	80	80	65	65	
	Suction refrigerant temperature	°C	8	8	-1	-1	
	Liquid pipe temperature (at piping sensor)	°C	48	48	0	0	
	Compressor shell bottom temperature	°C	30	30	20	20	

Note: The values listed above indicate that when connected with the indoor unit PEH-P20MYA as representative data.

\*1: Value for one outdoor unit.



## [2] Cooling Capacity Curves

•PUH-P8MYA/P10MYA

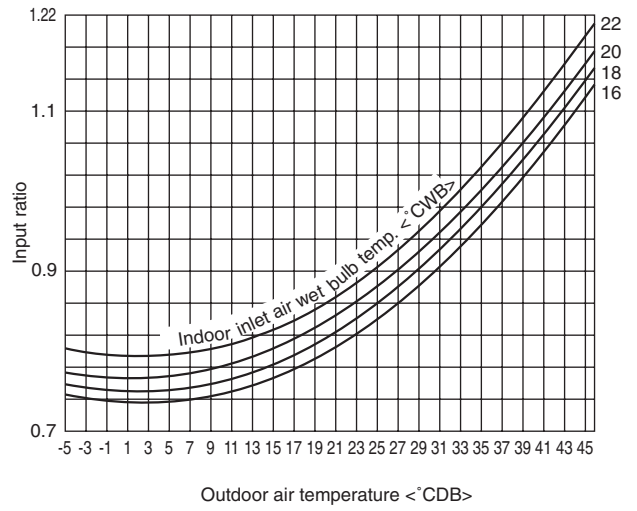
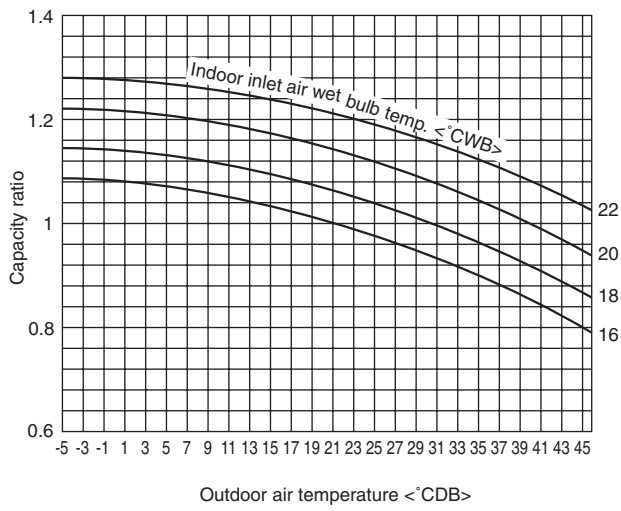

## [3] Heating Capacity Curves

•PUH-P8MYA/P10MYA

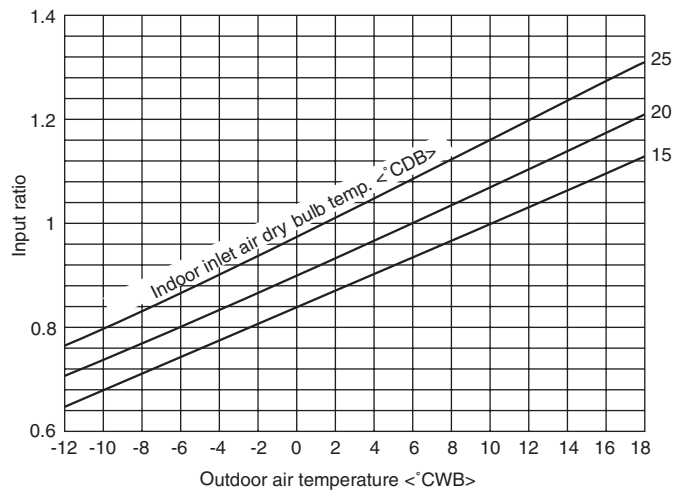
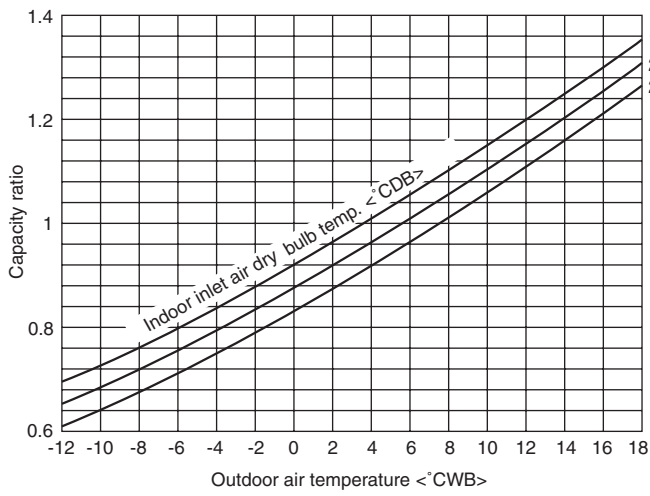

## [4] Capacity Reduction Ratio due to Changes in Piping Length

### (1) Cooling capacity

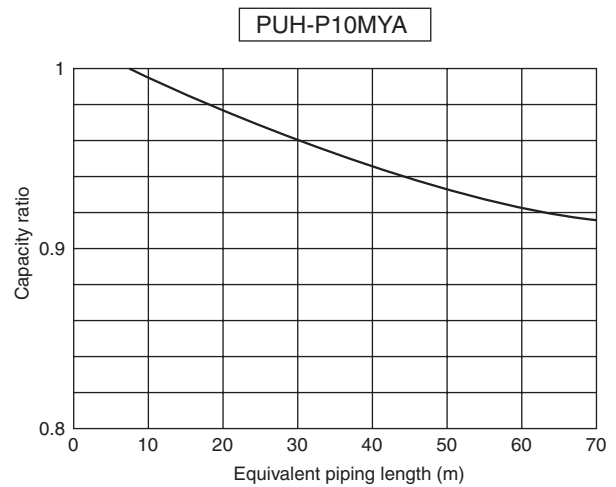
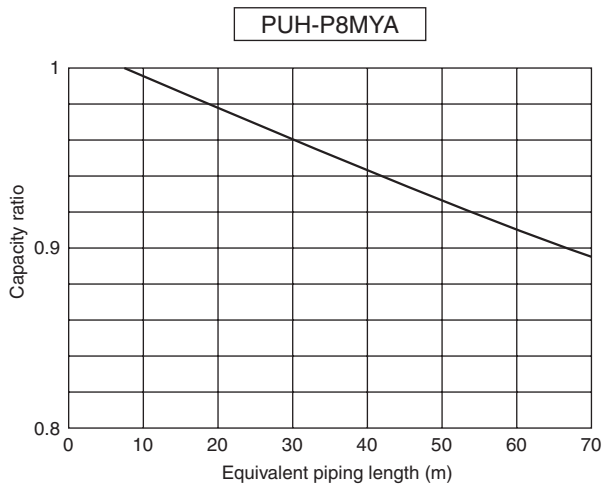

### (2) Heating capacity

Model name	Equivalent piping length		
	- 30m	30 - 50m	50 - 70m
PUH-P8MYA	1.0	0.995	0.99
PUH-P10MYA			

### (3) Calculation formula of equivalent piping length

PUH-P8MYA	Equivalent piping length (m) = Actual piping length (m) + (0.47 × Number of bend)
PUH-P10MYA	Equivalent piping length (m) = Actual piping length (m) + (0.5 × Number of bend)

### (4) Reduction ratio by frosting

Outdoor unit inlet wet bulb temperature (°CWB)	Heating capacity reduction ratio
6	1.0
4	0.98
2	0.88
0	0.85
-2	0.86
-4	0.89
-6	0.92
-8	0.92
-10	0.92

## [5] Center of Gravity (Outdoor unit)

### (1) Caution for Lifting



#### Warning

Lift unit slowly by suspending rope uniformly so that the rope will not slip off or unit will not incline seriously.

Be careful that unit may fall down if the rope is not in a proper position as the center or gravity of unit is being inclined.

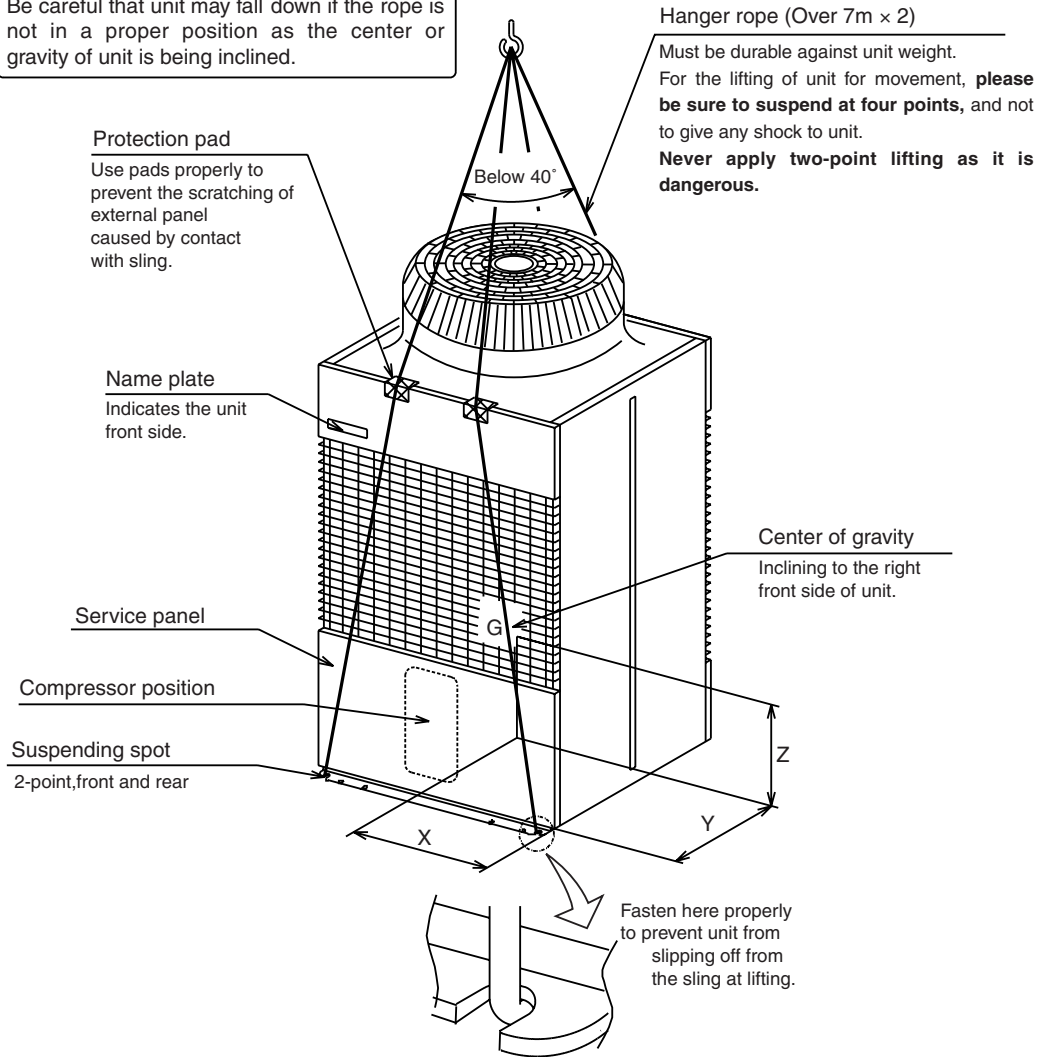

Item	Center of gravity (mm)			Net weight (kg)
	X	Y	Z	
Model name				
PUH-P8MYA	330	350	490	215
PUH-P10MYA	300	330	510	220

## [6] NC Curve (Outdoor unit)

### (1) Octave Band Analysis

#### 1) PUH-P8MYA

Measurement condition

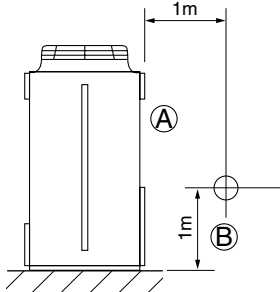

Sound pressure level in anechoic room
56 dB (A)

63Hz	125Hz	250Hz	500Hz	1000Hz	2000Hz	4000Hz	8000Hz	(dB)
63	59	56	55	50	45	42	39	

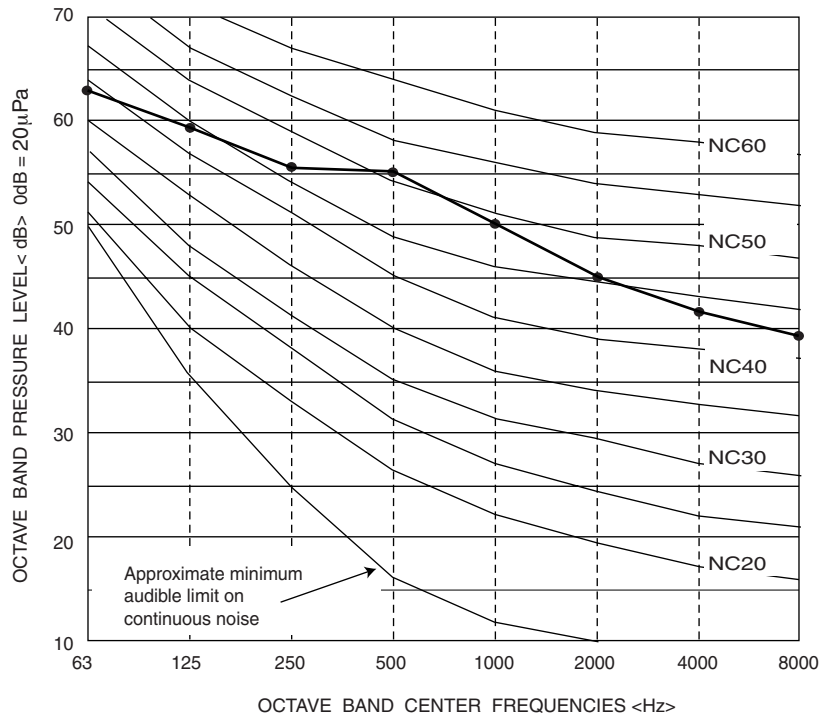

Note: The measuring point is 1m from the bottom of the unit (1m from the front of the unit).

#### 2) PUH-P10MYA

Measurement condition

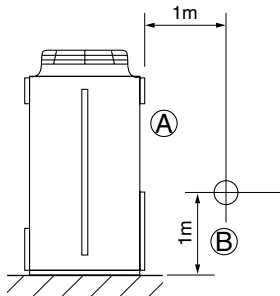

Sound pressure level in anechoic room
57 dB (A)

63Hz	125Hz	250Hz	500Hz	1000Hz	2000Hz	4000Hz	8000Hz	(dB)
63	60	56	56	51	47	44	40	

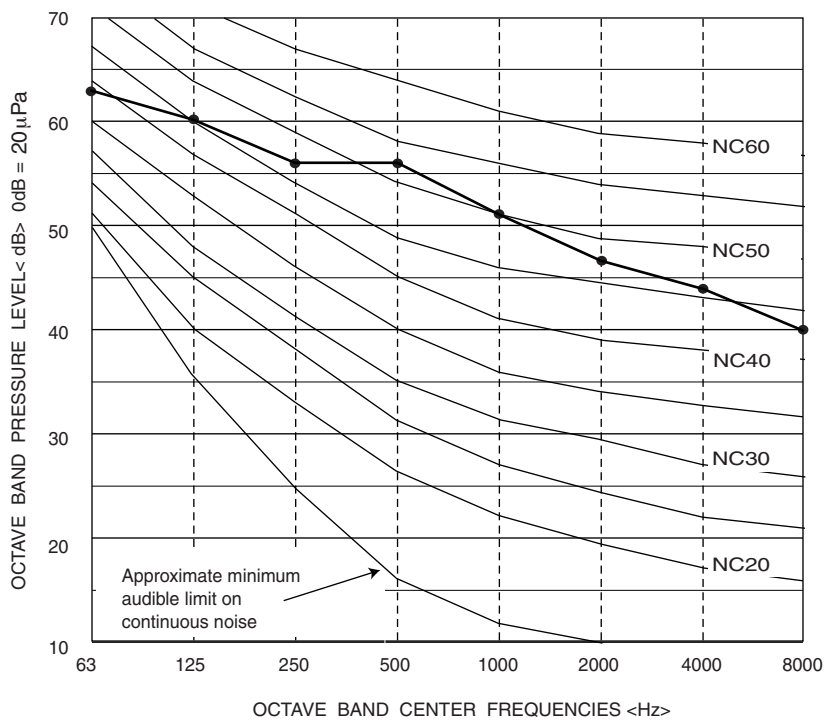

Note: The measuring point is 1m from the bottom of the unit (1m from the front of the unit).

## 6 SERVICE DATA

### [1] Appearance of Equipment

#### • PUH-P8MYA/P10MYA Detail of Electrical Parts Box

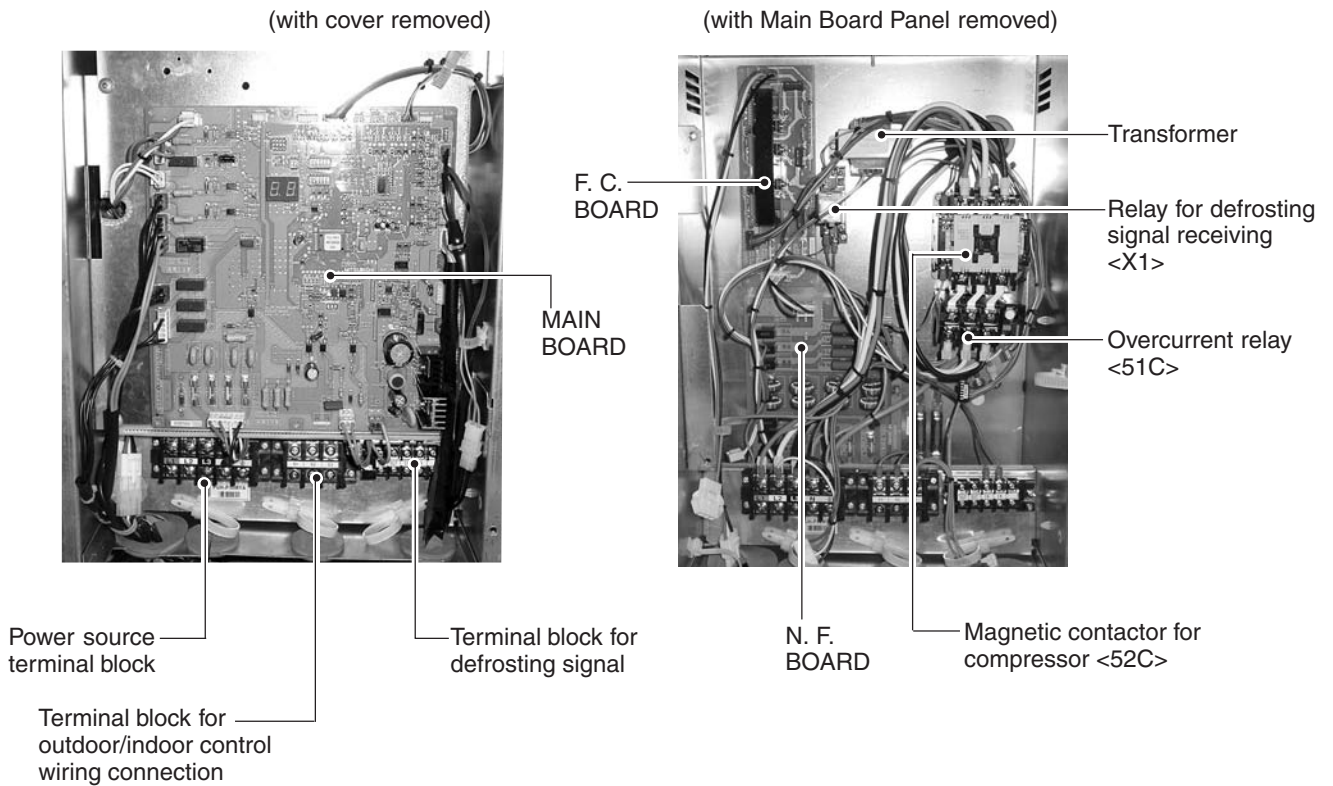

#### • PUH-P8MYA/P10MYA (with cover removed)

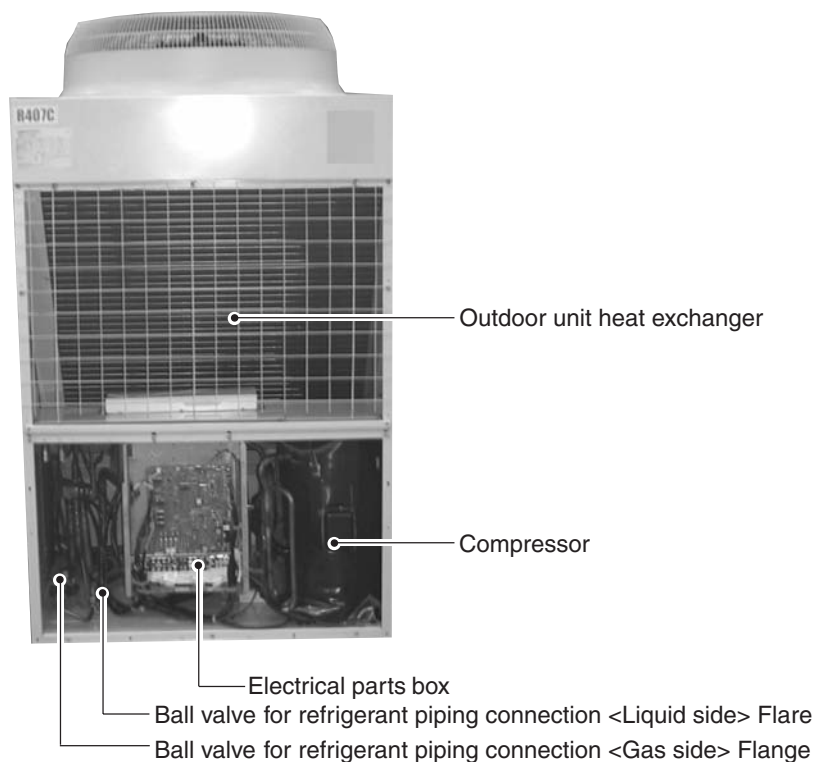

• PUH-P8MYA/P10MYA (Detail of machine room)

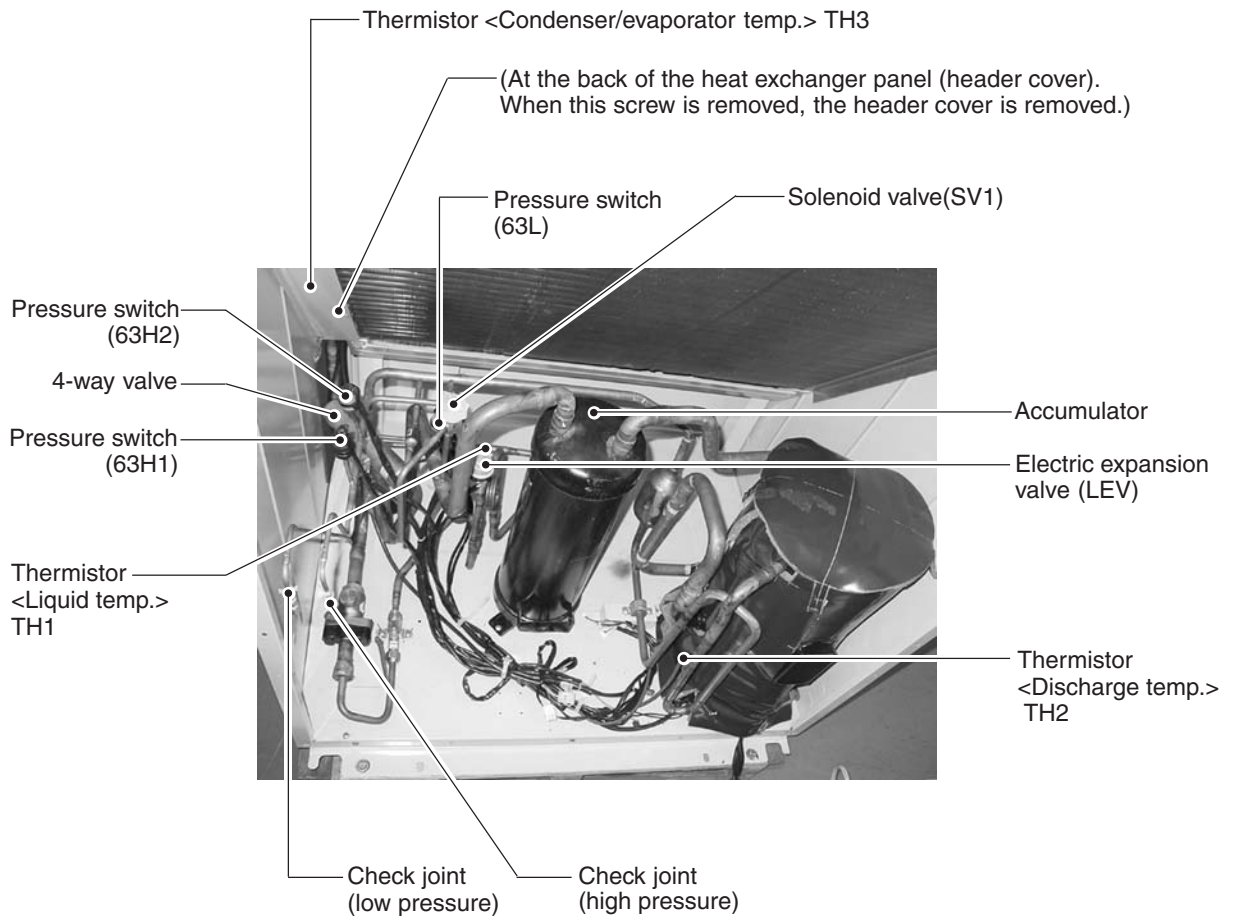

## [2] Refrigerant Circuit

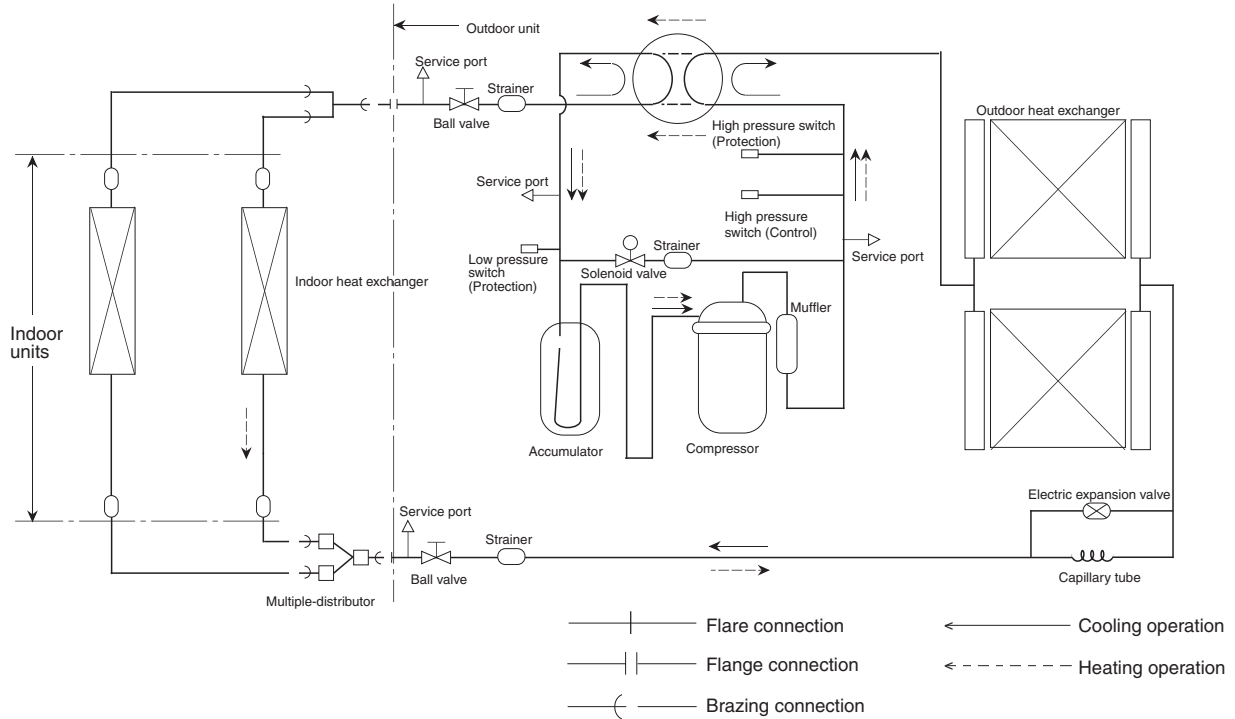

\* Two outdoor units must be connected when using PEH-P16-20MYA.

## [3] Limitation of Refrigerant Piping Length

(1) Single

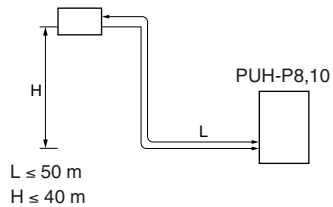

(2) Twin

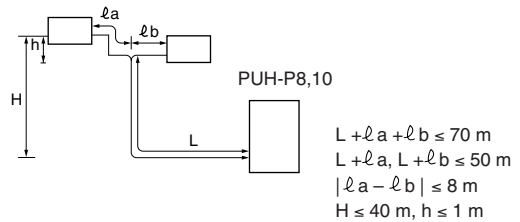

(3) Triple

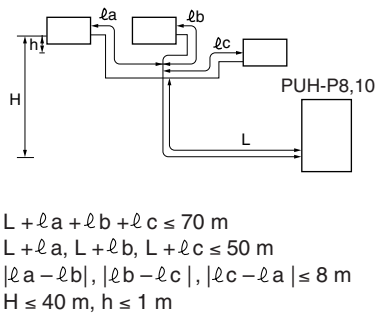

(4) Four

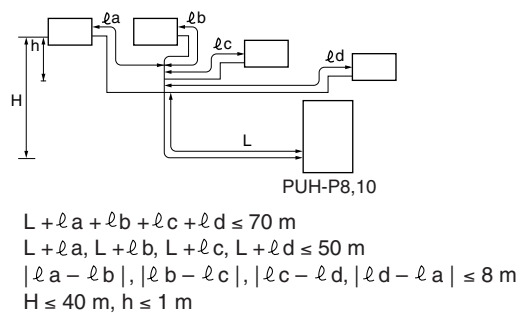

\* Total bends are 15 units, and max. bends are 8 units within  $L + l_a$ ,  $L + l_b$ ,  $L + l_c$  and  $L + l_d$ .

#### [4] Refrigerant Piping

	Model	Gas pipe	Liquid pipe
Outdoor unit	PUH-P8MYA	ø25.4	ø 12.7
	PUH-P10MYA	ø 28.58	ø 12.7
Indoor unit	1.6, 2, 2.5, 3	ø 15.88	ø9.52
	4, 5	ø19.05	ø 9.52
	8	ø 25.4	ø 12.7
	10	ø28.58	ø 12.7
	16	ø25.4 × 2	ø12.7 × 2
	20	ø28.58 × 2	ø12.7 × 2

#### [5] Refrigerant Charge

Model	Amount of refrigerant at ex-factory	Additional refrigerant charge
PUH-P8MYA	R407C 6.0 kg	$0.026 \times L + 0.014 \times (l_a + l_b + l_c + l_d) + \underline{1.7}^{*1}(\text{kg})$
PUH-P10MYA	R407C 6.5 kg	$0.026 \times L + 0.014 \times (l_a + l_b + l_c + l_d) + \underline{1.7}^{*1}(\text{kg})$

L: Main section actual length  $l_a + l_b + l_c + l_d$ : Join section actual length

The value of calculation result at the second decimal place must be rounded up to the first decimal place. (e.g. 2.22 kg must be rounded up to 2.3 kg)

\* 1 : For amount of total indoor units

#### [6] Operation Range

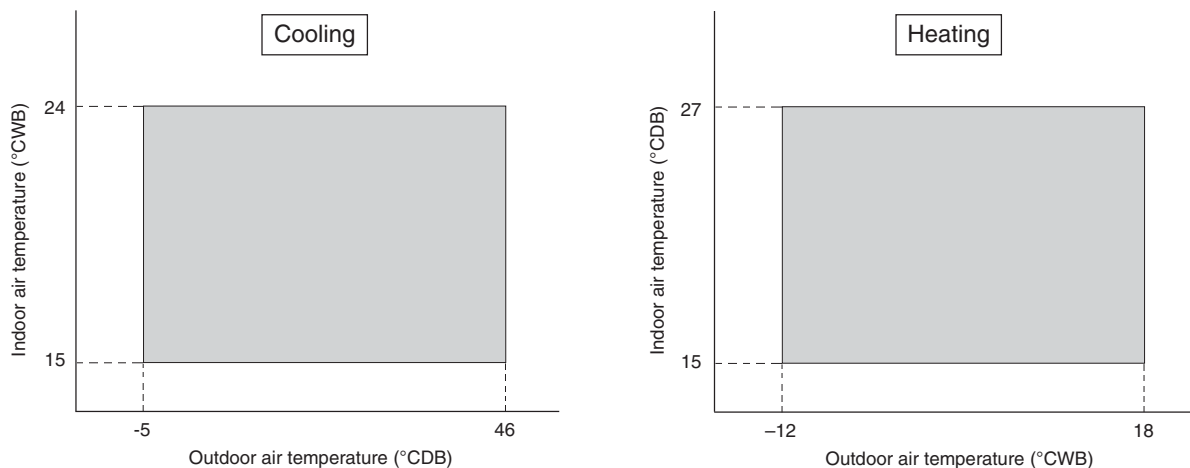



# 7 CONTROL

## [1] Composition of Control

### 1. Function block diagram

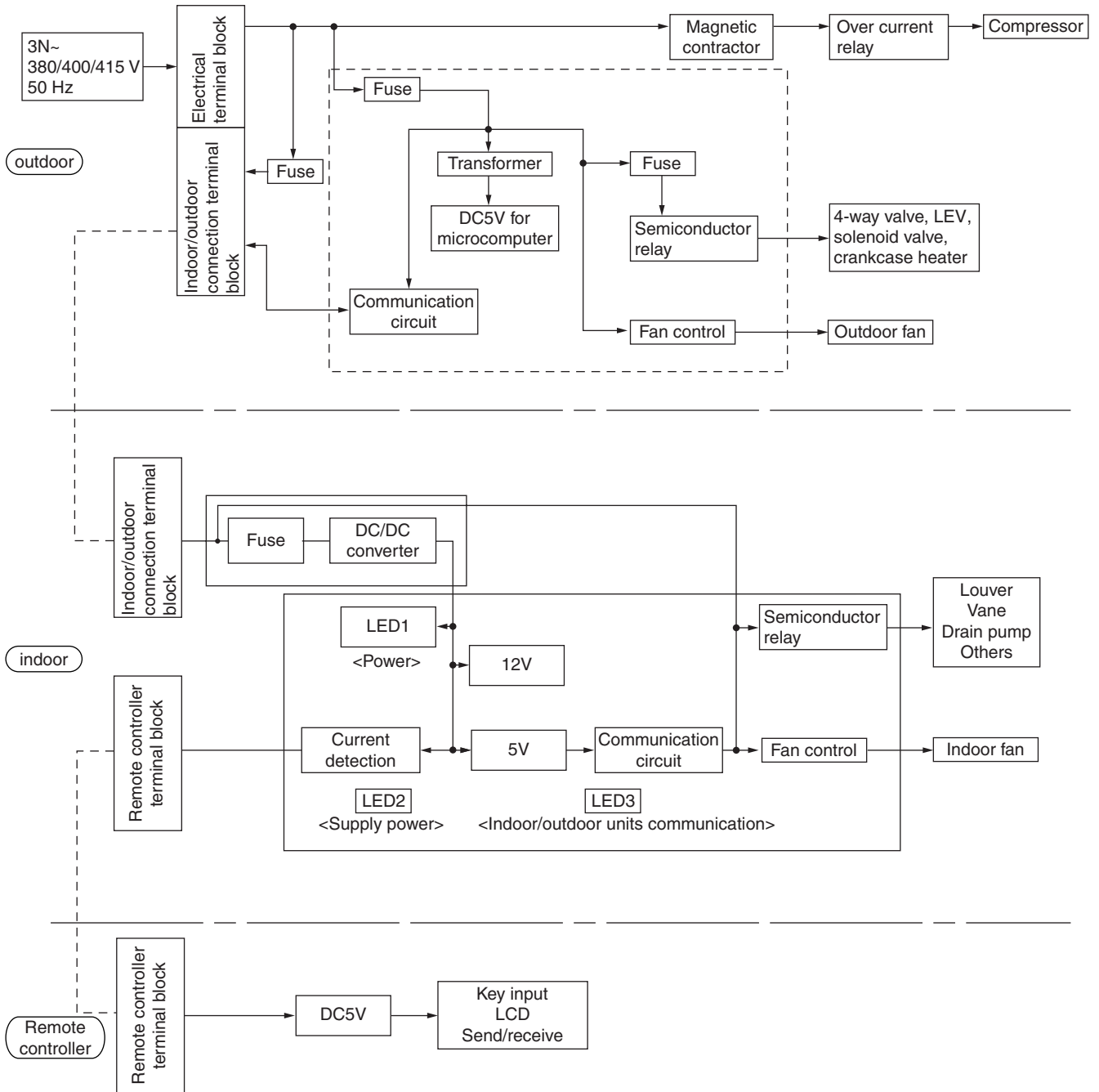

## [2] Control specifications

### (1) Protection functions

- 1) The main protection devices for the outdoor unit are:
  - a) High pressure protection (63H1)
  - b) Compressor overcurrent protection (51C)
  - c) Liquid temp thermistor trouble (TH1)
  - d) Discharge temperature protection (TH2  $\geq 118$  °C)
  - e) Discharge temp thermistor trouble (TH2)
  - f) Condenser/evaporater temp thermistor trouble (TH3)
  - g) Low pressure protection (63L)
- 2) When tripping of a detection device is sensed, the check mode is entered and the compressor is stopped. (After 3 minutes, the compressor restarts.) Thereafter, the compressor is stopped when the specified number of check modes or greater is sensed within the check time.

Protection functions	Operation value	Detection condition	Number of check modes	Check time
a) High pressure protection (63H1)	3.3 MPa	Compressor operating	0	–
b) Compressor overcurrent protection (51C)	P8MYA: 22 A P10MYA: 27 A	Compressor operating	1 time	30 minutes
c) Liquid temp thermistor trouble (TH1)	Less than $-39$ °C or greater than $88$ °C	Compressor operating except for 10 minutes at end of defrosting and 7 minutes while compressor starting	1 time	30 minutes
d) Discharge temperature protection (TH2 $\geq 118$ °C)	Greater than $118$ °C	Compressor operating	2 times	30 minutes
e) Discharge temp thermistor trouble (TH2)	Less than $0$ °C or greater than $216$ °C	Compressor operating except for 10 minutes at end of defrosting and 5 minutes while compressor starting	1 time	30 minutes
f) Condenser/evaporater temp thermistor trouble (TH3)	Less than $-39$ °C or greater than $88$ °C	Compressor operating except for 10 minutes at end of defrosting and 7 minutes while compressor starting	1 time	30 minutes
g) Low pressure protection (63L)	0 MPa	Compressor operating except for defrosting, 10 minutes at end of defrosting	2 times	30 minutes

- 3) Check mode is released by stopping operation, changing the operation mode, or check mode time up. A check mode is also released by stopping of operation by remote controller.
- 4) Detected check mode history (newest) and abnormality history (last 2 times) are memorized and are displayed on the segment by circuit board DIP switch setting.  
The operation mode when the newest abnormality was generated, the thermistor temperature (TH1,2,3), and the thermostat ON time can also be displayed.

### (2) Compressor, 4-way valve, and crankcase heater control

- 1) Determines the operation mode and operates the compressor based on the indoor/outdoor communication or M-NET communication data.
- 2) Compressor control has a function which prevents the compressor from restarting within 3 minutes.
- 3) The 4-way valve is always ON during heating (except during defrosting). In other modes, it is OFF. However, when the operation mode was changed from heating to stop, the 4-way valve is turned off 10 minutes after the compressor was stopped.
- 4) While the compressor is stopped, the crankcase heater remains ON. (OFF while the compressor is operating.)
- 5) When the operation mode is changed while the compressor is operating, the compressor stops and 3 minutes later restarts in the new mode.

**(3) Fan control**

Controls the fan speed based on the piping temperature (TH1) to perform cooling at low outdoor temperatures and heating at high outdoor temperatures.

1) Control at cooling

- a) When the compressor stops, the fan stops (fan output=0%).
- b) When the power is turned on, or when the compressor is restated after it has been stopped for 30 minutes or longer, the piping temperature ( TH1) determines the fan output.
  - When  $TH \leq 25^{\circ}C$  Fan output = 100 %
  - When  $TH < 25^{\circ}C$  Fan output = 60 %
- c) When the compressor is restarted within 30 minutes after it has been stopped, the fan step before the compressor was stopped is selected. However, when the fan output was under 30% when the fan was stopped, 30% is selected.
- d) When the mode was changed from heating to cooling, the fan step conforms to item 2.
- e) Two minutes after the fan is started, the fan step (number of units) is controlled every 30 seconds based on the piping temperature (TH1).
- f) When TH1 reaches 50°C or higher, or when the control high pressure switch (63H2) tripped, the fan output becomes 100%.
- g) Fan output while the compressor is operating is within the 20% to 100% range.

• FAN step

The following expression determines the next fan step count nj+1:

$$nj + 1 = nj + \Delta nj \quad nj: \text{Current fan step, } \Delta nj: \text{Displacement step amount}$$

nj control

- If  $nj + 1 \geq 100\%$   $nj + 1 = 100\%$
- If  $nj + 1 \geq 20\%$   $nj + 1 = 20\%$
- If  $TH1 \geq 50^{\circ}C$  or 63H2 is "OFF"  $nj + 1 = 100\%$

FAN  $\Delta nj$

Outputs are all %.

Target condensation temperature 31 °C		20 °C Condensation temperature TH1										
		t > 49 °C	t = 49 t > 46	t = 46 t > 43	t = 43 t > 40	t = 40 t > 36	t = 36 t > 33	t = 33 t > 29	t = 29 t > 26	t = 26 t > 23	t = 23 t > 20	t ≤
Current output	20 ≤ nj < 50	5	3	2	2	2	2	0	-2	-2	-3	-5
	50 ≤ nj 100	10	4	3	2	2	2	0	-2	-2	-4	-10

\* In the night mode, the maximum value of nj is 80%. (When TH1 < 50°C)

2) Control at heating

- a) When the compressor is stopped and during defrosting, the fan is stopped.
- b) When the power is turned on, or when the compressor is restarted after being stopped for 30 minutes or longer, the piping temperature (TH1) determines the fan step.
  - TH1 > 8°C                      Fan output = 60%
  - TH1 ≤ 8°C                      Fan output = 100%
- c) When the compressor is restarted within 30 minutes, the fan step is the step before the compressor was stopped.
- d) When the mode is changed from cooling to heating, the fan step conforms to item b).
- e) When returning from defrosting, the fan step is the step before defrosting.
- f) Two minutes after the fan was restarted, the fan step is controlled every 30 seconds based on the piping temperature (TH1).
- g) When TH1 is -5°C or lower, the fan output is made 100%.

• FAN step

The following expression determines the next fan step count nj + 1:

$$nj + 1 = nj + \Delta nj \quad nj: \text{Current fan step, } \Delta nj: \text{Displacement step amount}$$

nj control

- If  $nj + 1 \leq 100\%$      $nj + 1 = 100\%$
- If  $nj + 1 \leq 20\%$      $nj + 1 = 20\%$
- If  $TH1 < -5^\circ C$      $nj + 1 = 100\%$

FAN Δnj

Outputs are all %.

Target evaporation temperature 10 °C		Evaporation temperature TH1										
		T > 19 °C	T = 19 T > 17	T = 17 T > 15	T = 15 T > 13	T = 13 T > 11	T = 11 T > 8	T = 8 T > 6	T = 6 T > 4	T = 4 T > 2	T = 2 T > 0	T ≤ 0 °C
Current output	20 ≤ nj + 1 ≤ 100	-10	-4	-3	-2	-2	0	2	2	3	4	10

(4) Defrosting control

- 1) When the following conditions are satisfied, defrosting starts:
  - a) When the integrated compressor operation time has exceeded T1 (initial setting 50 minutes) and the piping temperature (TH1) is below -10C
  - b) When the integrated compressor °C

Piping differential temperature

$$\Delta TH1 = TH10 - TH1$$

Current piping temperature

Piping temperature 10 minutes after starting or 10 minutes after returning from defrosting

- 2) The defrosting prohibit time T1 is set as following based on the defrosting time T2:

T2 ≤ 3 (minutes)	T1 60 (minutes)
3 < T2 < 15	40
T2 = 15	30

Note: T1 is reset at the end of defrosting, or by cooling ON command.

Note: When the compressor was stopped during defrosting, T1 = 20 minutes is set to recognize the stop as defrosting end.

- 3) During defrosting, all the outdoor fans are stopped and the bypass solenoid valve (SV1) is turned ON and the 4-way valve (21S4) is turned OFF.
- 4) When the following conditions are satisfied, defrosting ends:
  - a) T2 ≤ 2 mins                      TH1 ≤ 30°C
  - b) 2 < T2 < 15 minutes            TH1 ≤ 8°C continuous 2 minutes
  - c) T2 = 15 minutes
- 5) When the fan and 4-way valve (21S4) are turned ON at the end of defrosting, the heating mode is reset. Two minutes after defrosting reset, the bypass solenoid valve (SV1) turns OFF.
- 6) When using PEH-P16-20MYA, alternate defrosting is possible after sending and receiving each respective outdoor unit defrost signal.

**(5) Bypass solenoid valve control (SV1)**

- 1) Control at cooling
  - a) While the compressor is stopped, the solenoid valve is OFF.
  - b) When the power is turned on, or when the compressor is restarted after it has been stopped for 30 minutes or longer, if the liquid temperature (TH1) is 25°C or higher then the solenoid valve turns ON for 2 minutes.
  - c) When the power is turned on, or when the compressor restarted after it has been stopped for 30 minutes or longer, the solenoid valve turns ON for 5 minutes if the liquid temperature (TH1) is staying below 25°C.
  - d) The item b) or c) is applied to the mode change from heating to cooling.
  - e) When the previous operation mode is cooling and the compressor restarted within 30 minutes after it's stopping by the tripping of 63H2, the solenoid valve turns ON for 2 minutes.
- 2) Control at heating
  - a) While the compressor is stopped, the solenoid valve is OFF.
  - b) When the power is turned on, or when the compressor restarted after it has been stopped for 30 minutes or longer, the solenoid valve turns ON for 2 minutes if the liquid temperature (TH1) is staying above 8°C.
  - c) When the power is turned on, or when the compressor restarted after it has been stopped for 30 minutes or longer, the solenoid valve turns ON for 5 minutes if the liquid temperature (TH1) is staying below 8°C.
  - d) The item b) or c) is applied to the mode change from cooling to heating.
  - e) When the control pressure switch (63H2) trips, the solenoid valve turns ON.
  - f) If 63H2 resets 15 minutes after tripping, the solenoid valve turns OFF.
  - g) During defrosting, the solenoid valve turns ON.
  - h) When the previous operation mode is heating and the compressor restarted within 30 minutes after it's stopping by the tripping of 63H2, the solenoid valve turns ON for 2 minutes.
  - i) When the previous operation mode is heating, and the compressor restarted within 30 minutes after the tripping of 63L, the solenoid valve turns ON for 2 minutes.

**(6) Electronic expansion valve (LEV)**

- 1) Initial processing after power turned on
 

After the power is turned on, full close processing is performed as initial drive processing.

  - a) A 2200 pulses down is output from power on.
  - b) At the end of 2200 pulse down output, 60 pulses up is output.
  - c) Sixty pulses up output ends initial processing. At this point, the valves are fully closed.
- 2) Control contents

	LEV output opening angle	Opening angle control range
At compressor starting	Initial opening angle	Approx. 1000 to 2000 pulses
At compressor stopping	1000 pulses	–
At defrosting	2000 pulses (full close)	–
Normal	See next item	1000 to 1500 pulses

- 3) Normal LEV control
  - a) The operation frequency when the compressor is started (including after defrosting reset) determines the standard opening angle.
  - b) After a) above, sub cool (SC) shown below controls the LEV opening angle.
 

<Definition of SC>

Cooling: SC = TH3 (outdoor unit)-TH1 (outdoor unit)

Heating: SC = TH5 (indoor unit)-TH2 (indoor unit)

\* When there are multiple indoor units, the value of TH2 and TH5 is the average value of TH2 and TH5 of all the indoor units.

<LEV control>

LEV is controlled so that SC is equal to SCm.

SC < SCm: LEV opening angle is made smaller

SC > SCm: LEV opening angle is made larger

SC = SCm: LEV opening angle remains unchanged

SCm = 5~15 (SCm is different with Indoor Units.)
- 4) Transient LEV control
  - a) When outlet temperature (outdoor unit TH2) rises
 

When the outlet temperature (outdoor unit TH2) exceeds 115 °C, the LEV opening angle is made larger.

**(7) Service functions**

- 1) Abnormality history clear
  - a) When DIP SW1-2 is turned ON while the compressor is operating or stopped, the abnormality history is cleared.

### [3] Function of switches and connectors (outdoor unit)

#### (1) Function of switches

##### 1) Function of switches

(Normal mode)

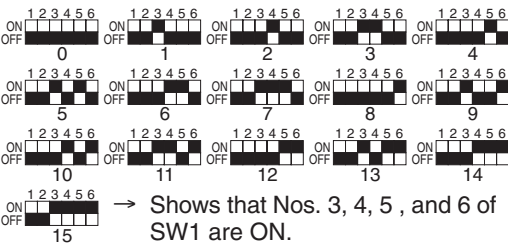
			Normal mode			
			SW3 = Unrelated			
Kind of switch	Switch	Pole	Function	Operation by switch operation		Switch effective timing
				ON	OFF	
DIP SW	SW1 (CN33) When open (Normal)	1	None	—	—	—
		2	Abnormality history clear	Clear	Normal	Running or stopped
		3	Refrigerant system address setting			When power turned on
		4				
		5				
		6				
	SW2	1	Self diagnosis	See pages 29 to 34.		Running or stopped
		2				
		3				
		4				
		6				
Tact SW	SW3		Mode input register	Register	Normal	stopped
DIP SW	SW4	1	Trial run	Operate	Stop	stopped*1
		2	Trial run mode switching	Heat	Cool	stopped
DIP SW	SW5	1	Inlet temp. re-reading	Do	Do not	—
		2	3-phase power source detection	Do not	Do	When power turned on
		3	Cooling only switching	Cooling only	Heat pump	When power turned on
		4	Model setting	PUH-P10MYA	PUH-P8MYA	

##### 2) Switch functions at set mode change

			Set input mode			
			CN33 = short SW3 = ON*2			
Kind of switch	Switch	Pole	Function	Operation by switch operation		Switch effective timing
				ON	OFF	
DIP SW	SW1 When CN33 shorted (mode switching)	1	None	—	—	—
		2				
		3	Night mode	Night mode	Normal mode	stopped
		4	Defrosting end switching	12 °C continuous 2 minutes	8 °C continuous 2 minutes	stopped
		5	Defrosting prohibit time switching	Fixed	Training	stopped
		6	None	—	—	—
Remarks	*1 Trial run performs trail run processing by input change while stopped. (For details, see the trail run section)					
	*2 Mode input is entered by SW3 OFF→ON change (___↑). Press and hold down SW3 for about 2 seconds. The set mode can be registered according to the outdoor unit setting information on page 31.					

Note: After changing the mode by CN33 shorting (mode switching), return to the normal mode by opening CN33.

##### 3) Connector function assignment

Type	Connector	Function	Operation by open/short		Switch effective timing
			short	open	
Connector	CN31	Emergency operation	Start	Normal	At initialization
	CN32	Function test	Function mode	Normal	At initialization
	CN33	DIP switch mode switching	Mode switching	Normal	stopped

<Outdoor unit operation monitoring function>

The operation status and check code contents can be ascertained by means of the 2-digit number and symbol on digital display light emitting diode LED2 by operating DIP switch SW2.

<Description of operation of digital display light emitting diode (LED2)>

- When ON (normal operation): Displays the operation mode.

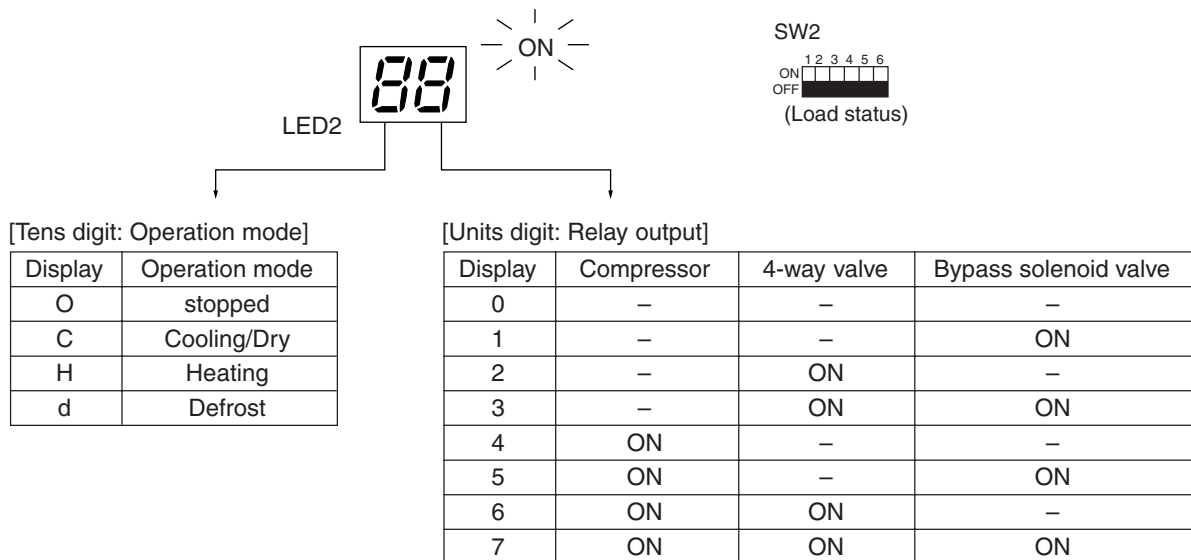

- When blinking (Operation stopped by tripping protection device): Displays the check mode







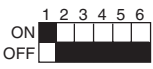

Display	Check unit
0	Outdoor unit
1	Indoor unit 1
2	Indoor unit 2
3	Indoor unit 3
4	Indoor unit 4

Display	Check contents (at power on)
E8	Indoor-outdoor communication receive abnormal (outdoor unit)
E9	Indoor-outdoor communication send abnormal (outdoor unit)
EA	Indoor/outdoor connection erroneous wiring, number of indoor units mismatch
Eb	Indoor/outdoor connection erroneous wiring (indoor unit power failure, disconnection)
Ed	Serial communication abnormal (M-NET)
E0-E7	Communication other than outdoor unit abnormal
F8	Input circuit faulty

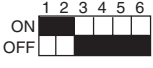



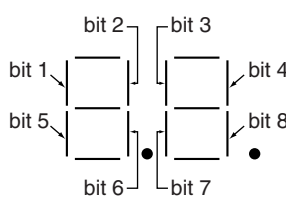

- PUH-P8MYA/P10MYA



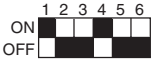

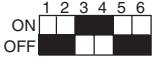
Display	Check contents (operating)
U2	Compressor discharge temperature abnormal, CN23 short-circuit connector unplugged
U3	Compressor discharge temp thermistor (TH2) open/short
U4	Liquid temp thermistor (TH1), Condenser/evaporater temp thermistor (TH3) open/short
U6	Compressor overcurrent protection trip (51C trip)
UE	High pressure protection (63H1 trip)
UL	Low pressure protection (63L trip)
P1-P8	Indoor unit abnormal
A0-A8	M-NET communication abnormal

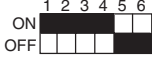

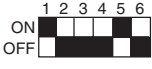

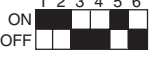
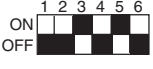

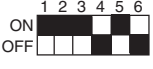



Self diagnosis by SW2  
 • PUH-P8MYA/P10MYA



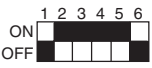

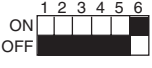

SW2 setting	Display contents	Description of display		Unit
	Liquid temperature (TH1) -39 - 88	-39 - 88 (When 0 °C or lower, “-”and temperature are displayed alternately.) <Example> When -10, every other second - □ ↔ 10		°C
	Discharge temperature (TH2) 0 - 216	0 - 216 (When 100 or higher, 100s digit and 10s and units digits are displayed alternately.) <Example> When 115, every other second 1 □ ↔ 15		°C
	FAN output 0 - 100	0 - 100 (When 100 or higher, 100s digit and 10s and units digits are displayed alternately.) <Example> When 100, every other second 1 □ ↔ 00		%
	Number of compressor ON/OFF 0 - 999	0 - 999 (When 100 or higher, 100s digit and 10s and units digits are displayed alternately.) <Example> When 425, every other second 4 □ ↔ 25		100 times
	Compressor integrated operation time 0 - 999	0 - 999 (When 100 or higher, 100s digit and 10s and units digits are displayed alternately.) <Example> When 245, every other second 2 □ ↔ 45		10 hours
	Current check mode code 1	Check mode segment display method Segment and bit correspondence 	Check mode 1 display method bit 1 ..... Compressor discharge temperature abnormal bit 2 ..... Compressor discharge temp thermistor abnormal (TH2) bit 3 ..... CN23 short-circuit connector unplugged bit 5 ..... Liquid temp thermistor abnormal (TH1)	
	Current check mode code 2		Check mode 2 display method bit 1 ..... Overcurrent trip (Comp) bit 2 ..... Low pressure protection	
	LEV opening angle (/5) 0 - 400	0 - 400 (When 100 or higher, 100s digit and 10s and units digits are displayed alternately.) <Example> When 200 , every other second 2 □ ↔ 00		5 pulses









SW2 setting	Display contents	Description of display	Unit
	Newest check code Newest outdoor unit abnormality Check display	When no check mode, "00" <Example> When piping thermistor abnormal U4	Code display
	Operation mode when abnormality occurred	Operation mode when abnormally stopped <Example> Comp. only ON at cooling operation C4	Code display
	Liquid temperature (TH1) when abnormality occurred - 39 - 88	-39 - 88 (When 0 °C or lower, "-" and temperature are displayed alternately.) <Example> When -15, every other second - □ ↔ 15	°C
	COMP discharge temperature (TH2) when abnormality occurred 0 - 216	0 - 216 (When 100 or higher, 100s digit and 10s and units digits are displayed alternately.) <Example> When 130, every other second 1 □ ↔ 30	°C
	Check code history (1) (newest) Abnormal unit No. and check code inverted display	When no abnormality history "0", "↔", "-"	Code display
	Check code history (2) (One before newest) Abnormal unit No. and check code inverted display	When no abnormality history "0", "↔", "-"	Code display
	Current thermostat ON time 0 - 999	0 - 999 (When 100 or higher, 100s digit and 10s and units digits are displayed alternately.) <Example> When 245, every other second 2 □ ↔ 45	Minutes
	Number of indoor units connected 0 - 4	0 - 4	Units

SW2 setting	Display contents	Description of display	Unit																								
	Outdoor unit set information 1	Outdoor unit capacity is displayed as function code. <table border="1" data-bbox="630 235 933 324"> <thead> <tr> <th>Model name</th> <th>function code</th> </tr> </thead> <tbody> <tr> <td>PUH-P8MYA</td> <td>20</td> </tr> <tr> <td>PUH-P10MYA</td> <td>25</td> </tr> </tbody> </table>	Model name	function code	PUH-P8MYA	20	PUH-P10MYA	25	Code display																		
Model name	function code																										
PUH-P8MYA	20																										
PUH-P10MYA	25																										
	Outdoor unit set information 2	<table border="1" data-bbox="630 414 1236 593"> <thead> <tr> <th></th> <th>Outdoor unit set information 1</th> <th colspan="2">Function setting (display valves)</th> </tr> </thead> <tbody> <tr> <td>3-phase power source detection</td> <td>Do</td> <td>(1) Do not</td> <td>(0)</td> </tr> <tr> <td>Cooling only switching</td> <td>Cooling only</td> <td>(2) H/P</td> <td>(0)</td> </tr> <tr> <td>Night mode</td> <td>Night mode</td> <td>(1) Normal mode</td> <td>(0)</td> </tr> <tr> <td>Defrosting end time</td> <td>12 °C continuous 2 minutes (2)</td> <td>8 °C continuous 2 minutes (0)</td> <td></td> </tr> <tr> <td>Defrosting prohibit time</td> <td>Fixed</td> <td>(4) Training</td> <td>(0)</td> </tr> </tbody> </table> <p>Set information display values are added and displayed at each position.</p>		Outdoor unit set information 1	Function setting (display valves)		3-phase power source detection	Do	(1) Do not	(0)	Cooling only switching	Cooling only	(2) H/P	(0)	Night mode	Night mode	(1) Normal mode	(0)	Defrosting end time	12 °C continuous 2 minutes (2)	8 °C continuous 2 minutes (0)		Defrosting prohibit time	Fixed	(4) Training	(0)	Code display
	Outdoor unit set information 1	Function setting (display valves)																									
3-phase power source detection	Do	(1) Do not	(0)																								
Cooling only switching	Cooling only	(2) H/P	(0)																								
Night mode	Night mode	(1) Normal mode	(0)																								
Defrosting end time	12 °C continuous 2 minutes (2)	8 °C continuous 2 minutes (0)																									
Defrosting prohibit time	Fixed	(4) Training	(0)																								
	Indoor unit piping temperature (TH2) Indoor 1 -39 - 88	-39 - 88 (When 0 °C or lower, “-”and temperature are displayed alternately.) When there are no indoor units, “00” is displayed.	°C																								
	Indoor unit piping temperature (TH2) Indoor 2 -39 - 88	-39 - 88 (When 0 °C or lower, “-”and temperature are displayed alternately.) When there are no indoor units, “00” is displayed.	°C																								
	Indoor unit piping temperature (TH2) Indoor 3 -39 - 88	-39 - 88 (When 0 °C or lower, “-”and temperature are displayed alternately.) When there are no indoor units, “00” is displayed.	°C																								
	Indoor unit piping temperature (TH2) Indoor 4 -39 - 88	-39 - 88 (When 0 °C or lower, “-”and temperature are displayed alternately.) When there are no indoor units, “00” is displayed.	°C																								
	Indoor intake temperature 8 - 39.5	8 - 39.5 When there are no indoor units, “00” is displayed.	°C																								
	Indoor set temperature 17 - 30	17 - 30 When there are no indoor units, “00” is displayed.	°C																								

SW2 setting	Display contents	Description of display	Unit																													
	Indoor unit control status Indoor 1, 2	Control mode display system   Indoor unit No.2 Indoor unit No.4 Indoor unit No.1 Indoor unit No.3 <table border="1" data-bbox="837 369 1236 616"> <thead> <tr> <th rowspan="2">Display</th> <th colspan="2">Control mode</th> </tr> <tr> <th>Indoor unit</th> <th>Outdoor unit</th> </tr> </thead> <tbody> <tr><td>0</td><td>Ordinary</td><td>←</td></tr> <tr><td>1</td><td>Hot adjustment</td><td>←</td></tr> <tr><td>2</td><td>Defrosting</td><td>←</td></tr> <tr><td>3</td><td>—</td><td>←</td></tr> <tr><td>4</td><td>Heater ON</td><td>←</td></tr> <tr><td>5</td><td>Freeze prevention</td><td>←</td></tr> <tr><td>6</td><td>Surge prevention</td><td>←</td></tr> <tr><td>7</td><td>Compressor OFF</td><td>←</td></tr> </tbody> </table>	Display	Control mode		Indoor unit	Outdoor unit	0	Ordinary	←	1	Hot adjustment	←	2	Defrosting	←	3	—	←	4	Heater ON	←	5	Freeze prevention	←	6	Surge prevention	←	7	Compressor OFF	←	—
Display	Control mode																															
	Indoor unit	Outdoor unit																														
0	Ordinary	←																														
1	Hot adjustment	←																														
2	Defrosting	←																														
3	—	←																														
4	Heater ON	←																														
5	Freeze prevention	←																														
6	Surge prevention	←																														
7	Compressor OFF	←																														
	Indoor unit control status Indoor 3, 4	<table border="1" data-bbox="837 369 1236 616"> <thead> <tr> <th rowspan="2">Display</th> <th colspan="2">Control mode</th> </tr> <tr> <th>Indoor unit</th> <th>Outdoor unit</th> </tr> </thead> <tbody> <tr><td>0</td><td>Ordinary</td><td>←</td></tr> <tr><td>1</td><td>Hot adjustment</td><td>←</td></tr> <tr><td>2</td><td>Defrosting</td><td>←</td></tr> <tr><td>3</td><td>—</td><td>←</td></tr> <tr><td>4</td><td>Heater ON</td><td>←</td></tr> <tr><td>5</td><td>Freeze prevention</td><td>←</td></tr> <tr><td>6</td><td>Surge prevention</td><td>←</td></tr> <tr><td>7</td><td>Compressor OFF</td><td>←</td></tr> </tbody> </table>	Display	Control mode		Indoor unit	Outdoor unit	0	Ordinary	←	1	Hot adjustment	←	2	Defrosting	←	3	—	←	4	Heater ON	←	5	Freeze prevention	←	6	Surge prevention	←	7	Compressor OFF	←	—
Display	Control mode																															
	Indoor unit	Outdoor unit																														
0	Ordinary	←																														
1	Hot adjustment	←																														
2	Defrosting	←																														
3	—	←																														
4	Heater ON	←																														
5	Freeze prevention	←																														
6	Surge prevention	←																														
7	Compressor OFF	←																														
	Condenser/evaporater temperature (TH3)	-39 - 88 (When 0 °C or lower, “-”and temperature are displayed alternately.) <Example> When -10, every other second - □ ↔ -10	°C																													
	Outdoor unit control status	Control mode display system   Indoor unit No.2 Indoor unit No.4 Indoor unit No.3 Outdoor unit <table border="1" data-bbox="837 1041 1236 1288"> <thead> <tr> <th rowspan="2">Display</th> <th colspan="2">Control mode</th> </tr> <tr> <th>Indoor unit</th> <th>Outdoor unit</th> </tr> </thead> <tbody> <tr><td>0</td><td>Ordinary</td><td>←</td></tr> <tr><td>1</td><td>Hot adjustment</td><td>←</td></tr> <tr><td>2</td><td>Defrosting</td><td>←</td></tr> <tr><td>3</td><td>—</td><td>←</td></tr> <tr><td>4</td><td>Heater ON</td><td>←</td></tr> <tr><td>5</td><td>Freeze prevention</td><td>←</td></tr> <tr><td>6</td><td>Surge prevention</td><td>←</td></tr> <tr><td>7</td><td>Compressor OFF</td><td>←</td></tr> </tbody> </table>	Display	Control mode		Indoor unit	Outdoor unit	0	Ordinary	←	1	Hot adjustment	←	2	Defrosting	←	3	—	←	4	Heater ON	←	5	Freeze prevention	←	6	Surge prevention	←	7	Compressor OFF	←	—
Display	Control mode																															
	Indoor unit	Outdoor unit																														
0	Ordinary	←																														
1	Hot adjustment	←																														
2	Defrosting	←																														
3	—	←																														
4	Heater ON	←																														
5	Freeze prevention	←																														
6	Surge prevention	←																														
7	Compressor OFF	←																														
	Discharge super heat SHd 0 - 216 Cooling: Outdoor TH2 - Outdoor TH3 Heating: Outdoor TH2 - Indoor TH3 (Average)	0 - 216 (When 100 or higher, 100s digit and 10s and units digits are displayed alternately.) <Example> When 150, every other second 1 □ ↔ 50	°C																													
	Sub cool Sc 0 - 130 Cooling: Outdoor TH3 - Outdoor TH1 Heating: Indoor TH3 (Average) - Indoor TH2 (Average)	0 - 130 (When 100 or higher, 100s digit and 10s and units digits are displayed alternately.) <Example> When 100, every other second 1 □ ↔ 00	°C																													
	Target sub cool step N 1 - 5	1 - 5	—																													

SW2 setting	Display contents	Description of display	Unit
	Communication demand capacity 0 - 255	0 - 255 When communication demand not set: 100% (When 100 or higher, 100s digit and 10s and units digits are displayed alternately.) <Example> When 100, every other second 1 □ ↔ 100	%
	Abnormal thermistor display 1 - 3, -	1 - 3, - 1: Outdoor liquid temp thermistor (TH1) 2: Outdoor discharge temp thermistor (TH2) 3: Outdoor condenser/evaporater temp thermistor (TH3) -: No abnormal thermistor	-
	FAN output at abnormal stop 0 - 100	0 - 100 (When 100 or higher, 100s digit and 10s and units digits are displayed alternately.) <Example> When 100, every other second - □ ↔ 00	%
	LEV opening angle (/5) at abnormal stop 0 - 400	0 - 400 (When 100 or higher, 100s digit and 10s and units digits are displayed alternately.) <Example> When 200, every other second 2 □ ↔ 00	5 pulses
	Outdoor Condenser/evaporater temp temperature at abnormal stop -39 - 88	-39 - 88 (When 0 °C or lower, “-” and temperature are displayed alternately.) <Example> When -10, every other second - □ ↔ -10	°C
	Discharge super heat SHd at abnormal stop 0 - 216 Cooling: Outdoor TH2- Outdoor TH3 Heating: Outdoor TH2- Indoor TH3 (average)	0 - 216 (When 100 °C or higher, 100s digit and 10s and units digits are displayed alternately.) <Example> When 150, every other second - □ ↔ 50	°C
	Sub cool Sc at abnormal stop 0 - 130 Cooling: Outdoor TH3- Outdoor TH1 Heating: Indoor TH3 (average) -Indoor TH2 (average)	0 - 130 (When 100 °C or higher, 100s digit and 10s and units digits are displayed alternately.) <Example> When 100, every other second 1 □ ↔ 00	°C

SW2 setting	Display contents	Description of display	Unit
	Thermostat ON time up to abnormal stop 0 - 999	0 - 999 (When 100 or higher, 100s digit and 10s and units digits are displayed alternately.) <Example> When 245, every other second 2 □ ←→ 45	Minutes
	LEV regular control count n 1 - 5	1 - 5	—
	Indoor unit condenser/evaporator temp temperature (TH3) Indoor 1 -39 - 88	-39 - 88 (When 0 °C or lower, “-”and temperature are displayed alternately.) When there are no indoor units, “00” is displayed.	°C
	Indoor unit condenser/evaporator temp temperature (TH3) Indoor 2 -39 - 88	-39 - 88 (When 0 °C or lower, “-”and temperature are displayed alternately.) When there are no indoor units, “00” is displayed.	°C
	Indoor unit condenser/evaporator temp temperature (TH3) Indoor 3 -39 - 88	-39 - 88 (When 0 °C or lower, “-”and temperature are displayed alternately.) When there are no indoor units, “00” is displayed.	°C
	Indoor unit condenser/evaporator temp temperature (TH3) Indoor 4 -39 - 88	-39 - 88 (When 0 °C or lower, “-”and temperature are displayed alternately.) When there are no indoor units, “00” is displayed.	°C

#### [4] Simple parts check method

- PUH-P8MYA/P10MYA

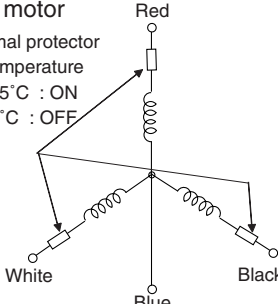
Part name	Judgment instructions								
Thermistor (TH1) <Liquid temperature detection> Thermistor (TH2) <Discharge temperature detection> Thermistor (TH3) <Condenser/evaporator temperature detection>	Disconnect the connector and measure the resistance value with a multimeter. (Ambient temperature 10 °C to 30 °C) <table border="1" data-bbox="539 392 1109 495"> <thead> <tr> <th></th> <th>Normal</th> <th>Abnormal</th> </tr> </thead> <tbody> <tr> <td>TH1, 3</td> <td>4.3 kΩ~9.6 kΩ</td> <td rowspan="2">Open or short</td> </tr> <tr> <td>TH2</td> <td>160 kΩ~410 kΩ</td> </tr> </tbody> </table> (Based on thermistor characteristic table (next page))		Normal	Abnormal	TH1, 3	4.3 kΩ~9.6 kΩ	Open or short	TH2	160 kΩ~410 kΩ
	Normal	Abnormal							
TH1, 3	4.3 kΩ~9.6 kΩ	Open or short							
TH2	160 kΩ~410 kΩ								
Fan motor Thermal protector trip temperature 135 ±5°C : ON 88 ±5°C : OFF 	Measure the resistance value across the terminals with a multimeter. (Winding temperature 20 °C) <table border="1" data-bbox="539 689 1109 757"> <thead> <tr> <th>Motor lead wire</th> <th>Normal</th> <th>Abnormal</th> </tr> </thead> <tbody> <tr> <td>Between 2 phases</td> <td>45.5 Ω</td> <td>Open or short</td> </tr> </tbody> </table>	Motor lead wire	Normal	Abnormal	Between 2 phases	45.5 Ω	Open or short		
Motor lead wire	Normal	Abnormal							
Between 2 phases	45.5 Ω	Open or short							
Compressor	Measure the resistance value across the terminals with a multimeter. (Winding temperature 20 °C) <table border="1" data-bbox="539 1025 1109 1198"> <thead> <tr> <th>Normal</th> <th>Abnormal</th> </tr> </thead> <tbody> <tr> <td>PUH-P8MYA</td> <td rowspan="2">Open or short</td> </tr> <tr> <td>Each phase 1.574 Ω</td> </tr> <tr> <td>PUH-P10MYA</td> <td rowspan="2">Open or short</td> </tr> <tr> <td>Each phase 1.263 Ω</td> </tr> </tbody> </table>	Normal	Abnormal	PUH-P8MYA	Open or short	Each phase 1.574 Ω	PUH-P10MYA	Open or short	Each phase 1.263 Ω
Normal	Abnormal								
PUH-P8MYA	Open or short								
Each phase 1.574 Ω									
PUH-P10MYA	Open or short								
Each phase 1.263 Ω									

## [5] Reference Data

<Thermistor characteristic table>

Low temperature thermistor

Thermistor <Liquid temperature detection> (TH1)

Thermistor <Condenser/evaporater temperature detection> (TH3)

Thermistor <Liquid temperature detection> (TH1)

Thermistor <Condenser/evaporater temperature detection> (TH3)

Thermistor  $R_0 = 15 \text{ k}\Omega \pm 3 \%$

B constant =  $3,460 \text{ k}\Omega \pm 2 \%$

$$R_t = 15 \exp \left\{ 3,460 \left( \frac{1}{273 + t} - \frac{1}{273} \right) \right\}$$

0 °C: 15 k $\Omega$

10 °C: 9.7 k $\Omega$

20 °C: 6.4 k $\Omega$

25 °C: 5.3 k $\Omega$

30 °C: 4.3 k $\Omega$

40 °C: 3.1 k $\Omega$

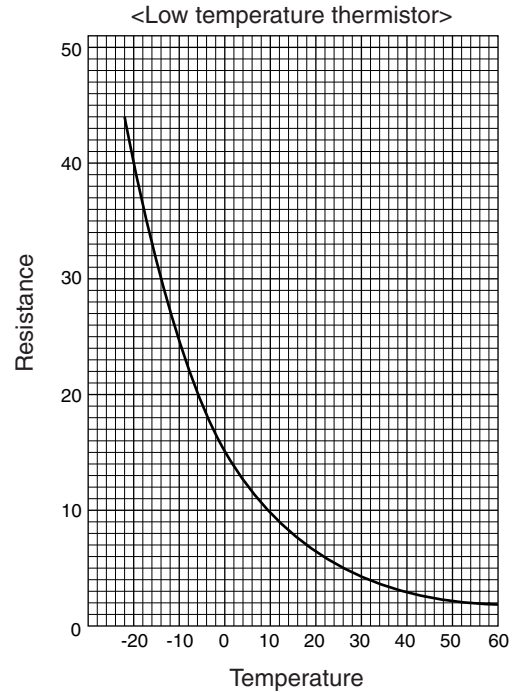

High temperature thermistor

Thermistor <Discharge temperature detection> (TH2)

Thermistor (Discharge temperature detection) (TH2)

Thermistor  $R_{120} = 7.465 \text{ k}\Omega \pm 2 \%$

B constant =  $4,057 \text{ k}\Omega \pm 2 \%$

$$R_t = 7.465 \exp \left\{ 4,057 \left( \frac{1}{273 + t} - \frac{1}{393} \right) \right\}$$

20 °C: 250 k $\Omega$       70 °C: 34 k $\Omega$

30 °C: 160 k $\Omega$       80 °C: 24 k $\Omega$

40 °C: 104 k $\Omega$       90 °C: 17.5 k $\Omega$

50 °C: 70 k $\Omega$       100 °C: 13.0 k $\Omega$

60 °C: 48 k $\Omega$       110 °C: 9.8 k $\Omega$

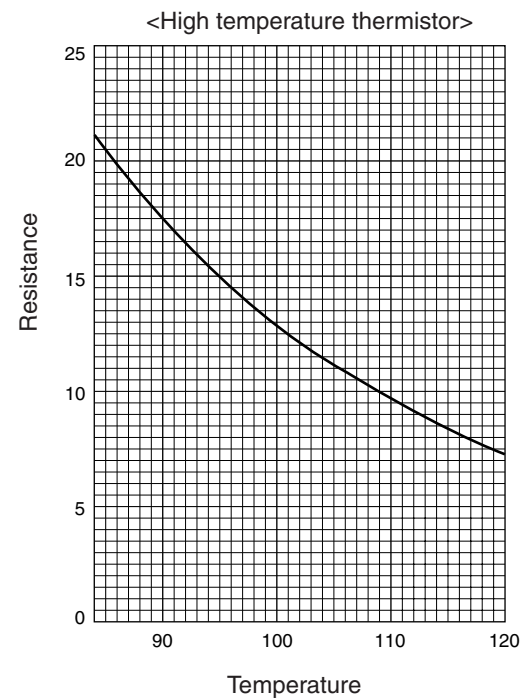

## [6] Troubleshooting of each part

### (1) LEV

#### 1) Overview of LEV operation

LEV (electronic expansion valve) receives pulse signals from the outdoor unit main circuit board and drives a valve by means of a servomotor.

The valve opening angle changes in proportion to the number of pulses.

<Outdoor controller board and LEV>

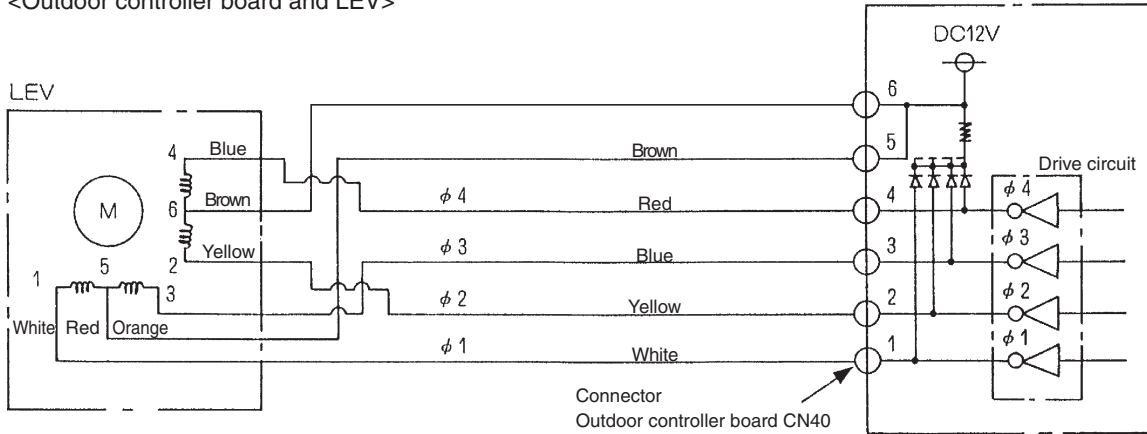

Output (phase) No.	Output state			
	1	2	3	4
ø1	ON	OFF	OFF	ON
ø2	ON	ON	OFF	OFF
ø3	OFF	ON	ON	OFF
ø4	OFF	OFF	ON	ON

#### <Pulse signal output and valve operation>

The output pulses change in the following order:

Valve closing 1 → 2 → 3 → 4 → 1

Valve opening 4 → 3 → 2 → 1 → 4

- \*1. When the LEV opening angle is not changed, all output phases turn OFF.
- 2. When the output misses a phase or remains ON, the motor cannot rotate smoothly and makes a clacking sound and vibrates.

#### LEV opening and closing operations

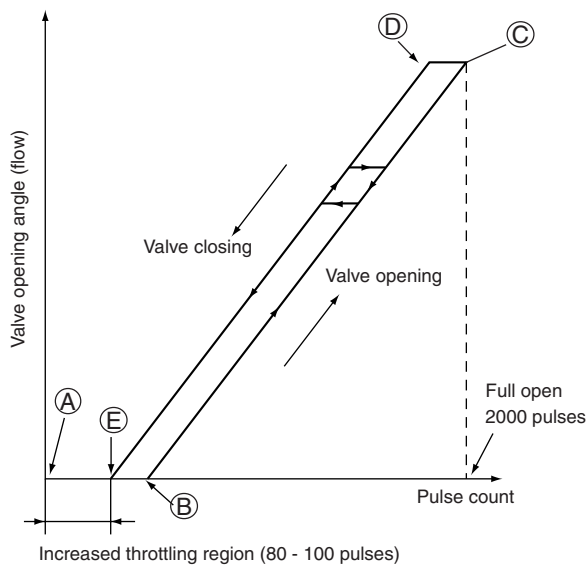

- \* When the power is turned on, to register the valve position, a 2200 pulses valve close signal is output and is always set to point (A).

If the valve moves smoothly, the LEV will not generate a sound or vibration, but at (E) → (A) and when the valve is locked, a sound louder than the sound generated by missing phase, etc. will be generated.

- \* Generation of sound can be checked by placing the tip of a screwdriver against the valve and your ear against the handle.

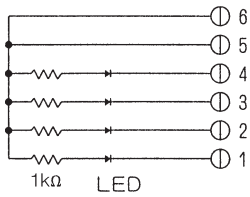

## 2) Judgment method and probable trouble mode

Trouble mode	Judgment method	Remedy
Microcomputer drive circuit faulty	<p>(1) Disconnect the control circuit board connector, and connect the check LED shown below.</p>  <p>When the mains power is turned on, a pulse signal is output for 10 seconds. If the LED remains OFF or ON, the drive circuit is abnormal.</p>	When drive circuit is faulty, replace control circuit board.
LEV mechanism locked	<p>(1) When the LEV is in the locked state and driven, the motor races. At this time, a soft clicking sound is generated. When this sound is generated both when closing and when opening, the mechanism is abnormal.</p>	Replace LEV
LEV motor coil open or shorted	<p>Measure the resistance between the coils (red-white, red-orange, brown-yellow, brown-blue) with a multimeter. If <math>150 \Omega \pm 10\%</math>, the coil is normal.</p>	Replace LEV coil
Connector connection incorrect, or contact faulty	<p>(1) Visually check for loose connector terminals and check the color of the lead wires. (2) Disconnect the control circuit board connector and check the continuity with a multimeter.</p>	Check continuity of faulty point

## 3) Electronic expansion valve motor replacement instructions

### 1. Description of construction

- 1.1 A lock nut connects the motor to the valve body.
- 1.2 The motor consists of a motor rotating section, rotation transmission gear section, and a driver which converts rotation to linear motion.
- 1.3 The valve body consists of a valve assembly, which moves up and down, and an orifice.  
A bellows at the top of the valve body block isolates the refrigerant circuit from the atmosphere side.  
Therefore, the motor is not exposed to the refrigerant.

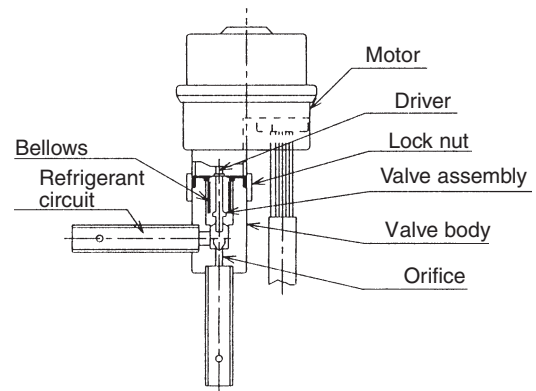

### 2. Principle of operation

- 2.1 Pulses output from the control circuit board are sequentially supplied to four coils and the motor is rotated.  
The motor can be rotated in either clockwise or counterclockwise by changing the order in which the pulses are supplied.
- 2.2 The gear section reduces the motor speed to 1/30 and supplies the motor rotation to the motor output shaft.
- 2.3 The motor output shaft is threaded and is used as a driver.
- 2.4 The up and down motion of the end of the driver moves the valve assembly of the valve body up and down and controls the flow by changing the distance between the orifice and the bottom end of the valve.

### 3. Work precautions

- 3.1 Do not apply abnormal force to the motor.
- 3.2 Do not use a motor that has been dropped.
- 3.3 Do not remove the cap until immediately before starting work.
- 3.4 Do not wipe off the molybdenum.
- 3.5 Do not remove the packing.
- 3.6 Do not coat the lock nut with a substance other than the specified lock tight, grease, etc.

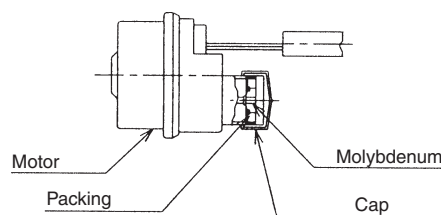

### 4. Replacement instructions

- 4.1 Stop the air conditioner from the remote controller. After confirming that the air conditioner has stopped, turn off the outdoor unit power.
- 4.2 Get two wrenches. Hold the flat part of the body with one wrench and loosen the lock nut with the other wrench. The lock nut loosens when turned counterclockwise as viewed from the motor. Always use two wrenches. Do not hold the motor with one hand and try to loosen the lock nut with only one wrench.
- 4.3 When the lock nut is turned several turns, it will disengage from the threads and the motor can be removed.
- 4.4 Get the replacement motor. The replacement motor is limited to a motor whose driver end position has been set at the factory for replacement use. (The driver end of factory set parts does not stick out.) Use of a motor whose driver end position is not set is related to erroneous valve flow control or no operation.
- 4.5 During replacement work, be sure that dirt, foreign matter, or water does not enter the part where the motor and valve body separate. (Since the part exposed by separation corresponds to the mechanical part of the valve.) Do not damage the connecting part with the tools. After removing the motor, 1 blow out the body bellows section with N<sub>2</sub> gas, etc. to remove the water clinging to the inside and 2 after fan stop processing of the pertinent unit in the motor removed state, dry the bellows section by performing the cooling operation for 30 minutes.
- 4.6 Remove the cap of the replacement motor and butt the bottom of the motor against the top of the valve body and hold it so that both are aligned and connect the motor to the valve body with the lock nut. Coat the entire periphery of the threaded part with screw lock. Be sure that the screw lock does not enter the interior. If a defect occurs during replacement work, do not use the motor, instead use a new replacement motor.
- 4.7 After tightening the lock nut 2 to 3 turns by hand, hold the flat part of the body with one wrench and tighten to the prescribed torque with a torque wrench. Tighten to a torque of 15N·m (150kgf·cm) (Control value 15 ±1N·m (150 ± 10 kgf·cm)) If tightened too tight, the flare nut may break during use.
- 4.8 When tightening the lock nut, hold the motor with your hand, etc. so that strong rotation torque and bending load are not applied.
- 4.9 The difference of the relative positions of the motor and body after assembly has no effect on the valve control and open/close mechanism. Do not try to forcefully position the motor and valve body to correct “displacement” after tightening of the lock nut due to the difference in the positional relationship between the motor and valve body before and after assembly.

Fixing with the clip may be impossible due to motor section deformation, but fixing of the piping is sufficient and fixing by clip is unnecessary.

- 4.10 Connect the connector. At this time, be sure not to pull the lead wires forcefully. Also, firmly insert the connector up to the lock and check that it cannot not be easily disconnected.
- 4.11 Turn on the outdoor unit power and operate the air conditioner from the remote controller and confirm that there are no abnormalities.

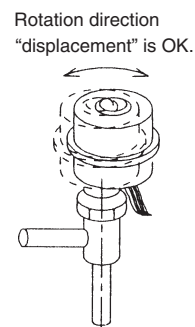

## [7] Emergency operation

- 1) When the following check displays occur at the outdoor unit, or when the wired remote controller or indoor unit microcomputer fails, if there are no other defects, emergency operation is possible by shorting the connector (CN31) on the outdoor controller board.

- Abnormalities that allow emergency operation

Display	Check contents
U4	Liquid temp thermistor (TH1) open or shorted Condenser/evaporater temp thermistor (TH3) open or shorted
E8	Indoor-outdoor communication receive abnormal (outdoor unit)
E9	Indoor-outdoor communication send abnormal (outdoor unit)
E0 - E7	Communication other than outdoor unit abnormal

- 2) Check items and precautions when performing emergency operation
- In addition to the abnormalities above, check the outdoor unit for any abnormalities. (When there is an abnormality other than the above, emergency operation is impossible.)
  - Check the operating range. (For U4 display)  
Since the outdoor fan always operates at full speed at emergency operation, do not operate the air conditioner outside the range shown below.

	Operation range (outdoor unit intake temperature)
Cooling	geater than 20 °C
Heating	less than 10 °C

Operation outside this range may cause compressor trouble.

- When performing emergency operation, set the outdoor unit after setting the emergency operation switch (SWE) on the indoor controller board. For the indoor emergency operation method, refer to the indoor unit wiring diagram.
  - A power failure causes emergency operation to become continuous operation. ON/OFF, temperature adjustment and other operations cannot be performed from the remote controller.  
(When a PEH-P8MYA or P10MYA indoor unit is connected, check that the special indoor unit power is turned on, then start emergency operation.)
  - Since cool air is discharged from the indoor unit, when the outdoor unit starts the defrosting operation during heating emergency operation, do not operate the air conditioner for a long time.
  - You can perform cooling emergency operation up to 10 hours. The indoor unit heat exchanger may freeze.
  - At the end of emergency operation, always return the switch settings, etc. to their original state.
- 3) Emergency operation contents
- The operation mode operates according to the contents set (cooling or heating) by SW4-2.
  - The fan operation condition is always 100% operation.
  - The operation mode display flashes every other second.

4) Emergency operation method

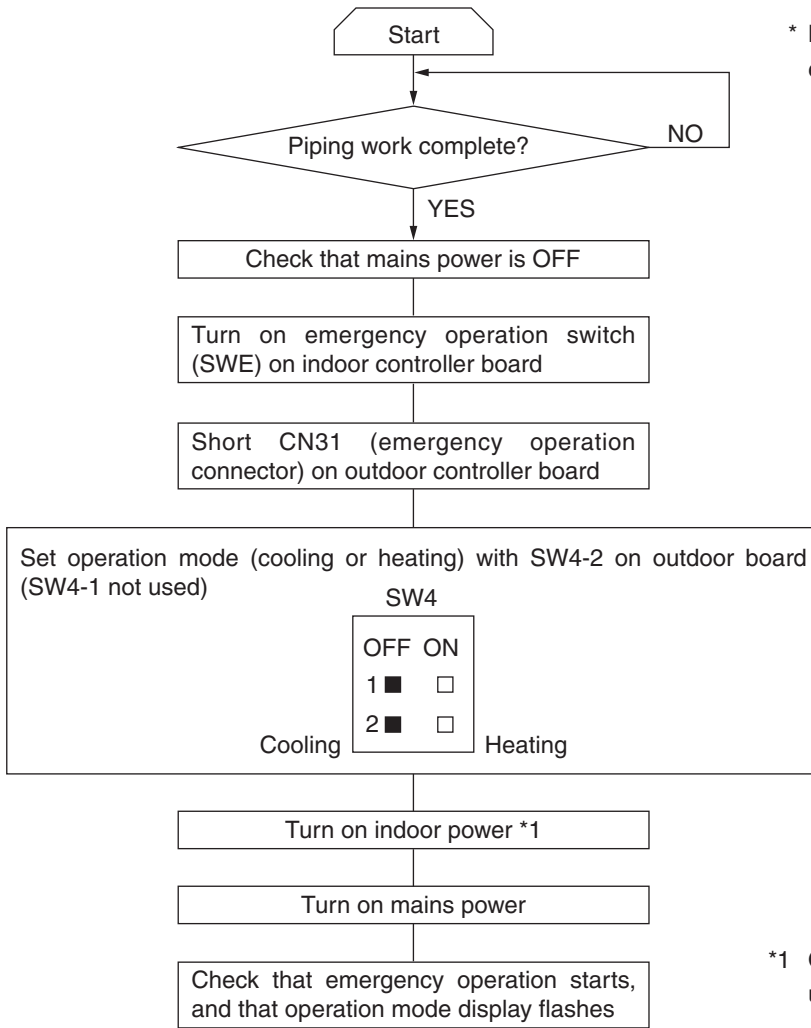

\* Before starting, recheck that the trouble allows emergency operation.

\*1 Only when PEH-P8 or 10 or 16 or 20MYA indoor unit connected.

5) Emergency operation release method

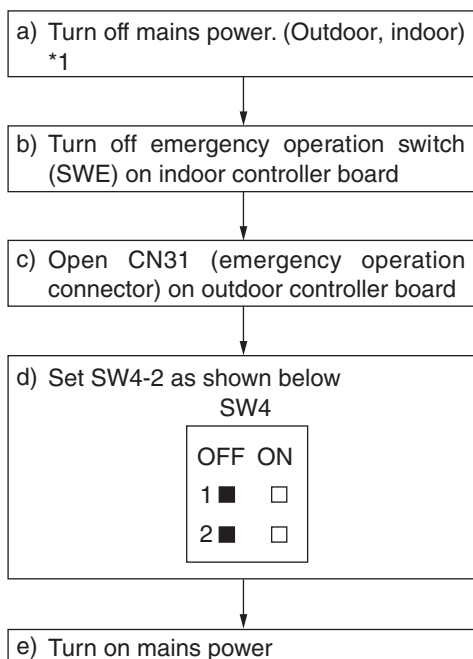

\*1. When PEH-P8 or 10 or 16 or 20MYA indoor unit is connected, first turn off the outdoor unit power, then turn off the indoor unit power.

## [8] Self-diagnosis and troubleshooting

<Abnormality detected at power on>

Abnormality display	Meaning of abnormality display and abnormality troubleshooting	Cause	Judgment method and remedy
None		(1) Voltage not applied to outdoor unit terminal block TB1. a. Power supply circuit breaker not closed. b. Power supply terminals connection faulty, or disconnected. c. Missing phase (R or S phase) (2) No electricity at controller board power supply connector. a. Power supply connector contact faulty. b. Terminal R/1 or S/2 on controller board disconnected. (3) Outdoor unit controller board faulty. a. Blown fuse on controller board. b. Part faulty.	(1) a. Check power supply circuit breaker. b. Check power supply terminal block connections. c. Check power supply terminal block connections. (2) a. Check power supply connector board connections. (3) a. Replace fuse. b. Replace controller board. (However, when cannot be repaired even through the check above was carried out.)
EA	<b>Indoor/outdoor connection erroneous wiring, too many indoor units (5 or more)</b> 1. Outdoor controller board automatically recognizes the number of connected indoor units. However, when the number of connected indoor units cannot be set due to erroneous indoor/outdoor connection, erroneous wiring, etc. even after 4 minutes have elapsed since the power was turned on, an abnormality is recognized. 2. When the outdoor controller board identified "5 or more" connected indoor units, an abnormality is recognized.	(1) Indoor/outdoor connection wire contact faulty or erroneous wiring. (2) Indoor/outdoor connection wire diameter or wiring length outside specification. (3) Five or more indoor units connected to outdoor unit. (4) Outdoor controller board send/receive circuit faulty. (5) Indoor controller board send/receive circuit faulty. (6) Noise has entered on power supply or indoor/outdoor connection wire.	(1) Check if indoor unit or outdoor unit indoor/outdoor connection wire disconnected or loose. Also check polarity. (2) Check indoor/outdoor wire diameter and wiring length. Outdoor-indoor: Max. 50m Indoor-indoor (span): Max. 30m Also check that VVF and other flat cables are connected in S1, S2, S3 order. (S2 in the middle) (3) Check number of indoor units connected to outdoor unit. (4) Check by turning power off and on. If abnormality is displayed again, replace outdoor controller board or indoor controller board. * LED3 of the indoor controller board flashes when communication is being performed.
Eb	<b>Indoor/outdoor connection erroneous wiring</b> The outdoor controller board automatically sets the unit No. of the indoor units. However, when the unit No. of the indoor units cannot be set due to indoor/outdoor connection erroneous wiring even after 4 minutes has elapsed since the power was turned on, an abnormality is recognized.	(1) Indoor/outdoor connection wire contact faulty, or erroneous wiring. (2) Indoor/outdoor connection wire diameter or wiring length outside specification. (3) Outdoor controller board send/receive circuit faulty. (4) Indoor controller board send/receive circuit faulty. (5) Noise has entered on power supply or indoor/outdoor connection wire.	
EC	<b>Start-up time over</b> When start-up processing does not end even through 4 minutes has elapsed since the power was turned on, an abnormality is recognized.	(1) Indoor/outdoor connection wire contact faulty. (2) Indoor/outdoor connection wire diameter or wiring length outside specification. (3) Noise has entered on power supply or indoor/outdoor connection wire.	
F1	<b>Reverse phase detected</b>	Power supply reverse phase connection.	(1) Check power supply terminal block connections.
F2	<b>Missing phase detected</b>	Power supply missing phase.	(2) Replace controller board (However, when cannot be repaired even though check above was carried out.)

<Abnormality detected during unit operation: Outdoor unit>

Abnormality display	Meaning of abnormality display and abnormality troubleshooting	Cause	Judgment method and remedy
U2	<b>Discharge temperature abnormal</b> When the discharge thermistor temperature (TH2) exceeds 118 °C while the compressor is operating, an abnormality is recognized.	(1) Compressor overheating due to insufficient refrigerant.  (2) Thermistor faulty. (TH2) (3) Outdoor controller board faulty.	(1) Check input super heat. Check for refrigerant leakage and check piping length. Charge with additional refrigerant. (2)(3) Turn off power and restart operation and check if U3 is displayed within 8 minutes. When U3 is displayed, carry out U3 processing. (Do not replace board at U2 display only.)
	<b>49C trip (CN23 connector disconnected)</b> When connector CN23 opens while the compressor is operating, an abnormality is recognized.	(1) Shorting connector CN23 on outdoor controller board dislodged or contact faulty.	(1) Repair shorting connector.
U3	<b>Discharge temp thermistor (TH2) open or shorted.</b> When an open (0 °C or lower) or short (216 °C or higher) is detected while the compressor is operating, an abnormality is recognized. (Detection is disabled for 5 minutes at compressor starting.)	(1) Connector (CN3) dislodged or connect faulty. (2) Thermistor faulty.  (3) Outdoor controller board faulty.	(1) Check connector contact and thermistor wire. (2) Check thermistor resistance value, or check temperature by microcomputer. (Check using SW2 self-diagnosis function.) See page 36. (3) Replace outdoor controller board. (Replace board after sufficiently checking 1 and 2.)
U4	<b>Liquid temp thermistor (TH1) or condenser/evaporator temp thermistor (TH3) open or shorted.</b> When an open (-39 °C or lower) or short (88 °C or higher) is detected while the compressor is operating, an abnormality is recognized. (Detection is disabled for 7 minutes beginning from 10 seconds after the compressor starts and for 10 minutes after return from defrosting.)	(1) Connector (TH1: CN2, TH3: CN4) dislodged or contact faulty. (2) Thermistor faulty.  (3) Outdoor controller board faulty.	(1) Check connector contact and thermistor wire. (2) Check thermistor resistance value or check temperature by microcomputer. (Check using SW2 self-diagnosis function.) See to page 36. (3) Replace outdoor controller board. (Replace board after sufficiently checking 1 and 2)
U6	<b>Compressor overcurrent trip</b> When the current value reaches the overload set value or higher while the compressor is operating, an abnormality is recognized. P8MYA ..... 22 A P10MYA ..... 27 A	(1) Overload operation exceeding unit usage range limit. (2) Power supply terminal voltage low. (3) Power supply missing phase. (4) Compressor motor faulty. (5) Compressor locked. (6) Connector (CN22) on outdoor controller board dislodged or contact faulty. (7) 51C disconnected or contact faulty.	(1) Check usage conditions. (Check for short cycle operation.) (2) Check power supply voltage. (3) Check wiring for breaks and faulty contact. (4) Check motor winding resistance (See page 35.) (5) Replace compressor. (6)(7) After checking connections, restart and check operation.
UE	<b>High pressure abnormal (63H1 trip)</b> Detected (3.3 <sup>+0.15</sup> MPa) by 63H1 trip while compressor is operating.  63H1: Pressure switch (high pressure) OFF: 3.3 MPa	(1) Started with ball valve closed. (2) Connector (CN21) on outdoor controller board dislodged or contact faulty. (3) 63H1 disconnected or contact faulty. (4) Indoor filter clogged. Power reset detected during heating overload operation (Heating). (5) Low indoor unit air flow (heating). (6) Low outdoor unit air flow (cooling). (7) Part faulty.	(1) Check if ball valve is fully open. (2)(3) Repair connector. (4) Check indoor filter. (5) Check flow duct static pressure and for faulty fan motor. (6) Check for faulty outdoor fan motor. (7) Replace pressure switch.

Abnormality display	Meaning of abnormality display and abnormality troubleshooting	Cause	Judgment method and remedy
UL	<b>Low pressure abnormal (63L trip)</b> Detected by tripping of 63L while the compressor is operating. (Ignored during defrosting and for 10 minutes at defrosting return.) 63L: Pressure switch (low pressure) OFF: 0 MPa	(1) Started with ball valve closed. (2) Connector (CN27) on outdoor controller board open or contact faulty. (3) 63L disconnected or contact faulty. (4) Part faulty.	(1) Check if ball valve fully open. (2)(3) Repair connector.  (4) Replace pressure switch.
EO	<b>Remote controller communications receive abnormal (remote controller).</b> 1) When transmission from refrigerant address "0" IC is not received normally even once in 3 minutes, an abnormality is recognized. 2) When a slave remote controller does not receive even one signal in 2 minutes, an abnormality is recognized.	(1) Remote controller send/receive circuit faulty. (2) Refrigerant address "0" indoor controller board send/receive circuit faulty. (3) Noise entered on remote controller transmission line.	Perform remote controller diagnosis. Take the following action based on the diagnosed result: a) [RC OK] display Remote controller normal. Turn power off and on and check. If "HO" remains on for 4 minutes or longer, replace indoor controller board. b) [RC NG] display Replace remote controller. c) [RC E3] display } Noise, etc. probable cause. [ERC00-66]
E3	<b>Remote controller communication send abnormal (remote controller)</b> 1) When the remote controller can not confirm that the transmission circuit is idle in 6 seconds, an abnormality is recognized. 2) When the remote controller cannot complete 30 continuous transmissions, an abnormality is recognized.	(1) Remote controller send/receive circuit faulty. (2) Noise entered on remote controller transmission line.	
E8	<b>Indoor-outdoor communication receive abnormal (Outdoor unit)</b> When the outdoor controller can not receive normally even once in 3 minutes, an abnormality is recognized.	(1) Indoor/outdoor connection wire contact faulty. (2) Outdoor controller board send/receive circuit faulty. (3) Indoor controller board send/receive circuit faulty. (4) Noise entered on indoor/outdoor connection wire.	(1) Check for disconnected or loose indoor unit or outdoor unit indoor/outdoor connection wire. (2)-(4) Turn power off and on and check. If abnormality displayed again, replace indoor controller board or outdoor controller board.
E9	<b>Indoor-outdoor communication send abnormal (Outdoor unit)</b> 1) When the outdoor controller detects reception of 30 consecutive "0" even through "1" was received, an abnormality is recognized. 2) When the outdoor controller can not confirm that the transmission circuit is idle in 3 minutes, an error is recognized.	(1) Outdoor controller board send/receive circuit faulty. (2) Noise entered at power supply. (3) Noise entered on indoor/outdoor connection wire.	(1)(2)(3) Turn power off and on and check. If abnormality displayed again, replace indoor controller board or outdoor controller board.
EF	<b>Check code undefined</b> Displayed when an undefined check code is received.	(1) Noise entered on remote controller transmission line. (2) Noise entered on indoor/outdoor connection wire.	(1)(2) Turn power off and on and check. If abnormality displayed again, replace indoor controller board or outdoor controller board.

<Abnormality detected during unit operation: Indoor unit>

Abnormality display	Meaning of abnormality display and abnormality troubleshooting	Cause	Judgment method and remedy
P1	<p><b>Intake sensor abnormal</b></p> <p>1) If thermistor open or short is detected and the compressor enters the 3 minutes restart prevention mode and does not return to normal after 3 minutes, an abnormality is recognized. (If returned, returns to normal operation.)</p> <p>2) Always detected during cool, dry, and heat operations. Short: 90 °C or higher Open: -40 °C or lower</p>	<p>(1) Thermistor characteristics faulty. (2) Connector contact faulty. (Insertion faulty) (3) Thermistor wiring open or contact faulty. (4) Indoor controller board faulty.</p>	<p>(1)-(3) Check thermistor resistance value 0 °C ..... 15.0 kΩ 10 °C ..... 9.7 kΩ 20 °C ..... 6.4 kΩ 30 °C ..... 5.3 kΩ 40 °C ..... 3.1 kΩ</p> <p>Open or faulty contact can be detected by applying force (pulling, bending) to lead wire while measuring thermistor resistance.</p> <p>(2) Check for connector faulty contact. After reinserting connector, turn on power and recheck operation.</p> <p>(4) Check remote controller room temperature display. If there is a difference between actual room temperature and displayed room temperature after checking that there are no problems at (1)-(3), replace indoor controller board. If there are no problems above, there are no abnormalities. Turn power off and on and operate.</p>
P2	<p><b>Piping sensor abnormal</b></p> <p>1) If thermistor short or open is detected and the compressor enters the 3 minutes restart prevention mode and does not return to normal after 3 minutes, an abnormality is recognized. (If returned, returns to normal operation.)</p> <p>2) Always detected during cool, dry, and heat (except during defrosting) operation. Short: 90 °C or higher Open: -40 °C or lower</p>	<p>(1) Thermistor characteristics faulty. (2) Connector contact faulty. (Insertion faulty) (3) Thermistor wiring open or contact faulty. (4) Faulty refrigerant circuit, etc. has caused thermistor temperature to rise to 90 °C or higher or drop to -40 °C or lower. (5) Indoor controller board faulty.</p>	<p>(1)-(3) Check thermistor resistance value. For characteristic, see above (P1).</p> <p>(2) Check for connector faulty contact. After reinserting connector, turn on power and recheck operation.</p> <p>(4) Operate in trail run mode and check piping temperature with remote controller. When piping temperature is abnormally low (cooling) or high (heating), refrigerant circuit is probably faulty.</p> <p>(5) Check test run mode piping temperature with remote controller. If there is a difference between actual piping temperature and displayed piping temperature when there are no abnormalities at (1)-(4), replace indoor controller board. If there is no problem above, there are no abnormalities. Turn on power and operate.</p>
P4	<p><b>Drain sensor abnormal</b></p> <p>1) If thermistor short or open continuously detected for 30 seconds, the compressor enters the check mode and turns off and the indoor fan turns off.</p> <p>2) When another short or open is continuously detected for 30 seconds in the check mode, an abnormality is recognized. (If returned, returns to normal operation.)</p> <p>3) Always detected during cool, dry, and drain pump operation. Short: 90 °C or higher Open: -20 °C or lower</p>	<p>(1) Thermistor characteristics faulty. (2) Connector contact faulty. (Insertion faulty) (3) Drain sensor wiring open or contact faulty. (4) Indoor controller board faulty.</p>	<p>(1)-(3) Check thermistor resistance value. 0 °C .... 6.0 kΩ 10 °C .... 3.9 kΩ 20 °C .... 2.6 kΩ 30 °C .... 1.8 kΩ 40 °C .... 1.3 kΩ</p> <p>(2) Check connector for faulty contact. After reinserting connector, turn on power and recheck operation.</p> <p>(4) If abnormality reproduced by shorting between drain sensor connector CN31 pins 1 and 2 and operating air conditioner, replace indoor controller board. If there are no problems above, there are no abnormalities. Turn on power and operate.</p>



<Abnormality detected during unit operation: Indoor unit>

Abnormality display	Meaning of abnormality display and abnormality troubleshooting	Cause	Judgment method and remedy
P5	<b>Drain overflow protection operation</b> 1) When the drain sensor thermistor overheats and the temperature rise is small, the compressor enters the check mode and is turned off and the indoor fan is turned off. 2) If the state above is detected again in the check mode, drain pump abnormality is recognized. 3) Always detected during drain pump operation.	(1) Drain pump trouble. (2) Drain faulty. Drain pump clogged. Drain pipe clogged. (3) Water droplets on drain sensor. Drain water waves created by transmission of drain water from lead wire, clogged filter, etc. (4) Indoor controller board faulty.	(1) Check drain up mechanism. (2) Check drain characteristic. (3) Check drain sensor lead wire arrangement and check for filter clogging. (4) If abnormality reproduced by shorting between drain sensor connector CN31 pins 1 and 2 and operating air conditioner, replace indoor controller board. If there are no problems above, there are no abnormalities. Turn on the power and operate.
	<b>Water leakage abnormality (PDH only)</b> 1) When the drain sensor thermistor overheats and the temperature rise is small, the compressor enters the check mode and the drain pump is turned on for 6 minutes. (Detection: 1 time/hour) 2) If the state above is detected again within 12 hours after the check mode was entered, a water leakage abnormality is recognized. 3) Detected during stop, fan, and heat operation.	(1) Water leaking from humidifier water supply pipe. (2) Water droplets on drain sensor. (3) Indoor controller board faulty.	(1) Repair water leakage. (2) Check drain sensor lead wire arrangement and check for filter clogging. (3) If abnormality reproduced by shorting between drain sensor connector CN31 pins 1 and 2 and operating air conditioner, replace indoor controller board. If there are no problems above, there are no abnormalities. Turn on power and operate.
P6	<b>Freezing/excessive rise protection operation</b> 1) Freezing protection When the piping temperature remains at $-15^{\circ}\text{C}$ or lower for 3 minutes after 3 minutes have elapsed since the compressor started, the compressor enters the 6 minutes restart prohibit mode and if the piping temperature again remains at $-15^{\circ}\text{C}$ for 3 minutes within 16 minutes after 6 minutes restarting, an abnormality is recognized. 2) Excessive rise protection When a piping temperature rise to $70^{\circ}\text{C}$ or higher is detected after the compressor starts, the compressor enters the 6 minutes restart prohibit mode. If a piping temperature rise up to $70^{\circ}\text{C}$ or higher is detected again within 10 minutes after 6 minutes restarting, an abnormality is recognized.	<Cool and dry> (1) Filter is clogged (insufficient air flow). (2) Air duct short cycle. (3) Low load operation (low temperature) exceeding allowable range. (4) Indoor fan motor faulty. (5) Outdoor fan control faulty (intermediate period, winter). (6) Refrigerant overcharged. (7) Refrigerant circuit faulty (clogged).  <Heat> (1) Filter clogged (insufficient air flow) (2) Air duct short cycle. (3) Overload operation (high temperature) exceeding allowable range. (4) Indoor fan motor faulty. (5) Outdoor fan control faulty (intermediate period) (6) Refrigerant overcharged. (7) Refrigerant circuit faulty (clogged) (8) Outdoor unit bypass circuit faulty.	<Cool and dry> (1) Check filter for clogging. (2) Remove obstruction. (4) Check fan motor operation and winding resistance. (5) Check outdoor fan motor operation. (6)(7) Check refrigerant circuit operation.  <Heat> (1) Check filter for clogging. (2) Remove obstruction. (4) Check fan motor operation and winding resistance. (5) Check outdoor fan motor operation. (6)-(8) Check refrigerant circuit operation.

<Abnormality detected during unit operation: Indoor unit>

Abnormality display	Meaning of abnormality display and abnormality troubleshooting	Cause	Judgment method and remedy
P8	<p><b>Piping temperature abnormal</b></p> <p>&lt;Cool&gt; When the piping temperature stays outside the cooling area for 1 minute after 3 minutes have elapsed since the compressor was started, the indoor fan operates at low speed. If the piping temperature does not return to the cooling area after 5 minutes operation at low speed, an abnormality is recognized. Note 1) It takes a minimum of 9 minutes for an abnormality to be detected. Note 2) At dry operation, P8 abnormality is not detected.</p> <p>&lt;Heat&gt; When the piping temperature falls outside the heating area and enters the ventilation area after compressor operation and the end of hot adjust, the indoor fan stops and the piping temperature does not return to the heating area within 20 minutes after 10 seconds have elapsed after it left the heating area, an abnormality is recognized. Note 3) It takes a minimum of 22 minutes and a maximum of 27 minutes for an abnormality to be detected. Note 4) Except during defrosting (Detected again after defrosting return.)</p>	<p>(1) Indoor intake piping thermistor temperature differential small. - EInsufficient refrigerant - EPiping thermistor holder dislodged. - ERefrigerant circuit faulty.</p> <p>(2) Extension piping (When multiple units connected).</p> <p>(3) Indoor/outdoor connection wire (When multiple units connected).</p> <p>(4) Indoor intake piping thermistor detection faulty.</p>	<p>(1) Operate in test run mode and check piping temperature.</p> <p>(2)(3) Check extension piping or indoor/outdoor connection wire.</p> <p>(4) Check remote controller room temperature display and piping temperature in test run mode.</p>
E4	<p>Remote control communication receive abnormal</p> <p>1) When the indoor controller board can not receive data normally from the remote controller or another indoor controller board even once in 3 minutes, an abnormality is recognized.</p> <p>2) When the indoor controller board can not receive signals even once in 2 minutes, an abnormality is recognized.</p>	<p>(1) Remote controller transmission line contact faulty.</p> <p>(2) All remote controllers set as "slave" remote controller.</p> <p>(3) Remote controller send/receive circuit faulty.</p> <p>(4) Indoor controller board send/receive circuit faulty.</p> <p>(5) Noise entered on remote controller transmission line.</p>	<p>(1) Check if indoor unit or remote controller transmission line disconnected or loose.</p> <p>(2) Set one remote controller as "master". When there are no problems at the above</p> <p>(3) Perform remote controller diagnosis.</p> <p>a) [RC OK] display Remote controller normal. Check by turning power off and on. If the abnormality occurs again, replace indoor controller board.</p> <p>b) [RC NG] display Replace remote controller.</p> <p>c) [RC E3] display [ERC00-66] noise, etc. is probable cause.</p>

\* Error countermeasures for PEH-P16-20MYA

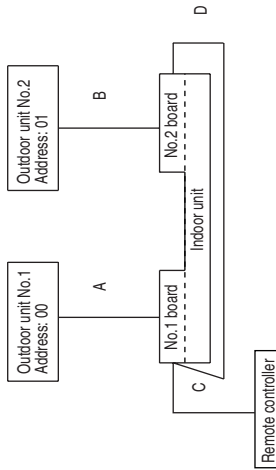

- A : No. 1 system indoor/outdoor unit transmission cable.
- B : No. 2 system indoor/outdoor unit transmission cable.
- C : Remote controller cable for board No.1 (communication of operation and control details).
- D : Cable connecting No.1 and No.2 board (communication of operation and control details)

		Stoppage (power supplied)			During Operation			
		【Error Details】	【Recommended Countermeasure】	【Error Details】	【Recommended Countermeasure】	【Error Details】	【Recommended Countermeasure】	
Wiring Errors	Cable A breakage, reverse connection	<p>Prior to power ON to boot-up</p> <p>【Error Details】 The outdoor unit for address 00 is no longer connected to the system, and operation is not possible as there is no power supply to the remote controller. Error can be confirmed at outdoor unit LED.</p>	<p>【Recommended Countermeasure】 (1) Repair cable A. [Emergency Repair] (1) Set to the No.2 address 00 and cut the power to the No.1 outdoor unit. (single system operation.) Change No.1 address to 01.</p>	<p>【Error Details】 The outdoor unit for address 00 is no longer connected to the system, and operation is not possible as there is no power supply to the remote controller, resulting in an error.</p>	<p>【Recommended Countermeasure】 (1) Repair cable A. [Emergency Repair] (1) Set to the No.2 address 00 and cut the power to the No.1 outdoor unit. (single system operation.) Change No.1 address to 01.</p>	<p>【Error Details】 The outdoor unit for address 00 is no longer connected to the system, and operation is not possible as there is no power supply to the remote controller, resulting in an error.</p>	<p>【Recommended Countermeasure】 (1) Repair cable A. [Emergency Repair] (1) Set to the No.2 address and cut the power to the No.1 outdoor unit. (single system operation.) Change No.1 address to 01.</p>	
	Cable B breakage, reverse connection	<p>Unable to boot up system No.2 and error detected at both the outdoor and indoor unit, however, the remote controller cannot be used during the stoppage, and therefore no error is indicated. Error can be confirmed at outdoor unit LED. (No.1 system has booted up and therefore operation is possible.)</p>	<p>【Recommended Countermeasure】 (1) Repair cable B. [Emergency Repair] (1) Cut power to outdoor unit No.2. Single system operation.</p>	<p>Error detected at both No.2 outdoor and indoor unit, however, the remote controller cannot be used during the stoppage, and therefore no error is indicated.</p>	<p>【Recommended Countermeasure】 (1) Repair cable B. [Emergency Repair] (1) Cut power to outdoor unit No.2. Single system operation.</p>	<p>Error occurred at both No.2 system outdoor and indoor unit and error occurs at remote controller. Operation can be continued as no error has occurred at system No.1, however, remote controller operation is not possible other than at stoppage. (No fan stoppage.)</p>	<p>(1) Repair cable B. [Emergency Repair] (1) Cut power to outdoor unit No.2. Single system operation.</p>	
	Cable C breakage, reverse connection	<p>No power to remote controller and so inoperable. Error can be confirmed at outdoor unit LED.</p>	<p>【Recommended Countermeasure】 (1) Repair cable C</p>	<p>Communication error detected at No.1 and No.2 system indoor unit due to remote controller error, however, no error reported at remote controller as inoperable during stoppage.</p>	<p>Communication error detected at No.1 and No.2 system indoor unit due to remote controller error, and all systems stopped.</p>	<p>(1) Repair cable C</p>	<p>Communication error detected at No.1 and No.2 system indoor unit due to remote controller error, and all systems stopped.</p>	<p>(1) Repair cable C</p>
	Cable D breakage, reverse connection	<p>Communication error detected at No.2 system indoor unit, however, no error reported at remote controller when D breakage occurs. Error can be confirmed at outdoor unit LED. (No.1 system has booted up and therefore operation is possible.)</p>	<p>【Recommended Countermeasure】 (1) Repair cable D</p>	<p>Communication error detected at No.2 system indoor unit, however, no error reported at remote controller when D breakage occurs. No.2 system cannot be operated.</p>	<p>Communication error detected at No.2 system indoor unit, however, no error reported at remote controller when D breakage occurs. Communication error detected at No.2 system indoor unit, resulting in stoppage.</p>	<p>(1) Repair cable C</p>	<p>Communication error detected at No.2 system indoor unit, however, no error reported at remote controller when D breakage occurs. Communication error detected at No.2 system indoor unit, resulting in stoppage.</p>	<p>(1) Repair cable C</p>
Refrigerant Related Errors	No.1 system error	<p>Normal boot-up completed.</p>	<p>No error occurs, therefore no countermeasures possible.</p>	<p>Normal stoppage</p>	<p>No error occurs, therefore no countermeasures possible.</p>	<p>No.1 system error stoppage. No.2 system stoppage. Remote controller indicates error, however, remote controller operation is not possible other than at stoppage. (No fan stoppage.)</p>	<p>Correct cause of error.</p>	
	No.2 system error	<p>Normal boot-up completed.</p>	<p>No error occurs, therefore no countermeasures possible.</p>	<p>Normal stoppage</p>	<p>No error occurs, therefore no countermeasures possible.</p>	<p>No.1 system stoppage. No.2 system error stoppage. Remote controller indicates error, however, remote controller operation is not possible other than at stoppage. (No fan stoppage.)</p>	<p>Correct cause of error.</p>	
	51F error	<p>Normal boot-up completed.</p>	<p>No error occurs, therefore no countermeasures possible.</p>	<p>Normal stoppage</p>	<p>No error occurs, therefore no countermeasures possible.</p>	<p>No.1 system stoppage. No.2 system error stoppage. Remote controller indicates error, however, remote controller operation is not possible other than at stoppage. (Fan stoppage.)</p>	<p>Correct cause of error.</p>	

<Troubleshooting and repair by symptom>

Symptom and operation when normal	Cause	Symptom judgment and remedy
1. No remote controller display	<p>(1) DC14V is not supplied to remote controller. (No power O display on liquid crystal panel.)</p> <p>(2) DC14V is supplied to remote controller but nothing is displayed. - "H0" not displayed - "H0" displayed</p>	<p>(1) Check LED2 on indoor controller board.</p> <p>1) Steady light Check remote controller wire open or faulty contact.</p> <p>2) Flashing Check for remote controller wire short.</p> <p>3) Not lit Check outdoor controller refrigerant address.</p> <p>(2) Make the following judgment: - When "H0" is not displayed, remote controller is faulty. - When "H0" is displayed, see item 2.</p>
2. Remote controller displays "H0" unchanged.	<p>(1) Remote controller displays "H0" for maximum of 2 minutes for starting after power turned on.</p> <p>(2) Indoor-remote controller communication faulty.</p> <p>(3) Outdoor-indoor communication faulty.</p>	<p>(1) Normal operation.</p> <p>(2) Remote controller self-diagnosis.</p> <p>(3) When outdoor-indoor cannot communicate "H0" is displayed for a maximum 6 minutes. Check LED3 on indoor controller board.</p> <p>1) Does not flash Check indoor/outdoor connection cable for erroneous wiring. (S1 and S2 or S3 open)</p> <p>2) Flashes Indoor/outdoor connection cable is normal.</p>
3. When remote controller operation switch pressed, operation display appears but immediately disappears.	<p>(1) Operation switch is disabled for approximately 30 seconds after function select operation from remote controller is released.</p>	<p>(1) Normal operation.</p>
4. Does not beep and air conditioner does not operate even when operated with wireless remote controller. (Operation display appears on wireless remote controller.)	<p>(1) Wireless remote controller and indoor controller board pair number setting mismatched.</p> <p>(2) Cause of item 1.</p>	<p>(1) Check pair number setting.</p> <p>(2) Item check of item 1.</p>
5. When operated with wireless remote controller, beeps but does not operate.	<p>(1) Air conditioner does not operate for a maximum of 2 minutes after the power is turned on.</p> <p>(2) Set to local operation prohibit mode. - Remote start/stop adapter is connected to CN32 on indoor controller board. - Air conditioner is connected to MELANS and is set to local operation prohibit mode from centralized controller, etc.</p> <p>(3) Cause of item 2.</p>	<p>(1) Normal operation.</p> <p>(2) Normal operation.</p> <p>(3) Item check of item 2.</p>
6. Remote controller display is normal and cooling operation is performed, but without any capacity (does not cool).	<p>(1) Insufficient refrigerant.</p> <p>(2) Filter clogged.</p> <p>(3) Outdoor unit heat exchanger clogged.</p> <p>(4) Air duct short cycle.</p> <p>(5) Outdoor unit bypass circuit faulty.</p>	<p>(1) - When there is leakage, discharge temperature rises. Therefore, check by measuring temperature. - Check for gas leakage from piping connections, etc.</p> <p>(2) Open intake grille and check filter. Clean filter, and remove dust and dirt.</p> <p>(3) - Since both indoor piping temperature and outlet pressure rise when filter clogged, judge by measuring outlet pressure. - Clean heat exchanger.</p> <p>(4) Remove obstruction.</p> <p>(5) Check refrigerant circuit operation state.</p>

Symptom and operation when normal	Cause	Symptom judgment and remedy
<p>7. Remote controller display is normal and heating operation is performed but without any capacity (does not heat).</p>	<p>(1) Insufficient refrigerant.  (2) Refrigerant piping heat insulation insufficient.  (3) Filter clogged.  (4) Indoor unit heat exchanger clogged.  (5) Air duct short cycle.  (6) Outdoor unit bypass circuit faulty.</p>	<p>(1) - Since the discharge temperature rises when there is leakage, judge by measuring the temperature.  - Check piping connections, etc. for gas leakage.  (2) Check heat insulation.  (3) Open intake grille and check filter.  Clean filter, and remove dust and dirt.  (4) - Since the indoor piping temperature and outlet pressure rise when the heat exchanger is clogged, judge by measuring the outlet pressure.  - Clean heat exchanger.  (5) Remove obstruction.  (6) Check refrigerant circuit operation state.</p>

<Indoor/outdoor connection wire erroneous wiring and open symptoms>

Erroneous wiring contents	Condition	Remote controller display	Indoor controller board LED display			Outdoor controller board LED display	Remarks
			LED1	LED2	LED3		
Outdoor side S1 ⊙ ————— ⊙ S1 S2 ⊙ ————— ⊙ S2 S3 ⊙ ————— ⊙ S3 Indoor side	Trial run (relocation)	“⊙” Power supply mark	On	On	Flashing	OO	Normal wiring
Outdoor side S1 ⊙ ————— ⊙ S1 S2 ⊙ ————— ⊙ S2 S3 ⊙ ————— ⊙ S3 Indoor side	Trial run	No display	Off	Off	Off	EA (after 4 minutes)	
Outdoor side S1 ⊙ ————— ⊙ S2 S2 ⊙ ————— ⊙ S1 S3 ⊙ ————— ⊙ S3 Indoor side	relocation	No display	Off	Off	Off	Eb (after 4 minutes)	
Outdoor side S1 ⊙ ————— ⊙ S1 S2 ⊙ ————— ⊙ S2 S3 ⊙ ————— ⊙ S3 Indoor side	Trial run	No display	On	Off	Off	EA (after 4 minutes)	
Outdoor side S1 ⊙ ————— ⊙ S2 S2 ⊙ ————— ⊙ S1 S3 ⊙ ————— ⊙ S3 Indoor side	relocation	Eb	On	On	Off	Eb (after 4 minutes)	
Outdoor side S1 ⊙ ————— ⊙ S1 S2 ⊙ ————— ⊙ S2 S3 ⊙ ————— ⊙ S3 Indoor side	Trial run	No display	Off	Off	Off	EA (after 4 minutes)	
Outdoor side S1 ⊙ ————— ⊙ S2 S2 ⊙ ————— ⊙ S1 S3 ⊙ ————— ⊙ S3 Indoor side	relocation	No display	Off	Off	Off	Eb (after 4 minutes)	
Outdoor side S1 ⊙ ————— ⊙ S1 S2 ⊙ ————— ⊙ S2 S3 ⊙ ————— ⊙ S3 Indoor side	Trial run	No display	On	Off	Off	EA (after 4 minutes)	
Outdoor side S1 ⊙ ————— ⊙ S2 S2 ⊙ ————— ⊙ S1 S3 ⊙ ————— ⊙ S3 Indoor side	relocation	No display	Off	Off	Off	Eb (after 4 minutes)	
Outdoor side S1 ⊙ ————— ⊙ S1 S2 ⊙ ————— ⊙ S2 S3 ⊙ ————— ⊙ S3 Indoor side	Trial run	No display	On	Off	Off	EA (after 4 minutes)	
Outdoor side S1 ⊙ ————— ⊙ S2 S2 ⊙ ————— ⊙ S1 S3 ⊙ ————— ⊙ S3 Indoor side	relocation	No display	Off	Off	Off	Eb (after 4 minutes)	
Outdoor side S1 ⊙ — x ——— ⊙ S1 S2 ⊙ ————— ⊙ S2 S3 ⊙ ————— ⊙ S3 Indoor side	Trial run	No display	Off	Off	Off	EA (after 4 minutes)	Open between S1
Outdoor side S1 ⊙ ————— ⊙ S1 S2 ⊙ — x ——— ⊙ S2 S3 ⊙ ————— ⊙ S3 Indoor side	relocation	No display	Off	Off	Off	Eb (after 4 minutes)	
Outdoor side S1 ⊙ ————— ⊙ S1 S2 ⊙ ————— ⊙ S2 S3 ⊙ ————— ⊙ S3 Indoor side	Trial run	No display	Off	Off	Off	EA (after 4 minutes)	Open between S2
Outdoor side S1 ⊙ ————— ⊙ S1 S2 ⊙ — x ——— ⊙ S2 S3 ⊙ ————— ⊙ S3 Indoor side	relocation	No display	Off	Off	Off	Eb (after 4 minutes)	
Outdoor side S1 ⊙ ————— ⊙ S1 S2 ⊙ ————— ⊙ S2 S3 ⊙ ————— ⊙ S3 Indoor side	Trial run	No display	On	Off	Off	EA (after 4 minutes)	Open between S3
Outdoor side S1 ⊙ ————— ⊙ S1 S2 ⊙ ————— ⊙ S2 S3 ⊙ — x ——— ⊙ S3 Indoor side	relocation	Eb	On	On	Off	Eb (after 4 minutes)	

## 8 Test run

### (1) Test run (For PUH-P8MYA/P10MYA)

The test run can be carried out either from the outdoor unit or the indoor unit.

#### 1. Check list

- After the installation, piping setup, and wiring of the indoor and outdoor units is complete, check that refrigerant is not leaking, the power and control wires are not loose, and the poles are not reversed. (When connecting model PEH-P-YE in particular, check that there is current in the separate power supply cable for the indoor unit.)
- Use a 500 V insulation resistance tester to make sure that the resistance between the power terminal and the ground is 1.0 MΩ or more. If it is less than 1.0 MΩ, do not operate the unit. \* Absolutely do not touch the tester to indoor/outdoor connection terminals S1, S2, and S3. An accident could occur.
- Make sure there is no malfunction in the outdoor unit. (If there is a malfunction, you can diagnose it using LED2 on the board.)
- Check that the ball valve is fully open on both the liquid and gas ends.
- Check the electrical power phase. If the phase is reversed, the fan may rotate in the wrong direction or stop, or unusual sounds may be produced.
- Starting at least 12 hours before the test run, send current through the crankcase heater. (If the current is running for a shorter period of time, damage to the compressor could result.)

After the above checks are complete, carry out the test run as indicated in the following outline.

#### 2. Starting and finishing the test run

- Procedure from the indoor unit: carry out the test run as in the manual provided with the indoor unit.
- Procedure from the outdoor unit: start and stop the test run and set test run mode (cooling/heating) using the SW4 dip switches on the board.
  - a) Set test run mode (cooling/heating) using SW 4-2.
  - b) The test run will begin when SW 4-1 is turned ON, according to the mode selected by SW 4-2.
  - c) The test run is stopped when SW 4-1 is turned OFF.

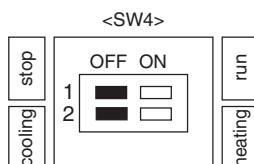

#### Note:

**Test run mode cannot be stopped during operation by using SW 4-2. (If the operation mode is to be changed, first stop it using SW 4-1, then after changing the operation mode, start the test run again using SW 4-1.)**

- If the 2-hour timer is set, the test run will stop automatically after 2 hours.
- During the test run, the room temperature display on the indoor unit will indicate the temperature of the indoor unit piping.

**(2) How to handle problems with the test run (For PUH-P8MYA/P10MYA)**

Error code list: details

Error details	Problem location	MELANS display	Remote controller display
Remote controller communication – reception error	Remote Controller	6831,6834	E0
Remote controller communication – transmission error	Remote Controller	6832,6833	E3
Remote controller communication – reception error	Indoor unit	6831,6834	E4
Remote controller communication – transmission error	Indoor unit	6832,6833	E5
Communication between indoor and outdoor units – reception error	Indoor unit	6740,6843	E6
Communication between indoor and outdoor units – transmission error	Indoor unit	6841,6842	E7
Communication between indoor and outdoor units – reception error	Outdoor unit	6840,6843	E8
Communication between indoor and outdoor units – transmission error	Outdoor unit	6841,6842	E9
Indoor/outdoor connection wiring error, indoor unit overload (5 units or more)	Outdoor unit	6844	EA
Indoor/outdoor connection wiring error (interference, loose)	Outdoor unit	6845	EB
Excessive time in use	Outdoor unit	6846	EC
Serial communication error	Outdoor unit	0403	ED
Serial communication error	M-NET board	0403	EE
Reverse phase, out of phase verification	Outdoor unit	4103	F1
Faulty input circuit	Outdoor unit	4115	F8
Duplicated M-NET address setting	M-NET board	6600	A0
M-NET error in PH/W transmission	M-NET board	6602	A2
M-NET bus busy	M-NET board	6603	A3
M-NET communication error with P transmission	M-NET board	6606	A6
M-NET error – no ACK	M-NET board	6607	A7
M-NET error- no response	M-NET board	6608	A8
Undefined error code	–	undefined	EF
Outlet temperature error	Outdoor unit	1102	U2
CN23 Short-circuit Connector Unplugged	Outdoor unit	1108	U2
Open/short in discharge temp thermistor	Outdoor unit	5104	U3
Open/short in liquid temp or condenser/evaporater temp thermistor	Outdoor unit	5105	U4
Compressor overcurrent interruption (51C operation)	Outdoor unit	4101	U6
High pressure error (63H1 operation)	Outdoor unit	1302	UE
Low pressure error (63L operation)	Outdoor unit	1300	UL
Power synchronous idle circuit error	Outdoor unit	4115	F8
Inlet sensor error	Indoor unit	5101	P1
Piping sensor error	Indoor unit	5102	P2
Drain sensor error	Indoor unit	2503	P4
Drain overflow protector operation	Indoor unit	2502	P5
Water leak error (PDH only)	Indoor unit	2500	P5
Freeze prevention operation	Indoor unit	1503	P6
Surge prevention operation	Indoor unit	1504	P6
Piping temperature error	Indoor unit	1110	P8

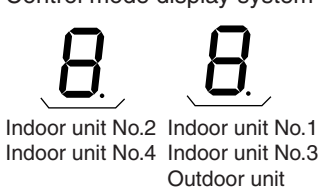

- Depending on the position of the SW2 switch on the outdoor unit board, the segments light up to indicate the running condition of the unit and the particulars of the check code.

SW2 setting 123456	Item	Display contents																													
000000	Operation mode/relay output	tens place    O: stop C: cooling H: heating d: defrosting units place    1: SV1            Relay output = SV1 + 21S4 + 52C 2: 21S4 4: 52C  Ex. During cooling mode, when 52C and SV1 are ON: C5  When an error occurs, the error code and error signal (*1) are displayed in alternation.																													
011110	Outdoor unit control condition	Control mode display system																													
010110	Indoor unit control condition (IC1) (IC2)	<table border="1"> <thead> <tr> <th rowspan="2">Display</th> <th colspan="2">Control mode</th> </tr> <tr> <th>Indoor unit</th> <th>Outdoor unit</th> </tr> </thead> <tbody> <tr> <td>0</td> <td>Ordinary</td> <td>←</td> </tr> <tr> <td>1</td> <td>Hot adjustment</td> <td>←</td> </tr> <tr> <td>2</td> <td>Defrosting</td> <td>←</td> </tr> <tr> <td>3</td> <td>—</td> <td>←</td> </tr> <tr> <td>4</td> <td>Heater ON</td> <td>←</td> </tr> <tr> <td>5</td> <td>Freeze prevention</td> <td>←</td> </tr> <tr> <td>6</td> <td>Surge prevention</td> <td>←</td> </tr> <tr> <td>7</td> <td>Compressor OFF</td> <td>←</td> </tr> </tbody> </table> 	Display	Control mode		Indoor unit	Outdoor unit	0	Ordinary	←	1	Hot adjustment	←	2	Defrosting	←	3	—	←	4	Heater ON	←	5	Freeze prevention	←	6	Surge prevention	←	7	Compressor OFF	←
Display	Control mode																														
	Indoor unit		Outdoor unit																												
0	Ordinary	←																													
1	Hot adjustment	←																													
2	Defrosting	←																													
3	—	←																													
4	Heater ON	←																													
5	Freeze prevention	←																													
6	Surge prevention	←																													
7	Compressor OFF	←																													
110110	Indoor unit control condition (IC3) (IC4)																														
011100	Error code history 1	The error code (ex. U8, UA) and error indicator (*1) are displayed in alternation.																													
111100	Error code history 2																														

\*1 Display system for error indicator

The indicator corresponds to the following numbers

- 0 ..... Outdoor unit
- 1 ..... Indoor unit No.1
- 2 ..... Indoor unit No.2
- 3 ..... Indoor unit No.3
- 4 ..... Indoor unit No.4



Certificate Number FM33568

The Air Conditioning & Refrigeration Systems Works acquired ISO 9001 certification under Series 9000 of the International Standard Organization (ISO) based on a review of quality warranties for the production of refrigeration and air conditioning equipment.

#### ISO Authorization System

The ISO 9000 series is a plant authorization system relating to quality warranties as stipulated by the ISO. ISO 9001 certifies quality warranties based on the "design, development, production, installation and auxiliary services" for products built at an authorized plant.



Certificate Number EC97J1227  
Registered on March 10, 1998

The Air Conditioning & Refrigeration Systems Works acquired environmental management system standard ISO 14001 certification.

The ISO 14000 series is a set of standards applying to environmental protection set by the International Standard Organization (ISO). ISO 14001 certifies the plant's environmental protection system and activities.

 **MITSUBISHI ELECTRIC CORPORATION**  
HEAD OFFICE MITSUBISHI DENKI BLDG. MARUNOUCHI TOKYO 100-0005 TELEX J24532 CABLE MELCO TOKYO