



SPLIT-TYPE, HEAT PUMP AIR CONDITIONERS

CE
2001

No. OC238
REVISED EDITION-B

TECHNICAL & SERVICE MANUAL

Series PMH Ceiling Cassettes R407C

Indoor unit
[Model names]

PMH-P1BA

PMH-P1.6BA

PMH-P2BA

[Service Ref.]

PMH-P1BA
PMH-P1BA₁
PMH-P1.6BA
PMH-P1.6BA₁
PMH-P2BA
PMH-P2BA₁

- PMH-P1BA₁, PMH-P1.6BA₁, PMH-P2BA₁ are added in REVISED EDITION-B.
- Please void OC238.REVISED EDITION-A.
- Refer to the OCT03 REVISED EDITION-C as regarding control relation. This manual does not cover outdoor units. When servicing them, please refer to the service manual No.OC180 REVISED EDITION-A, OC261 and this manual in a set.

[Service Ref.]

<OC180 REVISED EDITION-A>

PUH-P1.6VGA

PUH-P1.6YGA

PUH-P2VGA

PUH-P2YGA

<OC261>

PUH-P1VGAA.UK

PUH-P1.6VGAA.UK

PUH-P1.6YGAA.UK

PUH-P2VGAA.UK

PUH-P2YGAA.UK

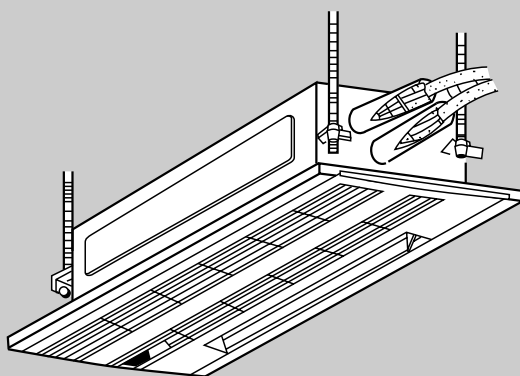

INDOOR UNIT

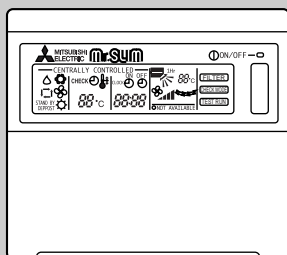

PMH- P1,1.6,2BA

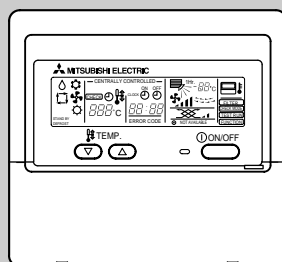

PMH- P1,1.6,2BA₁

REMOTE CONTROLLER

CONTENTS

1. TECHNICAL CHANGES	2
2. COMBINATION OF INDOOR AND OUTDOOR UNITS ...	3
3. SAFETY PRECAUTION	3
4. PART NAMES AND FUNCTIONS	5
5. SPECIFICATIONS	10
6. DATA	16
7. OUTLINES AND DIMENSIONS	29
8. WIRING DIAGRAM	30
9. REFRIGERANT SYSTEM DIAGRAM	31
10. TROUBLE SHOOTING	32
11. DISASSEMBLY PROCEDURE	35
12. PARTS LIST	38
13. OPTIONAL PARTS	41

Mr. SLIM™

1

TECHNICAL CHANGES

PMH-P1BA → PMH-P1BA₁ PMH-P1.6BA → PMH-P1.6BA₁
PMH-P2BA → PMH-P2BA₁

- Outdoor units which are connected to PMH-P•BA and PMH-P•BA₁ have been added.
- The parts No. of REMOTE CONTROLLER has changed. (The following parts numbers are interchangeable.)

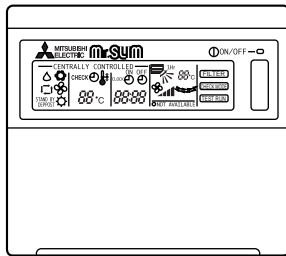

[T7W E00 713]

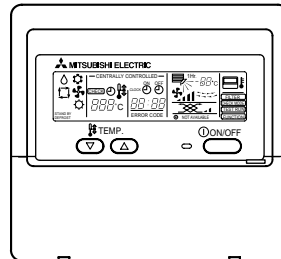

[T7W E06 713]

2

COMBINATION OF INDOOR AND OUTDOOR UNITS

Indoor unit	Outdoor unit								
	PUH-P								
	1.6VGA	1.6YGA	2VGA	2YGA	1VGAA.UK	1.6VGAA.UK	1.6YGAA.UK	2VGAA.UK	2YGAA.UK
PMH-P1BA	—	—	—	—	○	—	—	—	—
PMH-P1.6BA	○	○	—	—	—	○	○	—	—
PMH-P2BA	—	—	○	○	—	—	—	○	○
PMH-P1BA ₁	—	—	—	—	○	—	—	—	—
PMH-P1.6BA ₁	—	—	—	—	—	○	○	—	—
PMH-P2BA ₁	—	—	—	—	—	—	—	○	○

3

SAFETY PRECAUTION

Cautions for using with the outdoor unit which adopts R407C refrigerant.

- **Do not use the existing refrigerant piping.**
-The old refrigerant and lubricant in the existing piping contains a large amount of chlorine which may cause the lubricant of the new unit to deteriorate.
 - **Do not use copper pipes which are broken, deformed or discolour .**
In addition, be sure that the inner surfaces of the pipes are clean, free of hazardous sulphur and oxides, or have no dust / dirt, shaving particles, oils, moisture or any other contamination.
-If there is a large amount of residual oil (hydraulic oil, etc.) inside the piping and joints, deterioration of the lubricant will result.
 - **Store the piping to be used during installation indoors and keep both ends of the piping sealed until just before brazing. (Store elbows and other joints in a plastic bag.)**
-If dust, dirt, or water enters the refrigerant cycle, deterioration of the oil and compressor trouble may result.
 - **Use ester oil, ether oil or alkyl benzene (small amount) as the lubricant to coat flares and flange connections.**
-The lubricant will degrade if it is mixed with a large amount of mineral oil.
- Use liquid refrigerant to fill the system.**
-If gas refrigerant is used to fill the system, the composition of the refrigerant in the cylinder will change and performance may drop.
- **Do not use a refrigerant other than R407C.**
-If another refrigerant (R22, etc.) is used, the chlorine in the refrigerant may cause the lubricant to deteriorate.
 - **Use a vacuum pump with a reverse flow check valve.**
-The vacuum pump oil may flow back into the refrigerant cycle and cause the lubricant to deteriorate.
 - **Do not use the following tools that are used with conventional refrigerant. (Gauge manifold , charge hose, gas leak detector, reverse flow check valve, refrigerant charge base, vacuum gauge, refrigerant recovery equipment)**
-If the conventional refrigerant and lubricant are mixed in the R407C, the refrigerant may deteriorated.
-If water is mixed in the R407C, the lubricant may deteriorate.
-Since R407C does not contain any chlorine, gas leak detectors for conventional refrigerant will not react to it.
 - **Do not use a charging cylinder.**
-Using a charging cylinder may cause the refrigerant to deteriorate.
 - **Be especially careful when managing the tools.**
-if dust, dirt, or water gets in the refrigerant cycle, the refrigerant may deteriorate.
 - **Do not use the drier which is sold in the field.**
-The drier for R407C refrigerant is per-attached to outdoor unit refrigerant circuit.
-Some drier in the field are not in conformity with R407C refrigerant .

[1] Service tools

Use the below service tools as exclusive tools for R407C refrigerant.

No.	Tool name	Specifications
①	Gauge manifold	·Only for R407C.
		·Use the existing fitting SPECIFICATIONS. (UNF7/16)
		·Use high-tension side pressure of 3.43MPa·G or over.
②	Charge hose	·Only for R407C.
		·Use pressure performance of 5.10MPa·G or over.
③	Electronic scale	
④	Gas leak detector	·Use the detector for R407C.
⑤	Adapter for reverse flow check.	·Attach on vacuum pump.
⑥	Refrigerant charge base.	
⑦	Refrigerant cylinder.	·For R407C ·Top of cylinder (Brown)
		·Cylinder with syphon
⑧	Refrigerant recovery equipment.	

[2] Notice on repair service

- After recovering the all refrigerant in the unit, proceed to working.
- Do not release refrigerant in the air.
- After completing the repair service, recharge the cycle with the specified amount of liquid refrigerant.

[3] Refrigerant recharging

(1) Refrigerant recharging process

- ① Direct charging from the cylinder.
- R407C cylinder are available on the market has a syphon pipe.
 - Leave the syphon pipe cylinder standing and recharge it.
(By liquid refrigerant)

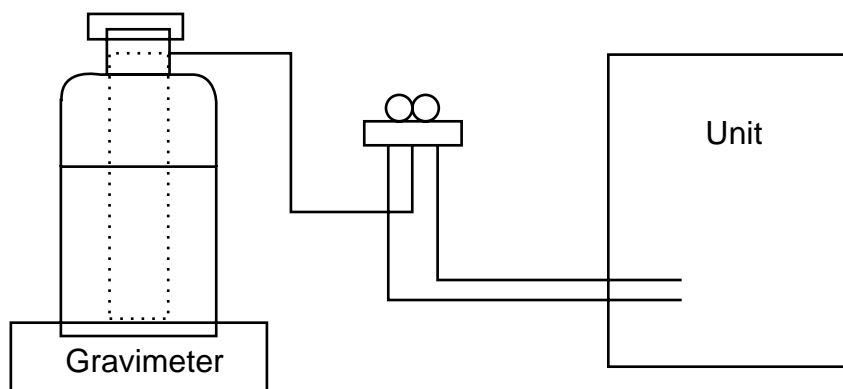

(2) Recharge in refrigerant leakage case

- After recovering the all refrigerant in the unit, proceed to working.
- Do not release the refrigerant in the air.
- After completing the repair service, recharge the cycle with the specified amount of liquid refrigerant.

● Indoor (Main) Unit

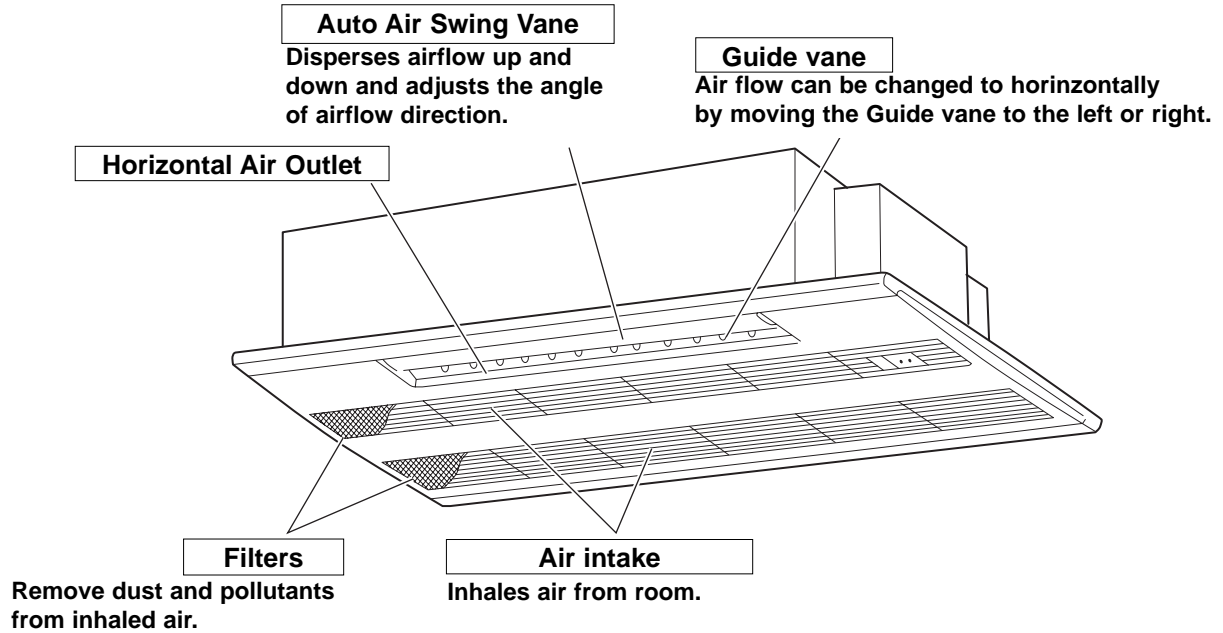
PMH-P1BA, PMH-P1BA₁PMH-P1.6BA, PMH-P1.6BA₁PMH-P2BA, PMH-P2BA₁

**PMH-P1BA
PMH-P1.6BA
PMH-P2BA**

● Remote controller

● Once the controls are set, the same operation mode can be repeated by simply pressing the ON/OFF button.

● Operation buttons

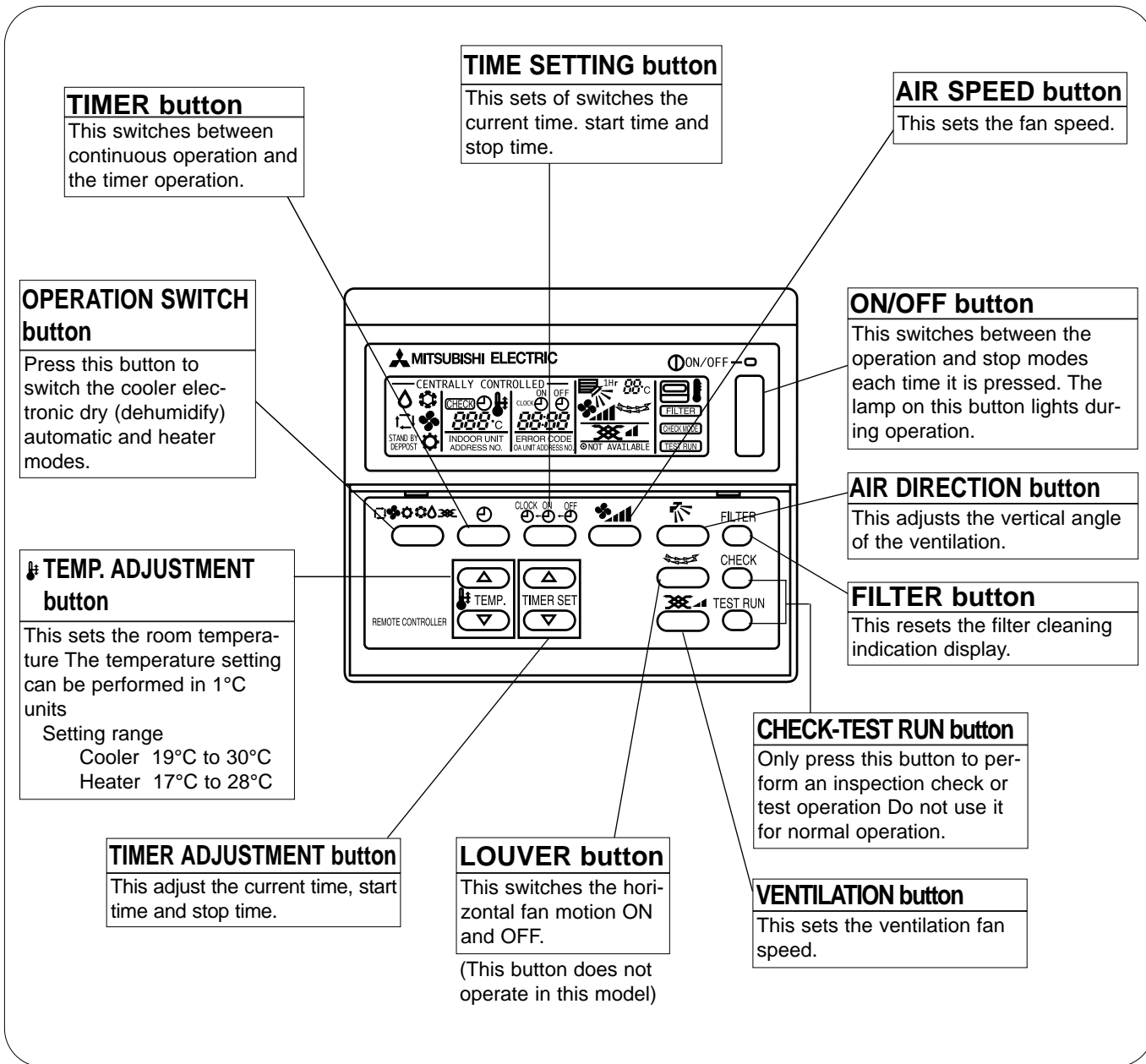

● Display

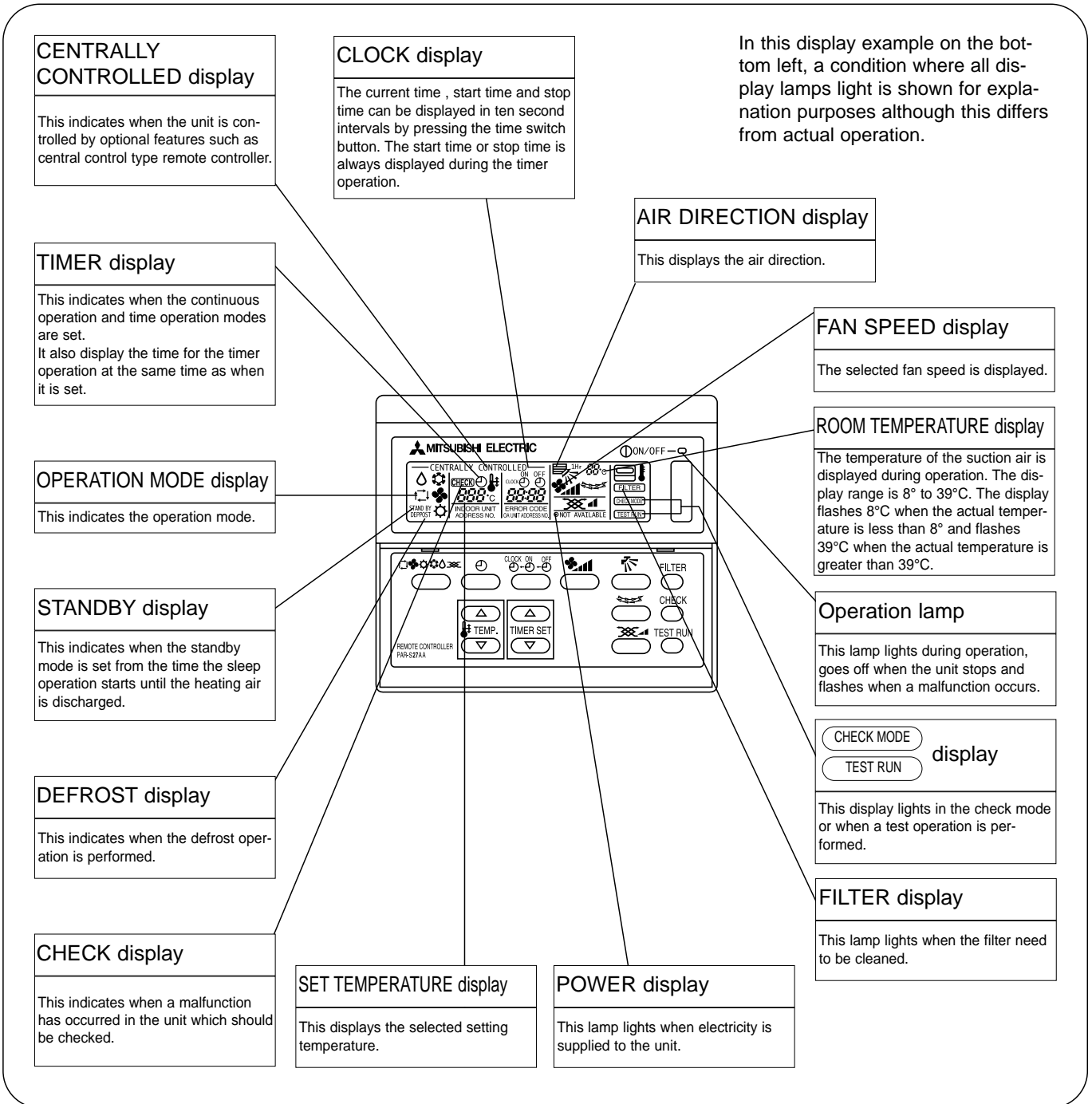

Caution

- Only the Power display lights when the unit is stopped and power supplied to the unit.
- When power is turned ON for the first time the (CENTRAL CTRL) display appears to go off momentarily but this is not a malfunction.
- When the central control remote control unit, which is sold separately, is used the ON-OFF button, operation switch button and  TEMP. adjustment button do not operate.
- "NOT AVAILABLE" is displayed when the Air speed button are pressed. This indicates that this room unit is not equipped with the fan direction adjustment function and the louver function.
- When power is turned ON for the first time, it is normal that "H0" is displayed on the room temperature indication (For max. 2minutes). Please wait until this "H0" indication disappear then start the operation.

PMH-P1BA₁
PMH-P1.6BA₁
PMH-P2BA₁

● **Remote controller**

- Once the controls are set, the same operation mode can be repeated by simply pressing the ON/OFF button.

● **Operation buttons**

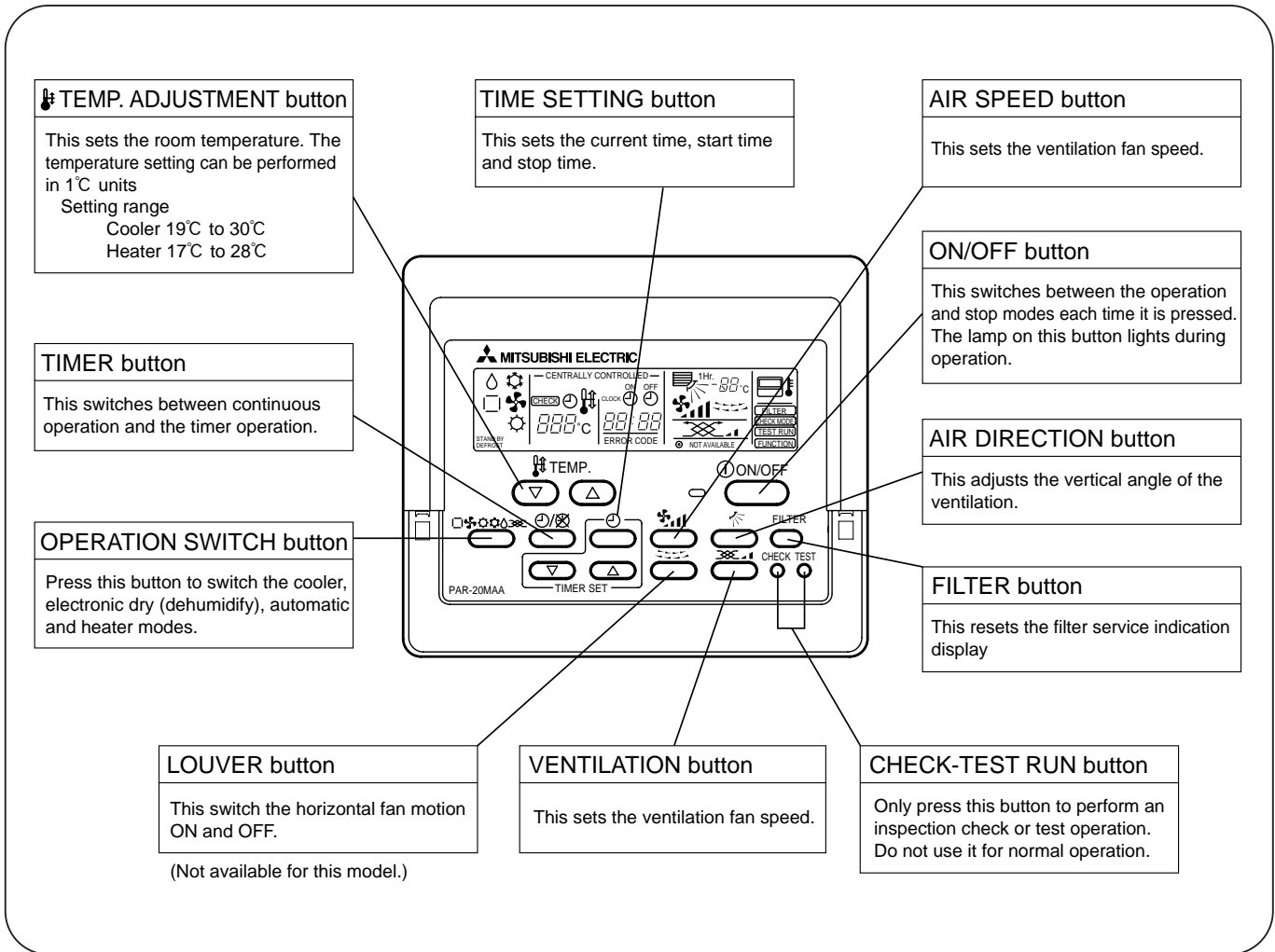

● Display

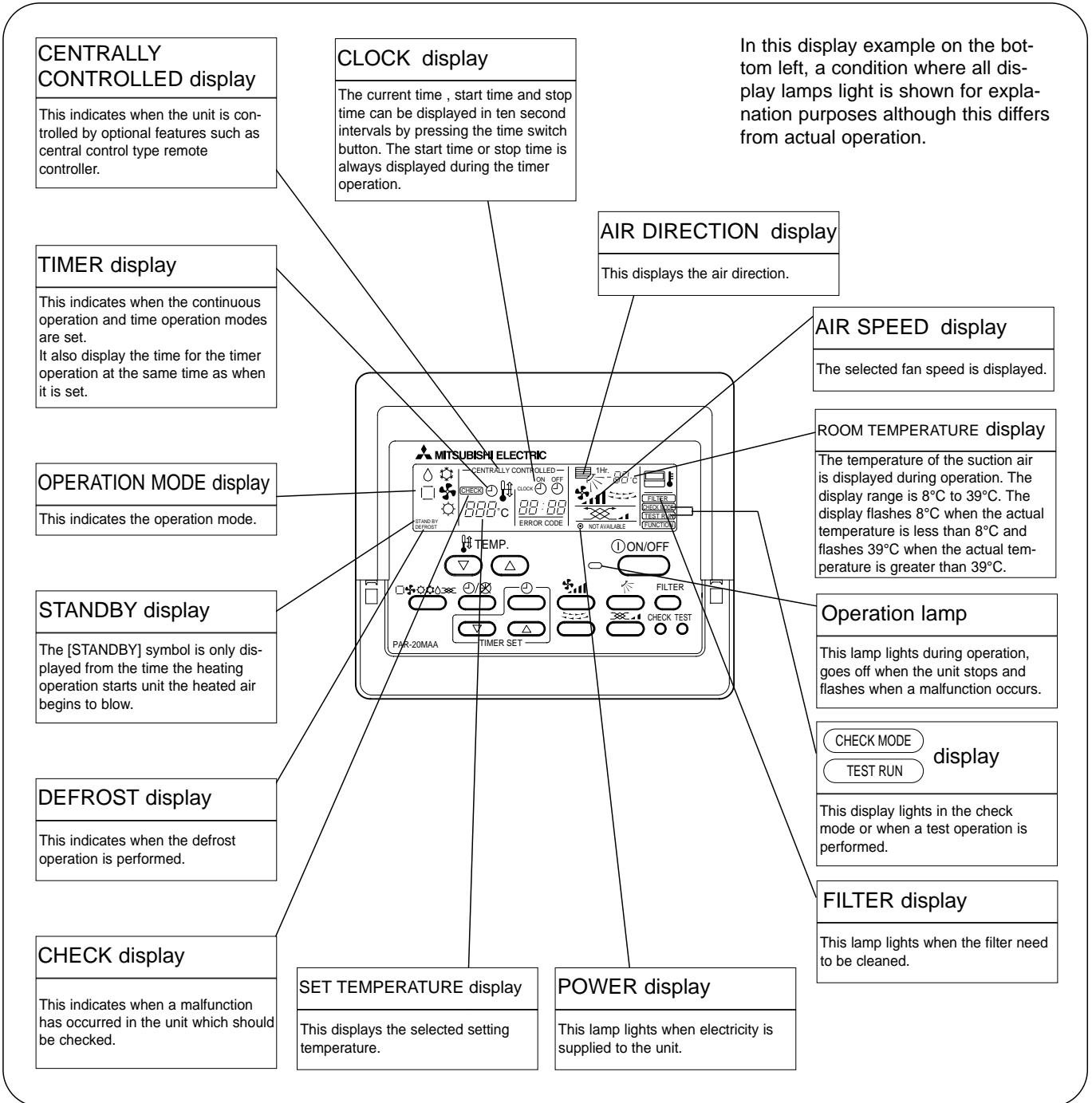

Caution

- Only the Power display lights when the unit is stopped and power supplied to the unit.
- When the central control remote control unit, which is sold separately, is used the ON-OFF button, operation switch button and  TEMP. adjustment button do not operate.
- “NOT AVAILABLE” is displayed when the Air speed button are pressed. This indicates that this room unit is not equipped with the fan direction adjustment function and the louver function.
- When power is turned ON for the first time, it is normal that “H0” is displayed on the room temperature indication (For max. 2minutes). Please wait until this “H0” indication disappear then start the operation.

5-1. SPECIFICATIONS

Item		Service Ref.	PMH-P1.6BA			
Function			Cooling		Heating	
Capacity		Btu/h	15,000		17,100	
		W	4,400		5,000	
Total input		kW	1.65		1.70	
Service Ref.			PMH-P1.6BA			
Power supply(phase, cycle, voltage)			Single Phase, 50Hz, 220-230-240V			
Input		kW	0.06		0.06	
Running current		A	0.29		0.29	
Starting current		A	0.32		0.32	
External finish			Unit : Galvanized sheets with gray heat insulation, Grille munsell 0.98Y 8.99/0.63			
Heat exchanger			Plate fin coil			
INDOOR UNIT	Fan		Lineflow fan (direct) x 1			
	Fan(drive) x No.					
	Fan motor output		kW		0.028	
	Airflow(Lo - Mi2- Mi1 - Hi)		m ³ /min(CFM)		7.0-8.0-9.0-10.0(247-282-318-353)	
	External static pressure		Pa(mmAq)		0(direct blow)	
Operation control & Thermostat			Remote controller & built-in			
Noise level(Lo - Mi2 - Mi1 - Hi)		dB		34-36-38-40		
Unit drain pipe I.D.		mm(in.)		26(1)		
Dimensions		W	mm(in.)		UNIT : 854(33-5/8) PANEL : 1000(39-3/8)	
		D	mm(in.)		UNIT : 395(15-9/16) PANEL : 470(18-1/2)	
		H	mm(in.)		UNIT : 230(9-1/16) PANEL : 30(1-3/16)	
Weight		kg(lbs)		UNIT : 14(31) PANEL : 3.0(6.6)		
Service Ref.			PUH-P1.6VGA	PUH-P1.6YGA	PUH-P1.6VGA	PUH-P1.6YGA
Power supply (phase, cycle, voltage)			Single Phase, 50Hz, 220-230-240V	3 phase, 50Hz, 380-400-415V(4wires)	Single Phase, 50Hz, 220-230-240V	3 phase, 50Hz, 380-400-415V(4wires)
Running current		A	7.66		2.67	
Starting current		A	36		20	
External finish			Munsell 5Y 8/1			
Refrigerant control			Linear Expansion Valve			
Compressor			Hermetic			
Model			RE277VHSM		RE277YFKM	
Motor output		kW		1.3		
Starter type		Line start				
Protection devices			*1		*2	
Crankcase heater		W		28		
Heat exchanger			Plate fin coil			
OUTDOOR UNIT	Fan		Propeller (direct) x 1			
	Fan(drive) x No.					
	Fan motor output		kW		0.070	
Airflow		m ³ /min(CFM)		45(1,590)		
Defrost method		Reverse cycle				
Noise level		Cooling	dB		46	
		Heating	dB		48	
Dimensions		W	mm(in.)		900(35-7/16)	
		D	mm(in.)		330+20(13+3/4)	
		H	mm(in.)		650(25-5/8)	
Weight		kg(lbs)		55(121)		
Refrigerant		R407C				
Charge		kg(lbs)		2.6(5.7)		
Oil (Model)		L 1.2(Ester)MEL56				
Pipe size O.D.		Liquid	mm(in.)		9.52(3/8)	
		Gas	mm(in.)		15.88(5/8)	
Connection method		Indoor side		Flared		
		Outdoor side		Flared		
Between the indoor & outdoor unit		Height difference		Max. 40m		
		Piping length		Max. 40m		

Notes1. Rating Conditions (ISO T1)

Cooling---Indoor : D.B. 27°C(80°F), W.B. 19°C (66°F)

Outdoor : D.B. 35°C(95°F), W.B. 24°C (75°F)

Heating---Indoor : D.B. 20°C(68°F)

Outdoor : D.B. 7°C(45°F), W.B. 6°C (43°F)

Refrigerant piping length (one way) : 5m (16ft)

2. Guaranteed operating range

		Indoor		Outdoor	
Cooling	Upper limit	D.B. 35°C	W.B. 22.5°C	D.B. 46°C	
	Lower limit	D.B. 19°C	W.B. 15°C	D.B. -5°C	
Heating	Upper limit	D.B. 28°C		D.B. 24°C W.B. 18°C	
	Lower limit	D.B. 17°C		D.B. -11°C W.B. -12°C	

3. Above data based on indicated voltage

Indoor Unit Single phase 240V 50Hz
Outdoor Unit Single phase 240V 50Hz
3 phase 415V 50Hz

*1: Inner thermostat, HP switch, Discharge thermo.

*2: Thermal relay, Discharge thermo, HP switch, Anti-phase protector.

Item		Service Ref.	PMH-P2BA				
Function			Cooling		Heating		
Capacity		Btu/h	18,400		21,300		
		W	5,400		6,250		
Total input		kW	2.35		2.42		
Service Ref.			PMH-P2BA				
Power supply(phase, cycle, voltage)			Single Phase, 50Hz, 220-230-240V				
Input		kW	0.06		0.06		
Running current		A	0.29		0.29		
Starting current		A	0.32		0.32		
INDOOR UNIT	External finish		Unit : Galvanized sheets with gray heat insulation, Grille munsell 0.98Y 8.99/0.63				
	Heat exchanger		Plate fin coil				
	Fan	Fan(drive) x No.		Lineflow fan (direct) x 1			
		Fan motor output		0.028			
		Airflow(Lo - Mi2 - Mi1 - Hi)		m³/min(CFM) 8.0-9.0-10.0-11.0(282-318-353-388)			
		External static pressure		Pa(mmAq) 0(direct blow)			
	Operation control & Thermostat		Remote controller & built-in				
	Noise level(Lo - Mi2 - Mi1 - Hi)		dB 36-38-40-42				
	Unit drain pipe I.D.		mm(in.) 26(1)				
	Dimensions		W	mm(in.)		UNIT : 854(33-5/8) PANEL : 1000(39-3/8)	
D			mm(in.)		UNIT : 395(15-9/16) PANEL : 470(18-1/2)		
H			mm(in.)		UNIT : 230(9-1/16) PANEL : 30(1-3/16)		
Weight		kg(lbs)	UNIT : 14(31)		PANEL : 3.0(6.6)		
Service Ref.			PUH-P2VGA	PUH-P2YGA	PUH-P2VGA	PUH-P2YGA	
Power supply (phase, cycle, voltage)			Single Phase, 50Hz, 220-230-240V	3 phase, 50Hz, 380-400-415V(4wires)	Single Phase, 50Hz, 220-230-240V	3 phase, 50Hz, 380-400-415V(4wires)	
Running current		A	11.11	3.88	11.51	4.02	
Starting current		A	74		30		
External finish			Munsell 5Y 8/1				
Refrigerant control			Linear Expansion Valve				
Compressor			Hermetic				
Model			NE38VMJM		NE38YEJM		
Motor output		kW	1.7				
Starter type			Line start				
Protection devices			*1		*2		
Crankcase heater		W	35				
Heat exchanger			Plate fin coil				
FAN	Fan(drive) x No.		Propeller (direct) x 1				
	Fan motor output		0.070				
	Airflow		m³/min(CFM) 55(1,940)				
Defrost method			Reverse cycle				
Noise level		Cooling	dB 48				
		Heating	dB 49				
Dimensions		W	mm(in.) 900(35-7/16)				
		D	mm(in.) 330+20(13+3/4)				
		H	mm(in.) 855(33-5/8)				
Weight		kg(lbs)	71(157)				
REFRIGERANT PIPING	Refrigerant		R407C				
	Charge		kg(lbs) 3.1(6.8)				
	Oil (Model)		L 1.2(Ester)MEL56				
	Pipe size O.D.		Liquid	mm(in.) 9.52(3/8)			
			Gas	mm(in.) 15.88(5/8)			
	Connection method		Indoor side	Flared			
			Outdoor side	Flared			
Between the indoor & outdoor unit		Height difference	Max. 40m				
		Piping length	Max. 40m				

Notes1. Rating Conditions (ISO T1)

Cooling....Indoor : D.B. 27°C(80°F), W.B. 19°C (66°F)

Heating....Indoor : D.B. 20°C(68°F)

Refrigerant piping length (one way) : 5m (16ft)

Outdoor : D.B. 35°C(95°F), W.B. 24°C (75°F)

Outdoor : D.B. 7°C(45°F), W.B. 6°C (43°F)

2. Guaranteed operating range

		Indoor		Outdoor	
Cooling	Upper limit	D.B. 35°C	W.B. 22.5°C	D.B. 46°C	
	Lower limit	D.B. 19°C	W.B. 15°C	D.B. -5°C	
Heating	Upper limit	D.B. 28°C		D.B. 24°C W.B. 18°C	
	Lower limit	D.B. 17°C		D.B. -11°C W.B. -12°C	

3. Above data based on indicated voltage
Indoor Unit Single phase 240V 50Hz
Outdoor Unit Single phase 240V 50Hz
3 phase 415V 50Hz

*1: Inner thermostat, HP switch, Discharge thermo.

*2: Thermal relay, Discharge thermo, HP switch, Anti-phase protector.



Item		Service Ref.	PMH-P1BA / PMH-P1BA ₁		
Function			Cooling	Heating	
Capacity		Btu/h	10,700	11,600	
		W	3,150	3,400	
Total input		kW	1.15	1.06	
Service Ref.			PMH-P1BA / PMH-P1BA₁		
Power supply(phase, cycle, voltage)			Single Phase, 50Hz, 220-230-240V		
INDOOR UNIT	Input	kW	0.04	0.04	
	Running current	A	0.19	0.19	
	Starting current	A	0.21	0.21	
External finish			Unit : Galvanized sheets with gray heat insulation, Grille munsell 0.98Y 8.99/0.63		
Heat exchanger			Plate fin coil		
INDOOR UNIT	Fan	Fan(drive) x No.	Lineflow fan (direct) x 1		
		Fan motor output	kW	0.028	
	Airflow(Lo - Mi2 - Mi1 - Hi)	m ³ /min(CFM)	6.3-6.8-7.6-8.4(222-240-268-297)		
	External static pressure	Pa(mmAq)	0(direct blow)		
Operation control & Thermostat			Remote controller & built-in		
Noise level(Lo - Mi2 - Mi1 - Hi)		dB	29-31-33-35		
Unit drain pipe I.D.		mm(in.)	26(1)		
INDOOR UNIT	Dimensions	W	UNIT : 854(33-5/8) PANEL : 1000(39-3/8)		
		D	UNIT : 395(15-9/16) PANEL : 470(18-1/2)		
		H	UNIT : 230(9-1/16) PANEL : 30(1-3/16)		
Weight		kg(lbs)	UNIT : 14(31) PANEL : 3.0(6.6)		
Service Ref.			PUH-P1VGAA.UK		
Power supply (phase, cycle, voltage)			Single Phase, 50Hz, 220-230-240V		
OUTDOOR UNIT	Running current	A	4.92	4.52	
	Starting current	A	30		
	External finish			Munsell 5Y 7/1	
Refrigerant control			Linear Expansion Valve		
Compressor			Hermetic		
OUTDOOR UNIT	Model		RE189VHSMT		
	Motor output	kW	0.85		
	Starter type		Line start		
	Protection devices		Inner thermostat, HP switch, Discharge thermo.		
	Crackcase heater	W	30		
Heat exchanger			Plate fin coil		
OUTDOOR UNIT	Fan	Fan(drive) x No.	Propeller (direct) x 1		
		Fan motor output	kW	0.070	
		Airflow	m ³ /min(CFM)	45(1,590)	
Defrost method			Reverse cycle		
OUTDOOR UNIT	Noise level	Cooling	dB 46		
		Heating	dB 48		
OUTDOOR UNIT	Dimensions	W	900(35-7/16)		
		D	330+20(13+3/4)		
		H	650(25-5/8)		
Weight		kg(lbs)	50(110)		
REFRIGERANT PIPING	Refrigerant		R407C		
	Charge		kg(lbs) 1.7(3.7)		
	Oil (Model)		L 0.57(Ester)MEL56		
	Pipe size O.D.	Liquid	mm(in.)	6.35(1/4)	
		Gas	mm(in.)	12.7(1/2)	
	Connection method		Indoor side	Flared	
		Outdoor side	Flared		
Between the indoor & outdoor unit	Height difference		Max. 30m		
	Piping length		Max. 30m		

Notes1. Rating Conditions (ISO T1)

Cooling---Indoor : D.B. 27°C(80°F), W.B. 19°C (66°F)

Heating---Indoor : D.B. 20°C(68°F)

Refrigerant piping length (one way) : 5m (16ft)

Outdoor : D.B. 35°C(95°F), W.B. 24°C (75°F)

Outdoor : D.B. 7°C(45°F), W.B. 6°C (43°F)

2. Guaranteed operating range

		Indoor		Outdoor
Cooling	Upper limit	D.B. 35°C	W.B. 22.5°C	D.B. 46°C
	Lower limit	D.B. 19°C	W.B. 15°C	D.B. -5°C
Heating	Upper limit	D.B. 28°C		D.B. 24°C W.B. 18°C
	Lower limit	D.B. 17°C		D.B. -11°C W.B. -12°C

3. Above data based on indicated voltage

Indoor Unit Single phase 240V 50Hz
Outdoor Unit Single phase 240V 50Hz

Item		Service Ref.	PMH-P1.6BA / PMH-P1.6BA ₁				
Function			Cooling		Heating		
Capacity		Btu/h	15,000		17,100		
		W	4,400		5,000		
Total input		kW	1.65		1.70		
Service Ref.			PMH-P1.6BA / PMH-P1.6BA₁				
Power supply(phase, cycle, voltage)			Single Phase, 50Hz, 220-230-240V				
Input		kW	0.06		0.06		
Running current		A	0.29		0.29		
Starting current		A	0.32		0.32		
INDOOR UNIT	External finish		Unit : Galvanized sheets with gray heat insulation, Grille munsell 0.98Y 8.99/0.63				
	Heat exchanger		Plate fin coil				
	Fan	Fan(drive) x No.		Lineflow fan (direct) x 1			
		Fan motor output		0.028			
		Airflow(Lo - Mi2- Mi1 - Hi)		m ³ /min(CFM)			
		External static pressure		Pa(mmAq)			
	Operation control & Thermostat		Remote controller & built-in				
	Noise level(Lo - Mi2 - Mi1 - Hi)		dB				
	Unit drain pipe I.D.		mm(in.)				
	Dimensions		W	mm(in.)		UNIT : 854(33-5/8) PANEL : 1000(39-3/8)	
D			mm(in.)		UNIT : 395(15-9/16) PANEL : 470(18-1/2)		
H			mm(in.)		UNIT : 230(9-1/16) PANEL : 30(1-3/16)		
Weight		kg(lbs)	UNIT : 14(31)		PANEL : 3.0(6.6)		
Service Ref.			PUH-P1.6VGAA.UK	PUH-P1.6YGAA.UK	PUH-P1.6VGAA.UK	PUH-P1.6YGAA.UK	
Power supply (phase, cycle, voltage)			Single Phase, 50Hz, 220-230-240V	3 phase, 50Hz, 380-400-415V(4wires)	Single Phase, 50Hz, 220-230-240V	3 phase, 50Hz, 380-400-415V(4wires)	
Running current		A	7.36	2.49	7.59	2.56	
Starting current		A	36		20		
External finish			Munsell 5Y 7/1				
Refrigerant control			Linear Expansion Valve				
Compressor			Hermetic				
Model			RE277VHSMT		RE277YFKM		
Motor output		kW	1.3				
Starter type			Line start				
Protection devices			*1		*2		
Crankcase heater		W	30				
Heat exchanger			Plate fin coil				
FAN	Fan(drive) x No.		Propeller (direct) x 1				
	Fan motor output		0.070				
	Airflow		m ³ /min(CFM)				
Defrost method			Reverse cycle				
Noise level		Cooling	dB				
		Heating	dB				
Dimensions		W	mm(in.)				
		D	mm(in.)				
		H	mm(in.)				
Weight		kg(lbs)	54(119)				
REFRIGERANT PIPING	Refrigerant		R407C				
	Charge		kg(lbs)				
	Oil (Model)		L				
	Pipe size O.D.		Liquid	mm(in.)			
			Gas	mm(in.)			
	Connection method		Indoor side	Flared			
			Outdoor side	Flared			
Between the indoor & outdoor unit		Height difference	Max. 40m				
		Piping length	Max. 40m				

Notes1. Rating Conditions (ISO T1)

Cooling....Indoor : D.B. 27°C(80°F), W.B. 19°C (66°F)

Heating....Indoor : D.B. 20°C(68°F)

Refrigerant piping length (one way) : 5m (16ft)

Outdoor : D.B. 35°C(95°F), W.B. 24°C (75°F)

Outdoor : D.B. 7°C(45°F), W.B. 6°C (43°F)

2. Guaranteed operating range

		Indoor		Outdoor	
Cooling	Upper limit	D.B. 35°C	W.B. 22.5°C	D.B. 46°C	
	Lower limit	D.B. 19°C	W.B. 15°C	D.B. -5°C	
Heating	Upper limit	D.B. 28°C		D.B. 24°C W.B. 18°C	
	Lower limit	D.B. 17°C		D.B. -11°C W.B. -12°C	

3. Above data based on indicated voltage

Indoor Unit Single phase 240V 50Hz
Outdoor Unit Single phase 240V 50Hz
3 phase 415V 50Hz

*1: Inner thermostat, HP switch, Discharge thermo.

*2: Thermal relay, Discharge thermo, HP switch, Anti-phase protector.



Item		Service Ref.	PMH-P2BA / PMH-P2BA ₁			
Function			Cooling		Heating	
Capacity		Btu/h	18,400		21,450	
		W	5,400		6,250	
Total input		kW	2.35		2.42	
Service Ref.			PMH-P2BA / PMH-P2BA₁			
Power supply(phase, cycle, voltage)			SinglePhase, 50Hz, 220-230-240V			
Input		kW	0.06		0.06	
Running current		A	0.29		0.29	
Starting current		A	0.32		0.32	
External finish			Unit : Galvanized sheets with gray heat insulation, Grille munsell 0.98Y 8.99/0.63			
Heat exchanger			Plate fin coil			
INDOOR UNIT	Fan	Fan(drive) x No.	Lineflow fan (direct) x 1			
		Fan motor output	kW			
	Airflow(Lo - Mi2 - Mi1 - Hi)	m ³ /min(CFM)				
	External static pressure	Pa(mmAq)				
	Operation control & Thermostat	Remote controller & built-in				
Noise level(Lo - Mi2 - Mi1 - Hi)		dB		36-38-40-42		
Unit drain pipe I.D.		mm(in.)		26(1)		
Dimensions		W	mm(in.)		UNIT : 854(33-5/8) PANEL : 1000(39-3/8)	
		D	mm(in.)		UNIT : 395(15-9/16) PANEL : 470(18-1/2)	
		H	mm(in.)		UNIT : 230(9-1/16) PANEL : 30(1-3/16)	
Weight		kg(lbs)		UNIT : 14(31) PANEL : 3.0(6.6)		
Service Ref.			PUH-P2VGAA.UK	PUH-P2YGAA.UK	PUH-P2VGAA.UK	PUH-P2YGAA.UK
Power supply (phase, cycle, voltage)			Single Phase, 50Hz, 220-230-240V	3 phase, 50Hz, 380-400-415V(4wires)	Single Phase, 50Hz, 220-230-240V	3 phase, 50Hz, 380-400-415V(4wires)
Running current		A	10.26	3.70	10.57	3.82
Starting current		A	62		31	
External finish			Munsell 5Y 7/1			
Refrigerant control			Linear Expansion Valve			
Compressor			Hermetic			
Model			NE36VMJMT		NE38YEJM	
Motor output		kW		1.6		
Starter type		Line start				
Protection devices			*1		*2	
Crankcase heater		W		38		
Heat exchanger			Plate fin coil			
OUTDOOR UNIT	Fan	Fan(drive) x No.	Propeller (direct) x 1			
		Fan motor output	kW			
	Airflow	m ³ /min(CFM)				
Defrost method		Reverse cycle				
Noise level		Cooling	dB		48	
		Heating	dB		50	
Dimensions		W	mm(in.)		900(35-7/16)	
		D	mm(in.)		330+20(13+3/4)	
		H	mm(in.)		855(33-5/8)	
Weight		kg(lbs)		74(163)		
Refrigerant		R407C				
Charge		kg(lbs)		2.6(5.7)		
Oil (Model)		L				
Pipe size O.D.		Liquid	mm(in.)		9.52(3/8)	
		Gas	mm(in.)		15.88(5/8)	
Connection method		Indoor side	Flared			
		Outdoor side	Flared			
Between the indoor & outdoor unit		Height difference	Max. 40m			
		Piping length	Max. 40m			

Notes1. Rating Conditions (ISO T1)

Cooling---Indoor : D.B. 27°C(80°F), W.B. 19°C (66°F) Outdoor : D.B. 35°C(95°F), W.B. 24°C (75°F)
 Heating---Indoor : D.B. 20°C(68°F) Outdoor : D.B. 7°C(45°F), W.B. 6°C (43°F)
 Refrigerant piping length (one way) : 5m (16ft)

2. Guaranteed operating range

		Indoor		Outdoor	
Cooling	Upper limit	D.B. 35°C	W.B. 22.5°C	D.B. 46°C	
	Lower limit	D.B. 19°C	W.B. 15°C	D.B. -5°C	
Heating	Upper limit	D.B. 28°C		D.B. 24°C W.B. 18°C	
	Lower limit	D.B. 17°C		D.B. -11°C W.B. -12°C	

3. Above data based on indicated voltage
 Indoor Unit Single phase 240V 50Hz
 Outdoor Unit Single phase 240V 50Hz
 3 phase 415V 50Hz

*1: Inner thermostat, HP switch, Discharge thermo.

*2: Thermal relay, Discharge thermo, HP switch, Anti-phase protector.

5-2. Air capacity taken from outside

PMH-P-BA series are possible to be taken air from outside.
 When taking air from the outside, the duct fan can be used to.
 The air capacity should be 20% or less of the air flow SPEC(Hi).

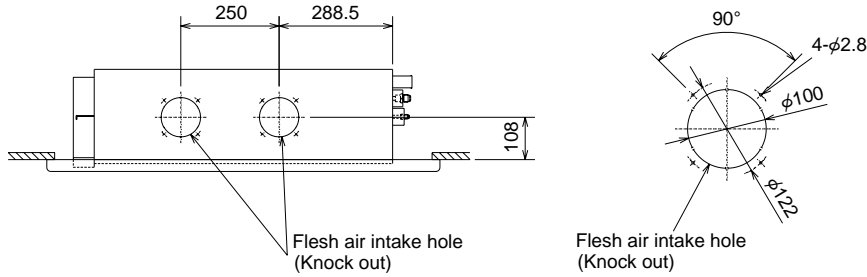

	Air flow (Hi)	Air capacity taken outside
PMH-P1BA, PMH-P1BA1	8.4m ³ /min	1.6m ³ /min
PMH-P1.6BA, PMH-P1.6BA1	10.0m ³ /min	2.0m ³ /min
PMH-P2BA, PMH-P2BA1	11.0m ³ /min	2.2m ³ /min

How to read curves

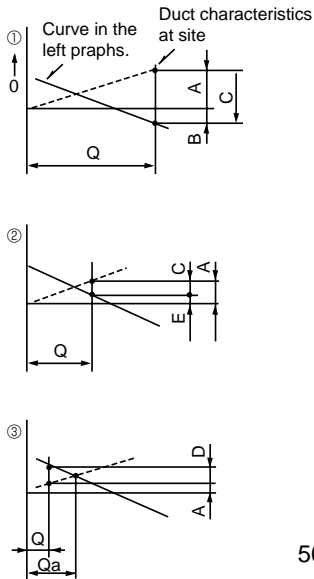

Q...Planned amount of fresh air intake <m³/min>

A...Static pressure loss of fresh air intake duct system with air flow amount Q <Pa>

B...Forced static pressure at air conditioner inlet with air flow amount Q <Pa>

C...Static pressure of booster fan with air flow amount Q <Pa>

D...Static pressure loss increase amount of fresh air intake duct system for air flow amount Q <Pa>

E...Static pressure of indoor unit with air flow amount Q <Pa>

Qa...Estimated amount of fresh air intake without D <m³/min>

Characteristic diagram of air capacity taken from outside

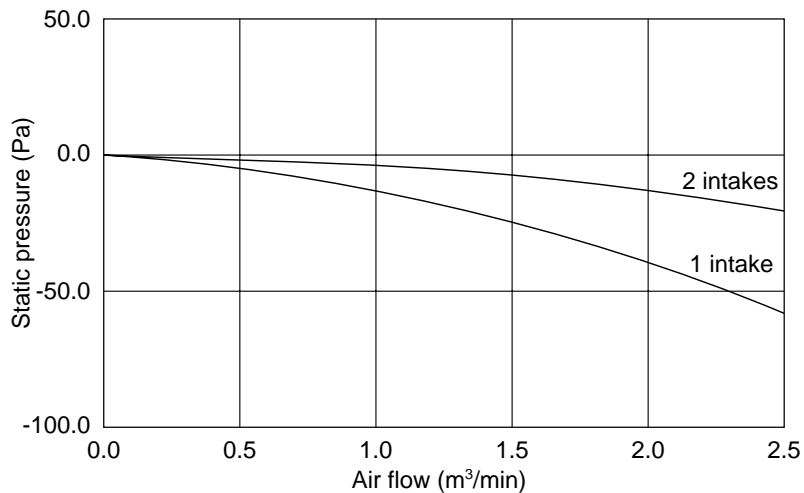

6-1. PERFORMANCE DATA

1) COOLING CAPACITY(1)
PMH-P1BA, PMH-P1BA₁

Indoor Intake air D.B.(°C)	Indoor Intake air W.B.(°C)	Outdoor intake air D.B.(°C)											
		20				25				30			
		CA	SHC(W)	SHF	P.C.	CA	SHC(W)	SHF	P.C.	CA	SHC(W)	SHF	P.C.
20	16	3,119	2,089	0.67	0.92	3,024	2,026	0.67	0.97	2,930	1,963	0.67	1.03
20	18	3,339	1,836	0.55	0.94	3,245	1,784	0.55	0.99	3,134	1,724	0.55	1.06
20	20	3,591	1,544	0.43	0.97	3,512	1,510	0.43	1.01	3,418	1,470	0.43	1.08
22	16	3,119	2,339	0.75	0.92	3,024	2,268	0.75	0.97	2,930	2,197	0.75	1.03
22	18	3,339	2,104	0.63	0.94	3,245	2,044	0.63	0.99	3,134	1,975	0.63	1.06
22	20	3,591	1,831	0.51	0.97	3,512	1,791	0.51	1.01	3,418	1,743	0.51	1.08
24	16	3,119	2,588	0.83	0.92	3,024	2,510	0.83	0.97	2,930	2,431	0.83	1.03
24	18	3,339	2,371	0.71	0.94	3,245	2,304	0.71	0.99	3,134	2,225	0.71	1.06
24	20	3,591	2,119	0.59	0.97	3,512	2,072	0.59	1.01	3,418	2,016	0.59	1.08
24	22	3,827	1,799	0.47	0.99	3,749	1,762	0.47	1.05	3,654	1,717	0.47	1.12
26	16	3,119	2,838	0.91	0.92	3,024	2,752	0.91	0.97	2,930	2,666	0.91	1.03
26	18	3,339	2,638	0.79	0.94	3,245	2,563	0.79	0.99	3,134	2,476	0.79	1.06
26	20	3,591	2,406	0.67	0.97	3,512	2,353	0.67	1.01	3,418	2,290	0.67	1.08
26	22	3,827	2,105	0.55	0.99	3,749	2,062	0.55	1.05	3,654	2,010	0.55	1.12
28	16	3,119	3,087	0.99	0.92	3,024	2,994	0.99	0.97	2,930	2,900	0.99	1.03
28	18	3,339	2,905	0.87	0.94	3,245	2,823	0.87	0.99	3,134	2,727	0.87	1.06
28	20	3,591	2,693	0.75	0.97	3,512	2,634	0.75	1.01	3,418	2,563	0.75	1.08
28	22	3,827	2,411	0.63	0.99	3,749	2,362	0.63	1.05	3,654	2,302	0.63	1.12
30	16	3,119	3,119	1.00	0.92	3,024	3,024	1.00	0.97	2,930	2,930	1.00	1.03
30	18	3,339	3,172	0.95	0.94	3,245	3,082	0.95	0.99	3,134	2,978	0.95	1.06
30	20	3,591	2,981	0.83	0.97	3,512	2,915	0.83	1.01	3,418	2,837	0.83	1.08
30	22	3,827	2,717	0.71	0.99	3,749	2,661	0.71	1.05	3,654	2,594	0.71	1.12
32	16	3,119	3,119	1.00	0.92	3,024	3,024	1.00	0.97	2,930	2,930	1.00	1.03
32	18	3,339	3,339	1.00	0.94	3,245	3,245	1.00	0.99	3,134	3,134	1.00	1.06
32	20	3,591	3,268	0.91	0.97	3,512	3,196	0.91	1.01	3,418	3,110	0.91	1.08
32	22	3,827	3,024	0.79	0.99	3,749	2,961	0.79	1.05	3,654	2,887	0.79	1.12
34	16	3,119	3,119	1.00	0.92	3,024	3,024	1.00	0.97	2,930	2,930	1.00	1.03
34	18	3,339	3,339	1.00	0.94	3,245	3,245	1.00	0.99	3,134	3,134	1.00	1.06
34	20	3,591	3,555	0.99	0.97	3,512	3,477	0.99	1.01	3,418	3,384	0.99	1.08
34	22	3,827	3,330	0.87	0.99	3,749	3,261	0.87	1.05	3,654	3,179	0.87	1.12

Note CA : Capacity (W)

P.C. : Power consumption (kW)

SHC(W) : Sensible heat capacity

SHF : Sensible heat factor

Above data based on indicated voltage

Indoor unit : Single phase 240V 50Hz

Outdoor unit : Single phase 240V 50Hz

COOLING CAPACITY(2)
PMH-P1BA, PMH-P1BA:

Indoor Intake air D.B.(°C)	Indoor Intake air W.B.(°C)	Outdoor intake air D.B.(°C)											
		35				40				45			
		CA	SHC(W)	SHF	P.C.	CA	SHC(W)	SHF	P.C.	CA	SHC(W)	SHF	P.C.
20	16	2,804	1,878	0.67	1.10	2,678	1,794	0.67	1.18	2,552	1,710	0.67	1.28
20	18	3,024	1,663	0.55	1.13	2,930	1,611	0.55	1.22	2,741	1,507	0.55	1.31
20	20	3,276	1,409	0.43	1.16	3,150	1,355	0.43	1.24	2,961	1,273	0.43	1.33
22	16	2,804	2,103	0.75	1.10	2,678	2,008	0.75	1.18	2,552	1,914	0.75	1.28
22	18	3,024	1,905	0.63	1.13	2,930	1,846	0.63	1.22	2,741	1,727	0.63	1.31
22	20	3,276	1,671	0.51	1.16	3,150	1,607	0.51	1.24	2,961	1,510	0.51	1.33
24	16	2,804	2,327	0.83	1.10	2,678	2,222	0.83	1.18	2,552	2,118	0.83	1.28
24	18	3,024	2,147	0.71	1.13	2,930	2,080	0.71	1.22	2,741	1,946	0.71	1.31
24	20	3,276	1,933	0.59	1.16	3,150	1,859	0.59	1.24	2,961	1,747	0.59	1.33
24	22	3,528	1,658	0.47	1.18	3,402	1,599	0.47	1.28	3,213	1,510	0.47	1.36
26	16	2,804	2,551	0.91	1.10	2,678	2,437	0.91	1.18	2,552	2,322	0.91	1.28
26	18	3,024	2,389	0.79	1.13	2,930	2,314	0.79	1.22	2,741	2,165	0.79	1.31
26	20	3,276	2,195	0.67	1.16	3,150	2,111	0.67	1.24	2,961	1,984	0.67	1.33
26	22	3,528	1,940	0.55	1.18	3,402	1,871	0.55	1.28	3,213	1,767	0.55	1.36
28	16	2,804	2,775	0.99	1.10	2,678	2,651	0.99	1.18	2,552	2,526	0.99	1.28
28	18	3,024	2,631	0.87	1.13	2,930	2,549	0.87	1.22	2,741	2,384	0.87	1.31
28	20	3,276	2,457	0.75	1.16	3,150	2,363	0.75	1.24	2,961	2,221	0.75	1.33
28	22	3,528	2,223	0.63	1.18	3,402	2,143	0.63	1.28	3,213	2,024	0.63	1.36
30	16	2,804	2,804	1.00	1.10	2,678	2,678	1.00	1.18	2,552	2,552	1.00	1.28
30	18	3,024	2,837	0.95	1.13	2,930	2,783	0.95	1.22	2,741	2,603	0.95	1.31
30	20	3,276	2,719	0.83	1.16	3,150	2,615	0.83	1.24	2,961	2,458	0.83	1.33
30	22	3,528	2,505	0.71	1.18	3,402	2,415	0.71	1.28	3,213	2,281	0.71	1.36
32	16	2,804	2,804	1.00	1.10	2,678	2,678	1.00	1.18	2,552	2,552	1.00	1.28
32	18	3,024	3,024	1.00	1.13	2,930	2,930	1.00	1.22	2,741	2,741	1.00	1.31
32	20	3,276	2,981	0.91	1.16	3,150	2,867	0.91	1.24	2,961	2,695	0.91	1.33
32	22	3,528	2,787	0.79	1.18	3,402	2,688	0.79	1.28	3,213	2,538	0.79	1.36
34	16	2,804	2,804	1.00	1.10	2,678	2,678	1.00	1.18	2,552	2,552	1.00	1.28
34	18	3,024	3,024	1.00	1.13	2,930	2,930	1.00	1.22	2,741	2,741	1.00	1.31
34	20	3,276	3,243	0.99	1.16	3,150	3,119	0.99	1.24	2,961	2,931	0.99	1.33
34	22	3,528	3,069	0.87	1.18	3,402	2,960	0.87	1.28	3,213	2,795	0.87	1.36

Note CA : Capacity (W)

P.C. : Power consumption (kW)

SHC(W) : Sensible heat capacity

SHF : Sensible heat factor

Above data based on indicated voltage

Indoor unit : Single phase 240V 50Hz

Outdoor unit : Single phase 240V 50Hz

COOLING CAPACITY(3)
PMH-P1.6BA, PMH-P1.6BA,

Indoor Intake air D.B.(°C)	Indoor Intake air W.B.(°C)	Outdoor intake air D.B.(°C)											
		20				25				30			
		CA	SHC(W)	SHF	P.C.	CA	SHC(W)	SHF	P.C.	CA	SHC(W)	SHF	P.C.
20	16	4,356	2,614	0.60	1.32	4,224	2,534	0.60	1.39	4,092	2,455	0.60	1.48
20	18	4,664	2,239	0.48	1.34	4,532	2,175	0.48	1.42	4,378	2,101	0.48	1.52
20	20	5,016	1,806	0.36	1.39	4,906	1,766	0.36	1.45	4,774	1,719	0.36	1.55
22	16	4,356	2,962	0.68	1.32	4,224	2,872	0.68	1.39	4,092	2,783	0.68	1.48
22	18	4,664	2,612	0.56	1.34	4,532	2,538	0.56	1.42	4,378	2,452	0.56	1.52
22	20	5,016	2,207	0.44	1.39	4,906	2,159	0.44	1.45	4,774	2,101	0.44	1.55
24	16	4,356	3,311	0.76	1.32	4,224	3,210	0.76	1.39	4,092	3,110	0.76	1.48
24	18	4,664	2,985	0.64	1.34	4,532	2,900	0.64	1.42	4,378	2,802	0.64	1.52
24	20	5,016	2,608	0.52	1.39	4,906	2,551	0.52	1.45	4,774	2,482	0.52	1.55
24	22	5,346	2,138	0.40	1.42	5,236	2,094	0.40	1.50	5,104	2,042	0.40	1.60
26	16	4,356	3,659	0.84	1.32	4,224	3,548	0.84	1.39	4,092	3,437	0.84	1.48
26	18	4,664	3,358	0.72	1.34	4,532	3,263	0.72	1.42	4,378	3,152	0.72	1.52
26	20	5,016	3,010	0.60	1.39	4,906	2,944	0.60	1.45	4,774	2,864	0.60	1.55
26	22	5,346	2,566	0.48	1.42	5,236	2,513	0.48	1.50	5,104	2,450	0.48	1.60
28	16	4,356	4,008	0.92	1.32	4,224	3,886	0.92	1.39	4,092	3,765	0.92	1.48
28	18	4,664	3,731	0.80	1.34	4,532	3,626	0.80	1.42	4,378	3,502	0.80	1.52
28	20	5,016	3,411	0.68	1.39	4,906	3,336	0.68	1.45	4,774	3,246	0.68	1.55
28	22	5,346	2,994	0.56	1.42	5,236	2,932	0.56	1.50	5,104	2,858	0.56	1.60
30	16	4,356	4,356	1.00	1.32	4,224	4,224	1.00	1.39	4,092	4,092	1.00	1.48
30	18	4,664	4,104	0.88	1.34	4,532	3,988	0.88	1.42	4,378	3,853	0.88	1.52
30	20	5,016	3,812	0.76	1.39	4,906	3,729	0.76	1.45	4,774	3,628	0.76	1.55
30	22	5,346	3,421	0.64	1.42	5,236	3,351	0.64	1.50	5,104	3,267	0.64	1.60
32	16	4,356	4,356	1.00	1.32	4,224	4,224	1.00	1.39	4,092	4,092	1.00	1.48
32	18	4,664	4,477	0.96	1.34	4,532	4,351	0.96	1.42	4,378	4,203	0.96	1.52
32	20	5,016	4,213	0.84	1.39	4,906	4,121	0.84	1.45	4,774	4,010	0.84	1.55
32	22	5,346	3,849	0.72	1.42	5,236	3,770	0.72	1.50	5,104	3,675	0.72	1.60
34	16	4,356	4,356	1.00	1.32	4,224	4,224	1.00	1.39	4,092	4,092	1.00	1.48
34	18	4,664	4,664	1.00	1.34	4,532	4,532	1.00	1.42	4,378	4,378	1.00	1.52
34	20	5,016	4,615	0.92	1.39	4,906	4,514	0.92	1.45	4,774	4,392	0.92	1.55
34	22	5,346	4,277	0.80	1.42	5,236	4,189	0.80	1.50	5,104	4,083	0.80	1.60

Note CA : Capacity (W)
P.C. : Power consumption (kW)

SHC(W) : Sensible heat capacity
SHF : Sensible heat factor

Above data based on indicated voltage

Indoor unit : Single phase 240V 50Hz

Outdoor unit : Single phase 240V 50Hz / 3 phase 415V 50Hz

COOLING CAPACITY(4)
PMH-P1.6BA, PMH-P1.6BA₁

Indoor Intake air D.B.(°C)	Indoor Intake air W.B.(°C)	Outdoor intake air D.B.(°C)											
		35				40				45			
		CA	SHC(W)	SHF	P.C.	CA	SHC(W)	SHF	P.C.	CA	SHC(W)	SHF	P.C.
20	16	3,916	2,350	0.60	1.58	3,740	2,244	0.60	1.70	3,564	2,138	0.60	1.84
20	18	4,224	2,028	0.48	1.63	4,092	1,964	0.48	1.75	3,828	1,837	0.48	1.88
20	20	4,576	1,647	0.36	1.67	4,400	1,584	0.36	1.78	4,136	1,489	0.36	1.91
22	16	3,916	2,663	0.68	1.58	3,740	2,543	0.68	1.70	3,564	2,424	0.68	1.84
22	18	4,224	2,365	0.56	1.63	4,092	2,292	0.56	1.75	3,828	2,144	0.56	1.88
22	20	4,576	2,013	0.44	1.67	4,400	1,936	0.44	1.78	4,136	1,820	0.44	1.91
24	16	3,916	2,976	0.76	1.58	3,740	2,842	0.76	1.70	3,564	2,709	0.76	1.84
24	18	4,224	2,703	0.64	1.63	4,092	2,619	0.64	1.75	3,828	2,450	0.64	1.88
24	20	4,576	2,380	0.52	1.67	4,400	2,288	0.52	1.78	4,136	2,151	0.52	1.91
24	22	4,928	1,971	0.40	1.70	4,752	1,901	0.40	1.83	4,488	1,795	0.40	1.95
26	16	3,916	3,289	0.84	1.58	3,740	3,142	0.84	1.70	3,564	2,994	0.84	1.84
26	18	4,224	3,041	0.72	1.63	4,092	2,946	0.72	1.75	3,828	2,756	0.72	1.88
26	20	4,576	2,746	0.60	1.67	4,400	2,640	0.60	1.78	4,136	2,482	0.60	1.91
26	22	4,928	2,365	0.48	1.70	4,752	2,281	0.48	1.83	4,488	2,154	0.48	1.95
28	16	3,916	3,603	0.92	1.58	3,740	3,441	0.92	1.70	3,564	3,279	0.92	1.84
28	18	4,224	3,379	0.80	1.63	4,092	3,274	0.80	1.75	3,828	3,062	0.80	1.88
28	20	4,576	3,112	0.68	1.67	4,400	2,992	0.68	1.78	4,136	2,812	0.68	1.91
28	22	4,928	2,760	0.56	1.70	4,752	2,661	0.56	1.83	4,488	2,513	0.56	1.95
30	16	3,916	3,916	1.00	1.58	3,740	3,740	1.00	1.70	3,564	3,564	1.00	1.84
30	18	4,224	3,717	0.88	1.63	4,092	3,601	0.88	1.75	3,828	3,369	0.88	1.88
30	20	4,576	3,478	0.76	1.67	4,400	3,344	0.76	1.78	4,136	3,143	0.76	1.91
30	22	4,928	3,154	0.64	1.70	4,752	3,041	0.64	1.83	4,488	2,872	0.64	1.95
32	16	3,916	3,916	1.00	1.58	3,740	3,740	1.00	1.70	3,564	3,564	1.00	1.84
32	18	4,224	4,055	0.96	1.63	4,092	3,928	0.96	1.75	3,828	3,675	0.96	1.88
32	20	4,576	3,844	0.84	1.67	4,400	3,696	0.84	1.78	4,136	3,474	0.84	1.91
32	22	4,928	3,548	0.72	1.70	4,752	3,421	0.72	1.83	4,488	3,231	0.72	1.95
34	16	3,916	3,916	1.00	1.58	3,740	3,740	1.00	1.70	3,564	3,564	1.00	1.84
34	18	4,224	4,224	1.00	1.63	4,092	4,092	1.00	1.75	3,828	3,828	1.00	1.88
34	20	4,576	4,210	0.92	1.67	4,400	4,048	0.92	1.78	4,136	3,805	0.92	1.91
34	22	4,928	3,942	0.80	1.70	4,752	3,802	0.80	1.83	4,488	3,590	0.80	1.95

Note CA : Capacity (W)

P.C. : Power consumption (kW)

SHC(W) : Sensible heat capacity

SHF : Sensible heat factor

Above data based on indicated voltage

Indoor unit : Single phase 240V 50Hz

Outdoor unit : Single phase 240V 50Hz

**COOLING CAPACITY(5)
PMH-P2BA, PMH-P2BA₁**

Indoor Intake air D.B.(°C)	Indoor Intake air W.B.(°C)	Outdoor intake air D.B.(°C)											
		20				25				30			
		CA	SHC(W)	SHF	P.C.	CA	SHC(W)	SHF	P.C.	CA	SHC(W)	SHF	P.C.
20	16	5,346	3,047	0.57	1.88	5,184	2,955	0.57	1.99	5,022	2,863	0.57	2.10
20	18	5,724	2,576	0.45	1.92	5,562	2,503	0.45	2.02	5,373	2,418	0.45	2.16
20	20	6,156	2,031	0.33	1.97	6,021	1,987	0.33	2.07	5,859	1,933	0.33	2.21
22	16	5,346	3,475	0.65	1.88	5,184	3,370	0.65	1.99	5,022	3,264	0.65	2.10
22	18	5,724	3,034	0.53	1.92	5,562	2,948	0.53	2.02	5,373	2,848	0.53	2.16
22	20	6,156	2,524	0.41	1.97	6,021	2,469	0.41	2.07	5,859	2,402	0.41	2.21
24	16	5,346	3,903	0.73	1.88	5,184	3,784	0.73	1.99	5,022	3,666	0.73	2.10
24	18	5,724	3,492	0.61	1.92	5,562	3,393	0.61	2.02	5,373	3,278	0.61	2.16
24	20	6,156	3,016	0.49	1.97	6,021	2,950	0.49	2.07	5,859	2,871	0.49	2.21
24	22	6,561	2,428	0.37	2.02	6,426	2,378	0.37	2.14	6,264	2,318	0.37	2.28
26	16	5,346	4,330	0.81	1.88	5,184	4,199	0.81	1.99	5,022	4,068	0.81	2.10
26	18	5,724	3,950	0.69	1.92	5,562	3,838	0.69	2.02	5,373	3,707	0.69	2.16
26	20	6,156	3,509	0.57	1.97	6,021	3,432	0.57	2.07	5,859	3,340	0.57	2.21
26	22	6,561	2,952	0.45	2.02	6,426	2,892	0.45	2.14	6,264	2,819	0.45	2.28
28	16	5,346	4,758	0.89	1.88	5,184	4,614	0.89	1.99	5,022	4,470	0.89	2.10
28	18	5,724	4,407	0.77	1.92	5,562	4,283	0.77	2.02	5,373	4,137	0.77	2.16
28	20	6,156	4,001	0.65	1.97	6,021	3,914	0.65	2.07	5,859	3,808	0.65	2.21
28	22	6,561	3,477	0.53	2.02	6,426	3,406	0.53	2.14	6,264	3,320	0.53	2.28
30	16	5,346	5,186	0.97	1.88	5,184	5,028	0.97	1.99	5,022	4,871	0.97	2.10
30	18	5,724	4,865	0.85	1.92	5,562	4,728	0.85	2.02	5,373	4,567	0.85	2.16
30	20	6,156	4,494	0.73	1.97	6,021	4,395	0.73	2.07	5,859	4,277	0.73	2.21
30	22	6,561	4,002	0.61	2.02	6,426	3,920	0.61	2.14	6,264	3,821	0.61	2.28
32	16	5,346	5,346	1.00	1.88	5,184	5,184	1.00	1.99	5,022	5,022	1.00	2.10
32	18	5,724	5,323	0.93	1.92	5,562	5,173	0.93	2.02	5,373	4,997	0.93	2.16
32	20	6,156	4,986	0.81	1.97	6,021	4,877	0.81	2.07	5,859	4,746	0.81	2.21
32	22	6,561	4,527	0.69	2.02	6,426	4,434	0.69	2.14	6,264	4,322	0.69	2.28
34	16	5,346	5,346	1.00	1.88	5,184	5,184	1.00	1.99	5,022	5,022	1.00	2.10
34	18	5,724	5,724	1.00	1.92	5,562	5,562	1.00	2.02	5,373	5,373	1.00	2.16
34	20	6,156	5,479	0.89	1.97	6,021	5,359	0.89	2.07	5,859	5,215	0.89	2.21
34	22	6,561	5,052	0.77	2.02	6,426	4,948	0.77	2.14	6,264	4,823	0.77	2.28

Note CA : Capacity (W)
P.C. : Power consumption (kW)

SHC(W) : Sensible heat capacity
SHF : Sensible heat factor

Above data based on indicated voltage

Indoor unit : Single phase 240V 50Hz

Outdoor unit : Single phase 240V 50Hz / 3 phase 415V 50Hz

**COOLING CAPACITY(6)
PMH-P2BA, PMH-P2BA:**

Indoor Intake air D.B.(°C)	Indoor Intake air W.B.(°C)	Outdoor intake air D.B.(°C)											
		35				40				45			
		CA	SHC(W)	SHF	P.C.	CA	SHC(W)	SHF	P.C.	CA	SHC(W)	SHF	P.C.
20	16	4,806	2,739	0.57	2.26	4,590	2,616	0.57	2.42	4,374	2,493	0.57	2.62
20	18	5,184	2,333	0.45	2.31	5,022	2,260	0.45	2.49	4,698	2,114	0.45	2.68
20	20	5,616	1,853	0.33	2.37	5,400	1,782	0.33	2.54	5,076	1,675	0.33	2.73
22	16	4,806	3,124	0.65	2.26	4,590	2,984	0.65	2.42	4,374	2,843	0.65	2.62
22	18	5,184	2,748	0.53	2.31	5,022	2,662	0.53	2.49	4,698	2,490	0.53	2.68
22	20	5,616	2,303	0.41	2.37	5,400	2,214	0.41	2.54	5,076	2,081	0.41	2.73
24	16	4,806	3,508	0.73	2.26	4,590	3,351	0.73	2.42	4,374	3,193	0.73	2.62
24	18	5,184	3,162	0.61	2.31	5,022	3,063	0.61	2.49	4,698	2,866	0.61	2.68
24	20	5,616	2,752	0.49	2.37	5,400	2,646	0.49	2.54	5,076	2,487	0.49	2.73
24	22	6,048	2,238	0.37	2.42	5,832	2,158	0.37	2.61	5,508	2,038	0.37	2.77
26	16	4,806	3,893	0.81	2.26	4,590	3,718	0.81	2.42	4,374	3,543	0.81	2.62
26	18	5,184	3,577	0.69	2.31	5,022	3,465	0.69	2.49	4,698	3,242	0.69	2.68
26	20	5,616	3,201	0.57	2.37	5,400	3,078	0.57	2.54	5,076	2,893	0.57	2.73
26	22	6,048	2,722	0.45	2.42	5,832	2,624	0.45	2.61	5,508	2,479	0.45	2.77
28	16	4,806	4,277	0.89	2.26	4,590	4,085	0.89	2.42	4,374	3,893	0.89	2.62
28	18	5,184	3,992	0.77	2.31	5,022	3,867	0.77	2.49	4,698	3,617	0.77	2.68
28	20	5,616	3,650	0.65	2.37	5,400	3,510	0.65	2.54	5,076	3,299	0.65	2.73
28	22	6,048	3,205	0.53	2.42	5,832	3,091	0.53	2.61	5,508	2,919	0.53	2.77
30	16	4,806	4,662	0.97	2.26	4,590	4,452	0.97	2.42	4,374	4,243	0.97	2.62
30	18	5,184	4,406	0.85	2.31	5,022	4,269	0.85	2.49	4,698	3,993	0.85	2.68
30	20	5,616	4,100	0.73	2.37	5,400	3,942	0.73	2.54	5,076	3,705	0.73	2.73
30	22	6,048	3,689	0.61	2.42	5,832	3,558	0.61	2.61	5,508	3,360	0.61	2.77
32	16	4,806	4,806	1.00	2.26	4,590	4,590	1.00	2.42	4,374	4,374	1.00	2.62
32	18	5,184	4,821	0.93	2.31	5,022	4,670	0.93	2.49	4,698	4,369	0.93	2.68
32	20	5,616	4,549	0.81	2.37	5,400	4,374	0.81	2.54	5,076	4,112	0.81	2.73
32	22	6,048	4,173	0.69	2.42	5,832	4,024	0.69	2.61	5,508	3,801	0.69	2.77
34	16	4,806	4,806	1.00	2.26	4,590	4,590	1.00	2.42	4,374	4,374	1.00	2.62
34	18	5,184	5,184	1.00	2.31	5,022	5,022	1.00	2.49	4,698	4,698	1.00	2.68
34	20	5,616	4,998	0.89	2.37	5,400	4,806	0.89	2.54	5,076	4,518	0.89	2.73
34	22	6,048	4,657	0.77	2.42	5,832	4,491	0.77	2.61	5,508	4,241	0.77	2.77

Note CA : Capacity (W)

P.C. : Power consumption (kW)

SHC(W) : Sensible heat capacity

SHF : Sensible heat factor

Above data based on indicated voltage

Indoor unit : Single phase 240V 50Hz

Outdoor unit : Single phase 240V 50Hz / 3 phase 415V 50Hz

2) HEATING CAPACITY

Service Ref.	Indoor intake air D.B.(°C)	Outdoor intake air W.B.(°C)											
		-10		-5		0		5		10		15	
		CA	P.C.	CA	P.C.	CA	P.C.	CA	P.C.	CA	P.C.	CA	P.C.
PMH-P1BA PMH-P1BA ₁	15	2,159	0.63	2,346	0.69	2,618	0.80	3,434	0.95	3,876	1.06	4,318	1.14
	20	2,074	0.68	2,244	0.74	2,482	0.86	3,315	1.03	3,740	1.14	4,165	1.23
	25	2,006	0.72	2,176	0.81	2,380	0.93	3,128	1.09	3,604	1.22	4,012	1.32
PMH-P1.6BA PMH-P1.6BA ₁	15	3,175	1.00	3,450	1.11	3,850	1.28	5,050	1.53	5,700	1.70	6,350	1.84
	20	3,050	1.09	3,300	1.19	3,650	1.38	4,875	1.65	5,500	1.84	6,125	1.97
	25	2,950	1.16	3,200	1.29	3,500	1.50	4,600	1.75	5,300	1.96	5,900	2.12
PMH-P2BA PMH-P2BA ₁	15	3,969	1.43	4,313	1.57	4,813	1.82	6,313	2.18	7,125	2.42	7,938	2.61
	20	3,813	1.55	4,125	1.69	4,563	1.96	6,094	2.35	6,875	2.61	7,656	2.81
	25	3,688	1.65	4,000	1.84	4,375	2.13	5,750	2.49	6,625	2.80	7,375	3.01

Note CA : Capacity (W)

P.C. : Power consumption (kW)

Above data based on indicated voltage

Indoor unit : Single phase 240V 50Hz

Outdoor unit : Single phase 240V 50Hz / 3 phase 415V 50Hz

Cooling capacity correction factors

Service Ref.	Refrigerant piping length (one way)									
	5m	10m	15m	20m	25m	30m	35m	40m	45m	50m
PMH-P1BA PMH-P1BA ₁	1.00	0.993	0.984	0.978	0.969	0.961	—	—	—	—
PMH-P1.6BA PMH-P1.6BA ₁	1.00	0.993	0.984	0.978	0.969	0.961	0.956	0.948	—	—
PMH-P2BA PMH-P2BA ₁	1.00	0.993	0.984	0.978	0.969	0.961	0.956	0.948	—	—

Heating capacity correction factors

Service Ref.	Refrigerant piping length (one way)									
	5m	10m	15m	20m	25m	30m	35m	40m	45m	50m
PMH-P1BA PMH-P1BA ₁	1.00	0.998	0.995	0.993	0.990	0.988	—	—	—	—
PMH-P1.6BA PMH-P1.6BA ₁	1.00	0.998	0.995	0.993	0.990	0.988	0.985	0.983	—	—
PMH-P2BA PMH-P2BA ₁	1.00	0.998	0.995	0.993	0.990	0.988	0.985	0.983	—	—

6-2. PERFORMANCE CURVE

Cooling performance curve(50Hz)

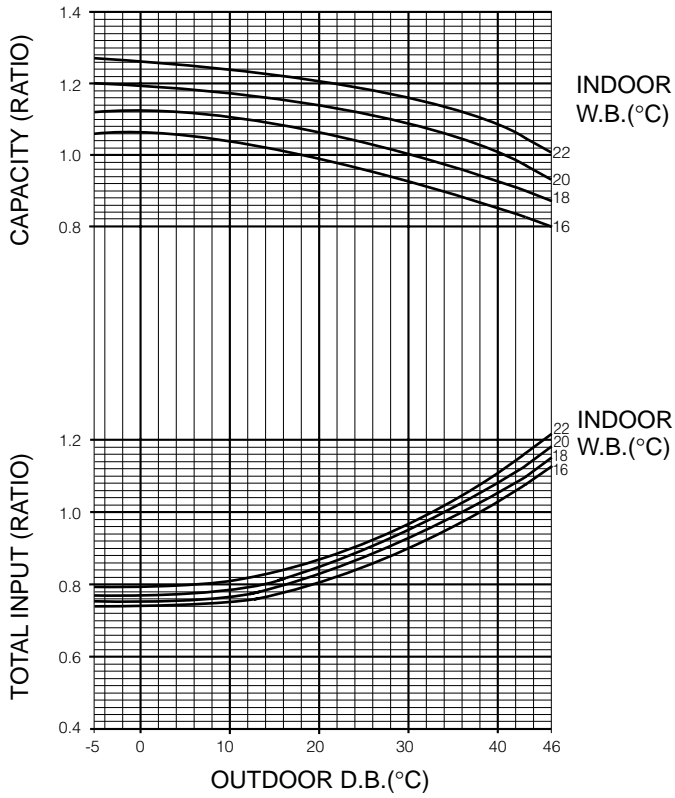

Heating performance curve(50Hz)

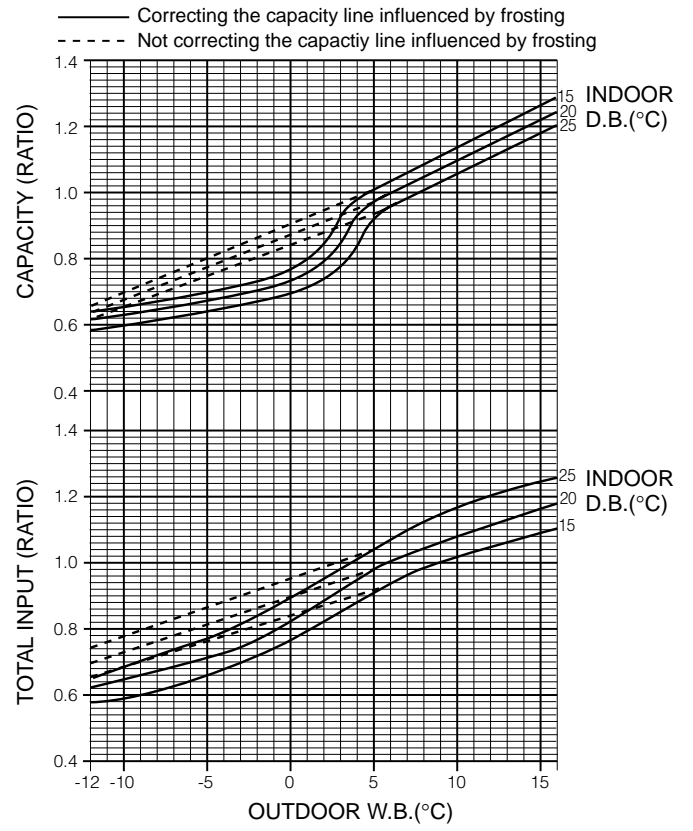

6-3. ELECTRICAL DATA

Indoor unit ... 220V 50Hz Single phase Outdoor unit...220V 50Hz Single phase / 380V 50Hz 3phase

Service Ref.	Indoor unit	PMH-P1.6BA				PMH-P2BA			
	Outdoor unit	PUH-P1.6VGA	PUH-P1.6YGA	PUH-P2VGA	PUH-P2YGA	PUH-P2VGA	PUH-P2YGA	PUH-P2VGA	PUH-P2YGA
Mode		Cool	Heat	Cool	Heat	Cool	Heat	Cool	Heat
Capacity (W)		4,300	4,900	4,300	4,900	5,300	6,150	5,300	6,150
Total Input (kW)		1.54	1.58	1.54	1.58	2.27	2.32	2.27	2.32
Indoor unit	Input (kW)	0.06	0.06	0.06	0.06	0.06	0.06	0.06	0.06
	Current (A)	0.29	0.29	0.29	0.29	0.29	0.29	0.29	0.29
Outdoor unit	Starting current (A)	33	33	18	18	68	68	28	28
	Current (A)	7.54	7.96	2.75	2.90	11.13	11.50	4.01	4.14

Indoor unit ... 230V 50Hz Single phase Outdoor unit...230V 50Hz Single phase / 400V 50Hz 3phase

Service Ref.	Indoor unit	PMH-P1.6BA				PMH-P2BA			
	Outdoor unit	PUH-P1.6VGA	PUH-P1.6YGA	PUH-P2VGA	PUH-P2YGA	PUH-P2VGA	PUH-P2YGA	PUH-P2VGA	PUH-P2YGA
Mode		Cool	Heat	Cool	Heat	Cool	Heat	Cool	Heat
Capacity (W)		4,350	4,950	4,350	4,950	5,350	6,200	5,350	6,200
Total Input (kW)		1.59	1.64	1.59	1.64	2.31	2.37	2.31	2.37
Indoor unit	Input (kW)	0.06	0.06	0.06	0.06	0.06	0.06	0.06	0.06
	Current (A)	0.29	0.29	0.29	0.29	0.29	0.29	0.29	0.29
Outdoor unit	Starting current (A)	35	35	19	19	71	71	29	29
	Current (A)	7.64	8.05	2.71	2.85	11.05	11.45	3.91	4.06

Indoor unit ... 240V 50Hz Single phase Outdoor unit...240V 50Hz Single phase / 415V 50Hz 3phase

Service Ref.	Indoor unit	PMH-P1.6BA				PMH-P2BA			
	Outdoor unit	PUH-P1.6VGA	PUH-P1.6YGA	PUH-P2VGA	PUH-P2YGA	PUH-P2VGA	PUH-P2YGA	PUH-P2VGA	PUH-P2YGA
Mode		Cool	Heat	Cool	Heat	Cool	Heat	Cool	Heat
Capacity (W)		4,400	5,000	4,400	5,000	5,400	6,250	5,400	6,250
Total Input (kW)		1.65	1.70	1.65	1.70	2.35	2.42	2.35	2.42
Indoor unit	Input (kW)	0.06	0.06	0.06	0.06	0.06	0.06	0.06	0.06
	Current (A)	0.29	0.29	0.29	0.29	0.29	0.29	0.29	0.29
Outdoor unit	Starting current (A)	36	36	20	20	74	74	30	30
	Current (A)	7.66	8.19	2.67	2.86	11.11	11.51	3.88	4.02

Indoor unit ... 220V 50Hz Single phase Outdoor unit ... 220V 50Hz Single phase / 380V 50Hz 3phase

Service Ref.	Indoor unit	PMH-P1BA PMH-P1BA ₁		PMH-P1.6BA PMH-P1.6BA ₁				PMH-P2BA PMH-P2BA ₁			
	Outdoor unit	PUH-P1VGAA.UK		PUH-P1.6VGAA.UK		PUH-P1.6YGAA.UK		PUH-P2VGAA.UK		PUH-P2YGAA.UK	
Mode		Cool	Heat	Cool	Heat	Cool	Heat	Cool	Heat	Cool	Heat
Capacity (W)		3,050	3,300	4,300	4,900	4,300	4,900	5,300	6,150	5,300	6,150
Total Input (kW)		1.13	1.04	1.54	1.58	1.54	1.58	2.27	2.32	2.27	2.32
Indoor unit	Input (kW)	0.04	0.04	0.06	0.06	0.06	0.06	0.06	0.06	0.06	0.06
	Current (A)	0.19	0.19	0.29	0.29	0.29	0.29	0.29	0.29	0.29	0.29
Outdoor unit	Starting current (A)	27	27	33	33	18	18	62	62	31	31
	Current (A)	5.37	4.93	8.03	8.28	2.71	2.80	11.19	11.53	4.05	4.17

Indoor unit ... 230V 50Hz Single phase Outdoor unit ... 230V 50Hz Single phase / 400V 50Hz 3phase

Service Ref.	Indoor unit	PMH-P1BA PMH-P1BA ₁		PMH-P1.6BA PMH-P1.6BA ₁				PMH-P2BA PMH-P2BA ₁			
	Outdoor unit	PUH-P1VGAA.UK		PUH-P1.6VGAA.UK		PUH-P1.6YGAA.UK		PUH-P2VGAA.UK		PUH-P2YGAA.UK	
Mode		Cool	Heat	Cool	Heat	Cool	Heat	Cool	Heat	Cool	Heat
Capacity (W)		3,100	3,350	4,350	4,950	4,350	4,950	5,350	6,200	5,350	6,200
Total Input (kW)		1.14	1.05	1.59	1.64	1.59	1.64	2.31	2.37	2.31	2.37
Indoor unit	Input (kW)	0.04	0.04	0.06	0.06	0.06	0.06	0.06	0.06	0.06	0.06
	Current (A)	0.19	0.19	0.29	0.29	0.29	0.29	0.29	0.29	0.29	0.29
Outdoor unit	Starting current (A)	29	29	35	35	19	19	62	62	31	31
	Current (A)	5.13	4.72	7.68	7.92	2.58	2.66	10.71	11.03	3.84	3.96

Indoor unit ... 240V 50Hz Single phase Outdoor unit ... 240V 50Hz Single phase / 415V 50Hz 3phase

Service Ref.	Indoor unit	PMH-P1BA PMH-P1BA ₁		PMH-P1.6BA PMH-P1.6BA ₁				PMH-P2BA PMH-P2BA ₁			
	Outdoor unit	PUH-P1VGAA.UK		PUH-P1.6VGAA.UK		PUH-P1.6YGAA.UK		PUH-P2VGAA.UK		PUH-P2YGAA.UK	
Mode		Cool	Heat	Cool	Heat	Cool	Heat	Cool	Heat	Cool	Heat
Capacity (W)		3,150	3,400	4,400	5,000	4,400	5,000	5,400	6,250	5,400	6,250
Total Input (kW)		1.15	1.06	1.65	1.70	1.65	1.70	2.35	2.42	2.35	2.42
Indoor unit	Input (kW)	0.04	0.04	0.06	0.06	0.06	0.06	0.06	0.06	0.06	0.06
	Current (A)	0.19	0.19	0.29	0.29	0.29	0.29	0.29	0.29	0.29	0.29
Outdoor unit	Starting current (A)	30	30	36	36	20	20	62	62	31	31
	Current (A)	4.92	4.52	7.36	7.59	2.49	2.56	10.26	10.57	3.70	3.82

6-4. STANDARD OPERATION DATA

Service Ref.			PMH-P1.6BA				PMH-P2BA					
Mode			Cooling		Heating		Cooling		Heating			
Total	Capacity	W	4,400		5,000		5,400		6,250			
	Input	kW	1.65		1.70		2.35		2.42			
Electrical circuit	Indoor unit Service Ref.		PMH-P1.6BA				PMH-P2BA					
	Phase, Hz		1, 50				1, 50					
	Volts	V	240				240					
	Amperes	A	0.29		0.29		0.29		0.29			
	Outdoor unit Service Ref.		PUH-P • GA				PUH-P • GA					
			1.6V	1.6Y	1.6V	1.6Y	2V	2Y	2V	2Y		
	Phase, Hz		1, 50	3, 50	1, 50	3, 50	1, 50	3, 50	1, 50	3, 50		
	Volts	V	240	415	240	415	240	415	240	415		
	Amperes	A	7.66	2.67	8.19	2.86	11.11	3.88	11.51	4.02		
Refrigerant circuit	Discharge pressure	MPa (kgf/cm ²)	1.99 (20.3)		2.15 (21.9)		2.37 (24.2)		2.52 (25.7)			
	Suction pressure	MPa (kgf/cm ²)	0.49 (5.0)		0.41 (4.2)		0.49 (5.0)		0.41 (4.2)			
	Discharge temperature	°C	75		80		86		93			
	Condensing temperature	°C	46		50		53		53			
	Suction temperature	°C	5.0		1.2		5.0		1.0			
	Ref. pipe length	m	5		5		5		5			
Indoor side	Intake air temperature	D.B.	°C		27		20		27		20	
		W.B.	°C		19		15		19		15	
Outdoor side	Discharge air temperature	D.B.	°C		12.4		47.2		11.4		49.0	
		W.B.	°C		35		7		35		7	
Outdoor side	Intake air temperature	D.B.	°C		35		7		35		7	
		W.B.	°C		24		6		24		6	
SHF			0.70		—		0.67		—			
BF			0.15		—		0.15		—			

The unit of pressure has been changed to Mpa based on international SI system.

The conversion factor is : 1(Mpa)=10.2(kgf/cm²)



Service Ref.			PMH-P1BA PMH-P1BA ₁		PMH-P1.6BA PMH-P1.6BA ₁		PMH-P2BA PMH-P2BA ₁					
Mode			Cooling	Heating	Cooling	Heating	Cooling	Heating				
Total	Capacity	W	3,150	3,400	4,400	5,000	5,400	6,250				
	Input	kW	1.15	1.06	1.65	1.70	2.35	2.42				
Electrical circuit	Indoor unit Service Ref.		PMH-P1BA PMH-P1BA ₁		PMH-P1.6BA PMH-P1.6BA ₁		PMH-P2BA PMH-P2BA ₁					
	Phase, Hz		1, 50		1, 50		1, 50					
	Volts	V	240		240		240					
	Amperes	A	0.19	0.19	0.29	0.29	0.29	0.29				
	Outdoor unit Service Ref.		PUH-P • GAA.UK		PUH-P • GAA.UK		PUH-P • GAA.UK					
			1V	1V	1.6V	1.6Y	1.6V	1.6Y	2V	2Y	2V	2Y
	Phase, Hz		1, 50	1, 50	1, 50	3, 50	1, 50	3, 50	1, 50	3, 50	1, 50	3, 50
	Volts	V	240	240	240	415	240	415	240	415	240	415
Amperes	A	4.92	4.52	7.36	2.49	7.59	2.56	10.26	3.70	10.57	3.82	
Refrigerant circuit	Discharge pressure	MPa (kgf/cm ²)	2.01 (20.5)	1.85 (18.9)	1.99 (20.3)	2.15 (21.9)	2.37 (24.2)	2.52 (25.7)				
	Suction pressure	MPa (kgf/cm ²)	0.55 (5.6)	0.44 (4.2)	0.49 (5.0)	0.41 (4.2)	0.49 (5.0)	0.41 (4.2)				
	Discharge temperature	°C	71	70	75	80	86	93				
	Condensing temperature	°C	48	44	46	50	53	53				
	Suction temperature	°C	8.0	4.0	5.0	1.2	5.0	1.0				
	Ref. pipe length	m	5	5	5	5	5	5				
Indoor side	Intake air temperature	D.B.	°C	27	20	27	20	27	20			
		W.B.	°C	19	15	19	15	19	15			
	Discharge air temperature	D.B.	°C	13.3	41.5	12.4	47.2	11.4	49.0			
Outdoor side	Intake air temperature	D.B.	°C	35	7	35	7	35	7			
		W.B.	°C	24	6	24	6	24	6			
SHF			0.77	—	0.70	—	0.67	—				
BF			0.09	—	0.15	—	0.15	—				

The unit of pressure has been changed to Mpa based on international SI system.
The conversion factor is : 1(Mpa)=10.2(kgf/cm²)

6-5. OUTLET AIR SPEED AND COVERAGE RANGE

			PMH-P1BA PMH-P1BA ₁	PMH-P1.6BA PMH-P1.6BA ₁	PMH-P2BA PMH-P2BA ₁
Standard	Air flow	m ³ /min	8.4	10.0	11.0
	Air speed	m/sec.	3.7	4.3	4.7
	Coverage range	m	5.9	7.0	7.7

* The air coverage range is the value up to the position where the air speed is 0.25m/sec.
When air is blown out horizontally from the unit at the Hi notch position.
The coverage range should be used only as a general guideline since it varies according to the size of the room and the furniture inside the room.

6-6. NOISE CRITERION CURVES

PMH-P1BA PMH-P1BA₁

NOTCH	SPL(dB)	LINE
Hi	35	○—○
Mi1	33	△—△
Mi2	31	▲—▲
Lo	29	●—●

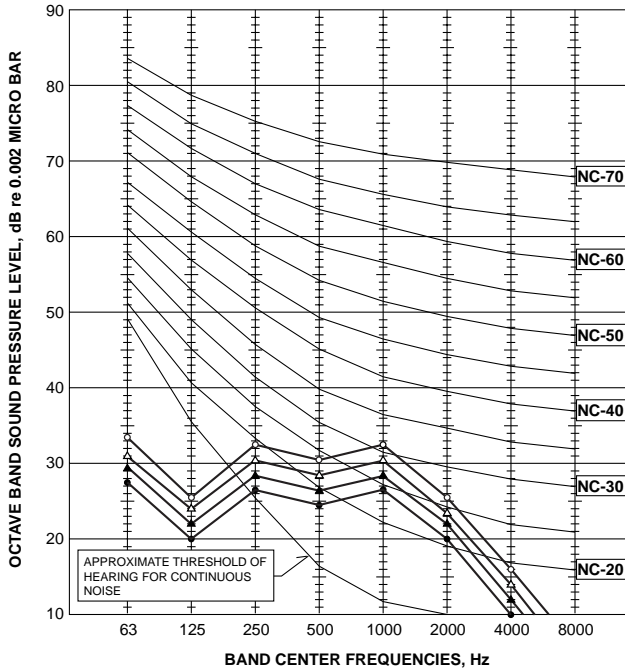

PMH-P1.6BA PMH-P1.6BA₁

NOTCH	SPL(dB)	LINE
Hi	40	○—○
Mi1	38	△—△
Mi2	36	▲—▲
Lo	34	●—●

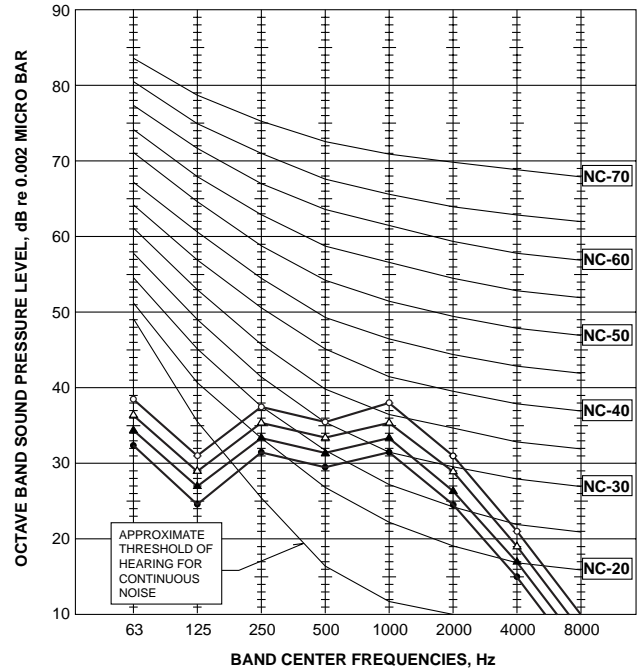

PMH-P2BA PMH-P2BA₁

NOTCH	SPL(dB)	LINE
Hi	42	○—○
Mi1	40	△—△
Mi2	38	▲—▲
Lo	36	●—●

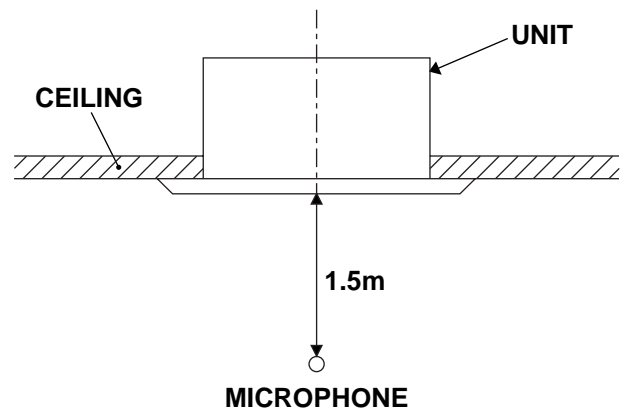
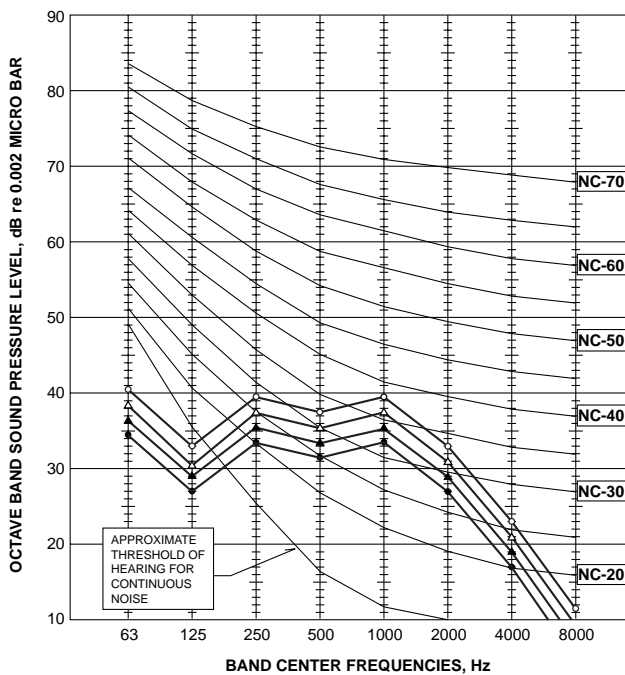

Ambient temperature 27°C

Test conditions are based on JIS Z8731

PMH-P1BA, PMH-P1BA₁
 PMH-P1.6BA, PMH-P1.6BA₁
 PMH-P2BA, PMH-P2BA₁

Unit : mm

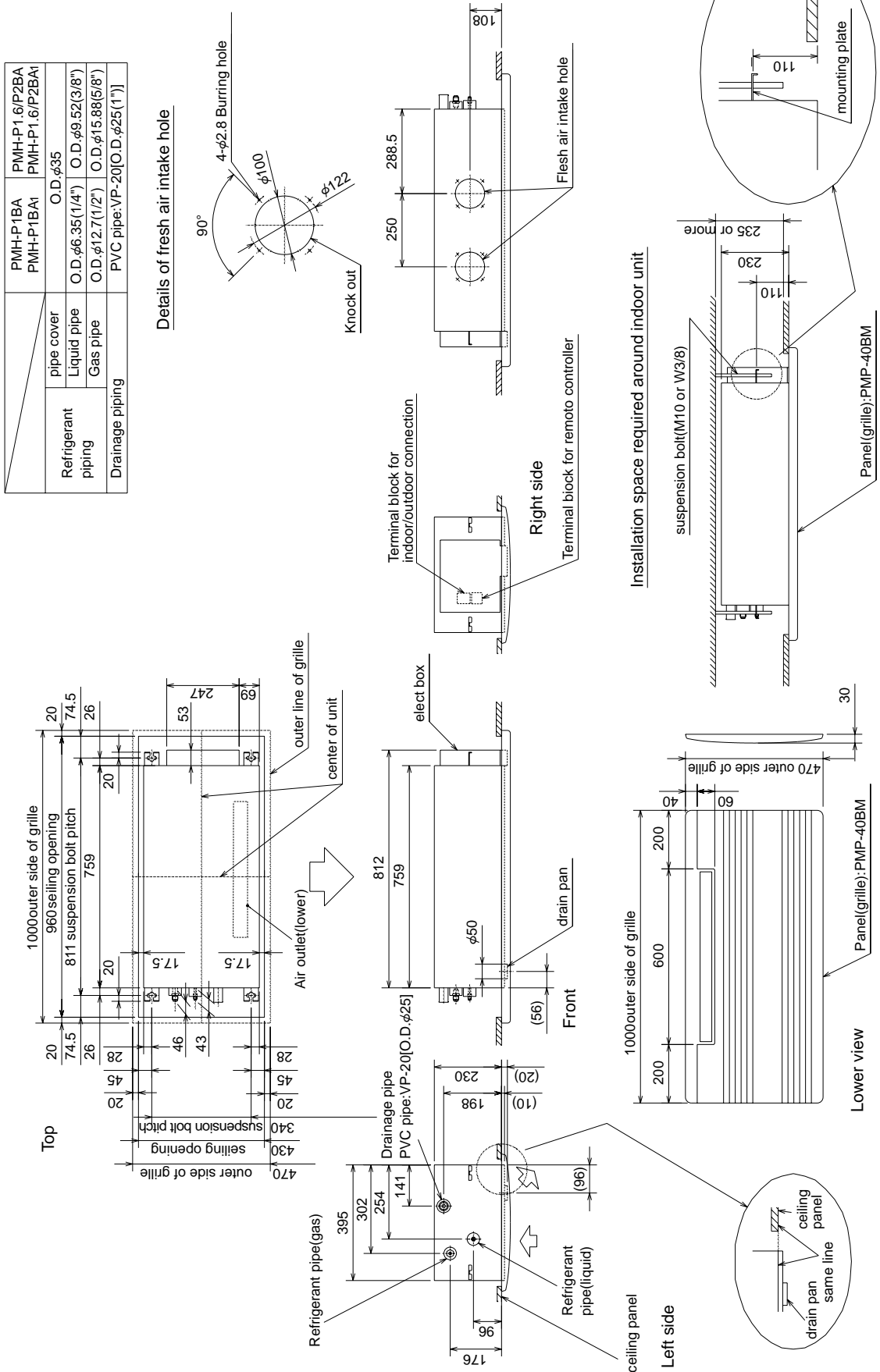

PMH-P1BA, PMH-P1.6BA, PMH-P2BA
PMH-P1BA₁, PMH-P1.6BA₁, PMH-P2BA₁

[LEGEND]

SYMBOL	NAME
I.B	INDOOR CONTROLLER BOARD
CN2L	CONNECTOR (LOSSNAY)
CN32	CONNECTOR (REMOTE SWITCH)
CN41	CONNECTOR (HA TERMINAL-A)
FUSE	FUSE (6.3A, 250V)
LED1	POWER SUPPLY (I.B)
LED2	POWER SUPPLY (R.B)
LED3	TRANSMISSION (INDOOR-OUTDOOR)
SW1	JUMPER WIRE (MODEL SELECTION)
SW2	JUMPER WIRE (CAPACITY CODE)
SWE	SWITCH (EMERGENCY OPERATION)
T	TRANSFORMER
X1	RELAY (DRAIN PUMP)
ZNR	VARISTOR
R.B	REMOTE CONTROLLER BOARD
CN2	CONNECTOR (PROGRAM TIMER)
TB6	TERMINAL BLOCK (REMOTE CONTROLLER TRANSMISSION LINE)
DP	DRAIN-UP MACHINE
DS	DRAIN SENSOR
MF	FAN MOTOR
MV	VANE MOTOR
TB4	TERMINAL BLOCK (INDOOR/OUTDOOR CONNECTING LINE)
TB5	TERMINAL BLOCK (REMOTE CONTROL TRANSMISSION LINE)
TH1	ROOM TEMPERATURE THERMISTOR (0°C/15KΩ, 25°C/5.4KΩ DETECT)
TH2	PIPE TEMPERATURE THERMISTOR/LIQUID (0°C/15KΩ, 25°C/5.4KΩ DETECT)
TH5	CONDENSER/EVAPORATOR TEMPERATURE THERMISTOR (0°C/15KΩ, 25°C/5.4KΩ DETECT)

NOTES:

1. Since the outdoor side electric wiring may change be sure to check the outdoor unit electric wiring for servicing.
2. Indoor and outdoor connecting wires are made with polarities, make wiring matching terminal numbers(S1, S2, S3).
3. Symbols used in wiring diagram above are, □:Connector, ⊙:Terminal (block).

Please set the voltage using the remote controller.
 For the setting method, please refer to the indoor unit Installation Manual.

<w1>

	MODELS	Manufacture	Service board
SW1	PMH-P1/1.6/2BA PMH-P1/1.6/2BA ₁	J11 J12 J13 J14 J15	J11 J12 J13 J14 J15
SW2	PMH-P1BA PMH-P1BA ₁	J21 J22 J23 J24	1 2 3 4 ON OFF
	PMH-P1.6BA PMH-P1.6BA ₁	J21 J22 J23 J24	1 2 3 4 ON OFF
	PMH-P2BA PMH-P2BA ₁	J21 J22 J23 J24	1 2 3 4 ON OFF

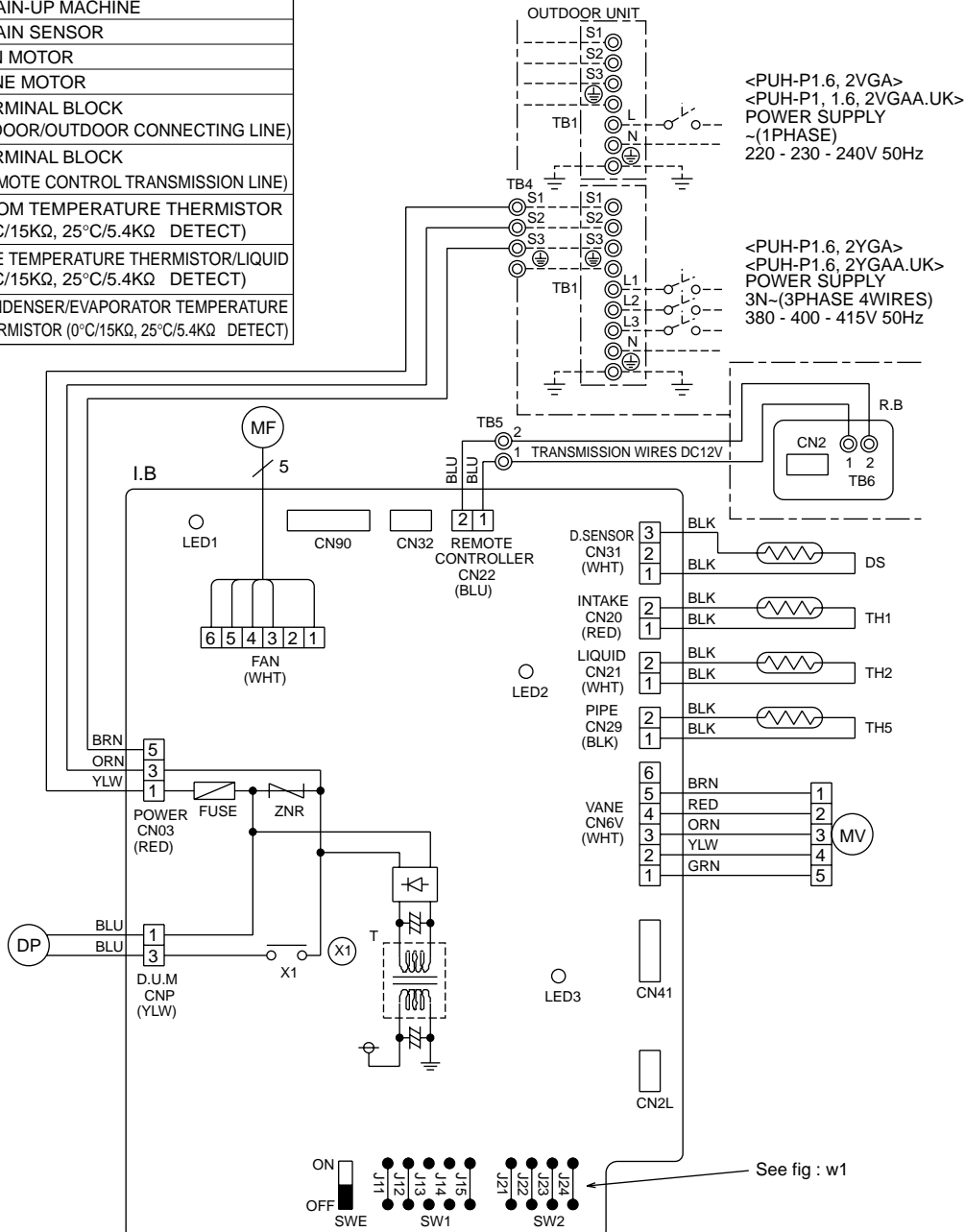

PMH-P1BA, PMH-P1BA ₁	/ PUH-P1VGAA.UK	
PMH-P1.6BA	/ PUH-P1.6VGA ,	PUH-P1.6VGAA.UK ,
	PUH-P1.6YGA ,	PUH-P1.6YGAA.UK
PMH-P1.6BA ₁	/ PUH-P1.6VGAA.UK ,	PUH-P1.6YGAA.UK
PMH-P2BA	/ PUH-P2VGA ,	PUH-P2VGAA.UK ,
	PUH-P2YGA ,	PUH-P2YGAA.UK
PMH-P2BA ₁	/ PUH-P2VGAA.UK ,	PUH-P2YGAA.UK

Unit : mm

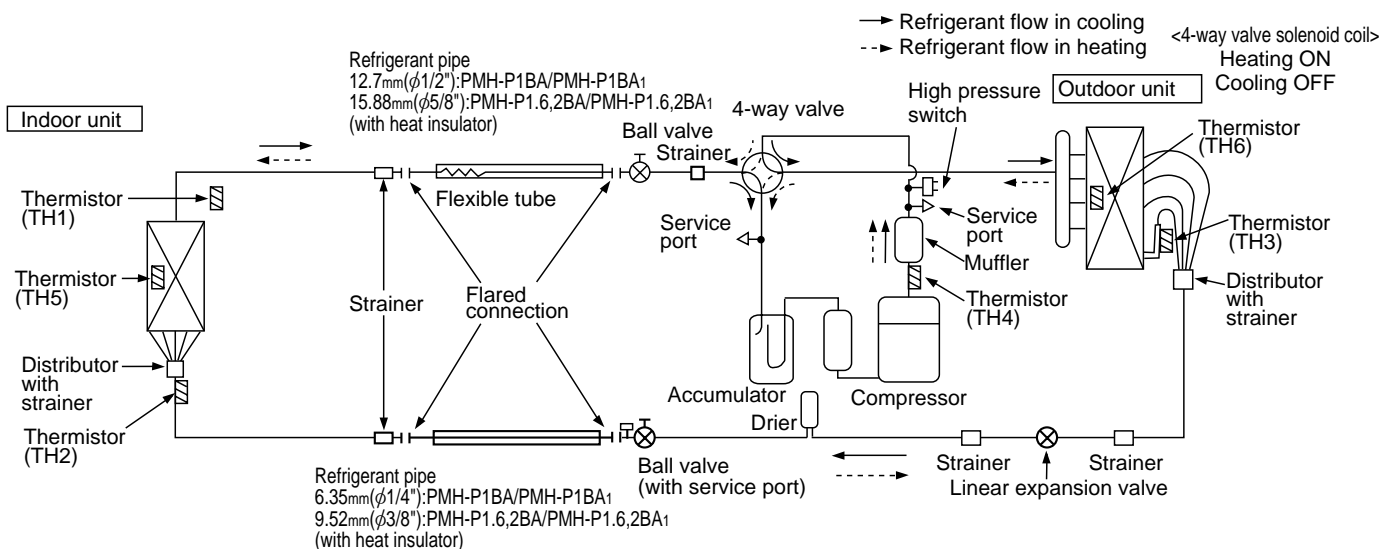

**How to check the parts PMH-P1BA, PMH-P1.6BA, PMH-P2BA
PMH-P1BA₁, PMH-P1.6BA₁, PMH-P2BA₁**

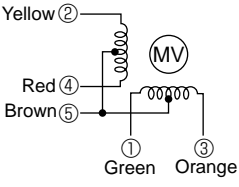
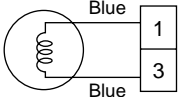
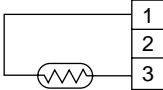
Parts name	Check points									
Room temperature thermistor (TH1) Pipe temperature thermistor (TH2) Condenser/evaporator temperature thermistor (TH5)	Disconnect the connector then measure the resistance using a tester. (Surrounding temperature 10°C ~30°C) <table border="1" data-bbox="349 479 860 555" style="margin-left: 20px;"> <thead> <tr> <th>Normal</th> <th>Abnormal</th> </tr> </thead> <tbody> <tr> <td>4.3kΩ~9.6kΩ</td> <td>Open or short</td> </tr> </tbody> </table> (Refer to page 34 in detail.)	Normal	Abnormal	4.3kΩ~9.6kΩ	Open or short					
Normal	Abnormal									
4.3kΩ~9.6kΩ	Open or short									
Vane motor 	Measure the resistance between the terminals using a tester. (Surrounding temperature 20°C ~30°C) <table border="1" data-bbox="349 678 1086 864" style="margin-left: 20px;"> <thead> <tr> <th>Connector</th> <th>Normal</th> <th>Abnormal</th> </tr> </thead> <tbody> <tr> <td>Brown — Yellow</td> <td rowspan="4" style="text-align: center; vertical-align: middle;">380Ω ±7%</td> <td rowspan="4" style="text-align: center; vertical-align: middle;">Open or short</td> </tr> <tr> <td>Brown — Red</td> </tr> <tr> <td>Brown — Orange</td> </tr> <tr> <td>Brown — Green</td> </tr> </tbody> </table>	Connector	Normal	Abnormal	Brown — Yellow	380Ω ±7%	Open or short	Brown — Red	Brown — Orange	Brown — Green
Connector	Normal	Abnormal								
Brown — Yellow	380Ω ±7%	Open or short								
Brown — Red										
Brown — Orange										
Brown — Green										
Drain-up mechanism 	Measure the resistance between the terminals using a tester. (Surrounding temperature 20°C) <table border="1" data-bbox="349 987 860 1064" style="margin-left: 20px;"> <thead> <tr> <th>Normal</th> <th>Abnormal</th> </tr> </thead> <tbody> <tr> <td>400Ω~480Ω</td> <td>Open or short</td> </tr> </tbody> </table>	Normal	Abnormal	400Ω~480Ω	Open or short					
Normal	Abnormal									
400Ω~480Ω	Open or short									
Drain sensor 	Measure the resistance between the terminals using a tester. (Surrounding temperature 20°C ~30°C) <table border="1" data-bbox="349 1178 860 1254" style="margin-left: 20px;"> <thead> <tr> <th>Normal</th> <th>Abnormal</th> </tr> </thead> <tbody> <tr> <td>0.6kΩ~6.0kΩ</td> <td>Open or short</td> </tr> </tbody> </table> (Refer to page 34 in detail.)	Normal	Abnormal	0.6kΩ~6.0kΩ	Open or short					
Normal	Abnormal									
0.6kΩ~6.0kΩ	Open or short									

Check method of indoor fan motor (fan motor / control p.c.board)

① Notes

- High voltage is applied to the connector (FAN) for the fan motor. Give attention to the service.
- Do not pull out the connector (Fan) for the motor with the power supply on.
(It causes trouble of the control p.c.board)

② Self check

Conditions : The indoor fan cannot turn around.

Wiring contact check
Contact of fan motor connector (FAN)
Contact of power supply cable.



Was contact caused good? → NO → Wiring recovery

↓Yes

Fan motor check
Measure the resistance between the fan motor connector ①(+) and ③(-).
(With the connector is pulled out from the p.c.board)



Is the resistance 1MΩ or more? → NO → Trouble of the fan motor Replacement of the motor

↓Yes

Power supply check
Check the voltage in the indoor control p.c.board
Approx. 310~340V between the connector (FAN) ①(+) and ③(-).
Approx. 1~3V between the connector (FAN) ⑤(+) and ③(-).
(The voltage between the ⑤ and ③ is a value during the fan motor operation.)
(In the case that the fan motor off, the voltage is 0V.)



Is the voltage normal? → NO → Trouble of the indoor p.c.board
Replacement of the indoor control p.c.board

↓Yes

Fan motor position sensor signal check
Turn around the fan motor more than one revolution slowly, and check
the voltage between the connector (FAN) ⑥(+) and ③(-).



Dose the voltage repeat DC0V and DC15V? → NO → Trouble of the fan motor
Replacement of the motor

↓Yes

Replacement of the indoor control p.c.board

<Thermistor Characteristic graph>

Thermistor for lower temperature

Room temperature thermistor (TH1)
 Pipe temperature thermistor (TH2)
 Condenser/evaporator temperature thermistor (TH5)

Thermistor $R_0 = 15k\Omega \pm 3\%$

Fixed number of $B = 3480k\Omega \pm 2\%$

$$R_t = 15 \exp \left\{ 3480 \left(\frac{1}{273+t} - \frac{1}{273} \right) \right\}$$

0°C	15kΩ
10°C	9.6kΩ
20°C	6.3kΩ
25°C	5.4kΩ
30°C	4.3kΩ
40°C	3.0kΩ

Thermistor for drain sensor

Thermistor $R_0 = 6.0k\Omega \pm 5\%$

Fixed number of $B = 3390k\Omega \pm 2\%$

$$R_t = 6 \exp \left\{ 3390 \left(\frac{1}{273+t} - \frac{1}{273} \right) \right\}$$

0°C	6.0kΩ
10°C	3.9kΩ
20°C	2.6kΩ
25°C	2.2kΩ
30°C	1.8kΩ
40°C	1.3kΩ

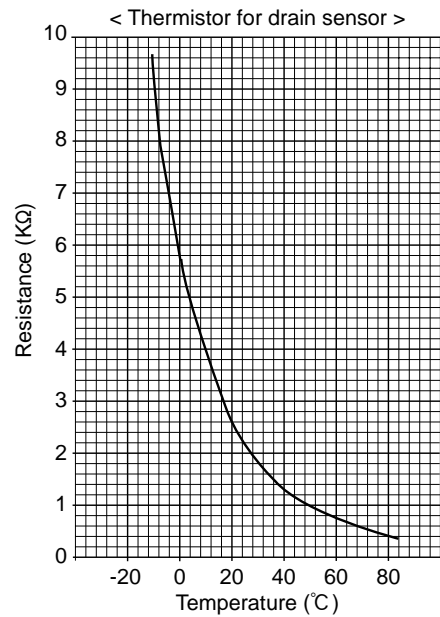
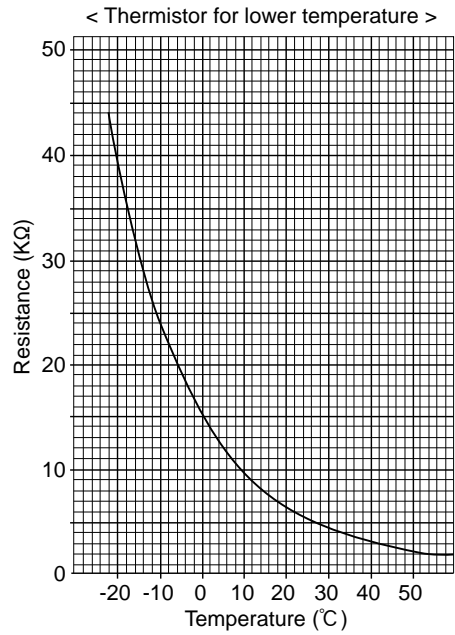

PMH-P1BA, PMH-P1BA₁
 PMH-P1.6BA, PMH-P1.6BA₁, PMH-P2BA, PMH-P2BA₁

Be careful on removing heavy parts.

OPERATING PROCEDURE

1. Removing the intake grille

Opening the air intake grille

- (1) Press the **PUSH** of the air intake grille.(See figure 1)
- (2) Put your figure on the both end of nut of the air intake grille and put it down after the grille clicked.

Removing the air intake grille

- (1) Press the **PUSH** of air intake grille, and pull down the both end of nut with your fingers after the grille clicked. (See figure 1)
- (2) Pull out the handle of air intake grille strong toward you. (See figure 2)
- (3) Draw the string of air intake grille to prevent the grille from dropping.(see figure 3)

PHOTOS&ILLUSTRATIONS

Photo 1

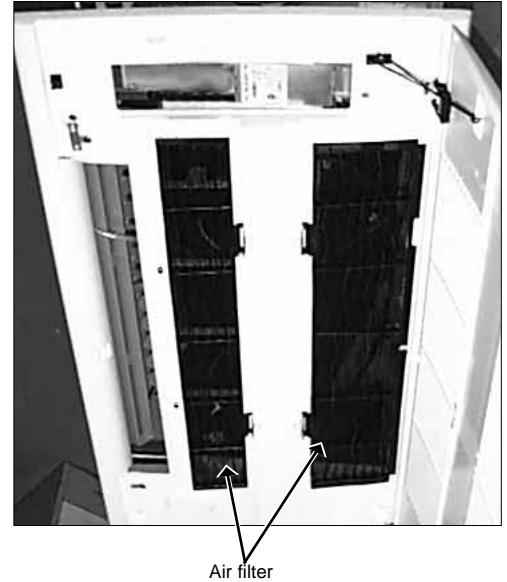

Figure 1

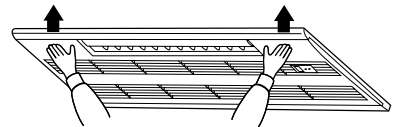

Figure 2

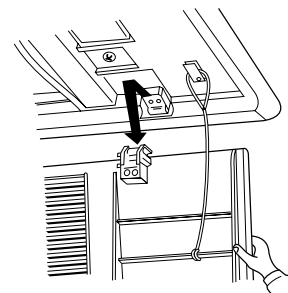
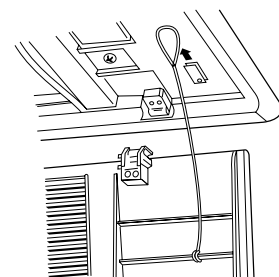

Figure 3



OPERATING PROCEDURE

PHOTOS&ILLUSTRATIONS

2. Removing the electrical parts box

- (1) Remove the panel.
- (2) Remove the cover.
- (3) Remove the electrical parts cover.
- (4) Disconnect the connectors of fan motor, vane motor, drain pump, room temperature thermistor, pipe temperature thermistor, condenser/evaporator temperature thermistor and drain sensor on the electrical controller board.
- (5) Disconnect the lead wire and earth wire from terminal block.
- (6) Remove the electrical parts box.

Photo 2

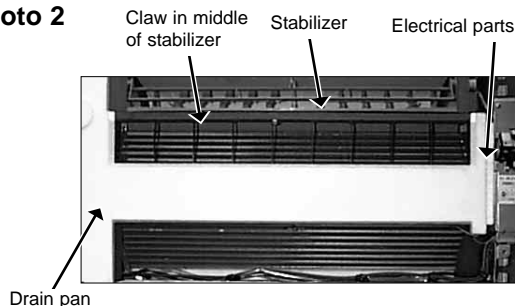
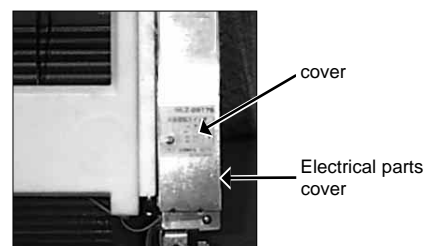

Photo 3



3. Removing the stabilizer

Note when the stabilizer is removed

- Since the insulation material (white) which prevents waterdrops from putting is mounted to the side of vane motor, remove the insulation material when the stabilizer is removed.(See figure 4)
- After completing the service, mount the insulation material as before as shown in right figure.
- Since the insulation material to prevent water-drops from putting consists of double layer of soft and hard materials, mount the insulation material so that the hard material faces to the stabilizer side.

- (1) Remove the panel.
- (2) Remove the room temperature thermistor.
- (3) Unhook the claw in the middle of stabilizer and remove the drain pan. (5 screws) (See photo 2)
- (4) Remove the stabilizer side of the heat exchanger. (2 screws)
- (5) Remove the cover.
- (6) Remove the electrical parts cover.
- (7) Disconnect the connector of vane motor.
- (8) Remove the insulation material (white) on the right side of stabilizer.
- (9) Remove the stabilizer. (6 screws)

Photo 4

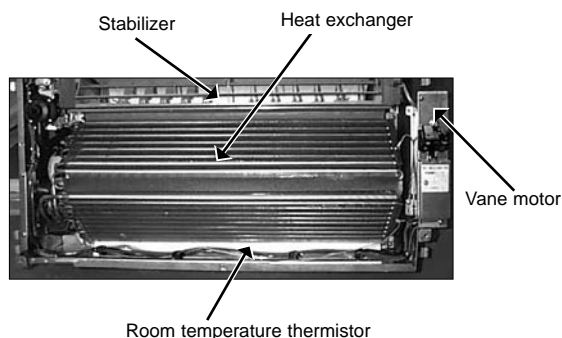
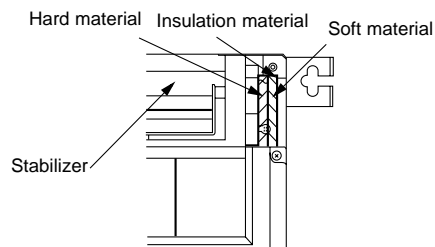

Figure 4



4. Removing the vane motor

- (1) Remove the stabilizer. Refer to above-mentioned (3) Removing the stabilizer.
- (2) Remove the vane motor.

Photo 5

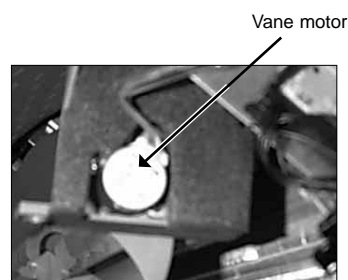



OPERATING PROCEDURE

PHOTOS&ILLUSTRATIONS

5. Removing the drain pump

- (1) Remove the panel.
- (2) Unhook the claw in the middle of stabilizer and remove the drain pan.
- (3) Remove the cover.
- (4) Remove the electrical parts cover.
- (5) Disconnect the connector of drain pump.
- (6) Remove the drain hose.
- (7) Remove the drain pump.(2 screws)

Photo 6

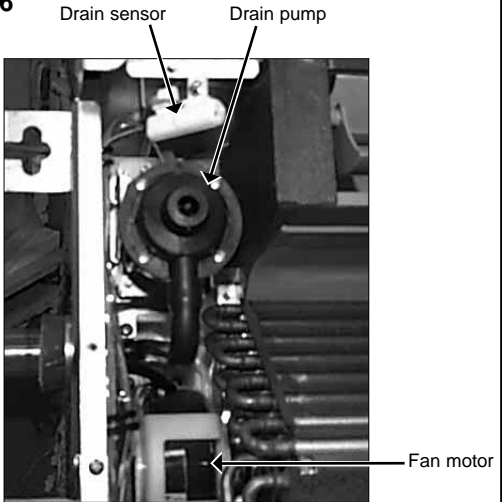

6. Removing the fan motor and line flow fan

- (1) Remove the panel.
- (2) Unhook the claw in the middle of stabilizer and remove the drain pan.
- (3) Unscrew 2 screws at the stabilizer side of the heat exchanger
- (4) Remove the cover.
- (5) Remove the electrical parts cover.
- (6) Disconnect the connectors of vane motor, fan motor and drain pump.
- (7) Remove the stabilizer side of the heat exchanger. (2 screws)
- (8) Remove the stabilizer.
- (9) Remove the drain pump.
- (10) Unscrew 2 screws in the motor support.
- (11) Remove the fan motor and line flow fan (The fan motor and line flow fan can be removed without removing the heat exchanger.)

Photo 7

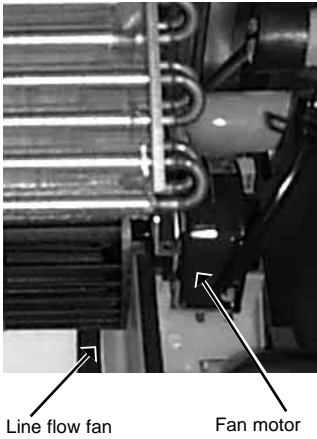

7. Removing the thermistor<Room temperature thermistor>

- (1) Remove the panel.
- (2) Bring down the electrical parts box and remove the cover.
- (3) Remove the thermistor <Room temperature thermistor>
- (4) Disconnect the lead wire from the cord clamp (5 points)
- (5) Disconnect the connector (CN20) on the indoor controller board.

**8. Removing the thermistor<Pipe temperature thermistor/liquid>
<Condenser/evaporator temperature thermistor>**

- (1) Remove the panel.
- (2) Bring down the electrical parts box and remove the cover.
- (3) Remove the drain pan.
- (4) Remove the thermistor <Pipe temperature thermistor/liquid>
/<Condenser/evaporator temperature thermistor>.
- (5) Disconnect the lead wire from the cord clamp
- (6) Disconnect the connector (CN29)/(CN21) on the indoor controller board.

PANEL PARTS

PMH-P1BA , PMH-P1BA₁
 PMH-P1.6BA , PMH-P1.6BA₁
 PMH-P2BA , PMH-P2BA₁

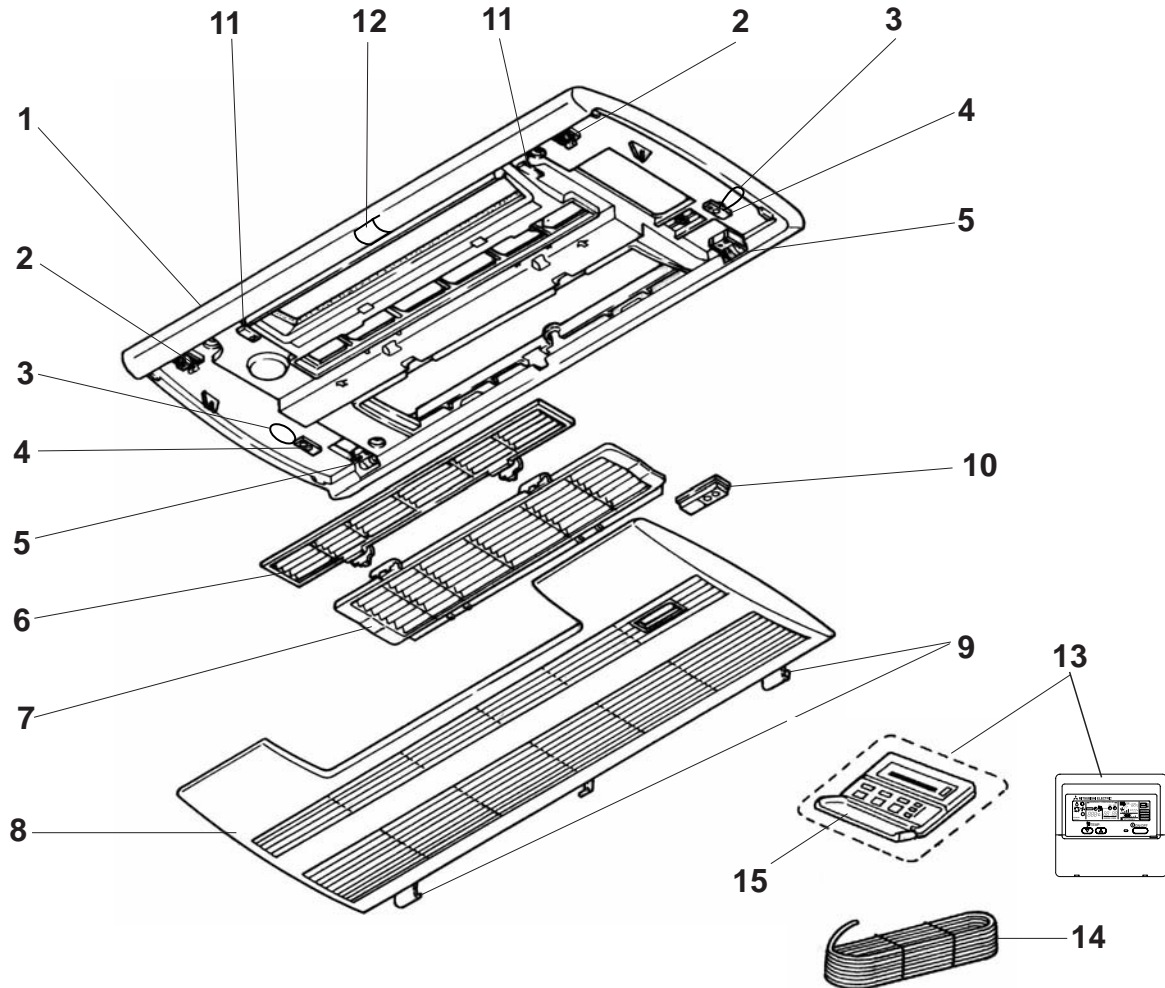

No.	Part No.	Part Name	Specification	Q'ty/set		Remarks (Drawing No.)	Wiring Diagram Symbol	Recom- mended Q'ty	Price	
				PMH-P1/1.6/2					Unit	Amount
				BA	BA ₁					
1	T7W E11 003	AIR OUTLET GRILLE		1	1					
2	R01 E00 055	LATCH		2	2					
3	—	HANGER		2	2	(DT88D360H03)				
4	R01 E00 099	PANEL HOOK		2	2					
5	R01 E01 054	GRILLE CATCH		2	2					
6	R01 E01 500	LL.FILTER		1	1					
7	R01 E02 500	LL.FILTER		1	1					
8	T7W E01 691	INTAKE GRILLE		1	1					
9	R01 E00 054	GRILLE CATCH		2	2					
10	R01 E00 648	RECEIVER COVER		1	1					
11	R01 E00 044	MAGNET		2	2					
12	R01 E00 096	SCREW CAP		1	1					
13	T7W E00 713	REMOTE CONTROLLER		1						
	T7W E06 713	REMOTE CONTROLLER			1					
14	T7W A00 305	REMOTE CONTROLLER CABLE		1	1					
15	T7W E04 049	REMOTE CONTROLLER COVER		1						

FUNCTIONAL PARTS

PMH-P1BA , PMH-P1BA₁
 PMH-P1.6BA , PMH-P1.6BA₁
 PMH-P2BA , PMH-P2BA₁

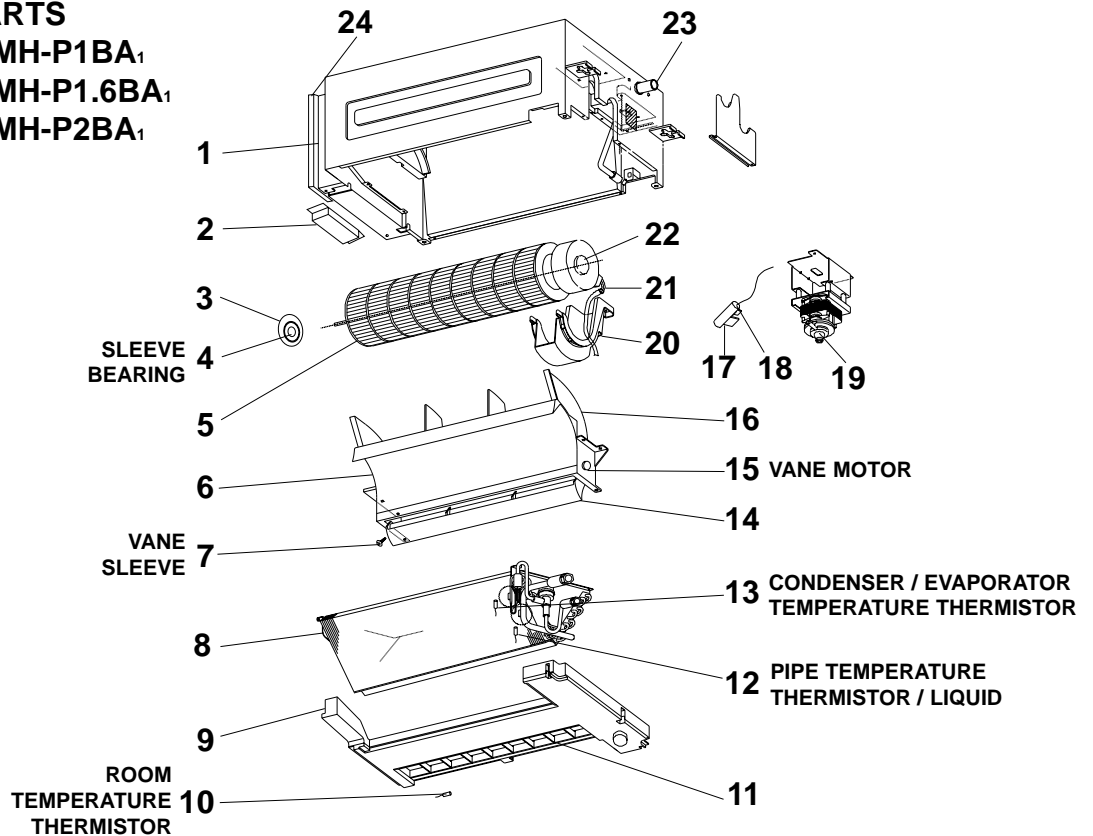

Part number that is circled is not shown in the figure.

No.	Part No.	Part Name	Specification	Q'ty/set			Remarks (Drawing No.)	Wiring Diagram Symbol	Recom- mended Q'ty	Price	
				PMH-P-BA	PMH-P-BA ₁					Unit	Amount
					1	1.6					
1	—	CABINET		1	1	1	(DT00A478G78)				
2	—	COVER		1	1	1	(RG02L277H02)				
3	R01 22A 102	BEARING MOUNT		1	1	1					
4	R01 005 103	SLEEVE BEARING		1	1	1					
5	R01 E02 114	LINE FLOW FAN		1	1	1					
6	R01 E00 079	STABILIZER ASSY		1	1	1					
7	R01 E00 092	VANE SLEEVE		1	1	1					
8	T7W E69 480	HEAT EXCHANGER		1							
	T7W E70 480	HEAT EXCHANGER			1	1					
9	R01 E04 529	DRAIN PAN		1	1	1					
10	R01 E00 202	ROOM TEMPERATURE THERMISTOR		1	1	1		TH1			
11	R01 E00 038	GUIDE VANE		1	1	1					
12	R01 E41 202	PIPE TEMPERATURE THERMISTOR / LIQUID		1	1	1		TH2			
13	R01 E44 202	CONDENSER / EVAPORATOR TEMPERATURE THERMISTOR		1	1	1		TH5			
14	R01 E01 002	VANE		1	1	1					
15	R01 E01 223	VANE MOTOR		1	1	1		MV			
16	R01 E00 110	CASING		1	1	1					
17	R01 31K 241	SENSOR HOLDER		1	1	1					
18	R01 E01 266	DRAIN SENSOR		1	1	1		DS			
19	T7W E02 355	DRAIN PUMP		1	1	1		DP			
20	R01 E00 130	MOTOR SUPPORT		1	1	1					
21	R01 E03 220	FAN MOTOR		1	1	1		MF			
22	R01 E01 105	MOTOR MOUNT		1	1	1					
23	R01 E00 527	DRAIN PIPE		1	1	1					
24	—	CONTROL BOX COVER		1	1	1	(RG00L311G08)				
(25)	R01 E01 673	SCREW ASSY		1	1	1					

ELECTRICAL PARTS

PMH-P1BA , PMH-P1BA₁

PMH-P1.6BA , PMH-P1.6BA₁

PMH-P2BA , PMH-P2BA₁

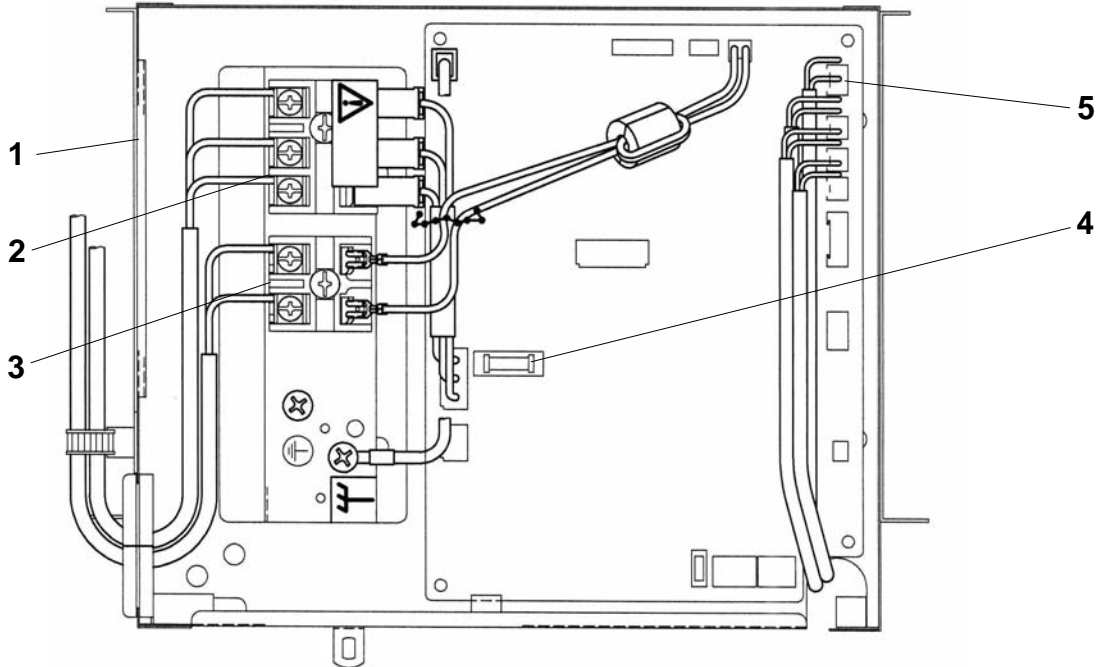

No.	Part No.	Part Name	Specification	Q'ty/set		Remarks (Drawing No.)	Wiring Diagram Symbol	Recom- mended Q'ty	Price		
				PMH-P1/1.6/2	BA				BA ₁	Unit	Amount
1	—	CONTROL BOX		1	1	(RG02B337G10)					
2	T7W E13 716	TERMINAL BLOCK	3P (S1, S2, S3)	1	1		TB4				
3	T7W 515 716	TERMINAL BLOCK	2P (1, 2)	1	1		TB5				
4	T7W 520 239	FUSE	250V 6.3A	1	1		FUSE				
5	T7W E13 310	INDOOR CONTROLLER BOARD		1	1		I.B				

13-1. TIMER

Part No.	PAC-SC32PTA (with set back function)
Model Name	Program timer

13-1-1. Program timer specifications

Part name	Program timer
Parts No.	PAC-SC32PTA
Exterior dimensions (inch)	5-4/32X4-23/32X23/32 (130X120X18mm)
Installation	Wall mount
Type of clock	Quartz
Clock accuracy	±50 second / month at 25°C
Display-Time	Liquid crystal display
-Week	Liquid crystal display
-Timer setting unit	Liquid crystal display
Program cycle	24 hours
Timer setting unit	30 minutes
No. of set points	48 / day
Power rating	5V DC ±5% (Supplied by Remote Controller)

13-1-2. Feature of program timer

(1) Daily timer function

Daily timer can be set in 30 minutes units for up to 24 hours.
Each unit can be set for unit ON, unit OFF, or setback operation.

(2) Setback operation

Set back operation is useful for reducing running costs

e.g. At a hotel with a 24-hour system

8:00~23:00 Cooling operation with set temperature at 26°C

23:00~8:00 Setback operation with 2 degrees of setback

As shown in the chart on the right, the set temperature rises 2 degrees automatically during the setback operation. When the setback operation ends, normal operation will begin.

(3) Weekly timer function

Daily timer function can apply to each day of the week.

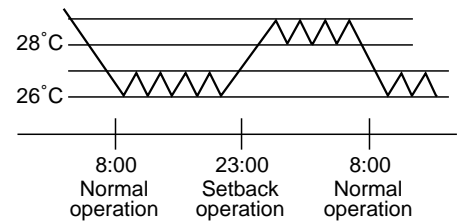

13-1-3. How to connect program timer

- (1) Install the program timer next to the remote controller the same way as the remote controller is installed.
- (2) Connect the program timer and the remote controller with a 5-wire cable as shown in the figure below

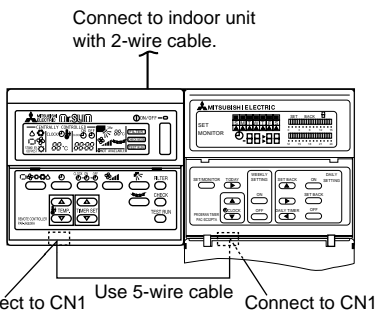

NOTE: While the program timer is connected to the remote controller, the 24hour ON/OFF timer on the remote controller will not operate.

13-1-4. Names and functions <PAC-SC32PTA>

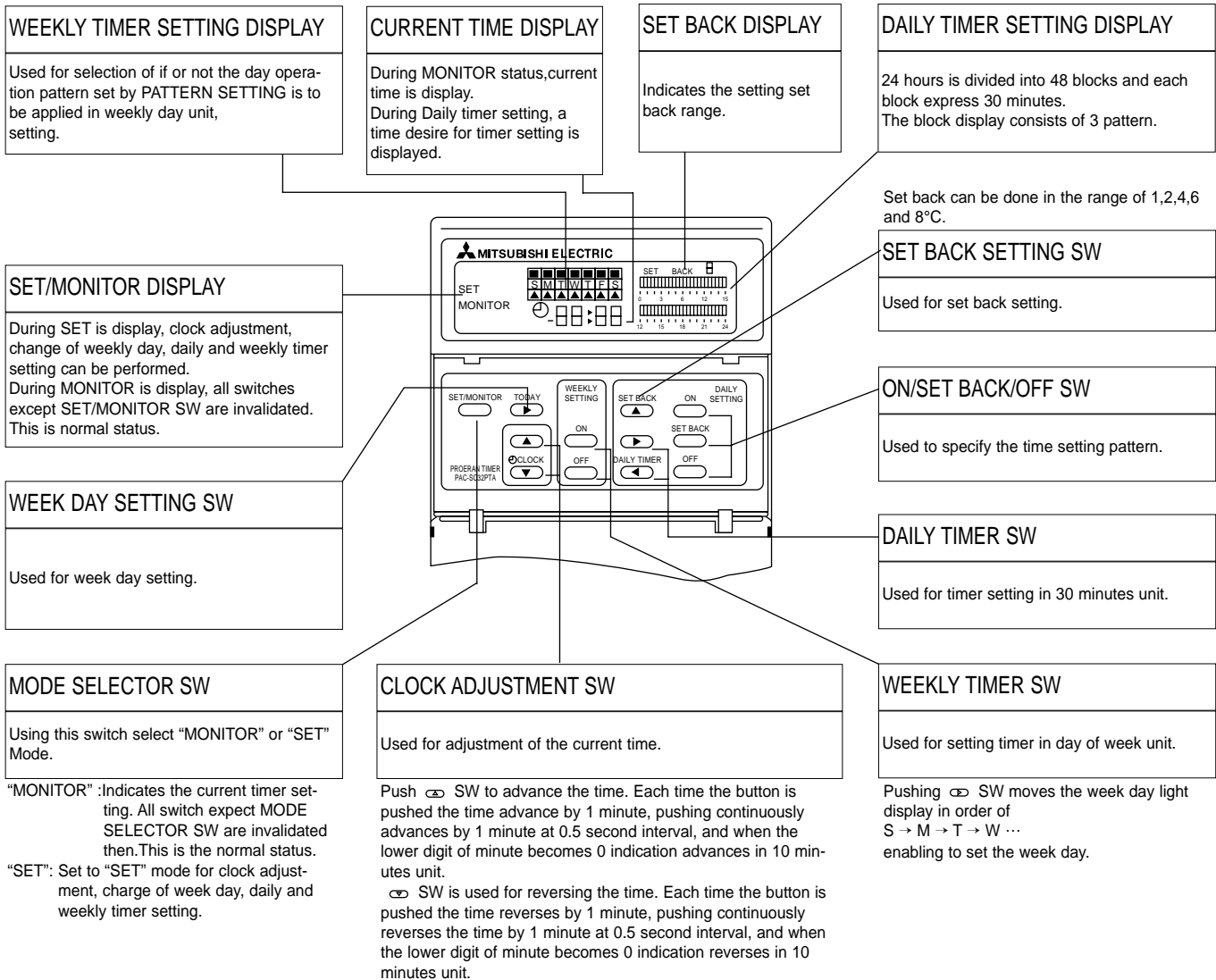



13-2. Remote Sensor

Part No.	PAC-SE41TS-E
Applied Service Ref.	PMH-P1 / 1.6 / 2BA, PMH-P1 / 1.6 / 2BA ₁

13-3. Remote Operation Adapter

Part No.	PAC-SF40RM-E
Applied Service Ref.	PMH-P1 / 1.6 / 2BA, PMH-P1 / 1.6 / 2BA ₁

13-4. Remote ON/OFF Adapter

Part No.	PAC-SE55RA-E
Applied Service Ref.	PMH-P1 / 1.6 / 2BA, PMH-P1 / 1.6 / 2BA ₁

Mr. SLIM™

 **MITSUBISHI ELECTRIC CORPORATION**
HEAD OFFICE : MITSUBISHI DENKI BLDG., 2-2-3, MARUNOUCHI, CHIYODA-KU, TOKYO 100-8310, JAPAN