

Air Conditioning

Product Information

PEAD-RP100JAQ : Power Inverter Heat Pump

R410A Ceiling Concealed Ducted System

Mr.SLIM™

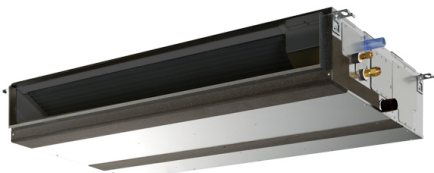

Our wide range of Power Inverters offer customers high seasonal efficiency, advanced control options and quiet operation, whilst providing greater flexibility and ease of installation.

FEATURES

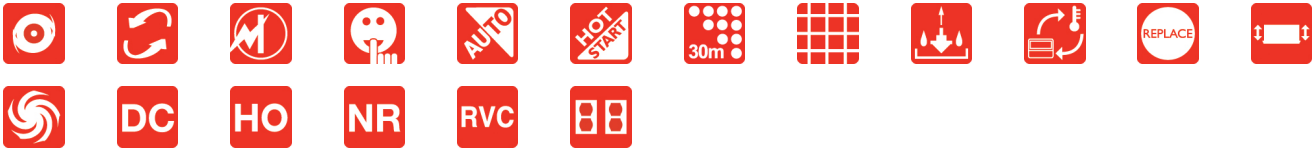

INDOOR

Heating Capacity (kW) (nominal)	11.2 (4.5 - 14)
Cooling Capacity (kW) (nominal)	10 (4.9 - 11.4)
Heating Capacity (kW) (UK)	9.50 (3.85 - 11.9)
Cooling Capacity (kW) (UK)	9.2 (4.5 - 10.5)
SHF (nominal and UK)	0.82
COP / EER (nominal)	4.31 / 3.80
SCOP / SEER	4.2 / 5.5
Energy Efficiency Class - Heating / Cooling	A+ / A
Airflow (m ³ /min) Lo-Mi-Hi	24 - 29 - 34
Pipe Size Gas (mm [in])	15.88 (5/8")
Pipe Size Liquid (mm [in])	9.52 (3/8")
External Static Pressure (Pa) Lo-Mi-Mi2-Mi3-Hi	35 - 50 - 70 - 100 - 150
Sound Pressure Level (dBA) Lo-Mi-Hi	29 - 34 - 38
Sound Power Level (dBA) Cooling	61
Dimensions (mm) Width x Depth x Height	1400 x 732 x 250
Weight (kg)	41
Electrical Supply	FED BY OUTDOOR UNIT
Phase	SINGLE
Fuse Rating (BS88) - HRC (A)	6
Interconnecting Cable No. Cores	4

OUTDOOR

Sound Pressure Level (dBA) Heating / Cooling	51 / 49
Sound Power Level (dBA) Cooling	69
Weight (kg)	124
Dimensions (mm) Width x Depth x Height	1050 x (330+30) x 1338
Electrical Supply	380-415V, 50HZ
Phase	THREE
System Power Input (kW) - Heating / Cooling (nominal)	2.60 / 2.63
System Power Input (kW) - Heating / Cooling (UK)	2.34 / 2.21
Starting Current (A)	4
System Running Current (A) [MAX] - Heating / Cooling	5.45 / 5.52 [10.7]
Fuse Rating (BS88) - HRC (A)	16
Mains Cable No. Cores	5
Max Pipe Length (m)	75
Max Height Difference (m)	30
Charge R410A (kg) - Pre charged length (m)	5 - 30

DIMENSIONS

PEAD-RP100JAQ

Front View >



Rear View >

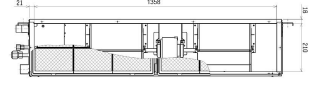

Upper View >

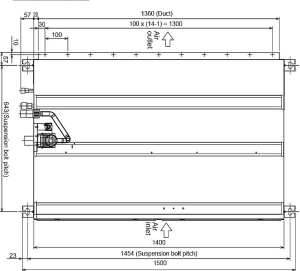

Side View >

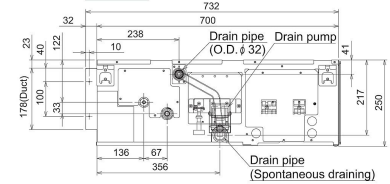

DIMENSIONS

PUHZ-ZRP100YKA

Upper View >

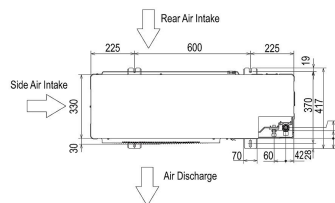

Front View >

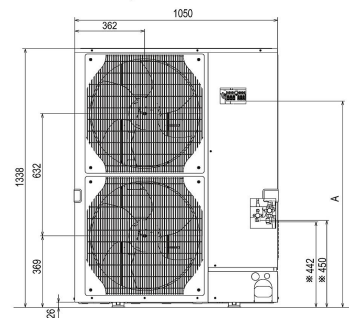

Right Side View >

