

March 2010
**No. OCS11
REVISED EDITION-B**
TECHNICAL DATA BOOK R410A INVERTER

 <Indoor unit>
[Model names]

PLA-RP-BA/BA2/BA3
PEAD-RP-JA(L)
PEAD-RP-EA(2)
PEAD-RP-GA
PKA-RP-HAL
PKA-RP-KAL
PKA-RP-GAL
PKA-RP-FAL(2)

Revision :

- PLA-RP-BA3, PKA-RP-HAL/KAL and PEAD-RP-JA(L) are added, and the data of PUAZ-HRP-HA2 has been modified in REVISED EDITION-B.
- Some descriptions have been modified.

- Please void OCS11 REVISED EDITION-A.

 <Outdoor unit>
[Model names]

PUHZ-HRP71/100VHA
PUHZ-HRP100/125YHA
PUHZ-HRP71/100VHA2
PUHZ-HRP100/125YHA2

CONTENTS

1. REFERENCE SERVICE MANUAL.....	2
2. SPECIFICATIONS	3
3. OUTLINES AND DIMENSIONS	12
4. WIRING DIAGRAM.....	24
5. REFRIGERANT SYSTEM DIAGRAM	36
6. PERFORMANCE CURVES	38
7. CORRECTION FACTORS.....	40
8. APPLICABLE EXTENSION PIPE FOR EACH MODEL	41
9. AIR FLOW DATA	44
10. NOISE CRITERION CURVES	60
11. OPTIONAL PARTS.....	74

Zubadan

For information on service, please refer to the service manual as follows.

1-1. INDOOR UNIT

Model Name	Service Ref.	Service Manual No.
PLA-RP35/50/60/100/125BA PLA-RP71/100/125BA2	PLA-RP35/50/60/100/125BA#2.UK PLA-RP71/100/125BA2.UK	OCH412 OCB412
PLA-RP100BA3	PLA-RP100BA3	OCH459 OCB459
PKA-RP35/50HAL	PKA-RP35/50HAL	OCH453 OCB453
PKA-RP60/100KAL	PKA-RP60/100KAL.TH	OCH452 OCB452
PEAD-RP35/50/60/71/100/125JA(L)	PEAD-RP35/50/60/71/100/125JA(L).UK	HWE08130 BWE08240
PKA-RP35/50GAL	PKA-RP35/50GAL#1	OC330
PKA-RP60/100FAL PKA-RP50FAL2	PKA-RP60/100FAL#1 PKA-RP50FAL2#1	OC331
PEAD-RP50/60/71/125EA PEAD-RP35/100EA2	PEAD-RP50/60/71/125EA#1.UK PEAD-RP35/100EA2#1.UK	HWE0521
PEAD-RP60/71/100GA	PEAD-RP60/71/100GA#1.UK	HWE0506

1-2. OUTDOOR UNIT

Model Name	Service Ref.	Service Manual No.
PUHZ-HRP71/100VHA PUHZ-HRP100/125YHA PUHZ-HRP71/100VHA2 PUHZ-HRP100/125YHA2	PUHZ-HRP71/100VHA PUHZ-HRP100/125YHA PUHZ-HRP71/100VHA2R1 PUHZ-HRP100/125YHA2R1	OCH425 OCB425

2-1. CEILING CASSETTE TYPE

Model name	Indoor unit		PLA-RP71BA2	PLA-RP100BA2	PLA-RP100BA3
	Outdoor unit		PUHZ-HRP71VHA2	PUHZ-HRP100VHA2	PUHZ-HRP100VHA2
Cooling	Capacity	Btu/h	24,200	34,100	34,100
		kW	7.1 (4.9 - 8.1)	10.0 (4.9 - 11.4)	10.0 (4.9 - 11.4)
	Total input	kW	1.94	2.44	2.44
	EER		3.66	4.10	4.10
	Energy label class		A	A	A
	SHF		0.73	0.74	0.74
Heating	Capacity	Btu/h	27,300	38,200	38,200
		kW	8.0 (4.5 - 10.2)	11.2 (4.5 - 14.0)	11.2 (4.5 - 14.0)
	Total input	kW	1.90	2.54	2.54
	COP		4.21	4.41	4.41
	Energy label class		A	A	A
	Booster heater	kW	-	-	-
Power supply	Phase	ϕ	1		
	Cycle	Hz	50		
	Voltage	V	230		
	Breaker size	A	32	40	40
Indoor unit	Air flow (Low-Medium2-Medium1-High)	CMM	14 - 16 - 18 - 21	20 - 23 - 26 - 30	20 - 23 - 26 - 30
		CFM	495 - 565 - 635 - 740	710 - 810 - 920 - 1060	710 - 810 - 920 - 1060
	External pressure	Pa	0		
	Sound level (Low-Medium2-Medium1-High)	dB(A)	28 - 30 - 32 - 34	32 - 34 - 37 - 40	32 - 34 - 37 - 40
	External finish (Panel)		White Munsell 6.4Y 8.9/0.4		
	Dimension Unit (Panel)	W : mm	840 (950)		
		D : mm	840 (950)		
		H : mm	258 (35)	298 (35)	298 (35)
		W : inch	33-1/16 (37-3/8)		
		D : inch	33-1/16 (37-3/8)		
		H : inch	10-3/16 (1-3/8)	11-3/4 (1-3/8)	11-3/4 (1-3/8)
	Weight	kg	23 (6)	27 (6)	26 (6)
	Unit (Panel)	lbs	51 (13)	60 (13)	57 (13)
Field drain pipe O.D.	mm	32			
	inch	1-1/4			
Outdoor unit	Air flow	CMM	100		
		CFM	3,530		
	Sound level at cooling	dB(A)	51		
	Sound level at heating	dB(A)	52		
	External finish		Ivory Munsell 3Y 7.8/1.1		
	Dimension	W : mm	950		
		D : mm	330+30		
		H : mm	1,350		
		W : inch	37-3/8		
		D : inch	13 + 1-3/16		
H : inch		53-1/8			
Weight	kg	120			
	lbs	265			
Refrigerant pipe size	Gas side O.D.	mm	15.88		
		inch	5/8		
	Liquid side O.D.	mm	9.52		
		inch	3/8		
Refrigerant pipe length	Height difference	m	Max. 30		
	Length	m	Max. 75		

- NOTE:** 1. Rating conditions (ISO T1)
Cooling Indoor : D.B. 27°C (80°F) W.B. 19°C (66°F) Outdoor : D.B. 35°C (95°F) W.B. 24°C (75°F)
Heating Indoor : D.B. 20°C (68°F) Outdoor : D.B. 7°C (45°F) W.B. 6°C (43°F)
Refrigerant piping length (one way) : 5m (16ft.)

2. Guaranteed operating range

		Indoor	Outdoor
Cooling	Upper limit	D.B. 32°C, W.B. 23°C	D.B. 46°C
	Lower limit	D.B. 19°C, W.B. 15°C	D.B. -5°C *
Heating	Upper limit	D.B. 28°C	D.B. 21°C, W.B. 15°C
	Lower limit	D.B. 17°C	D.B. -25°C, W.B. -25°C

3. Guaranteed voltage
198~264V, 50Hz

4. Above data are based on the indicated voltage.
Indoor unit Single phase 230V 50Hz
Outdoor unit Single phase 230V 50Hz

* If optional air protect guide is installed : D.B. -18°C



Model name	Indoor unit		PLA-RP100BA2	PLA-RP100BA3	PLA-RP125BA2
	Outdoor unit		PUHZ-HRP100YHA2	PUHZ-HRP100YHA2	PUHZ-HRP125YHA2
Cooling	Capacity	Btu/h	34,100	34,100	42,700
		kW	10.0 (4.9 - 11.4)	10.0 (4.9 - 11.4)	12.5 (5.5 - 14.0)
	Total input	kW	2.50	2.50	3.79
	EER		4.00	4.00	3.30
	Energy label class		A	A	A
	SHF		0.74	0.74	0.71
Heating	Capacity	Btu/h	38,200	38,200	47,800
		kW	11.2 (4.5 - 14.0)	11.2 (4.5 - 14.0)	14.0 (5.0 - 16.0)
	Total input	kW	2.60	2.60	3.57
	COP		4.31	4.31	3.92
	Energy label class		A	A	A
	Booster heater		kW	-	-
Power supply	Phase	φ	3		
	Cycle	Hz	50		
	Voltage	V	400		
	Breaker size	A	16		
Indoor unit	Air flow (Low-Medium2-Medium1-High)	CMM	20 - 23 - 26 - 30	20 - 23 - 26 - 30	22 - 25 - 28 - 31
		CFM	710 - 810 - 920 - 1060	710 - 810 - 920 - 1060	780 - 880 - 990 - 1090
	External pressure	Pa	0	0	0
	Sound level (Low-Medium2-Medium1-High)	dB(A)	32 - 34 - 37 - 40	32 - 34 - 37 - 40	34 - 36 - 39 - 41
	External finish (Panel)		White Munsell 6.4Y 8.9/0.4		
	Dimension Unit (Panel)	W : mm	840 (950)		
		D : mm	840 (950)		
		H : mm	298 (35)		
		W : inch	33-1/16 (37-3/8)		
		D : inch	33-1/16 (37-3/8)		
		H : inch	11-3/4 (1-3/8)		
	Weight Unit (Panel)	kg	27 (6)	26 (6)	27 (6)
		lbs	60 (13)	57 (13)	60 (13)
	Field drain pipe O.D.	mm	32		
inch		1-1/4			
Outdoor unit	Air flow	CMM	100		
		CFM	3,530		
	Sound level at cooling	dB(A)	51		
	Sound level at heating	dB(A)	52		
	External finish		Ivory Munsell 3Y 7.8/1.1		
	Dimension	W : mm	950		
		D : mm	330+30		
		H : mm	1,350		
		W : inch	37-3/8		
		D : inch	13 + 1-3/16		
		H : inch	53-1/8		
Weight	kg	134			
	lbs	295			
Refrigerant pipe size	Gas side O.D.	mm	15.88		
		inch	5/8		
	Liquid side O.D.	mm	9.52		
		inch	3/8		
Refrigerant pipe length	Height difference	m	Max. 30		
	Length	m	Max. 75		

NOTE: 1. Rating conditions (ISO T1)

Cooling Indoor : D.B. 27°C (80°F) W.B. 19°C (66°F) Outdoor : D.B. 35°C (95°F) W.B. 24°C (75°F)
 Heating Indoor : D.B. 20°C (68°F) Outdoor : D.B. 7°C (45°F) W.B. 6°C (43°F)

Refrigerant piping length (one way) : 5m (16ft.)

2. Guaranteed operating range

		Indoor	Outdoor
Cooling	Upper limit	D.B. 32°C, W.B. 23°C	D.B. 46°C
	Lower limit	D.B. 19°C, W.B. 15°C	D.B. -5°C *
Heating	Upper limit	D.B. 28°C	D.B. 21°C, W.B. 15°C
	Lower limit	D.B. 17°C	D.B. -25°C, W.B. -25°C

3. Guaranteed voltage

198~264V, 50Hz(HRP100, 125Y : 342~457V, 50Hz)

4. Above data are based on the indicated voltage.

Indoor unit Single phase 230V 50Hz

Outdoor unit 3 phase 400V 50Hz

* If optional air protect guide is installed : D.B. -18°C



Model name	Indoor unit		PLA-RP100BA	PLA-RP100BA	PLA-RP125BA
	Outdoor unit		PUHZ-HRP100VHA	PUHZ-HRP100YHA	PUHZ-HRP125YHA
Cooling	Capacity	Btu/h	34,100	34,100	42,700
		kW	10.0 (4.9 - 11.4)	10.0 (4.9 - 11.4)	12.5 (5.5 - 14.0)
	Total input	kW	3.02	3.02	3.87
	EER		3.31	3.31	3.23
	Energy label class		A	A	A
	SHF		0.74	0.74	0.71
Heating	Capacity	Btu/h	38,200	38,200	47,800
		kW	11.2 (4.5 - 14.0)	11.2 (4.5 - 14.0)	14.0 (5.0 - 16.0)
	Total input	kW	3.10	3.10	3.88
	COP		3.61	3.61	3.61
	Energy label class		A	A	A
	Booster heater	kW	-	-	-
Power supply	Phase	φ	1	3	
	Cycle	Hz	50	50	
	Voltage	V	230	400	
	Breaker size	A	32	16	
Indoor unit	Air flow (Low-Medium2-Medium1-High)	CMM	20 - 23 - 26 - 30		22 - 25 - 28 - 31
		CFM	710 - 810 - 920 - 1060		780 - 880 - 990 - 1090
	External pressure	Pa	0		0
	Sound level (Low-Medium2-Medium1-High)	dB(A)	32 - 34 - 37 - 40		34 - 36 - 39 - 41
	External finish (Panel)		White Munsell 6.4Y 8.9/0.4		
	Dimension Unit (Panel)	W : mm	840 (950)		
		D : mm	840 (950)		
		H : mm	298 (35)		
		W : inch	33-1/16 (37-3/8)		
		D : inch	33-1/16 (37-3/8)		
		H : inch	11-3/4 (1-3/8)		
	Weight	kg	25 (6)		
	Unit (Panel)	lbs	55 (13)		
	Field drain pipe O.D.	mm	32		
inch		1-1/4			
Outdoor unit	Air flow	CMM	100		
		CFM	3,530		
	Sound level at cooling	dB(A)	52		
	Sound level at heating	dB(A)	53		
	External finish		Ivory Munsell 3Y 7.8/1.1		
	Dimension	W : mm	950		
		D : mm	330+30		
		H : mm	1,350		
		W : inch	37-3/8		
		D : inch	13 + 1-3/16		
H : inch		53-1/8			
Weight	kg	120	134		
	lbs	265	295		
Refrigerant pipe size	Gas side O.D.	mm	15.88		
		inch	5/8		
	Liquid side O.D.	mm	9.52		
		inch	3/8		
Refrigerant pipe length	Height difference	m	Max. 30		
	Length	m	Max. 75		

NOTE: 1. Rating conditions (ISO T1)

Cooling Indoor : D.B. 27°C (80°F) W.B. 19°C (66°F) Outdoor : D.B. 35°C (95°F) W.B. 24°C (75°F)
 Heating Indoor : D.B. 20°C (68°F) Outdoor : D.B. 7°C (45°F) W.B. 6°C (43°F)
 Refrigerant piping length (one way) : 5m (16ft.)

2. Guaranteed operating range

		Indoor	Outdoor
Cooling	Upper limit	D.B. 32°C, W.B. 23°C	D.B. 46°C
	Lower limit	D.B. 19°C, W.B. 15°C	D.B. -5°C *
Heating	Upper limit	D.B. 28°C	D.B. 21°C, W.B. 15°C
	Lower limit	D.B. 17°C	D.B. -25°C, W.B. -25°C

3. Guaranteed voltage

198~264V, 50Hz(HRP100, 125Y : 342~457V, 50Hz)

4. Above data are based on the indicated voltage.

Indoor unit Single phase 230V 50Hz
 Outdoor unit V:Single phase 230V 50Hz, Y:3 phase 400V 50Hz

* If optional air protect guide is installed : D.B.-18°C

2-2. CEILING-CONCEALED TYPE

Model Name	Indoor Unit		PEAD-RP71JA(L)	PEAD-RP100JA(L)	PEAD-RP100JA(L)	PEAD-RP125JA(L)	
	Outdoor Unit		PUHZ-HRP71VHA2	PUHZ-HRP100VHA2	PUHZ-HRP100YHA2	PUHZ-HRP125YHA2	
Cooling	Capacity	Btu/h	24,200	34,100	34,100	42,700	
		kW	7.1 (3.3 - 8.1)	10.0 (4.9 - 11.4)	10.0 (4.9 - 11.4)	12.5 (5.5 - 14.0)	
	Total Input	kW	2.15 (2.13)	3.06 (3.04)	3.06 (3.04)	3.89 (3.87)	
	EER		3.30 (3.33)	3.27 (3.29)	3.27 (3.29)	3.21 (3.23)	
	Energy label class		A	A	A	A	
Heating	Capacity	Btu/h	27,300	38,200	38,200	47,800	
		kW	8.0 (3.5 - 10.2)	11.2 (4.5 - 14.0)	11.2 (4.5 - 14.0)	14.0 (5.0 - 16.0)	
	Total Input	kW	2.34	3.10	3.10	3.88	
	COP		3.42	3.61	3.61	3.61	
	Energy label class		B	A	A	A	
Power supply	Booster heater	kW	-	-	-	-	
	Phase	φ	1		3		
	Cycle	Hz	50		50		
	Voltage	V	230		400		
Indoor unit	Breaker size	A	32	40	16		
	Air flow (Low - Middle - High)	CMM	17.5 - 21 - 25	24 - 29 - 34	24 - 29 - 34	29.5 - 35.5 - 42	
		CFM	618 - 742 - 883	847 - 1,024 - 1,201	847 - 1,024 - 1,201	1,042 - 1,253 - 1,483	
	External pressure	Pa	35 / 50 / 70 / 100 / 150				
	Sound level (Low - Middle - High/50Pa)	dB(A)	26 - 30 - 34	29 - 34 - 38	29 - 34 - 38	33 - 36 - 40	
	External finish		Galvanized sheets				
	Dimension	W : mm	1,100	1,400			
		D : mm	732				
		H : mm	250				
		W : inch	43-5/16	55-1/8			
		D : inch	28-7/8				
Weight	H : inch	9-7/8					
	kg	33 (32)	41 (40)	41 (40)	43 (42)		
Field drain pipe O.D.	lbs	73 (71)	91 (89)	91 (89)	95 (93)		
	mm	32					
Outdoor Unit	Air flow	inch	1-1/4				
		CMM	100				
	CFM	3,530					
	Sound level at cooling	dB(A)	51				
	Sound level at heating	dB(A)	52				
	External finish		Ivory Munsell 3Y 7.8/1.1				
	Dimension	W : mm	950				
		D : mm	330 + 30				
		H : mm	1,350				
		W : inch	37-3/8				
		D : inch	13 + 1-3/16				
Weight	H : inch	53-1/8					
	kg	120	134				
Refrigerant pipe size	Gas side O.D.	lbs	265	295			
		mm	15.88				
	Liquid side O.D.	inch	5/8				
		mm	9.52				
Refrigerant pipe length	inch	3/8					
	Height difference	m	Max. 30				
	Length	m	Max. 75				

NOTE: 1. Rating conditions (ISO T1)

Cooling Indoor : D.B. 27°C (80°F) W.B. 19°C (66°F) Outdoor : D.B. 35°C (95°F) W.B. 24°C (75°F)

Heating Indoor : D.B. 20°C (68°F) Outdoor : D.B. 7°C (45°F) W.B. 6°C (43°F)

Refrigerant piping length (one way) : 5m (16ft.)

2. Guaranteed operating range

		Indoor	Outdoor
Cooling	Upper limit	D.B. 32°C, W.B. 23°C	D.B. 46°C
	Lower limit	D.B. 19°C, W.B. 15°C	D.B. -5°C *
Heating	Upper limit	D.B. 28°C	D.B. 21°C, W.B. 15°C
	Lower limit	D.B. 17°C	D.B. -25°C, W.B. -25°C

3. Guaranteed voltage

Indoor unit : 198 ~ 264V, 50Hz
Outdoor unit : 198 ~ 264V, 50Hz (V)
342 ~ 457V, 50Hz (Y)

4. Above data are based on the indicated voltage.

Indoor unit Single phase 230V 50Hz
Outdoor unit (V) Single phase 230V 50Hz
(Y) 3 phase 400V 50Hz

* If optional air protect guide is installed : D.B.-18°C



Model name	Indoor unit		PEAD-RP71EA	PEAD-RP100EA2	
	Outdoor unit		PUHZ-HRP71VHA PUHZ-HRP71VHA2	PUHZ-HRP100VHA PUHZ-HRP100VHA2	
Cooling	Capacity	Btu/h	24,200	34,100	
		kW	7.1 (4.9 - 8.1)	10.0 (4.9 - 11.4)	
	Total input	kW	2.15	3.06	
	EER		3.30	3.27	
	Energy label class		A	A	
	SHF		0.83	0.86	
Heating	Capacity	Btu/h	27,300	38,200	
		kW	8.0 (4.5 - 10.2)	11.2 (4.5 - 14.0)	
	Total input	kW	2.34	3.10	
	COP		3.42	3.61	
	Energy label class		B	A	
	Booster heater	kW	-	-	
Power supply	Phase	φ	1		
	Cycle	Hz	50		
	Voltage	V	230		
	Breaker size	A	32	32 (VHA)/ 40 (VHA2)	
Indoor unit	Air flow (Low-High)	CMM	20 - 25	33.5 - 42	
		CFM	706 - 883	1,183 - 1,483	
	External pressure	Pa	70	70	
	Sound level (Low-High)	dB(A)	37-41	44-50	
	External finish (Panel)		Galvanized sheets		
	Dimension Unit (Panel)	W : mm	1,175	1,415	
		D : mm	740		
		H : mm	325		
		W : inch	46-1/8	55-11/16	
		D : inch	29-1/8		
		H : inch	12-13/16		
	Weight	kg	44	65	
	Unit (Panel)	lbs	97	143	
Unit drain pipe		R1 (External thread)			
Outdoor unit	Air flow	CMM	100		
		CFM	3,530		
	Sound level at cooling	dB(A)	52 (VHA)/ 51 (VHA2)		
	Sound level at heating	dB(A)	53 (VHA)/ 52 (VHA2)		
	External finish		Ivory Munsell 3Y 7.8/1.1		
	Dimension	W : mm	950		
		D : mm	330+30		
		H : mm	1,350		
		W : inch	37-3/8		
		D : inch	13 + 1-3/16		
		H : inch	53-1/8		
Weight	kg	120			
	lbs	265			
Refrigerant pipe size	Gas side O.D.	mm	15.88		
		inch	5/8		
	Liquid side O.D.	mm	9.52		
		inch	3/8		
Refrigerant pipe length	Height difference	m	Max. 30		
	Length	m	Max. 75		

NOTE: 1. Rating conditions (ISO T1)
Cooling Indoor : D.B. 27°C (80°F) W.B. 19°C (66°F) Outdoor : D.B. 35°C (95°F) W.B. 24°C (75°F)
Heating Indoor : D.B. 20°C (68°F) Outdoor : D.B. 7°C (45°F) W.B. 6°C (43°F)
Refrigerant piping length (one way) : 5m (16ft.)

2. Guaranteed operating range

		Indoor	Outdoor
Cooling	Upper limit	D.B. 32°C, W.B. 23°C	D.B. 46°C
	Lower limit	D.B. 19°C, W.B. 15°C	D.B. -5°C *
Heating	Upper limit	D.B. 28°C	D.B. 21°C, W.B. 15°C
	Lower limit	D.B. 17°C	D.B. -25°C, W.B. -25°C

3. Guaranteed voltage
198~264V, 50Hz

4. Above data are based on the indicated voltage.
Indoor unit Single phase 230V 50Hz
Outdoor unit Single phase 230V 50Hz

* If optional air protect guide is installed : D.B.-18°C



Model name	Indoor unit		PEAD-RP100EA2	PEAD-RP125EA	
	Outdoor unit		PUHZ-HRP100YHA PUHZ-HRP100YHA2	PUHZ-HRP125YHA PUHZ-HRP125YHA2	
Cooling	Capacity	Btu/h	34,100	42,700	
		kW	10.0 (4.9 - 11.4)	12.5 (5.5 - 14.0)	
	Total input	kW	3.06	3.89	
	EER		3.27	3.21	
	Energy label class		A	A	
	SHF		0.86	0.82	
Heating	Capacity	Btu/h	38,200	47,800	
		kW	11.2 (4.5 - 14.0)	14.0 (5.0 - 16.0)	
	Total input	kW	3.10	3.88	
	COP		3.61	3.61	
	Energy label class		A	A	
	Booster heater	kW	-	-	
Power supply	Phase	ϕ	3		
	Cycle	Hz	50		
	Voltage	V	400		
	Breaker size	A	16		
Indoor unit	Air flow (Low-High)	CMM	33.5 - 42	33.5 - 42	
		CFM	1,183 - 1,483	1,183 - 1,483	
	External pressure	Pa	70	70	
	Sound level (Low-High)	dB(A)	44 - 50	44 - 50	
	External finish (Panel)		Galvanized sheets		
	Dimension Unit (Panel)	W : mm	1,415		
		D : mm	740		
		H : mm	325		
		W : inch	55-11/16		
		D : inch	29-1/8		
		H : inch	12-13/16		
	Weight Unit (Panel)	kg	65		
		lbs	143		
	Unit drain pipe		R1 (External thread)		
Outdoor unit	Air flow	CMM	100		
		CFM	3,530		
	Sound level at cooling	dB(A)	52 (YHA)/ 51 (YHA2)		
	Sound level at heating	dB(A)	53 (YHA)/ 52 (YHA2)		
	External finish		Ivory Munsell 3Y 7.8/1.1		
	Dimension	W : mm	950		
		D : mm	330+30		
		H : mm	1,350		
		W : inch	37-3/8		
		D : inch	13 + 1-3/16		
		H : inch	53-1/8		
	Weight	kg	134		
lbs		295			
Refrigerant pipe size	Gas side O.D.	mm	15.88		
		inch	5/8		
	Liquid side O.D.	mm	9.52		
		inch	3/8		
Refrigerant pipe length	Height difference	m	Max. 30		
	Length	m	Max. 75		

NOTE: 1. Rating conditions (ISO T1)
Cooling Indoor : D.B. 27°C (80°F) W.B. 19°C (66°F) Outdoor : D.B. 35°C (95°F) W.B. 24°C (75°F)
Heating Indoor : D.B. 20°C (68°F) Outdoor : D.B. 7°C (45°F) W.B. 6°C (43°F)
Refrigerant piping length (one way) : 5m (16ft.)

2. Guaranteed operating range

		Indoor	Outdoor
Cooling	Upper limit	D.B. 32°C, W.B. 23°C	D.B. 46°C
	Lower limit	D.B. 19°C, W.B. 15°C	D.B. -5°C *
Heating	Upper limit	D.B. 28°C	D.B. 21°C, W.B. 15°C
	Lower limit	D.B. 17°C	D.B. -25°C, W.B. -25°C

3. Guaranteed voltage

Indoor unit:198~264V, 50Hz Outdoor unit:342~457V, 50Hz

4. Above data are based on the indicated voltage.

Indoor unit Single phase 230V 50Hz

Outdoor unit 3 phase 400V 50Hz

* If optional air protect guide is installed : D.B.-18°C



Model name	Indoor unit		PEAD-RP71GA	PEAD-RP100GA	PEAD-RP100GA
	Outdoor unit		PUHZ-HRP71VHA PUHZ-HRP71VHA2	PUHZ-HRP100VHA PUHZ-HRP100VHA2	PUHZ-HRP100YHA PUHZ-HRP100YHA2
Cooling	Capacity	Btu/h	24,200	34,100	34,100
		kW	7.1 (4.9 - 8.1)	10.0 (4.9 - 11.4)	10.0 (4.9 - 11.4)
	Total input	kW	2.15	3.08	3.08
	EER		3.30	3.25	3.25
	Energy label class		A	A	A
	SHF		0.83	0.86	0.86
Heating	Capacity	Btu/h	27,300	38,200	38,200
		kW	8.0 (4.5 - 10.2)	11.2 (4.5 - 14.0)	11.2 (4.5 - 14.0)
	Total input	kW	2.34	3.28	3.28
	COP		3.42	3.41	3.41
	Energy label class		B	B	B
	Booster heater	kW	-	-	-
Power supply	Phase	φ	1		3
	Cycle	Hz	50		50
	Voltage	V	230		400
	Breaker size	A	32	32 (VHA)/ 40 (VHA2)	16
Indoor unit	Air flow (Low-High)	CMM	20-25	26.5-33	
		CFM	706-883	935-1,165	
	External pressure	Pa	10/50/70	10/50/70	
	Sound level (Low-High)	dB(A)	35-38/37-41/37-43	40-43/42-45/42-46	
	External finish (Panel)		Galvanized sheets		
	Dimension Unit (Panel)	W : mm	1,171	1,411	
		D : mm		740	
		H : mm		275	
		W : inch	46-1/8	55-9/16	
		D : inch		29-1/8	
		H : inch		10-13/16	
	Weight Unit (Panel)	kg	42	50	
		lbs	93	111	
Unit drain pipe	mm	R1 (External thread)			
	inch	1-1/4			
Outdoor unit	Air flow	CMM	100		
		CFM	3,530		
	Sound level at cooling	dB(A)	52 (VHA, YHA)/ 51 (VHA2, YHA2)		
	Sound level at heating	dB(A)	53 (VHA, YHA)/ 52 (VHA2, YHA2)		
	External finish		Ivory Munsell 3Y 7.8/1.1		
	Dimension	W : mm	950		
		D : mm	330+30		
		H : mm	1,350		
		W : inch	37-3/8		
		D : inch	13 + 1-3/16		
		H : inch	53-1/8		
Weight	kg	120	134		
	lbs	265	295		
Refrigerant pipe size	Gas side O.D.	mm	15.88		
		inch	5/8		
	Liquid side O.D.	mm	9.52		
		inch	3/8		
Refrigerant pipe length	Height difference	m	Max. 30		
	Length	m	Max. 75		

NOTE: 1. Rating conditions (ISO T1)
Cooling Indoor : D.B. 27°C (80°F) W.B. 19°C (66°F) Outdoor : D.B. 35°C (95°F) W.B. 24°C (75°F)
Heating Indoor : D.B. 20°C (68°F) Outdoor : D.B. 7°C (45°F) W.B. 6°C (43°F)
Refrigerant piping length (one way) : 5m (16ft.)

2. Guaranteed operating range

		Indoor	Outdoor
Cooling	Upper limit	D.B. 32°C, W.B. 23°C	D.B. 46°C
	Lower limit	D.B. 19°C, W.B. 15°C	D.B. -5°C *
Heating	Upper limit	D.B. 28°C	D.B. 21°C, W.B. 15°C
	Lower limit	D.B. 17°C	D.B. -25°C, W.B. -25°C

3. Guaranteed voltage

198~264V, 50Hz(HRP100Y : 342~457V, 50Hz)

4. Above data are based on the indicated voltage.

Indoor unit Single phase 230V 50Hz

Outdoor unit V:Single phase 230V 50Hz, Y:3 phase 400V 50Hz

* If optional air protect guide is installed : D.B.-18°C

2-3. WALL-MOUNTED TYPE

Model Name	Indoor Unit		PKA-RP100KAL		PKA-RP100KAL	
	Outdoor Unit		PUHZ-HRP100VHA2		PUHZ-HRP100YHA2	
Cooling	Capacity	Btu/h	34,100			
		kW	10.0 (4.9 - 11.4)			
	Total Input	kW	2.93			
	EER	3.41				
	Energy label class	A				
	SHF	0.73				
Heating	Capacity	Btu/h	38,200			
		kW	11.2 (4.5 - 14.0)			
	Total Input	kW	3.10			
	COP	3.61				
	Energy label class	A				
	Booster heater	kW	-			
Power supply	Phase	ϕ	1	3		
	Cycle	Hz	50	50		
	Voltage	V	230	400		
	Breaker size	A	40	16		
Indoor unit	Air flow (Low - Middle - High)	CMM	20 - 23 - 26			
		CFM	705 - 810 - 920			
	External pressure	Pa	0			
	Sound level (Low - Middle - High/50Pa)	dB(A)	41 - 45 - 49			
	External finish	Munsell 1.0Y 9.2/0.2				
	Dimension	W : mm	1,170			
		D : mm	295			
		H : mm	365			
		W : inch	46-1/16			
		D : inch	11-5/8			
		H : inch	14-3/8			
	Weight	kg	21			
		lbs	46			
Field drain pipe O.D.	mm	16				
	inch	5/8				
Outdoor Unit	Air flow	CMM	100			
		CFM	3,530			
	Sound level at cooling	dB(A)	51			
	Sound level at heating	dB(A)	52			
	External finish	Ivory Munsell 3Y 7.8/1.1				
	Dimension	W : mm	950			
		D : mm	330 + 30			
		H : mm	1,350			
		W : inch	37-3/8			
		D : inch	13 + 1-3/16			
		H : inch	53-1/8			
	Weight	kg	120	134		
		lbs	265	295		
Refrigerant pipe size	Gas side O.D.	mm	15.88			
		inch	5/8			
	Liquid side O.D.	mm	9.52			
		inch	3/8			
Refrigerant pipe length	Height difference	m	Max. 30			
	Length	m	MAx. 75			

NOTE: 1. Rating conditions (ISO T1)

Cooling Indoor : D.B. 27°C (80°F) W.B. 19°C (66°F) Outdoor : D.B. 35°C (95°F) W.B. 24°C (75°F)

Heating Indoor : D.B. 20°C (68°F) Outdoor : D.B. 7°C (45°F) W.B. 6°C (43°F)

Refrigerant piping length (one way) : 5m (16ft.)

2. Guaranteed operating range

		Indoor		Outdoor	
Cooling	Upper limit	D.B. 35°C, W.B. 22.5°C		D.B. 46°C	
	Lower limit	D.B. 19°C, W.B. 15°C		D.B. -5°C ※1	
Heating	Upper limit	D.B. 28°C		D.B. 21°C, W.B. 15°C	
	Lower limit	D.B. 17°C		D.B. -15°C, W.B. -15°C	

3. Guaranteed voltage
198~264V, 50Hz (V) / 342~457V, 50Hz (Y)

4. Above data are based on the indicated voltage.

Indoor unit Single phase 230V 50Hz

Outdoor unit V : Single phase 230V 50Hz

Y : 3 phase 400V 50Hz

※1. If optional air protect guide is installed : D.B.-15°C



Model name	Indoor unit		PKA-RP100FAL	PKA-RP100FAL	
	Outdoor unit		PUHZ-HRP100VHA PUHZ-HRP100VHA2	PUHZ-HRP100YHA PUHZ-HRP100YHA2	
Cooling	Capacity	Btu/h	34,100	34,100	
		kW	10.0 (4.9 - 11.4)	10.0 (4.9 - 11.4)	
	Total input	kW	2.93	2.93	
	EER		3.41	3.41	
	Energy label class		A	A	
	SHF		0.77	0.77	
Heating	Capacity	Btu/h	38,200	38,200	
		kW	11.2 (4.5 - 14.0)	11.2 (4.5 - 14.0)	
	Total input	kW	3.10	3.10	
	COP		3.61	3.61	
	Energy label class		A	A	
	Booster heater	kW	-	-	
Power supply	Phase	φ	1	3	
	Cycle	Hz	50	50	
	Voltage	V	230	400	
	Breaker size	A	32 (VHA)/ 40 (VHA2)	16	
Indoor unit	Air flow (Low-High)	CMM	22 - 28		
		CFM	780 - 990		
	External pressure	Pa	0		
	Sound level (Low-High)	dB(A)	41 - 46		
	External finish (Panel)		White Munsell 3.4Y 7.7/0.8		
	Dimension Unit (Panel)	W : mm	1680		
		D : mm	235		
		H : mm	340		
		W : inch	66-1/8		
		D : inch	9-1/4		
		H : inch	13-3/8		
	Weight Unit (Panel)	kg	28		
		lbs	62		
Field drain pipe I.D.	mm	20			
	inch	13/16			
Outdoor unit	Air flow	CMM	100		
		CFM	3,530		
	Sound level at cooling	dB(A)	52 (VHA, YHA)/ 51 (VHA2, YHA2)		
	Sound level at heating	dB(A)	53 (VHA, YHA)/ 52 (VHA2, YHA2)		
	External finish		Ivory Munsell 3Y 7.8/1.1		
	Dimension	W : mm	950		
		D : mm	330+30		
		H : mm	1,350		
		W : inch	37-3/8		
		D : inch	13 + 1-3/16		
		H : inch	53-1/8		
Weight	kg	120	134		
	lbs	265	295		
Refrigerant pipe size	Gas side O.D.	mm	15.88		
		inch	5/8		
	Liquid side O.D.	mm	9.52		
		inch	3/8		
Refrigerant pipe length	Height difference	m	Max. 30		
	Length	m	Max. 75		

NOTE: 1. Rating conditions (ISO T1)
Cooling Indoor : D.B. 27°C (80°F) W.B. 19°C (66°F) Outdoor : D.B. 35°C (95°F) W.B. 24°C (75°F)
Heating Indoor : D.B. 20°C (68°F) Outdoor : D.B. 7°C (45°F) W.B. 6°C (43°F)
Refrigerant piping length (one way) : 5m (16ft.)

2. Guaranteed operating range

		Indoor	Outdoor
Cooling	Upper limit	D.B. 32°C, W.B. 23°C	D.B. 46°C
	Lower limit	D.B. 19°C, W.B. 15°C	D.B. -5°C *
Heating	Upper limit	D.B. 28°C	D.B. 21°C, W.B. 15°C
	Lower limit	D.B. 17°C	D.B. -25°C, W.B. -25°C

3. Guaranteed voltage

198~264V, 50Hz(HRP100Y : 342~457V, 50Hz)

4. Above data are based on the indicated voltage.

Indoor unit Single phase 230V 50Hz

Outdoor unit V:Single phase 230V 50Hz, Y:3 phase 400V 50Hz

* If optional air protect guide is installed : D.B.-18°C

INDOOR UNIT

PLA-RP35BA
PLA-RP71BA2

PLA-RP50BA
PLA-RP100BA2

PLA-RP60BA
PLA-RP100BA3

PLA-RP71BA
PLA-RP125BA2

PLA-RP100BA

PLA-RP125BA

Unit : mm

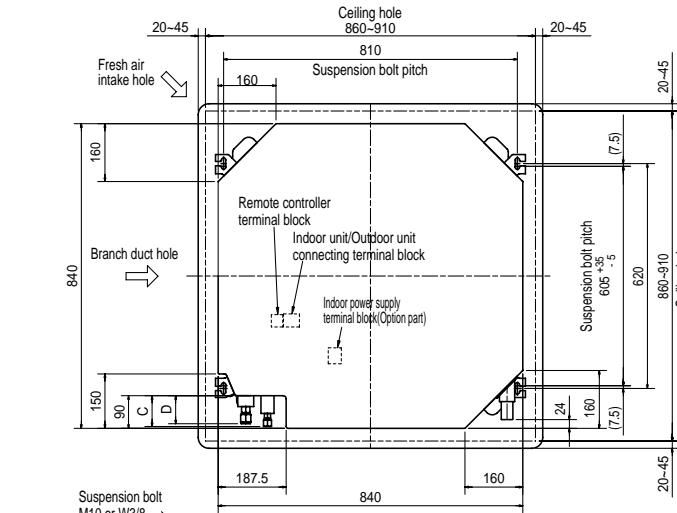

Detail connecting of Branch duct(Both aspects)

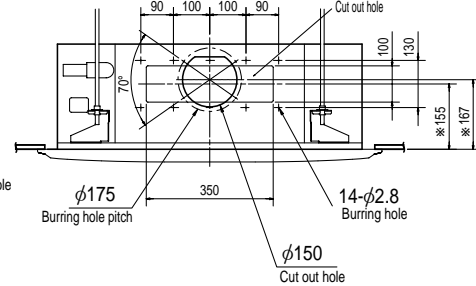

Detail drawing of fresh air intake hole

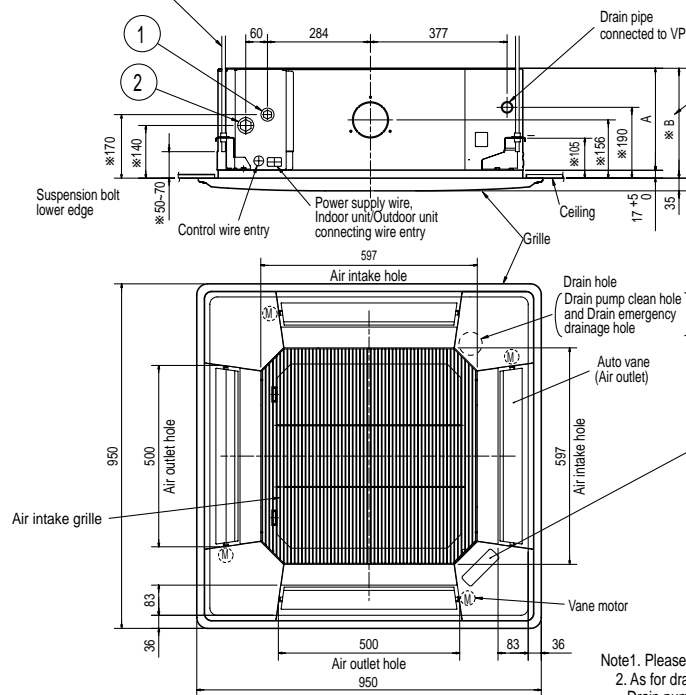
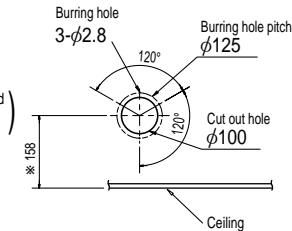

In case of standard grille : PLP-6BA / PLP-6BAMD



In case of Auto-Grille : PLP-6BAJ

In case of wireless remote controller : PLP-6BALM

Emergency operation switch<Cooling>and
Emergency Up/Down switch<Up>
Emergency operation switch<Heating>and
Emergency Up/Down switch<Down>

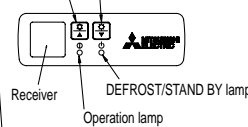

Auto Grille
Air intake grille up/down discharge

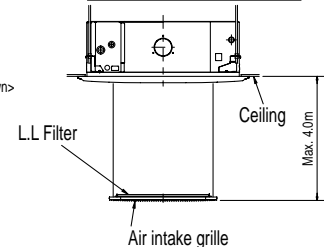

Note1. Please choose the Grille from a standard grille, Auto-Grille.

- As for drain pipe, please use VP-25(O.D. φ32 PVC TUBE).
Drain pump is included.
Raise is max 850mm from the ceiling.
- As for suspension bolt, please use M10 or W3/8.
(Procured at local site)
- Electrical box may be removed for the service purpose.
Make sure to slack the electrical wire little bit for control/ power wires connection.
- The height of the indoor unit is able to be adjusted with the grille attached.
- For the installation of the optional high efficiency filter or optional multi-functional casement.
 - Requires E or more space between transom and ceiling for the installation.
 - Add 135 mm to the dimensions * marked on the figure.
 - The optional high efficiency filter must be used jointly with optional multi-functional casement.
- When installing the branch ducts, be sure to insulate adequately.
Otherwise condensation and dripping may occur.
(It becomes the cause of dew drops/Water dew.)
- As for necessary installation/service space, please refer to left figure.

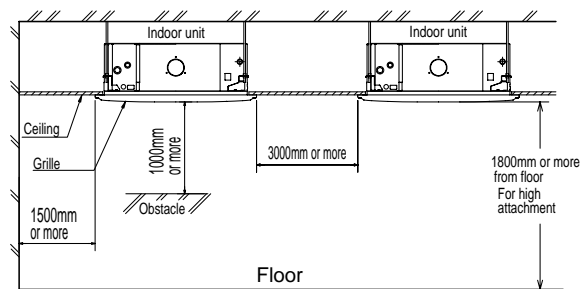

Models	①	②	A	B	C	D	E
PLA-RP35/50BA	Refrigerant pipe ...φ6.35 Flared connection ...1/4F	Refrigerant pipe ...φ12.7 Flared connection ...1/2F			80		
PLA-RP60BA	Refrigerant pipe φ6.35 / φ9.52 Flared connection 1/4F / 3/8F (compatible)		241	258	87		400
PLA-RP71BA,BA2	Refrigerant pipe ...φ9.52 Flared connection ...3/8F	Refrigerant pipe ...φ15.88 Flared connection ...5/8F			85	77	
PLA-RP100,125BA PLA-RP100BA3 PLA-RP100,125,140BA2			281	298			440

PEAD-RP35, 50, 60, 71, 100, 125JA

Unit : mm

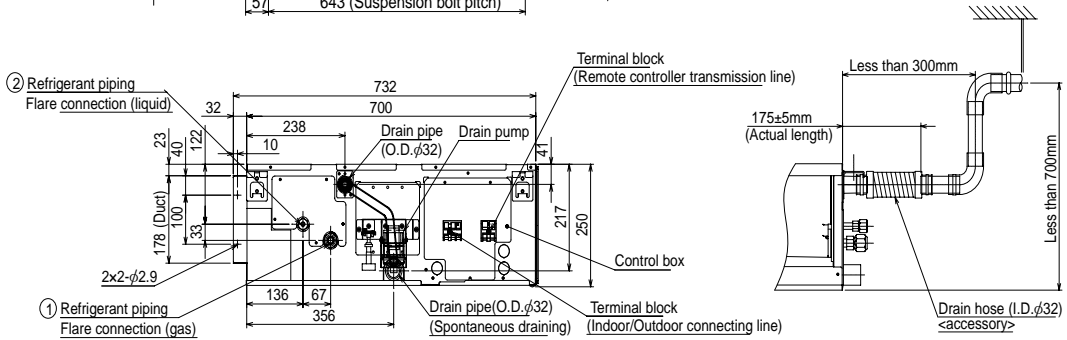
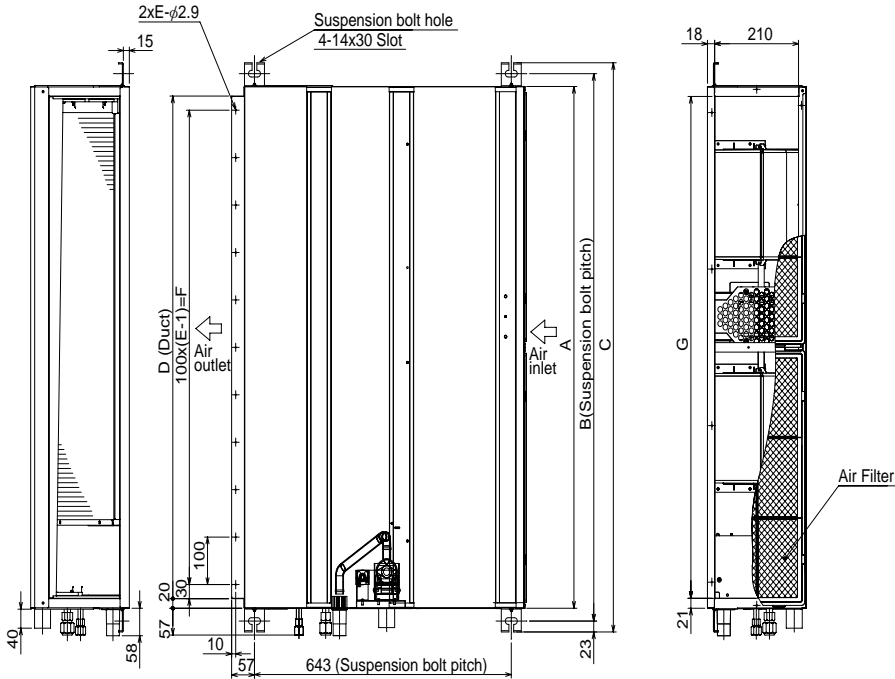

- NOTE 1. Use M10 screw for the Suspension bolt (field supply).
 2. Keep the service space for the maintenance at the bottom.
 3. This chart indicates for PEAD-RP60*71*100*125*140JA models, which have 2 fans. PEAD-RP35*50JA models have 1 fan.
 4. In case of the inlet duct is used, remove the air filter (supply with the unit), then install the filter (field supply) at suction side.

Model	A	B	C	D	E	F	G	① Gas pipe	② Liquid pipe
PEAD-RP35,50JA	900	954	1000	860	9	800	858	φ 12.7	φ 6.35
PEAD-RP60,71JA	1100	1154	1200	1060	11	1000	1058	φ 15.88	φ 9.52
PEAD-RP100,125JA	1400	1454	1500	1360	14	1300	1358		
PEAD-RP140JA	1600	1654	1700	1560	16	1500	1558		

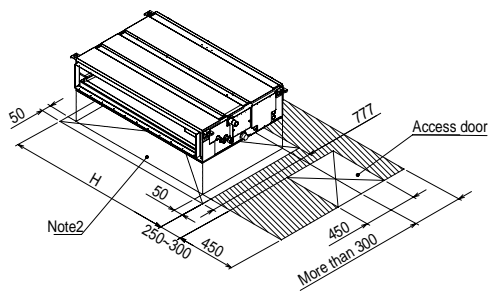
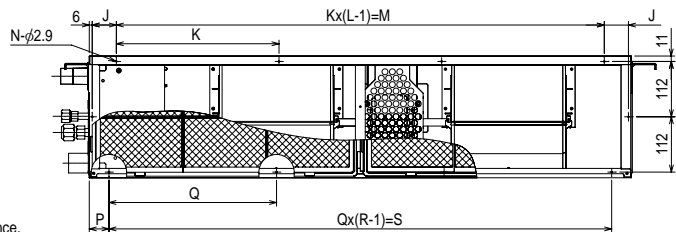
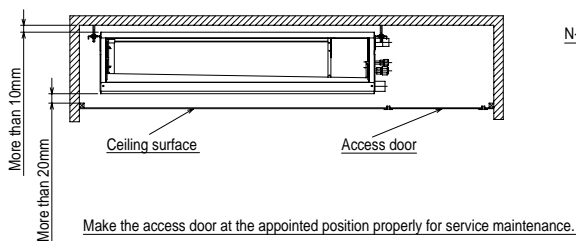

Model	H	J	K	L	M	N	P	Q	R	S
PEAD-RP35,50JA	1000	54	260	4	780	10	40.5	273	4	819
PEAD-RP60,71JA	1200	49	330	4	990	10	40	340	4	1020
PEAD-RP100,125JA	1500	54	320	5	1280	12	40	330	5	1320
PEAD-RP140JA	1700	54	370	5	1480	12	40	380	5	1520

Required space for service and maintenance

PEAD-RP35, 50, 60, 71, 100, 125JAL

Unit : mm

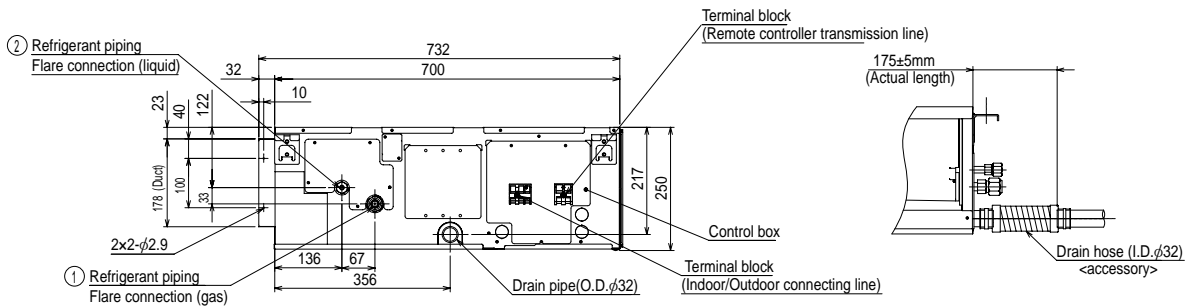
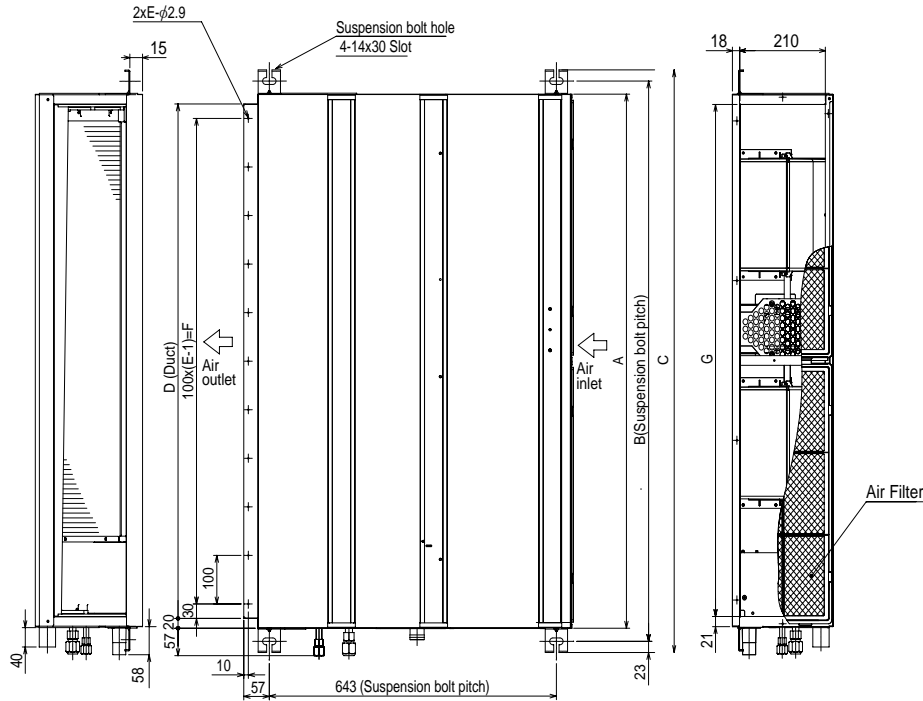

- NOTE 1. Use M10 screw for the Suspension bolt (field supply).
 2. Keep the service space for the maintenance at the bottom.
 3. This chart indicates for PEAD-RP60*71*100*125*140JAL models, which have 2 fans. PEAD-RP35*50JAL models have 1 fan.
 4. In case of the inlet duct is used, remove the air filter (supply with the unit), then install the filter (field supply) at suction side.

Model	A	B	C	D	E	F	G	①Gas pipe	②Liquid pipe
PEAD-RP35,50JAL	900	954	1000	860	9	800	858	φ 12.7	φ 6.35
PEAD-RP60,71JAL	1100	1154	1200	1060	11	1000	1058		
PEAD-RP100,125JAL	1400	1454	1500	1360	14	1300	1358	φ 15.88	φ 9.52
PEAD-RP140JAL	1600	1654	1700	1560	16	1500	1558		

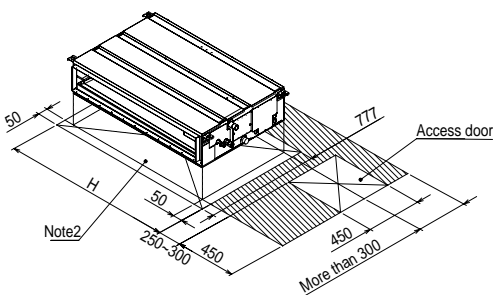
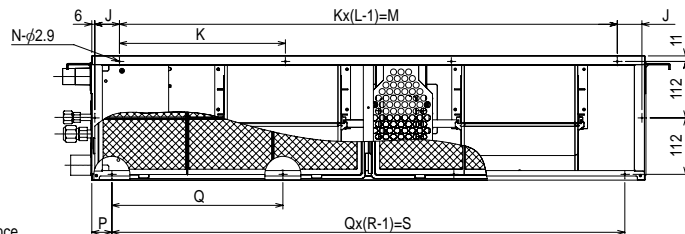
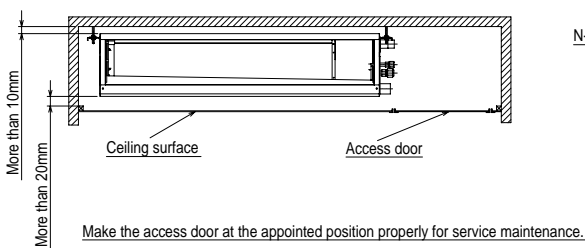

Model	H	J	K	L	M	N	P	Q	R	S
PEAD-RP35,50JAL	1000	54	260	4	780	10	40.5	273	4	819
PEAD-RP60,71JAL	1200	49	330	4	990	10	40	340	4	1020
PEAD-RP100,125JAL	1500	54	320	5	1280	12	40	330	5	1320
PEAD-RP140JAL	1700	54	370	5	1480	12	40	380	5	1520

Required space for service and maintenance

PEAD-RP35EA2 PEAD-RP50EA PEAD-RP60EA

Unit : mm

Model	A	B	C	D	E	F	G
RP35,50	772	305	-	830	804	R410A Outdoor unit : 6.35 * R407C Outdoor unit : 9.52	R410A Outdoor unit : 12.7 * R407C Outdoor unit : 15.88
RP60	1012	280	290	1070	1044	Outdoor unit (SUZ) : 6.35 R407C Outdoor unit : 9.52 *	15.88

* Initial setting

- ① Refrigerant piping flare connection (liquid ϕ F copper tube):HP
- ② Refrigerant piping flare connection (gas ϕ G copper tube):LP
- ③ Drain R1 (External thread)
- ④ Electrical parts box
- ⑤ Drain Pump (Option)
- ⑥ Drain Pipe (Option) ... Flexible joint VP-25(I.D. ϕ 32)
- ⑦ Filter

Set

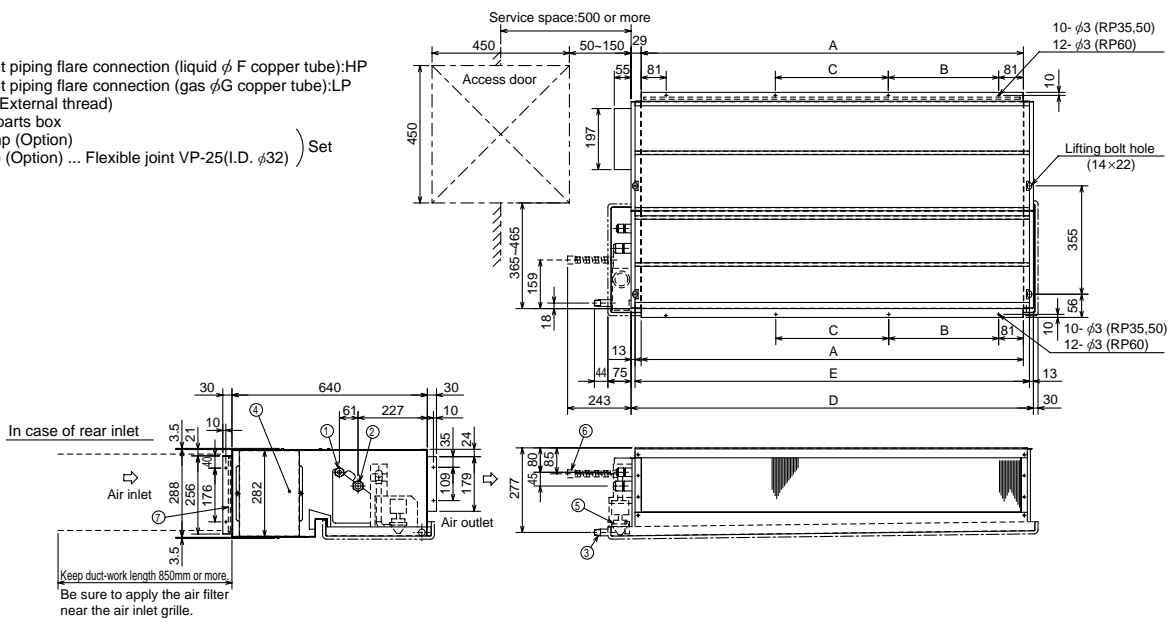

PEAD-RP71EA PEAD-RP100EA2 PEAD-RP125EA

Model	A	B	C	D	E	F
RP71	1012	280	290	1070	1044	15.88
RP100,125	1252	360	370	1310	1284	R410A Outdoor unit : 15.88 * R407C outdoor unit : 19.05

* Initial setting

- ① Refrigerant piping flare connection (liquid ϕ 9.52 copper tube):HP
- ② Refrigerant piping flare connection (gas ϕ F copper tube):LP
- ③ Drain R1 (External thread)
- ④ Electrical parts box
- ⑤ Drain Pump (Option)
- ⑥ Drain Pipe (Option) ... Flexible joint VP25(I.D. ϕ 32)
- ⑦ Filter

Set

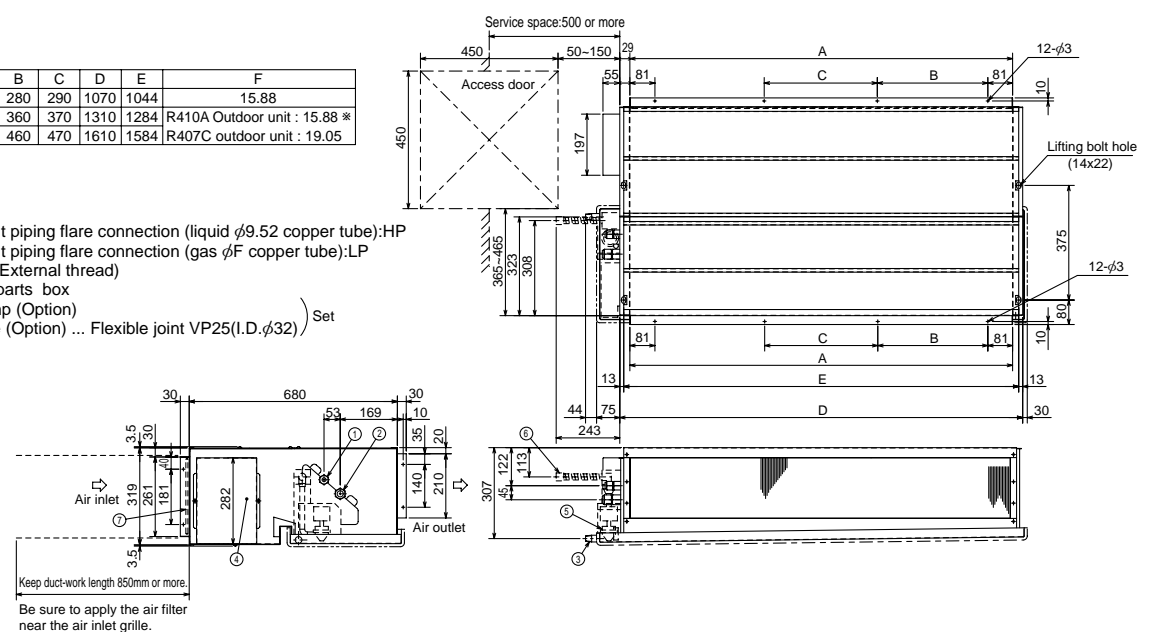

PEAD-RP60GA
PEAD-RP71GA
PEAD-RP100GA

Unit : mm

- ① Refrigerant piping flare connection(liquid øH copper tube): HP
- ② Refrigerant piping flare connection(gas ø J copper tube): LP
- ③ Electrical parts box *
- ④ Terminal bed : Power source
- ⑤ Terminal bed : Remote control
- ⑥ Filter
- ⑦ Drain pan (R1 External thread: ø34) (*:Fixable to opposition side.)

* NOTE: IT IS NECESSARY TO REMOVE THE CEILING PARTS OR TO KEEP THE MAINTENANCE HOLE OF OVER UNIT SIZE WHEN YOU HAVE A MAINTENANCE OR SERVICE THE FOLLOWING PARTS.
 SERVICE: MOTOR, SIROCCO FAN, HEAT EXCHANGER, DRAIN PAN
 (EXCHANGE) FILTER (IN CASE OF INDOOR UNIT HAVE INLET DUCT.)
 MAINTENANCE: HEAT EXCHANGER, DRAIN PAN (SURFACE WASHING)
 (WASHING) FILTER (IN CASE OF INDOOR UNIT HAVE INLET DUCT.)

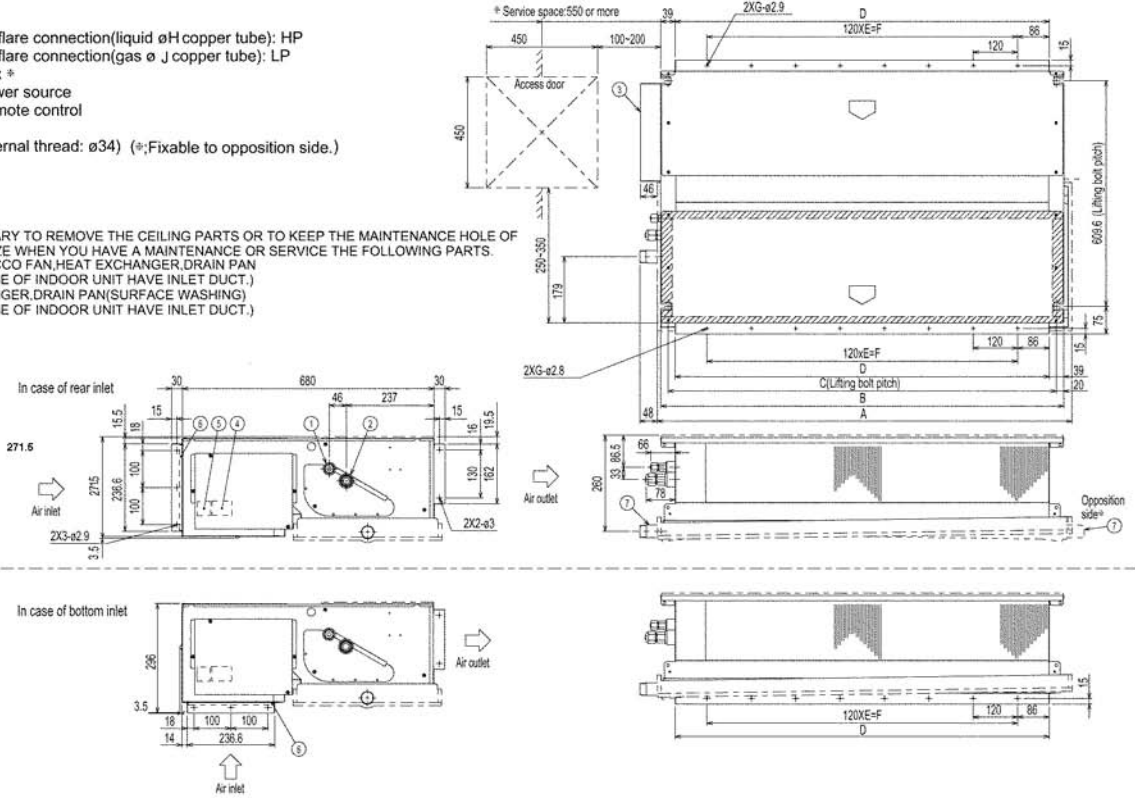

Model	A	B	C	D	E	F	G	H	J
RP60	1125	1090	1050	1012	7	840	8	Outdoor unit(SUZ) : 6.35 Other outdoor unit : 9.52 *	15.88
RP71	1125	1090	1050	1012	7	840	8	9.52	15.88
RP100	1365	1330	1290	1252	9	1080	10	9.52	R410A Outdoor unit : 15.88 * R407C Outdoor unit : 19.05

* Initial setting

**PKA-RP35HAL
PKA-RP50HAL**

Unit : mm

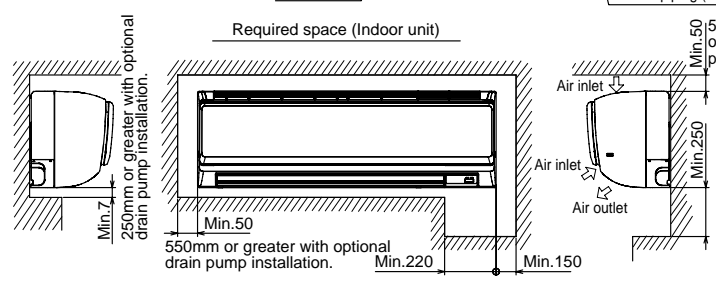
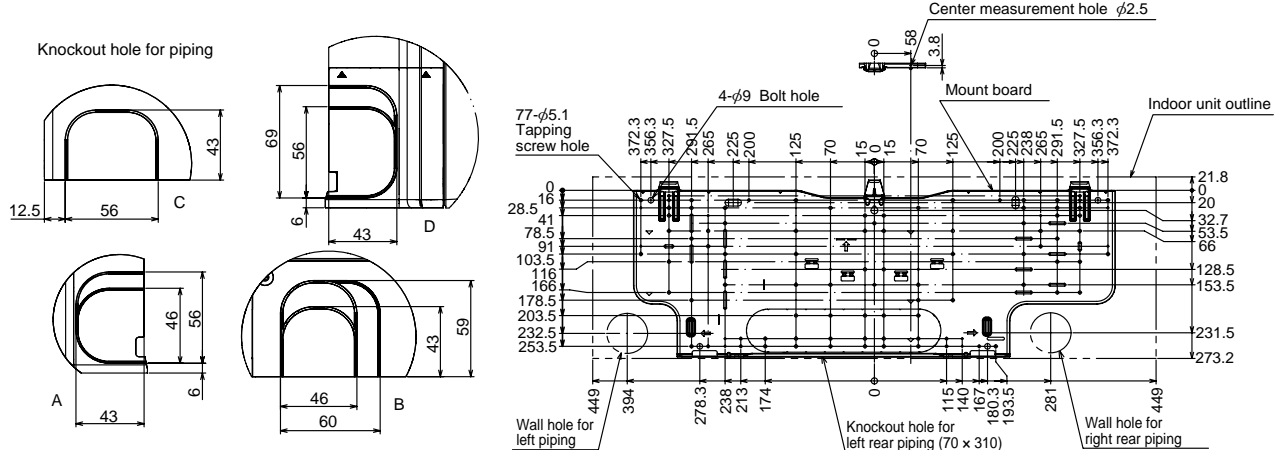
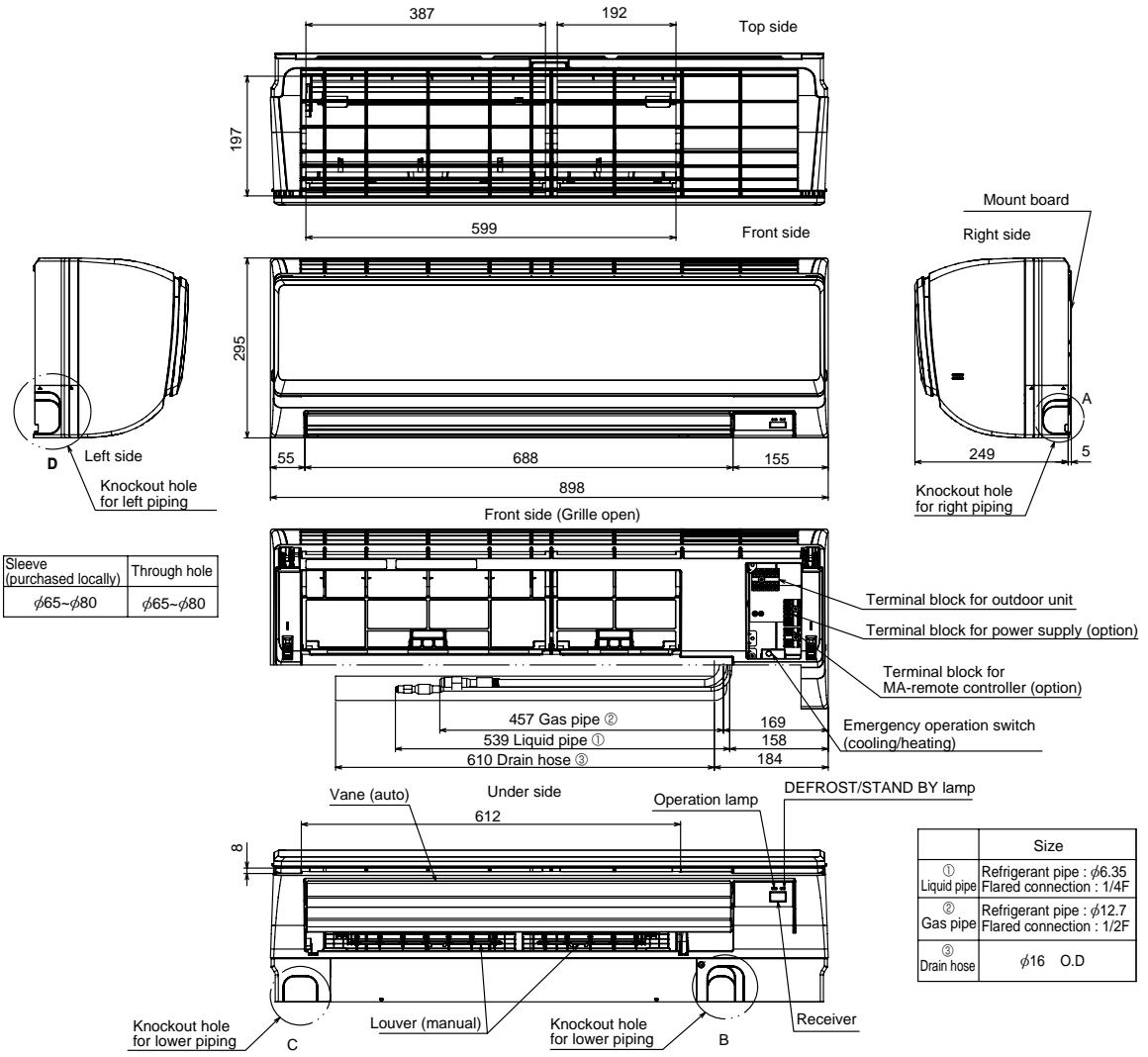

PKA-RP60KAL
PKA-RP100KAL

Unit : mm

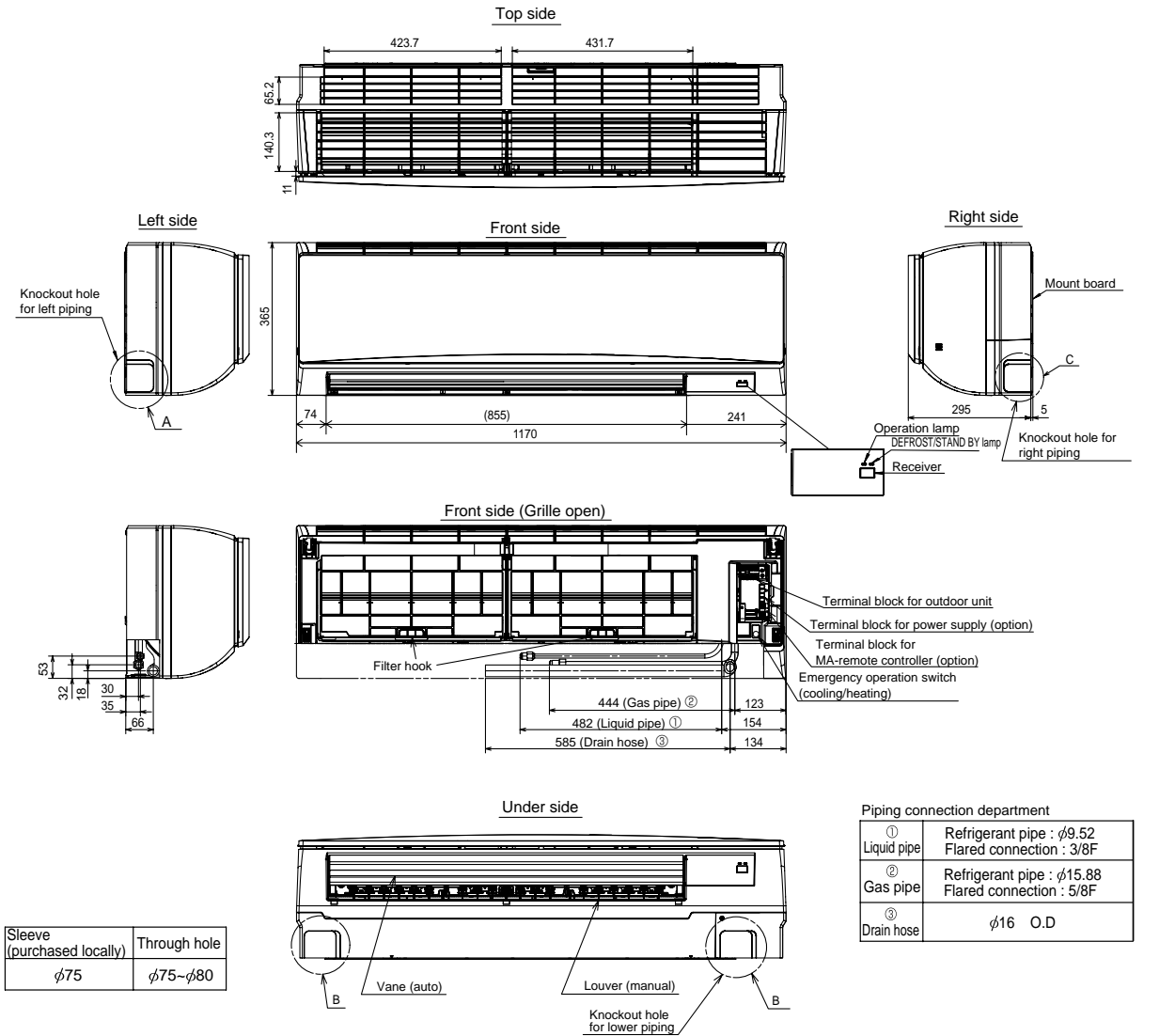

Sleeve (purchased locally)	Through hole
φ75	φ75~φ80

Piping connection department

① Liquid pipe	Refrigerant pipe : φ9.52 Flared connection : 3/8F
② Gas pipe	Refrigerant pipe : φ15.88 Flared connection : 5/8F
③ Drain hose	φ16 O.D

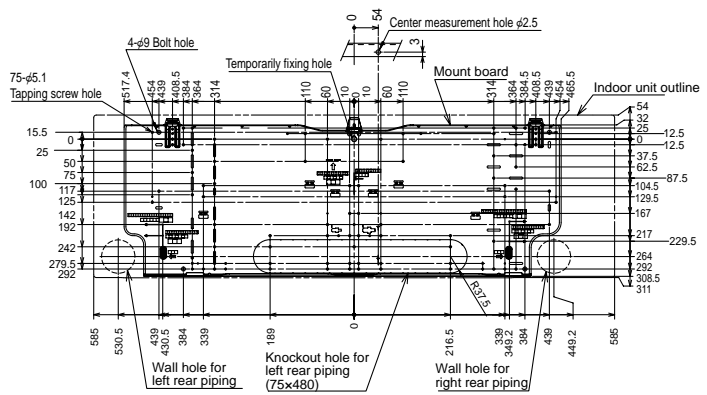
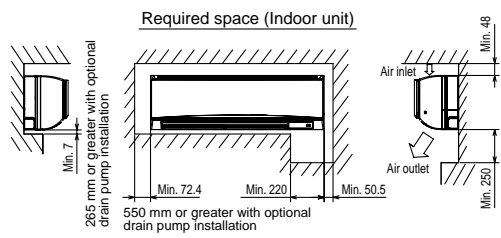
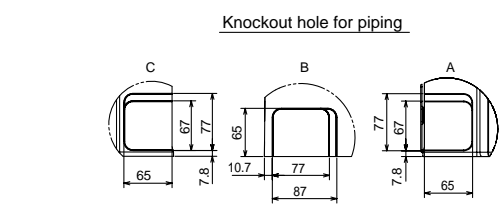

PKA-RP35GAL PKA-RP50GAL

Unit : mm

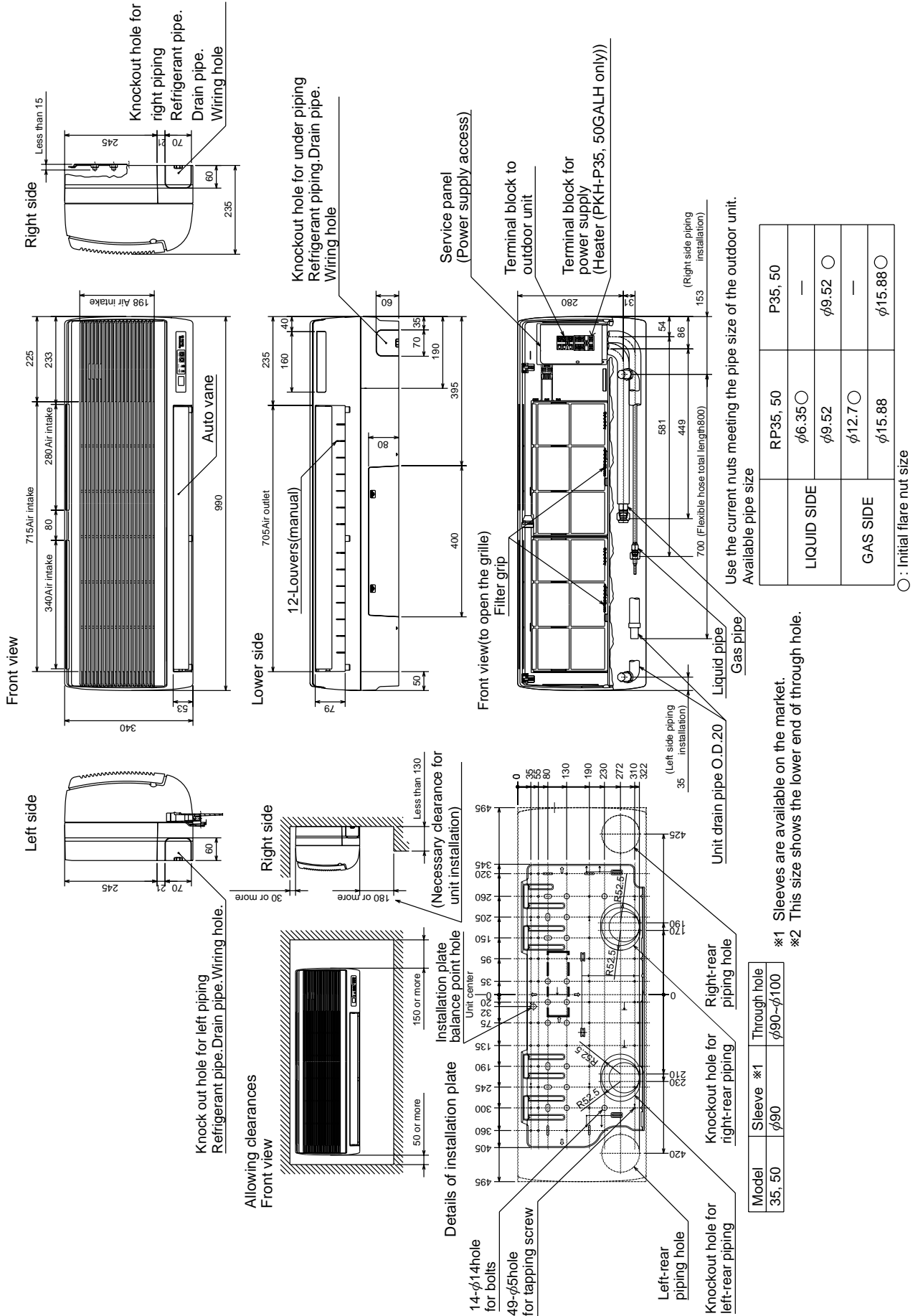

Available pipe size	RP35, 50	P35, 50
LIQUID SIDE	φ6.35○ φ9.52	— φ9.52 ○
GAS SIDE	φ12.7○ φ15.88	— φ15.88○

○ : Initial flare nut size

*1 Sleeves are available on the market.
 *2 This size shows the lower end of through hole.

Model	Sleeve *1	Through hole
35, 50	φ90	φ90~φ100

PKA-RP50FAL2
PKA-RP60FAL

Unit : mm

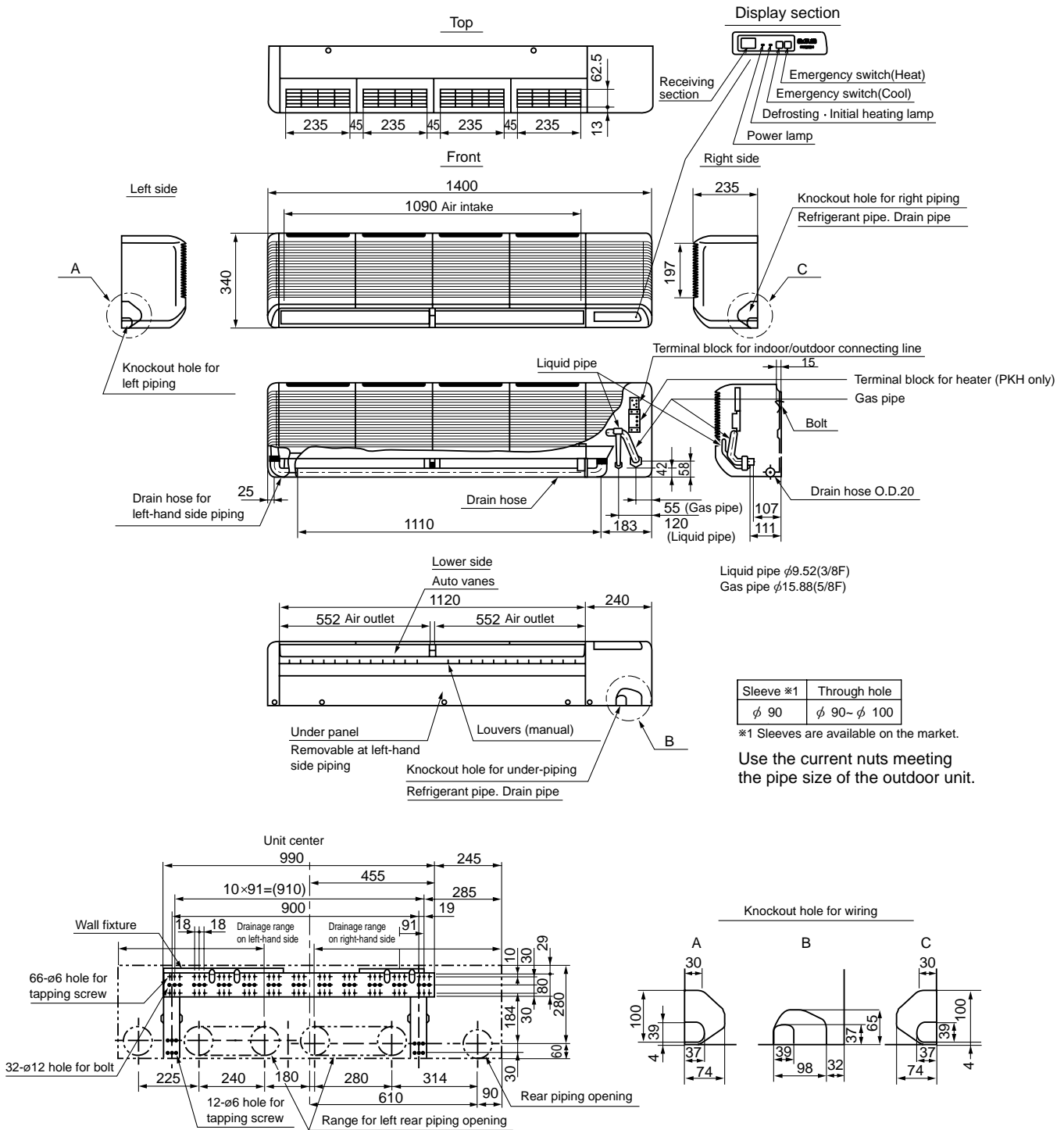

Available pipe size

	RP50	RP60,71 / P60,71
LIQUID SIDE	$\phi 6.35$ ○	—
	$\phi 9.52$	$\phi 9.52$ ○
GAS SIDE	$\phi 12.7$ ○	—
	$\phi 15.88$	$\phi 15.88$ ○

○ : Initial flare nut size

PKA-RP100FAL

Unit : mm

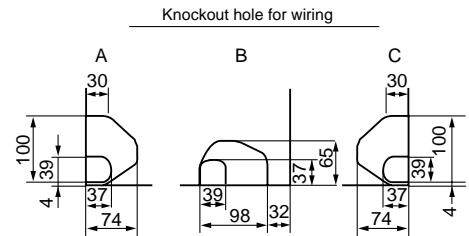
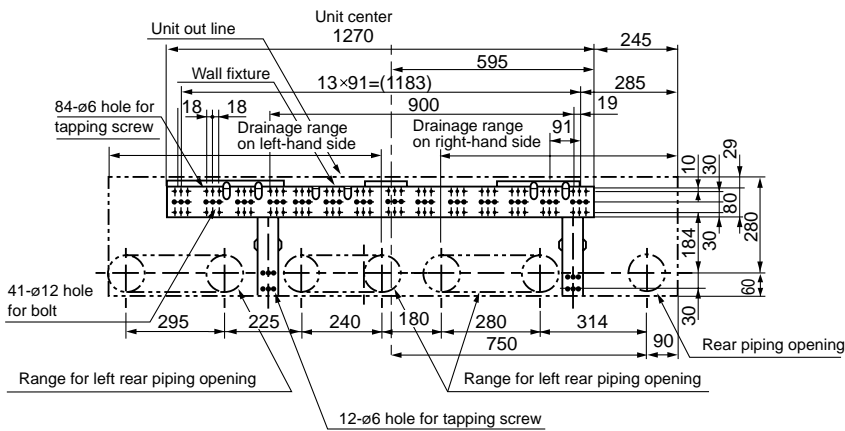
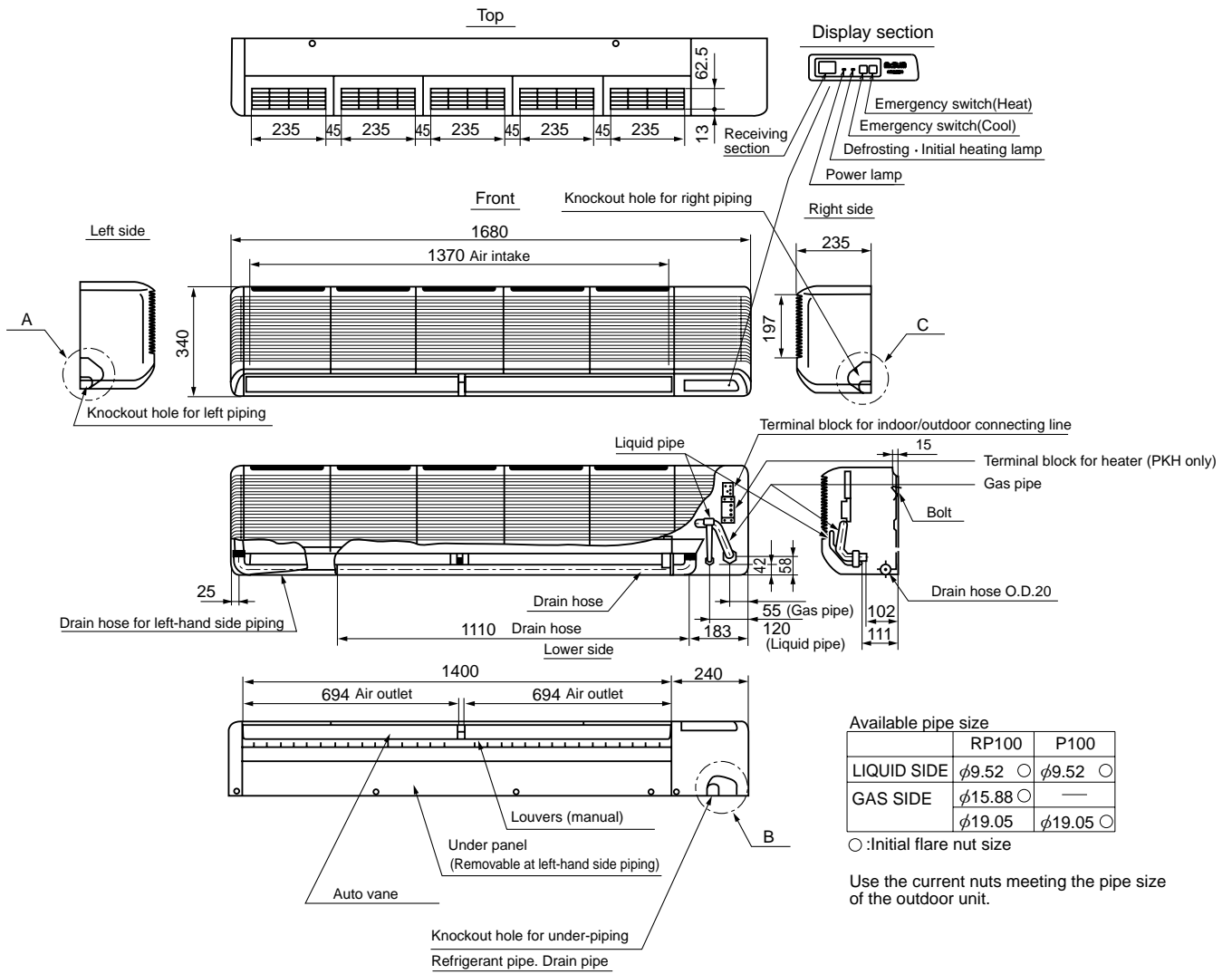

OUTDOOR UNIT
PUHZ-HRP71VHA
PUHZ-HRP100VHA
PUHZ-HRP100YHA
PUHZ-HRP125YHA

Unit : mm

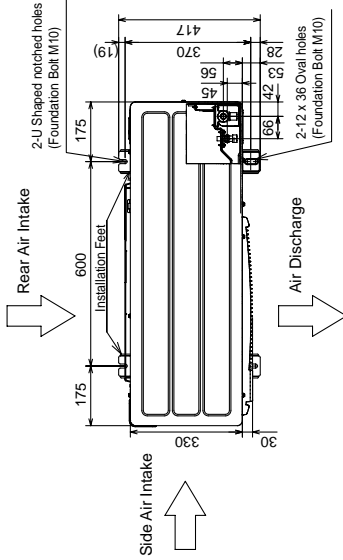

4 PIPING-WIRING DIRECTIONS

Piping and wiring connections can be made from 4 directions: front, right, rear and below.

3 FOUNDATION BOLTS

Please secure the unit firmly with 4 foundation (M10) bolts. (Bolts and washers must be purchased locally.)

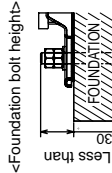

2 SERVICE SPACE

Dimensions of space needed for service access are shown in the below diagram.

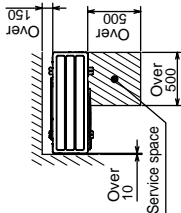

1 FREE SPACE (Around the unit)

The diagram below shows a basic example. Explanation of particular details are given in the installation manuals etc.

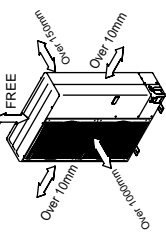

Example of Notes

- ①...Refrigerant GAS pipe connection (FLARE)φ15.88(5/8 inch)
- ②...Refrigerant LIQUID pipe connection (FLARE)φ9.52(3/8 inch)
- *1 ...Indication of STOP VALVE connection location.

Piping Knockout Hole Details

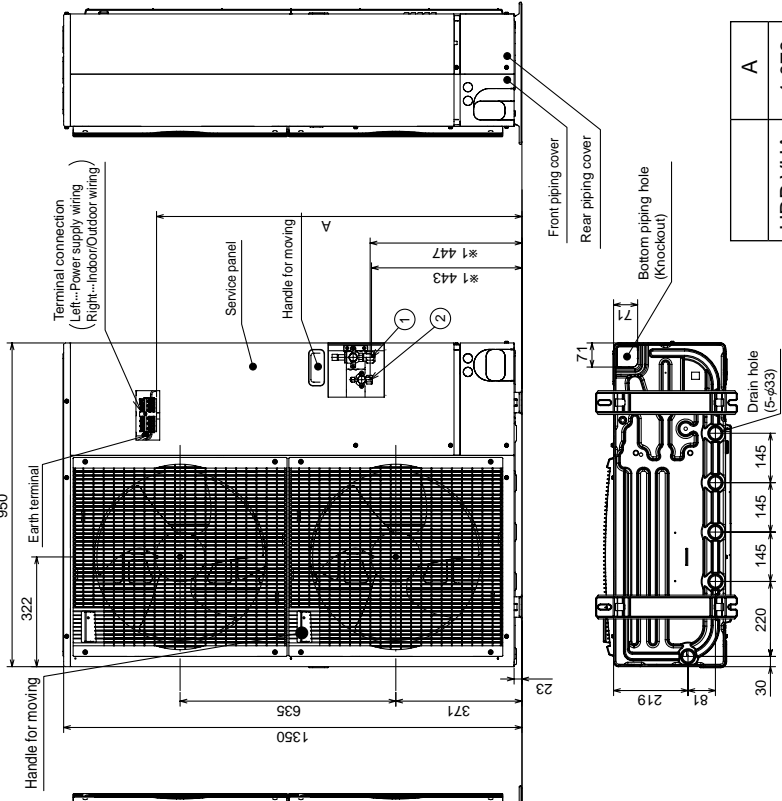
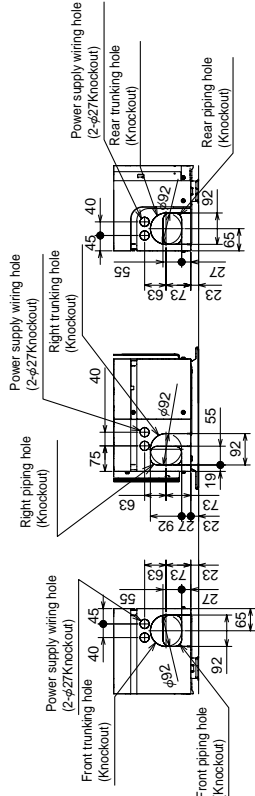

A	
HRP-VHA	1,079
HRP-YHA	930

PUHZ-HRP71VHA2
PUHZ-HRP100VHA2
PUHZ-HRP100YHA2
PUHZ-HRP125YHA2

Unit : mm

1 FREE SPACE (Around the unit)

The diagram below shows a basic example.
 Explanation of particular details is given in the installation manuals etc.

2 SERVICE SPACE

Dimensions of space needed for service access are shown in the below diagram.

3 FOUNDATION BOLTS

Please secure the unit firmly with 4 foundation (M10) bolts. (Bolts and washers must be purchased locally.)

4 PIPING-WIRING DIRECTIONS

Piping and wiring connections can be made from 4 directions: front, right, rear and below.

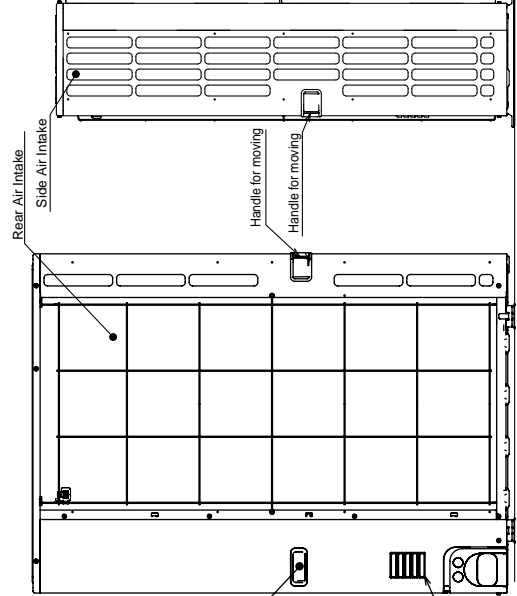
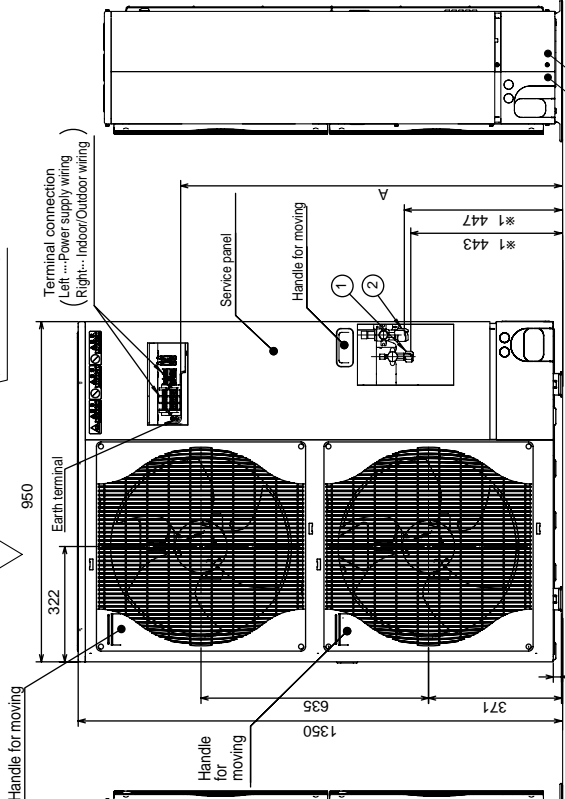
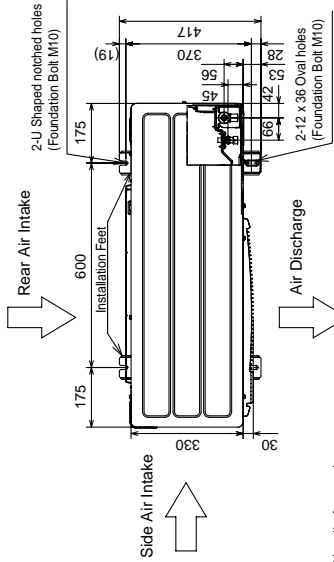

Example of Notes

- ①...Refrigerant GAS pipe connection (FLARE)φ16.38(5/8 inch)
- ②...Refrigerant LIQUID pipe connection (FLARE)φ9.52(3/8 inch)
- *1 ...Indication of STOP VALVE connection location.

Piping Knockout Hole Details

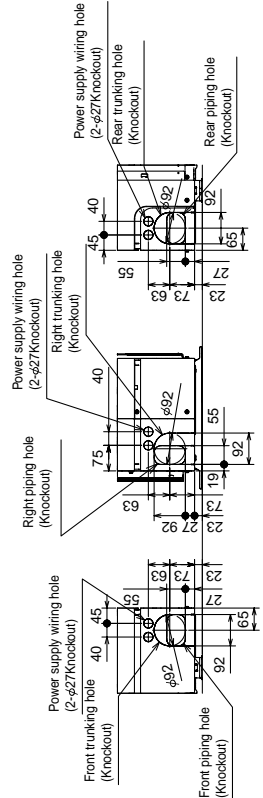

A		
HRP-VHA2	1,079	
HRP-YHA2	930	

4-1. INDOOR UNIT

PLA-RP35BA PLA-RP50BA PLA-RP60BA PLA-RP71BA PLA-RP100BA PLA-RP125BA
 PLA-RP71BA2 PLA-RP100BA2 PLA-RP100BA3 PLA-RP125BA2

<Table 1> SW1 (MODEL SELECTION)

SW1	
MODELS	SETTING
PLA-RP-BA	ON OFF
PLA-RP71/100/125BA2	ON OFF
PLA-RP140BA2 PLA-RP100BA3	ON OFF

<Table 2> SW2 (CAPACITY CODE)

SW2			
CAPACITY	SETTING	CAPACITY	SETTING
35	ON OFF	100	ON OFF
50	ON OFF	125	ON OFF
60	ON OFF	140	ON OFF
71	ON OFF		

The black square (■) indicates a switch position.

[LEGEND]

SYMBOL	NAME	SYMBOL	NAME
I.B	INDOOR CONTROLLER BOARD	MF	FAN MOTOR
CN2L	CONNECTOR (LOSSNAY)	MV	VANE MOTOR
CN32	CONNECTOR (REMOTE SWITCH)	TB2	TERMINAL BLOCK (Indoor unit Power (option))
CN41	CONNECTOR (HA TERMINAL-A)	TB4	TERMINAL BLOCK (INDOOR/OUTDOOR CONNECTING LINE)
CN51	CONNECTOR (CENTRALLY CONTROL)	TB5, TB6	TERMINAL BLOCK (REMOTE CONTROLLER TRANSMISSION LINE)
FUSE	FUSE (T6.3AL250V)		
LED1	POWER SUPPLY (I.B)	TH1	ROOM TEMP. THERMISTOR (0°C / 15kΩ, 25°C / 5.4kΩ DETECT)
LED2	POWER SUPPLY (R.B)	TH2	PIPE TEMP. THERMISTOR/LIQUID (0°C / 15kΩ, 25°C / 5.4kΩ DETECT)
LED3	TRANSMISSION (INDOOR-OUTDOOR)	TH5	COND. / EVA. TEMP. THERMISTOR (0°C / 15kΩ, 25°C / 5.4kΩ DETECT)
SW1	SWITCH (MODEL SELECTION) *See table 1		
SW2	SWITCH (CAPACITY CODE) *See table 2		
SWE	CONNECTOR (EMERGENCY OPERATION)		
X1	RELAY (DRAIN PUMP)		
DCL	REACTOR		
DP	DRAIN PUMP		
FS	DRAIN FLOAT SWITCH		
		OPTION PART	
		W.B	PCB FOR WIRELESS REMOTE CONTROLLER
		BZ	BUZZER
		LED1	LED (OPERATION INDICATION : GREEN)
		LED2	LED (PREPARATION FOR HEATING : ORANGE)
		RU	RECEIVING UNIT
		SW1	EMERGENCY OPERATION (HEAT / DOWN)
		SW2	EMERGENCY OPERATION (COOL / UP)

Refer to tables 1 and 2

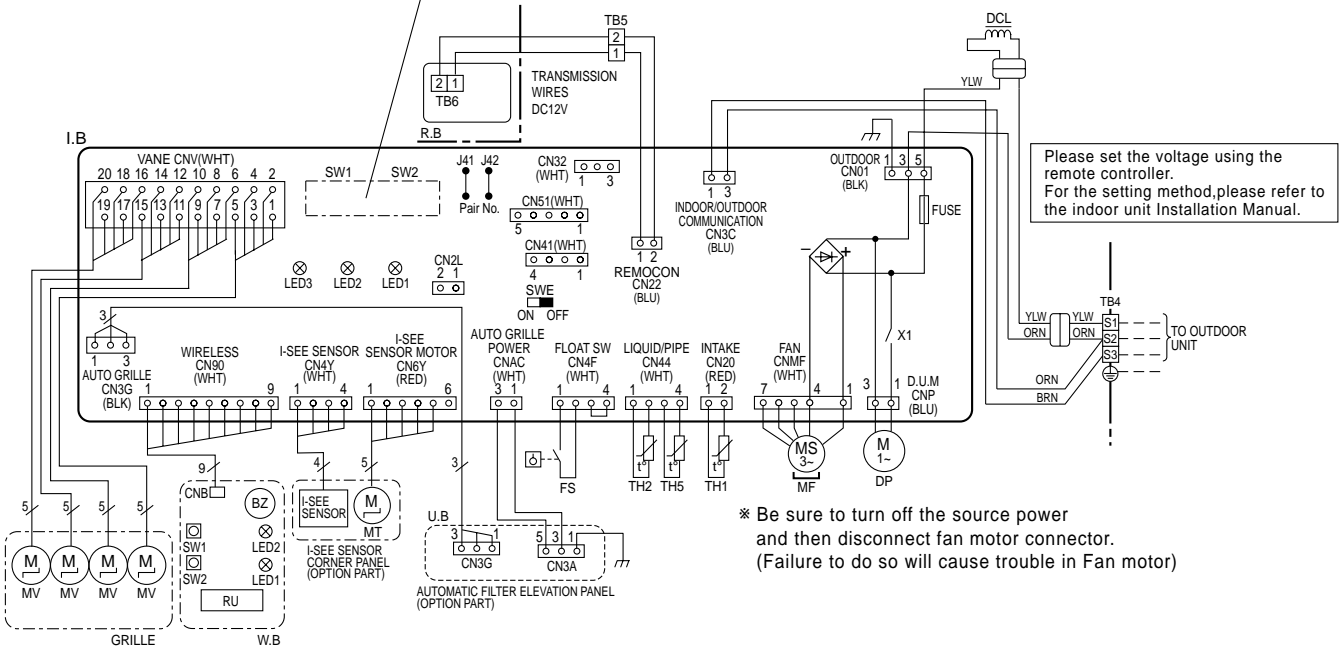

Please set the voltage using the remote controller. For the setting method, please refer to the indoor unit Installation Manual.

* Be sure to turn off the source power and then disconnect fan motor connector. (Failure to do so will cause trouble in Fan motor)

Notes:

1. Symbols used in wiring diagram above are, □ : Connector, □ : Terminal (block).
2. Indoor and outdoor connecting wires have polarities, make sure to match terminal numbers (S1, S2, S3) for correct wirings.
3. Since the outdoor side electric wiring may change, be sure to check the outdoor unit electric wiring diagram for servicing.
4. This diagram shows the wiring of indoor and outdoor connecting wires. (specification of 230V), adopting superimposed system for power and signal.
 - *1: If indoor and outdoor units have separate power supplies, refer to Fig. 1.
 - *2: For power supply system of this unit, refer to the caution label located near this diagram.

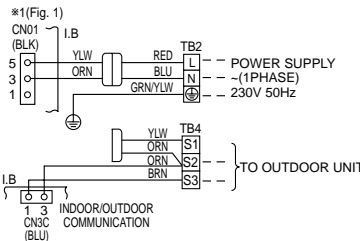

PEAD-RP35JA(L)
PEAD-RP100JA(L)

PEAD-RP50JA(L)
PEAD-RP125JA(L)

PEAD-RP60JA(L)

PEAD-RP71JA(L)

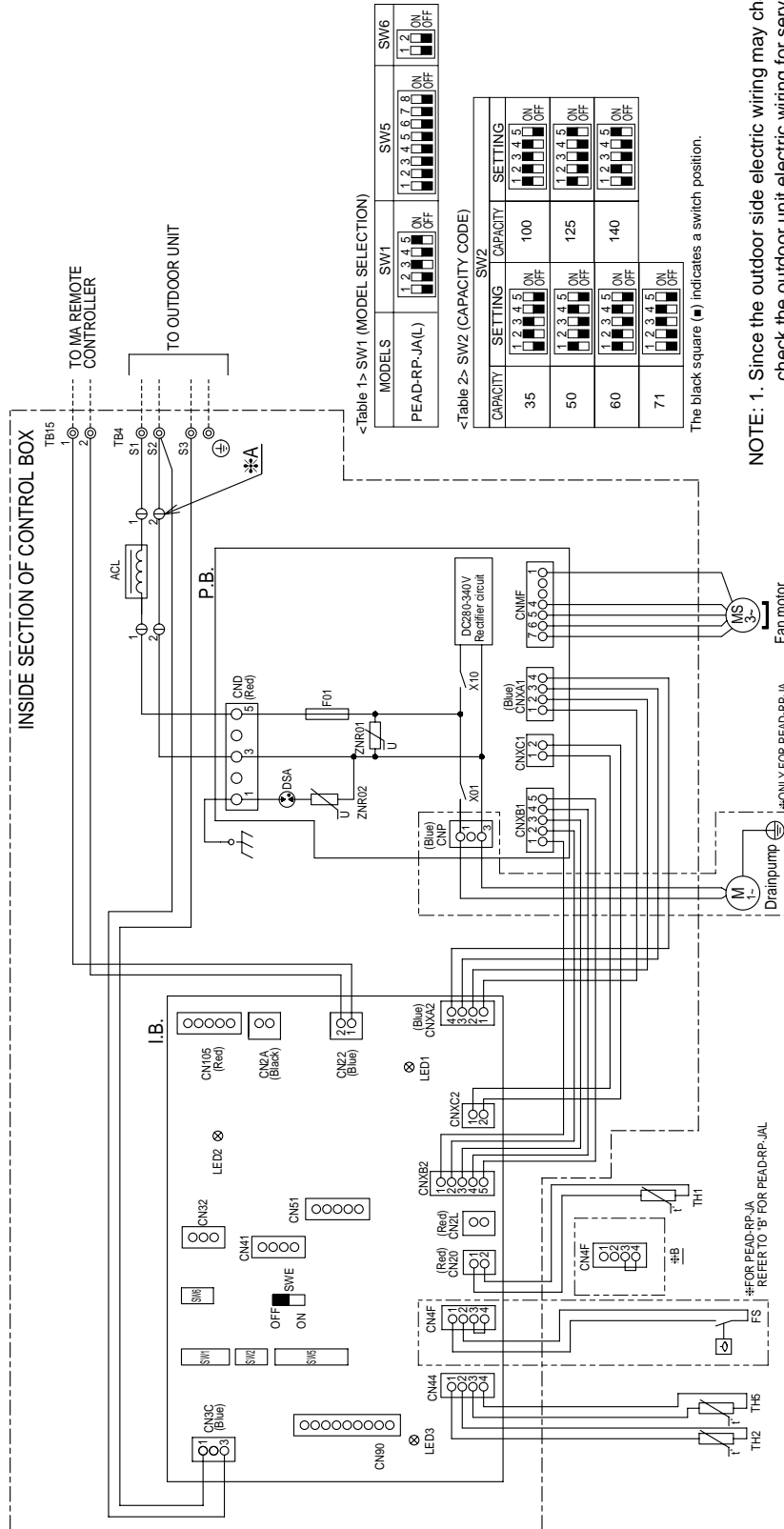

<Table 1> SW1 (MODEL SELECTION)

MODELS	SW1	SW5	SW6
PEAD-RP-JAL	1 2 3 4 5 [] [] [] [] []	1 2 3 4 5 6 7 8 [] [] [] [] [] [] [] []	1 2 [] []

<Table 2> SW2 (CAPACITY CODE)

CAPACITY	SW2	
	SETTING	SETTING
35	1 2 3 4 5 [] [] [] [] []	100 1 2 3 4 5 [] [] [] [] []
50	1 2 3 4 5 [] [] [] [] []	125 1 2 3 4 5 [] [] [] [] []
60	1 2 3 4 5 [] [] [] [] []	140 1 2 3 4 5 [] [] [] [] []
71	1 2 3 4 5 [] [] [] [] []	

The black square (■) indicates a switch position.

- NOTE:** 1. Since the outdoor side electric wiring may change, be sure to check the outdoor unit electric wiring for servicing.
2. Indoor and outdoor connecting wires are made with polarities, make wiring matching terminal numbers (S1, S2, S3).
3. Symbols used in wiring diagram above are: ○ terminal block, ⊙ connector.

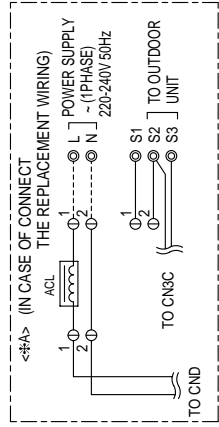

SYMBOL EXPLANATION

SYMBOL	NAME	SYMBOL	NAME	SYMBOL	NAME
I.B.	Indoor controller board	TH1	Intake air temp. Thermistor	TH1	Intake air temp. Thermistor
CN2A	Connector (0-10V Analog input)	TH2	Pipe temp. Thermistor/liquid	TH2	Pipe temp. Thermistor/liquid
CN2L	Connector (Lossnay)	TH5	Cond./eva.temp. Thermistor	TH5	Cond./eva.temp. Thermistor
CN32	Connector (Remote switch)	ACL	AC reactor (Power factor improvement)	ACL	AC reactor (Power factor improvement)
CN41	Connector (HA terminal-A)	FS	Float switch	FS	Float switch
CN51	Connector (Centrally control)	TB4	Terminal block (Indoor/outdoor connecting line)	TB4	Terminal block (Indoor/outdoor connecting line)
CN90	Connector (Wireless)	P.B.	Power supply board	P.B.	Power supply board
CN105	Connector (IT terminal)	F01	Fuse AC250V 6.3A	F01	Fuse AC250V 6.3A
LED1	LED(Power supply)	ZNR01,02	Varistor	ZNR01,02	Varistor
LED2	LED(Remote controller supply)	DSA	Arrester	DSA	Arrester
LED3	LED(Transmission indoor-outdoor)	X01	Aux. relay	X01	Aux. relay
		X10	Aux. relay	X10	Aux. relay

PEAD-RP35EA2
PEAD-RP100EA2

PEAD-RP50EA
PEAD-RP125EA

PEAD-RP60EA

PEAD-RP71EA

[LEGEND]

SYMBOL	NAME	SYMBOL	NAME	SYMBOL	NAME
I.B.	INDOOR CONTROLLER BOARD	SW2	SWITCH(CAPACITY CODE)	TB4	TERMINAL BLOCK (INDOOR/OUTDOOR CONNECTING LINE)
FUSE	FUSE(T6.3AL250V)	SWE	SWITCH(EMERGENCY OPERATION)	TB5	TERMINAL BLOCK(REMOTE CONTROLLER)
ZNR	VARISTOR	X1	RELAY(DRAIN PUMP)	TH1	INTAKE AIR TEMP. THERMISTOR (0°C /15kΩ, 25°C /5.4kΩ DETECT)
CN2L	CONNECTOR(LOSSNAY)	X4	RELAY(FAN MOTOR)	TH2	PIPE TEMP. THERMISTOR/LIQUID (0°C /15kΩ, 25°C /5.4kΩ DETECT)
CN24	CONNECTOR(HEATER)	X5	RELAY(FAN MOTOR)	TH5	COND./EVA. TEMP. THERMISTOR (0°C /15kΩ, 25°C /5.4kΩ DETECT)
CN32	CONNECTOR(REMOTE SWITCH)	X6	RELAY(FAN MOTOR)		
CN41	CONNECTOR(HA TERMINAL-A)	P.B.	INDOOR POWER BOARD (OPTIONAL PARTS)		
CN51	CONNECTOR(CENTRALLY CONTROL)	DRAIN PUMP			
CN90	CONNECTOR(WIRELESS)	DP	DRAIN PUMP		
LED1	POWER SUPPLY(I.B.)	DS	DRAIN SENSOR		
LED2	POWER SUPPLY(REMOTE CONTROLLER)	C	CAPACITOR(FAN MOTOR)		
LED3	TRANSMISSION(INDOOR-OUTDOOR)	MF	FAN MOTOR		
SW1	SWITCH(MODEL SELECTION)				

INSIDE SECTION OF CONTROL BOX

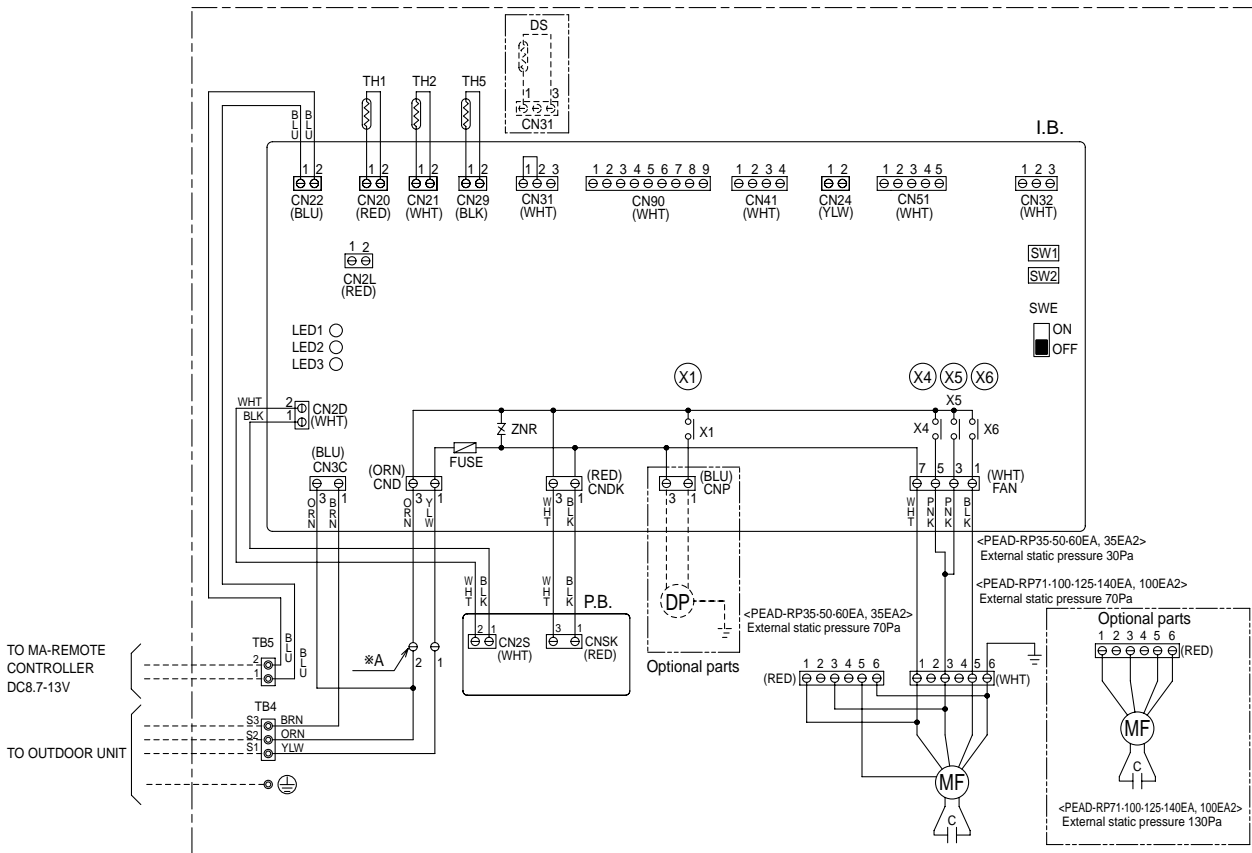

MODELS	SW1 Model selection switch	SW2 Capacity cord switch
35EA(2)		
50EA		
60EA		
71EA		
100EA(2)		
125EA		
140EA		

The black square (■) indicates a switch position.

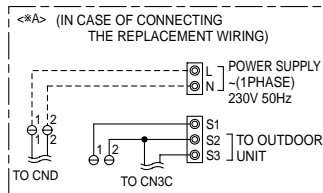

Notes:

1. Symbols used in wiring diagram above are, : Connector, : Terminal (block).
2. Indoor and outdoor connecting wires have polarities, make sure to match terminal numbers (S1, S2, S3) for correct wirings.
3. Since the outdoor side electric wiring may change, be sure to check the outdoor unit electric wiring diagram for servicing.
4. This diagram shows the wiring of indoor and outdoor connecting wires (specification of 230V), adopting superimposed system for power and signal.
 *1: If indoor and outdoor units have separate power supplies, refer to *A.
 *2: For power supply system of this unit, refer to the caution label located near this diagram.

PEAD-RP60GA

PEAD-RP71GA

PEAD-RP100GA

[LEGEND]

SYMBOL	NAME	SYMBOL	NAME	SYMBOL	NAME
I.B.	INDOOR CONTROLLER BOARD	SW1	SWITCH(MODEL SELECTION)	TB5	TERMINAL BLOCK(REMOTE CONTROLLER)
FUSE	FUSE(T6.3AL250V)	SW2	SWITCH(CAPACITY CODE)	TH1	INTAKE AIR TEMP.THERMISTOR (0°C /15kΩ, 25°C/5.4kΩ DETECT)
ZNR	VARISTOR	SWE	SWITCH(EMERGENCY OPERATION)	TH2	PIPE TEMP. THERMISTOR/LIQUID (0°C /15kΩ, 25°C/5.4kΩ DETECT)
CN2L	CONNECTOR(LOSSNAY)	X1	RELAY(DRAIN PUMP)	TH5	COND./EVA. TEMP. THERMISTOR (0°C /15kΩ, 25°C/5.4kΩ DETECT)
CN24	CONNECTOR(HEATER)	X4	RELAY(FAN MOTOR)		
CN32	CONNECTOR(REMOTE SWITCH)	X5	RELAY(FAN MOTOR)		
CN41	CONNECTOR(HA TERMINAL-A)	X6	RELAY(FAN MOTOR)		
CN51	CONNECTOR(CENTRALLY CONTROL)	P.B.	INDOOR POWER BOARD		
CN90	CONNECTOR(WIRELESS)	C	CAPACITOR(FAN MOTOR)		
LED1	POWER SUPPLY(I.B.)	MF	FAN MOTOR		
LED2	POWER SUPPLY(REMOTE CONTROLLER)	TB4	TERMINAL BLOCK (INDOOR/OUTDOOR CONNECTING LINE)		
LED3	TRANSMISSION(INDOOR-OUTDOOR)				

INSIDE SECTION OF CONTROL BOX

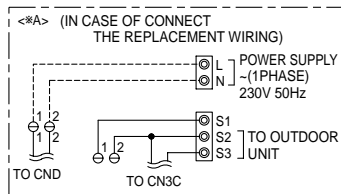
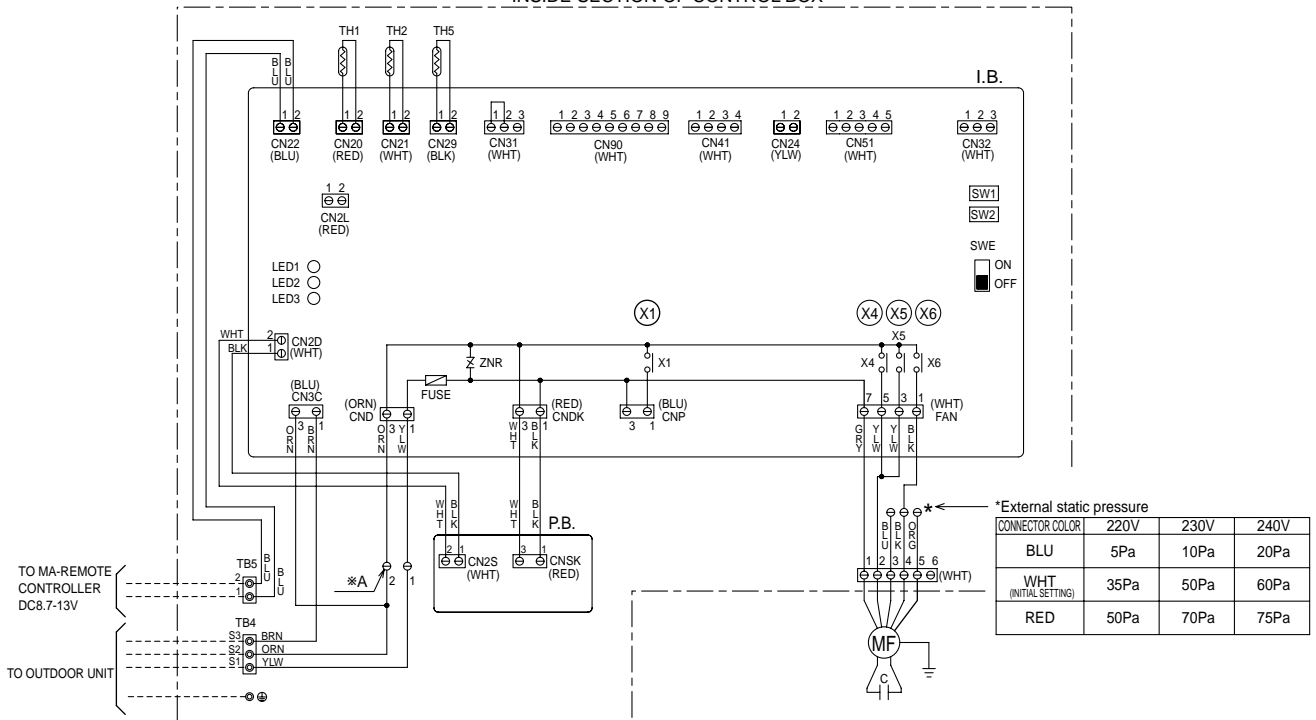

MODELS	SW1 Model selection switch	SW2 Capacity cord switch
60GA	1 2 3 4 5 ON OFF	1 2 3 4 5 ON OFF
71GA	1 2 3 4 5 ON OFF	1 2 3 4 5 ON OFF
100GA	1 2 3 4 5 ON OFF	1 2 3 4 5 ON OFF

The black square (■) indicates a switch position.

Notes:

1. Symbols used in wiring diagram above are, [⊙⊙⊙]: Connector, [⊙⊙⊙]: Terminal (block).
2. Indoor and outdoor connecting wires have polarities, make sure to match terminal numbers (S1, S2, S3) for correct wirings.
3. Since the outdoor side electric wiring may change, be sure to check the outdoor unit electric wiring diagram for servicing.
4. This diagram shows the wiring of indoor and outdoor connecting wires (specification of 230V), adopting superimposed system for power and signal.

- *1: If indoor and outdoor units have separate power supplies, refer to *A.
- *2: For power supply system of this unit, refer to the caution label located near this diagram.

PKA-RP35HAL

PKA-RP50HAL

[Explanation of symbols]

Symbol	Name	Symbol	Name
I.B	Indoor controller board	M	Vane motor
CN2L	Connector (LOSSNAY)	MS	Fan motor
CN32	Connector (Remote switch)	S.W	Switch board
CN41	Connector (HA terminal-A)	SWE2	Emergency operation
CN51	Connector (Centrally control)	TB2	Terminal block(Indoor unit Power (option))
CN90	Connector (Remote operation adapter)	TB4	Terminal block (Indoor/outdoor connecting line)
FUSE	FUSE(T3.15AL250V)	TB5	Terminal block (Remote controller transmission line(option))
LED1	Power supply (I.B)	TH1	Room temp. Thermistor (0°C/15kΩ, 25°C/5.4kΩ Detect)
LED2	Power supply (R.B)	TH2	Pipe temp. Thermistor/liquid (0°C/15kΩ, 25°C/5.4kΩ Detect)
LED3	Transmission (Indoor-outdoor)	TH5	Cond./eva. temp. Thermistor (0°C/15kΩ, 25°C/5.4kΩ Detect)
SW1	Switch (Model selection) *See table 1	W.B	PCB for wireless remote controller
SW2	Switch (Capacity code) *See table 2	LED1	LED (Operation indication : Green)
SWE	Connector (Emergency operation)	LED2	LED (Preparation for heating: Orange)
X1	Relay (Drain pump (option))	REC1	Receiving unit
CNP	Drain pump (option) power supply (Drain pump (option))	DCL	REACTOR
CN4F	Drain float switch (Drain pump (option))	DP	DRAIN PUMP (OPTION)
R.B	Wired remote controller(option)	FS	DRAIN FLOAT SWITCH (OPTION)
TB6	Terminal block (Remote controller transmission line)		

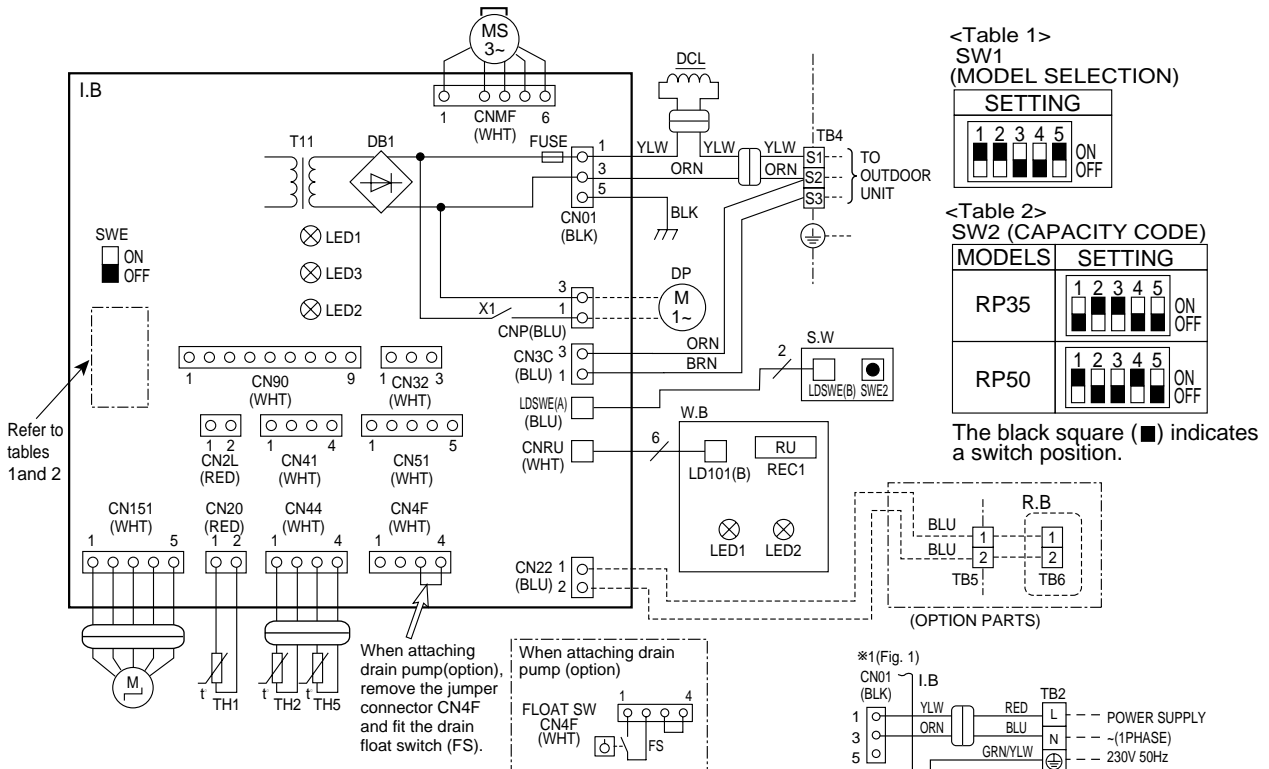

Notes:

1. Symbols used in wiring diagram above are, : Connector, : Terminal (block).
2. Indoor and outdoor connecting wires have polarities, make sure to match terminal numbers (S1, S2, S3) for correct wirings.
3. Since the outdoor side electric wiring may change, be sure to check the outdoor unit electric wiring diagram for servicing.
4. This diagram shows the wiring of indoor and outdoor connecting wires. (specification of 230V), adopting superimposed system for power and signal.

*1: If indoor and outdoor units have separate power supplies, refer to Fig 1.

*2: For power supply system of this unit, refer to the caution label located near this diagram.

PKA-RP60KAL

PKA-RP100KAL

[LEGEND]

SYMBOL	NAME	SYMBOL	NAME
I.B	Indoor controller board	M	Vane motor
CN2L	Connector (LOSSNAY)	MS	Fan motor
CN32	Connector (Remote switch)	S.W	Switch board
CN41	Connector (HA terminal-A)	SWE2	Emergency operation
CN51	Connector (Centrally control)	TB2	Terminal block (Indoor unit Power (option))
CN90	Connector (Remote operation adapter)	TB4	Terminal block (Indoor/outdoor connecting line)
FUSE	FUSE (T3.15AL250V)	TB5	Terminal block (Remote controller transmission line)
LED1	Power supply (I.B)	TH1	Room temp. Thermistor (0°C / 15kΩ, 25°C / 5.4kΩ Detect)
LED2	Power supply (R.B)	TH2	Pipe temp. Thermistor/liquid (0°C / 15kΩ, 25°C / 5.4kΩ Detect)
LED3	Transmission (Indoor-outdoor)	TH5	Cond. / eva. temp. Thermistor (0°C / 15kΩ, 25°C / 5.4kΩ Detect)
SW1	Switch (Model selection) *See table 1	W.B	PCB for wireless remote controller
SW2	Switch (Capacity code) *See table 2	LED1	LED (Operation indication : Green)
SWE	Connector (Emergency operation)	LED2	LED (Preparation for heating : Orange)
X1	Relay (Drain pump(option))	REC1	Receiving unit
CNP	Drain pump (option) power supply (Drain pump(option))	DCL	REACTOR
CN4F	Drain float switch (Drain pump (option))	DP	DRAIN PUMP (OPTION)
R.B	Wired remote controller	FS	DRAIN FLOAT SWITCH (OPTION)
TB6	Terminal block (Remote controller transmission line)		

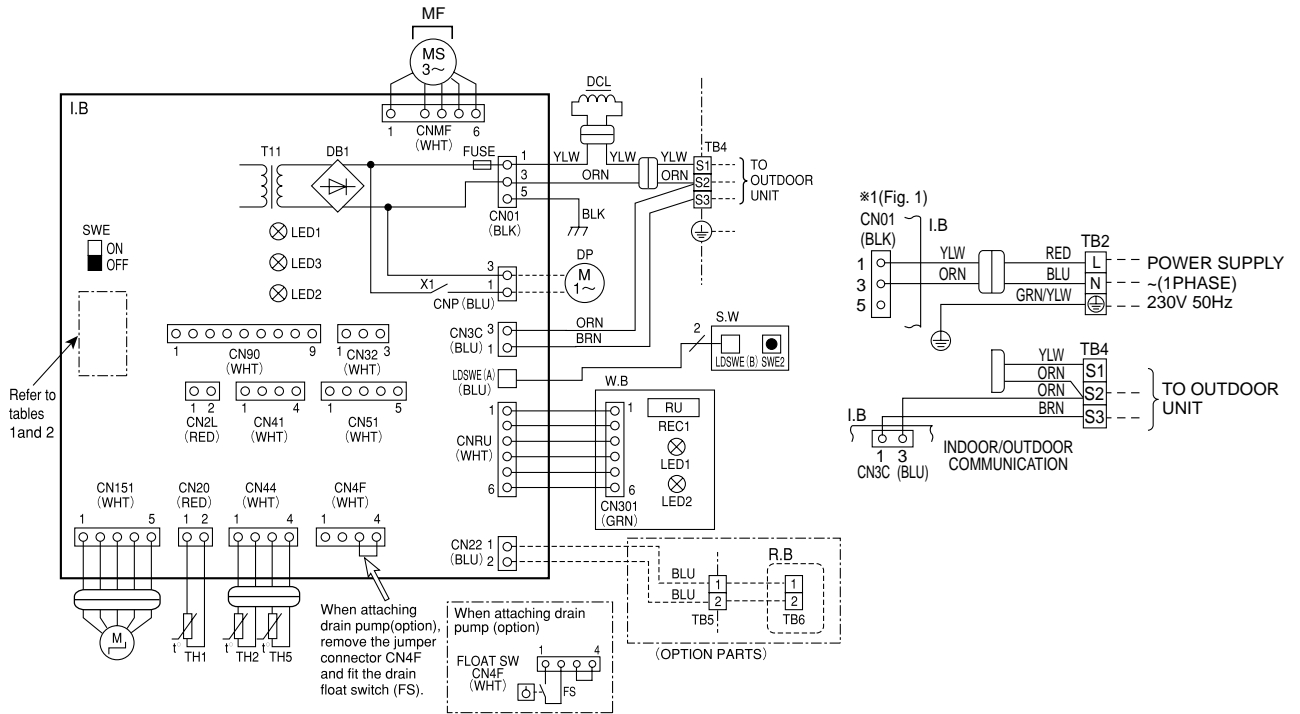

(Table 1)

SW1 (MODEL SELECTION)

SETTING
1 2 3 4 5 ON OFF

(Table 2)

SW2 (CAPACITY CODE)

MODELS	SETTING	MODELS	SETTING	MODELS	SETTING
PKA-RP60KAL	1 2 3 4 5 ON OFF	PKA-RP71KAL	1 2 3 4 5 ON OFF	PKA-RP100KAL	1 2 3 4 5 ON OFF

The black square (■) indicates a switch position.

Notes:

1. Symbols used in wiring diagram above are, □□□ : Connector, □□□ : Terminal (block).
 2. Indoor and outdoor connecting wires have polarities, make sure to match terminal numbers (S1, S2, S3) for correct wirings.
 3. Since the outdoor side electric wiring may change, be sure to check the outdoor unit electric wiring diagram for servicing.
 4. This diagram shows the wiring of indoor and outdoor connecting wires.(specification of 230V), adopting superimposed system for power and signal.
- ※1 If indoor and outdoor units have separate power supplies, refer to Fig 1.
 ※2 For power supply system of this unit, refer to the caution label located near this diagram.

PKA-RP35GAL PKA-RP50GAL

LEGEND

SYMBOL	NAME	SYMBOL	NAME	SYMBOL	NAME
P.B	INDOOR POWER BOARD	C	CAPACITOR <FAN MOTOR>	W.B	WIRELESS REMOTE CONTROLLER BOARD
I.B	INDOOR CONTROLLER BOARD	MF	FAN MOTOR	RU	RECEIVING UNIT
FUSE	FUSE (T6.3AL250V)	MV	VANE MOTOR	BZ	BUZZER
ZNR	VARISTOR	TB2	TERMINAL BLOCK (HEATER) *PKH-P.GALH models only or option for PKA-RP.GAL models.	LED1	LED <RUN INDICATOR>
CN2L	CONNECTOR <LOSSNAY>	TB4	TERMINAL BLOCK <INDOOR/ OUTDOOR CONNECTING LINE>	LED2	LED <HOT ADJUST>
CN32	CONNECTOR <REMOTE SWITCH>	TB5,TB6	TERMINAL BLOCK <REMOTE CONTROLLER TRANSMISSION LINE> <OPTION>	SW1	SWITCH (HEATING ON/ OFF)
CN41	CONNECTOR <HA TERMINAL-A>			SW2	SWITCH (COOLING ON/ OFF)
CN51	CONNECTOR <CENTRALLY CONTROL>			R.B	WIRED REMOTE CONTROLLER BOARD
SW1	SWITCH <MODEL SELECTION>*See Table 1.	TH1	ROOM TEMP.THERMISTOR <0°C/ 15kΩ, 25°C/ 5.4kΩ DETECT>	HEATER	
SW2	SWITCH <CAPACITY CODE>*See Table 2.	TH2	PIPE TEMP.THERMISTOR/ LIQUID <0°C/ 15kΩ, 25°C/ 5.4kΩ DETECT>	FS1	THERMAL FUSE <104°C 10A>
SWE	SWITCH <EMERGENCY OPERATION>	TH5	COND./ EVA.TEMP.THERMISTOR <0°C/ 15kΩ, 25°C/ 5.4kΩ DETECT>	FS2	THERMAL FUSE <84°C 10A>
X4	RELAY <FAN MOTOR>			H1	HEATER
BCR	FAN CONTROL ELEMENT			26H	HEATER THERMAL SWITCH
LED1	POWER SUPPLY <I.B>			88H	HEATER CONTACTOR
LED2	POWER SUPPLY <R.B>				
LED3	TRANSMISSION <INDOOR-OUTDOOR>				

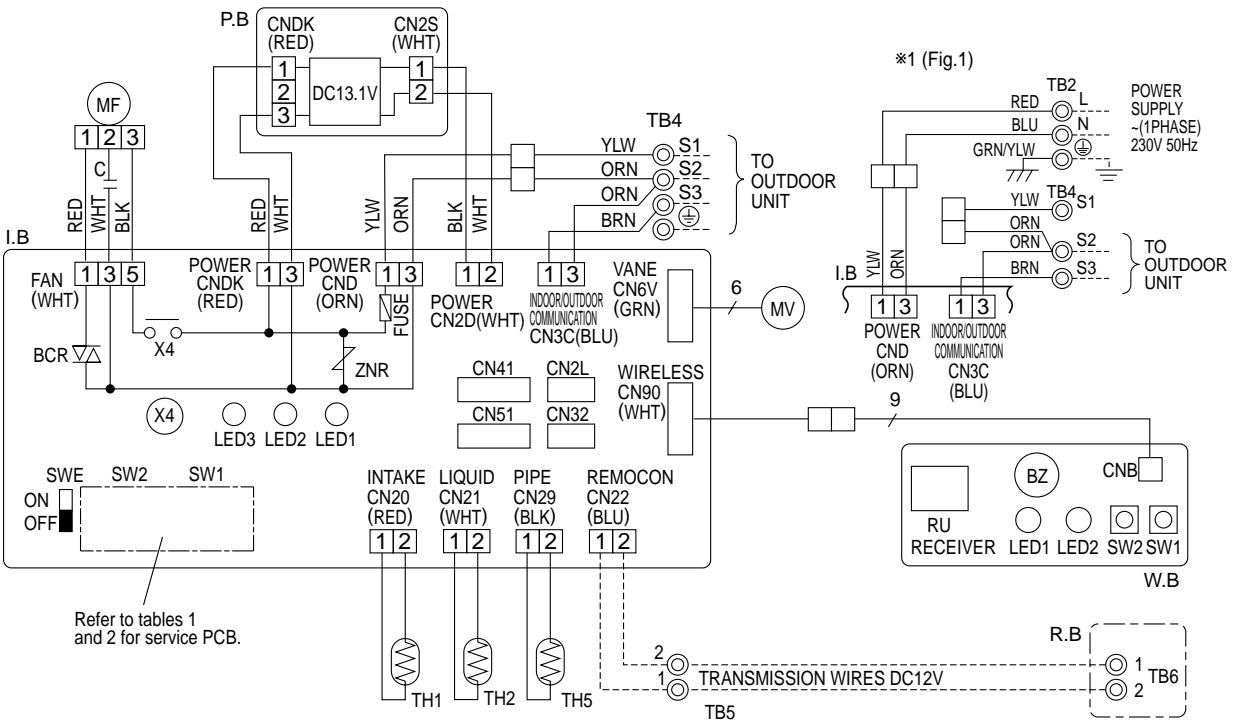

Refer to tables 1 and 2 for service PCB.

PKH-P35,50GALH models only

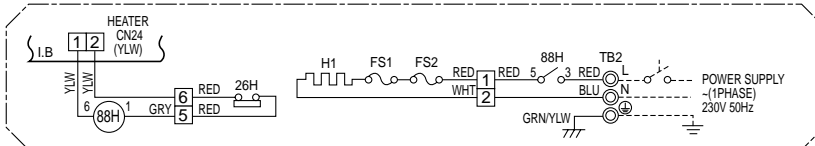

Please set the voltage using the remote controller.
For the setting method, please refer to the indoor unit Installation Manual.

SW1					SW2				
Service board					Service board				
1	2	3	4	5	1	2	3	4	5
ON	OFF	ON	OFF	ON	ON	OFF	ON	OFF	ON
PKA-RP35GAL	PKH-P35GALH	PKA-RP50GAL	PKH-P50GALH						

The black square (■) indicates a switch position.

Notes:

- Symbols used in wiring diagram above are, □□□: Connector, ⊙: Terminal (block).
- Indoor and outdoor connecting wires have polarities, make sure to match terminal numbers (S1, S2, S3) for correct wirings.
- Since the outdoor side electric wiring may change, be sure to check the outdoor unit electric wiring diagram for servicing.
- This diagram shows the wiring of indoor and outdoor connecting wires (specification of 230V), adopting superimposed system for power and signal.
 - *1: If indoor and outdoor units have separate power supplies, refer to Fig 1.
 - *2: For power supply system of this unit, refer to the caution label located near this diagram.

PKA-RP50FAL2

PKA-RP60FAL

PKA-RP100FAL

[LEGEND]

SYMBOL	NAME	SYMBOL	NAME	SYMBOL	NAME
P.B	INDOOR POWER BOARD	C	CAPACITOR(FAN MOTOR)	W.B	WIRELESS REMOTE CONTROLLER BOARD
I.B	INDOOR CONTROLLER BOARD	MF	FAN MOTOR	RU	RECEIVING UNIT
FUSE	FUSE(T6.3AL250V)	MV	VANE MOTOR	BZ	BUZZER
ZNR	VARISTOR	TB2	TERMINAL BLOCK (HEATER) *PKH-P.FALH models only or option for PKA-RP.FAL models.	LED1	LED(RUN INDICATOR)
CN2L	CONNECTOR(LOSSNAY)	TB4	TERMINAL BLOCK(INDOOR/OUTDOOR CONNECTING LINE)	LED2	LED(HOT ADJUST)
CN32	CONNECTOR(REMOTE SWITCH)	TB5	TERMINAL BLOCK(REMOTE CONTROLLER TRANSMISSION LINE)(OPTION)	SW1	SWITCH(HEATING ON/OFF)
CN41	CONNECTOR(HA TERMINAL-A)	TH1	ROOM TEMP.THERMISTOR (0°C/15kΩ, 25°C/5.4kΩ DETECT)	SW2	SWITCH(COOLING ON/OFF)
CN51	CONNECTOR(CENTRALLY CONTROL)	TH2	PIPE TEMP.THERMISTOR/LIQUID (0°C/15kΩ, 25°C/5.4kΩ DETECT)	R.B	WIRED REMOTE CONTROLLER BOARD(OPTION)
SW1	SWITCH (MODEL SELECTION) * See Table 1.	TH5	COND./EVA.TEMP.THERMISTOR (0°C/15kΩ, 25°C/5.4kΩ DETECT)	TB6	TERMINAL BLOCK(REMOTE CONTROLLER TRANSMISSION LINE)
SW2	SWITCH (CAPACITY CODE) * See Table 2.			HEATER	
SWE	SWITCH(EMERGENCY OPERATION)			FS1,2	THERMAL FUSE(117°C 10A:60,71FALH/ 117°C 16A:100FALH)
X4	RELAY(FAN MOTOR)			H1	HEATER
BCR	FAN CONTROL ELEMENT			26H	HEATER THERMAL SWITCH
LED1	POWER SUPPLY(I.B)			88H	HEATER CONTACTOR
LED2	POWER SUPPLY(R.B)				
LED3	TRANSMISSION(INDOOR-OUTDOOR)				

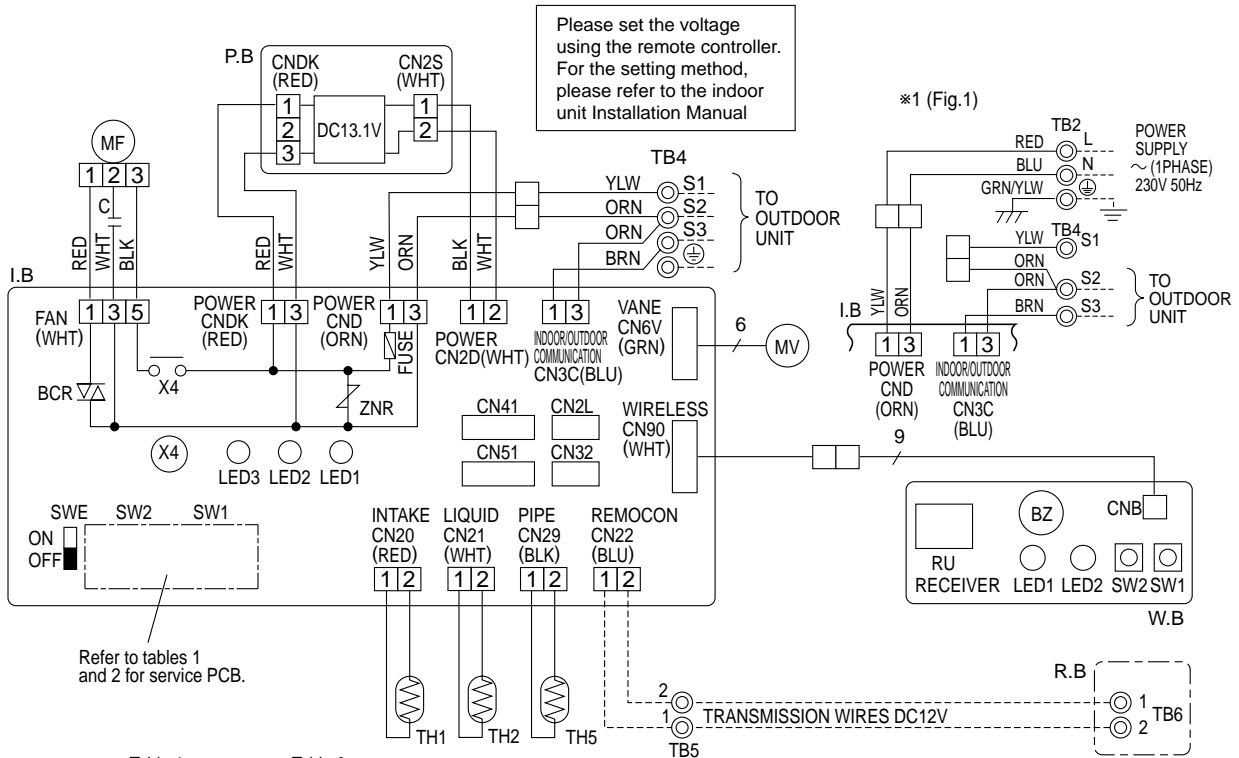

Table 1

SW1					
Service board					
1	2	3	4	5	ON/OFF
■	■	■	■	■	ON
■	■	■	■	■	OFF

Table 2

SW2											
MODELS		Service board		MODELS		Service board		MODELS		Service board	
PKA-RP50FAL2	PKA-RP60FAL	PKH-P60FALH	PKA-RP71FAL	PKH-P71FALH	PKA-RP100FAL	PKH-P100FALH	1	2	3	4	5
■	■	■	■	■	■	■	■	■	■	■	■
■	■	■	■	■	■	■	■	■	■	■	■

The black square (■) indicates a switch position.

PKH-P60~P100FALH models only

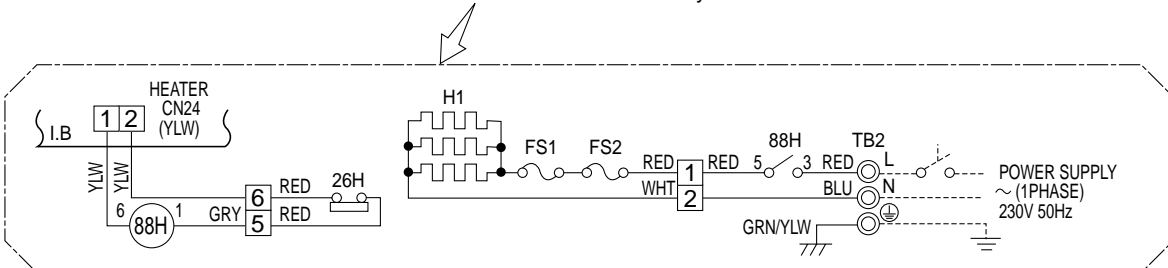

Notes:

1. Symbols used in wiring diagram above are, □□□: Connector, ⊙: Terminal (block).
 2. Indoor and outdoor connecting wires have polarities, make sure to match terminal numbers (S1, S2, S3) for correct wirings.
 3. Since the outdoor side electric wiring may change, be sure to check the outdoor unit electric wiring diagram for servicing.
 4. This diagram shows the wiring of indoor and outdoor connecting wires (specification of 230V), adopting superimposed system for power and signal.
- *1: If indoor and outdoor units have separate power supplies, refer to Fig 1.
 *2: For power supply system of this unit, refer to the caution label located near this diagram.

4-2. OUTDOOR UNIT

PUHZ-HRP71VHA PUAZ-HRP100VHA

[LEGEND]

SYMBOL	NAME	SYMBOL	NAME	SYMBOL	NAME
TB1	Terminal Block<Power Supply, Indoor/Outdoor>	P.B.	Power Circuit Board	SW6	Switch<Model Select>
MC	Motor for Compressor	TABU/V/W	Connection Terminal<U/V/W-Phase>	SW7	Switch<Function Setup>
MF1, MF2	Fan Motor	TABS/T	Connection Terminal<L/N-Phase>	SW8	Switch<Function Setup>
21S4	Solenoid Valve (Four-Way Valve)	TABP1/P2/P	Connection Terminal<DC Voltage>	SW9	Switch
63H	High Pressure Switch	TABN1/N2/N	Connection Terminal<DC Voltage>	SWP	Switch<Pump Down>
63L	Low Pressure Switch	DS2, DS3	Diode Bridge	CN31	Connector<Emergency Operation>
SV	Solenoid Valve (Bypass Valve)	IPM	Power Module	SS	Connector<Connection for Option>
TH3, TH32, TH33	Thermistor<Outdoor Pipe>	N.F.	Noise Filter Circuit Board	CNM	Connector<A-Control Service Inspection Kit>
TH4	Thermistor<Discharge>	LI / LO	Connection Terminal<L-Phase>	CNMNT	Connector<Connected to Optional M-NET Adapter Board>
TH6	Thermistor<Outdoor 2-Phase Pipe>	NI / NO	Connection Terminal<N-Phase>	CNMVMT	Connector<Connected to Optional M-NET Adapter Board>
TH7	Thermistor<Outdoor>	EI, E2	Connection Terminal<Ground>	CNDM	Connector<Connected for Option (Contact Input)>
TH8	Thermistor<Heatsink>	52C	52C Relay	LED1, LED2	LED<Operation Inspection Indicators>
LEV-A, LEV-B, LEV-C	Electronic Expansion Valve	C.B.	Controller Circuit Board	F1~F4	Fuse< T6.3AL250V>
DCL	Reactor	SW1	Switch<Forced Defrost, Defect History Record Reset, Refrigerant Address>	X51, X52, X55	Relay
ACTM	Active Filter Module	SW4	Switch<Test Operation>		
CB	Main Smoothing Capacitor	SW5	Switch<Function Switch>		
CY1, CY2	Capacitor				

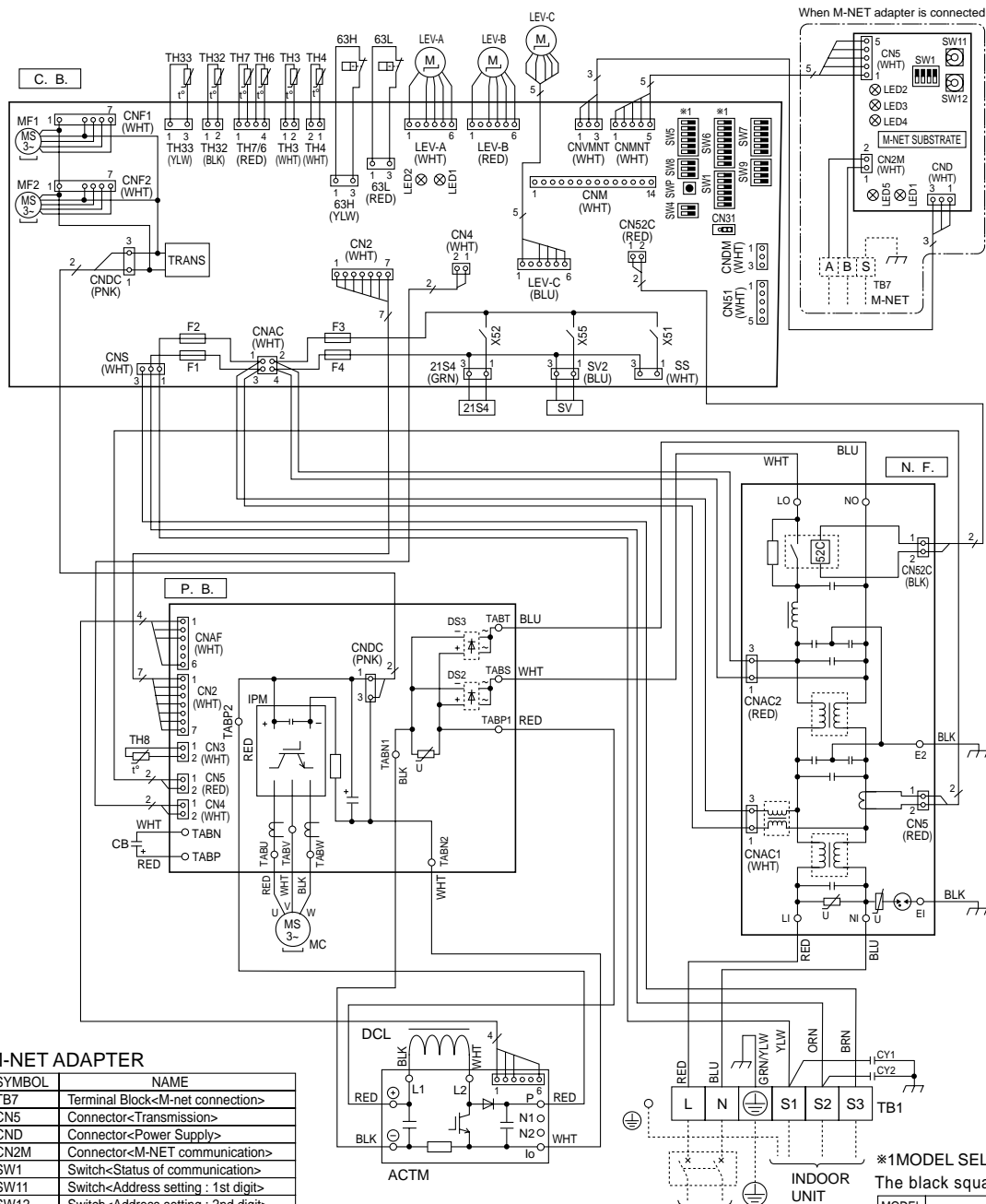

M-NET ADAPTER

SYMBOL	NAME
TB7	Terminal Block<M-net connection>
CN5	Connector<Transmission>
CND	Connector<Power Supply>
CN2M	Connector<M-NET communication>
SW1	Switch<Status of communication>
SW11	Switch<Address setting : 1st digit>
SW12	Switch<Address setting : 2nd digit>
LED1	LED<Power Supply : DC5V>
LED2	LED<Connection to Outdoor Unit>
LED3	LED<Transmission : Sending>
LED4	LED<Transmission : Receiving>
LED5	LED<Power Supply : DC12V>

*1MODEL SELECT

The black square (■) indicates a switch position.

MODEL	SW6	SW5-6 #2
71V	ON	ON
	OFF	OFF
100V	ON	ON
	OFF	OFF

PUHZ-HRP100YHA

PUHZ-HRP125YHA

LEGEND

SYMBOL	NAME	SYMBOL	NAME	SYMBOL	NAME
TB1	Terminal Block<Power Supply>	P.B.	Power Circuit Board	C.B.	Controller Circuit Board
TB2	Terminal Block<Indoor/Outdoor >	TB-U/V/W	Connection Terminal<U/V/W-Phase>	SW1	Switch<Forced Defrost, Defect History Record Reset, Refrigerant Address>
MC	Motor for Compressor	TB-L1/L2/L3	Connection Terminal<L1/L2/L3-Power Supply>	SW4	Switch<Test Operation>
MF1, MF2	Fan Motor	TB-P2	Connection Terminal	SW5	Switch<Function Switch>
21S4	Solenoid Valve (Four-Way Valve)	TB-C1	Connection Terminal	SW6	Switch<Model Select>
63H	High Pressure Switch	TB-N1	Connection Terminal	SW7	Switch<Function Setup>
63L	Low Pressure Switch	X52A	52C Relay	SW8	Switch<Function Setup>
SV	Solenoid Valve (Bypass Valve)	N.F.	Noise Filter Circuit Board	SW9	Switch
TH3, TH32, TH33	Thermistor<Outdoor Pipe>	L11/L12/L13/N1	Connection Terminal<L1/L2/L3/N-Power Supply>	SWP	Switch<Pump Down>
TH4	Thermistor<Discharge>	L01/L02/L03/N0	Connection Terminal<L1/L2/L3/N-Power Supply>	CN31	Connector<Emergency Operation>
TH6	Thermistor<Outdoor 2-Phase Pipe>	GD1, GD3	Connection Terminal<Ground>	LED1, LED2	LED<Operation Inspection Indicators>
TH7	Thermistor<Outdoor>	CONV.B.	Converter Circuit Board	F1-F4	Fuse<T6.3AL250V>
LEV-A, LEV-B, LEV-C	Electronic Expansion Valve	L1-A1/IN	Connection Terminal<L1-Power Supply>	CNM	Connector<A-Control Service Inspection Kit>
ACL1-ACL4	Reactor	L1-A2/OU	Connection Terminal<L1-Power Supply>	CNMNT	Connector<Connect to Optional M-NET Adapter Board>
CB1, CB2	Main Smoothing Capacitor	L2-A2/OU	Connection Terminal<L2-Power Supply>	CNVMNT	Connector<Connect to Optional M-NET Adapter Board>
CK	Capacitor	L3-A2/OU	Connection Terminal<L3-Power Supply>	CNDM	Connector<Connect to Optional M-NET Adapter Board>
CY1, CY2	Capacitor	N-IN	Connection Terminal	CN3S	Connector< Connection for Option>
RS	Rush Current Protect Resistor	CK-OU	Connection Terminal	CN51	Connector< Connection for Option>
				SS	Connector<Connection for Option>
				X51, X52, X55	Relay

M-NET ADAPTER

TB7	Terminal Block<M-NET connection >	SW12	Switch<Address setting, 2nd digit >
CN5	Connector<Transmission>	LED1	LED<Power Supply: DC5V>
CND	Connector<Power Supply>	LED2	LED<Connection to Outdoor Unit>
CN2M	Connector<M-NET communication>	LED3	LED<Transmission: Sending>
SW1	Switch<Status of communication>	LED4	LED<Transmission: Receiving>
SW11	Switch<Address setting: 1st digit>	LED5	LED<Power Supply: DC12V>

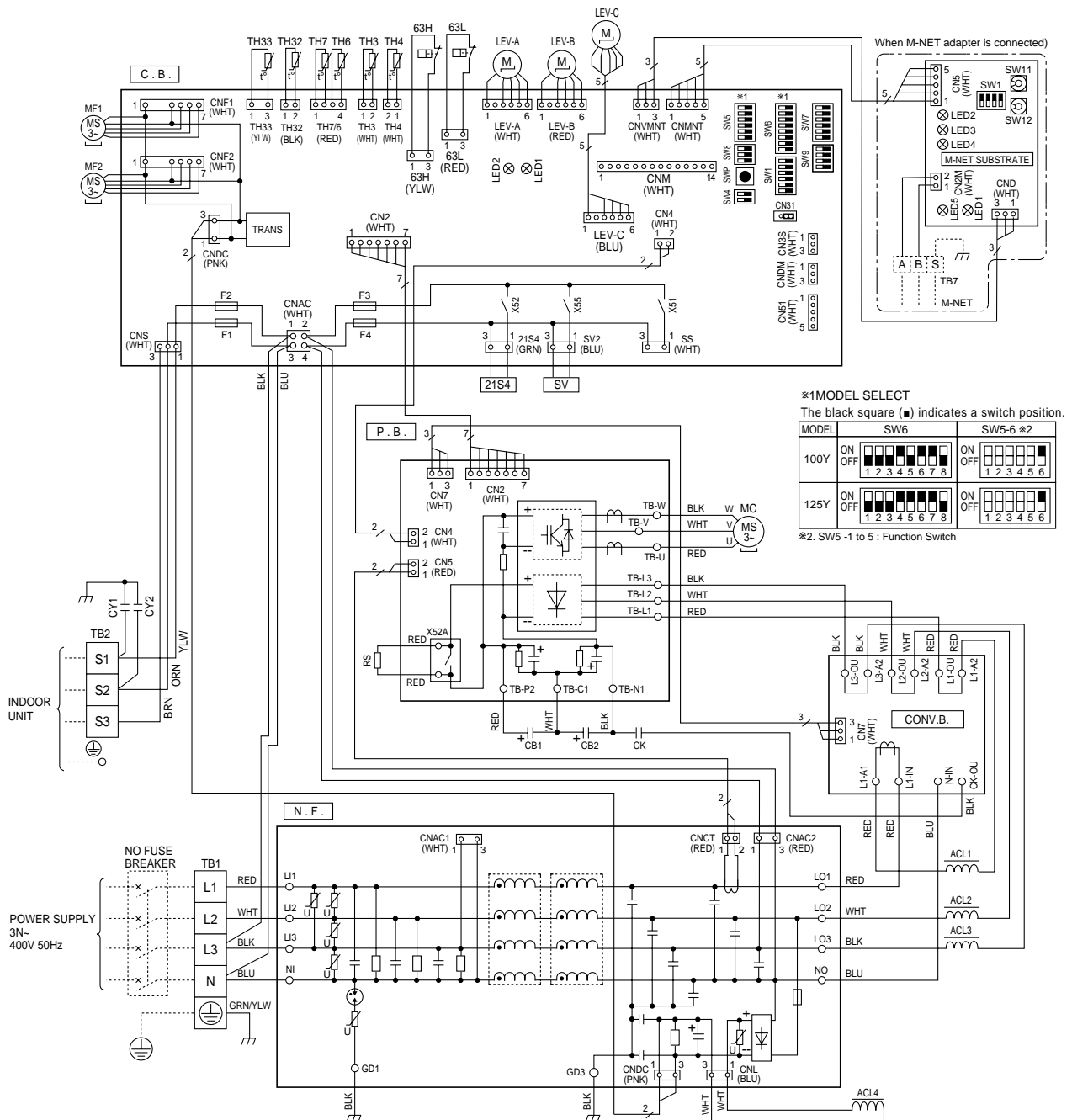

PUHZ-HRP71VHA2

PUHZ-HRP100VHA2

[LEGEND]

SYMBOL	NAME	SYMBOL	NAME	SYMBOL	NAME
TB1	Terminal Block<Power Supply, Indoor/Outdoor>	P.B.	Power Circuit Board	CN31	Connector<Emergency Operation>
MC	Motor for Compressor	U/V/W	Connection Terminal<U/V/W-Phase>	SV1	Connector<Connection for Option>
MF1, MF2	Fan Motor	LI	Connection Terminal <L-Phase>	SS	Connector<Connection for Option>
21S4	Solenoid Valve (Four-Way Valve)	NI	Connection Terminal<N-Phase>	CNM	Connector<A-Control Service Inspection Kit>
63H	High Pressure Switch	DCL1, DCL2	Recator	CNDM	Connector
63L	Low Pressure Switch	IGBT	Power Module		< Connected for Option (Contact Input)>
63HS	High Pressure Sensor	E1,E2,E3,E4	Connection Terminal (Ground)	LED1,LED2	LED<Operation Inspection Indicators>
TH3	Thermistor<Liquid>	C.B.	Controller Circuit Board	F1~F4	Fuse< T6.3AL250V>
TH4	Thermistor<Discharge>	SW1	Switch<Manual Defrost, Defect History Record Reset, Refrigerant Address>	X51,X52,X54	Relay
TH6	Thermistor<2-Phase>	SW4	Switch<Test Operation>		
TH7	Thermistor<Ambient>	SW5	Switch<Function Switch, Model Select>		
TH32	Thermistor<Suction>	SW6	Switch<Function Set up>		
TH33	Thermistor<Ref. check>	SW7	Switch<Function Set up>		
LEV-A,LEV-B,LEV-C	Electronic Expansion Valve	SW8	Switch<Function Set up>		
DCL	Reactor	SW9	Switch<Function Switch>		
CE	Main Smoothing Capacitor	SWP	Switch<Pump Down>		
CY1,CY2	Capacitor				

M-NET ADAPTER

SYMBOL	NAME
TB7	Terminal Block<M-NET connection>
CN5	Connector<Transmission>
CND	Connector<Power Supply>
CN2M	Connector<M-NET communication>
SW1	Switch<Status of communication>
SW11	Switch<Address setting : 1s digit>
SW12	Switch<Address setting : 10s digit>
LED1	LED<Power Supply : DC5V>
LED2	LED<Connection to Outdoor Unit>
LED3	LED<Transmission : Sending>
LED4	LED<Transmission : Receiving>
LED5	LED<Power Supply : DC12V>

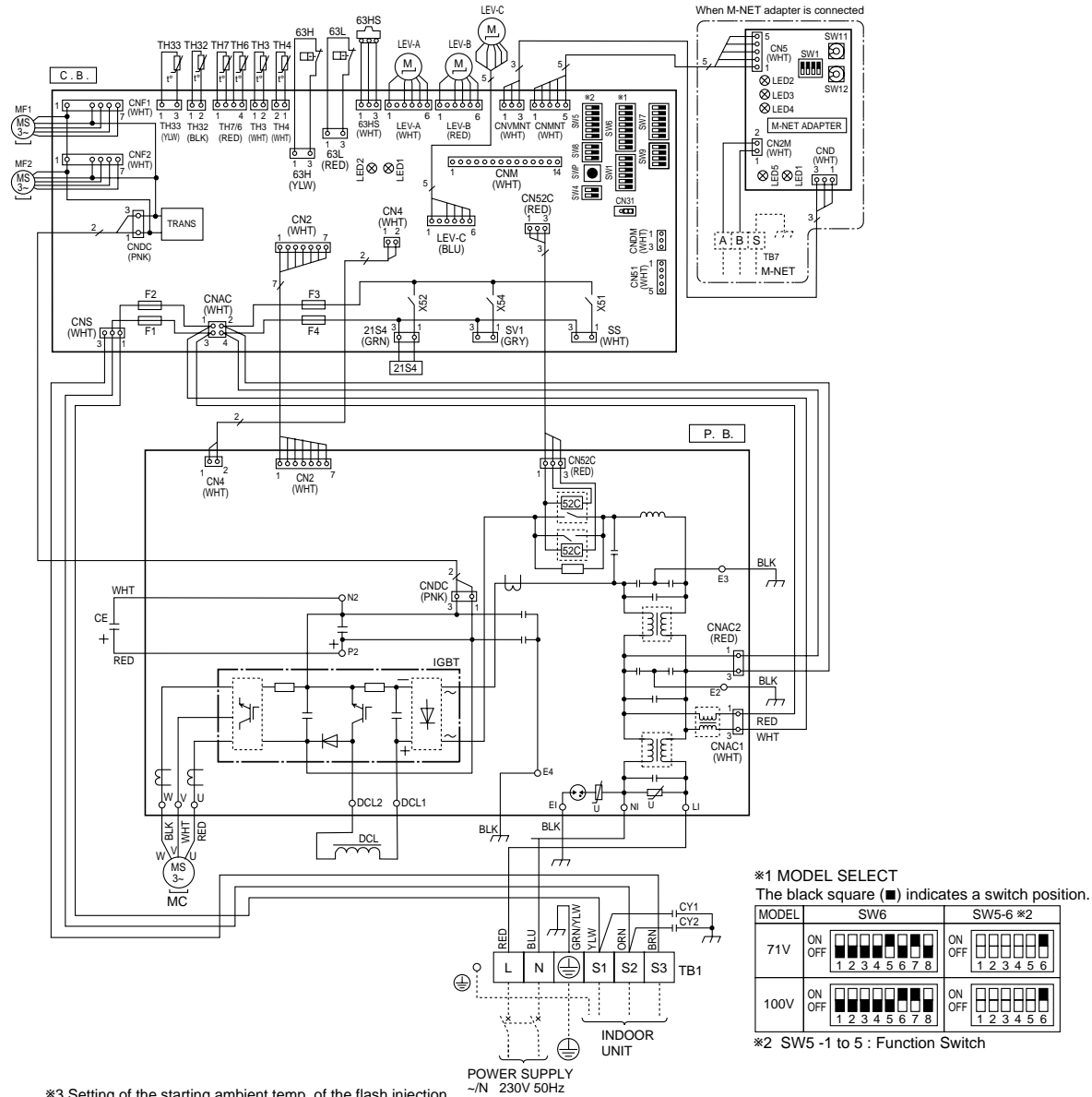

※3 Setting of the starting ambient temp. of the flash injection.

The black square (■) indicates a switch position.

Ambient temp.	SW9-3,4 ※4	Ambient temp.	SW9-3,4 ※4	Ambient temp.	SW9-3,4 ※4	Ambient temp.	SW9-3,4 ※4
3°C or less (Initial setting)	ON OFF <input type="checkbox"/> <input type="checkbox"/> <input type="checkbox"/> <input type="checkbox"/>	0°C or less	ON OFF <input type="checkbox"/> <input type="checkbox"/> <input type="checkbox"/> <input type="checkbox"/>	-3°C or less	ON OFF <input type="checkbox"/> <input type="checkbox"/> <input type="checkbox"/> <input type="checkbox"/>	-6°C or less	ON OFF <input type="checkbox"/> <input type="checkbox"/> <input type="checkbox"/> <input type="checkbox"/>

※4. SW9-1 to 2 : Function Switch

PUHZ-HRP100YHA2

PUHZ-HRP125YHA2

[LEGEND]

SYMBOL	NAME	SYMBOL	NAME	SYMBOL	NAME
TB1	Terminal Block<Power Supply>	P.B.	Power Circuit Board	C.B.	Controller Circuit Board
TB2	Terminal Block<Indoor/Outdoor >	TB-U/W/W	Connection Terminal<U/V/W-Phase>	SW1	Switch<Manual Defrost, Defect History Record Reset, Refrigerant Address>
MC	Motor for Compressor	TB-L1/L2/L3	Connection Terminal<L1/L2/L3-Power Supply>	SW4	Switch<Test Operation>
MF1, MF2	Fan Motor	TB-P2	Connection Terminal	SW5	Switch<Function Switch, Model select>
21S4	Solenoid Valve (Four-Way Valve)	TB-C1	Connection Terminal	SW6	Switch<Model Select>
63H	High Pressure Switch	TB-N1	Connection Terminal	SW7	Switch<Function Set up>
63L	Low Pressure Switch	X52A	52C Relay	SW8	Switch<Function Set up>
63HS	High Pressure Sensor	N.F.	Noise Filter Circuit Board	SW9	Switch<Function Switch>
TH3	Thermistor<Liquid>	L11/L12/L3/NI	Connection Terminal<L1/L2/L3/N-Power Supply>	SWP	Switch<Pump Down>
TH4	Thermistor<Discharge>	L01/L02/L03/NO	Connection Terminal<L1/L2/L3/N-Power Supply>	CN31	Connector<Emergency Operation>
TH6	Thermistor<Outdoor 2-Phase Pipe>	GD1_GD3	Connection Terminal<Ground>	SV1	Connector<Connection for Option>
TH7	Thermistor<Ambient>	CONV.B.	Converter Circuit Board	SS	Connector< Connection for Option>
TH32	Thermistor<Suction>	L1-A1/IN	Connection Terminal<L1-Power Supply>	LED1, LED2	LED<Operation Inspection Indicators>
TH33	Thermistor<Ref. check>	L1-A2/OU	Connection Terminal<L1-Power Supply>	CNM	Connector<A-Control Service Inspection Kit>
LEV-A, LEV-B, LEV-C	Electronic Expansion Valve	L2-A2/OU	Connection Terminal<L2-Power Supply>	CNDM	Connector < Connection for Option(Contact Input)>
ACL1~ACL4	Reactor	L3-A2/OU	Connection Terminal<L3-Power Supply>	F1-F4	Fuse<T6.3AL250V>
RS	Rush Current Protect Resistor	N-N	Connection Terminal	X51, X52, X54	Relay
CB1, CB2	Main Smoothing Capacitor	CK-OU	Connection Terminal		
CK	Capacitor				

M-NET ADAPTER

SYMBOL	NAME
TB7	Terminal Block<M-NET connection>
CN5	Connector<Transmission>
CND	Connector<Power Supply>
CNM2	Connector<M-NET communication>
SW1	Switch<Status of communication>
SW11	Switch<Address setting : 1s digit>
SW12	Switch<Address setting : 10s digit>
LED1	LED<Power Supply : DC5V>
LED2	LED<Connection to Outdoor Unit>
LED3	LED<Transmission : Sending>
LED4	LED<Transmission : Receiving>
LED5	LED<Power Supply : DC12V>

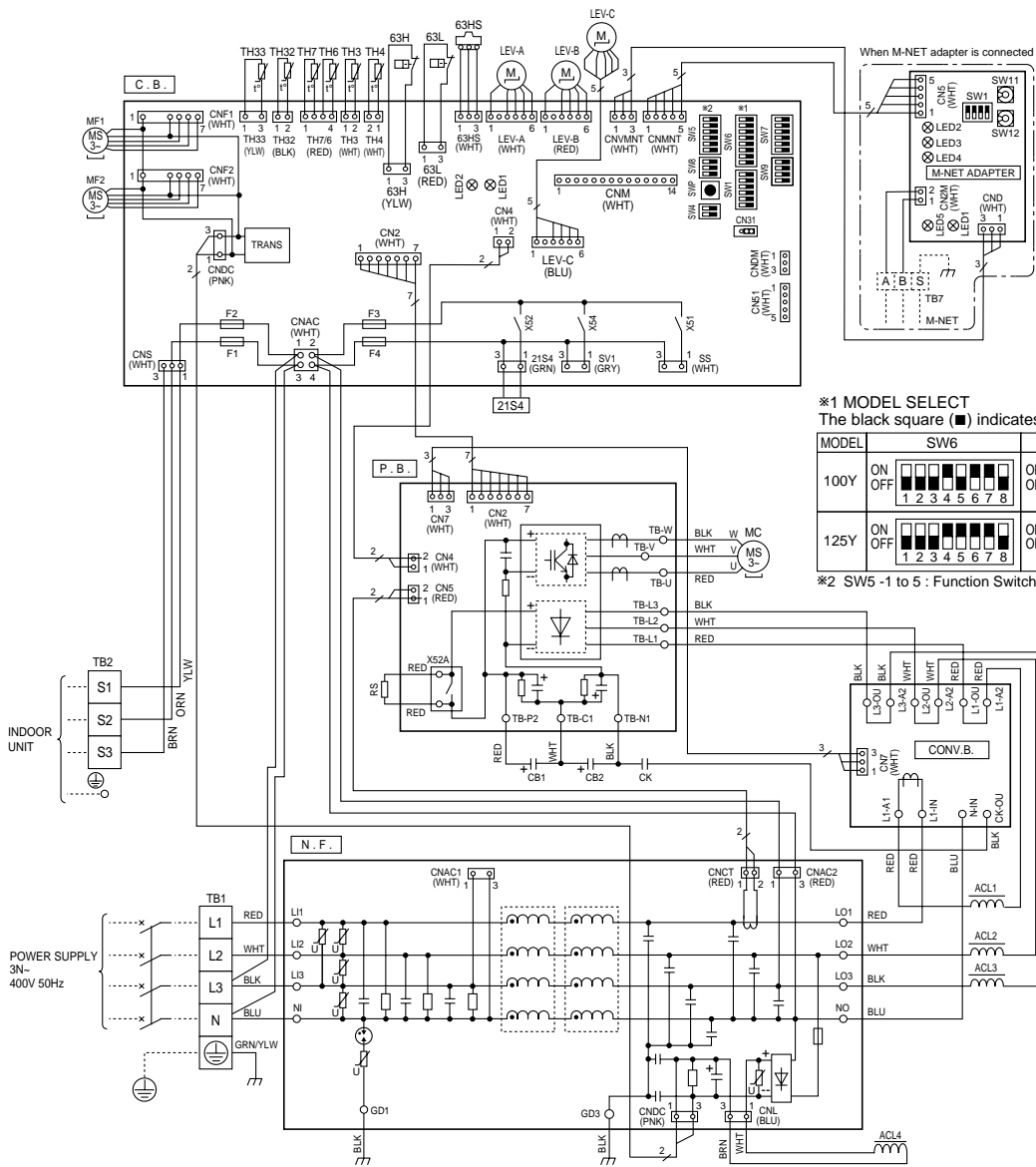

*1 MODEL SELECT

The black square (■) indicates a switch position.

MODEL	SW6	SW5-6 *2
100Y	ON OFF 1 2 3 4 5 6 7 8	ON OFF 1 2 3 4 5 6
125Y	ON OFF 1 2 3 4 5 6 7 8	ON OFF 1 2 3 4 5 6

*2 SW5 -1 to 5 : Function Switch

*3 Setting of the starting ambient temp. of the flash injection.

The black square (■) indicates a switch position.

Ambient temp.	SW9-3,4 *4	Ambient temp.	SW9-3,4 *4	Ambient temp.	SW9-3,4 *4	Ambient temp.	SW9-3,4 *4
3°C or less (Initial setting)	ON OFF 1 2 3 4	0°C or less	ON OFF 1 2 3 4	-3°C or less	ON OFF 1 2 3 4	-6°C or less	ON OFF 1 2 3 4

*4. SW9-1 to 2 : Function Switch

5-1. INDOOR UNIT
 PLA-RP-BA/BA2/BA3
 PKA-RP-FAL(2)
 PEAD-RP-EA(2)

PKA-RP-GAL
 PEAD-RP-JA(L)
 PEAD-RP-GA

unit : mm

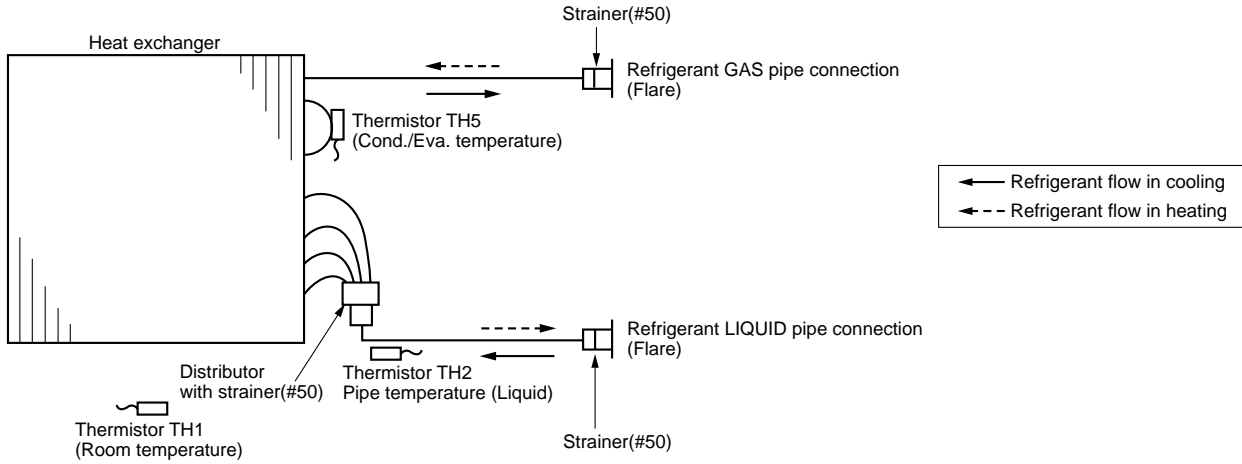

PKA-RP-HAL
 PKA-RP-KAL

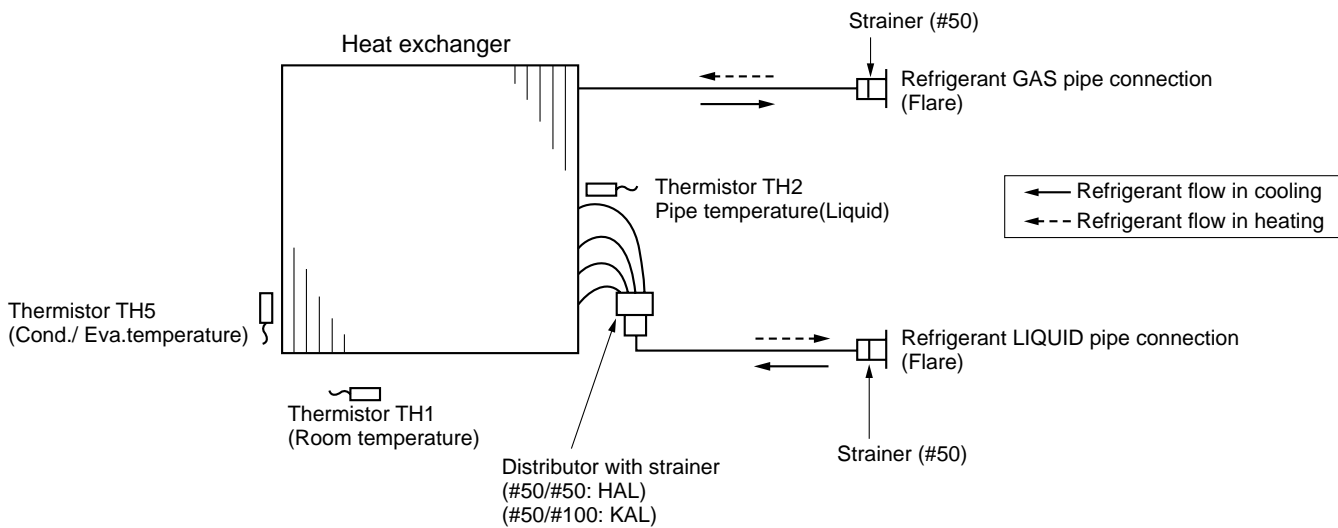

5-2. OUTDOOR UNIT
PUHZ-HRP71VHA

PUHZ-HRP100VHA

PUHZ-HRP100YHA

PUHZ-HRP125YHA

Unit : mm (inch)

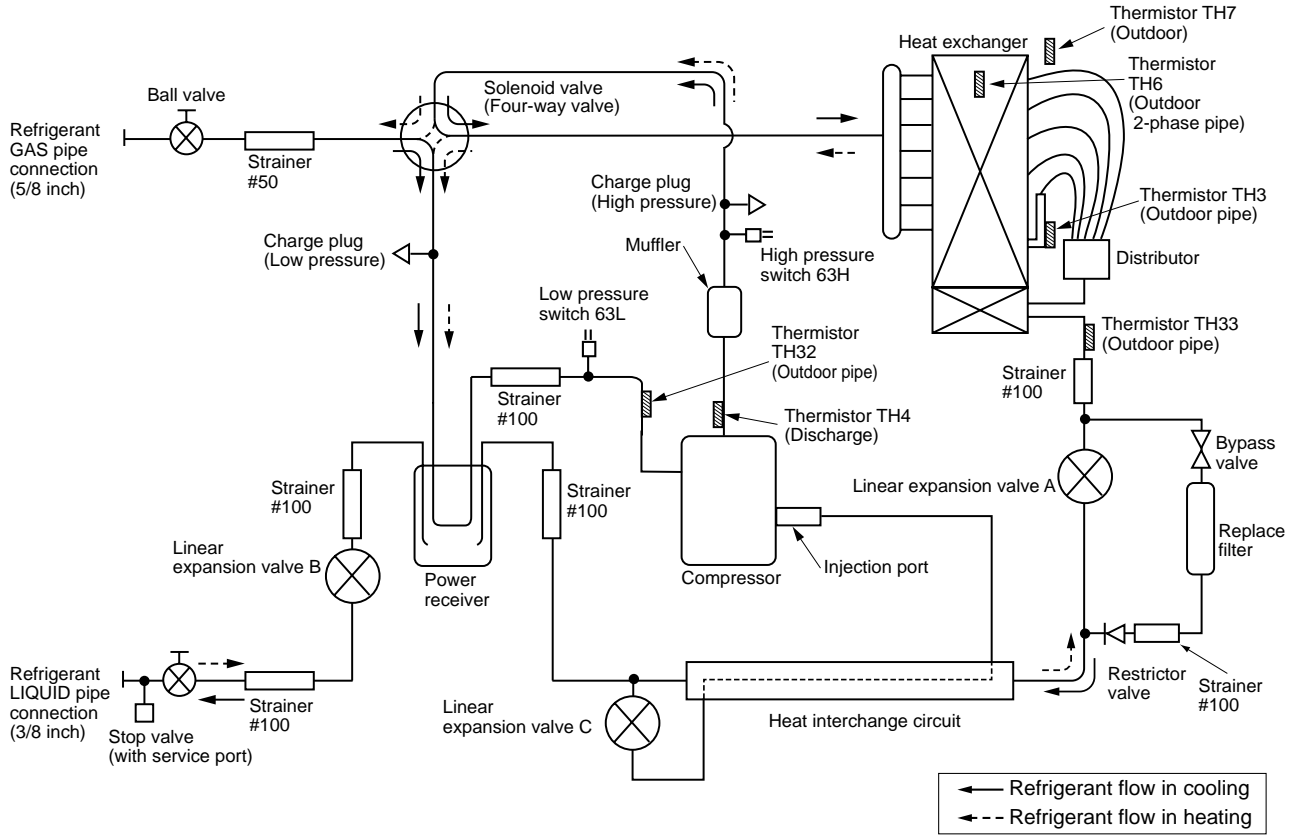

PUHZ-HRP71VHA2

PUHZ-HRP100VHA2

PUHZ-HRP100YHA2

PUHZ-HRP125YHA2

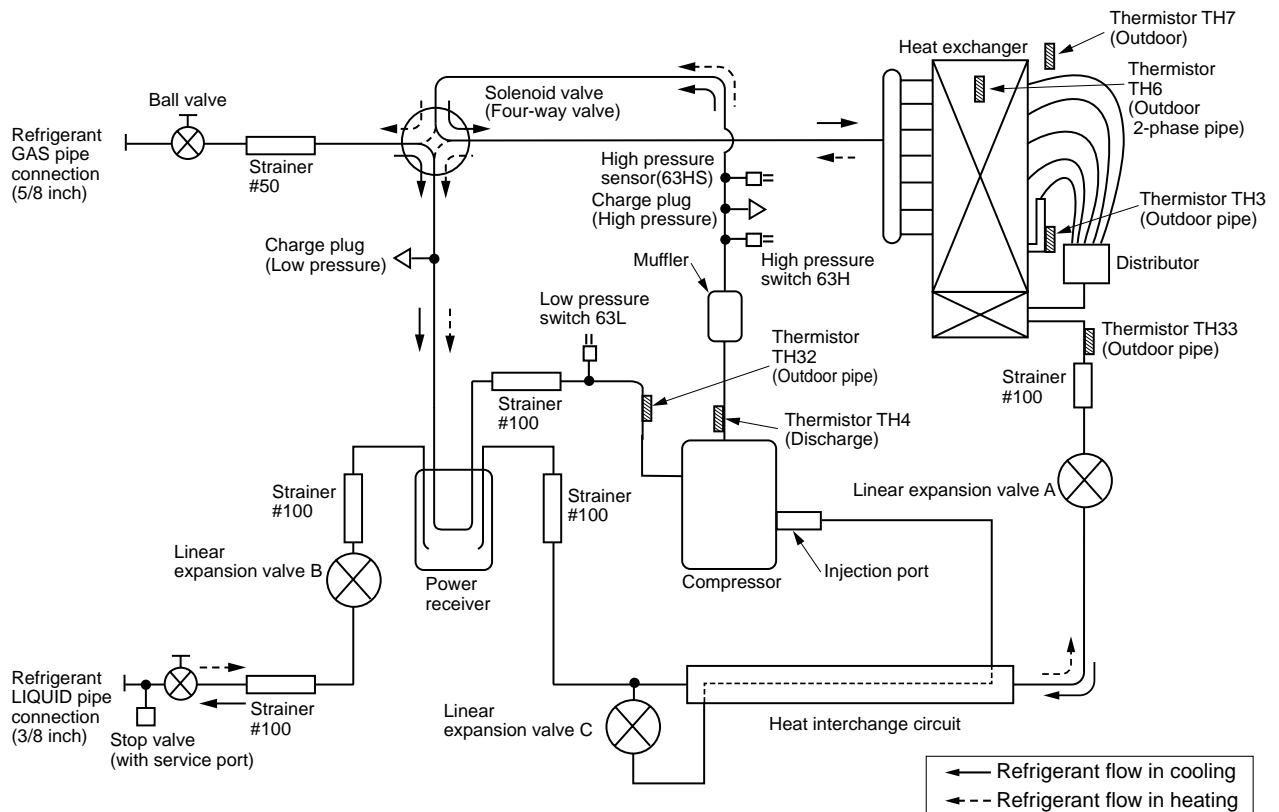

FOR THE COMBINATION OF OUTDOOR UNIT PUHZ-HRP-VHA(2), PUHZ-HRP-YHA(2)

Rated cooling capacity

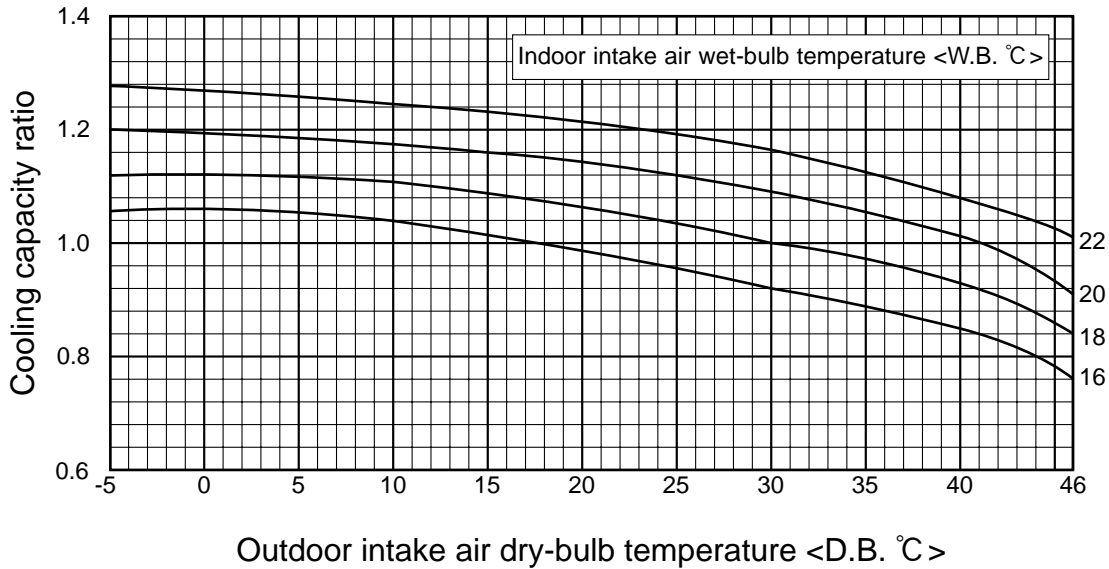

Rated cooling input

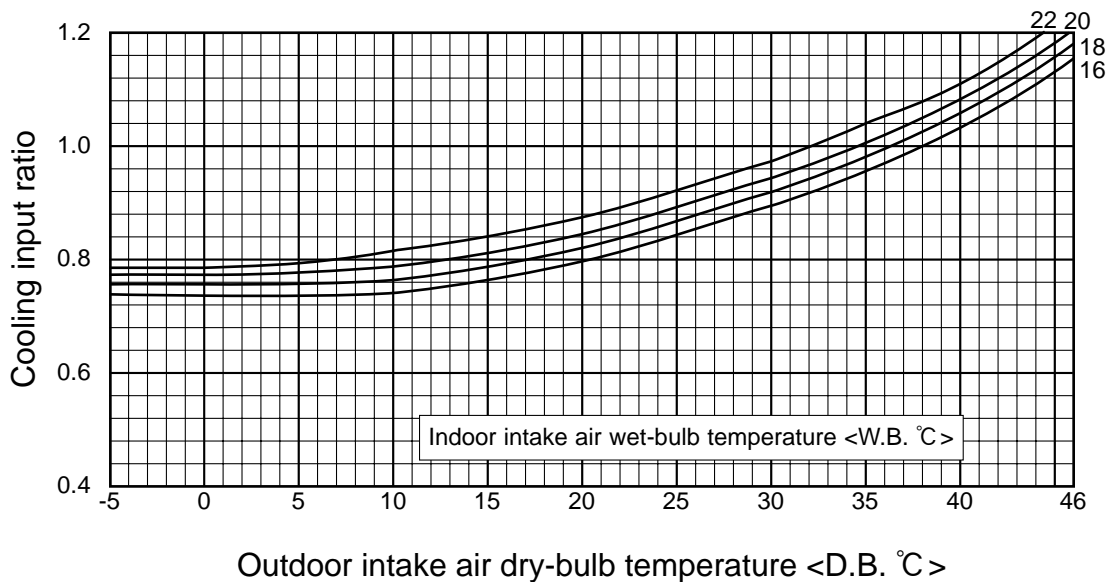

Note : This diagrams show the case where the operation frequency of a compressor is fixed.

Rated heating capacity

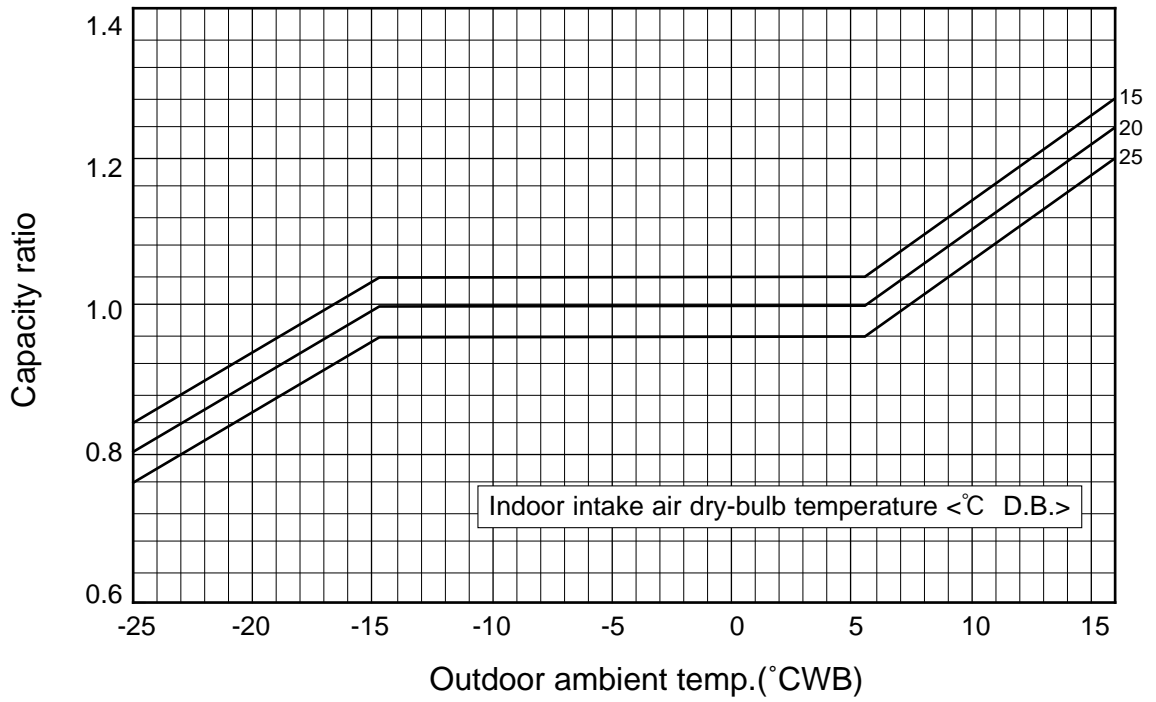

Rated heating input

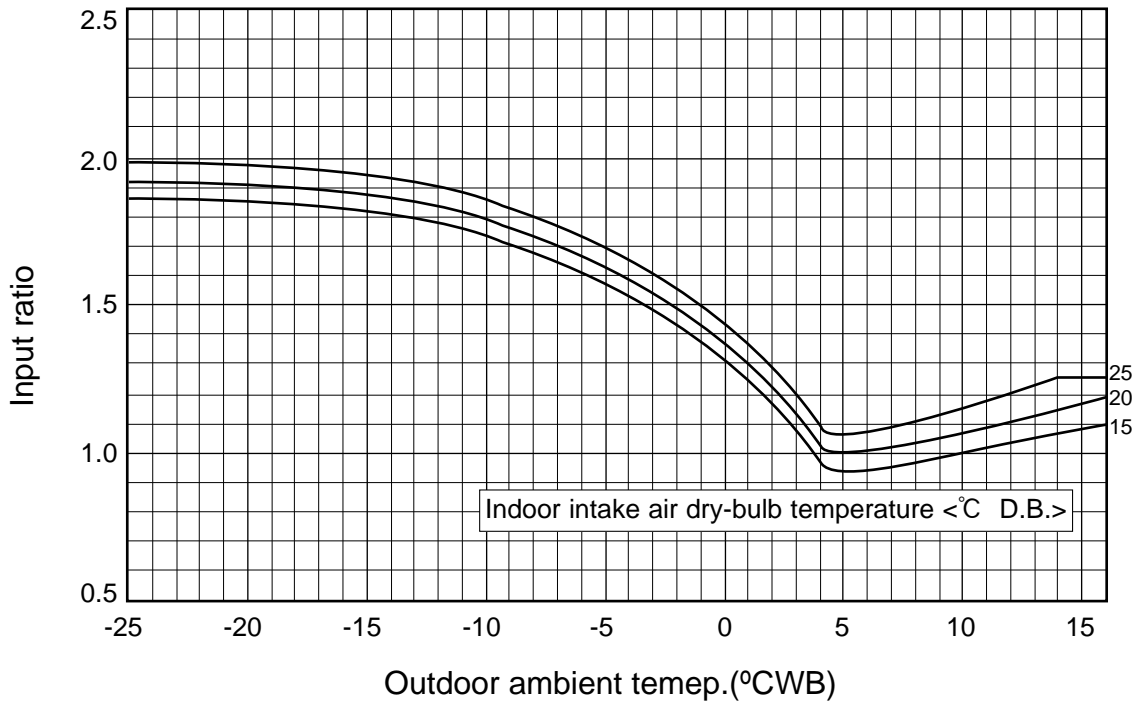

PUHZ-HRP71, 100VHA(2) PUHZ-HRP100, 125YHA(2)**Cooling capacity correction factors**

Outdoor unit	Refrigerant piping length (one way)									
	5m	10m	20m	30m	40m	50m	55m	60m	70m	80m
PUHZ-HRP71VHA(2)	1.00	0.988	0.966	0.946	0.929	0.913	0.905	0.897	0.876	0.870
PUHZ-HRP100VHA(2) PUHZ-HRP100YHA(2)	1.00	0.985	0.957	0.931	0.908	0.886	0.876	0.865	0.846	0.829
PUHZ-HRP125YHA(2)	1.00	0.981	0.946	0.914	0.885	0.858	0.845	0.834	0.812	0.792

Heating capacity correction factors

Outdoor unit	Refrigerant piping length (one way)									
	5m	10m	20m	30m	40m	50m	55m	60m	70m	80m
PUHZ-HRP71VHA(2)	1.00	0.997	0.991	0.985	0.979	0.973	0.970	0.967	0.961	0.955
PUHZ-HRP100VHA(2) PUHZ-HRP100YHA(2)	1.00	0.997	0.991	0.985	0.979	0.973	0.970	0.967	0.961	0.955
PUHZ-HRP125YHA(2)	1.00	0.997	0.991	0.985	0.979	0.973	0.970	0.967	0.961	0.955

8-1. PIPE LENGTH

8-1-1. 1:1 SYSTEM

Pipe length

<Table 1> Maximum pipe length

Liquid pipe (mm)	OD	φ9.52			φ12.7	
	Thickness	t0.8			t0.8	
Gas pipe (mm)	OD	φ12.7	φ15.88	φ19.05	φ15.88	φ19.05
	Thickness	t0.8	t1.0	t1.0	t1.0	t1.0
HRP71-125		Standard size	○	△	△	
		50m * [30m]	50m [30m]	50m [20m]	50m [20m]	

* The maximum length is 75m in case of new pipes.

<Marks in the table>

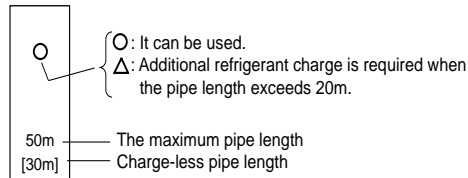

8-1-2. TWIN SYSTEM

(1) TWIN SYSTEM

<Table 2> Maximum pipe length

Main pipe (mm) [A]	Liquid pipe	HRP71(RP35×2)		HRP100(RP50×2)			HRP125(RP60×2)			
		φ6.35	φ9.52	φ9.52	φ9.52	φ12.7	φ9.52	φ9.52	φ12.7	
Branch pipe (mm) [B, C]	Gas pipe	φ12.7	φ15.88	φ15.88	φ19.05	φ19.05	φ15.88	φ19.05	φ19.05	
	Liquid pipe	φ6.35	Standard size	Standard size	○	△				
	Gas pipe	φ12.7	50m * [30m]	50m * [30m]	50m [30m]	50m [20m]				
	Liquid pipe	φ9.52		○	○	○	△	Standard size	○	
	Gas pipe	φ15.88		50m [30m]	50m [30m]	50m [30m]	50m [20m]	50m * [30m]	50m [30m]	△ 50m [20m]
	Liquid pipe	φ9.52								
Gas pipe	φ19.05									

* The maximum length is 75m in case of new pipes.

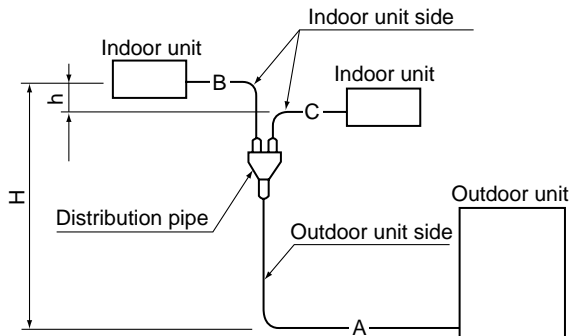

<TWIN SYSTEM>

Total length A + B + C

Max. 75 m

Height difference

H(Indoor unit-Outdoor unit) Max. 30m

h(Indoor unit-Indoor unit) Max. 1m

Distance between indoor and indoor units

Pipe length |B-C|

Max. 8m

Number of bends (one way)

Max. 15 (Max. 8 points between main pipe A and each branch pipe(B, C))

8-2. ADJUSTING THE AMOUNT OF REFRIGERANT

- Check additional refrigerant charging amount referring to table 5, 6 when liquid pipe is one size larger than standard diameter.

<Table 5> Required additional charge when the liquid pipe is one size larger than the standard diameter (1:1 SYSTEM)

Outdoor unit	Liquid pipe O.D.	Refrigerant amount to be added (Exceeding 20m)
PUHZ-HRP71-125	φ12.7	100 g per 1 m

<Table 6> Required additional charge when the liquid pipe is one size larger than the standard diameter (TWIN SYSTEM)

Outdoor unit	When the extension pipe length (main piping + branch piping) exceed 20 m
PUHZ-HRP71-125	Additional refrigerant amount $\Delta W(g) = (100 \times L1) + (60 \times L2) + (30 \times L3) - 2000$

If the calculation produces a negative number ($\Delta W \leq 0$), additional charging is not necessary.

L1: φ12.7 liquid pipe length (m)

L2: φ9.52 liquid pipe length (m)

L3: φ6.35 liquid pipe length (m)

<Table 7> Additional refrigerant charging amount for pipe of standard diameter

Type	Outdoor unit	Permitted pipe length	Amount of unit filling refrigerant (kg)	Additional refrigerant charging amount for pipe length exceeding 30 m (kg)				
				31 – 40m	41 – 50m	51 – 60m	61 – 70m	71 – 75m
1 : 1 system	PUHZ-HRP71-125	75m or less	5.5kg	0.6kg	1.2kg	1.8kg	2.4kg	

Type	Outdoor unit	Permitted pipe length	Amount of unit filling refrigerant (kg)	Additional refrigerant charging amount for pipe length exceeding 30 m (kg)				
				31 – 40m	41 – 50m	51 – 60m	61 – 70m	71 – 75m
Twin system	PUHZ-HRP71-125	75m or less	5.5kg	0.6kg	1.2kg	1.8kg	2.4kg	

8-3. CAPACITY CORRECTION CURVES

Cooling and heating capacity is lowered according to pipe length. Capacity can be obtained by referring to the capacity curves below. When the diameter of gas pipe is one size smaller than standard diameter, cooling capacity is lowered comparing to the standard diameter. The lowered capacity can be obtained by referring to capacity curves for gas pipe which is one size smaller than standard size.

$$\text{Corrected pipe length (m)} = \text{actual pipe length (m)} + \text{number of bends} \times 0.3 \text{ (m)}$$

[Sample calculation]

Indoor unit RP60 × 2 units (Twin system)

Outdoor unit HRP125 × 1

- Condition Using existing pipes.
 - Outdoor unit side
Liquid pipe $\phi 12.7$ / Gas pipe $\phi 19.05$
pipe length (A) 20m
 - Indoor unit side
Liquid pipe $\phi 9.52$ / Gas pipe $\phi 15.88$
pipe length (B) 20m + (C) 15m

- 1) Farthest piping length 20m + 15m = 35m
Number of bends : 10
- 2) Corrected piping length 35m + 0.3 × 10 = 38m
- 3) Capacity correction Outdoor unit side's gas pipe $\phi 19.05$
Standard $\phi 15.88 \rightarrow 1$ size up
Refer to ① Capacity curves <Standard size>
- 4) Capacity
Cooling capacity = Standard cooling capacity × 0.89
Heating capacity = Standard heating capacity × 0.98

① Capacity curves for PUHZ-HRP · HA(2) model <Standard size>

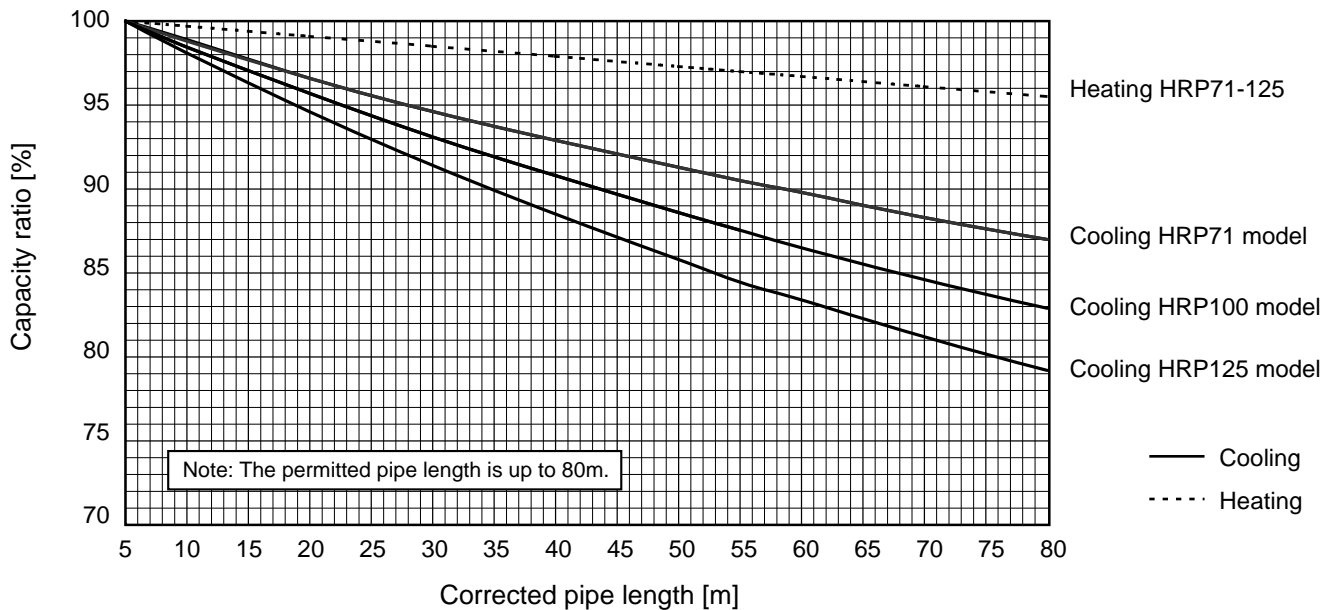

② When gas pipe is one size larger than standard size for PUHZ-HRP71-125.

① Capacity can be obtained by referring to capacity curves of standard size.

9-1. OUTLET AIR SPEED AND COVERAGE RANGE

		PLA-RP36BA	PLA-RP50BA	PLA-RP60BA	PLA-RP71BA2	PLA-RP100BA PLA-RP100BA2 PLA-RP100BA3	PLA-RP125BA PLA-RP125BA2
Air flow	m ³ /min.	15	18	18	21	30	31
Air speed	m/sec.	2.6	3.2	3.2	3.7	5.3	5.4
Coverage range	m	4.1	4.8	4.8	5.6	8	8.2

		PKA-RP35GAL	PKA-RP50GAL
Air flow	m ³ /min.	12	12
Air speed	m/sec.	5.3	5.3
Coverage range	m (ft)	10 (32.8)	10(32.8)

		PKA-RP50FAL2 PKA-RP60FAL	PKA-RP100FAL
Air flow	m ³ /min.	20	28
Air speed	m/sec.	4.9	5.4
Coverage range	m (ft)	12.4(40.7)	15.3 (50.2)

		PKA-RP35HAL	PKA-RP50HAL
Air flow	m ³ /min.	12	12
Air speed	m/sec.	6.1	6.1
Coverage range	m (ft)	10.8 (35.4)	10.8 (35.4)

		PKA-RP60KAL	PKA-RP100KAL
Air flow	m ³ /min.	22	26
Air speed	m/sec.	6.0	6.8
Coverage range	m (ft)	14.3 (46.9)	16.1 (52.8)

* The air coverage range is the distance to which the 0.25 m/sec air can reach, when air is blown out horizontally from the unit at the High notch position.

The coverage range should be used only as a general guideline since it varies according to the size of the room and the furniture inside the room.

9-2. PLA-RP-BA/BA2/BA3

9-2-1 FRESH AIR INTAKE AND BRANCH DUCT

1. Branch duct hole and fresh air intake hole (Fig. 1)

At the time of installation, use the duct holes (cut out) located at the positions shown in Fig.1, as and when required.

- A fresh air intake hole for the optional multi function casement can also be made.

Note:

The figure marked with * in the drawing represent the dimensions of the main unit excluding those of the optional multi function casement.

When installing the optional multi function casement, add 135 mm to the dimensions marked on the figure.

When installing the branch ducts, be sure to insulate adequately.

Otherwise condensation and dripping may occur.

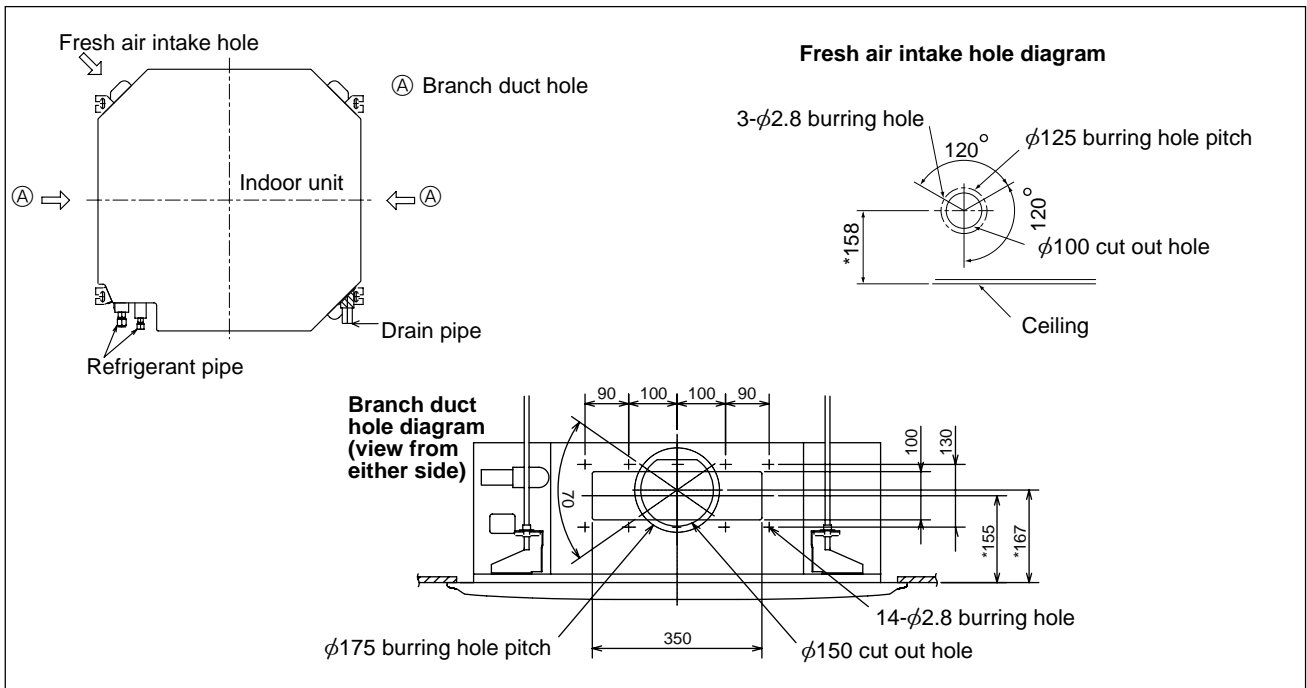
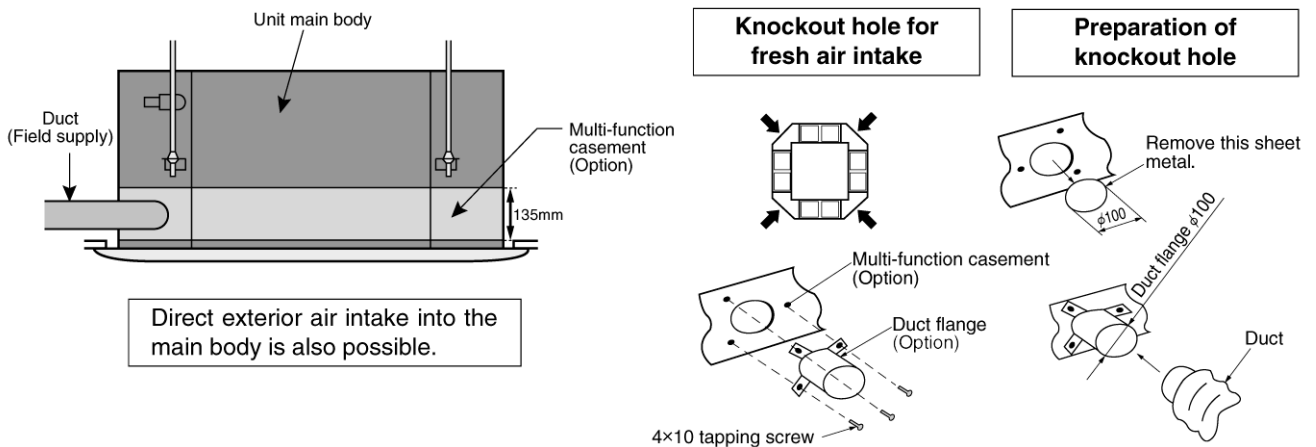

Fig. 1

2. Fresh air intake (Installation at site)

- By mounting the optional multi-function casement to the indoor unit main body, and mounting the duct and duct flange (option) onto it further, fresh exterior air intake can be accomplished.

(The mounting of the multi-function casement increases the height of the ceiling plenum by 135mm.)



3. Fresh air intake volume & static pressure characteristics

How to read the chart

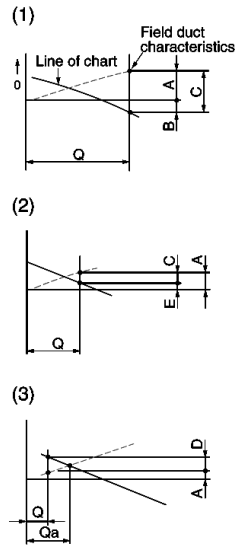

- Q Design fresh air intake volume (m³/min)
- A Static pressure loss [Pa] of fresh air intake duct at air flow rate of Q
- B Required boost pressure [Pa] of air conditioner inlet at air flow rate of Q
- C Required static pressure [Pa] of booster fan at air flow rate of Q
- D Required compensation [Pa] for static pressure loss of fresh air intake duct to make air flow rate Q
- E Static pressure [Pa] of indoor unit at air flow rate of Q
- Qa .. Estimated fresh air intake [m³/min] without compensation of D

PLA-RP35~60BA PLA-RP71BA2

① At using multi-function casement, standard filter

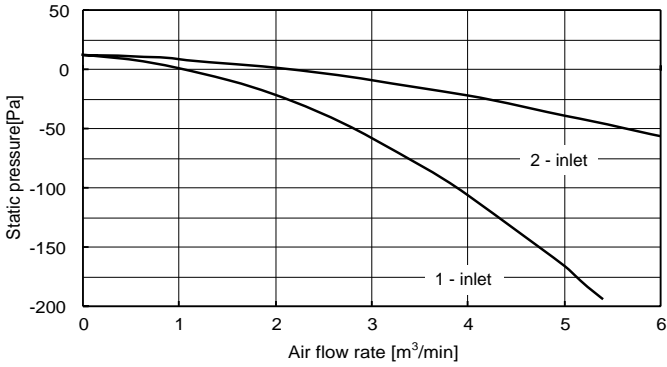

② Direct intake to unit

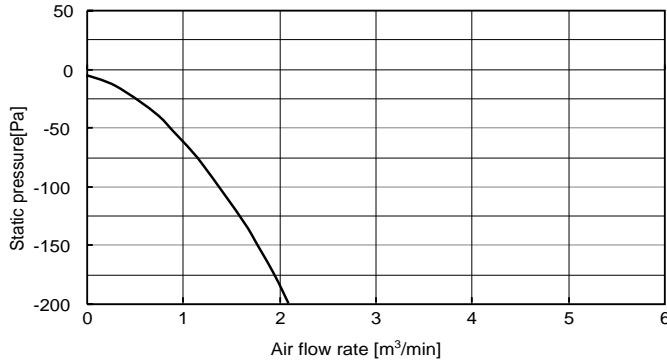

③ At using multi-function casement, high efficiency filter

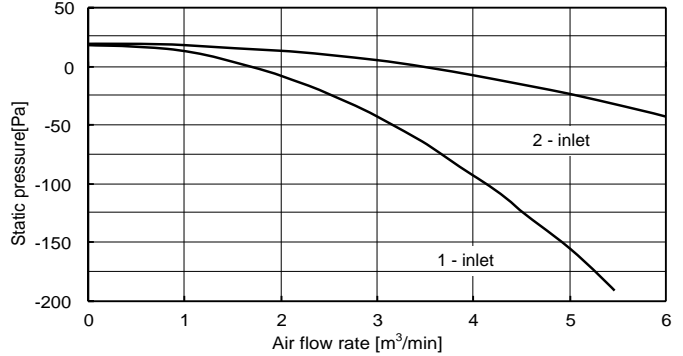

PLA-RP100BA/BA2/BA3, 125BA(2)

① At using multi-function casement, standard filter

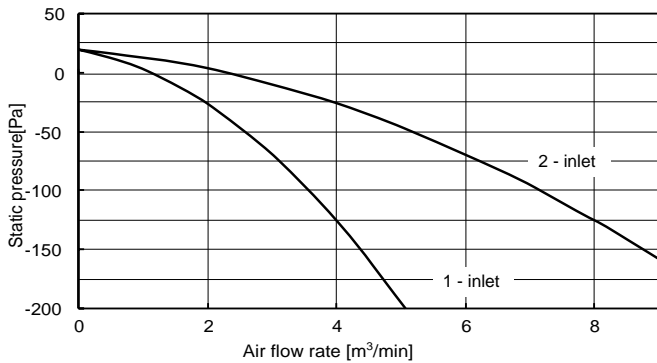

② Direct intake to unit

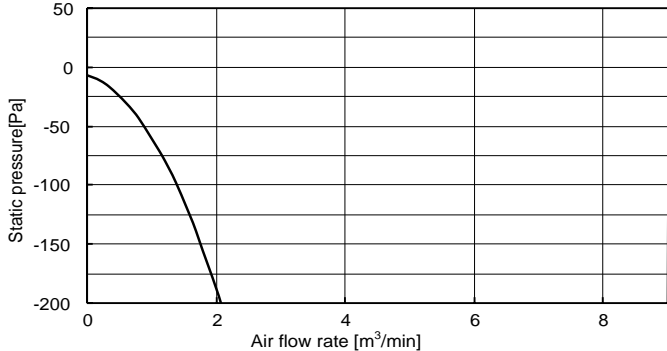

③ At using multi-function casement, high efficiency filter

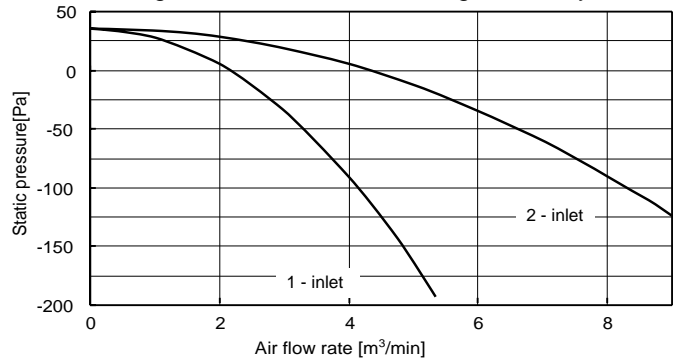

4. Change of outlet numbers

The optional air outlet is necessary.
To change the air outlet number to 3-, or 2-way outlet, the outlet number should be closed with the operational air outlet shutter.

When the air outlets are closed, close the vane by removing the vane connector.

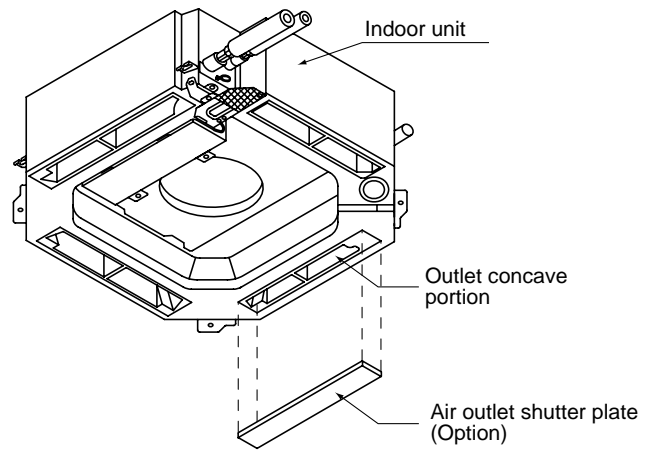
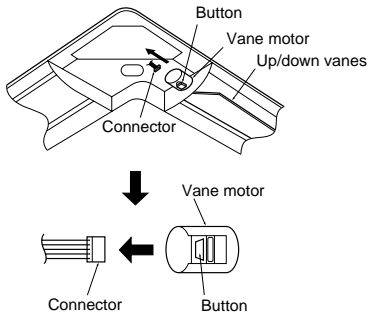

5. Branch duct and change of outlet numbers

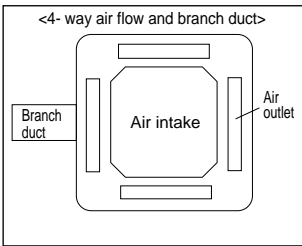

※ Branch duct should be connected to one of the branch duct holes on the main unit.

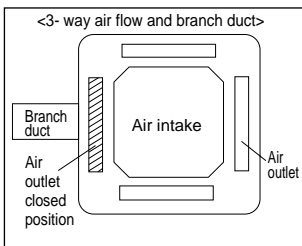

※ Close the outlet on the side of branch duct and air flows in 3 directions.

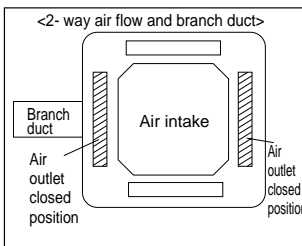

※ The outlet on the side of branch duct and one of the other outlets are closed. Air flows in 2 directions.

PLA-RP71BA2

● 4-way airflow (horizontal vane) Round duct

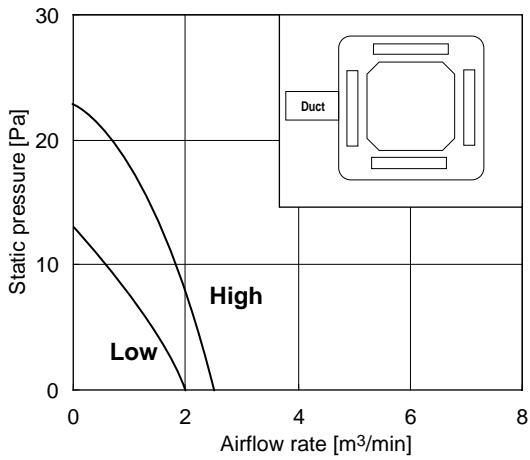

● 4-way airflow (horizontal vane) Rectangular duct

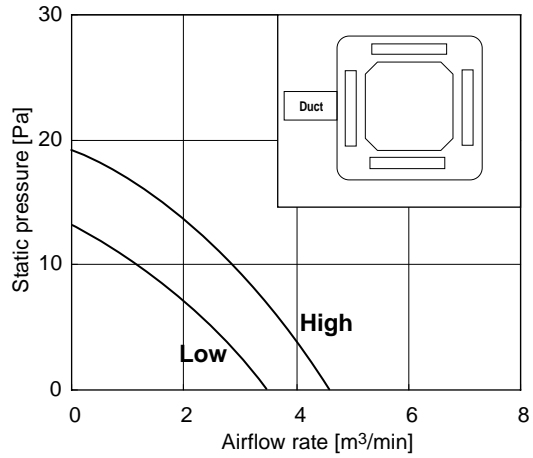

● 3-way airflow (horizontal vane) Round duct

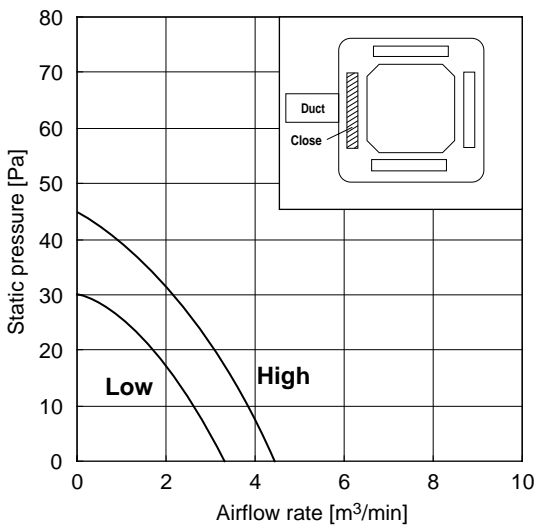

● 3-way airflow (horizontal vane) Rectangular duct

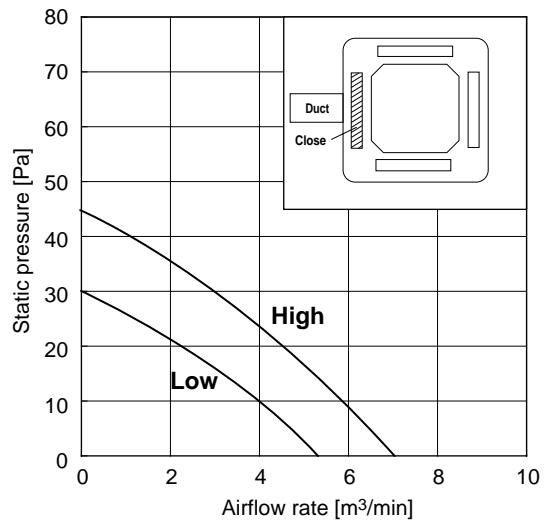

● 2-way airflow (horizontal vane) Round duct

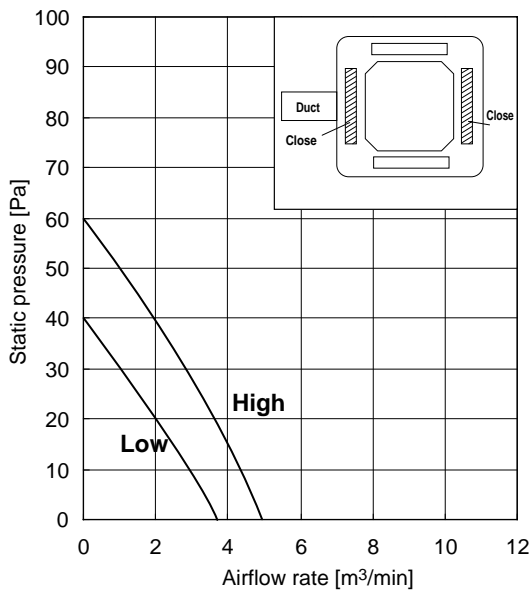

● 2-way airflow (horizontal vane) Rectangular duct

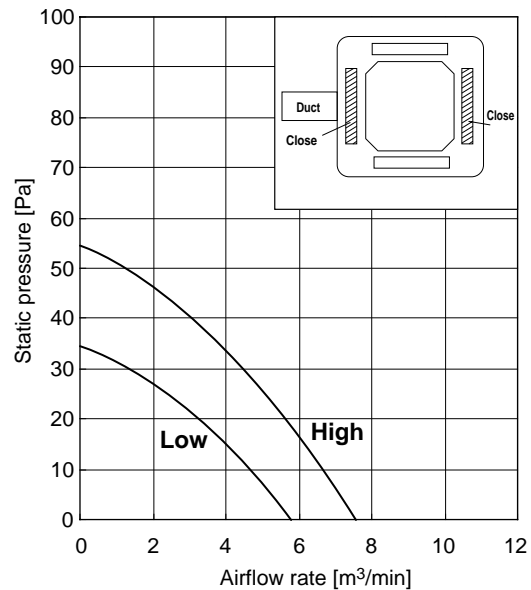

- Use 1 of the 2 duct holes on the indoor unit.
- Airflow rate of PLA-RP35-60BA can be calculated from the airflow rate based on the characteristic of the duct for PLA-RP71BA2.
- Use the optional air outlet shutter plate (PAC-SH51SP-E) for 3-way and 2-way airflow.

PLA-RP125BA(2)

● 4-way airflow (horizontal vane) Round duct

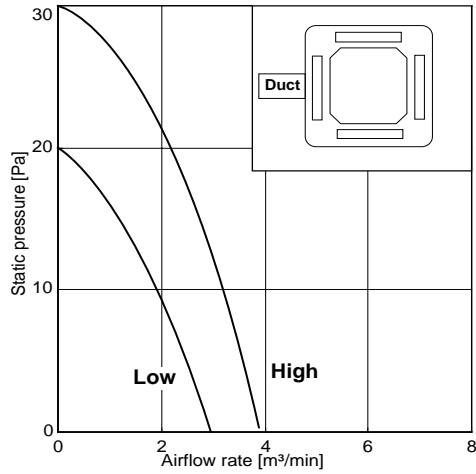

● 4-way airflow (horizontal vane) Rectangular duct

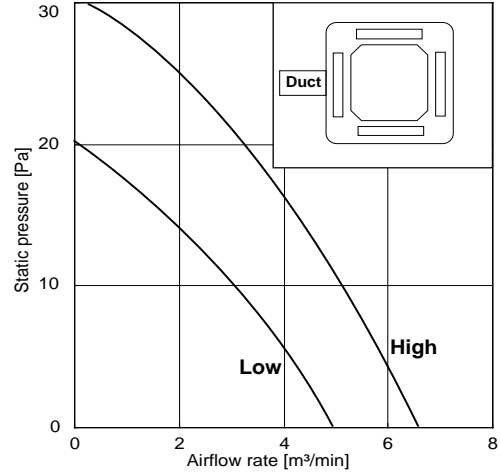

● 3-way airflow (horizontal vane) Round duct

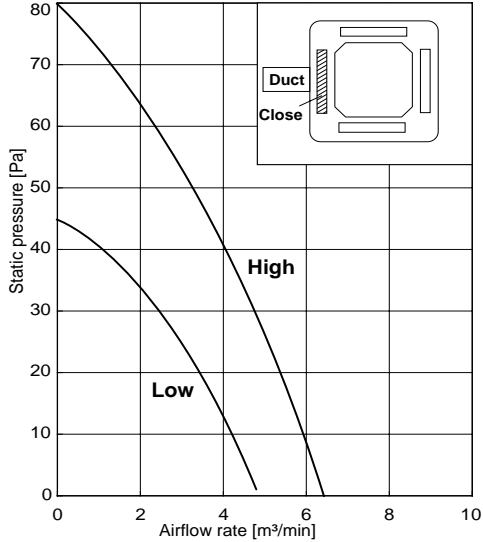

● 3-way airflow (horizontal vane) Rectangular duct

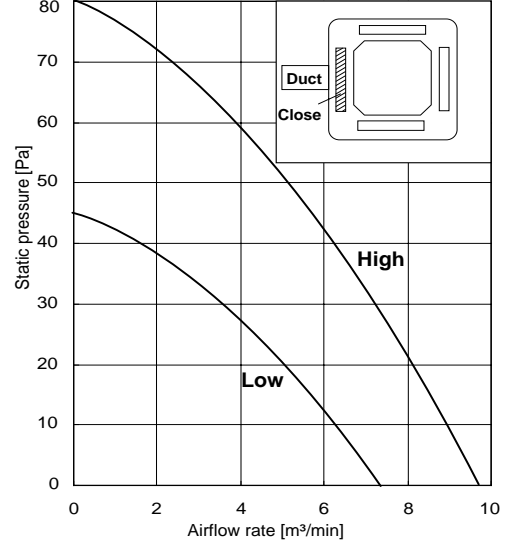

● 2-way airflow (horizontal vane) Round duct

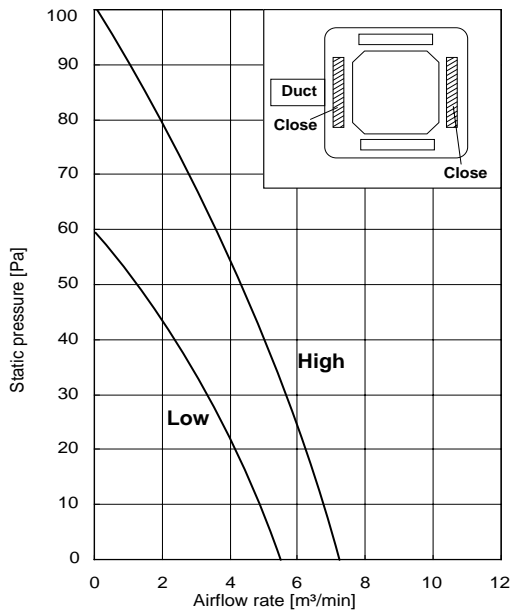

● 2-way airflow (horizontal vane) Rectangular duct

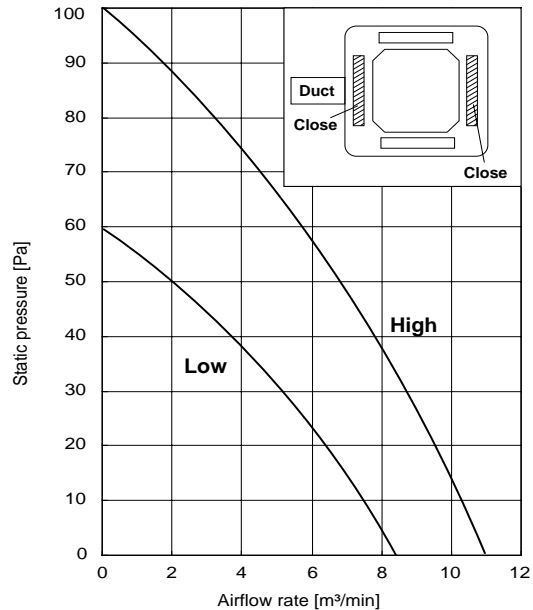

- Use 1 of the 2 duct holes on the indoor unit.
- Airflow rate of PLA-RP100BA/BA2/BA3 can be calculated from the airflow rate based on the characteristic of the duct for PLA-RP125BA(2).
- Use the optional air outlet shutter plate (PAC-SH51SP-E) for 3-way and 2-way airflow.

9-3. PEAD-RP-JA(L) Fan performance

PEAD-RP35JA(L)
(External static pressure 35Pa) 220-240V 50Hz

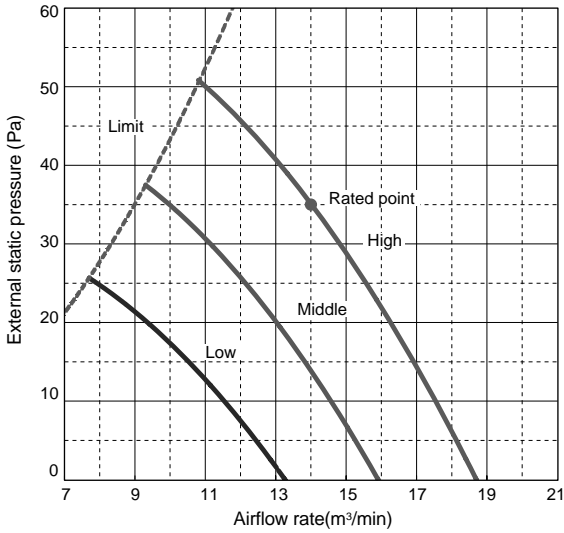

PEAD-RP35JA(L)
(External static pressure 100Pa) 220-240V 50Hz

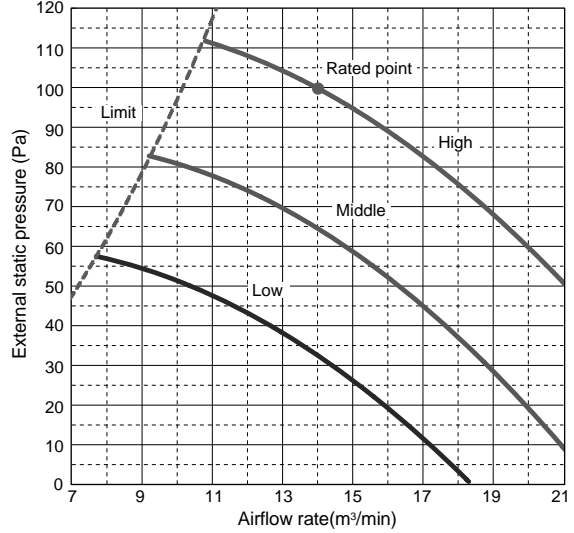

PEAD-RP35JA(L)
(External static pressure 50Pa) 220-240V 50Hz

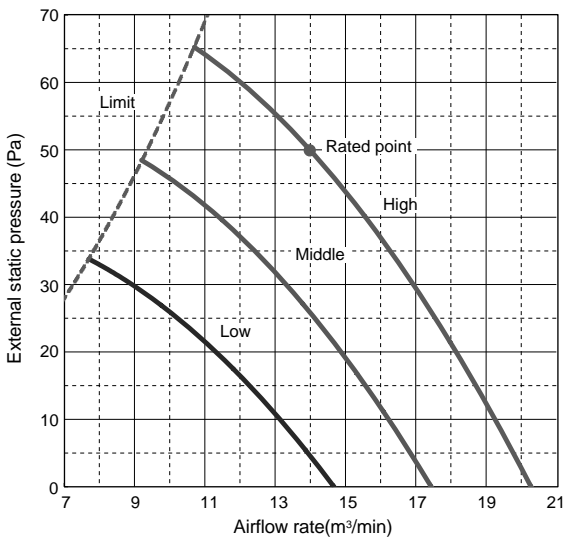

PEAD-RP35JA(L)
(External static pressure 150Pa) 220-240V 50Hz

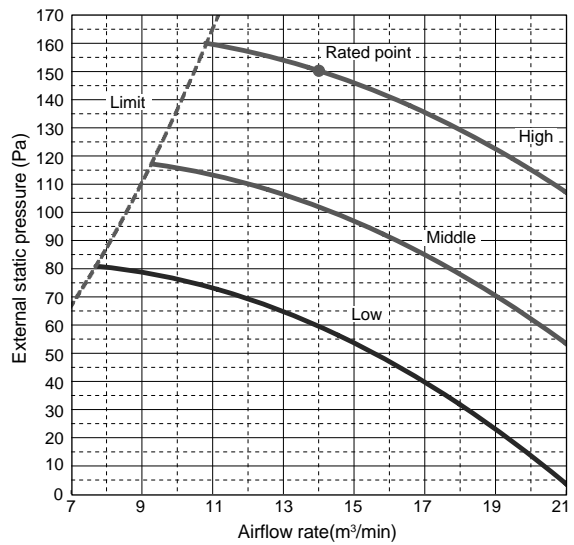

PEAD-RP35JA(L)
(External static pressure 70Pa) 220-240V 50Hz

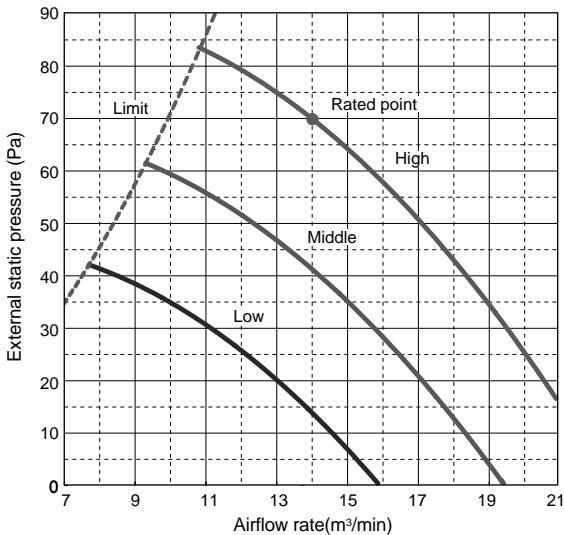

PEAD-RP50JA(L)
 (External static pressure 35Pa) 220-240V 50Hz

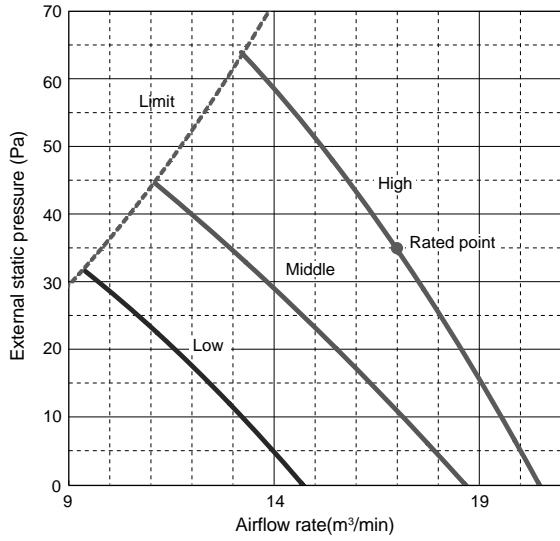

PEAD-RP50JA(L)
 (External static pressure 100Pa) 220-240V 50Hz

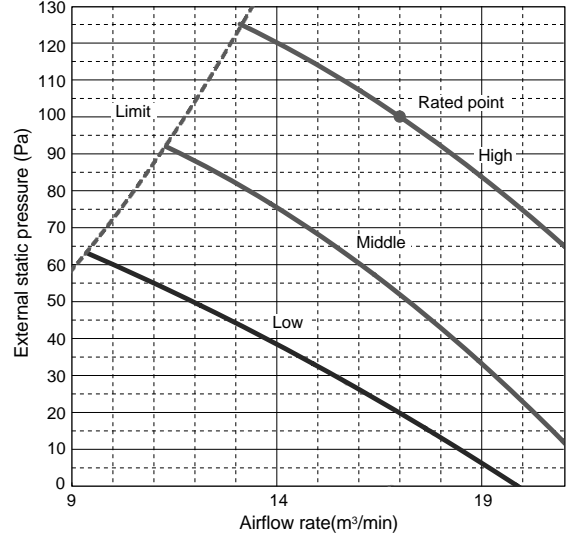

PEAD-RP50JA(L)
 (External static pressure 50Pa) 220-240V 50Hz

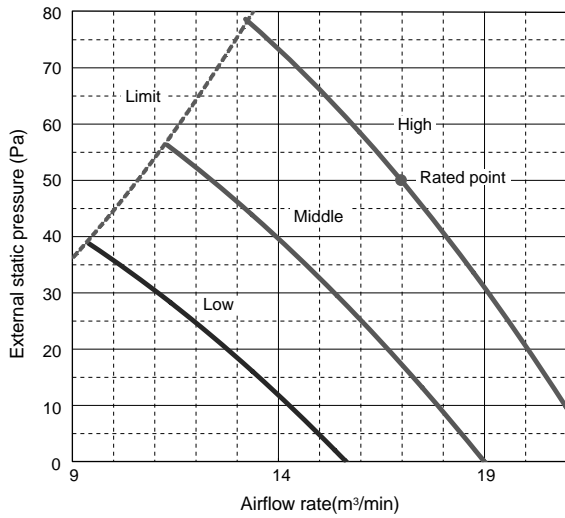

PEAD-RP50JA(L)
 (External static pressure 150Pa) 220-240V 50Hz

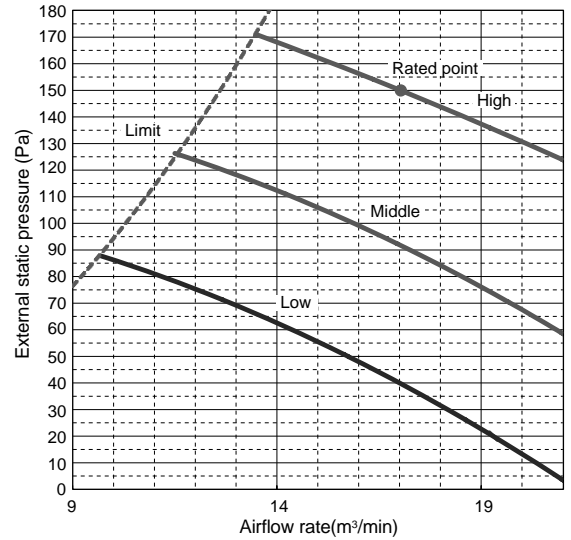

PEAD-RP50JA(L)
 (External static pressure 70Pa) 220-240V 50Hz

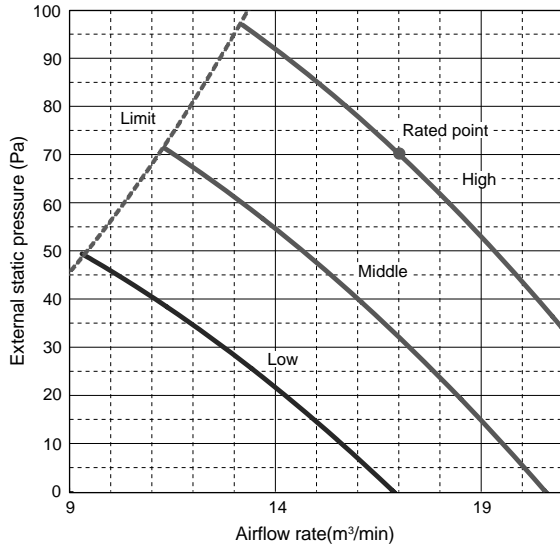

PEAD-RP60JA(L)
 (External static pressure 35Pa) 220-240V 50Hz

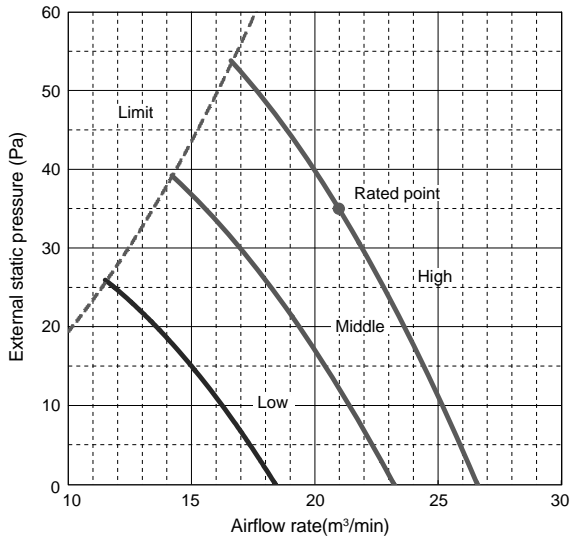

PEAD-RP60JA(L)
 (External static pressure 100Pa) 220-240V 50Hz

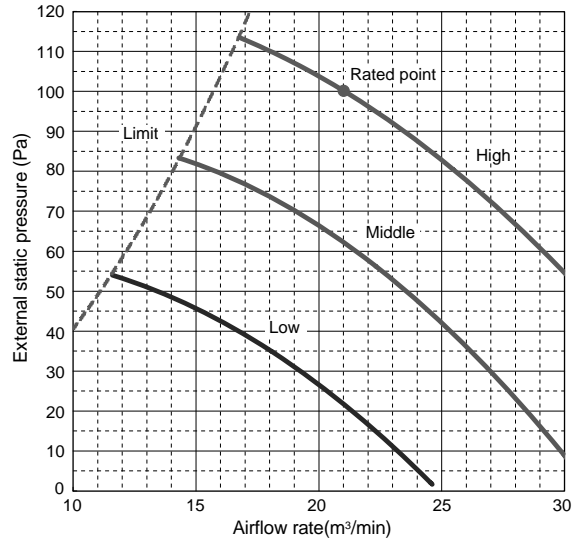

PEAD-RP60JA(L)
 (External static pressure 50Pa) 220-240V 50Hz

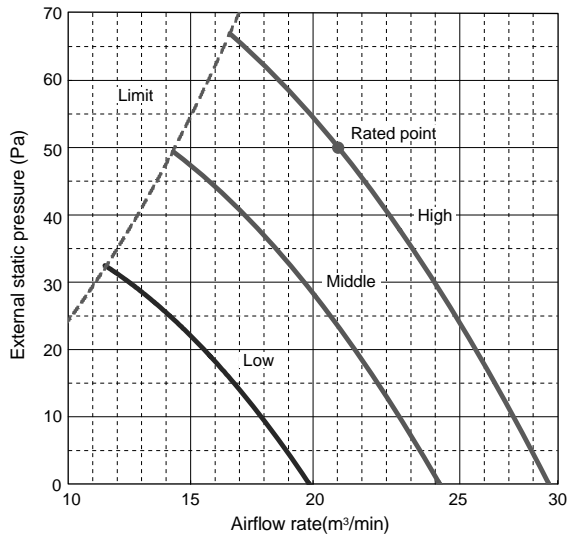

PEAD-RP60JA(L)
 (External static pressure 150Pa) 220-240V 50Hz

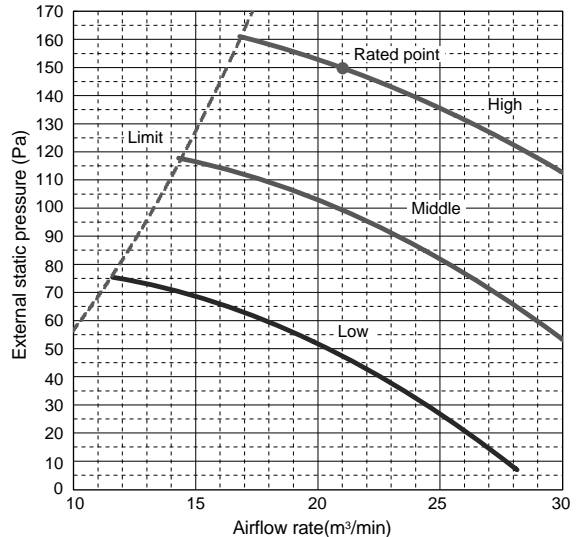

PEAD-RP60JA(L)
 (External static pressure 70Pa) 220-240V 50Hz

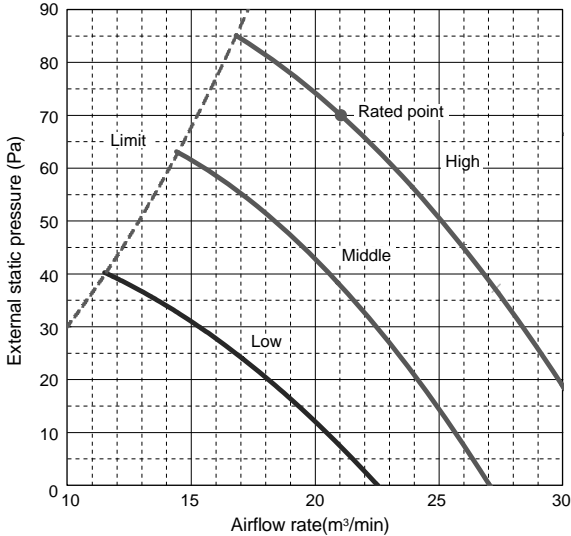

PEAD-RP71JA(L)
 (External static pressure 35Pa) 220-240V 50Hz

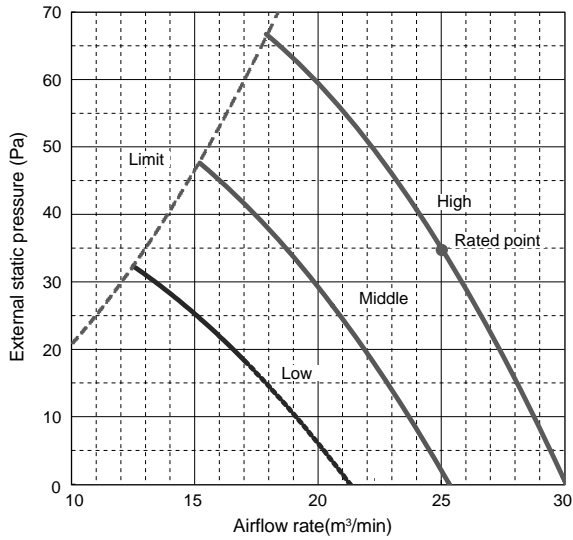

PEAD-RP71JA(L)
 (External static pressure 100Pa) 220-240V 50Hz

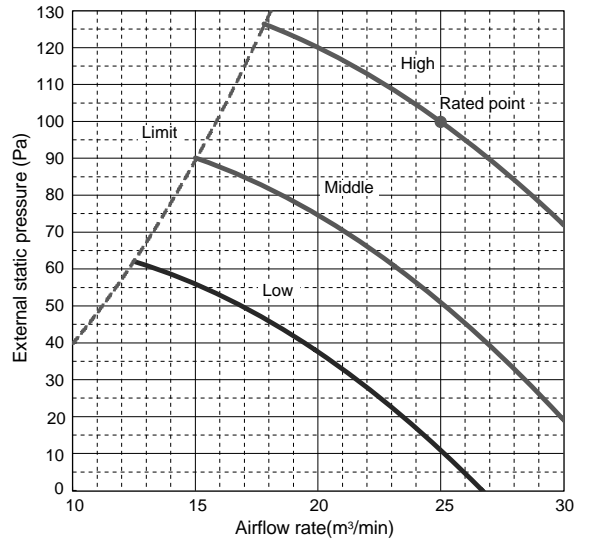

PEAD-RP71JA(L)
 (External static pressure 50Pa) 220-240V 50Hz

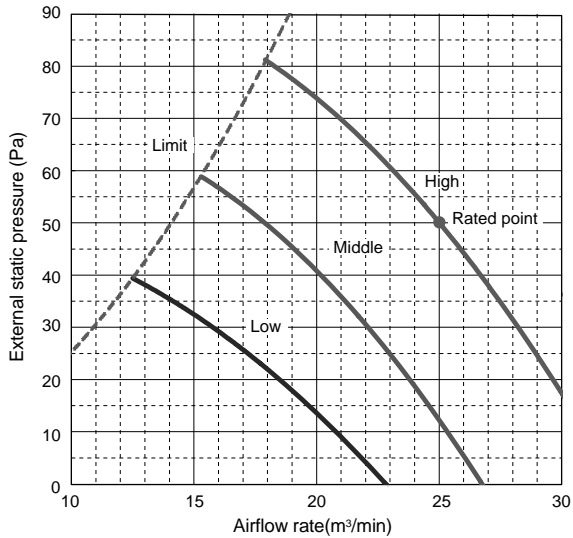

PEAD-RP71JA(L)
 (External static pressure 150Pa) 220-240V 50Hz

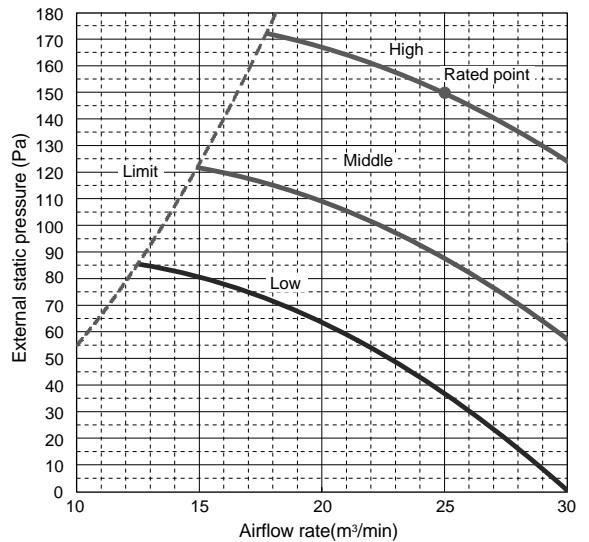

PEAD-RP71JA(L)
 (External static pressure 70Pa) 220-240V 50Hz

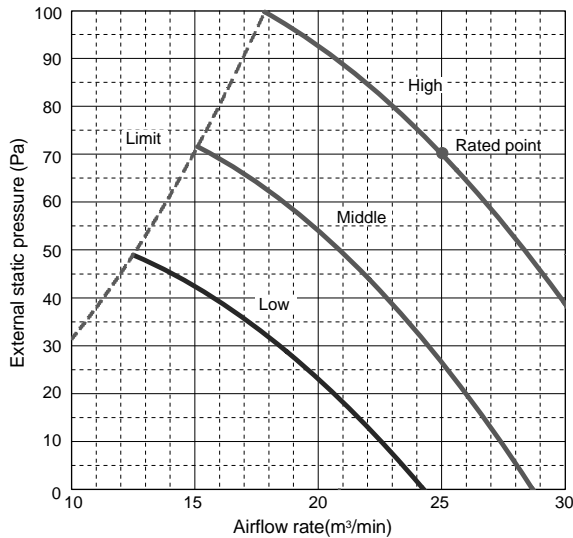

PEAD-RP100JA(L)
 (External static pressure 35Pa) 220-240V 50Hz

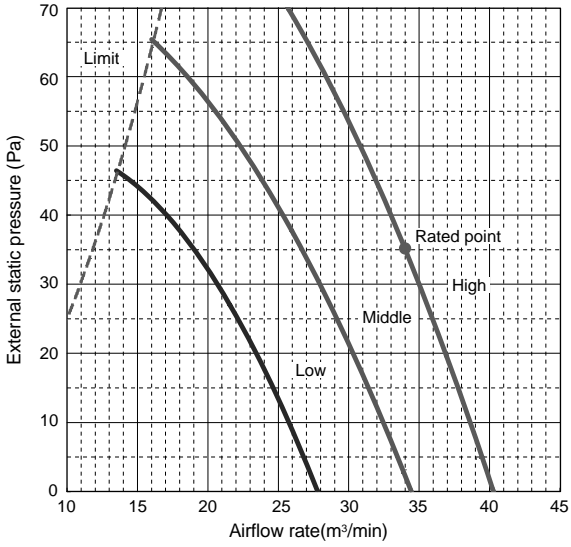

PEAD-RP100JA(L)
 (External static pressure 100Pa) 220-240V 50Hz

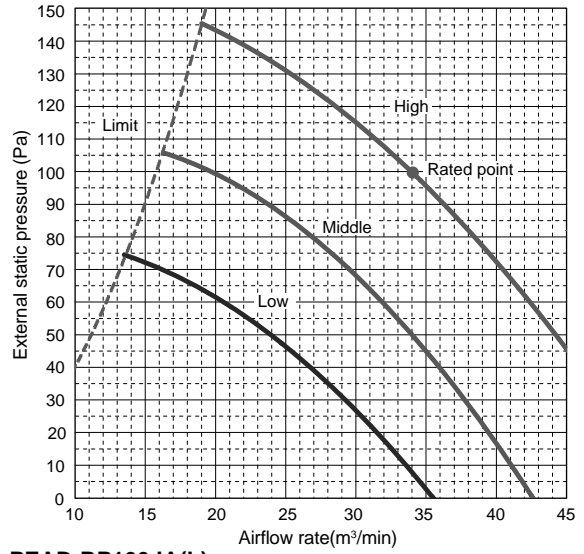

PEAD-RP100JA(L)
 (External static pressure 50Pa) 220-240V 50Hz

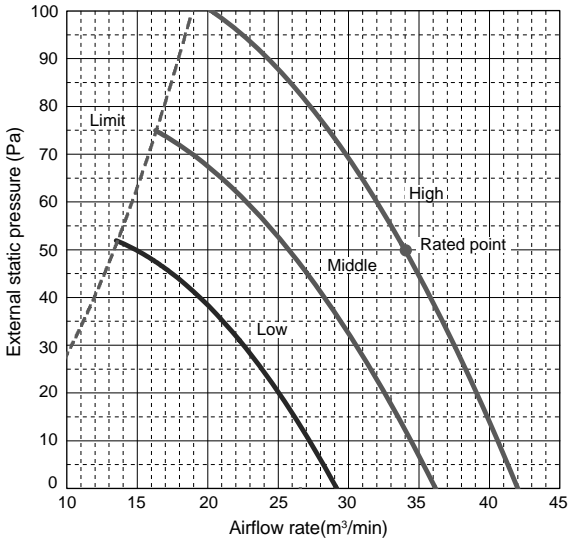

PEAD-RP100JA(L)
 (External static pressure 150Pa) 220-240V 50Hz

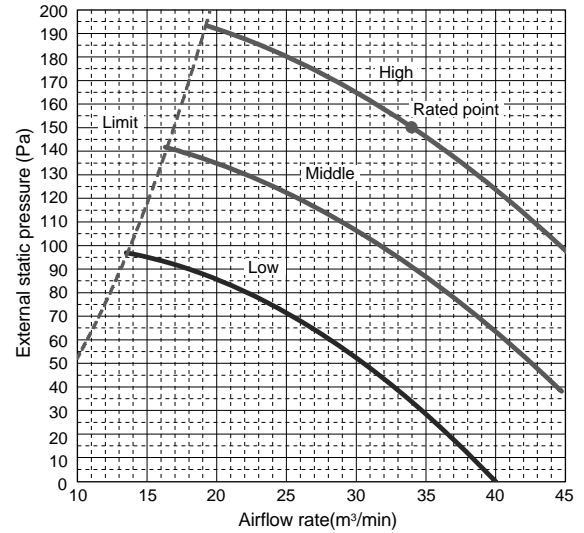

PEAD-RP100JA(L)
 (External static pressure 70Pa) 220-240V 50Hz

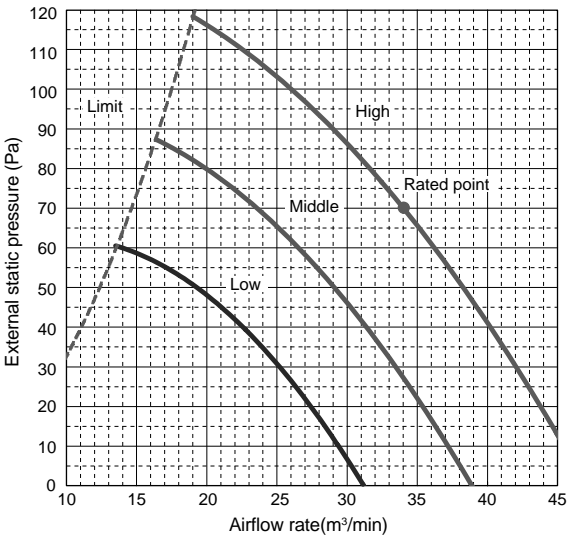

PEAD-RP125JA(L)
 (External static pressure 35Pa) 220-240V 50Hz

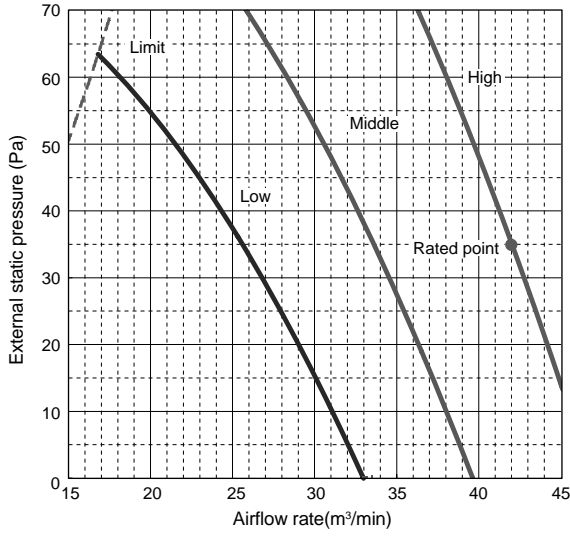

PEAD-RP125JA(L)
 (External static pressure 100Pa) 220-240V 50Hz

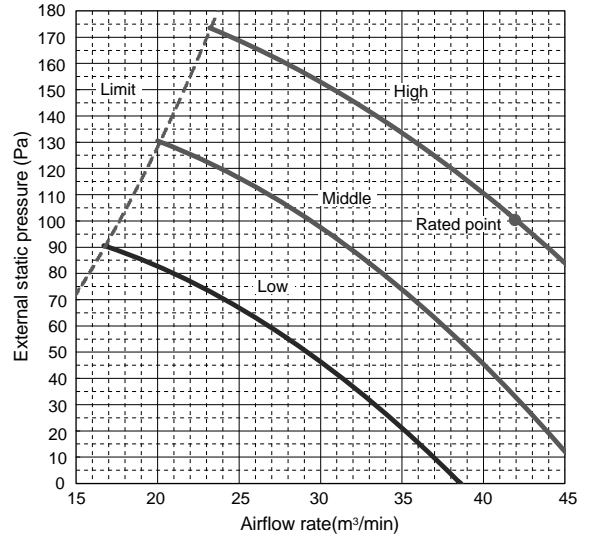

PEAD-RP125JA(L)
 (External static pressure 50Pa) 220-240V 50Hz

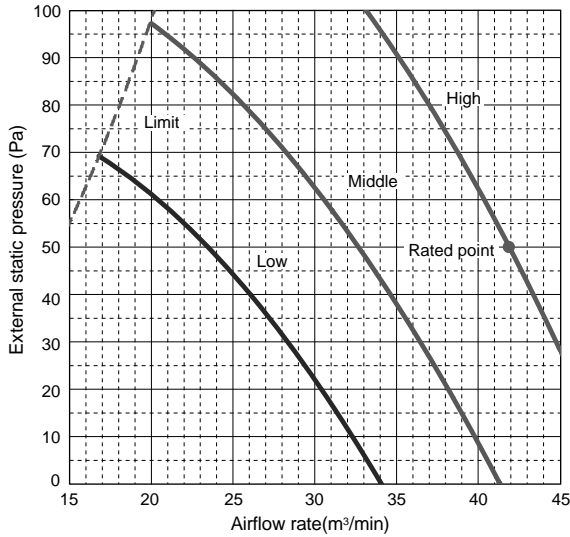

PEAD-RP125JA(L)
 (External static pressure 150Pa) 220-240V 50Hz

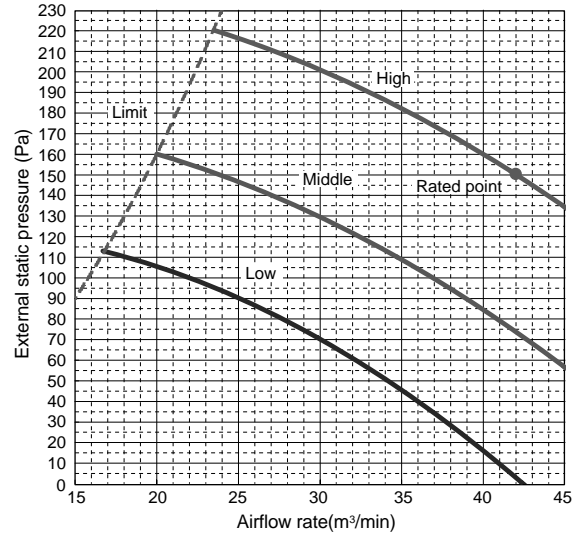

PEAD-RP125JA(L)
 (External static pressure 70Pa) 220-240V 50Hz

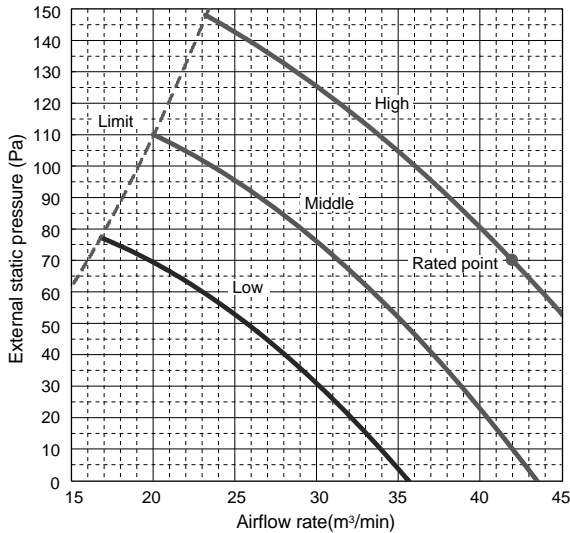

9-4. PEAD-RP-EA,EA2,GA

9-4-1. FAN PERFORMANCE AND CORRECTED AIR FLOW

PEAD-RP35EA2

PEAD-RP50EA

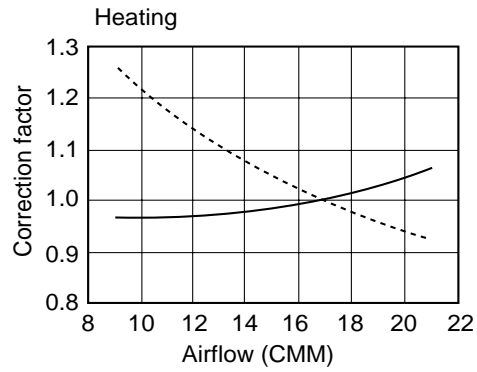
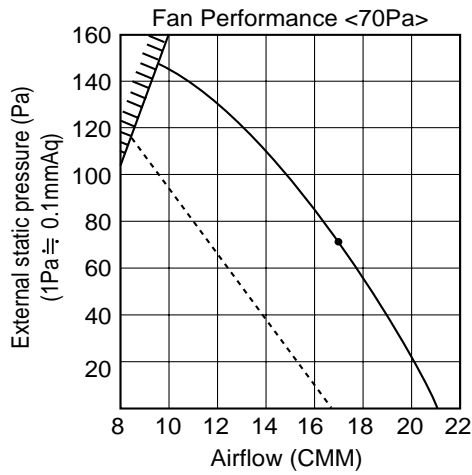
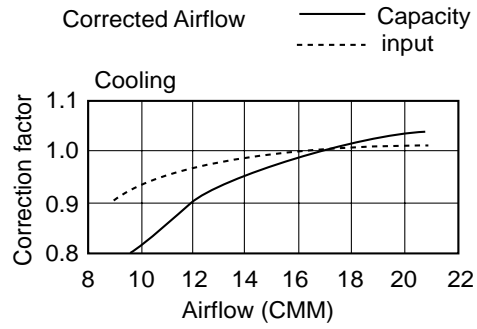
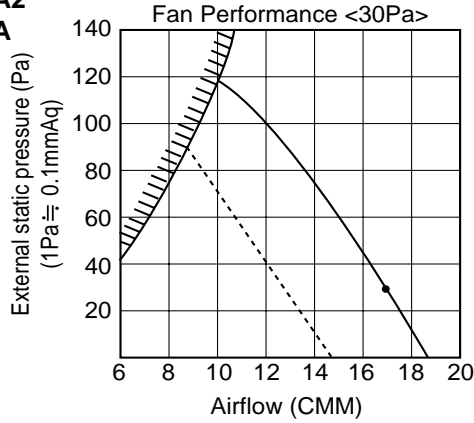

PEAD-RP60EA

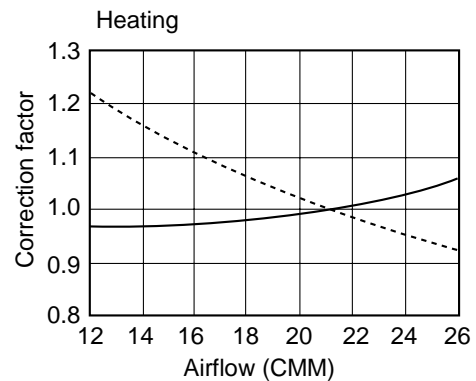
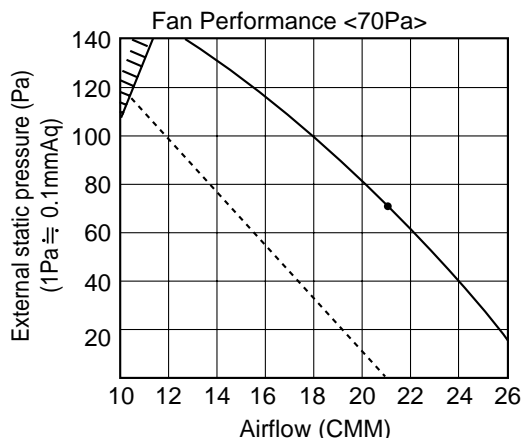
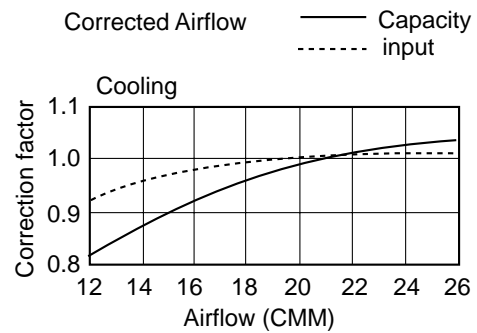
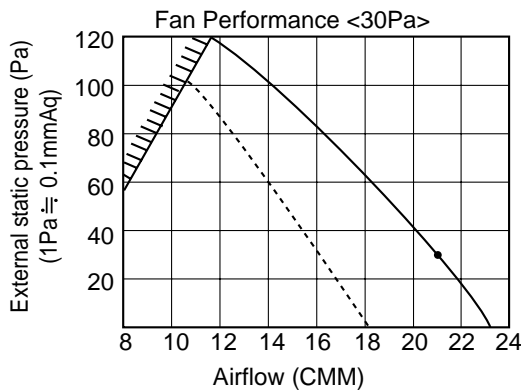

PEAD-RP71EA

Fan performance <130Pa>

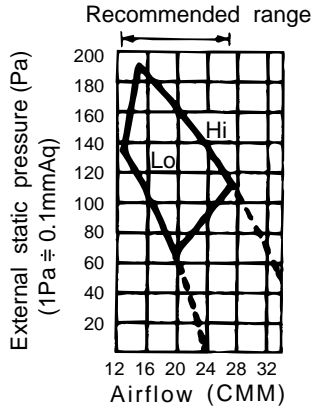

Fan performance <70Pa>

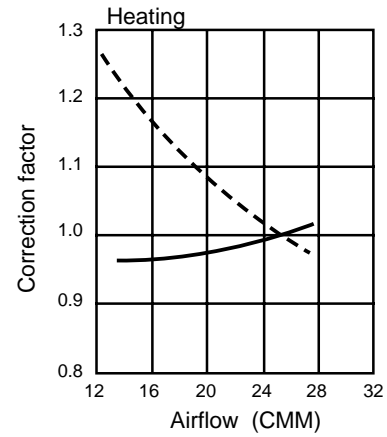
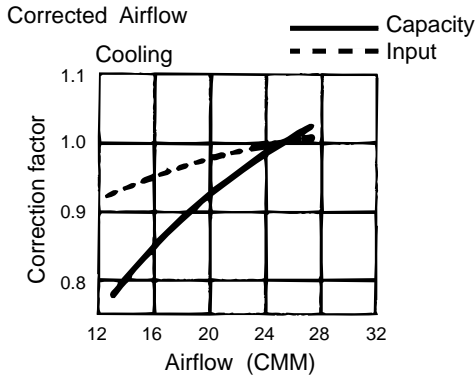
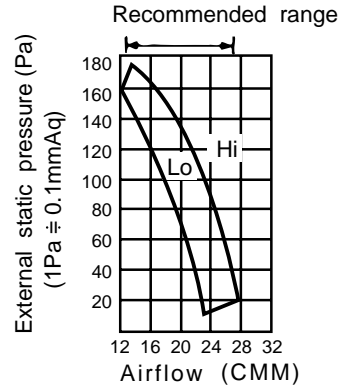

PEAD-RP100EA2
PEAD-RP125EA

Fan performance <130Pa>

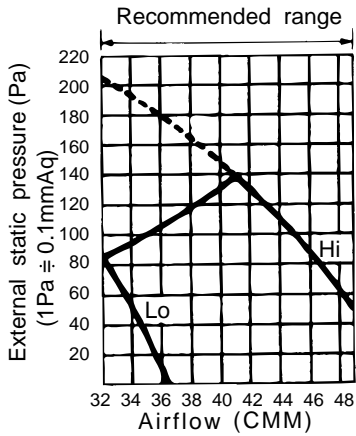

Fan performance <70Pa>

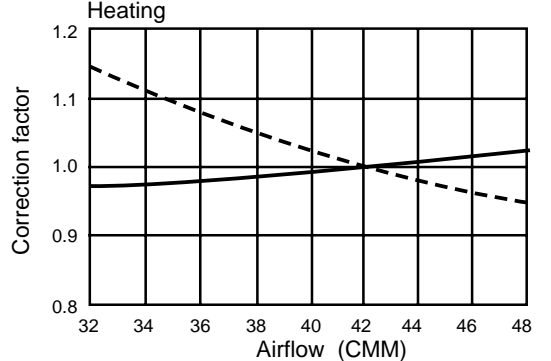
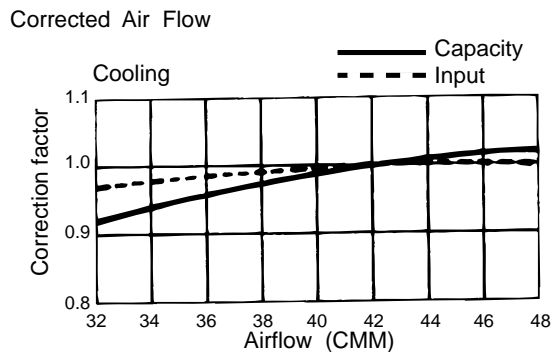
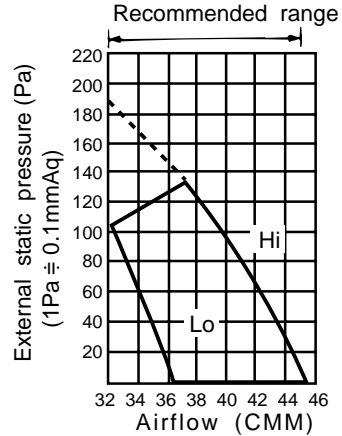

PEAD-RP60GA

Fan performance <220V>

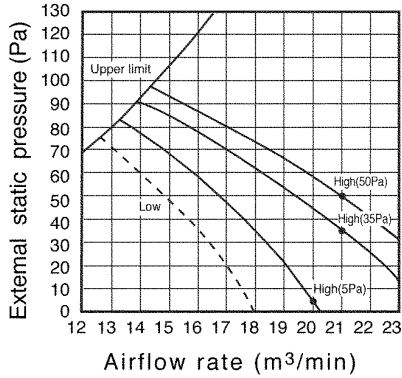

Fan performance <230V>

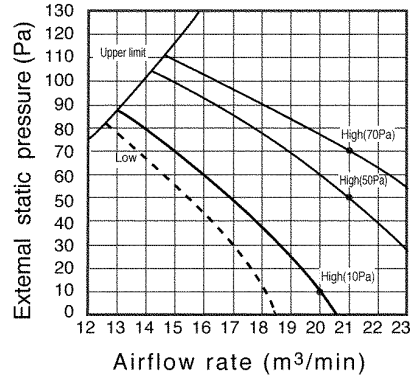

Fan performance <240V>

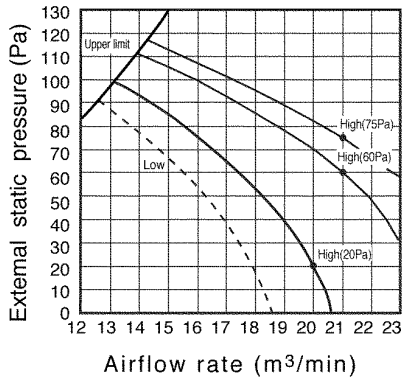

Corrected air flow

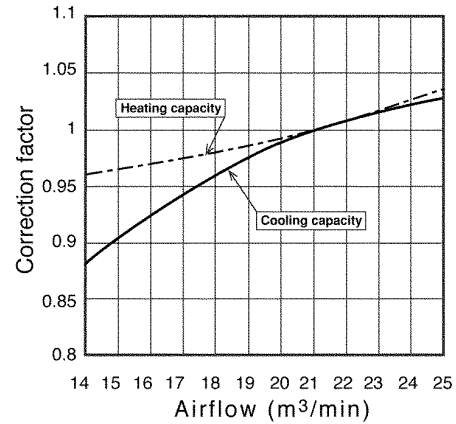

PEAD-RP71GA

Fan performance <220V>

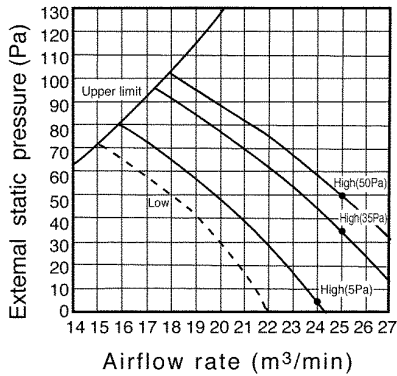

Fan performance <230V>

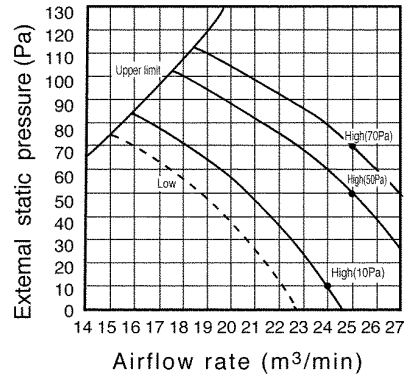

Fan performance <240V>

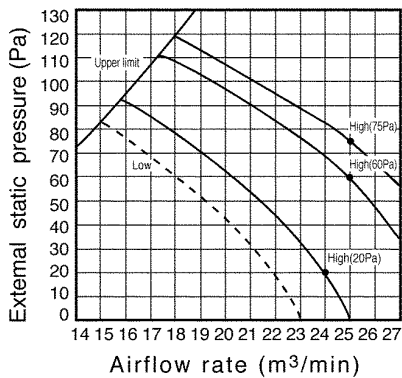

Corrected air flow

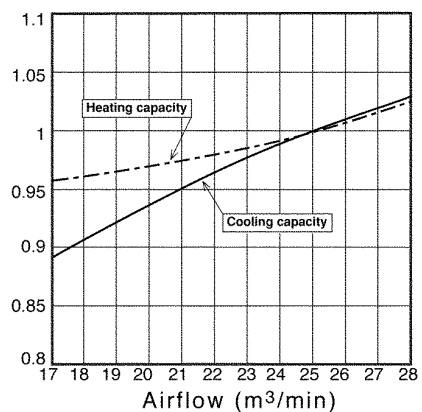

PEAD-RP100GA

Fan performance <220V>

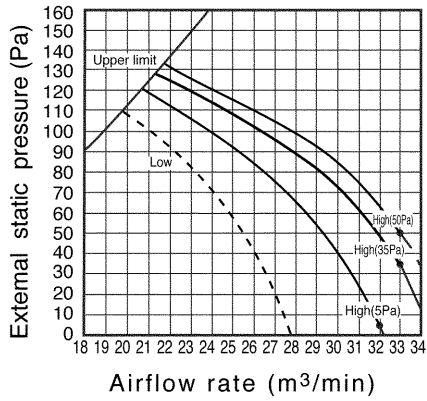

Fan performance <230V>

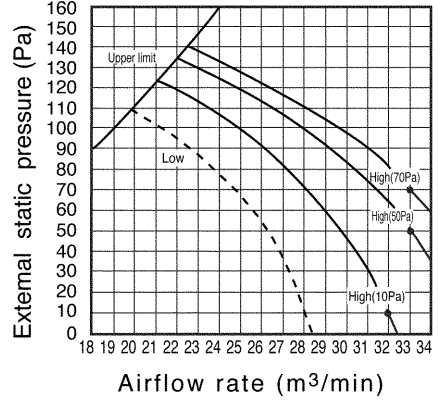

Fan performance <240V>

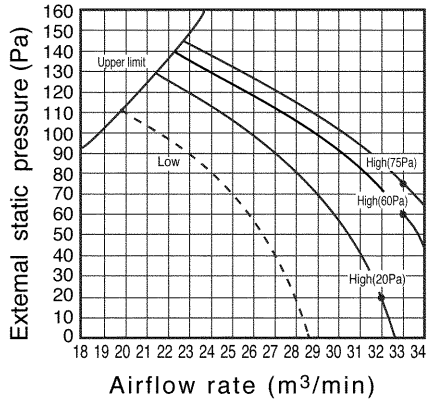

Corrected air flow

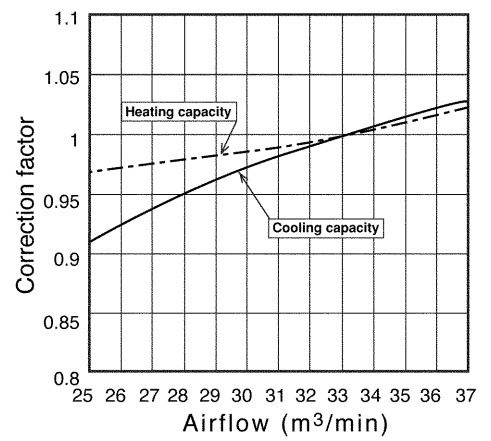

10-1. INDOOR UNIT

PLA-RP35BA

NOTCH	SPL(dB)	LINE
High	31	○—○
Medium1	29	●—●
Medium2	28	△—△
Low	27	▲—▲

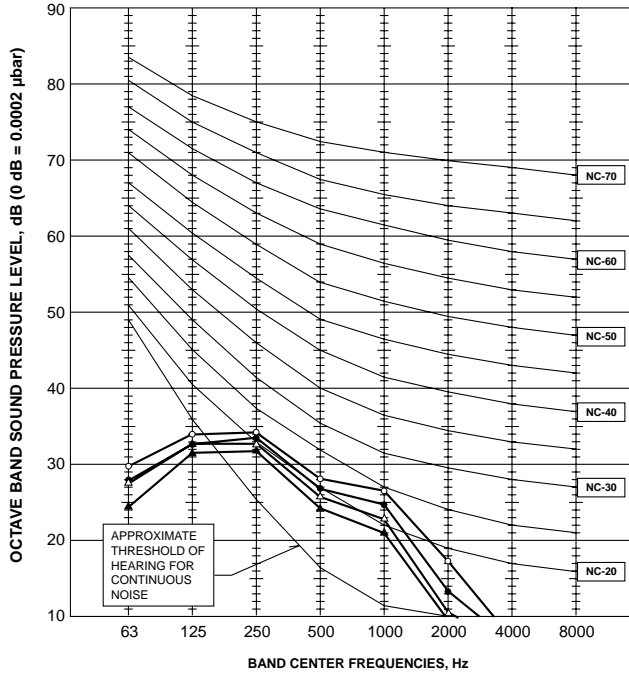

PLA-RP50BA

NOTCH	SPL(dB)	LINE
High	32	○—○
Medium1	31	●—●
Medium2	29	△—△
Low	28	▲—▲

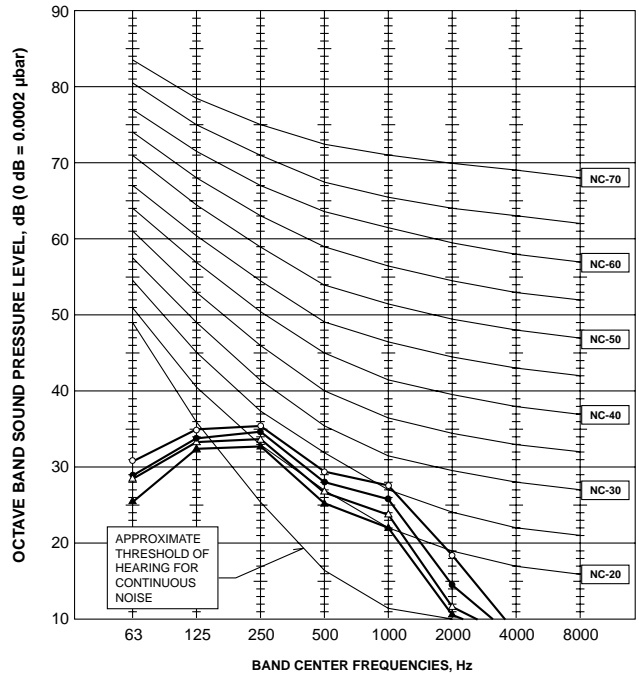

PLA-RP60BA

NOTCH	SPL(dB)	LINE
High	32	○—○
Medium1	31	●—●
Medium2	29	△—△
Low	28	▲—▲

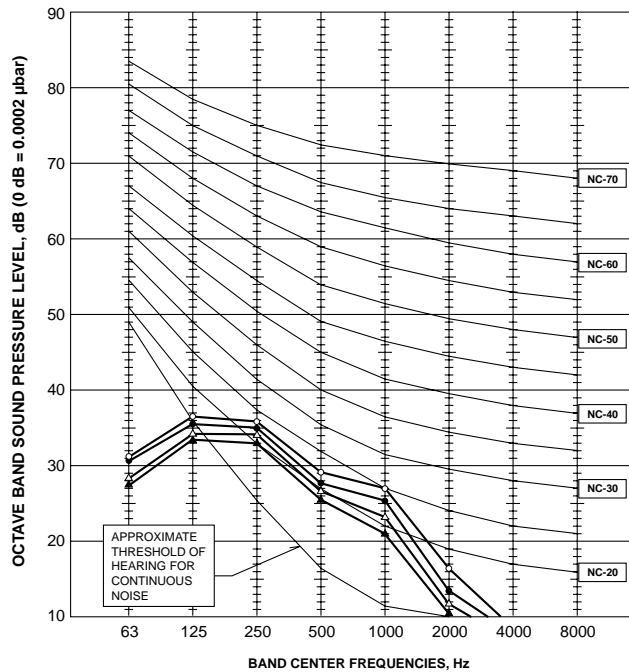

PLA-RP71BA2

NOTCH	SPL(dB)	LINE
High	34	○—○
Medium1	32	●—●
Medium2	30	△—△
Low	28	▲—▲

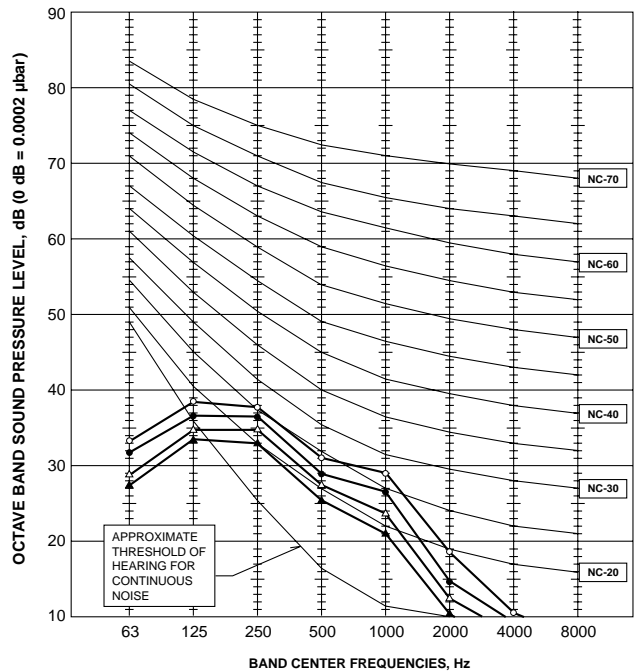

**PLA-RP100BA
PLA-RP100BA2
PLA-RP100BA3**

NOTCH	SPL(dB)	LINE
High	40	○—○
Medium1	37	●—●
Medium2	34	△—△
Low	32	

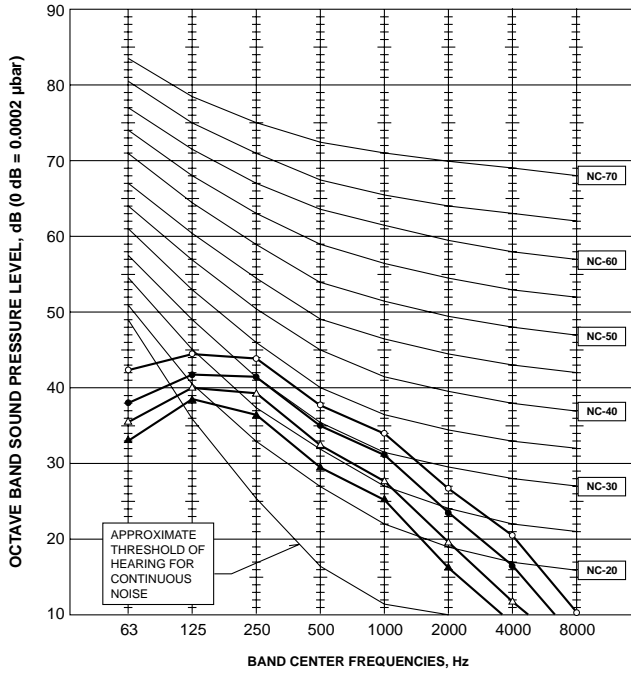

**PLA-RP125BA
PLA-RP125BA2**

NOTCH	SPL(dB)	LINE
High	41	○—○
Medium1	39	●—●
Medium2	36	△—△
Low	34	▲—▲

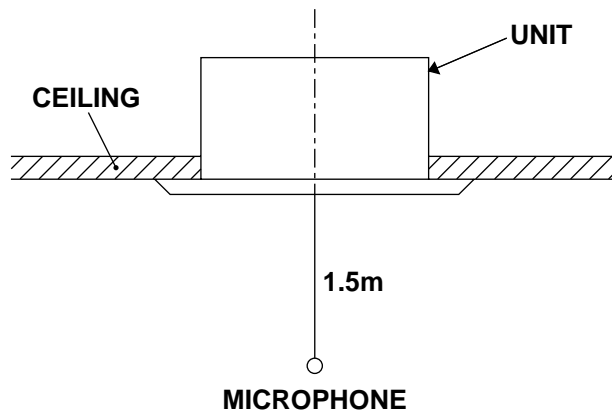
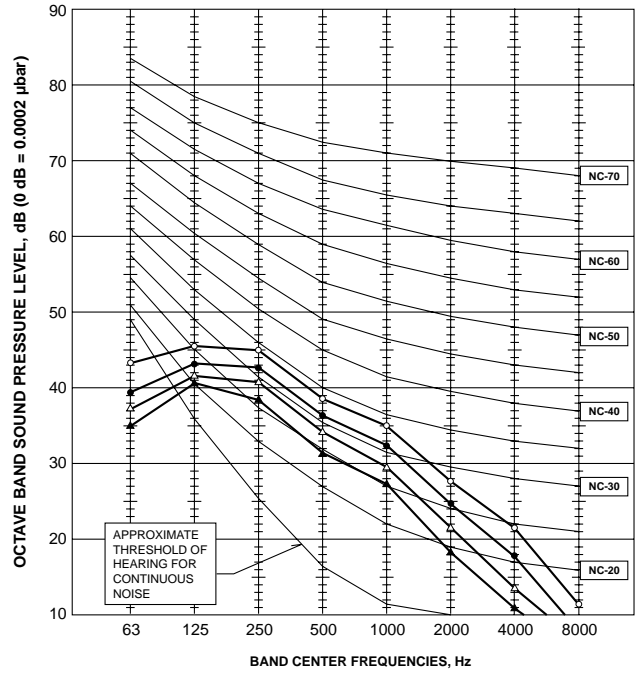

PEAD-RP-JA(L)

Ceiling concealed

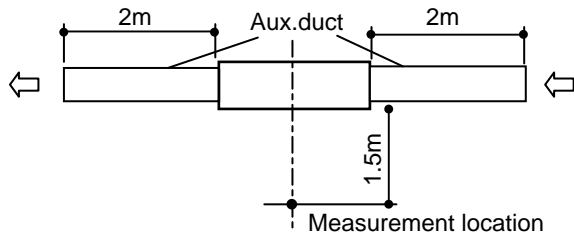

Noise level at anechoic room (Low-Middle-High) Unit: dB(A)

Model	External static pressure				
	35Pa	50Pa	70Pa	100Pa	150Pa
PEAD-RP35JA(L)	23-26-29	23-27-30	24-28-31	26-29-33	29-33-37
PEAD-RP50JA(L)	25-30-34	26-31-35	28-32-36	29-33-37	31-35-39
PEAD-RP60JA(L)	25-28-32	25-29-33	26-30-34	27-31-35	29-34-38
PEAD-RP71JA(L)	25-29-34	26-30-34	27-31-35	28-32-36	30-35-39
PEAD-RP100JA(L)	28-33-38	29-34-38	30-35-39	31-36-40	34-40-43
PEAD-RP125JA(L)	31-36-40	33-36-40	33-37-41	34-39-42	37-41-45

PEAD-RP35JA(L)

External static pressure 35Pa

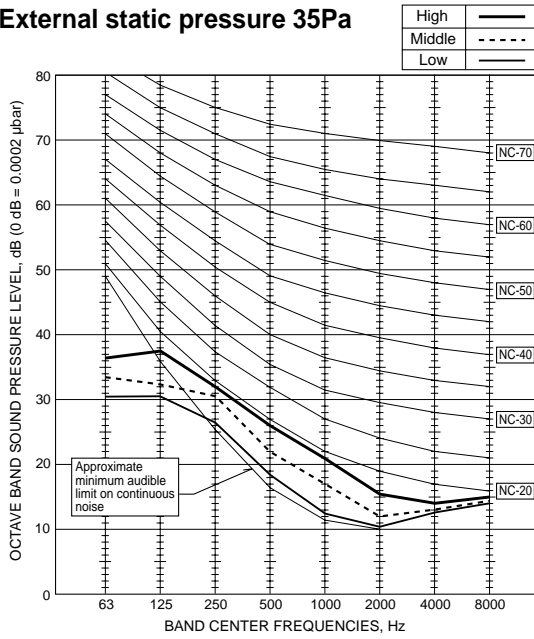

External static pressure 100Pa

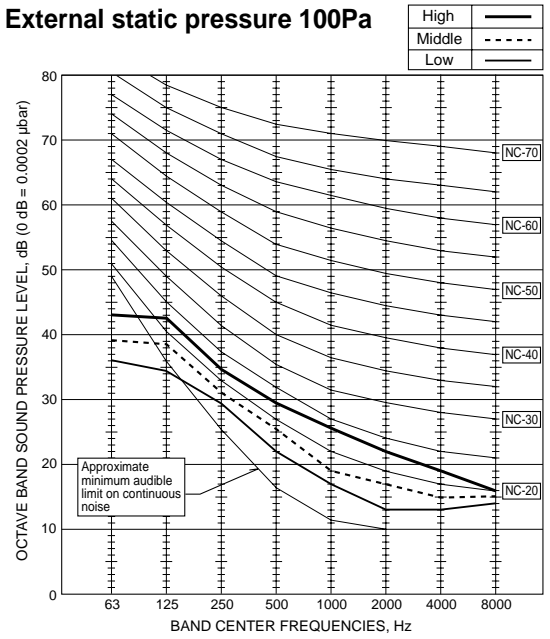

External static pressure 50Pa

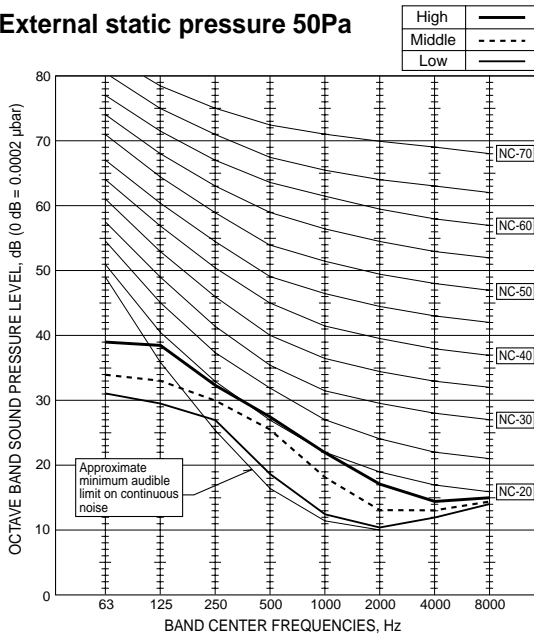

External static pressure 150Pa

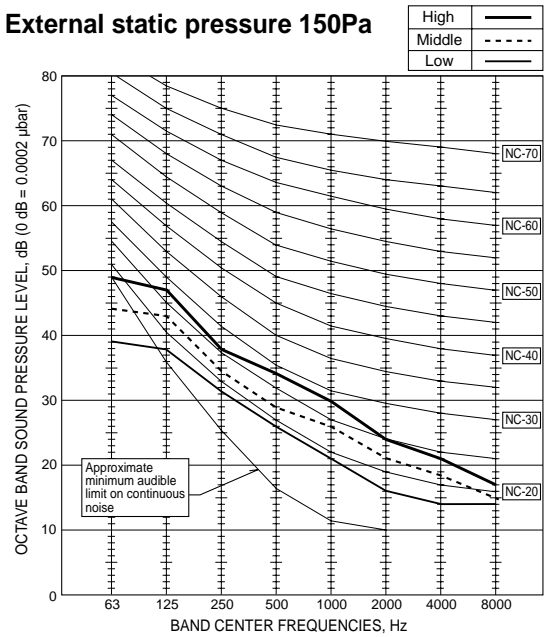

External static pressure 70Pa

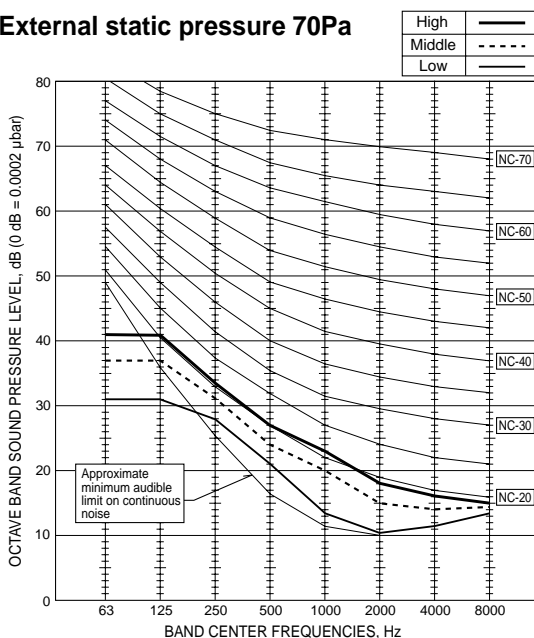

PEAD-RP50JA(L)

External static pressure 35Pa

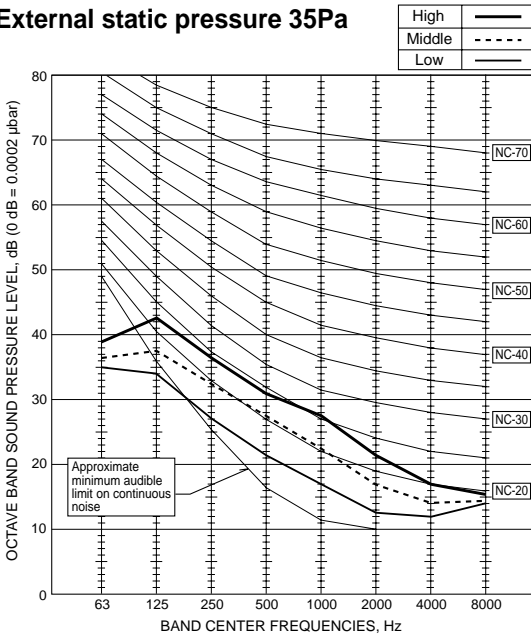

External static pressure 100Pa

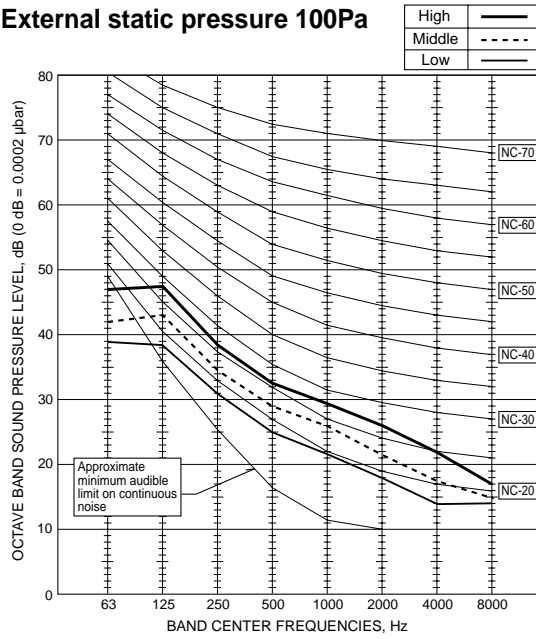

External static pressure 50Pa

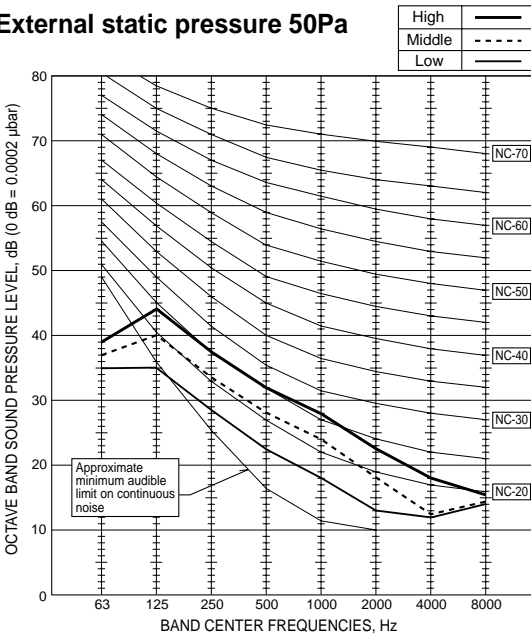

External static pressure 150Pa

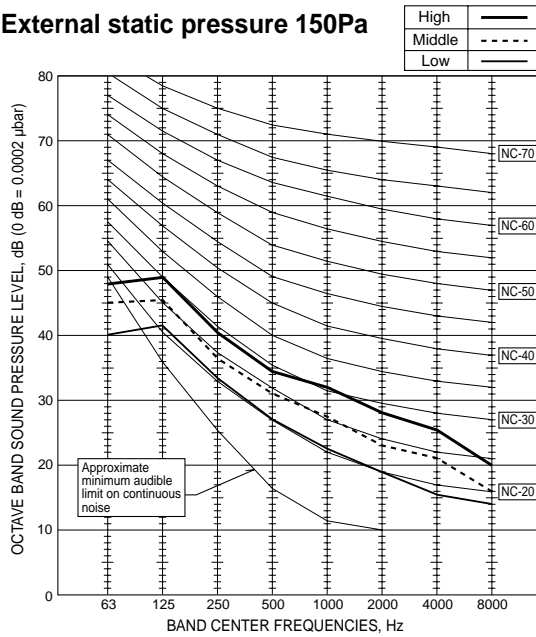

External static pressure 70Pa

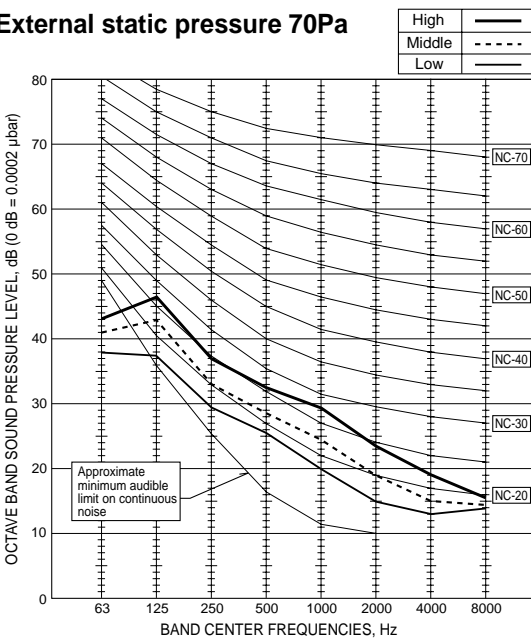

PEAD-RP60JA(L)

External static pressure 35Pa

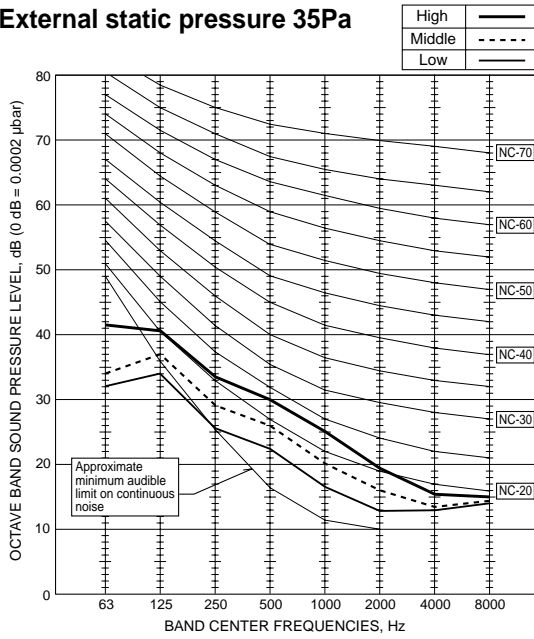

External static pressure 100Pa

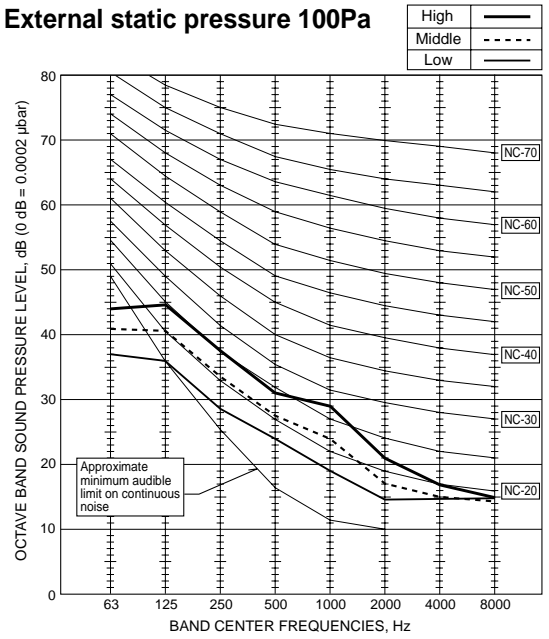

External static pressure 50Pa

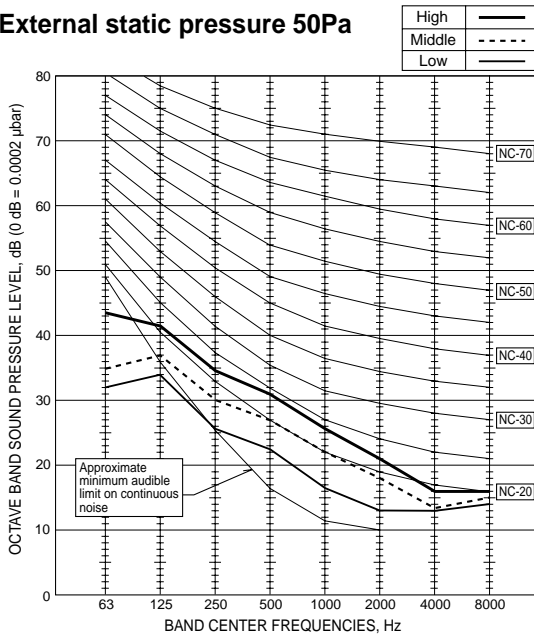

External static pressure 150Pa

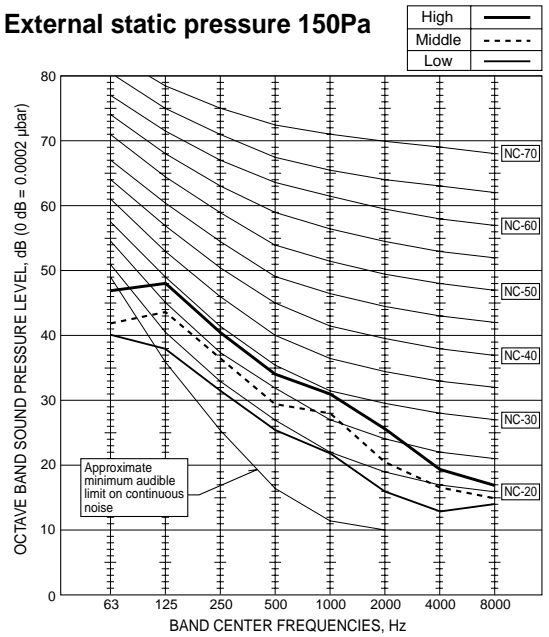

External static pressure 70Pa

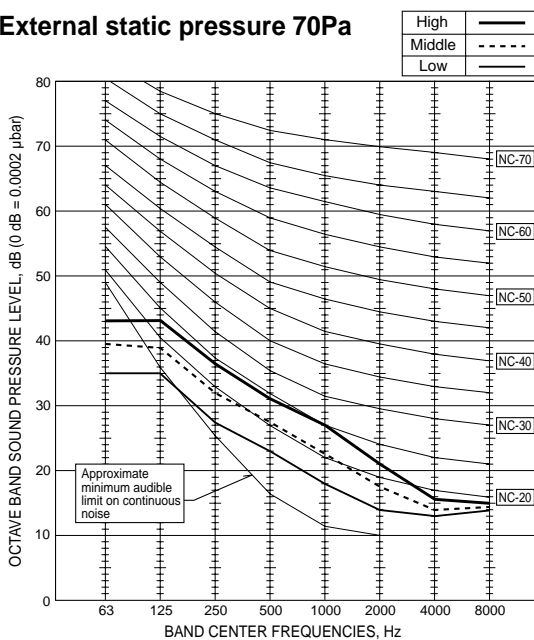

PEAD-RP71JA(L)

External static pressure 35Pa

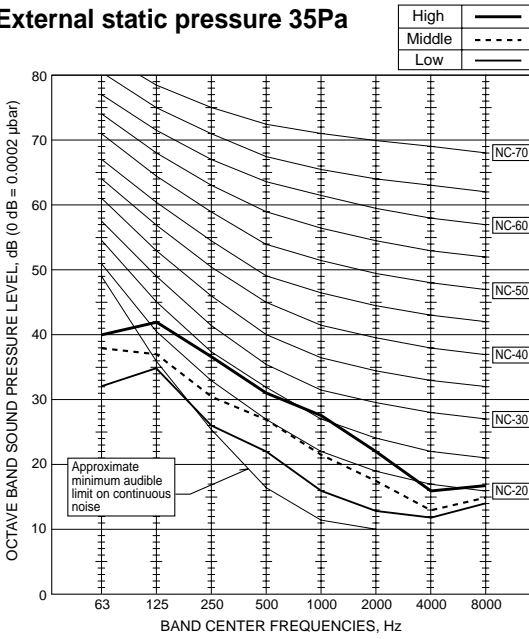

External static pressure 100Pa

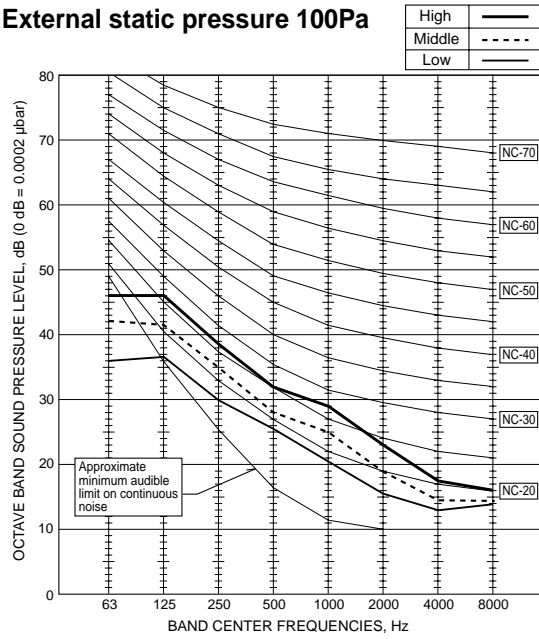

External static pressure 50Pa

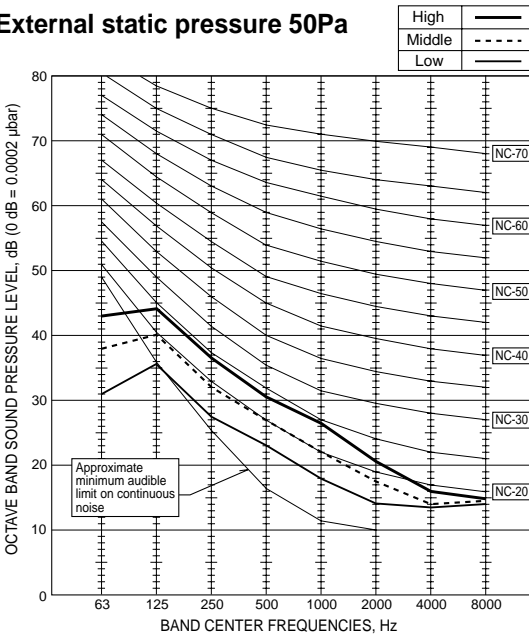

External static pressure 150Pa

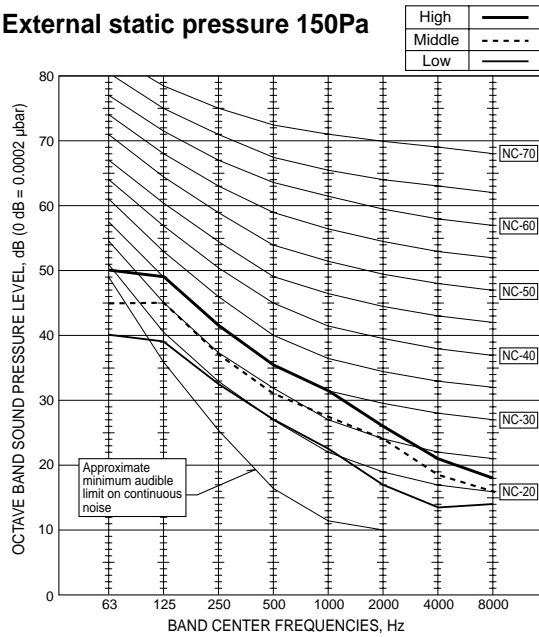

External static pressure 70Pa

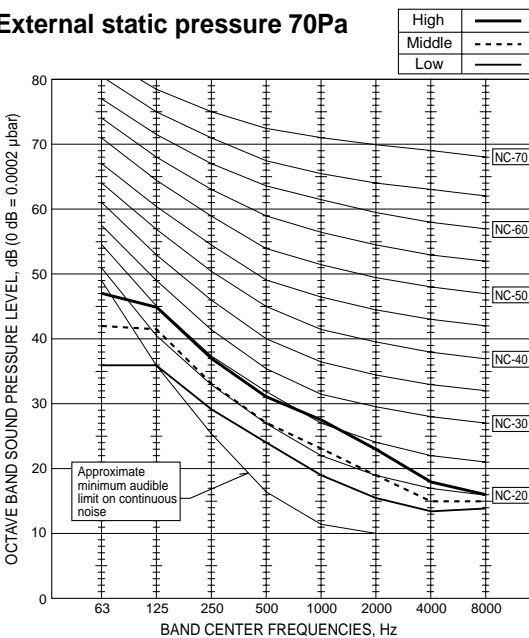

PEAD-RP100JA(L)

External static pressure 35Pa

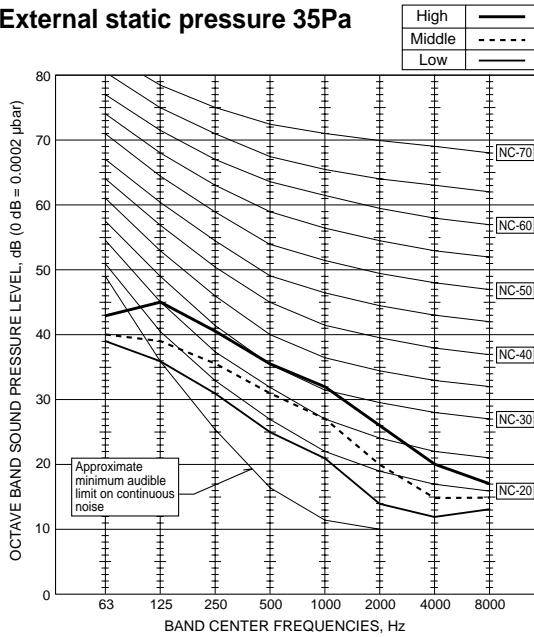

External static pressure 100Pa

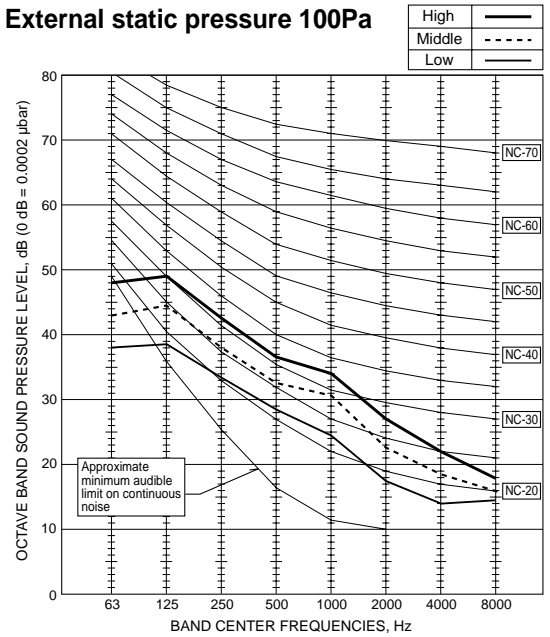

External static pressure 50Pa

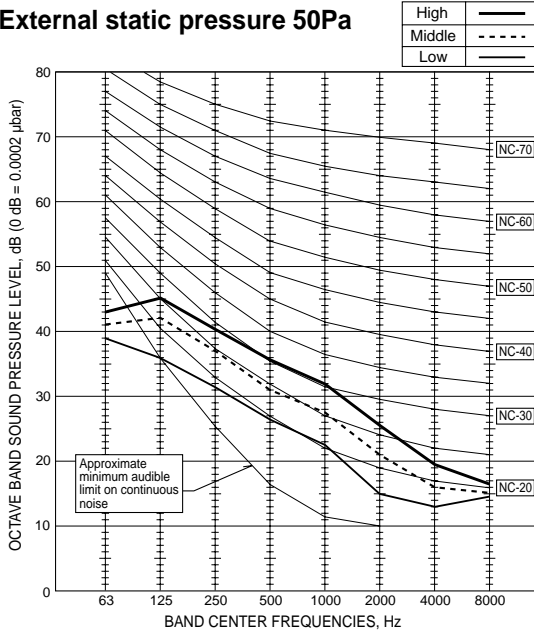

External static pressure 150Pa

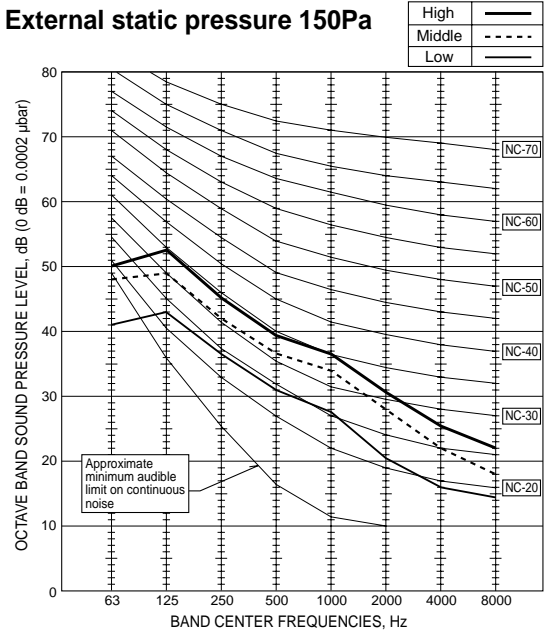

External static pressure 70Pa

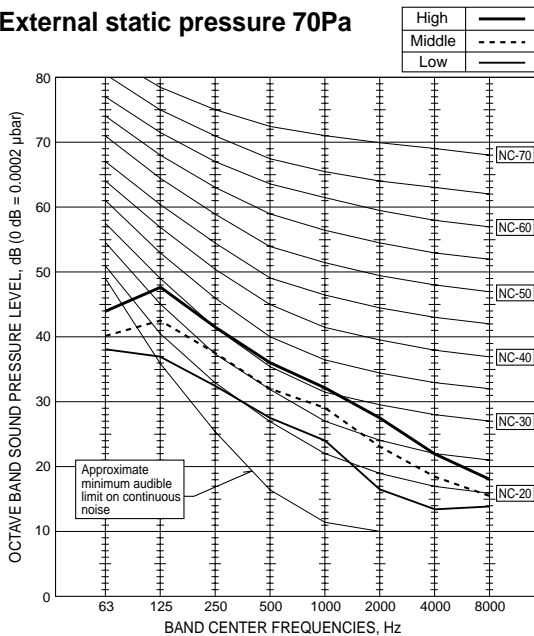

PEAD-RP125JA(L)

External static pressure 35Pa

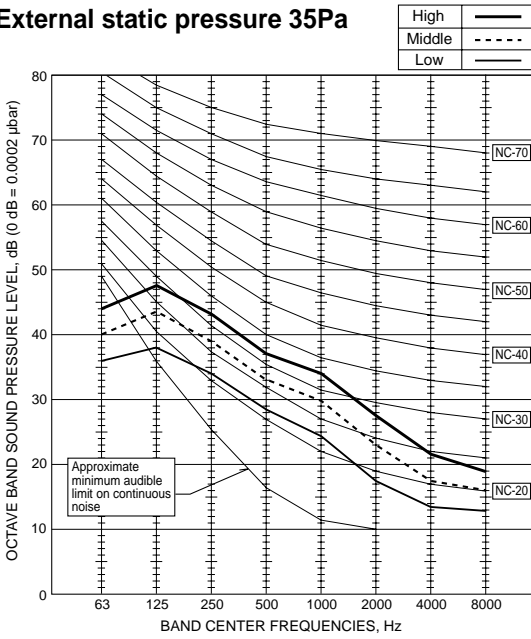

External static pressure 100Pa

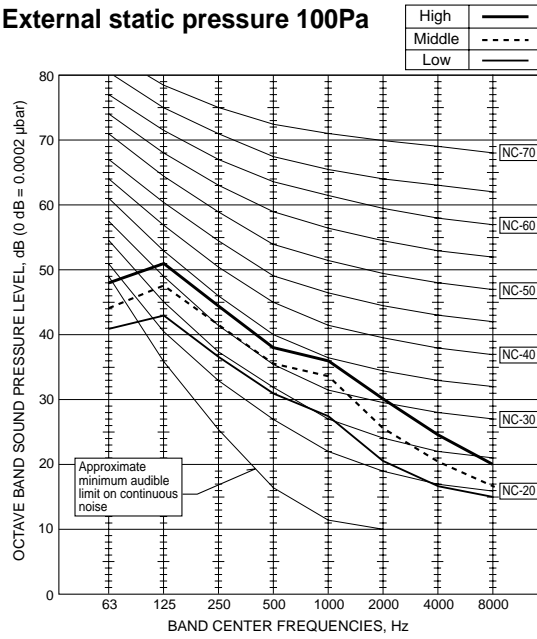

External static pressure 50Pa

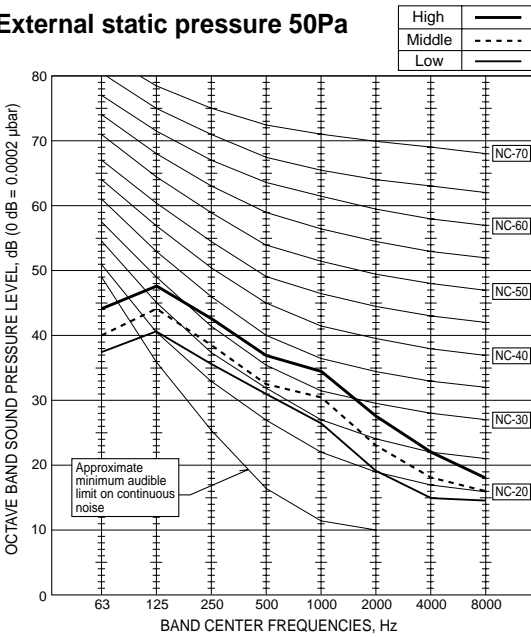

External static pressure 150Pa

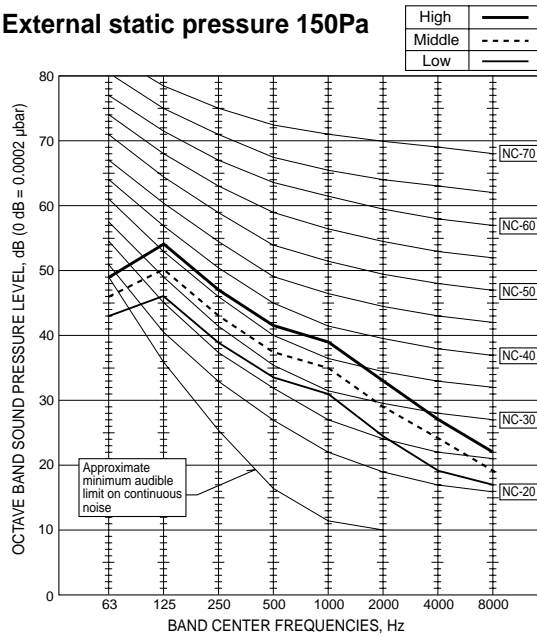

External static pressure 70Pa

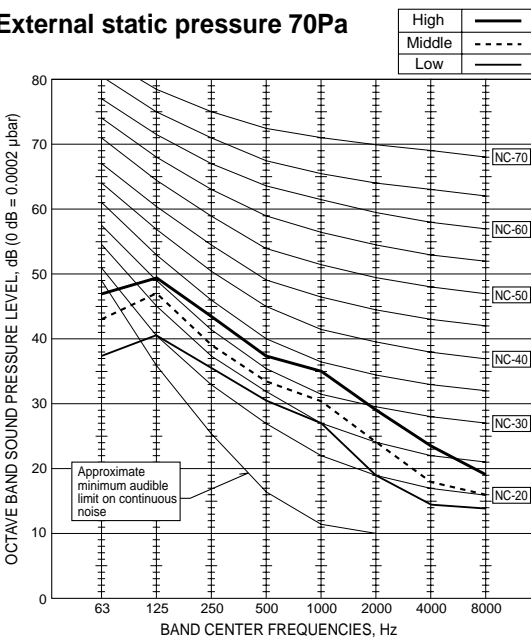

Ceiling concealed

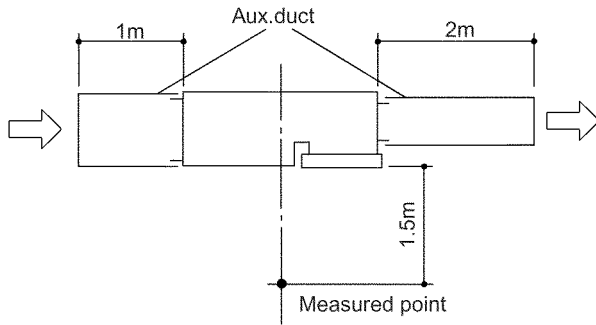

Noise level at anechoic room (Low-High)

Unit : dB(A)

Model	External static pressure		
	30Pa	70Pa	130Pa
PEAD-RP35EA2	36-40	38-44	-
PEAD-RP50EA	36-40	38-44	-
PEAD-RP60EA	37-41	39-46	-
PEAD-RP71EA	-	37-41	40-45 *
PEAD-RP100EA2	-	44-50	46-52 *
PEAD-RP125EA	-	44-50	46-52 *

* Optional motor

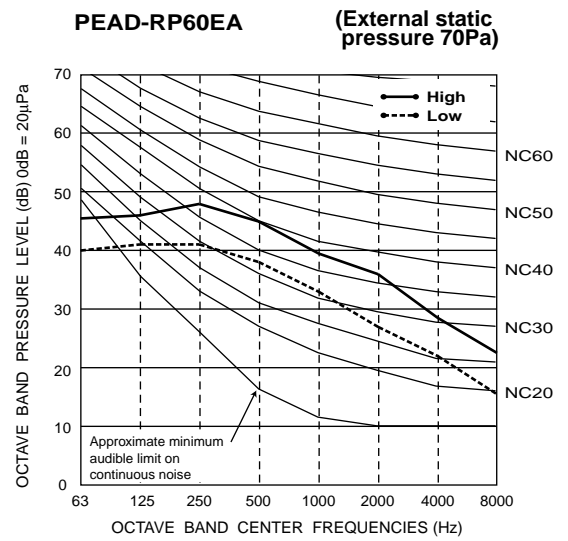
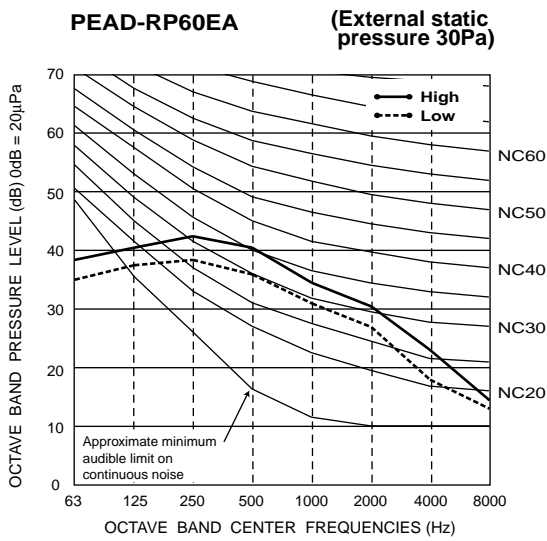
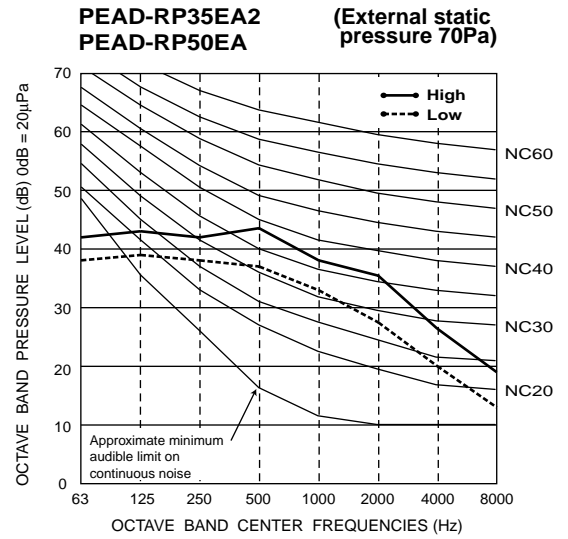
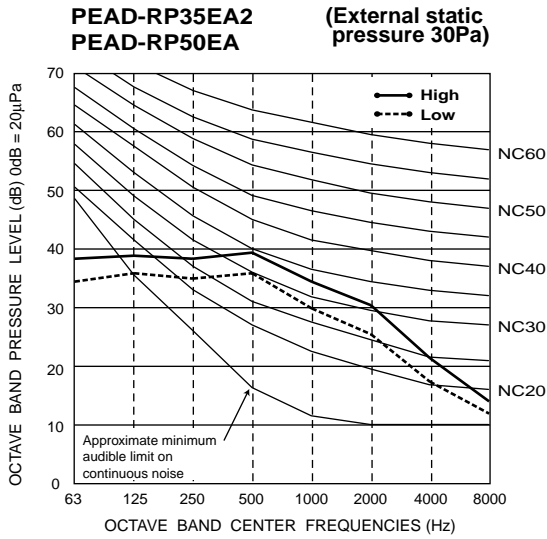

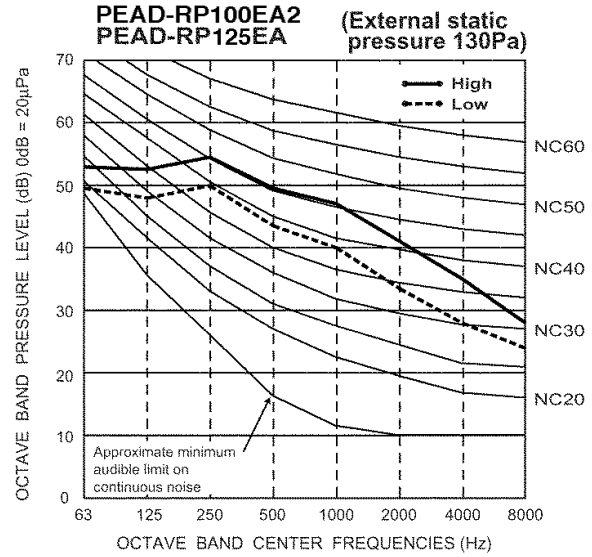
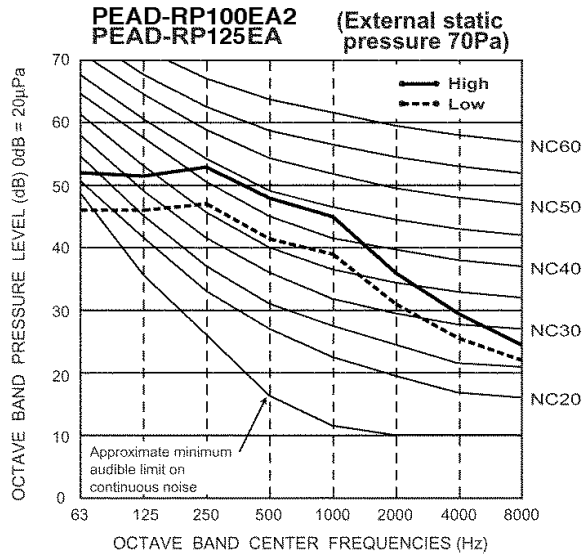
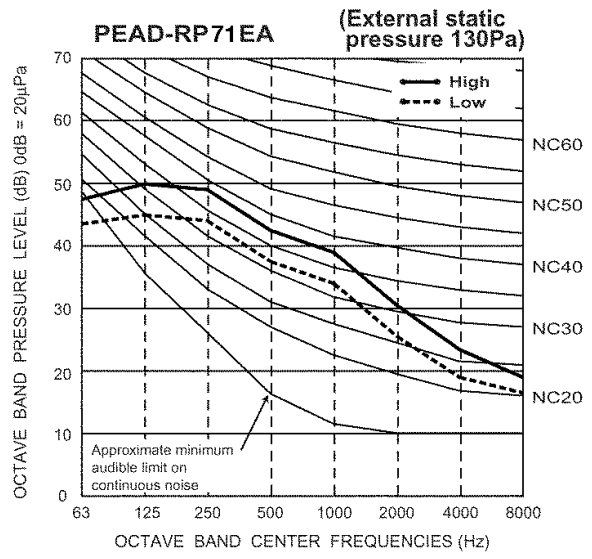
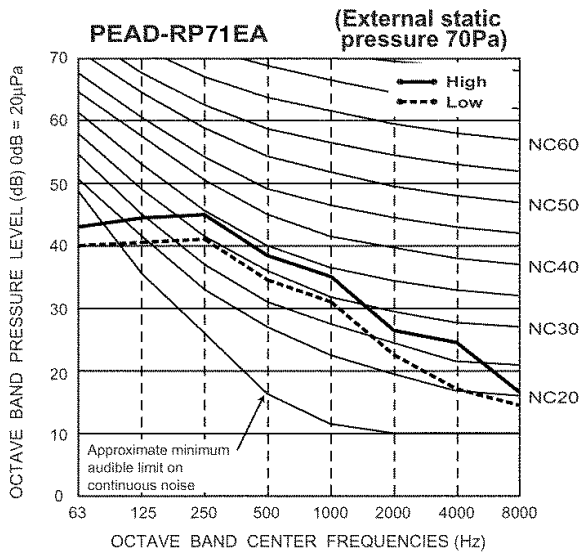

SOUND LEVELS

Low-Middle-High

Model	Sound level dB (A)
PKA-RP35, 50HAL	36 - 40 - 43
PKA-RP60KAL	39 - 42 - 45
PKA-RP100KAL	41 - 45 - 49

PKA-RP35HAL PKA-RP50HAL

External static pressure : 0Pa
Power source : 220, 230, 240V, 50Hz

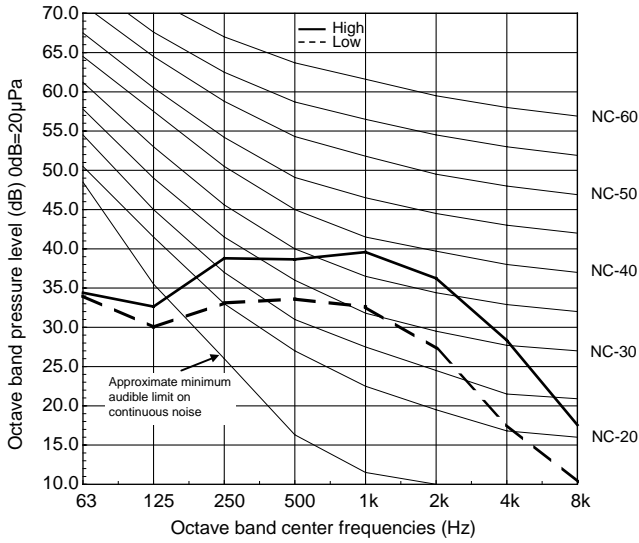

PKA-RP60KAL

External static pressure : 0Pa
Power source : 220, 230, 240V, 50Hz

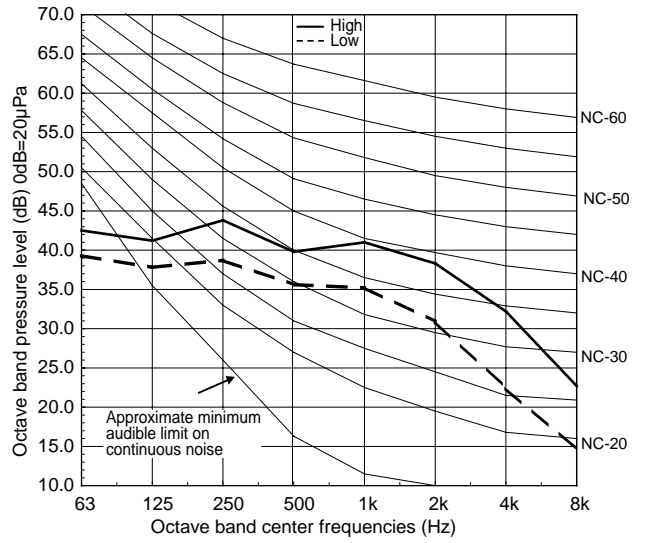

PKA-RP100KAL

External static pressure : 0Pa
Power source : 220, 230, 240V, 50Hz

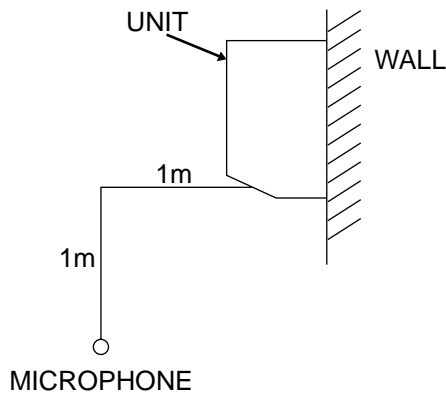
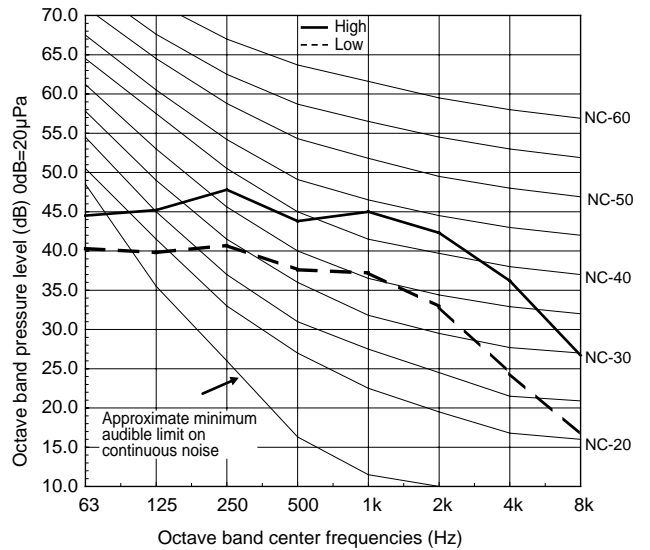

**PKA-RP35GAL
PKA-RP50GAL**

NOTCH	SPL(dB)	LINE
High	43	○—○
Medium1	41	△—△
Medium2	38	●—●
Low	36	▲—▲

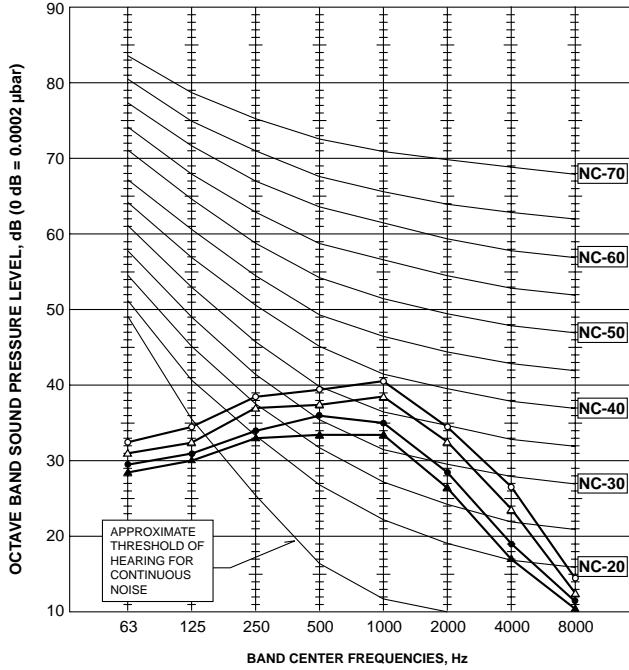

**PKA-RP50FAL2
PKA-RP60FAL**

NOTCH	SPL(dB)	LINE
High	45	○—○
Low	39	●—●

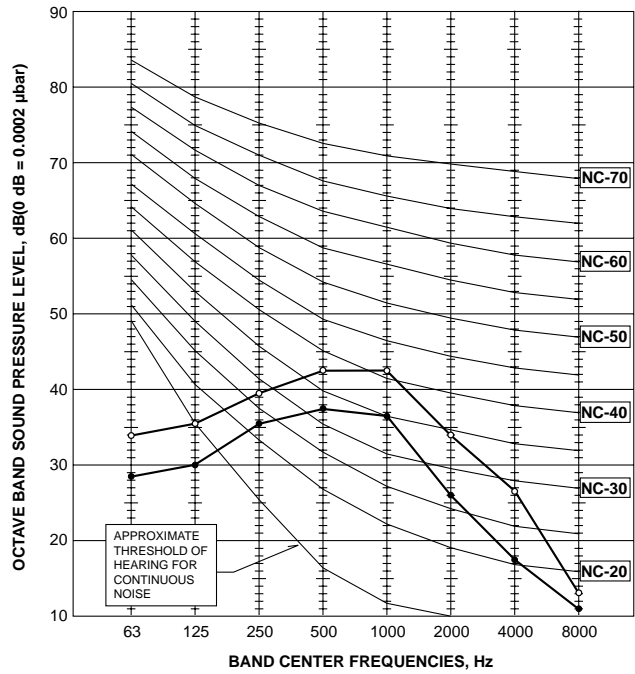

PKA-RP100FAL

NOTCH	SPL(dB)	LINE
High	46	○—○
Low	41	●—●

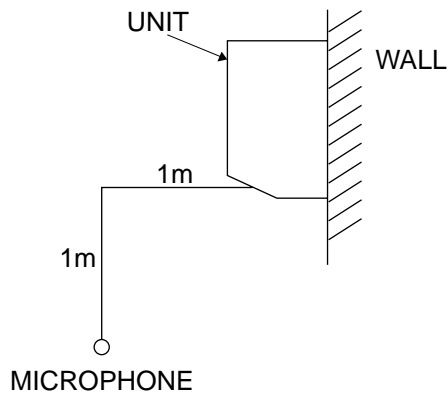
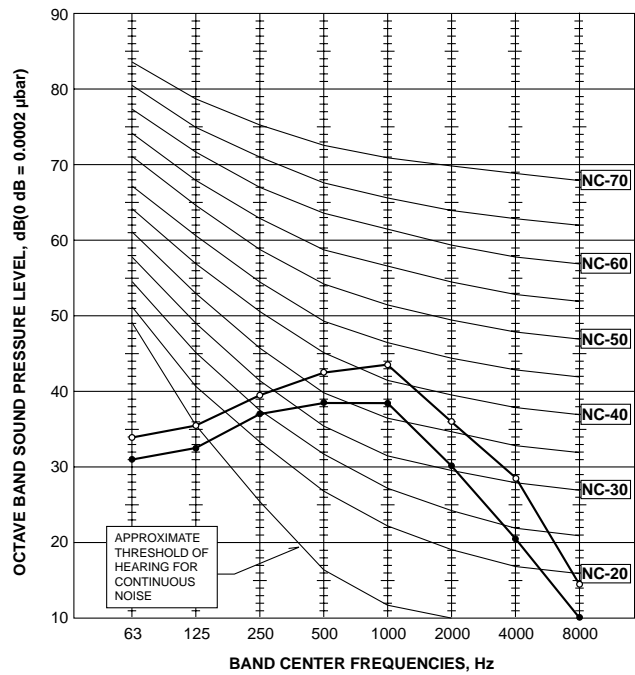

10-2. OUTDOOR UNIT

PUHZ-HRP71VHA
 PUHZ-HRP100VHA
 PUHZ-HRP100YHA
 PUHZ-HRP125YHA

MODE	SPL(dB)	LINE
COOLING	52	○—○
HEATING	53	●—●

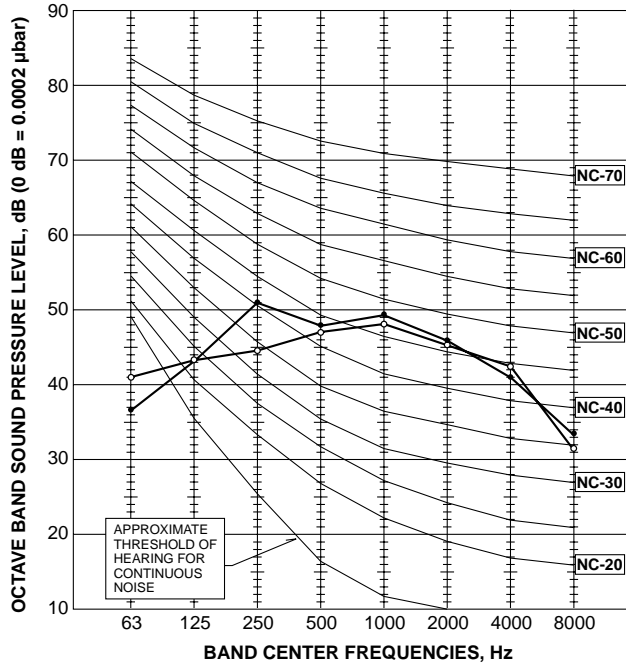

PUHZ-HRP71VHA2
 PUHZ-HRP100VHA2
 PUHZ-HRP100YHA2
 PUHZ-HRP125YHA2

MODE	SPL(dB)	LINE
COOLING	51	○—○
HEATING	52	●—●

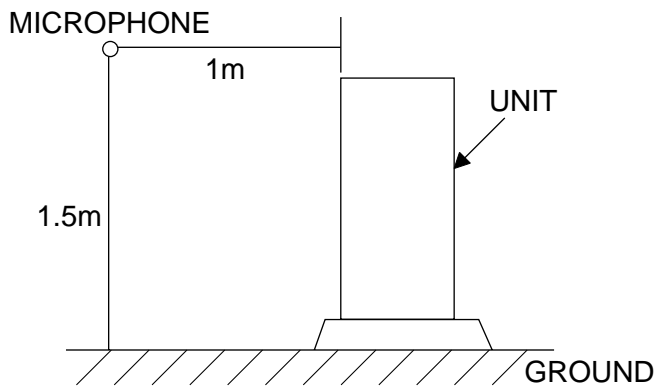
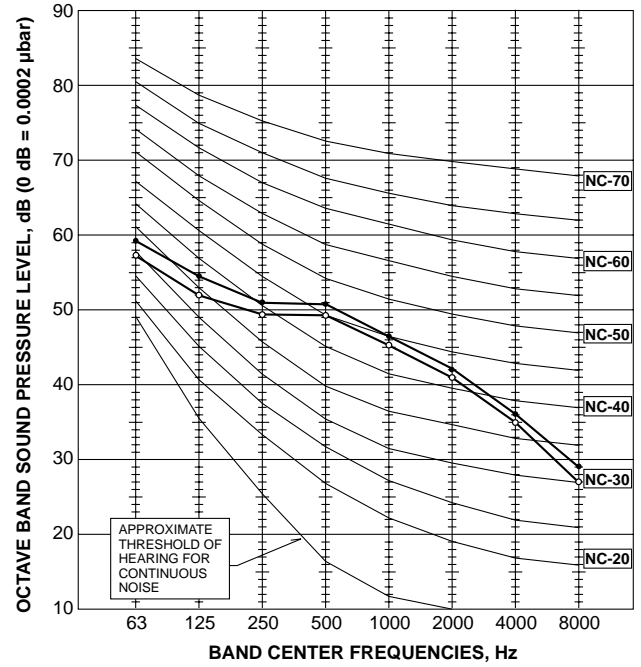

11-1. INDOOR UNIT

Part Name		Model Name	Applicable model
Remote sensor		PAC-SE41TS-E	All models
Remote operation adapter		PAC-SF40RM-E (※1)	
Multiple remote controller adapter		PAC-SA88HA-E (1 pc.)	
		PAC-725AD (10 pcs.)	
Remote on/off adapter		PAC-SE55RA-E	
Power supply terminal kit	L/N/Earth	PAC-SG96HR-E	PEAD-RP•EA(2) PKA-RP•GAL/FAL(2)
		PAC-SG94HR-E	PKA-RP•HAL/KAL
		PAC-SH52HR-E	PLA-RP•BA/BA2/BA3
	L/N	PAC-SG97HR-E	PEAD-RP•GA/JA(L)
Decoration panel		PLP-6BA	PLA-RP•BA/BA2/BA3
Decoration panel with Wireless remote controller		PLP-6BALM	
Decoration panel with Wired remote controller		PLP-6BAMD	
Automatic filter elevation panel		PLP-6BAJ	
i-see sensor corner panel		PAC-SA1ME-E	
Wireless signal receiver		PAR-SA9FA-E	
Space panel		PAC-SH48AS-E	
Air outlet shutter plate		PAC-SH51SP-E	
Multi-function casement		PAC-SH53TM-E	
Flange for fresh air intake		PAC-SH65OF-E	
High-efficiency filter element (PAC-SH53TM-E is needed.)		PAC-SH59KF-E	
Wired remote controller kit (with terminal bed)		PAR-21MAAT-E	
			PKA-RP•HAL/KAL
Drain pump		PAC-SH75DM-E	PKA-RP•HAL
		PAC-SH94DM-E	PKA-RP•KAL
		PAC-SE90DM-E	PKA-RP•FAL(2)
Motor (for high external static pressure)		PAC-SK003MT-F	PEAD-RP125EA
			PEAD-RP100EA2
Drain lift up mechanism		PAC-KE03DM-F	PEAD-RP•EA,EA2
Insulation kit		PAC-SK010DK	PEAD-RP•GA
Filter box		PAC-KE92TB-E	PEAD-RP35, 50JA(L)
		PAC-KE93TB-E	PEAD-RP60, 71JA(L)
		PAC-KE94TB-E	PEAD-RP100, 125JA(L)

(※1) Unable to use with wireless remote controller (except for PKA-RP•HAL/KAL).

11-2. OUTDOOR UNIT

Part Name		Model Name	Applicable model
M-NET adapter		PAC-SF81MA-E	PUHZ-HRP71-125
A-control service tool		PAC-SK52ST	PUHZ-HRP71-125
Drain socket		PAC-SG61DS-E	PUHZ-HRP71-125
Air outlet guide (HRP71/100/125 needs 2 pieces.)		PAC-SG59SG-E	PUHZ-HRP71-125
Air protect guide (HRP71/100/125 needs 2 pieces.)		PAC-SH63AG-E	PUHZ-HRP71-125
Drain pan		PAC-SG64DP-E	PUHZ-HRP71-125
Filter dryer	(ϕ 9.52)	PAC-SG82DR-E	PUHZ-HRP71-125
Distribution pipe	(Twin)	MSDD-50TR-E	PUHZ-HRP71-125
Joint pipe (Unit → Extension pipe)	(ϕ 15.88 → ϕ 19.05)	PAC-SG75RJ-E	PUHZ-HRP71-125
Interface (cased)		PAC-IF011B-E	PUHZ-HRP71-125
		PAC-IF012B-E	PUHZ-HRP71-125
Drain hose heater		PAC-SE60RA-E	PUHZ-HRP71-125-HA2R1

Mr. SLIM™

 **MITSUBISHI ELECTRIC CORPORATION**

HEAD OFFICE : TOKYO BLDG., 2-7-3, MARUNOUCHI, CHIYODA-KU, TOKYO 100-8310, JAPAN