



PEAD-RP35EA2

Power Inverter Heat Pump

R410A Ceiling Concealed Ducted System

Advanced inverter technology makes the Mr Slim Power Inverter the number one choice for improving comfort. They provide energy savings of up to 70% annually when compared to a previous non-inverter model. Operating noise has also been reduced thanks to improvements in fan design, while existing pipe work is reusable for easier maintenance and installation.



Pictures not to scale

Product Details

PEAD-RP35EA2 Indoor Unit

Capacity (kW):	
Heating (Nominal) (Low - High)	4.10 (1.60 - 5.20)
Cooling (Nominal) (Low - High)	3.60 (1.60 - 4.50)
Heating (UK) (Low - High)	3.50 (1.35 - 4.40)
Cooling (UK) (Low - High)	3.25 (1.45 - 4.05)
SHF R410A (Nominal)	0.89
COP / EER (Nominal)	3.41 / 3.21
Energy Label Heating / Cooling	B / A
Width - mm	935
Depth - mm	700
Height - mm	295
Weight - kg	33
Airflow (m ³ /min) - Lo-Hi	13.5-17
External Static Pressure Pa - Lo-Hi	30-70
Noise (dBA) - Lo-Hi	36-40
Pipe Size Gas mm (in)	12.7 (1/2)
Pipe Size Liquid mm (in)	6.35 (1/4)
Electrical Supply	Fed by Outdoor Unit
Phase	Single
Fuse Rating (BS88) - HRC (A)	6
Interconnecting Cable No. Cores	4
Remote Controller Ref	PAR-21MAA

PUHZ-RP35VHA3 Outdoor Unit

Width - mm	800
Depth - mm	300 + 23
Height - mm	600
Weight - kg	42
Noise (dBA) (Heating /Cooling)	46 /44
Electrical Supply	220-240v, 50Hz
Phase	Single
Fuse Rating (BS88) - HRC (A)	16
SystemPower Input (kW) - Heating (Nominal)	1.2
SystemPower Input (kW) - Cooling (Nominal)	1.12
SystemPower Input (kW) - Heating (UK)	1.05
SystemPower Input (kW) - Cooling (UK)	0.95
Starting Current (A)	5
SystemRunning Current (A) - Heating / Cooling	4.84 / 4.62
Mains Cable No. Cores	3
Max Pipe Length (m)	50
Max Height Difference (m)	30
Charge (kg) - 30m	2.5

Dimensions

PEAD-RP35EA2

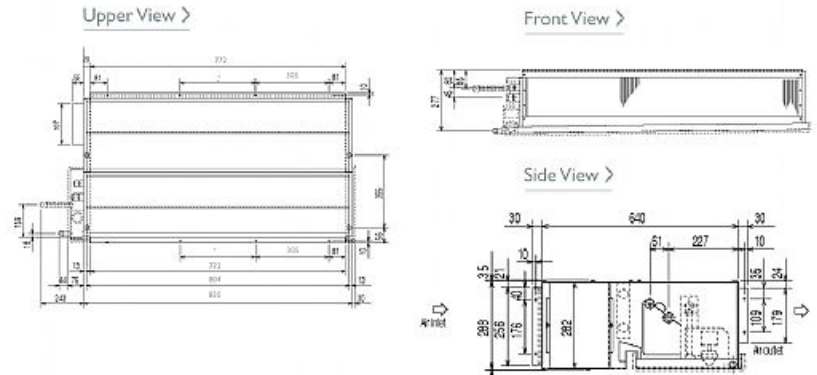

PUHZ-RP35VHA3

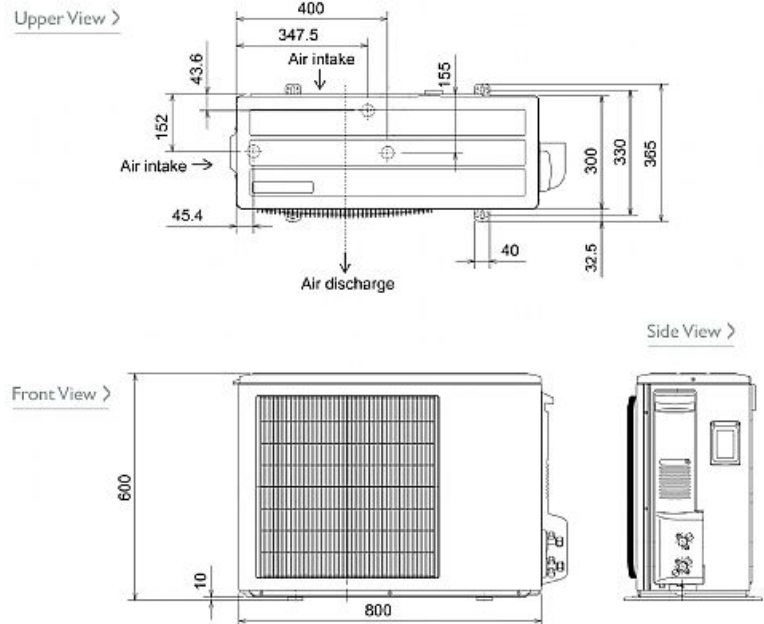

Telephone: 01707 282880

Email: air.conditioning@meuk.mee.com Website: <http://www.mitsubishielectric.co.uk/aircon>

Tel:
Fax:



Mitsubishi Electric reserves the right to make any variation in technical specification to the equipment described, or to withdraw or replace products without prior notification or public announcement.