



PEAD-RP60EA

Standard Inverter Heat Pump

R410A Ceiling Concealed Ducted System

The new Standard Inverter range provides inverter solutions for customers who want all the benefits that inverters offer, but do not have the budget available for the more expensive Power Inverter range.



Pictures not to scale

Product Details

PEAD-RP60EA Indoor Unit

Capacity (kW):	
Heating (Nominal) (Low - High)	7.00 (0.90 - 8.00)
Cooling (Nominal) (Low - High)	6.00 (1.10 - 6.30)
Heating (UK) (Low - High)	5.80 (0.75 - 6.65)
Cooling (UK) (Low - High)	5.95 (1.10 - 6.25)
SHF R410A (Nominal)	0.8
COP / EER (Nominal)	3.38 / 2.93
Energy Label Heating / Cooling	C / C
Width - mm	1175
Depth - mm	700
Height - mm	295
Weight - kg	42
Airflow (m ³ /min) - Lo-Hi	17-21
External Static Pressure Pa - Lo-Hi	30-70
Noise (dBA) - Lo-Hi	37-41
Pipe Size Gas mm (in)	15.88 (5/8)
Pipe Size Liquid mm (in)	6.35 (1/4)
Electrical Supply	Fed by Outdoor Unit
Phase	Single
Fuse Rating (BS88) - HRC (A)	6
Interconnecting Cable No. Cores	4
Remote Controller Ref	PAR-21MAA

SUZ-KA60VA Outdoor Unit

Width - mm	840
Depth - mm	330
Height - mm	850
Weight - kg	53
Noise (dBA) (Heating / Cooling) - Lo-Hi	53-55 / 51-53
Electrical Supply	220-240v, 50Hz
Phase	Single
Fuse Rating (BS88) - HRC (A)	25
System Power Input (kW) - Heating (Nominal)	2.07
System Power Input (kW) - Cooling (Nominal)	2.05
System Power Input (kW) - Heating (UK)	1.88
System Power Input (kW) - Cooling (UK)	1.64
Starting Current (A)	9.75
System Running Current (A) - Heating / Cooling	10.45 / 9.05
Mains Cable No. Cores	3
Max Pipe Length (m)	30
Max Height Difference (m)	15
Charge (kg) - 7m	1.8

Dimensions

PEAD-RP60EA

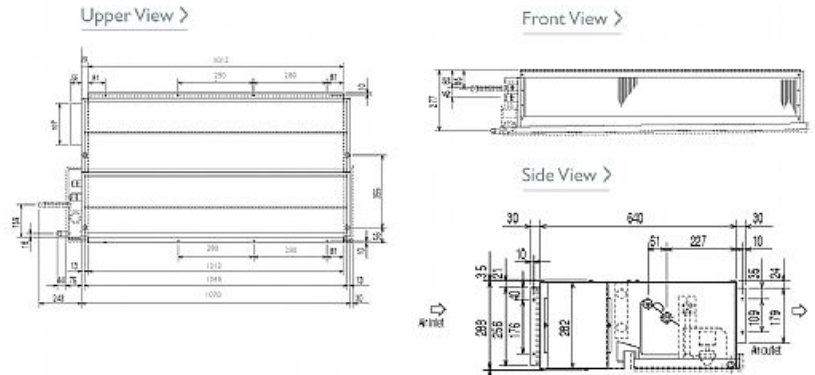

SUZ-KA60VA

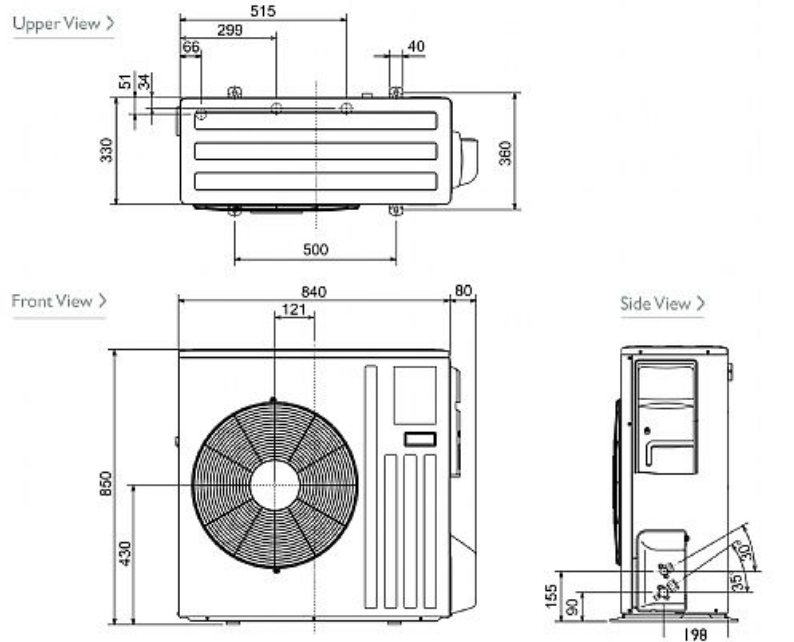

Telephone: 01707 282880

Email: air.conditioning@meuk.mee.com Website: <http://www.mitsubishielectric.co.uk/aircon>

Tel:
Fax:



Mitsubishi Electric reserves the right to make any variation in technical specification to the equipment described, or to withdraw or replace products without prior notification or public announcement.