

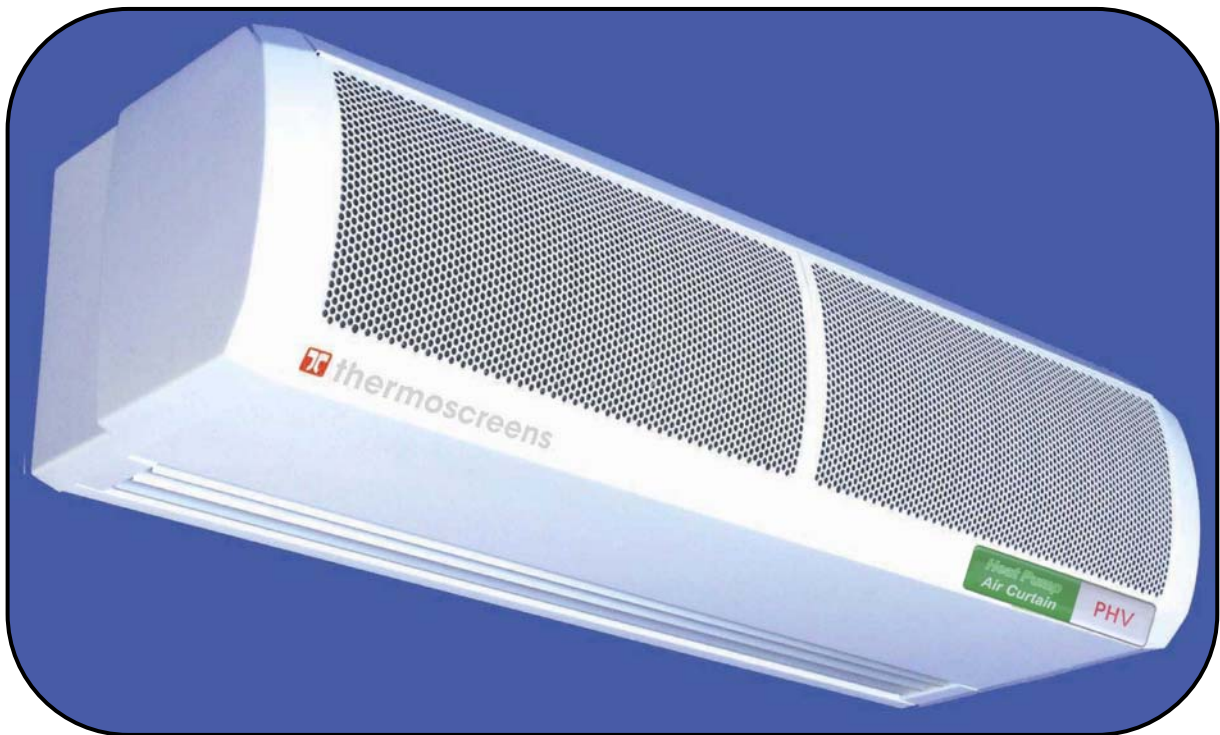

thermoscreens®

PHV HEAT PUMP RANGE AIR CURTAINS

INSTALLATION, OPERATION & MAINTENANCE INSTRUCTIONS



For use with Mr Slim units

PLEASE READ THESE INSTRUCTIONS CAREFULLY BEFORE ATTEMPTING INSTALLATION

Thermoscreens Ltd
St. Mary's Road Nuneaton
Warwickshire England
CV11 5AU

Email: sales@thermoscreens.com
Tel: +44 (0) 24 7638 4646
Fax: +44 (0) 24 7638 8578
www.thermoscreens.com



English

Thermoscreens / Mitsubishi Electric

Heat Pump Warm Air Curtain System

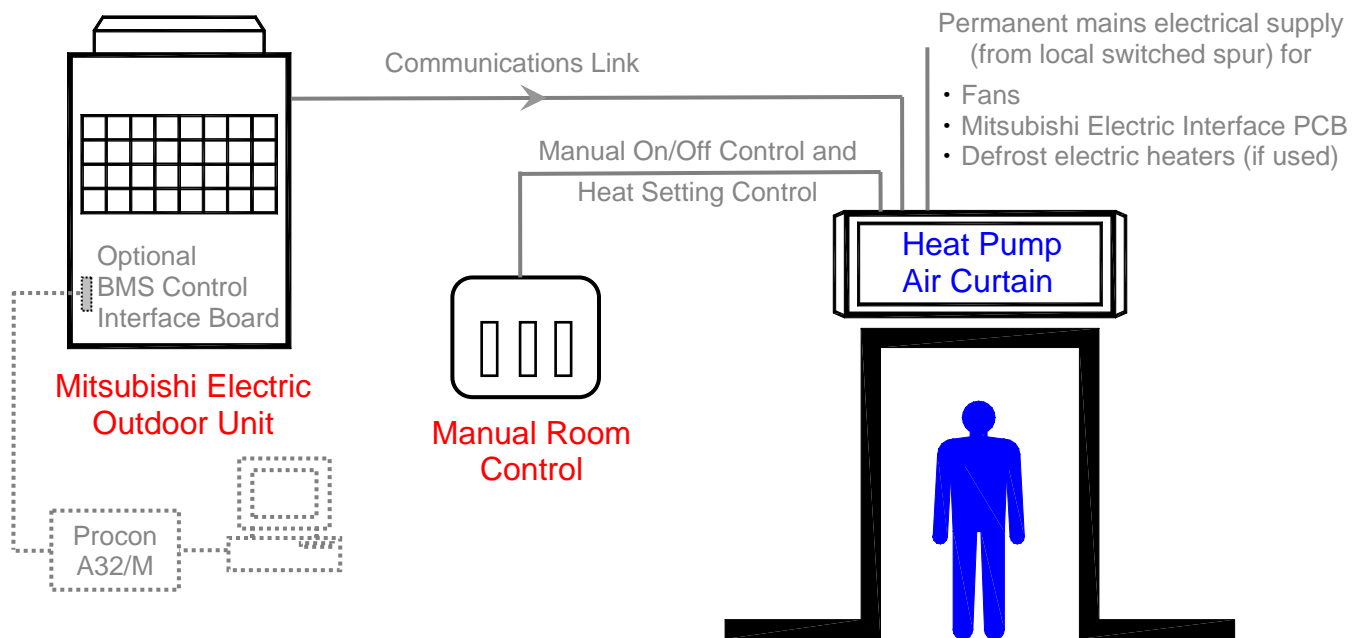

The Heat Pump Warm Air Curtain System consists of :-

- a Thermoscreens 'PHV Air Curtain' fitted with a PAC-IF010 Mitsubishi Electric Interface PCB
- a Mitsubishi Electric 'Mr Slim Outdoor Unit'
- a Thermoscreens 'Manual Room Control' for the manual control option by the occupant

Refer to Mitsubishi Electric if the air curtain is to be controlled via a Building Management System (BMS) or Centralised Controller. Do not install Manual Room Control and BMS/Centralised Control components together, install either one or the other.

A communications link is supplied to the Thermoscreens Heat Pump Air Curtain from the Mitsubishi Electric Outdoor Unit. This link provides control of the heat output of the air curtain and tells the air curtain when the outdoor unit is in defrost mode so auxiliary electric element heaters (if specified) can provide partial heat back-up during the few minutes of defrost.

The Air Curtain requires a permanent 3 phase electrical supply (3L+N+E) from a local switched spur to provide power to the defrost cycle electric heating elements, the air curtain fans and the Mitsubishi Electric Interface PCB. If the defrost cycle electric elements are not required they can be permanently disconnected, see 'Electrical Connections', and a 1 phase electrical supply (1L+N+E) used instead.

High and Low Output in this document refers to the heat pump heating capacity of the Air Curtain, not to any electrical rating.

UNPACKING THE PHV HEAT PUMP AIR CURTAIN

The following items are supplied and packaged within the air curtain box.

PHV Heat Pump Air Curtain



Please note end caps are supplied loose to be fitted during installation

Wall Brackets and Fixing Bolts



Manual Room Control



If anything is missing or damaged please contact your place of purchase immediately.

There will also be a 'Mr Slim Outdoor Unit' supplied by Mitsubishi Electric.

The complete Thermoscreens/Mitsubishi Electric heat pump system, to provide a heat pump warm air curtain over a doorway, including wiring, fridge pipework, etc. is to be installed only by an approved Mitsubishi Electric refrigeration contractor.

For your records

Date of Purchase.....
Place of Purchase.....
Serial Number.....

For warranty purposes proof of purchase is necessary so please keep a copy of your invoice.

IMPORTANT

This Heat Pump Air Curtain is intended only for use with a Mitsubishi Electric Mr Slim Outdoor Unit, for use on R410a with a condensing temperature of 49°C.

These instructions must be read in conjunction with the Mitsubishi Electric Mr Slim Outdoor Unit instructions.

(All documentation supplied with each unit should be stored and kept for future reference.)

INSTALLATION OF THE HEAT PUMP AIR CURTAIN

The air curtain has been designed to be surface mounted inside of the building and located horizontally over a doorway. It must not be installed outside of the building, or built into a cabinet or recessed in anyway. The air curtain is intended for use as a heating only unit.

Location

The air curtain must be mounted so the discharge grille is between 1.8m minimum and 3.75m maximum above floor level and situated as close to the doorway as possible. Leave a gap of 250mm minimum above the air curtain to allow for pipework brazing operations. Beware of doorway top edges, structural beams, door opening/closure devices, etc. which may interfere with the air stream and affect the location of the unit.

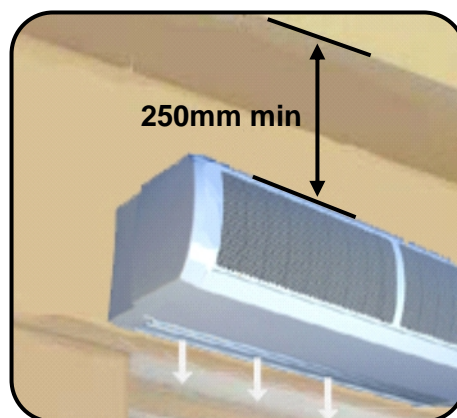

Wall Fixing

Bolt all of the wall brackets supplied to the rear face of the unit as shown in the adjacent picture using the M6 bolts supplied. Suitable wall fixing bolts (not supplied) need to be used to fix the brackets to the wall, taking into account the type of wall and the weight of the unit*, see table:



Air Curtain	Weight (kg)
PHV1000DXE HO	39
PHV1500DXE LO	59
PHV1500DXE HO	60
PHV2000DXE LO	78
PHV2000DXE HO	80

Step 1. Refer to Figure 1 for mounting details and drill the fixing points in the wall.

Step 2. Screw in the top wall bolts leaving a small gap between the head and the wall. Lower the unit onto the bolts via the key-hole slots in the top of the wall brackets and then screw in the bottom wall bolts.

Step 3. Ensure all fixing bolts are tightened and the air curtain is safely secured to the wall.

Ceiling Suspension

M10 threaded inserts are provided in the top face of the unit (see Figure 1 for positions) so it can be suspended on M10 threaded hanging rods (not provided). All suspension points must be used. Ensure each of the hanging rods is secured onto a suitable structure that can support the weight of the unit (see table above)*. Screw the hanging rods into the inserts by a minimum of 20mm and fit locking nuts (not supplied) to prevent the rod rotating and coming away from the casing. Do not screw the hanging rod too far in or it could interfere with internal components.

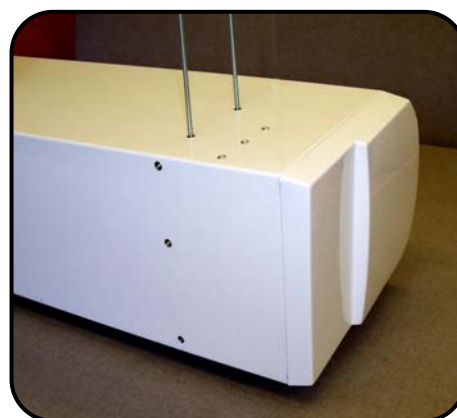

* It is the sole responsibility of the installer to ensure that the building fixing locations and suspension system used are suitable for the air curtain being installed.

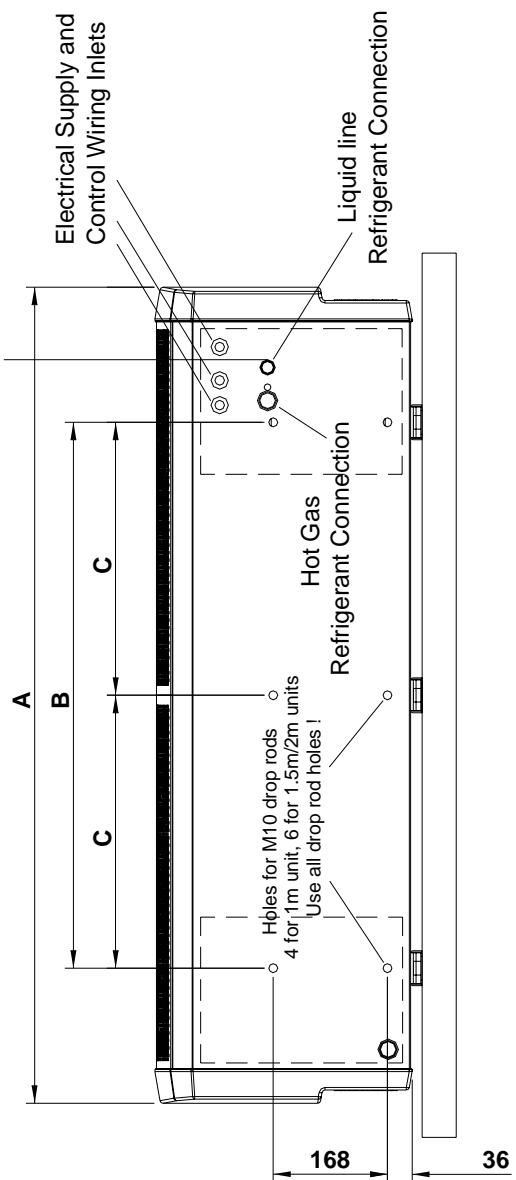
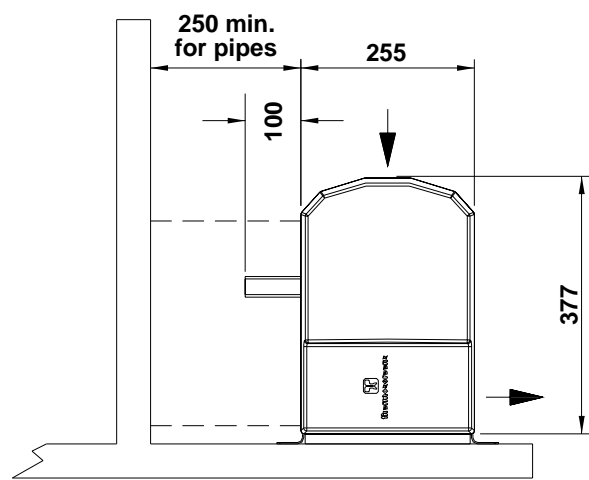
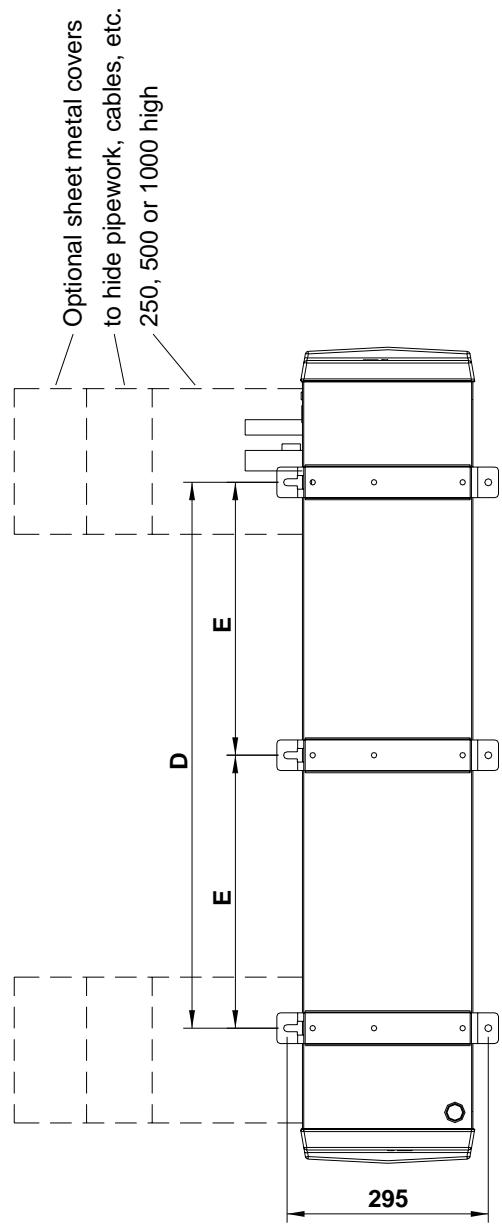

	PHV1000DX	PHV1500DX	PHV2000DX
A (mm)	1196	1746	2296
B (mm)	800	1400	1896
C (mm)	N/A	700	948
D (mm)	800	1300	1824
E (mm)	N/A	650	912

FIGURE 1 – DIMENSIONS OF PHV HEAT PUMP AIR CURTAIN

■ Mitsubishi Electric Outdoor Unit

The Mitsubishi Electric Outdoor Unit is selected to match its refrigerant heat output to the size of the Air Curtain. See table below for size of outdoor unit to be used together with performance data for the air curtain.

Air Curtain	Mr Slim Outdoor Unit	Heat Output (kW) @outdoor air 7/6°C db/wb		Max. Air Volume Flow Rate (m ³ /h)	Max. Noise Level dB(A) @3m
		Full Heat	Half Heat		
PHV1000 DXE HO	PUHZ-RP71VHA	8.6	5.34	1400	56
PHV1500 DXE LO	PUHZ-RP71VHA	10.1	5.6	2500	58
PHV1500 DXE HO	PUHZ-RP140VKA/YKA	14.4	8.3	2600	58
PHV2000 DXE LO	PUHZ-RP100VKA/YKA	14.1	7.9	3300	59
PHV2000 DXE HO	PUHZ-RP200YKA	21.3	11.2	3130	59

Indoor Air Temperature = 20°C

Performance figures derived from independent testing by UK test houses BRE and BSRIA in accordance with test standard EN 14511.

The air curtain normally operates under automatic temperature control and can also run at part load.

■ Refrigerant Pipework

This must be carried out before connection of any electrical and controls cables and in accordance with the Instructions that come with the Mitsubishi Electric Outdoor Unit. This work must only be undertaken by a Mitsubishi Electric approved Contractor.

Refrigerant installation pipework sizes are as follows :-

Air Curtain	Discharge Line (Gas)	Liquid Line	Maximum Pipe Run	
			Length	Height
PHV1000 DXE HO	5/8 in.	3/8 in.	50m	30m
PHV1500 DXE LO	5/8 in.	3/8 in.	50m	30m
PHV1500 DXE HO	5/8 in.	3/8 in.	50m	30m
PHV2000 DXE LO	5/8 in.	3/8 in.	50m	30m
PHV2000 DXE HO	1 1/8 in.	3/8 in.	100m	30m

It is intended that refrigerant pipe connections to the air curtain are made using brazed joints and these must be carried out in a professional and safe manner. If installation pipe sizes for the discharge (gas) line and liquid line are different from the pipe connection sizes on the air curtain, suitable pipe reducers must be used for the connection. R410a refrigerant systems can operate at pressures up to 610 psi (c. 42 Bar). These brazed joints may well be located in a public area and a weakness leading to an explosion could be extremely dangerous. The air curtain with its coil is

manufactured in accordance with the Pressure Equipment Directive and the installation must be carried out to a good standard of workmanship. Remove the protective plastic film on top of the air curtain before starting work. Use a heat sink on the copper pipes when brazing to reduce the transfer of heat to the inside of the air curtain where sensitive components are located.

■ To gain access inside the Air Curtain

To gain access for connection of the electrical supply, controls wiring and to work on the unit during commissioning, remove the air inlet grilles and the bottom access panel.

First remove the plastic end caps if already fitted by pulling off to the side (see picture).

Then remove each inlet grille in turn with its filter by unfastening the M4 Pozi Head screw at the bottom corner of the grille. Use a Pozi No.1 screwdriver to access the screw via the elongated hole at each bottom corner of the grille (see adjacent picture).

To remove the bottom access panel unfasten the access panel securing screws, one at each end and two in the centre (PHV1500 and PHV2000 units) and slide the panel out forwards.

Please note: All the panels of the air curtain are covered in a protective plastic film which should be removed.

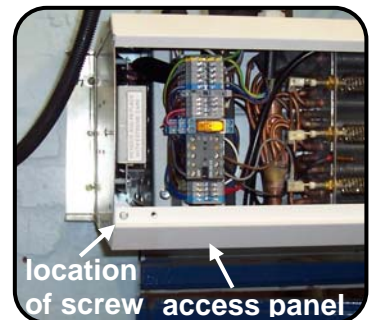
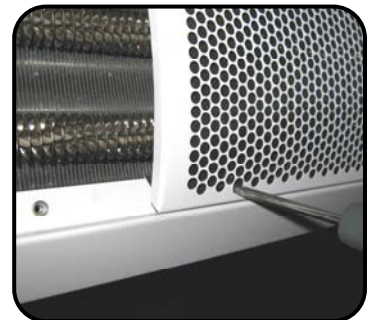
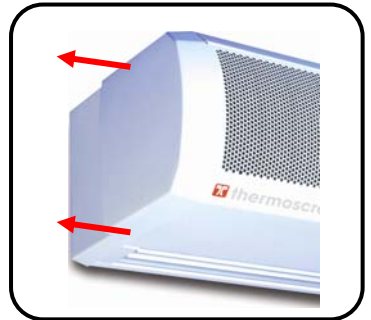

■ Electrical Supply to the Air Curtain

This must be carried out AFTER the connection of the refrigerant pipework. All electrical wiring and connections MUST be carried out by a competent qualified electrician in accordance with the latest edition of the IEE wiring regulations and/or local statutory regulations. (see also Wiring Diagram on Page 10)

- A local isolator having a contact separation of at least 3mm on all poles must be fitted in the electrical supply to the air curtain and located in an accessible position adjacent to the unit. 1 phase if defrost electric heaters are not required. 3 phase if defrost electric heaters are required.
- The appliance must be connected using cables having an appropriate temperature rating (heat resistant).
- Ensure that the supply cables, circuit breakers and other electrical installation equipment are correctly sized for the air curtain being installed. See Table overleaf.
- A 20mm size cable gland or conduit connector should be used for the Electrical Supply into the air curtain.
- This appliance must be Earthed.

Air Curtain	230V/1ph/50Hz if defrost electric heaters are not used		400V/3ph/50Hz if defrost electric heaters are required	
	Rated Electrical Power Input (kW)	Rated Current (A)	Rated Electrical Power Input (kW)	Rated Current per phase (A)
PHV1000 DXE HO	0.3	1.3	4.8	7.8
PHV1500 DXE LO	0.35	1.8	7.8	12.7
PHV1500 DXE HO	0.35	1.8	7.8	12.7
PHV2000 DXE LO	0.5	2.7	9.5	15.7
PHV2000 DXE HO	0.5	2.7	9.5	15.7

If the defrost electric heaters are to be disabled this can be done by disconnecting the neutral wire (blue or purple) from terminal A2 on the contactor inside the air curtain. The disconnected wire should be terminated safely into unused auxiliary terminal 14NO as shown in the adjacent picture, or into a suitable terminal block (see also wiring diagram on Page 10).

Note: If the defrost electric heaters are disconnected, discharge air temperatures could be very cold, approximately 6°C. Defrost times could also be extended.



Wiring to the air curtain should be carried out in accordance with the wiring diagram on Page 10 and IEE Regulations. The figure below shows the completed wiring for a 3 phase electrical supply if the defrost electric heaters are required.

1) Connection from Mitsubishi Electric Outdoor Unit

Connections to terminals S2 and S3 provide a communications link between the Mitsubishi Electric Outdoor Unit and the Air Curtain. S1 in the Mitsubishi Electric Outdoor Unit is not used at all for this Air Curtain Indoor Unit.

2) Connecting a 400V/3ph/50Hz supply

Connect to terminals L1, L2, L3, N and E with a 3-phase electrical supply. This will power the electric heating elements during the defrost cycle, air curtain fans and the Mitsubishi Electric interface pcb.

Connecting a 230V/1ph/50Hz supply

Connect to terminals L1, N and E with a 1-phase electrical supply. This will power the air curtain fans and the Mitsubishi Electric interface pcb. **NB.** Electric heaters must be disabled !!

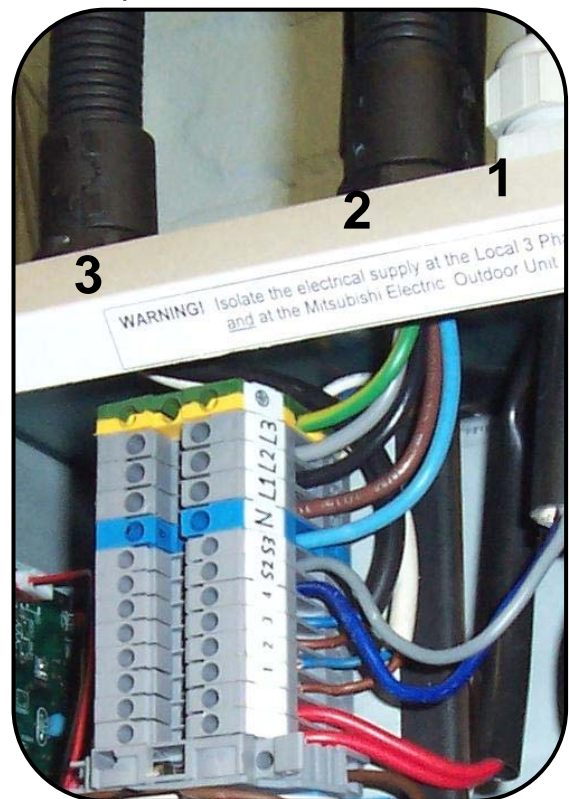

3) Connection from Manual Room Control (required only for manual control)

To comply with IEE regulations two separate 2-core, 230v mains rated double insulated cables of different colours should be used to wire from the manual room control. One 2-core cable is wired to terminals 1 & 2 (Heat Setting - signal voltage). The other 2-core cable is wired to terminals 3 & 4 (On/Off switch - 230v).

If a BMS or Centralised Controller is to be used instead of Manual Control it is not necessary to wire to terminals 1-4. **NB.** Do not install Manual Room Control and BMS/Centralised Control together as they can interfere with each other.

Recommended wire size for electrical connections are as follows:

1	2	3
1.0mm ²	2.5mm ² max for access	0.75mm ²

Do not use cable size of more than 2.5mm² or connecting the cable is difficult.

Electrical details for the Mitsubishi Electric Mr Slim Outdoor Unit are as follows:

Mr Slim Outdoor Unit	Electrical Supply (V/ph/Hz)	Maximum Current per phase (A)	Mitsubishi recommended BS88 Fuse Size (A)
PUHZ-RP71VHA	230/1/50	19.0	20
PUHZ-RP100VHA	230/1/50	26.5	32
PUHZ-RP100YHA	415/3/50	8.0	10
PUHZ-RP140VHA	230/1/50	28.0	32
PUHZ-RP140YHA	415/3/50	11.0	16
PUHZ-RP200YHA	415/3/50	19.0	20

WIRING DIAGRAM – PHV HEAT PUMP AIR CURTAIN

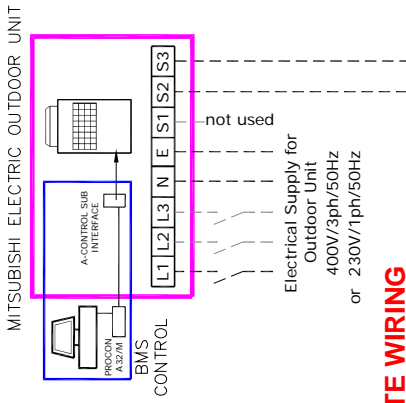
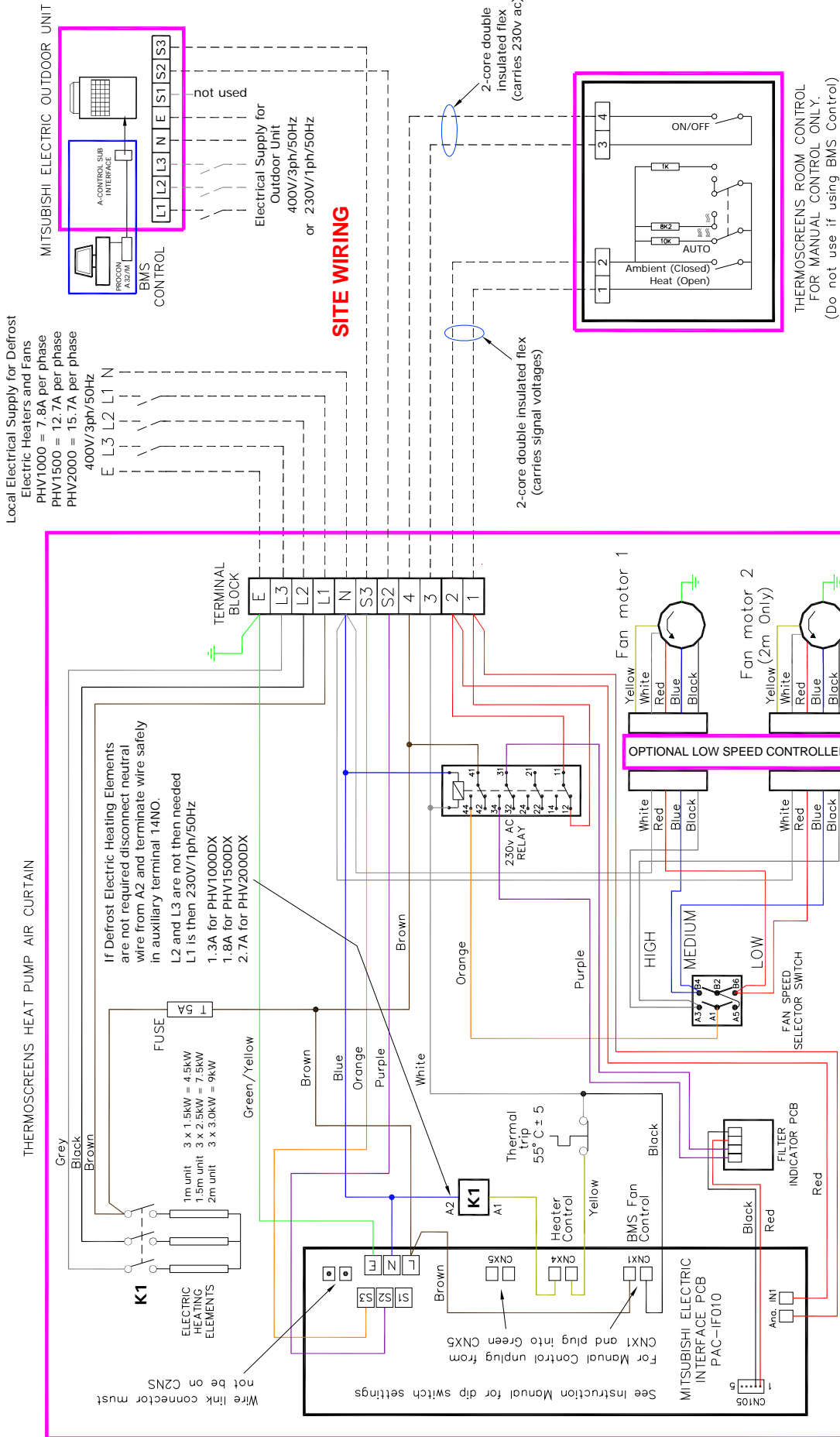

SITE WIRING

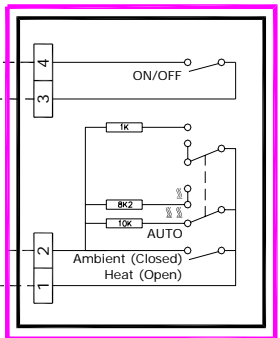

2-core double insulated flex (carries signal voltages)

2-core double insulated flex (carries 230v ac)

COMMISSIONING THE HEAT PUMP AIR CURTAIN

Ensure that the electrical supply to both the Mitsubishi Electric Outdoor Unit and the local electrical supply to the Air Curtain are switched off.

■ Air Curtain Checks

Check that the components inside the air curtain are as shown in the picture below. Check that the thermal overheat cut-out switch has not 'tripped'. Push down on the red button on the top of the thermal overheat switch - if it has tripped it will click back on.

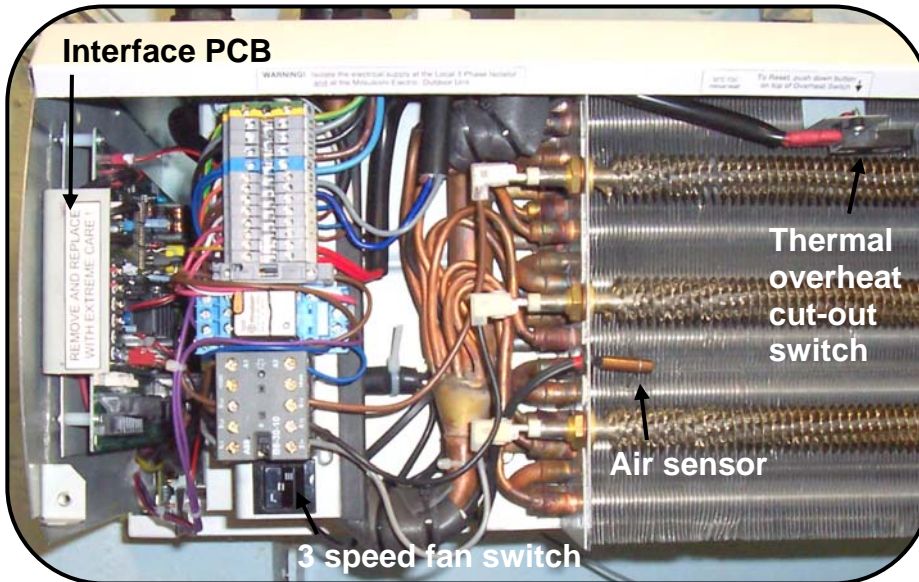

Set the adjustable aluminium air vanes within the air curtain air discharge so they point straight downwards over the doorway.

NB. The Mr Slim Outdoor Unit can be test run using dip switch SW4-1 on the outdoor unit (air curtain also needs electrical power) do not run for more than 5 mins as it will operate in cooling.

A Mitsubishi Electric Interface PCB is located within the Thermoscreens Air Curtain to provide communication between the Mitsubishi Electric Outdoor Unit and the Air Curtain Indoor Unit.

The Interface PCB on its mounting plate is held in place by a fixing screw located in the left-hand end panel of the air curtain under the left-hand plastic end cap. Remove the screw and carefully slide the pcb partially out. For easier withdrawal of the pcb the filter indicator connection may be temporarily removed.

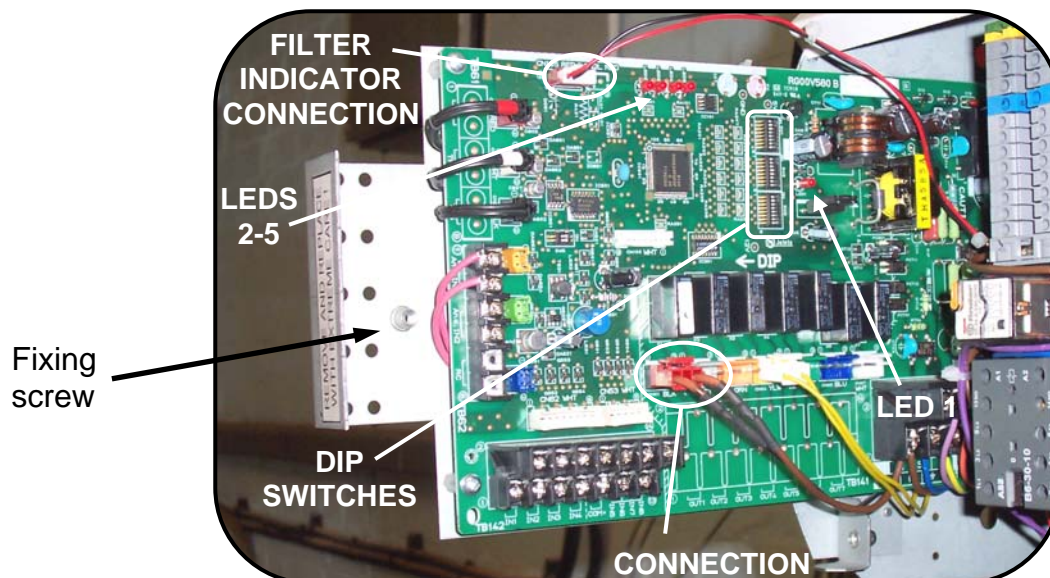

Now go to either "BMS Control" or "Manual Room Control" to continue with the Commissioning of the Air Curtain.

■ BMS Control or Centralised Controller

On the Mitsubishi Electric Interface PCB check that the BMS Fan-Run Connection is plugged into position CNX1 (as shown on previous page and Wiring Diagram). The dip switches on the Interface PCB are factory set for BMS Control, check they are as follows:

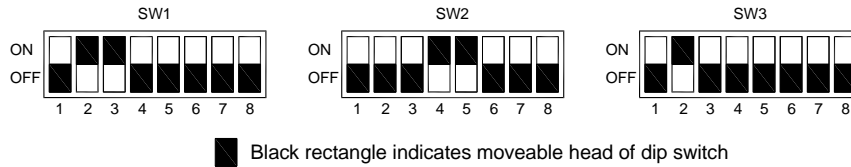

Connect a computer running the appropriate software to the Mitsubishi Electric outdoor unit. Switch on electrical power to both the Mitsubishi Electric outdoor unit and the Air Curtain. **WARNING!** Interface PCB will have 230 volts on it. Communication between the Mitsubishi Electric Outdoor Unit and the Air Curtain commences approximately 30 seconds after power-up. After this time switch on the air curtain using the 'On Off Write' parameter of the BMS software.

Once the air curtain fans are operating check that they run at Low (I), Medium (II) and High (III) speeds using the manual 3 speed fan switch inside the left hand end of the air curtain. Check there is no mechanical noise coming from the fans and that all fans are working. Select the fan speed appropriate to the site conditions and leave on this setting. LEDs 1, 2, 3 and 5 on the Interface PCB should be lit.

Set the BMS 'Mode' parameter to 2. Provided the return air temperature is below 28°C the air curtain should now be operating in heating mode. Check that the air stream from the discharge warms up across the whole length of the air curtain after approximately 20 minutes and that the air stream reaches right down across the doorway with the door open or closed. If necessary the vanes of the discharge grille can be angled either inwards or outwards if this gives better penetration/warming of any incoming draughts. Set up the BMS schedule. It is possible to:

- switch the Air Curtain on and off
- determine whether the Air Curtain is operating
- monitor the Return Air Temperature
- monitor any Mitsubishi Electric system errors
- read/write the Mitsubishi Electric Outdoor Unit Mode (heating or ambient)

Note 1: The 'Mode' parameter should only be set to '2' (heating) or '6' (Fan-Ambient). The system is designed for heating or Fan-Ambient only, using other 'Mode' settings will result in incorrect operation or malfunction. **Never set the 'Mode' parameter to '1' (cooling)** as the air curtain is not designed to cope with condensate.

Note 2: The set point and fan speed of the air curtain cannot be altered through the BMS or Centralised Controller. The set point is hard coded to 28°C * via dip switch SW2 on the Mitsubishi Interface PCB in the air curtain. The fan speed is set manually at commissioning using the 3 speed fan switch inside the air curtain (see above).

* for Set Point 26°C use dip switch settings SW2-3 ON, SW2-4 OFF, SW2-5 ON

* for Set Point 24°C use dip switch settings SW2-3 OFF, SW2-4 OFF, SW2-5 ON

Switch off the electrical power to the Mitsubishi Electric Outdoor Unit and Air Curtain. Carefully slide the Interface PCB back into place, replacing the Filter Indication

connection if removed earlier. Ensure cables are not trapped inside and refit retaining screw. The Filter Indicator Schedule can now be changed from its default setting if required (see page 15). Replace the bottom access panel, air inlet grilles (with filters) and plastic end caps (see "To gain access inside the Air Curtain" page 7). Power-up both the Outdoor Unit and Air Curtain and re-check the operation of the unit

Manual Room Control

On the Mitsubishi Electric Interface PCB the BMS Fan-Run Connection should be 'parked' at position CNX5 (green), see Wiring Diagram – Page 10. The dip switch settings should be as follows:

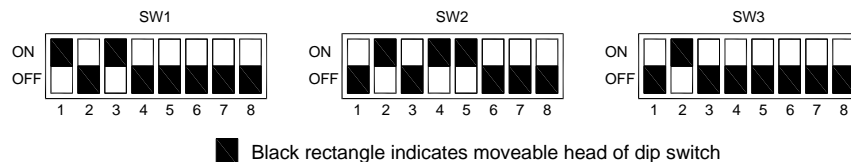

On the Thermoscreens Manual Room Control set the Fan On/Off switch to Off '0' and the Ambient/Heat switch to Ambient '⊗' Fan only. Switch on the electrical power to the Mitsubishi Electric outdoor unit and the Air Curtain. **WARNING!** Interface PCB will have 230 volts on it.

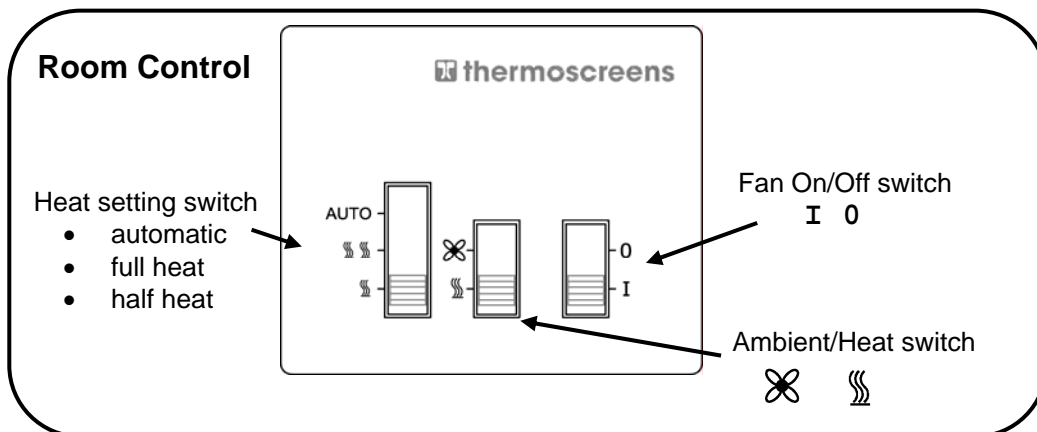

Communication between the Mitsubishi Electric Outdoor Unit and the Air Curtain commences approximately 30 seconds after power-up. After this time use the Room Control to switch on the fans. Once the air curtain fans are operating check that they run at Low (I), Medium (II) and High (III) speeds using the manual 3 speed fan switch inside the left hand end of the air curtain. Check there is no mechanical noise coming from the fans and that all fans are working. Select the fan speed appropriate to the site conditions and leave on this setting.

Using the Manual Room Control set the Ambient/Heat switch to Heat '☺' and the heat setting switch to Full Heat '☺☺☺'. Check that the air stream from the discharge warms up across the whole length of the air curtain after approximately 20 minutes and that the air stream reaches right down across the doorway with the door open or closed.

Use the Manual Room Control to test the different heat settings. LEDs 1-5 on the Interface PCB should be lit as follows.

- LED 1 indicates that there is power to the air curtain
- LEDs 2-5 indicate the different heating settings selected via the Manual Room Control heat setting switch

Heat setting	LEDs lit
ambient	1
half heat	1,3
full heat	1,3,5
automatic	1,2,3,5

Note 1: The **set point and fan speed of the air curtain cannot be altered** through the Manual Room Control. The set point is hard coded to 28°C * via dip switch SW2 on the Mitsubishi Interface PCB in the air curtain. The fan speed is set manually at commissioning using the 3 speed fan switch inside the air curtain, as described above.

* for Set Point 26°C use dip switch settings SW2-3 ON, SW2-4 OFF, SW2-5 ON

* for Set Point 24°C use dip switch settings SW2-3 OFF, SW2-4 OFF, SW2-5 ON

Switch off the electrical power to the Mitsubishi Electric Outdoor Unit and Air Curtain. Carefully slide the Interface PCB back into place, replacing the Filter Indication connection if removed earlier. Ensure cables are not trapped inside and refit retaining screw. The Filter Indicator Schedule can now be changed from its default setting if required (see page 15). Replace the bottom access panel, air inlet grilles (with filters) and plastic end caps (see “To gain access inside the Air Curtain” page 7). Power-up both the Mitsubishi Electric Outdoor Unit and Air Curtain and re-check the operation of the unit via the Manual Room Control.

■ Filter Dirty Indicator

The air curtain is fitted with a Filter Dirty Indicator. It is located at the left-hand end of the outlet grille and signals when the air curtain inlet grille/filters should be vacuum cleaned or the air curtain requires servicing.



The indicator states are outlined below:

Indicator State	Indicator Light	Action Required	Reset Button
GREEN FLASH	On 0.5s; Off 3s	None	N/A
RED ON	On permanently	Vacuum inlet	Quick reset
RED FLASH	On 0.5s; Off 0.5s	Service filters	Press for 5s

The filter indicator schedule is based on fan operating hours. For the default schedule, shown schematically below, the inlet grilles should be vacuum cleaned every 120hrs of fan operation (every 1 to 2 weeks) and a full service should take place every 480hrs of fan operation.

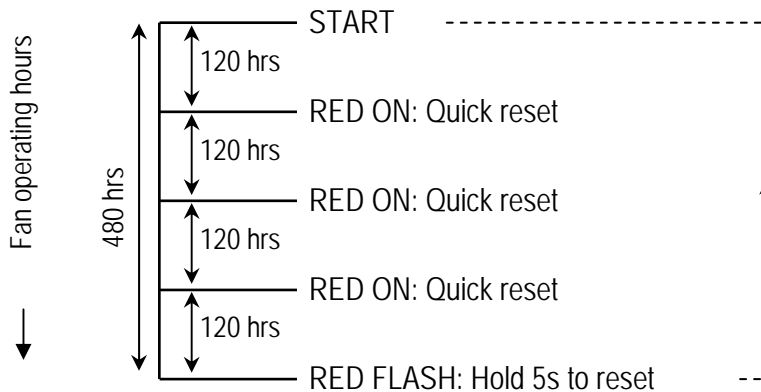

The factory set default schedule is suitable for most applications. However, the actual frequency of cleaning required will depend on the environment. Two alternative filter indicator schedules are available, and can be selected by changing the 'jumper' position (marked 1, 2 or 3) on the Filter Indicator pcb.

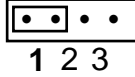
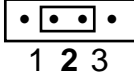
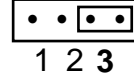
Filter Indicator Schedule	Double-frequency	Default	Half-frequency
Jumper position			
Inlet grille vacuum interval	60 hrs	120 hrs	240 hrs
Filter service interval	240 hrs	480 hrs	960 hrs

To access the Filter Indicator pcb to change jumper position:-

Switch off the electrical power to the Heat Pump Air Curtain. If the left-hand plastic end cap is already fitted, remove it from the air curtain. Unfasten the two screws as indicated.



Gently lower the left-hand end of the outlet grille, supporting it from below. The Filter Indicator pcb is now accessible to change the jumper position.

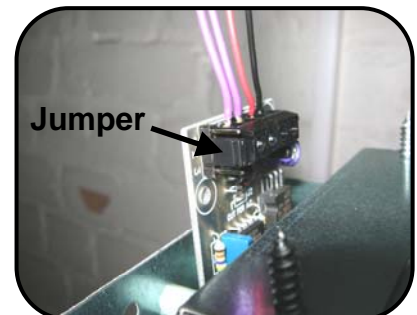

Once the filter indicator pcb 'jumper' has been re-positioned, push the outlet grille back up into place and fasten screws.

Hand-over to End-User

Before leaving site it is important that there is a 'Hand-Over Meeting' to hand-over the heat pump system and air curtain installation to the end user or their representative. This should include a full and clear explanation of how the system operates and a demonstration showing the air curtain running. Be sure to explain the Filter Indicator Schedule, that the air inlet grilles must be regularly vacuum cleaned and the unit serviced at regular intervals.

If the air curtain is to be operated under manual control, it is important that the end user understands how the Thermoscreens Manual Room Control operates (see Page 13). That the air curtain operates in FAN (Ambient) mode or in HEAT mode with a fixed target temperature of 28°C, or less if the hard coded set point has been changed via dip switch SW2 on the Mitsubishi Interface PCB in the air curtain (see Page 12).

If the air curtain is to be operated under the control of a BMS System or Centralised Controller, explain all the settings and demonstrate the operation of the system. That the air curtain should be operated in FAN (Ambient) mode or in HEAT mode with a fixed target temperature of 28°C, or less if the hard coded set point has been changed via dip

switch SW2 on the Mitsubishi Interface PCB in the air curtain (see Page 12). It is vital they understand that the air curtain must not be run in COOL or AUTO mode.

Ensure that all instructions and manuals are handed to the end user or their representative.

SERVICING THE HEAT PUMP AIR CURTAIN

■ Vacuum Clean the Air Inlet Grilles / Filters (Weekly, or when the Filter Dirty Indicator shows PERMANENT RED)

With the air curtain switched OFF, a vacuum cleaner with an extension tube and brush attachment at its end should be used to clean the face of the air inlet grilles. This is important to minimise the build-up of dust and lint on the air filters at the back of the inlet grilles which will affect the performance of the air curtain. This is a simple service task that can be carried out by the Cleaner or Janitor on a weekly basis from floor level without having to access the air curtain at high level. This should be done weekly as a regular service task and/or when the Filter Dirty Indicator shows permanent red.



Reset the Filter Dirty Indicator after cleaning by a quick press of the Reset Button (even if the indicator has not gone red).

■ Servicing the Air Curtain (suggest every 3 Months, or if the Filter Dirty Indicator shows FLASHING RED)

Always disconnect and isolate the mains electricity supply both at the local electrical supply to the Air Curtain and at the Mitsubishi Electric Outdoor Unit before servicing, maintaining or repairing the Air Curtain.

Note: All servicing, maintenance and repairs to the air curtain must be carried out by an approved Service Agent.



Remove the plastic end caps by pulling off to the side as shown.

Remove each Air Inlet Grille with its air filter by unfastening the M4 Pozi Head screw at the bottom corner of the grille. Use a Pozi No.1 screwdriver to access the screw via the elongated hole at the bottom corners of the grille.

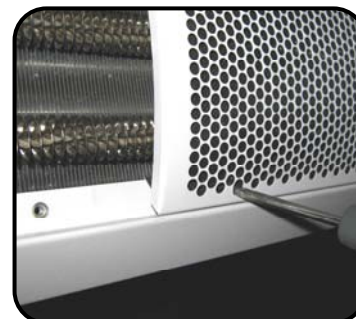

Remove the air filters from the air inlet grilles by gently prizing them free as shown. Vacuum clean and refit the filters into the curved air inlet grilles. The filters are very durable but may need to be replaced after a number of service intervals.

Remove the bottom access panel by unfastening the panel fixing screws (2 on PHV1000, 4 on PHV1500 & 2000 units) and sliding the access panel out forwards. Clean the inside of the access panel.

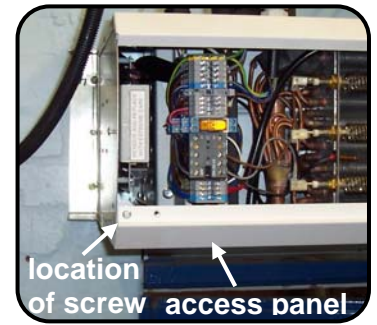

Vacuum clean and remove any build-up of dust, dirt and debris within the air-curtain, especially on the face of the coil and the electric heating elements.

Note: Fan motors are permanently lubricated and require no additional lubrication.

Once the air curtain has been cleaned, visually inspect the air curtain components. Ensure pipe temperature sensors are located in their pockets and any foam insulation covering these pockets is un-damaged. Check the location of the thermal overheating cut-out and air sensor and that the thermal overheating cut-out switch has not tripped (see Section – Commissioning, Page 11). Check all electrical connections and terminals within the unit are tight and that crimp connections have not become loose.

Refit the bottom access panel and air inlet grilles with filters. Switch on the electrical supplies and fully function test the air curtain to ensure correct operation (see Section – Commissioning, Page 13).

Reset the Filter Dirty Indicator after the service by pressing the Reset Button for at least 5 seconds (even if the indicator has not gone flashing red).and hand back the unit to the end user.



■ Fault Conditions

If the Thermoscreens Heat Pump Warm Air Curtain System does not operate as expected refer to the fault finding table below:

Symptom	Possible Cause	Action Required
Air curtain does not operate	Electrical power is not switched on at both the Mitsubishi Electric Outdoor Unit <u>and</u> at the local electrical isolator next to the Thermoscreens Air Curtain	Switch on power to Mitsubishi Electric Outdoor Unit <u>and</u> Thermoscreens Air Curtain and wait for 30 seconds
	BMS Control: Air curtain is set to 'Off'.	Check BMS schedule and amend if necessary
	Manual Control: Manual Room Control, Fan On/Off switch set to Off '0'	Use Manual Room Control to adjust fan and heat settings as appropriate
	Problem with air curtain fan motor(s), or internal wiring, or controls	Use wiring diagram to investigate possible cause of fault
Air curtain is discharging cold air	Air curtain has been running for less than 20 minutes and is still warming up	Give system sufficient time to reach operating condition
	BMS Control: Air curtain is set to FAN (Ambient)	Check BMS schedule and change to HEAT if necessary
	Manual Control: Manual Room Control, Ambient/Heat switch is set to FAN (Ambient) '⊗'	Use Room Control to adjust fan and heat settings as appropriate
	Fixed Target Temperature on dip switch SW2 on Mitsubishi interface pcb in air curtain is set too low for heating	If necessary adjust the fixed target temperature via dip switch SW2 (see Page 12)
	Manual Control: Heat setting switch on Manual Room Control is set to 'AUTO' and the SW2 fixed target temperature has been exceeded	NB. Air Curtain will only heat if room air temperature is below the target temperature.
Air Curtain filters and/or heating coil is dirty.	Service air curtain as described in Section – Servicing on pages 17 & 18	
Mitsubishi Electric system is indicating an error code	A variety of error codes can occur because of a fault within the air curtain	Refer to Mitsubishi Electric Service Manual to understand fault, then inspect and repair air curtain if there is a fault

If the Heat Pump Warm Air Curtain System is still not operating correctly call for a Mitsubishi Electric Service Agent.

■ Warranty

If any problems are encountered with the heat pump warm air curtain please contact your Mitsubishi Electric Service Agent.

Care has been taken in compiling these instructions to ensure they are correct, although Thermoscreens Ltd. disclaims all liability for damage resulting from any inaccuracies and/or deficiencies in this documentation. Thermoscreens Ltd. retain the right to change the specifications stated in these instructions.

Thermoscreens Ltd
St. Mary's Road Nuneaton
Warwickshire England
CV11 5AU

Email: sales@thermoscreens.com

Tel: + 44 (0) 24 7638 4646

Fax: + 44 (0) 24 7638 8578

www.thermoscreens.com

Thermoscreens Ltd
St. Mary's Road
Nuneaton
Warwickshire
CV11 5AU
United Kingdom
Telephone: +44 (0)24 7638 4646
Fax: +44 (0)24 7638 8578



thermoscreens®

EC DECLARATION OF CONFORMITY

as defined by the EC Council Directive on Machinery 2006/42/EC, the Low Voltage Directive 73/23/EEC, the Electromagnetic Compatibility Directive 89/336/EEC and the Pressure Equipment Directive 97/23/EC

Herewith we declare that the air movement equipment designated below, on the basis of its design and construction in the form brought onto the market by us in accordance with the relevant safety, health and performance requirements of the Machinery.

If alterations are made to the machinery without prior written permission from us this declaration becomes invalid.

Designation of Equipment : THERMOSCREENS AIR CURTAINS

Series Type : PHV1000 DXE HO, PHV1000RDXE HO, PHV1500 DXE LO, PHV1500RDXE LO, PHV1500 DXE HO, PHV1500R DXE HO, PHV2000 DXE LO, PHV2000R DXE LO, PHV2000 DXE HO, PHV2000R DXE HO

Relevant EC Council the Machinery Directive (2006/42/EC)
the Low Voltage Directive (73/23/EEC as amended by 93/68/EEC)
the Electromagnetic Compatibility Directive (89/336/EEC as amended by 91/31/EEC and 93/68/EEC)
the Pressure Equipment Directive (97/23/EC)

Applied Harmonised Standards : Machinery - EN 292-1, EN 292-2, EN 294, EN 394, EN 414
LVD - EN 60335-1, EN 60335-2-30, EN 60335-2-40
EMC - EN55011, EN 61000-3-2, EN 61000-3-3, EN 61000-4-2, EN 61000-4-4, EN61000-4-5, EN61000-4-11, EN61000-6-4
PED - EN 13134, EN 13133

Basis of Self Attestation : Quality Assurance to BS EN ISO 9001 : 2000
B.S.I. Registered Firm Certificate Number FM 85224

Responsible Person : Mr. M. Francis, Managing Director, Thermoscreens Limited

Date : 17th June 2009

Signed : 