

OUTDOOR UNIT

SERVICE MANUAL



No. OBH723

Models

MXZ-4E83VA - E1, ET1

MXZ-5E102VA - E1, ET1

Indoor unit service manual
 MSZ-EF•VE Series (OBH589)
 MSZ-SF•VA Series (OBH555)
 MSZ-SF•VE Series (OBH600)
 MSZ-FH•VE Series (OBH623)
 MSZ-GF•VE Series (OBH634)
 MFZ-KJ•VE Series (OBH666)
 MLZ-KA•VA Series (OBH483)
 SLZ-KA•VA Series (OC320)
 SEZ-KD•VA Series (HWE07110)
 PLA-RP•BA Series (OCH412)
 PCA-RP•KA Series (OCH454)
 PEAD-RP•JA Series (HWE08130)

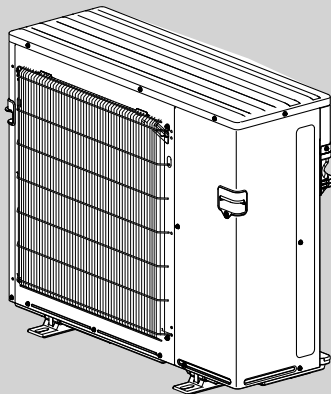

CONTENTS

1. TECHNICAL CHANGES	2
2. PART NAMES AND FUNCTIONS.....	3
3. SPECIFICATION.....	4
4. NOISE CRITERIA CURVES	6
5. OUTLINES AND DIMENSIONS	7
6. WIRING DIAGRAM.....	9
7. REFRIGERANT SYSTEM DIAGRAM	13
8. PERFORMANCE CURVES	16
9. ACTUATOR CONTROL.....	27
10. SERVICE FUNCTIONS.....	28
11. TROUBLESHOOTING	30
12. DISASSEMBLY INSTRUCTIONS.....	47

INDOOR UNITS COMBINATION SHEETS

PARTS CATALOG (OBB723)

NOTE:

RoHS compliant products have <G> mark on the spec name plate.

Use the specified refrigerant only

Never use any refrigerant other than that specified.

Doing so may cause a burst, an explosion, or fire when the unit is being used, serviced, or disposed of.

Correct refrigerant is specified in the manuals and on the spec labels provided with our products.

We will not be held responsible for mechanical failure, system malfunction, unit breakdown or accidents caused by failure to follow the instructions.

<Preparation before the repair service>

- Prepare the proper tools.
- Prepare the proper protectors.
- Provide adequate ventilation.
- After stopping the operation of the air conditioner, turn off the power-supply breaker and remove the power plug.
- Discharge the capacitor before the work involving the electric parts.

<Precautions during the repair service>

- Do not perform the work involving the electric parts with wet hands.
- Do not pour water into the electric parts.
- Do not touch the refrigerant.
- Do not touch the hot or cold areas in the refrigeration cycle.
- When the repair or the inspection of the circuit needs to be done without turning off the power, exercise great caution not to touch the live parts.

1

TECHNICAL CHANGES

MXZ-4E83VA -^[E1], ^[ET1]

MXZ-5E102VA -^[E1], ^[ET1]

1. New model

MXZ-4E83VA
MXZ-5E102VA

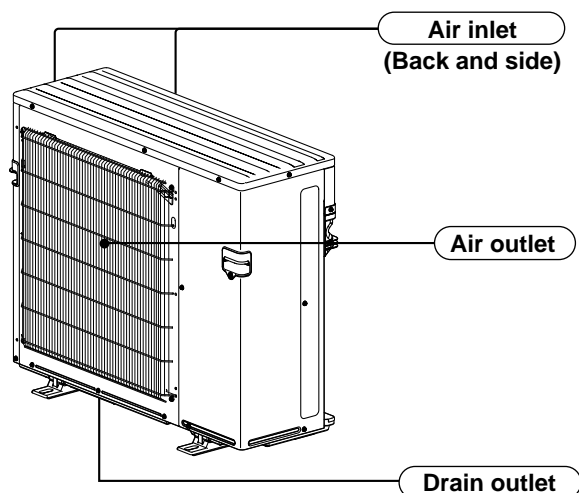

ACCESSORIES

Model	MXZ-4E83VA MXZ-5E102VA
① Drain socket	1
② Drain cap	5

Outdoor model			MXZ-4E83VA	
Outdoor unit power supply			Single phase 230 V, 50 Hz	
System	Indoor units number		2 to 4	
	Piping total length	m	Max. 70	
	Connecting pipe length	m	Max. 25	
	Height difference (Indoor ~ Outdoor)	m	Refer to 7 REFRIGERANT SYSTEM DIAGRAM.	
	Height difference (Indoor ~ Indoor)	m	Refer to 7 REFRIGERANT SYSTEM DIAGRAM.	
Function			Cooling	Heating
Capacity Rated frequency (Min.-Max.) *2		kW	8.3 (3.7 - 9.2)	9.3 (3.4 - 11.6)
Breaker capacity		A	25	
Electrical data	Power input (Total) *1, *2	W	2,440	2,000
	Running current (Total) *1, *2	A	10.7	8.8
	Power factor (Total) *1, *2	%	99	
	Starting current (Total) *1, *2	A	10.7	
Coefficient of performance (C.O.P) (Total) *1, *2			3.40	4.65
Compressor	Model		SNB220FAGMC	
	Output	W	2,200	
	Current *1, *2	A	10.1	8.1
	Refrigeration oil (Model)	L	0.7 (FV50S)	
Fan motor	Model		SIC-81FW-D888-9	
	Current *1, *2	A	0.3	
Dimensions W x H x D		mm	950 x 796 x 330	
Weight		kg	62	
Special remarks	Air flow (Rated)	m ³ /h	3,336	3,336
	Sound level (Rated)	dB(A)	49	51
	Fan speed (Rated)	rpm	620	620
	Refrigerant filling capacity (R410A)	kg	2.99	

*1 Measured under rated operating frequency.

*2 When connected with below indoor units.

MSZ-EF18VE + MSZ-EF18VE + MSZ-EF22VE + MSZ-EF25VE

NOTE: Test conditions are based on ISO 5151. (Refrigerant piping length (one way): 5 m)

COOLING INDOOR Dry-bulb temperature 27.0°C Wet-bulb temperature 19.0°C

OUTDOOR Dry-bulb temperature 35.0°C Wet-bulb temperature 24.0°C

HEATING INDOOR Dry-bulb temperature 20.0°C

OUTDOOR Dry-bulb temperature 7.0°C Wet-bulb temperature 6.0°C



Outdoor model			MXZ-5E102VA		
Outdoor unit power supply			Single phase 230 V, 50 Hz		
System	Indoor units number		2 to 5		
	Piping total length	m	Max. 80		
	Connecting pipe length	m	Max. 25		
	Height difference (Indoor ~ Outdoor)	m	Refer to 7 REFRIGERANT SYSTEM DIAGRAM.		
	Height difference (Indoor ~ Indoor)	m	Refer to 7 REFRIGERANT SYSTEM DIAGRAM.		
Function			Cooling	Heating	
Capacity Rated frequency (Min.-Max.) *2		kW	10.2 (3.9 - 11.0)	10.5 (4.1 - 14.0)	
Breaker capacity		A	25		
Electrical data	Power input (Total) *1, *2		W	3,150	2,340
	Running current (Total) *1, *2		A	13.8	10.3
	Power factor (Total) *1, *2		%	99	
	Starting current (Total) *1, *2		A	13.8	
Coefficient of performance (C.O.P) (Total) *1, *2			3.24	4.49	
Compressor	Model		SNB220FAGMC		
	Output	W	2,800		
	Current *1, *2	A	13.0	9.4	
	Refrigeration oil (Model)	L	0.7 (FV50S)		
Fan motor	Model		SIC-81FW-D888-9		
	Current *1, *2	A	0.5		
Dimensions W x H x D		mm	950 x 796 x 330		
Weight		kg	63		
Special remarks	Air flow (Rated)	m ³ /h	3,906	4,080	
	Sound level (Rated)	dB(A)	52	56	
	Fan speed (Rated)	rpm	720	750	
	Refrigerant filling capacity (R410A)	kg	2.99		

*1 Measured under rated operating frequency.

*2 When connected with below indoor units.

MSZ-EF18VE + MSZ-EF18VE + MSZ-EF22VE + MSZ-EF22VE + MSZ-EF22VE

NOTE: Test conditions are based on ISO 5151. (Refrigerant piping length (one way): 5 m)

COOLING INDOOR Dry-bulb temperature 27.0°C Wet-bulb temperature 19.0°C

OUTDOOR Dry-bulb temperature 35.0°C Wet-bulb temperature 24.0°C

HEATING INDOOR Dry-bulb temperature 20.0°C

OUTDOOR Dry-bulb temperature 7.0°C Wet-bulb temperature 6.0°C

NOISE CRITERIA CURVES

MXZ-4E83VA

FAN SPEED	FUNCTION	SPL(dB(A))	LINE
High	Cooling	49	●—●
High	Heating	51	○—○

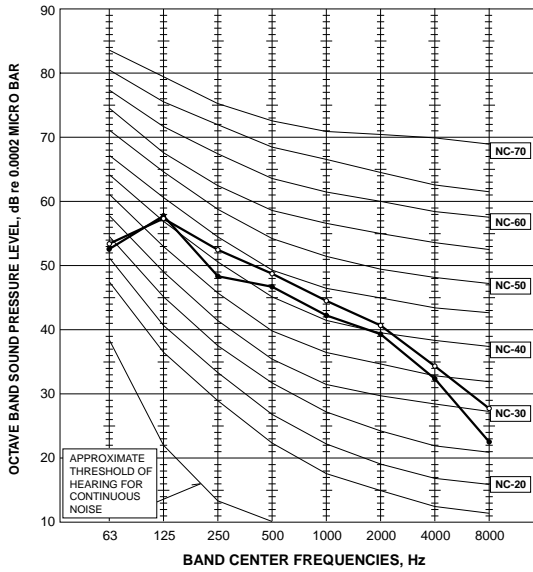

MXZ-5E102VA

FAN SPEED	FUNCTION	SPL(dB(A))	LINE
High	Cooling	52	●—●
High	Heating	56	○—○

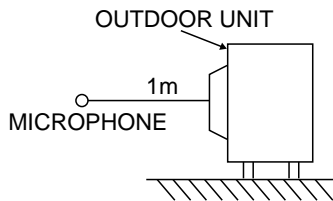
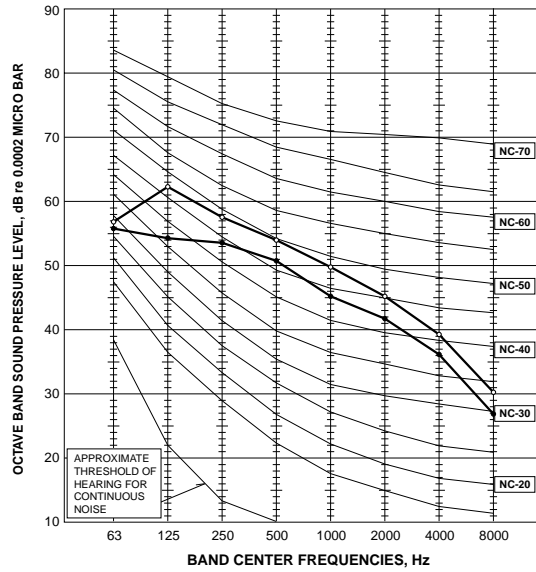

Test conditions

Cooling :Dry-bulb temperature 35°C Wet-bulb temperature 24°C
 Heating :Dry-bulb temperature 7°C Wet-bulb temperature 6°C

5 OUTLINES AND DIMENSIONS

MXZ-4E83VA

Unit: mm

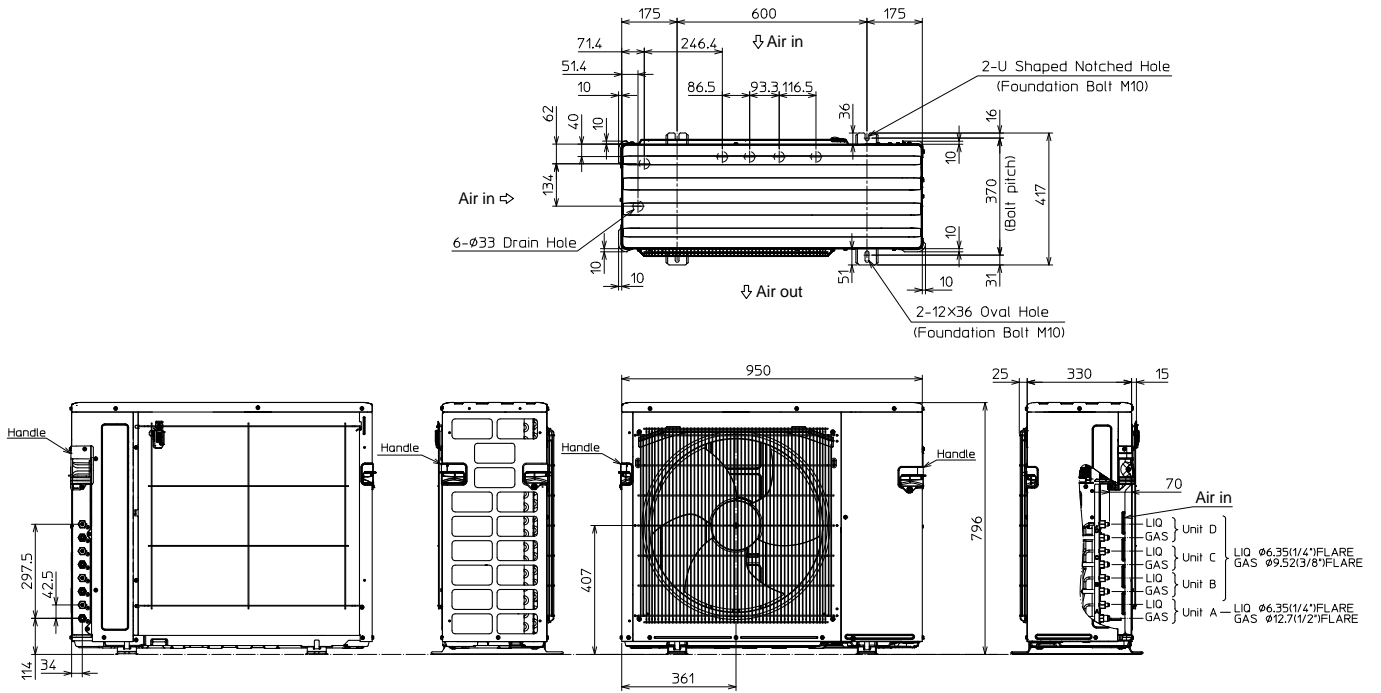

1.FREE SPACE

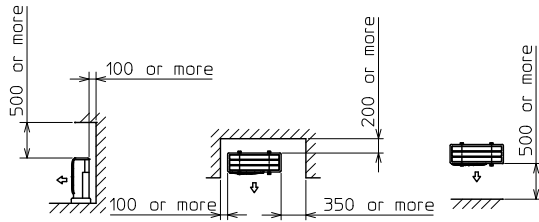

2.SERVICE SPACE

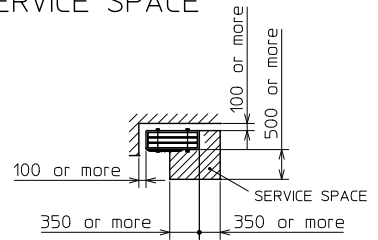

MXZ-5E102VA

Unit: mm

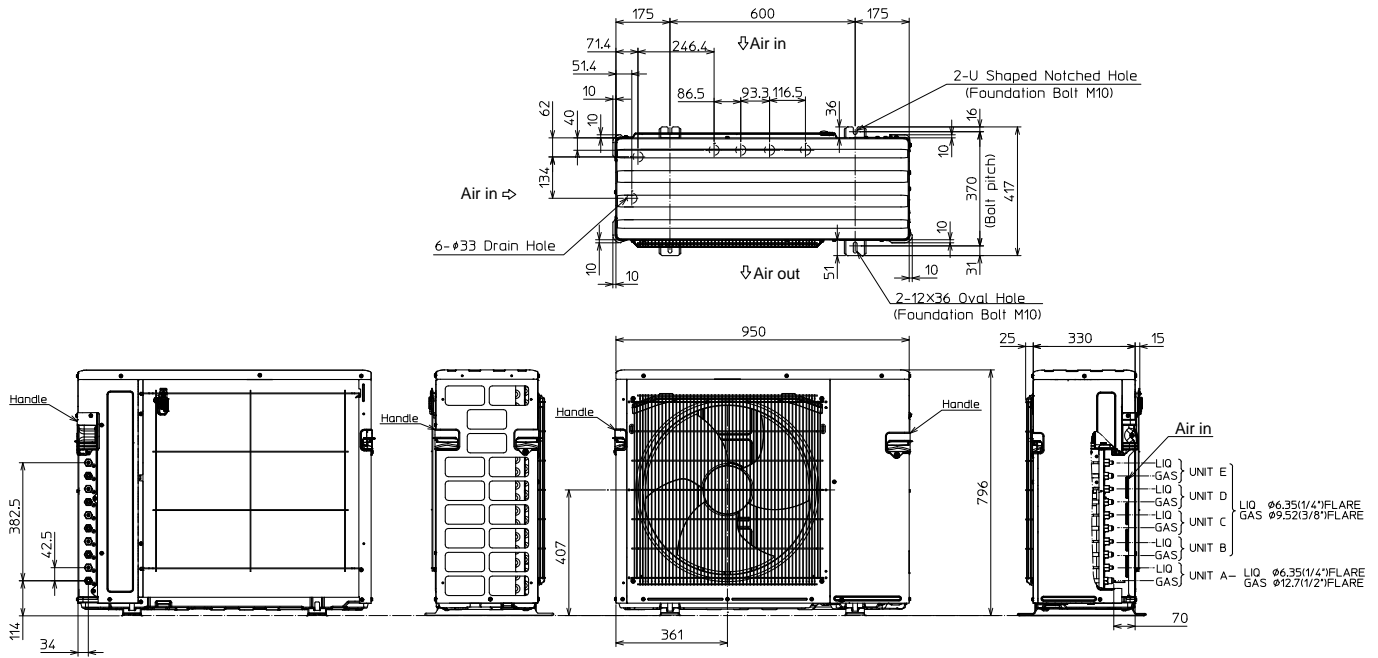

1. FREE SPACE

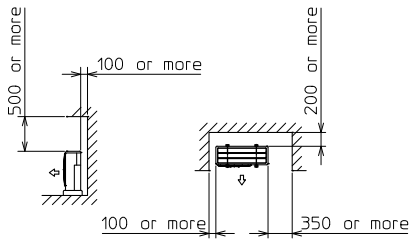

2. SERVICE SPACE

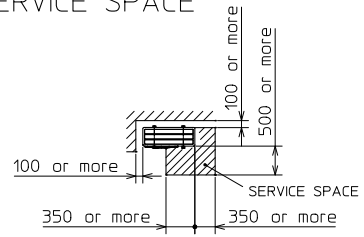

MXZ-4E83VA - E1

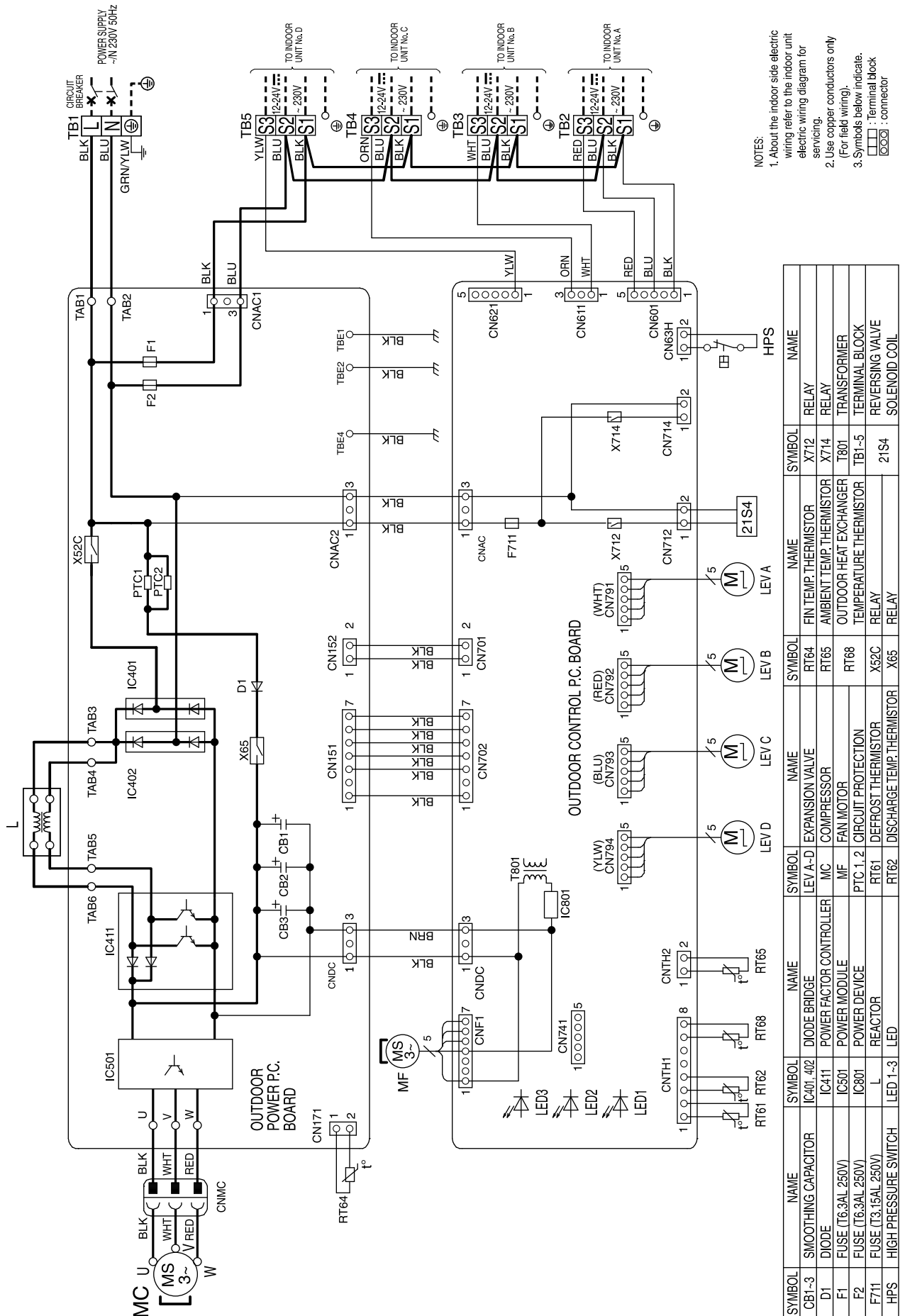

NOTES:
 1. About the indoor side electric wiring refer to the indoor unit electric wiring diagram for servicing.
 2. Use copper conductors only. (For field wiring).
 3. Symbols below indicate.
 □ : Terminal block
 ○ : connector

MXZ-4E83VA - [ET1]

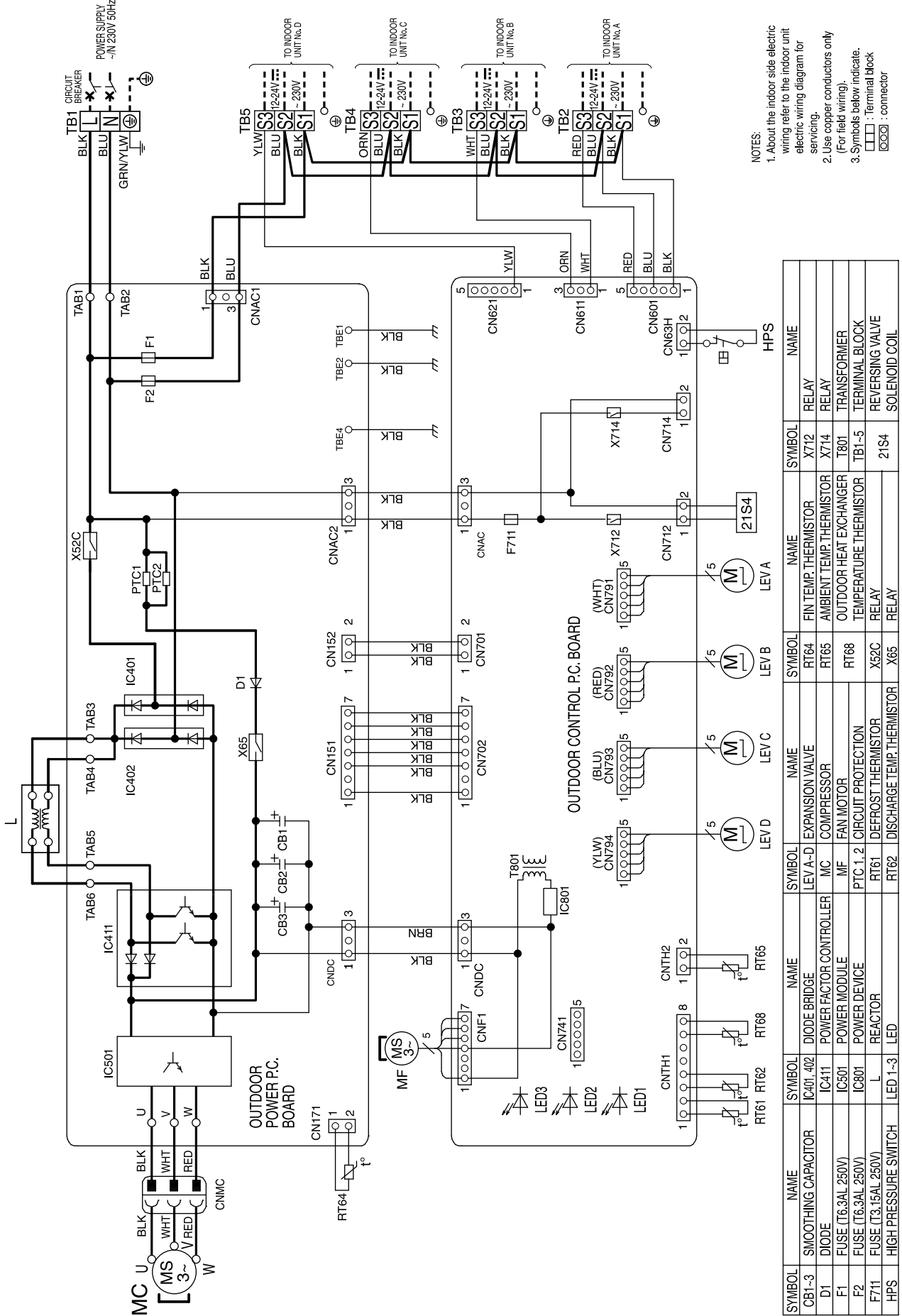

- NOTES:**
1. About the indoor side electric wiring refer to the indoor unit electric wiring diagram for servicing.
 2. Use copper conductors only (For field wiring).
 3. Symbols below indicate.
 - : terminal block
 - : connector

SYMBOL	NAME	SYMBOL	NAME	SYMBOL	NAME	SYMBOL	NAME
CB1-3	SMOOTHING CAPACITOR	IC401, 402	DIODE BRIDGE	LEV A-D	EXPANSION VALVE	RT64	FIN TEMP. THERMISTOR
D1	DIODE	IC411	POWER FACTOR CONTROLLER	MC	COMPRESSOR	RT65	AMBIENT TEMP. THERMISTOR
F1	FUSE (T6.3AL 250V)	IC501	POWER MODULE	MF	FAN MOTOR	RT68	OUTDOOR HEAT EXCHANGER
F2	FUSE (T6.3AL 250V)	IC801	POWER DEVICE	PTC 1, 2	CIRCUIT PROTECTION	TB1-5	TEMPERATURE THERMISTOR
F711	FUSE (T3.15AL 250V)	L	REACTOR	RT61	DEFROST THERMISTOR	X52C	REVERSE VALVE
HPS	HIGH PRESSURE SWITCH	LED 1-3	LED	RT62	DISCHARGE TEMP. THERMISTOR	X85	SOLENOID COIL

MXZ-5E102VA - E1

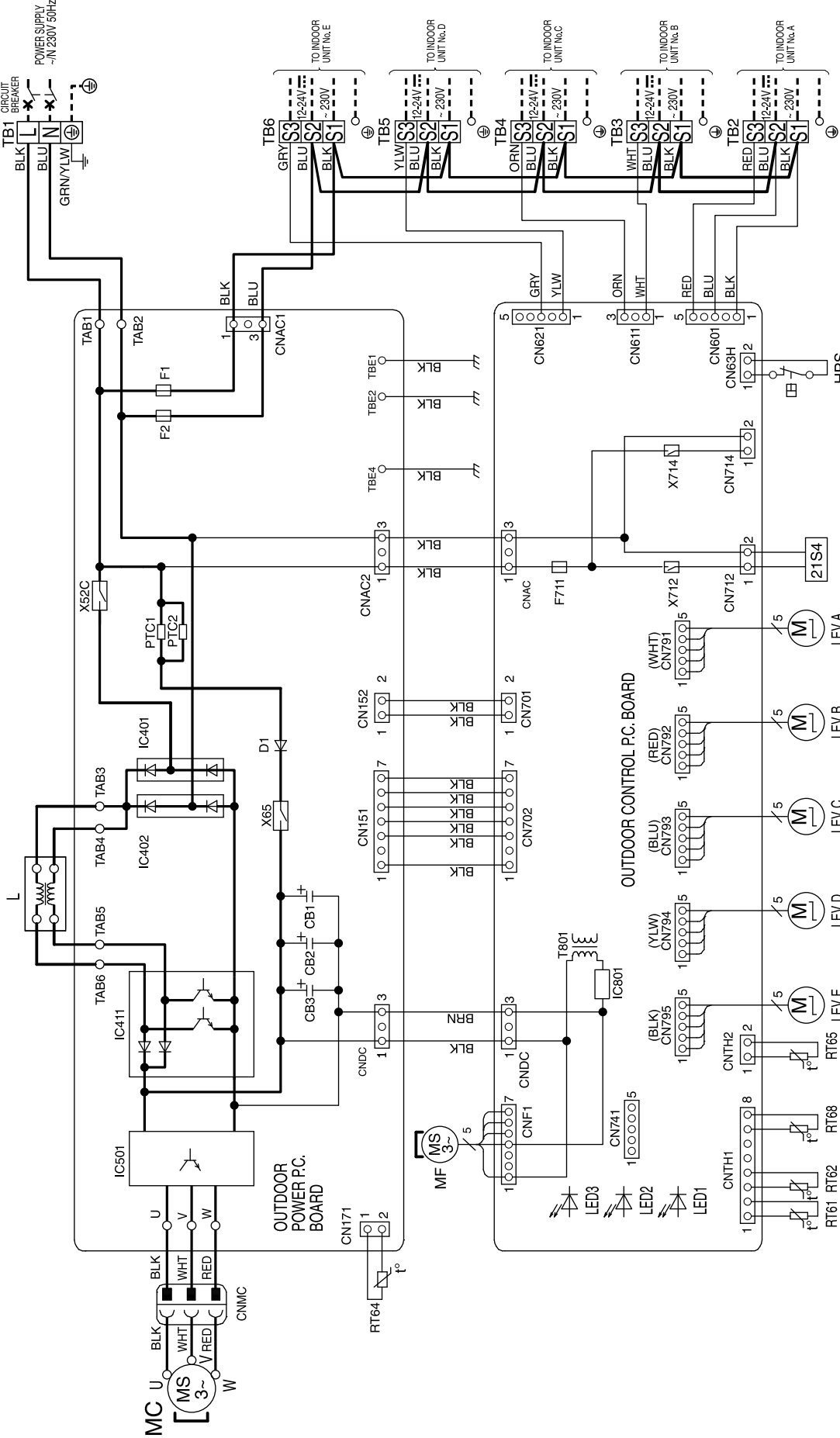

- NOTES:
- About the indoor side electric wiring refer to the indoor unit electric wiring diagram for servicing.
 - Use copper conductors only (For field wiring).
 - Symbols below indicate.
 - : Terminal block
 - : connector

SYMBOL	NAME	SYMBOL	NAME	SYMBOL	NAME	SYMBOL	NAME
CB1-3	SMOOTHING CAPACITOR	IC401, 402	DIODE BRIDGE	RT64	FIN TEMP. THERMISTOR	X712	RELAY
D1	DIODE	IC411	POWER FACTOR CONTROLLER	MC	AMBIENT TEMP. THERMISTOR	X714	RELAY
F1	FUSE (T6.3AL 250V)	IC501	POWER MODULE	MF	OUTDOOR HEAT EXCHANGER	T801	TRANSFORMER
F2	FUSE (T6.3AL 250V)	IC801	POWER DEVICE	PTC 1, 2	TEMPERATURE THERMISTOR	TB1-6	TERMINAL BLOCK
F711	FUSE (T3.15AL 250V)	L	REACTOR	RT61	DEFROST THERMISTOR	X52C	RELAY
HPS	HIGH PRESSURE SWITCH	LED 1-3	LED	RT62	DISCHARGE TEMP. THERMISTOR	X85	RELAY
						21S4	SOLENOID COIL

MXZ-5E102VA - ET1

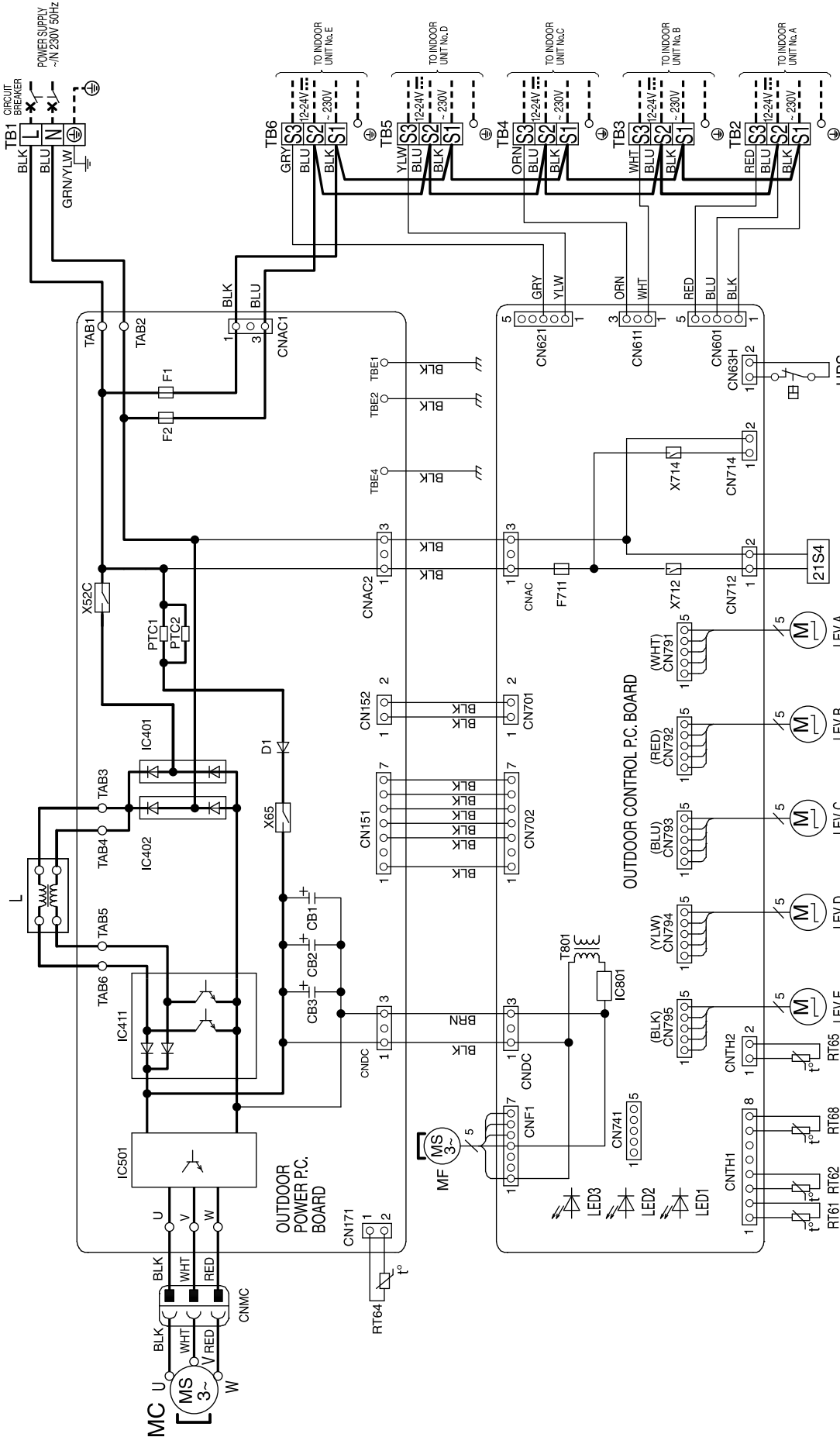

- NOTES:**
- About the indoor side electric wiring refer to the indoor unit electric wiring diagram for servicing.
 - Use copper conductors only (For field wiring).
 - Symbols below indicate.
 - : terminal block
 - : connector

SYMBOL	NAME	SYMBOL	NAME	SYMBOL	NAME	SYMBOL	NAME
CB1-3	SMOOTHING CAPACITOR	IC401, 402	DIODE BRIDGE	LEV A-E	EXPANSION VALVE	RT64	FIN TEMP. THERMISTOR
D1	DIODE	IC411	POWER FACTOR CONTROLLER	MC	COMPRESSOR	RT65	AMBIENT TEMP. THERMISTOR
F1	FUSE (T6.3AL 250V)	IC501	POWER MODULE	MF	FAN MOTOR	RT68	OUTDOOR HEAT EXCHANGER
F2	FUSE (T6.3AL 250V)	IC801	POWER DEVICE	PTC 1, 2	CIRCUIT PROTECTION	X52C	TEMPERATURE THERMISTOR
F711	FUSE (T3.15AL 250V)	L	REACTOR	RT61	DEFROST THERMISTOR	X65	DISCHARGE TEMP. THERMISTOR
HPS	HIGH PRESSURE SWITCH	LED 1-3	LED	RT62	DISCHARGE TEMP. THERMISTOR	RT66	RELAY
				RT68	RELAY	X712	RELAY
						X714	RELAY
						T801	TRANSFORMER
						TB1-6	TERMINAL BLOCK
						21S4	REVERSING VALVE SOLENOID COIL

MXZ-4E83VA

UNIT: mm

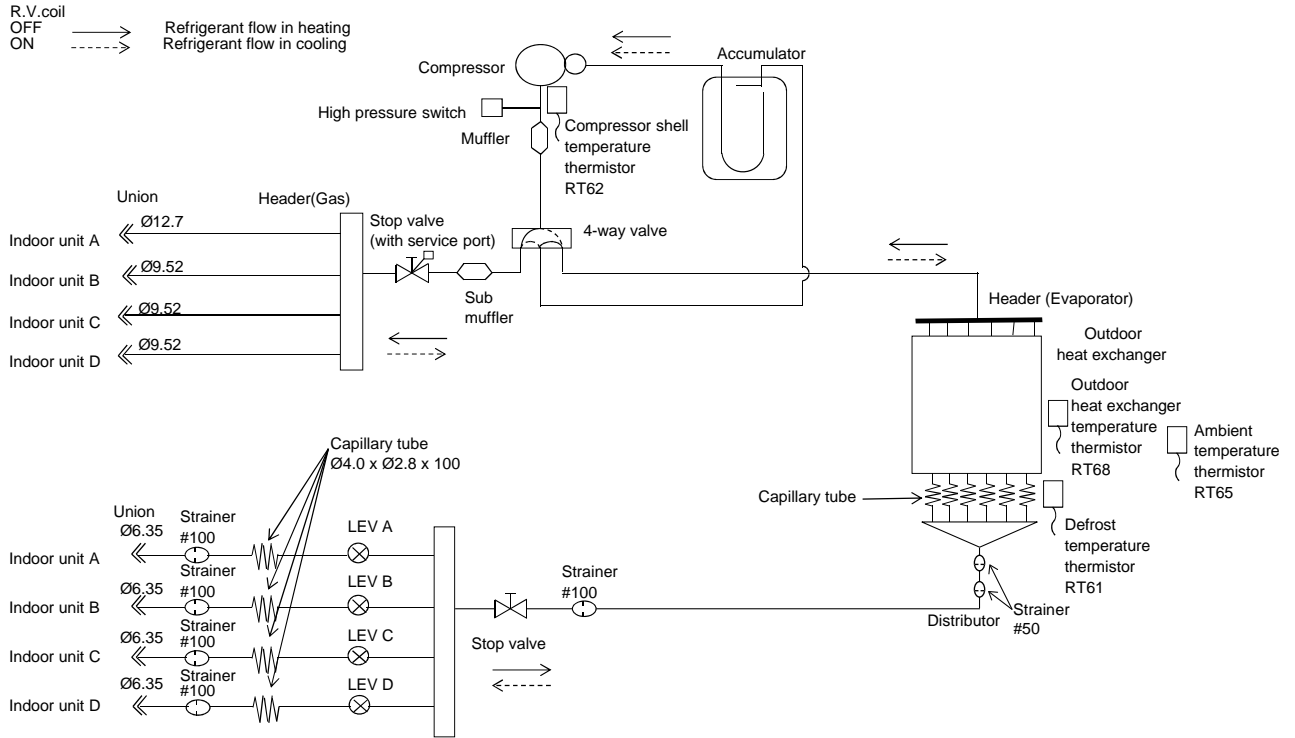

MAX REFRIGERANT PIPING LENGTH

Piping length each indoor unit (a, b, c, d)	25 m
Total piping length (a+b+c+d)	70 m
Bending point for each unit	25
Total bending point	70

*It is irrelevant which unit is higher.

ADDITIONAL REFRIGERANT CHARGE

Outdoor unit precharged (g)	Refrigerant piping length (one way, 4 unit total)			
	25 m	40 m	55 m	70 m
2,990	0	300	600	900

Calculation : $X_g = 20 \text{ g/m} \times (\text{Refrigerant piping length (m)} - 25)$

- Refrigerant pipe diameter is different according to indoor unit to be connected. When using extension pipes, refer to the tables below.
- When diameter of refrigerant pipe is different from that of outdoor unit union, use optional Different-diameter pipe. For further information on Different-diameter pipe, refer to "PARTS CATALOG".

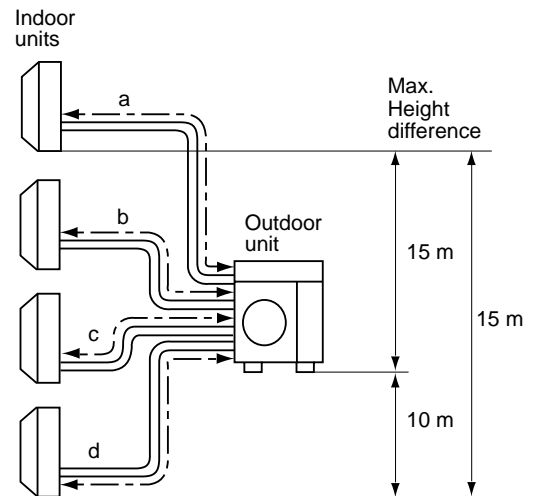

UNIT: mm (inch)

Outdoor unit union diameter		
For		
Indoor unit A	Liquid	6.35(1/4)
	Gas	12.7(1/2)
Indoor unit B	Liquid	6.35(1/4)
	Gas	9.52(3/8)
Indoor unit C	Liquid	6.35(1/4)
	Gas	9.52(3/8)
Indoor unit D	Liquid	6.35(1/4)
	Gas	9.52(3/8)

MXZ-5E102VA

UNIT: mm

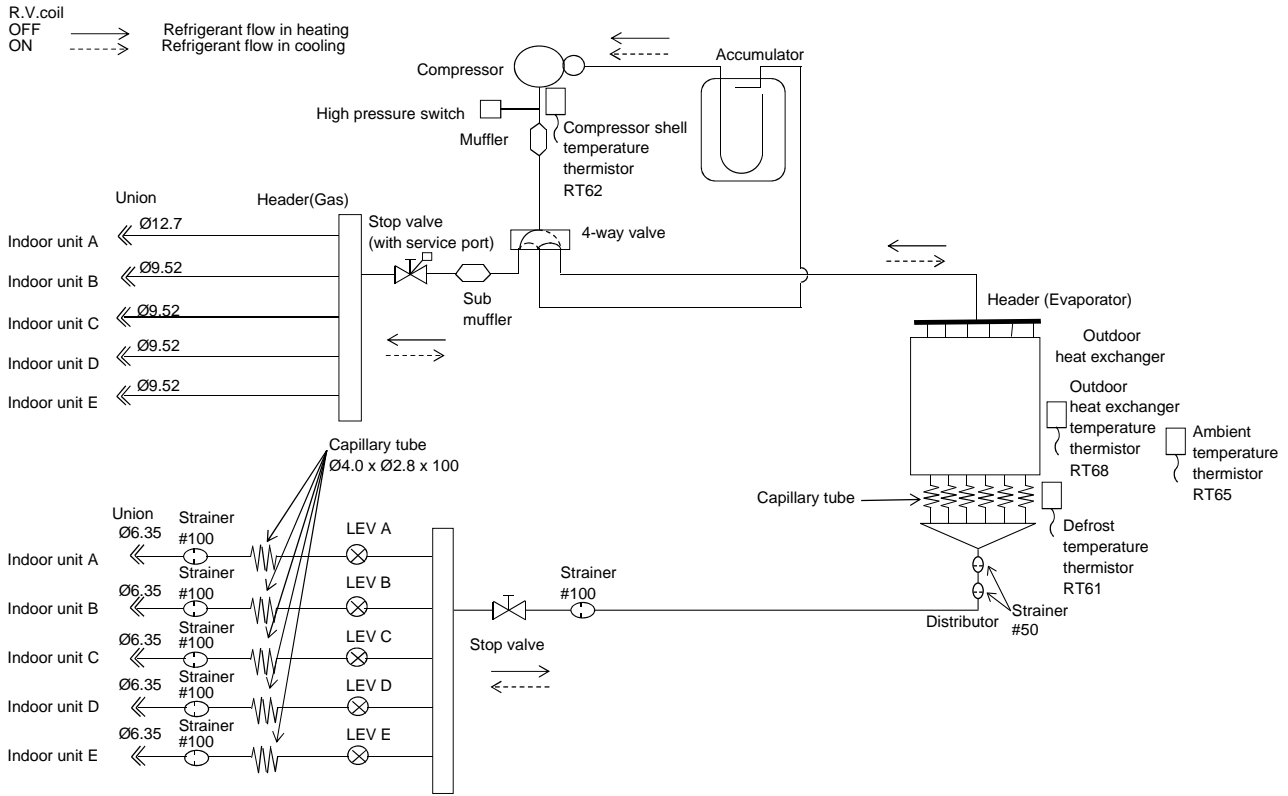

MAX REFRIGERANT PIPING LENGTH

Piping length each indoor unit (a, b, c, d, e)	25 m
Total piping length (a+b+c+d+e)	80 m
Bending point for each unit	25
Total bending point	80

*It is irrelevant which unit is higher.

ADDITIONAL REFRIGERANT CHARGE

Outdoor unit precharged (g)	Refrigerant piping length (one way, 5 unit total)				
	0 m	20 m	40 m	60 m	80 m
2,990	0	400	800	1,200	1,600

Calculation : $Xg = 20 \text{ g/m} \times (\text{Refrigerant piping length (m)} - 0)$

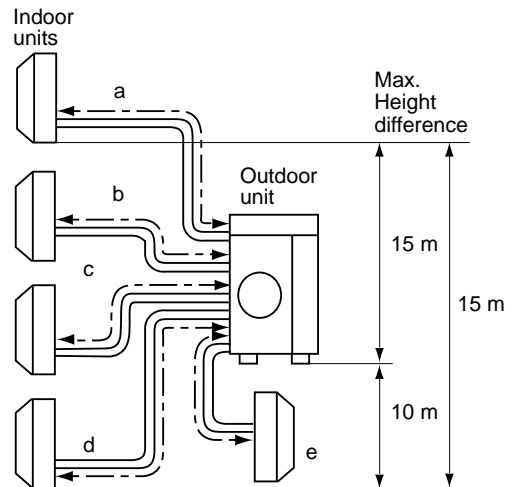

- Refrigerant pipe diameter is different according to indoor unit to be connected. When using extension pipes, refer to the tables below.
- When diameter of refrigerant pipe is different from that of outdoor unit union, use optional Different-diameter pipe. For further information on Different-diameter pipe, refer to "PARTS CATALOG".

UNIT: mm (inch)

Outdoor unit union diameter		
For		
Indoor unit A	Liquid	6.35(1/4)
	Gas	12.7(1/2)
Indoor unit B	Liquid	6.35(1/4)
	Gas	9.52(3/8)
Indoor unit C	Liquid	6.35(1/4)
	Gas	9.52(3/8)
Indoor unit D	Liquid	6.35(1/4)
	Gas	9.52(3/8)
Indoor unit E	Liquid	6.35(1/4)
	Gas	9.52(3/8)

PUMPING DOWN

When relocating or disposing of the air conditioner, pump down the system following the procedure below so that no refrigerant is released into the atmosphere.

- 1) Turn off the breaker.
- 2) Connect the gauge manifold valve to the service port of the stop valve on the gas pipe side of the outdoor unit.
- 3) Fully close the stop valve on the liquid pipe side of the outdoor unit.
- 4) Turn on the breaker.
- 5) Start the emergency COOL operation on all the indoor units.
- 6) When the pressure gauge shows 0.05 to 0 MPa [Gauge] (approximately 0.5 to 0 kgf/cm²), fully close the stop valve on the gas pipe side of the outdoor unit and stop the operation. (Refer to the indoor unit installation manual about the method for stopping the operation.)
 - * If too much refrigerant has been added to the air conditioner system, the pressure may not drop to 0.05 to 0 MPa [Gauge] (approximately 0.5 to 0 kgf/cm²), or the protection function may operate due to the pressure increase in the high-pressure refrigerant circuit. If this occurs, use a refrigerant collecting device to collect all of the refrigerant in the system, and then recharge the system with the correct amount of refrigerant after the indoor and outdoor units have been relocated.
- 7) Turn off the breaker. Remove the pressure gauge and the refrigerant piping.

WARNING

When pumping down the refrigerant, stop the compressor before disconnecting the refrigerant pipes. The compressor may burst and cause injury if any foreign substance, such as air, enters the pipes.

MXZ-4E83VA MXZ-5E102VA

The standard specifications apply only to the operation of the air conditioner under normal conditions.

Since operating conditions vary according to the areas where these units are installed, the following information has been provided to clarify the operating characteristics of the air conditioner under the conditions indicated by the performance curve.

(1) GUARANTEED VOLTAGE

198 - 264 V 50 Hz

(2) AIR FLOW

Air flow should be set at MAX.

(3) MAIN READINGS

(1) Indoor intake air wet-bulb temperature:	°CWB	} Cooling
(2) Indoor outlet air wet-bulb temperature:	°CWB	
(3) Outdoor intake air dry-bulb temperature:	°CDB	
(4) Total input:	W	} Heating
(5) Indoor intake air dry-bulb temperature:	°CDB	
(6) Outdoor intake air wet-bulb temperature:	°CWB	
(7) Total input:	W	

Indoor air wet and dry bulb temperature difference on the left side of the following chart shows the difference between the indoor intake air wet and dry bulb temperature and the indoor outlet air wet and dry bulb temperature for your reference at service.

How to measure the indoor air wet and dry bulb temperature difference

1. Attach at least 2 sets of wet and dry bulb thermometers to the indoor air intake as shown in the figure, and at least 2 sets of wet and dry bulb thermometers to the indoor air outlet. The thermometers must be attached to the position where air speed is high.
2. Attach at least 2 sets of wet and dry bulb thermometers to the outdoor air intake. Cover the thermometers to prevent direct rays of the sun.
3. Check that the air filter is cleaned.
4. Open windows and doors of room.
5. Press the EMERGENCY OPERATION switch once (twice) to start the EMERGENCY COOL (HEAT) MODE.
6. When system stabilizes after more than 15 minutes, measure temperature and take an average temperature.
7. 10 minutes later, measure temperature again and check that the temperature does not change.

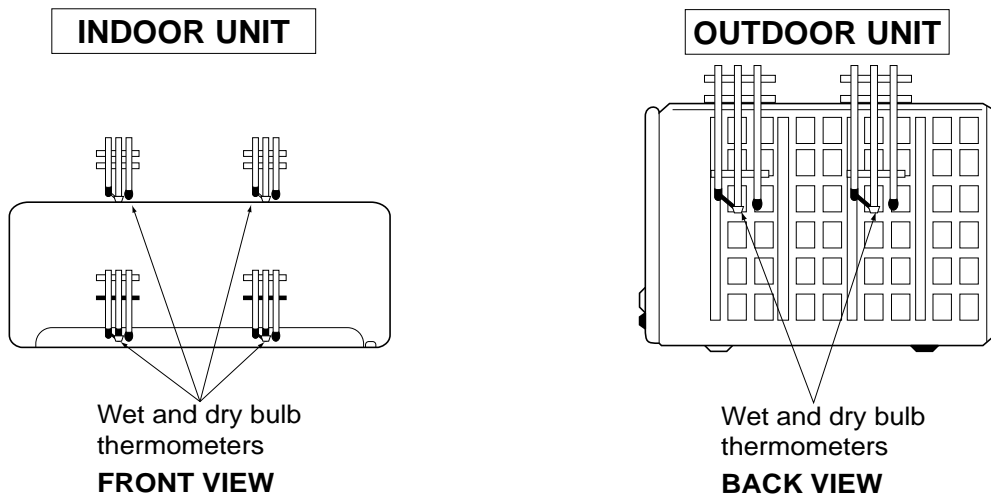

8-1. CAPACITY AND THE INPUT CURVES MXZ-4E83VA MXZ-5E102VA

5.8	4.1	7.4	5.2	6.0	8.8	11.2	12.8	8.8	9.0
5.4	3.8	6.8	4.8	5.5	8.0	10.2	11.6	8.0	8.2
4.9	3.5	6.2	4.4	5.0	7.3	9.3	10.6	7.3	7.5
4.5	3.2	5.7	4.0	4.6	6.6	8.4	9.5	6.6	6.8
4.0	2.9	5.1	3.6	4.1	6.0	7.5	8.5	6.0	6.1
3.6	2.6	4.5	3.2	3.7	5.3	6.6	7.5	5.3	5.4
15 class	18 class	20 class	22 class	25 class	35 class	42 class	50 class	60 class	71 class

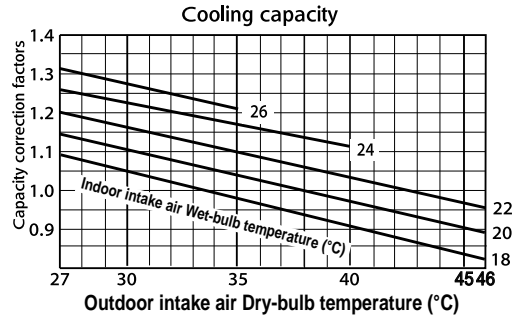

5.8	4.1	7.4	5.2	6.0	8.8	11.2	12.8	8.8	9.0
5.4	3.8	6.8	4.8	5.5	8.0	10.2	11.6	8.0	8.2
4.9	3.5	6.2	4.4	5.0	7.3	9.3	10.6	7.3	7.5
4.5	3.2	5.7	4.0	4.6	6.6	8.4	9.5	6.6	6.8
4.0	2.9	5.1	3.6	4.1	6.0	7.5	8.5	6.0	6.1
3.6	2.6	4.5	3.2	3.7	5.3	6.6	7.5	5.3	5.4
15 class	18 class	20 class	22 class	25 class	35 class	42 class	50 class	60 class	71 class

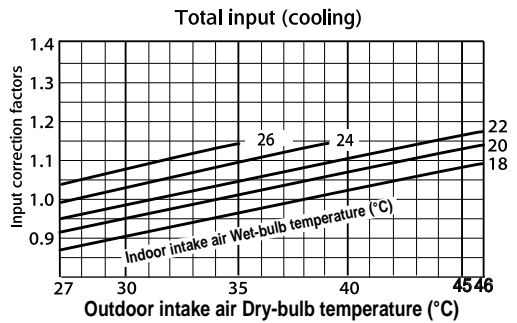

17.0	18.2	20.5	18.2	18.2	21.4	28.9	29.8	20.7	26.3
15.7	16.8	18.9	16.8	16.8	19.7	26.6	27.5	19.1	24.3
14.4	15.4	17.3	15.4	15.4	18.1	24.4	25.2	17.5	22.3
12.9	13.9	15.6	13.9	13.9	16.3	21.9	22.7	15.7	20.0
11.6	12.5	14.0	12.5	12.5	14.6	19.7	20.4	14.2	18.0
10.3	11.1	12.4	11.1	11.1	13.0	17.6	18.1	12.6	16.0
9.0	9.7	11.0	9.7	9.7	11.5	15.7	16.2	11.1	14.2
7.7	8.2	9.2	8.2	8.2	9.6	13.0	13.4	9.3	11.9
15 class	18 class	20 class	22 class	25 class	35 class	42 class	50 class	60 class	71 class

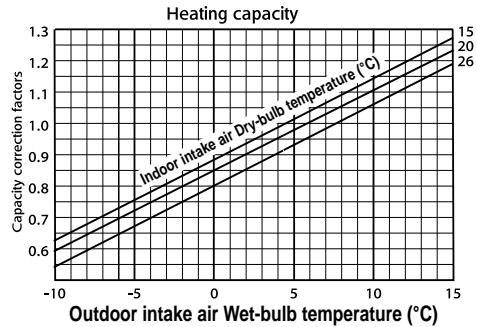

17.0	18.2	20.5	18.2	18.2	21.4	28.9	29.8	20.7	26.3
15.7	16.8	18.9	16.8	16.8	19.7	26.6	27.5	19.1	24.3
14.4	15.4	17.3	15.4	15.4	18.1	24.4	25.2	17.5	22.3
12.9	13.9	15.6	13.9	13.9	16.3	21.9	22.7	15.7	20.0
11.6	12.5	14.0	12.5	12.5	14.6	19.7	20.4	14.2	18.0
10.3	11.1	12.4	11.1	11.1	13.0	17.6	18.1	12.6	16.0
9.0	9.7	11.0	9.7	9.7	11.5	15.7	16.2	11.1	14.2
7.7	8.2	9.2	8.2	8.2	9.6	13.0	13.4	9.3	11.9
15 class	18 class	20 class	22 class	25 class	35 class	42 class	50 class	60 class	71 class

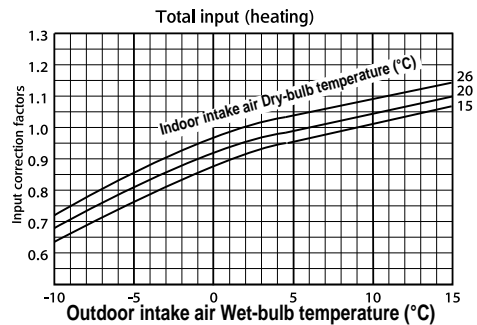

8-2. CAPACITY AND INPUT CORRECTION BY INVERTER OUTPUT FREQUENCY (single operation) MXZ-4E83VA

15-class unit

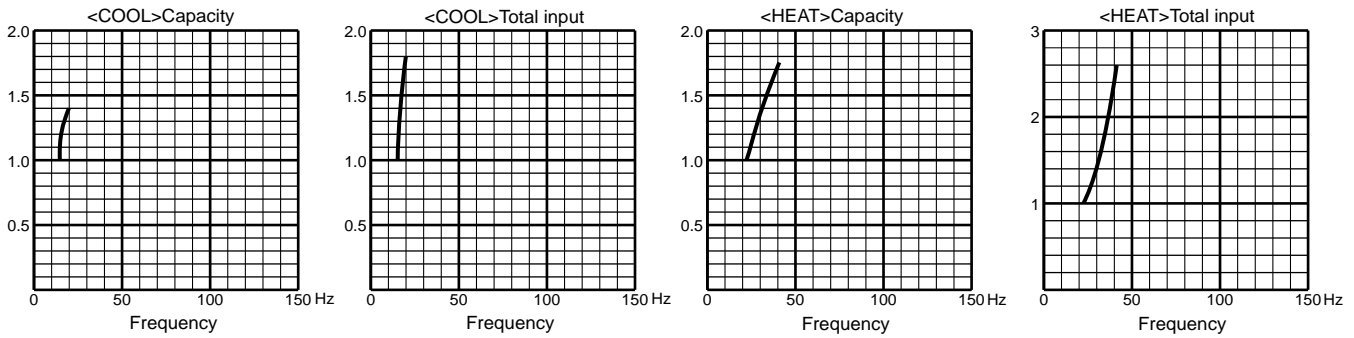

18-class unit

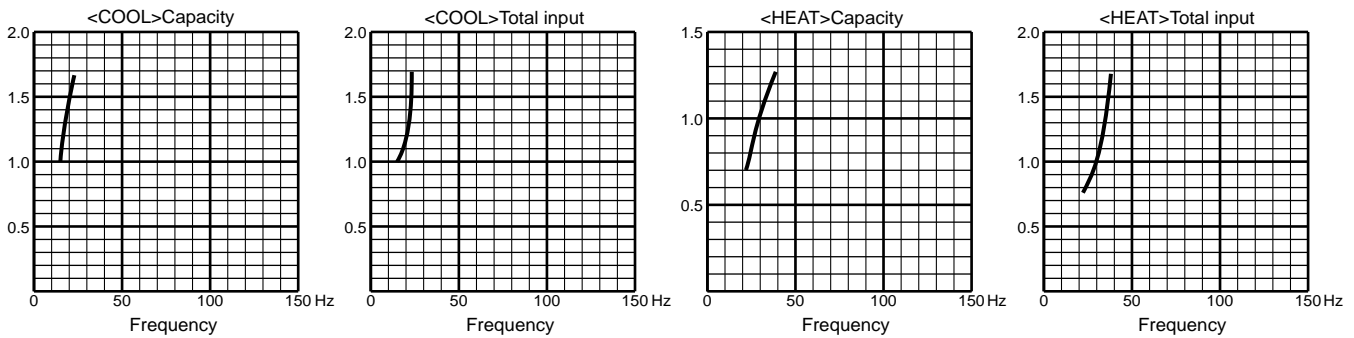

20-class unit

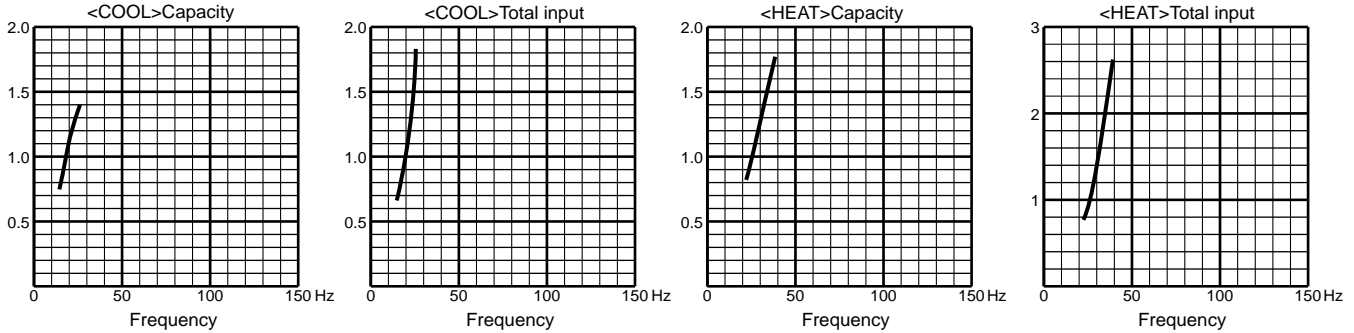

22-class unit

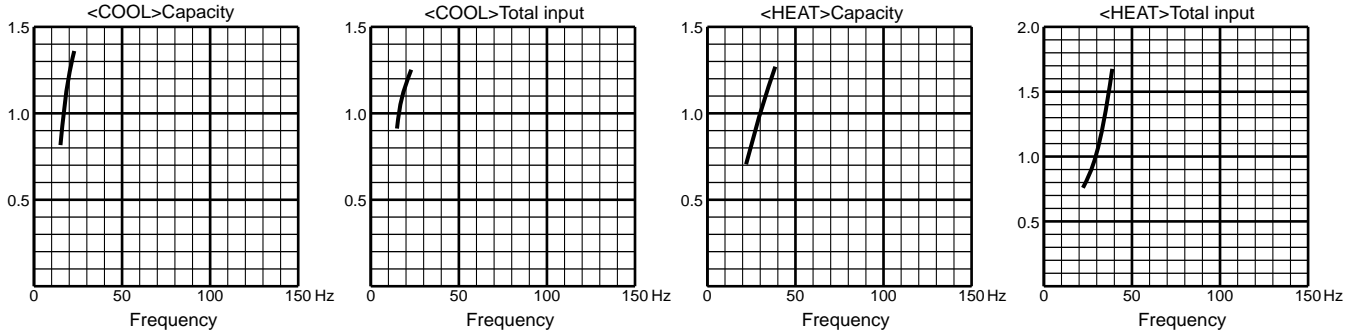

25-class unit

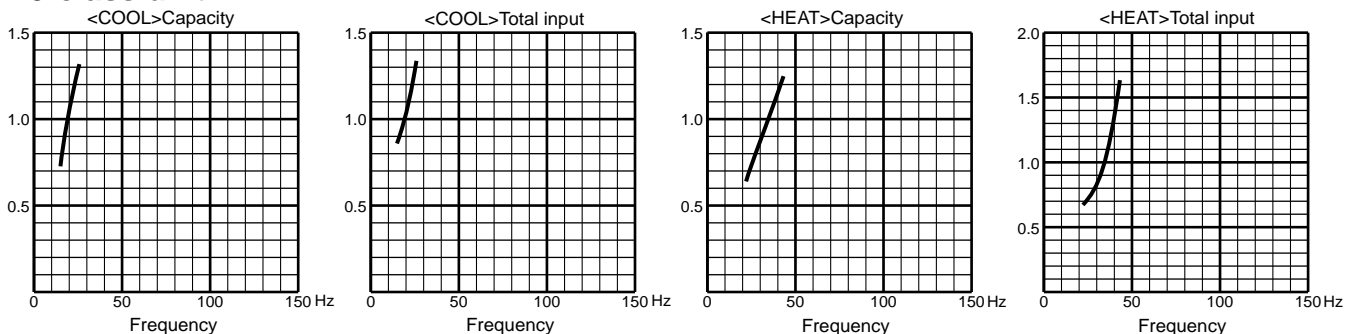



MXZ-4E83VA

35-class unit

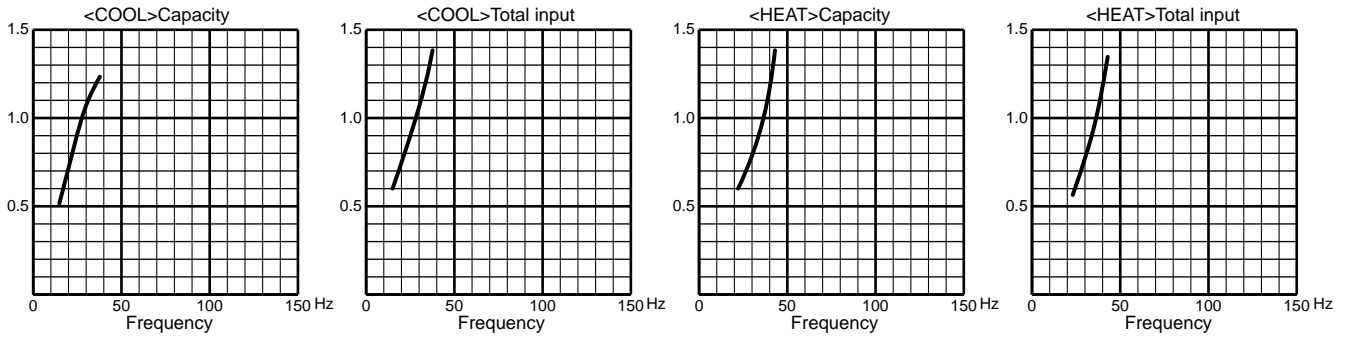

42-class unit

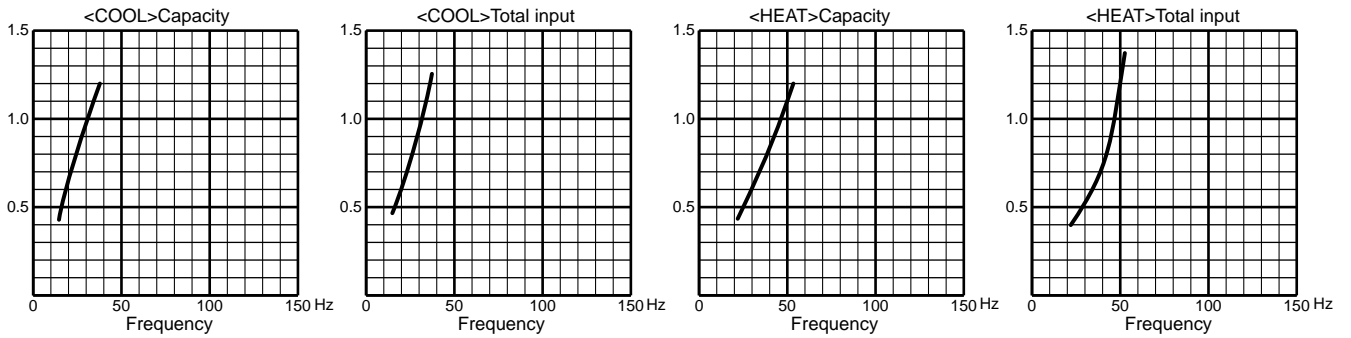

50-class unit

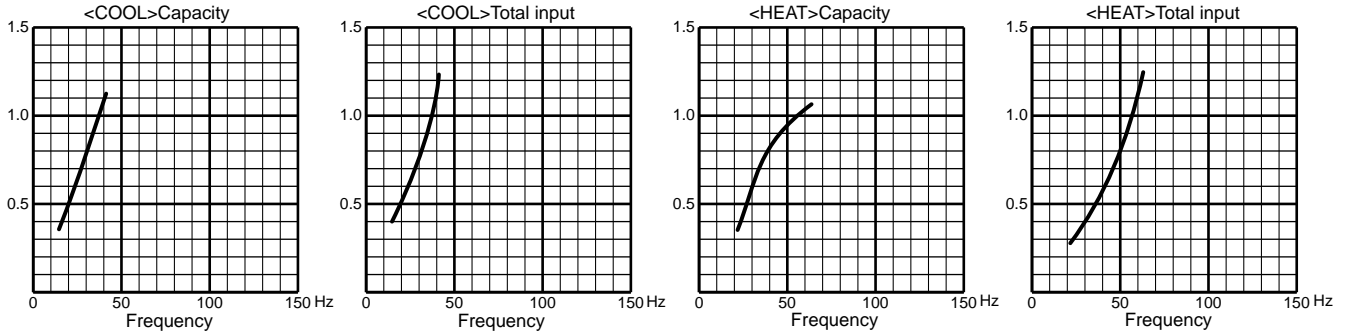

60-class unit

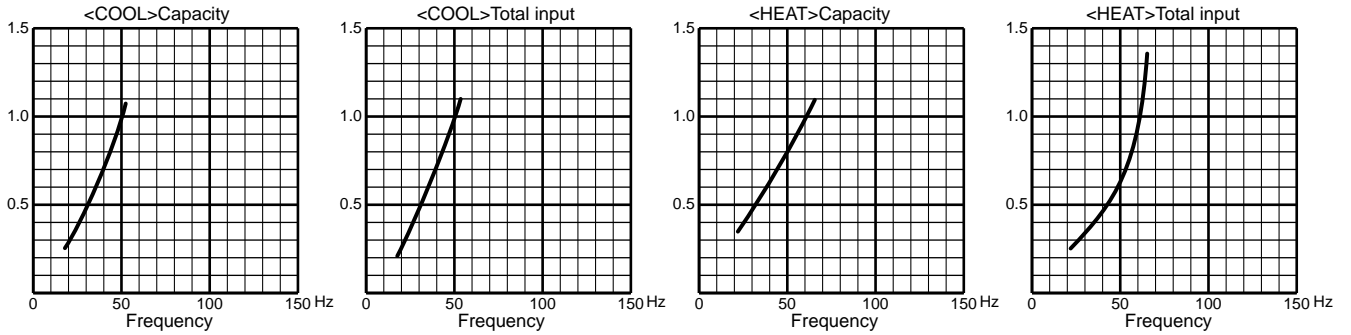

71-class unit

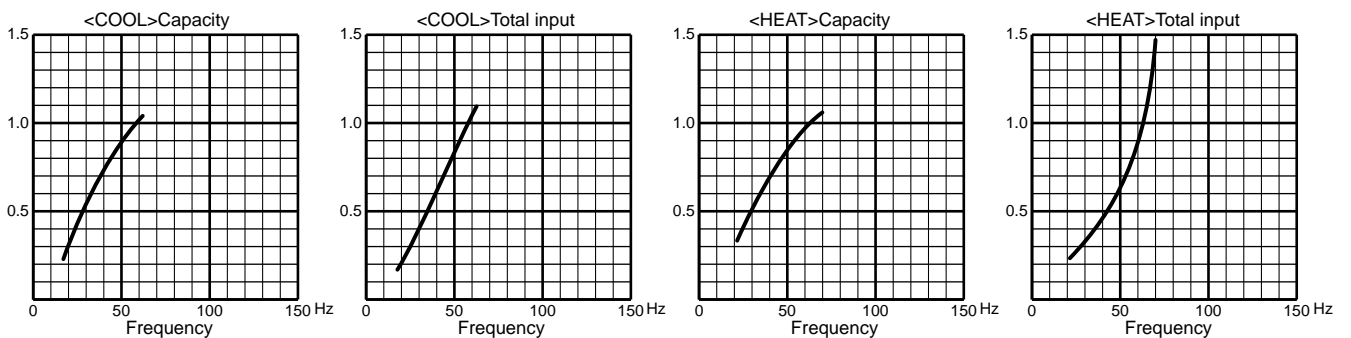

MXZ-5E102VA

35-class unit

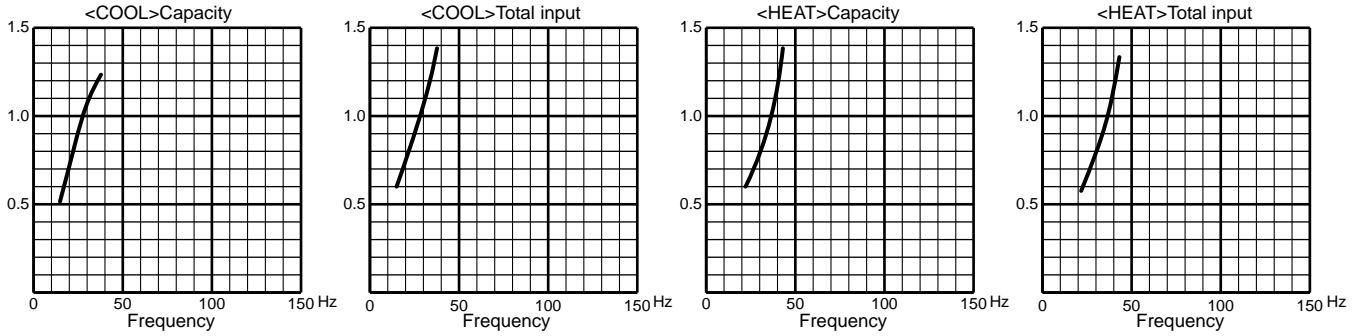

42-class unit

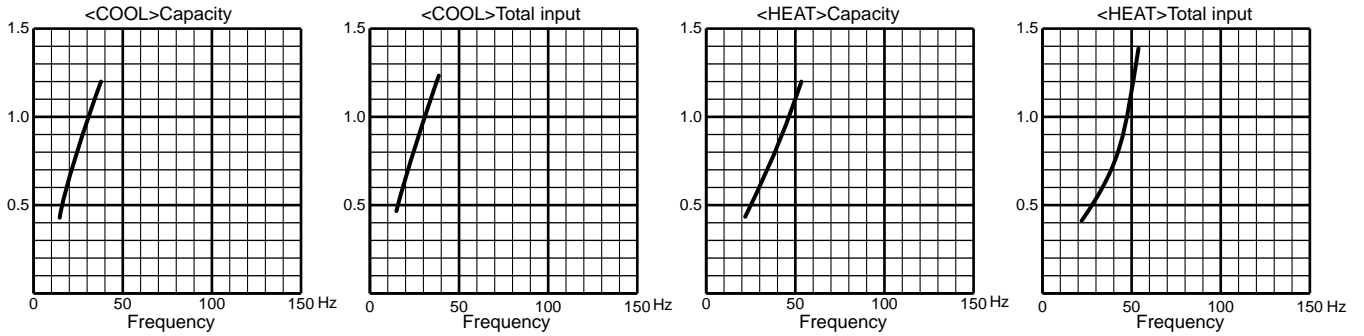

50-class unit

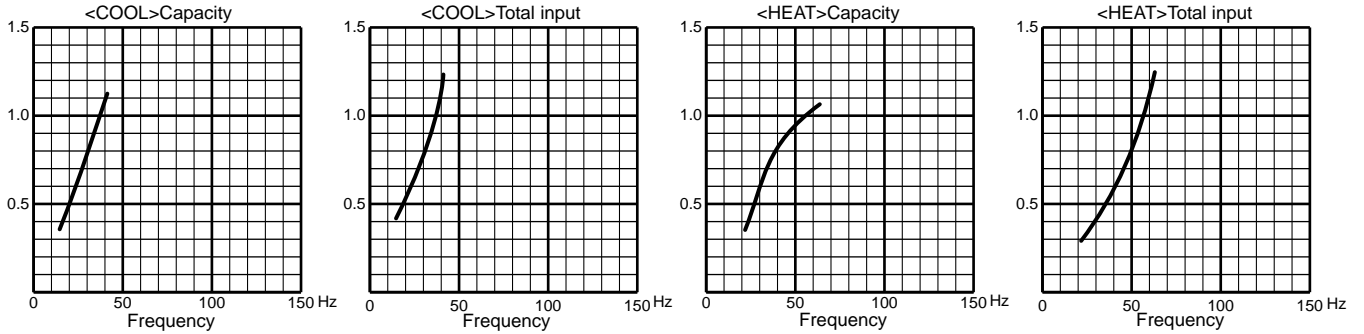

60-class unit

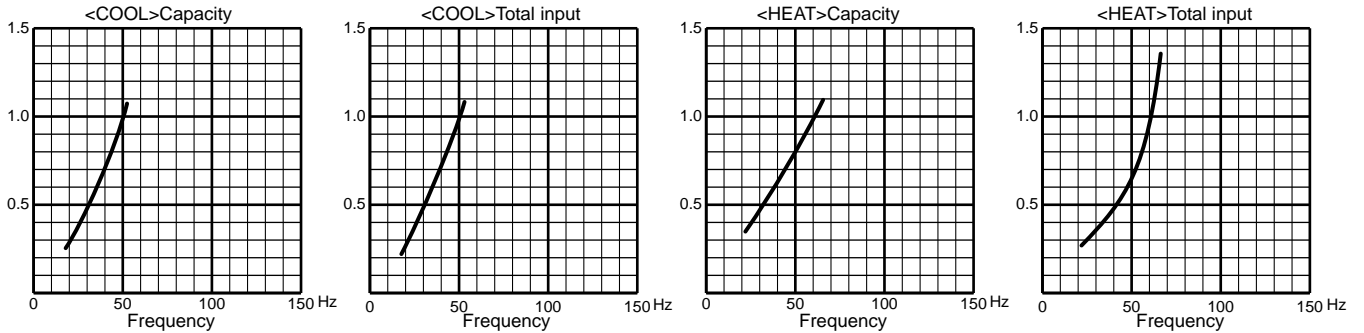

71-class unit

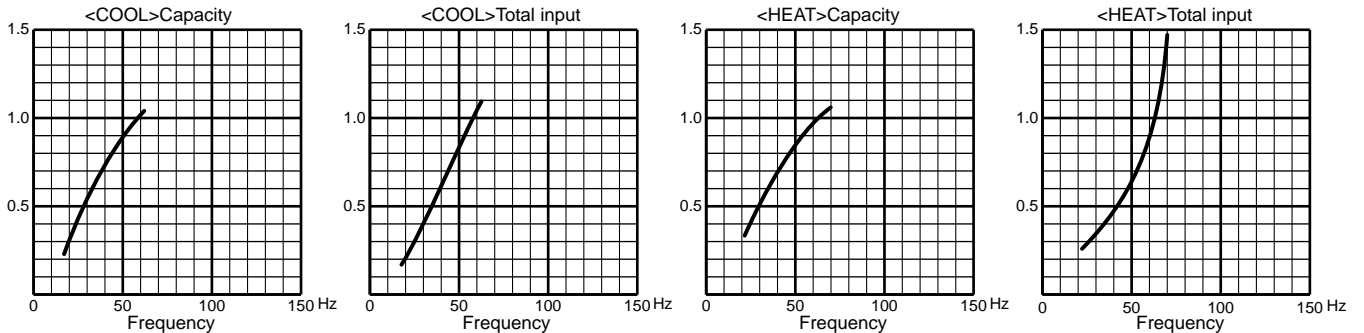

8-3. HOW TO OPERATE FIXED-FREQUENCY OPERATION <Test run operation>

1. Press EMERGENCY OPERATION switch to start COOL or HEAT mode (COOL: Press once, HEAT: Press twice).
2. Test run operation starts and continues to operate for 30 minutes.
3. Compressor operates at rated frequency.
4. Indoor fan operates at High speed.
5. After 30 minutes, test run operation finishes and EMERGENCY OPERATION starts (Operation frequency of compressor varies).
6. To cancel test run operation or EMERGENCY OPERATION, press EMERGENCY OPERATION switch or any button on remote controller.

8-4. OUTDOOR LOW PRESSURE AND OUTDOOR UNIT CURRENT CURVE (single operation)

NOTE: The unit of pressure has been changed to MPa on the international system of units (SI unit system).
The conversion factor is: **1 (MPa [Gauge]) = 10.2 (kgf/cm² [Gauge])**

(1) COOL operation

- ① Both indoor and outdoor units are under the same temperature/humidity condition.
- ② Operation: TEST RUN OPERATION (Refer to 8-3.)

Dry-bulb temperature (°C)	Relative humidity (%)
20	50
25	60
30	70

MXZ-4E83VA

15-class unit

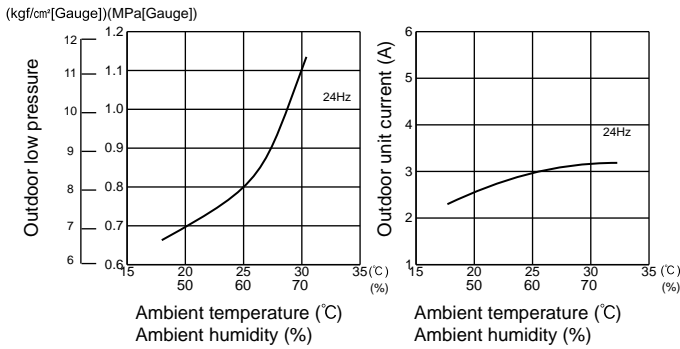

18-class unit

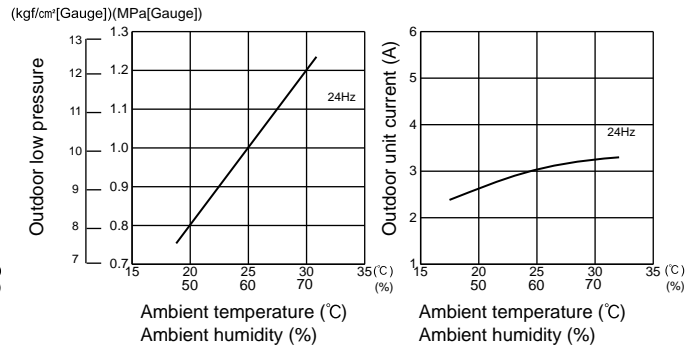

20-class unit

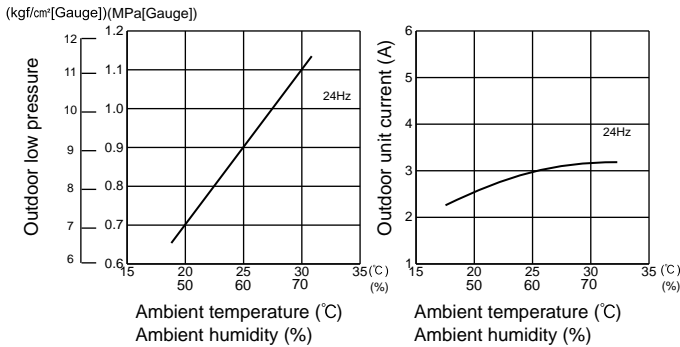

22-class unit

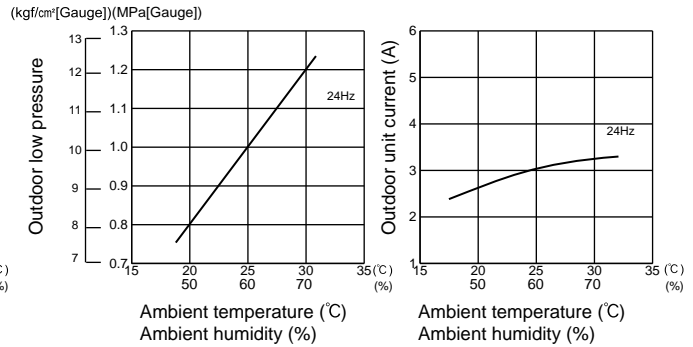

25-class unit

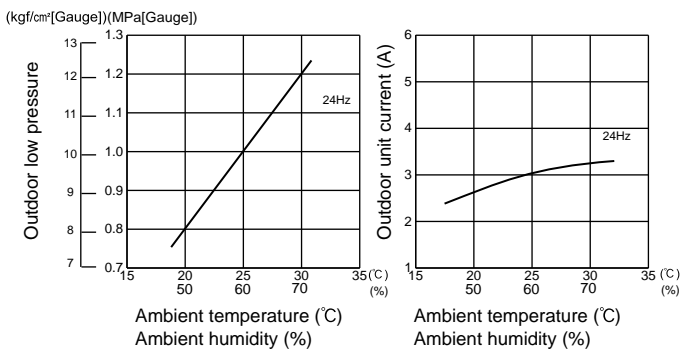

35-class unit

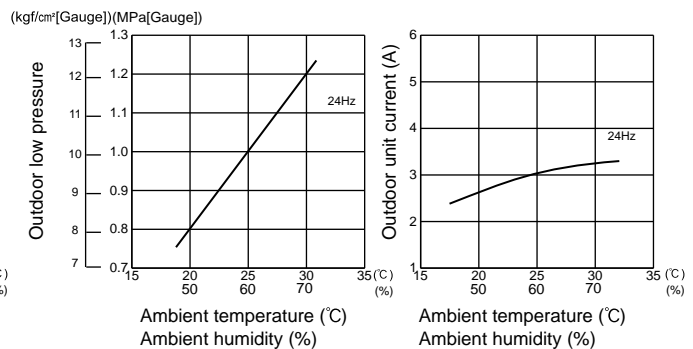

MXZ-4E83VA
42-class unit

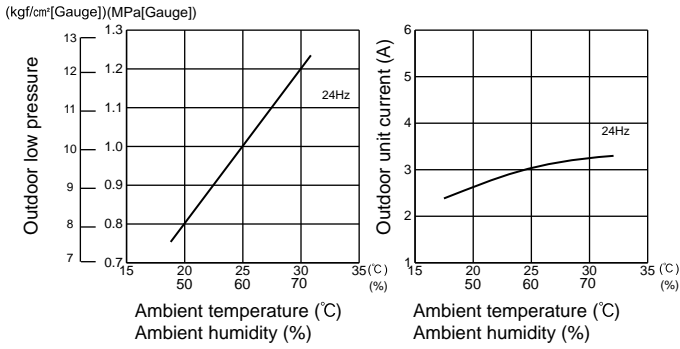

50-class unit

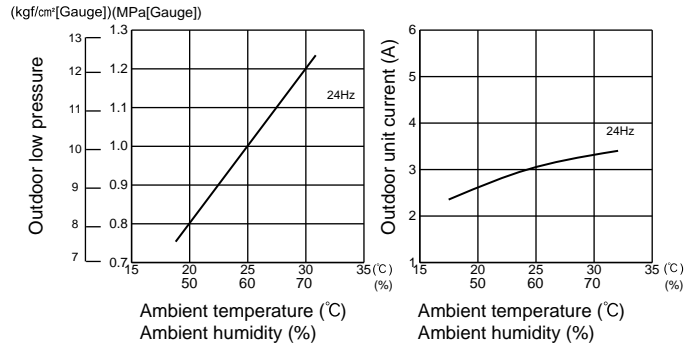

60-class unit

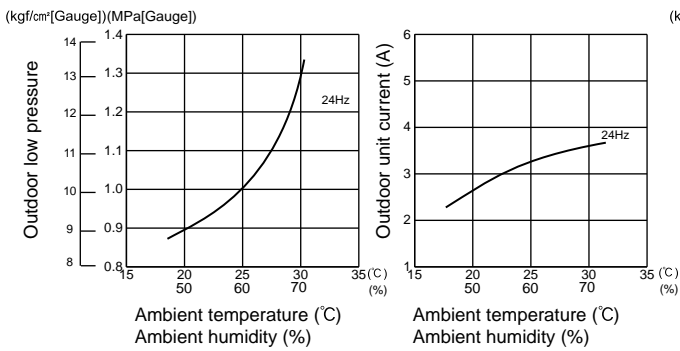

71-class unit

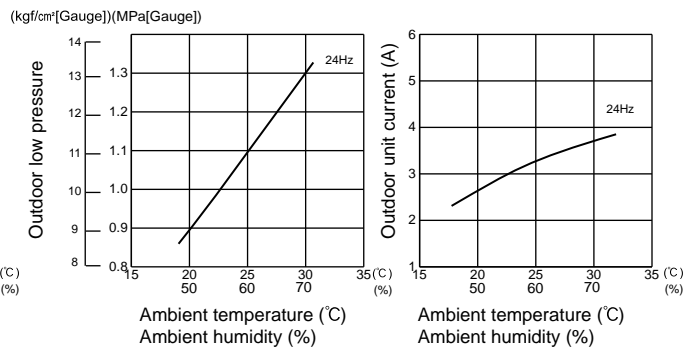

MXZ-5E102VA

15-class unit

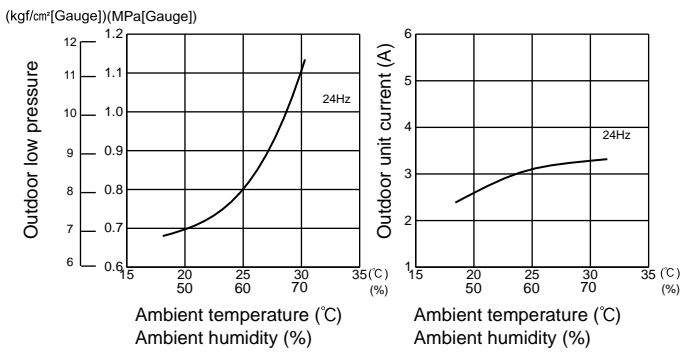

18-class unit

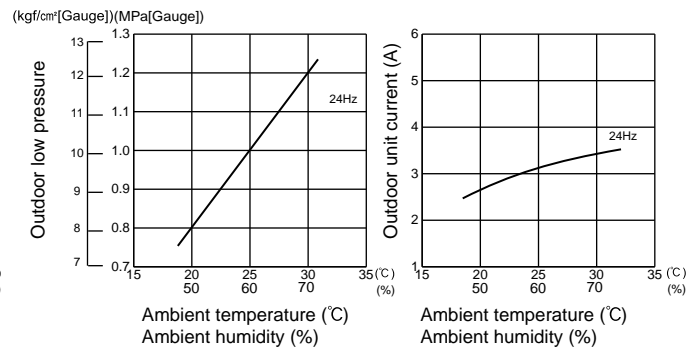

20-class unit

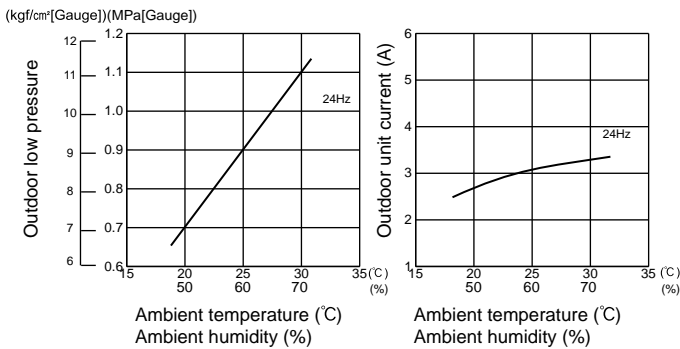

22-class unit

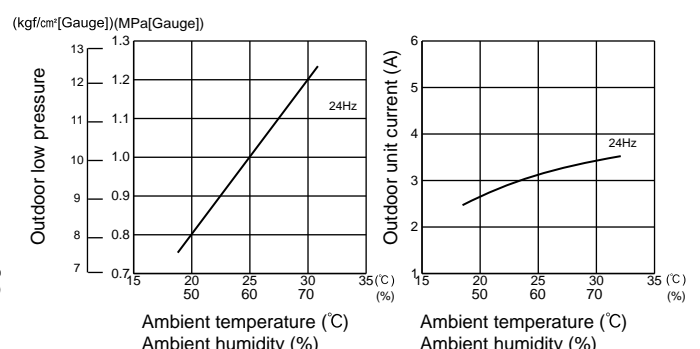

MXZ-5E102VA

25-class unit

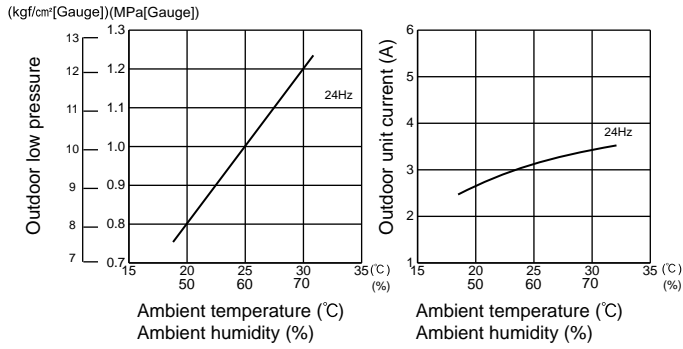

35-class unit

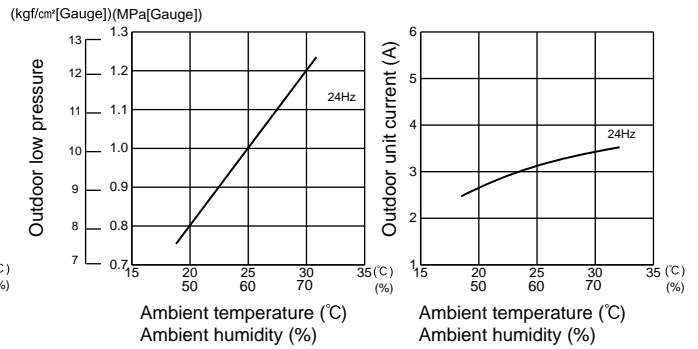

42-class unit

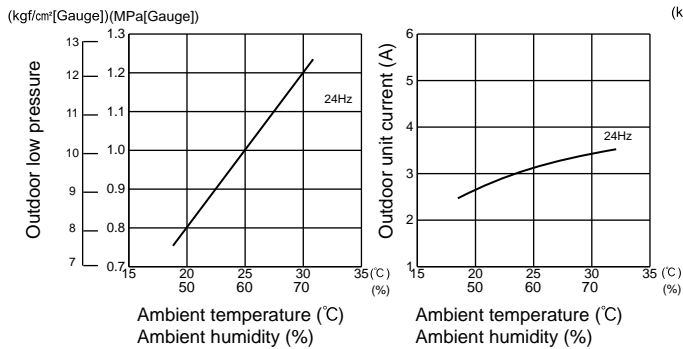

50-class unit

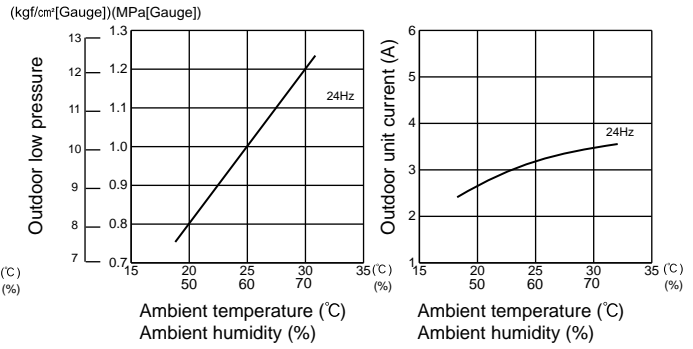

60-class unit

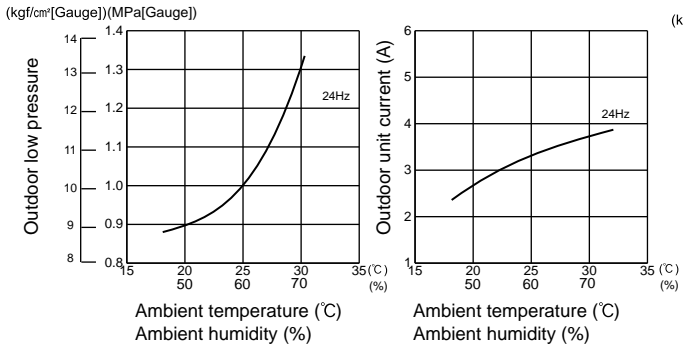

71-class unit

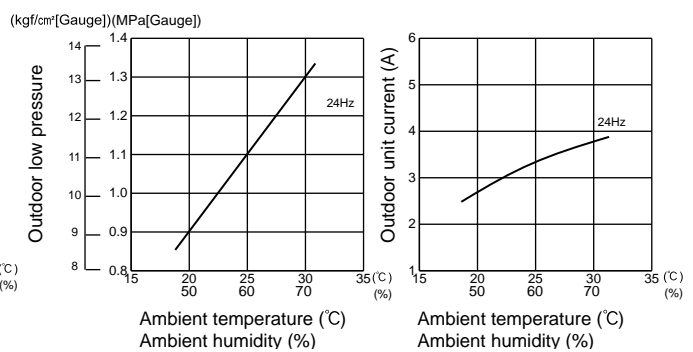

(2) HEAT operation

① Condition:

	Indoor	Outdoor			
Dry bulb temperature (°C)	20.0	2	7	15	20.0
Wet bulb temperature (°C)	14.5	1	6	12	14.5

② Operation: TEST RUN OPERATION (Refer to 8-3.)

MXZ-4E83VA

15-class unit

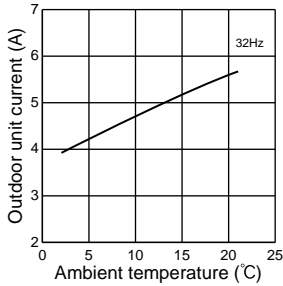

18-class unit

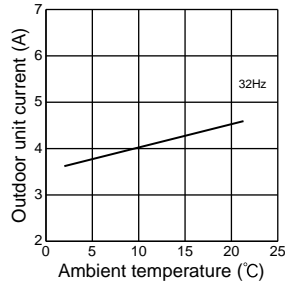

20-class unit

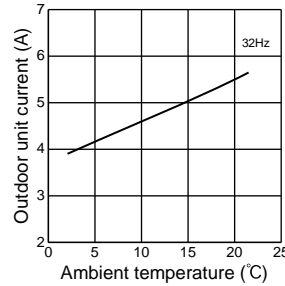

22-class unit

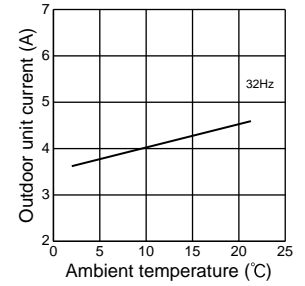

25-class unit

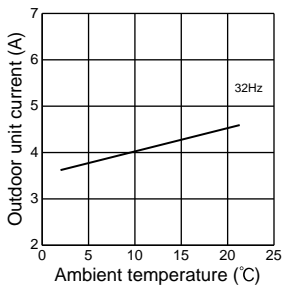

35-class unit

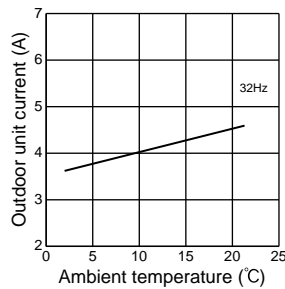

42-class unit

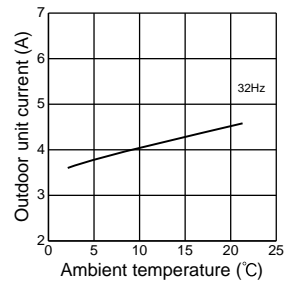

50-class unit

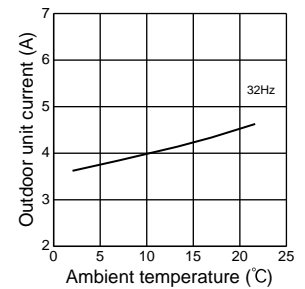

MXZ-5E102VA

60-class unit

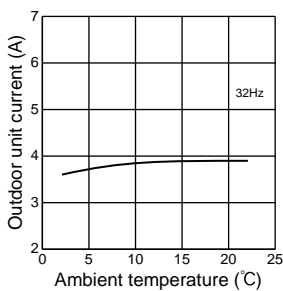

71-class unit

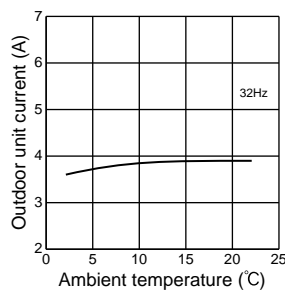

15-class unit

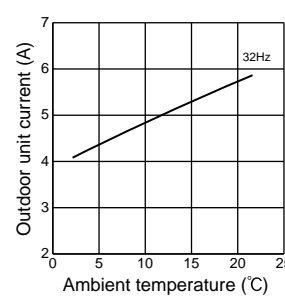

18-class unit

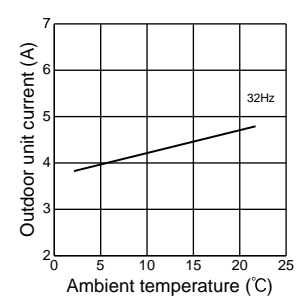

20-class unit

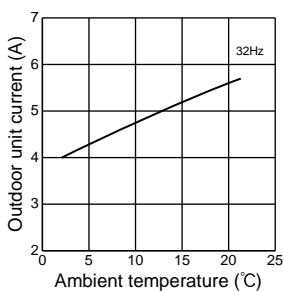

22-class unit

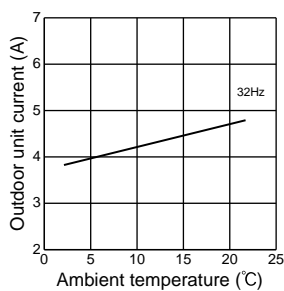

25-class unit

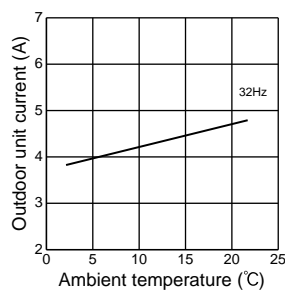

35-class unit

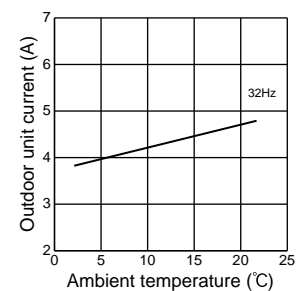

MXZ-5E102VA

42-class unit

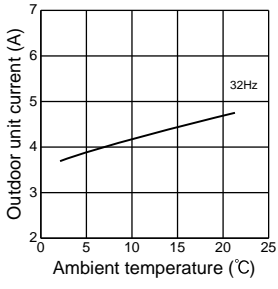

50-class unit

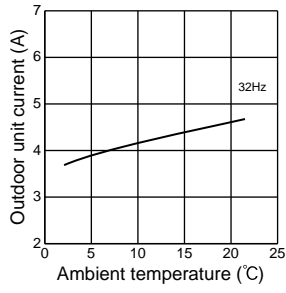

60-class unit

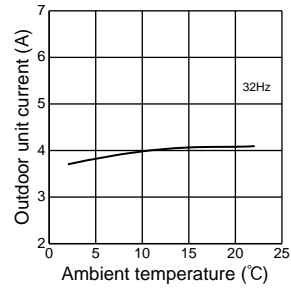

71-class unit

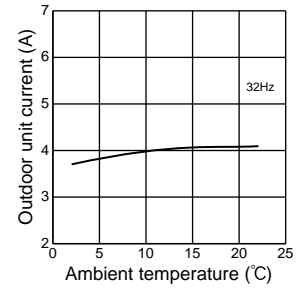

MXZ-4E83VA MXZ-5E102VA

Relation between main sensor and actuator

Sensor	Purpose	Actuator			
		Compressor	LEV	Outdoor fan motor	4-way valve
Discharge temperature thermistor	Protection	○	○		
Indoor coil temperature thermistor	Cooling: Coil frost prevention	○			
	Heating: High pressure protection	○	○		
Defrost thermistor	Heating: Defrosting	○	○	○	○
Fin temperature thermistor	Protection	○		○	
Ambient temperature thermistor	Control/Protection	○	○	○	
Outdoor heat exchanger temperature thermistor	Cooling: Control/Protection	○	○	○	
Capacity code	Control	○	○		

MXZ-4E83VA MXZ-5E102VA

10-1. PRE-HEAT CONTROL

If moisture gets into the refrigerant cycle, or when refrigerant is liquefied and collected in the compressor, it may interfere the start-up of the compressor.

To improve start-up condition, the compressor is energized even while it is not operating.

This is to generate heat at the winding.

The compressor uses about 50 W when pre-heat control is turned ON.

Pre-heat control is ON at initial setting.

[How to deactivate pre-heat control]

- ① Turn OFF the power supply for the air conditioner before making the setting.
- ② Set the "4" of SW2 on the outdoor control P.C. board to ON to deactivate pre-heat control function.

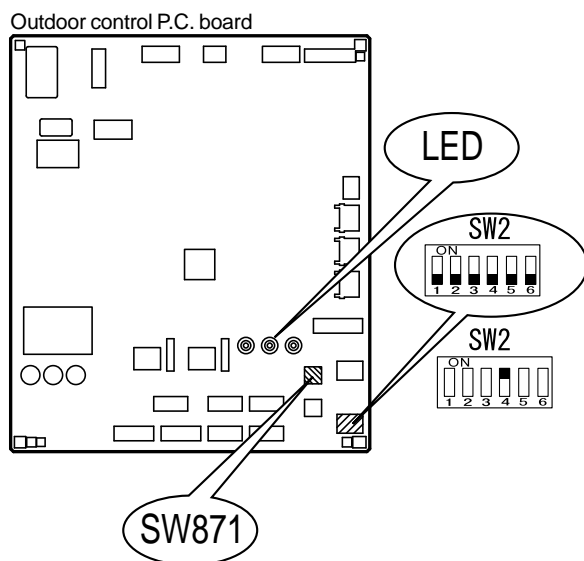

- ③ Turn ON the power supply for the air conditioner.

NOTE: Pre-heat control will be turned OFF when the breaker is turned OFF.

10-2. AUTO LINE CORRECTING

Outdoor unit has an auto line correcting function which automatically detects and corrects improper wiring or piping.

Improper wiring or piping can be automatically detected by pressing the piping/wiring correction switch (SW871). When improper wiring or piping is detected, wiring lines are corrected. This will be completed in about 10 to 20 minutes.

[How to activate this function]

1. Check that outside temperature is above 0°C.
(This function does not work when outside temperature is not above 0°C.)
2. Check that the stop valves of the liquid pipe and gas pipe are open.
3. Check that the wiring between indoor and outdoor unit is correct.
(If the wiring is not correct, this function does not work.)
4. Turn ON the power supply and wait at least 1 minute.
5. Press the piping/wiring correction switch (SW871) on the outdoor control P.C. board.
Do not touch energized parts.

LED indication during detection:

LED1 (Red)	LED2 (Yellow)	LED3 (Green)
Lighted	Lighted	Once

LED indication after detection:

LED1 (Red)	LED2 (Yellow)	LED3 (Green)	Indication
Lighted	Not lighted	Lighted	Completed (Problem corrected/ normal)
Once	Once	Once	Not completed (Detection failed)
Other indications			Refer to "SAFETY PRECAUTIONS WHEN LED FLASHES" located behind the service panel.

* Make sure that the valves are open and the pipes are not collapsed or clogged.

6. Press the switch to cancel.

LED indication after cancel :

LED1 (Red)	LED2 (Yellow)	LED3 (Green)
Lighted	Lighted	Not lighted

NOTE: Indoor unit cannot be operated while this function is activated.
When this function is activated while indoor unit is operating, the operation will be stopped.
Operate indoor unit after the auto line correcting is finished.
Pressing the switch during detection cancels this function.

The record of auto line correcting can be confirmed in the following way:

Press the switch for more than 5 seconds.

LED will show the record of auto correcting for about 30 seconds as shown in the table below:

Number of blinks			Wiring line
LED1 (Red)	LED2 (Yellow)	LED3 (Green)	
Once	Once	Lighted	Not corrected
3 times	3 times	Lighted	Corrected

NOTE: Activate this function to confirm the correct wiring after replacing the outdoor control P.C. board.
(Previous records are deleted when the outdoor control P.C. board is replaced.)
The record cannot be shown if auto line correcting is not canceled (Refer to "How to activate this function").

MXZ-4E83VA MXZ-5E102VA**11-1. CAUTIONS ON TROUBLESHOOTING****1. Before troubleshooting, check the following:**

- 1) Check the power supply voltage.
- 2) Check the indoor/outdoor connecting wire for miswiring.

2. Take care of the following during servicing

- 1) Before servicing the air conditioner, be sure to turn OFF the unit first with the remote controller, and after confirming the horizontal vane is closed, turn OFF the breaker and/or disconnect the power plug.
- 2) Be sure to turn OFF the power supply before removing the front panel, the cabinet, the top panel, and the P.C. board.
- 3) When removing the electrical parts, be careful of the residual voltage of smoothing capacitor.
- 4) When removing the P.C. board, hold the edge of the board with care NOT to apply stress on the components.
- 5) When connecting or disconnecting the connectors, hold the connector housing. DO NOT pull the lead wires.

<Incorrect>

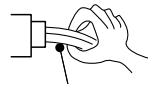
**Lead wiring**

<Correct>

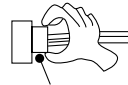
**Connector housing****3. Troubleshooting procedure**

- 1) Check if the OPERATION INDICATOR lamp on the indoor unit is flashing on and off to indicate an abnormality. To make sure, check how many times the OPERATION INDICATOR lamp is flashing on and off before starting service work.
- 2) Before servicing, check that the connector and terminal are connected properly.
- 3) When the P.C. board seems to be defective, check the copper foil pattern for disconnection and the components for bursting and discoloration.
- 4) Refer to 11-2, 11-3 and 11-4.

11-2. FAILURE MODE RECALL FUNCTION

This air conditioner can memorize the abnormal condition which has occurred once.

Even though LED indication listed on the troubleshooting check table (11-4.) disappears, the memorized failure details can be recalled.

1. Flow chart of failure mode recall function for the indoor/outdoor unit

Refer to the service manual of indoor unit.

2. Flow chart of the detailed outdoor unit failure mode recall function

Operational procedure

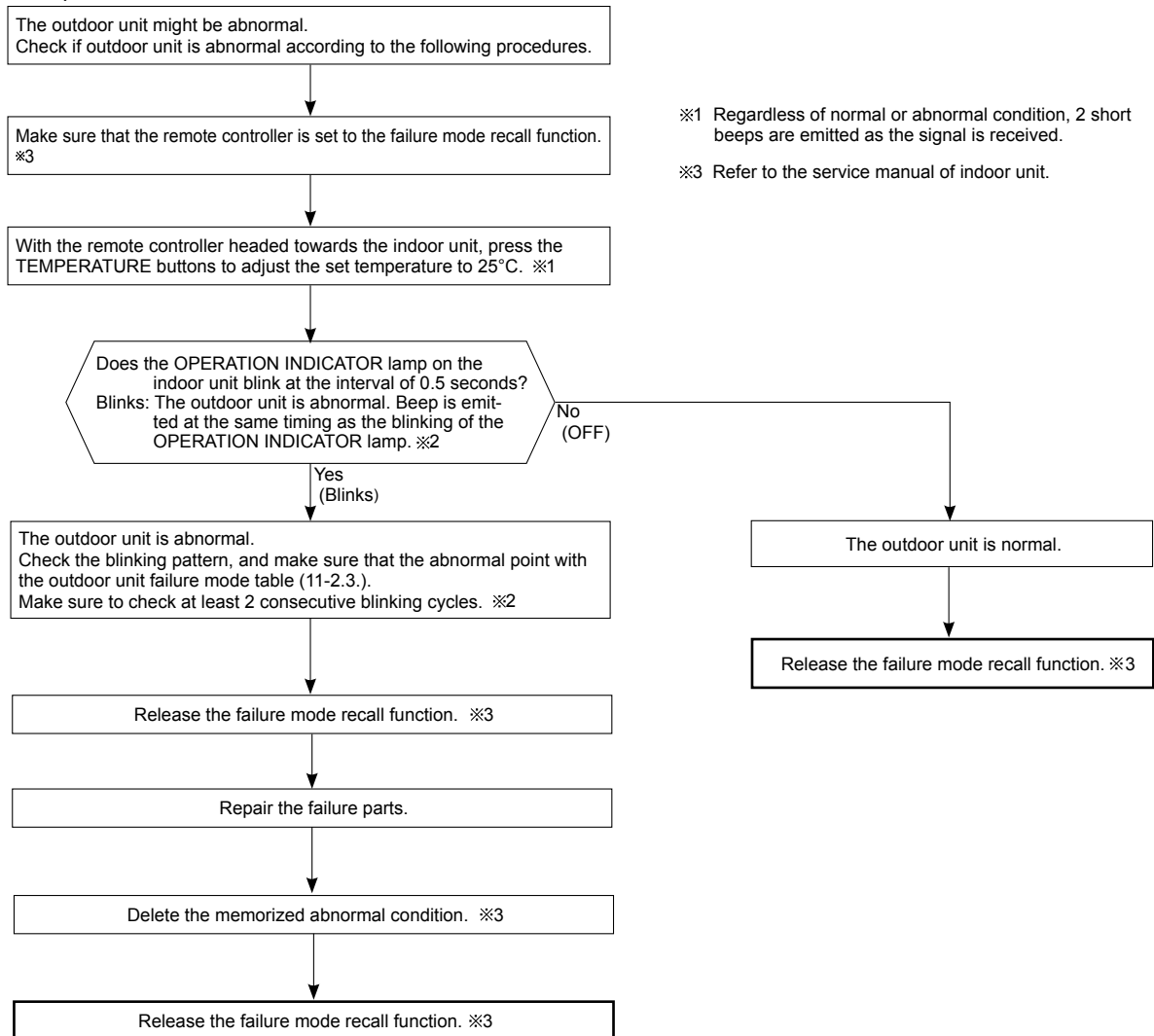

NOTE: 1. Make sure to release the failure mode recall function after it is set up, otherwise the unit cannot operate properly.
2. If the abnormal condition is not deleted from the memory, the last abnormal condition is kept memorized.

※2. Blinking pattern when outdoor unit is abnormal:

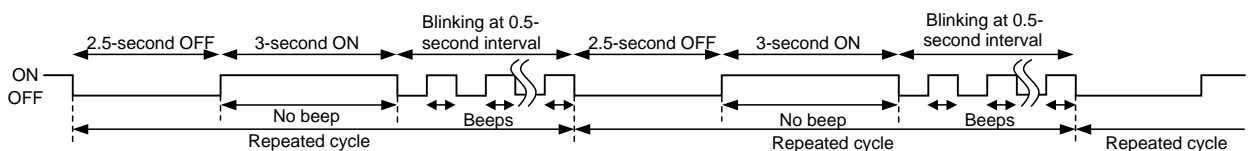

3. Outdoor unit failure mode table

The left lamp of OPERATION INDICATOR lamp (Indoor unit)	Abnormal point (Failure mode/protection)	LED indication (Outdoor P.C. board)		Condition	Remedy	Indoor/outdoor unit failure mode recall function
		LED 1	LED 2			
OFF	None (Normal)	Lighted	Lighted			
2-time flash	Outdoor power system	Lighted	Lighted	Overcurrent protection cut-out operates 3 consecutive times within 1 minute after the compressor gets started, or converter protection cut-out or bus-bar voltage protection cut-out operates 3 consecutive times within 3 minutes after start-up.	<ul style="list-style-type: none"> • Check the connection of the compressor connecting wire. • Refer to 11-6. ㉔ "How to check inverter/compressor". • Check the stop valve. 	○
3-time flash	Discharge temperature thermistor	Lighted	Once	A thermistor shorts or opens during compressor running.	<ul style="list-style-type: none"> • Refer to 11-6. ㉔ "Check of outdoor thermistors". 	○
	Defrost thermistor	Lighted	Once			
	Ambient temperature thermistor	Lighted	Twice			
	Fin temperature thermistor	Lighted	3 times			
	P.C. board temperature thermistor	Lighted	4 times			
Outdoor heat exchanger temperature thermistor	Lighted	9 times		<ul style="list-style-type: none"> • Replace the outdoor control P.C. board. • Refer to 11-6. ㉔ "Check of outdoor thermistors". 		
4-time flash	Overcurrent	Once	Not lighted	21 A current flows into power module.	<ul style="list-style-type: none"> • Reconnect compressor connector. • Refer to 11-6. ㉔ "How to check inverter/compressor". • Check the stop valve. 	—
5-time flash	Discharge temperature	Lighted	Lighted	The discharge temperature exceeds 106°C during operation. Compressor can restart if discharge temperature thermistor reads 95°C or less 3 minutes later.	<ul style="list-style-type: none"> • Check refrigerant circuit and refrigerant amount. • Refer to 11-6. ㉔ "Check of LEV". 	—
6-time flash	High pressure	Lighted	Lighted	The outdoor heat exchanger temperature exceeds 70°C during cooling or the indoor gas pipe temperature exceeds 70°C during heating.	<ul style="list-style-type: none"> • Check refrigerant circuit and refrigerant amount. • Check the stop valve. 	—
7-time flash	Fin temperature	3 times	Not lighted	The fin temperature exceeds 89°C during operation.	<ul style="list-style-type: none"> • Check around outdoor unit. • Check outdoor unit air passage. • Refer to 11-6. ㉔ "Check of outdoor fan motor". 	—
	P.C. board temperature	4 times	Not lighted	The P.C. board temperature exceeds 67°C during operation.		
8-time flash	Outdoor fan motor	Lighted	Lighted	A failure occurs 3 consecutive times within 30 seconds after the fan gets started.	<ul style="list-style-type: none"> • Refer to 11-6. ㉔ "Check of outdoor fan motor". 	—
9-time flash	Outdoor control system	Lighted	5 times	Nonvolatile memory data cannot be read properly.	<ul style="list-style-type: none"> • Replace the outdoor control P.C. board. 	○
10-time flash	Low discharge temperature protection	Lighted	Lighted	The frequency of the compressor is kept 80 Hz or more and the discharge temperature is kept under 39°C for more than 20 minutes.	<ul style="list-style-type: none"> • Check refrigerant circuit and refrigerant amount. • Refer to 11-6. ㉔ "Check of LEV". 	—
11-time flash	Communication error between P.C. boards	Lighted	6 times	Communication error occurs between the outdoor control P.C. board and outdoor power P.C. board for more than 10 seconds.	<ul style="list-style-type: none"> • Check the connecting wire between outdoor control P.C. board and outdoor power P.C. board. 	—
				The communication between boards protection cut-out operates 2 consecutive times.		○
	Current sensor	Lighted	7 times	A short or open circuit is detected in the current sensor during compressor operating.	—	—
				Current sensor protection cut-out operates 2 consecutive times.		○
	Zero cross detecting circuit	5 times	Not lighted	Zero cross signal cannot be detected while the compressor is operating.	<ul style="list-style-type: none"> • Check the connecting wire among outdoor control P.C. board and outdoor power P.C. board. 	—
				The protection cut-out of the zero cross detecting circuit operates 10 consecutive times.		○
Converter	5 times	Not lighted	A failure is detected in the operation of the converter during operation.	<ul style="list-style-type: none"> • Check the voltage of power supply. • Replace the outdoor power P.C. board. 	—	
Bus-bar voltage	5 times	Not lighted	The bus-bar voltage exceeds 400 V or falls to low level during compressor operating.	<ul style="list-style-type: none"> • Check the voltage of power supply. • Replace the outdoor control P.C. board. 	—	
15-time flash	LEV and drain pump	Lighted	Lighted	The indoor unit detects an abnormality in the LEV and drain pump.	<ul style="list-style-type: none"> • Refer to 11-6. ㉔ "Check of LEV". • Check the drain pump of the indoor unit. 	—

NOTE: Blinking patterns of this mode differ from the ones of Troubleshooting check table (11-4.).

11-3. INSTRUCTION OF TROUBLESHOOTING

- Check the indoor unit with referring to the indoor unit service manual, and confirm that there is any problem in the indoor unit.
Then, check the outdoor unit with referring to this page.

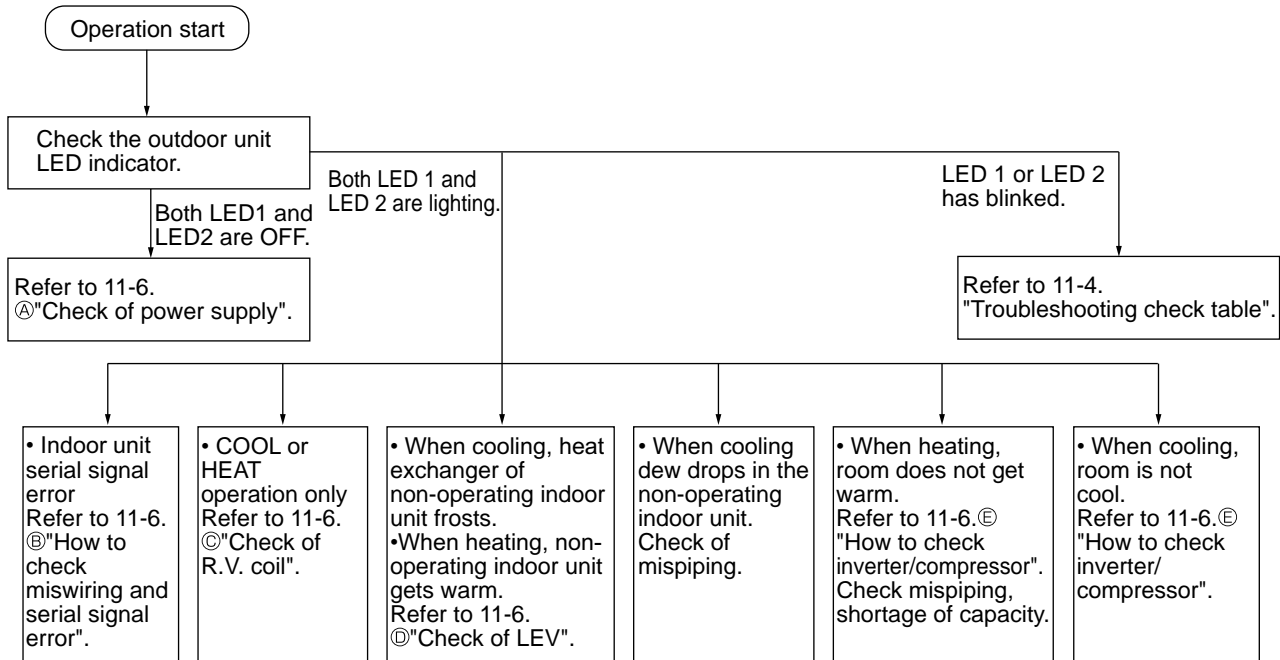

11-4. TROUBLESHOOTING CHECK TABLE

No.	Symptom	Indication		Abnormal point / Condition	Condition	Remedy	
		LED1(Red)	LED2(Yellow)				
1	'Outdoor unit does not operate.'	Lighted	Once	LEV and drain pump	The indoor unit detects an abnormality in the LEV and drain pump.	<ul style="list-style-type: none"> Refer to 11-6. ④ "Check of LEV". Check the drain pump of the indoor unit. 	
2		Lighted	Twice	Outdoor power system	Overcurrent protection cut-out operates 3 consecutive times within 1 minute after the compressor gets started, or converter protection cut-out or bus-bar voltage protection cut-out operates 3 consecutive times within 3 minutes after start-up.	<ul style="list-style-type: none"> Check the connection of the compressor connecting wire. Refer to 11-6. ⑤ "How to check inverter/compressor". Check the stop valve. 	
3		Lighted	3 times	Discharge temperature thermistor	A short circuit is detected in the thermistor during operation, or an open circuit is detected in the thermistor after 10 minutes of compressor start-up.	<ul style="list-style-type: none"> Refer to 11-6. ⑥ "Check of outdoor thermistors". 	
4		Lighted	4 times	Fin temperature thermistor P. C. board temperature thermistor	A short or open circuit is detected in the thermistor during operation.	<ul style="list-style-type: none"> Refer to 11-6. ⑥ "Check of outdoor thermistors". Replace the outdoor control P.C. board. 	
5		Lighted	5 times	Ambient temperature thermistor Outdoor heat exchanger temperature thermistor Defrost thermistor	A short or open circuit is detected in the thermistor during operation. A short circuit is detected in the thermistor during operation, or an open circuit is detected in the thermistor after 5 minutes (in cooling) and 10 minutes (in heating) of compressor start-up. A short circuit is detected in the thermistor during operation, or an open circuit is detected in the thermistor after 5 minutes of compressor start-up.	<ul style="list-style-type: none"> Refer to 11-6. ⑥ "Check of outdoor thermistors". 	
6		Lighted	6 times	Zero cross detecting circuit (Outdoor control P.C. board)	Zero cross signal cannot be detected.	<ul style="list-style-type: none"> Replace the outdoor control P.C. board. 	
7		Lighted	7 times	Outdoor control system	The nonvolatile memory data cannot be read properly.	<ul style="list-style-type: none"> Replace the outdoor control P.C. board. 	
8		Lighted	8 times	Current sensor	Current sensor protection cut-out operates 2 consecutive times.	<ul style="list-style-type: none"> Replace the outdoor power P.C. board. 	
9		Lighted	11 times	Communication error between P.C. boards M-NET communication error	The communication protection cut-out between boards operates 2 consecutive times. M-NET adapter P.C. board detects an abnormality in the communication error.	<ul style="list-style-type: none"> Check the connecting wire between outdoor control P.C. board and outdoor power P.C. board. Check the connecting wire between M-NET adapter P.C. board and outdoor control P.C. board, or terminal block. 	
10		Lighted	12 times	Zero cross detecting circuit (Outdoor power P.C. board)	The protection cut-out of the zero cross detecting circuit operates 10 consecutive times.	<ul style="list-style-type: none"> Replace the outdoor power P.C. board. 	
11		Lighted	13 times	Current sensor	A short or open circuit is detected in the input current detection circuit during operation.	<ul style="list-style-type: none"> Replace the outdoor power P.C. board. 	
12		Lighted	14 times	Voltage sensor	A short or open circuit is detected in the input voltage detection circuit during operation.	<ul style="list-style-type: none"> Replace the outdoor power P.C. board. 	
13		Lighted	15 times	Relay operation	No relay operation is detected during operation.	<ul style="list-style-type: none"> Replace the outdoor power P.C. board. 	
14		'Outdoor unit stops and restarts 3 minutes later' is repeated.'	Twice	Not lighted	IPM protection	Overcurrent is detected after 30 seconds of compressor start-up.	<ul style="list-style-type: none"> Reconnect compressor connector. Refer to 11-6. ⑤ "How to check inverter/compressor".
15					Lock protection	Overcurrent is detected within 30 seconds of compressor start-up.	<ul style="list-style-type: none"> Check the stop valve. Check the power module (PAM module).
16	3 times		Not lighted	Discharge temperature protection	The discharge temperature exceeds 106°C during operation. Compressor can restart if discharge temperature thermistor reads 95°C or less 3 minutes later.	<ul style="list-style-type: none"> Check the amount of gas and refrigerant circuit. Refer to 11-6. ④ "Check of LEV". 	
17	4 times		Not lighted	Fin temperature protection	The fin temperature exceeds during operation.	<ul style="list-style-type: none"> Check refrigerant circuit and refrigerant amount. Refer to 11-6. ④ "Check of outdoor fan motor". 	
				P.C. board temperature protection	The P.C. board temperature exceeds during operation.		
18	5 times		Not lighted	High-pressure protection	High-pressure is detected with the high-pressure switch (HPS) during operation.	<ul style="list-style-type: none"> Check around of gas and the refrigerant circuit. Check the stop valve. 	
					The outdoor heat exchanger temperature exceeds 70°C during cooling or the indoor gas pipe temperature exceeds 70°C during heating.		
19	6 times		Not lighted	Pre-heating protection	Overcurrent is detected during pre-heating.	<ul style="list-style-type: none"> Reconnect compressor connector. Refer to 11-6. ⑤ "How to check inverter/compressor". Check the power module. 	
20	8 times		Not lighted	Converter protection	A failure is detected in the operation of the converter during operation.	<ul style="list-style-type: none"> Replace the outdoor power P.C. board. 	
21	9 times	Not lighted	Bus-bar voltage protection	The bus-bar voltage exceeds 400 V or falls to low level during compressor operating.	<ul style="list-style-type: none"> Check the voltage of power supply. Replace the outdoor power P.C. board or the outdoor control P.C. board. Refer to 11-6. ④ "Check of bus-bar voltage". 		
	11 times	Not lighted	Low out side temperature protection(cooling)	The ambient became -12°C or less.	—		



No.	Symptom	Indication		Abnormal point / Condition	Condition	Remedy			
		LED1(Red)	LED2(Yellow)						
22	'Outdoor unit stops and restarts 3 minutes later' is repeated.	13 times	Not lighted	Outdoor fan motor	A failure occurs 3 consecutive times within 30 seconds after the fan gets started.	• Refer to 11-6. Ⓞ "Check of outdoor fan motor".			
23		Lighted	8 times	Current sensor protection	A short or open circuit is detected in the current sensor during compressor operating.	• Replace the outdoor power P.C. board.			
24		Lighted	11 times	Communication between P.C. boards protection	Communication error occurs between the outdoor control P.C. board and outdoor power P.C. board for more than 10 seconds.	• Check the connecting wire between outdoor control P.C. board and outdoor power P.C. board.			
25		Lighted	12 times	Zero cross detecting circuit (Outdoor power P.C. board)	Zero cross signal cannot be detected while the compressor is operating.	• Replace the outdoor power P.C. board.			
26	Outdoor unit operates.	Once	Lighted	Primary current protection	The input current exceeds 18 A.	These symptoms do not mean any abnormality of the product, but check the following points. • Check if indoor filters are clogged. • Check if refrigerant is short. • Check if indoor/outdoor unit air circulation is short cycled.			
27		Twice	Lighted	High-pressure protection	The indoor gas pipe temperature exceeds 45°C during heating.				
				Defrosting in cooling	The indoor gas pipe temperature falls 3°C or below during cooling.				
28		3 times	Lighted	Discharge temperature protection	The frequency of the compressor is kept 80 Hz or more and the discharge temperature is kept under 50°C(COOL mode)/40°C(HEAT mode) for more than 40 minutes.		• Check refrigerant circuit and refrigerant amount. • Refer to 11-6. Ⓞ "Check of LEV". • Refer to 11-6. Ⓞ "Check of outdoor thermistors".		
29					4 times		Lighted	Low discharge temperature protection	The frequency of the compressor is kept 80 Hz or more and the discharge temperature is kept under 39°C for more than 20 minutes.
30	5 times					Lighted			Cooling high-pressure protection
31	Outdoor unit operates.	11 times	Lighted	M-NET communication error	M-NET adapter P.C. board detects an abnormality in the communication error.	• Check the connecting wire between M-NET adapter P.C. board and outdoor control P.C. board, or terminal block.			
32	Outdoor unit operates normally.	9 times	Lighted	Inverter check mode	The unit is operated with emergency operation switch.	—			
33		Lighted	Lighted	Normal	—	—			

NOTE 1. The location of LED is illustrated at the right figure. Refer to 11-7.1.

2. LED is lighted during normal operation.

The flashing frequency shows the number of times the LED blinks after every 2.5-second OFF.
(Example) When the flashing frequency is "2".

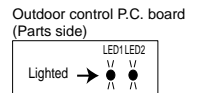
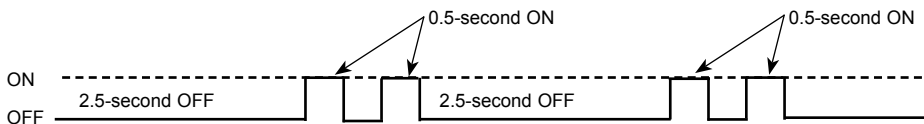

11-5. TROUBLE CRITERION OF MAIN PARTS
MXZ-4E83VA MXZ-5E102VA

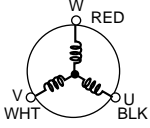
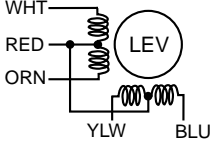
Part name	Check method and criterion								
Defrost thermistor (RT61) Fin temperature thermistor (RT64) Ambient temperature thermistor (RT65) Outdoor heat exchanger temperature thermistor (RT68)	Measure the resistance with a tester. Refer to 11-7. "Test point diagram and voltage", 1. "Outdoor control P.C.board", 2. "Outdoor power P.C. board", for the chart of thermistor.								
Discharge temperature thermistor (RT62)	Measure the resistance with a tester. Before measurement, hold the thermistor with your hands to warm it up. Refer to 11-7. "Test point diagram and voltage", 1. "Outdoor control P.C. board" for the chart of thermistor.								
Compressor 	Measure the resistance between terminals using a tester. (Winding temperature: -10 °C ~ 40 °C) <table border="1" data-bbox="411 779 1249 853"> <tr> <td style="text-align: center;">Normal (Each phase)</td> </tr> <tr> <td style="text-align: center;">0.83 Ω ~ 1.03 Ω</td> </tr> </table>	Normal (Each phase)	0.83 Ω ~ 1.03 Ω						
Normal (Each phase)									
0.83 Ω ~ 1.03 Ω									
Outdoor fan motor	<ul style="list-style-type: none"> Refer to 11-6. ©. 								
R.V. coil	Measure the resistance using a tester. (Part temperature: -10 °C ~ 40 °C) <table border="1" data-bbox="411 1014 1249 1088"> <tr> <td style="text-align: center;">Normal (Each phase)</td> </tr> <tr> <td style="text-align: center;">1.20 kΩ ~ 1.77 kΩ</td> </tr> </table>	Normal (Each phase)	1.20 kΩ ~ 1.77 kΩ						
Normal (Each phase)									
1.20 kΩ ~ 1.77 kΩ									
Linear expansion valve 	Measure the resistance using a tester. (Part temperature: -10 °C ~ 40 °C) <table border="1" data-bbox="411 1144 999 1308"> <tr> <td style="text-align: center;">Color of lead wire</td> <td style="text-align: center;">Normal</td> </tr> <tr> <td style="text-align: center;">WHT - RED</td> <td rowspan="4" style="text-align: center;">37.4 Ω ~ 53.9 Ω</td> </tr> <tr> <td style="text-align: center;">RED - ORN</td> </tr> <tr> <td style="text-align: center;">YLW - RED</td> </tr> <tr> <td style="text-align: center;">RED - BLU</td> </tr> </table>	Color of lead wire	Normal	WHT - RED	37.4 Ω ~ 53.9 Ω	RED - ORN	YLW - RED	RED - BLU	
Color of lead wire	Normal								
WHT - RED	37.4 Ω ~ 53.9 Ω								
RED - ORN									
YLW - RED									
RED - BLU									
High pressure switch (HPS)	<table border="1" data-bbox="411 1328 1198 1424"> <tr> <td></td> <td style="text-align: center;">Pressure</td> <td style="text-align: center;">Normal</td> </tr> <tr> <td rowspan="2" style="text-align: center;">HPS</td> <td style="text-align: center;">3.43 ± 0.15 MPa</td> <td style="text-align: center;">Close</td> </tr> <tr> <td style="text-align: center;">4.41 ± 0.1 MPa</td> <td style="text-align: center;">Open</td> </tr> </table>		Pressure	Normal	HPS	3.43 ± 0.15 MPa	Close	4.41 ± 0.1 MPa	Open
	Pressure	Normal							
HPS	3.43 ± 0.15 MPa	Close							
	4.41 ± 0.1 MPa	Open							

11-6. TROUBLESHOOTING FLOW

Outdoor unit does not operate.

Ⓐ Check of power supply

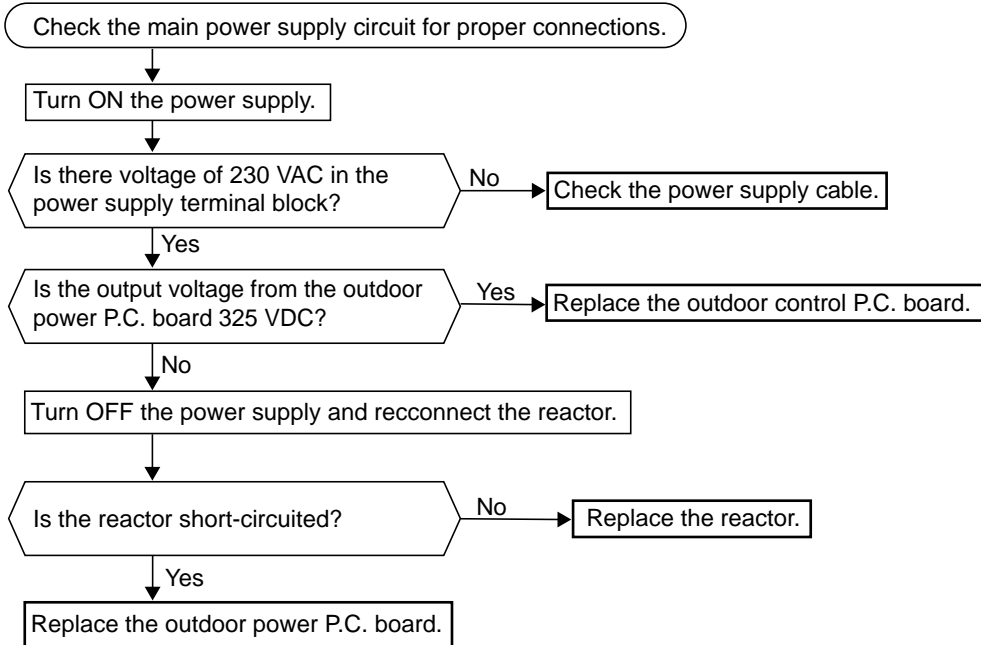

- When unit cannot operate neither by the remote controller nor by EMERGENCY OPERATION switch. Indoor unit does not operate.
- When OPERATION INDICATOR lamp flashes ON and OFF in every 0.5-second. Outdoor unit does not operate.

Ⓑ How to check miswiring and serial signal error (when outdoor unit does not work)

LED indication for communication status
Communication status is indicated by the LED.

Unit status
Blinking: normal communication
Lighting: abnormal communication or not connected

Pattern 1 and 2 is repeatedly displayed alternately. Each pattern is displayed for 15 seconds.

NOTE: "Lighting" in the table below does not indicate abnormal communication.

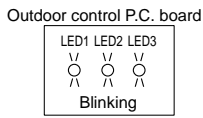

Pattern	LED 1	LED 2	LED 3
1	Unit A status	Unit B status	Lighted
2	Unit C status	Unit D status	Not lighted
3	Unit E status	—	Blinking

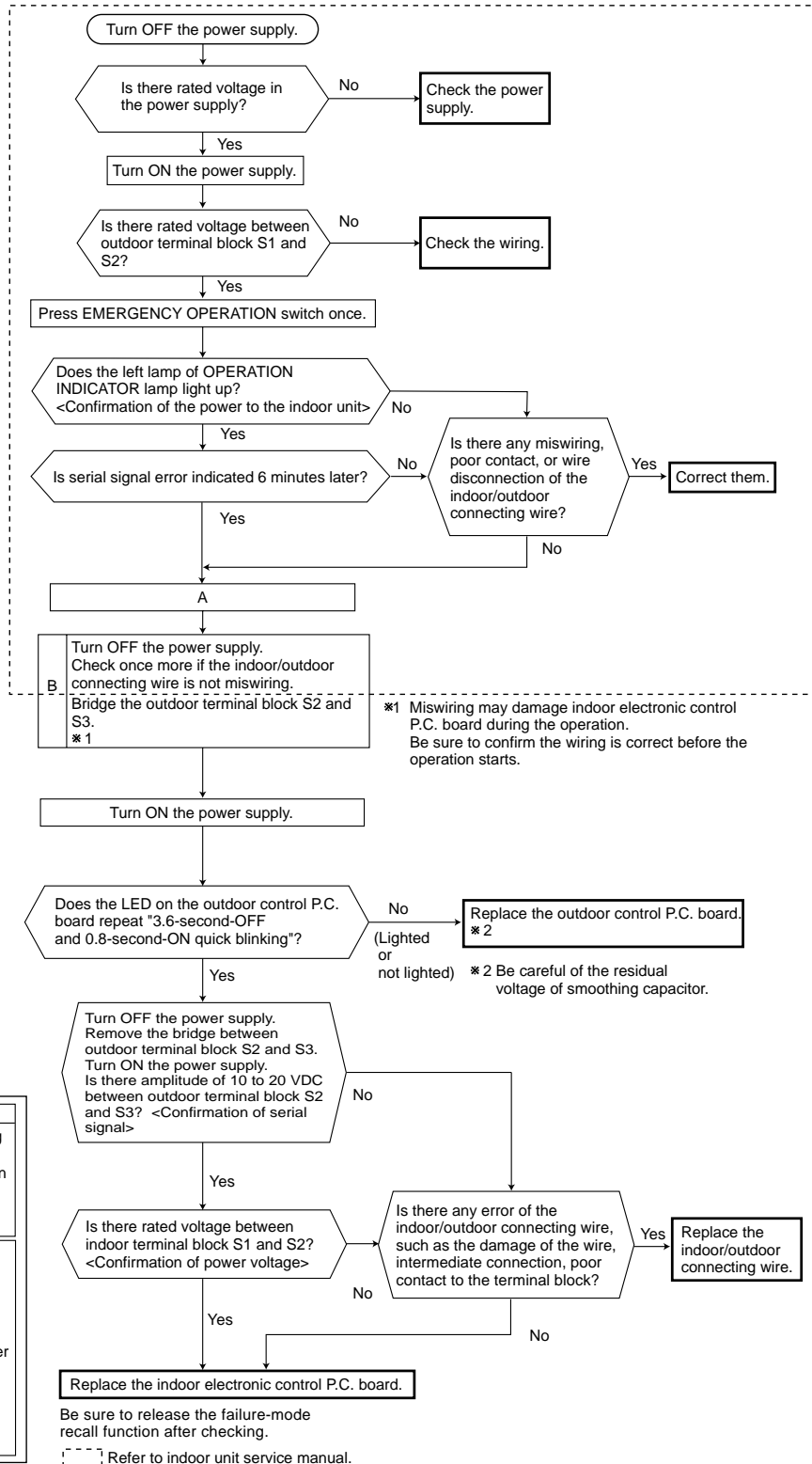



The cooling operation or heating operation does not operate.

© Check of R.V. coil

• When cooling operation does not work.

1. Disconnect the lead wire leading to the compressor.
2. 3 minutes after turning ON the power supply, start EMERGENCY OPERATION in COOL mode.

CNAC	Outdoor control P.C. board
CNAC2	Outdoor power P.C. board

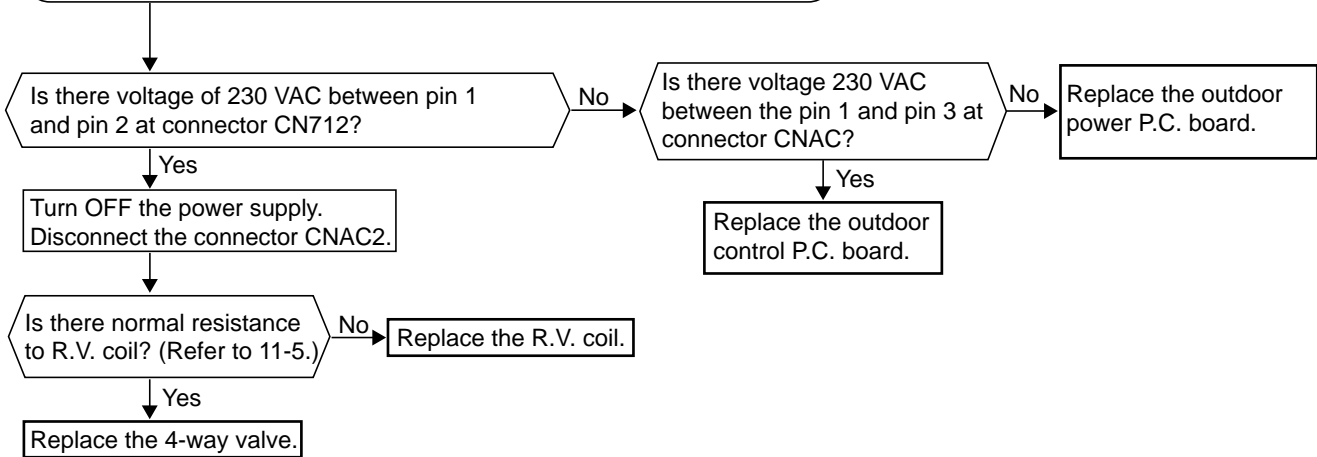

• When heating operation does not work.

1. Disconnect the lead wire leading to the compressor.
2. 3 minutes after turning ON the power supply, start EMERGENCY OPERATION in HEAT mode.

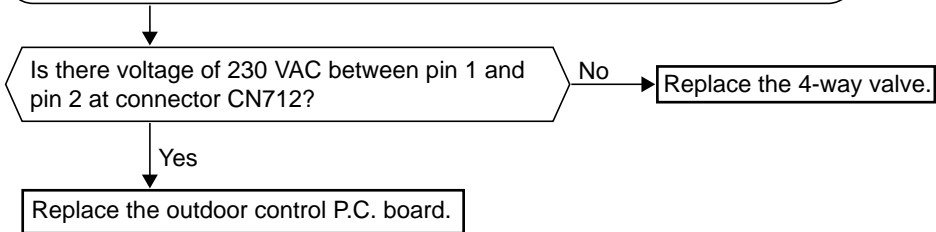

- When cooling, heat exchanger of non-operating indoor unit frosts.
- When heating, non-operating indoor unit gets warm.

⑩ **Check of LEV**

Turn ON the power supply to the outdoor unit after checking LEV coil is mounted to the LEV body securely.

Is "click - click" sound heard?
Or, do you feel vibration of LEV coil with your hand?

Yes → Normal

No

Disconnect the connectors.
CN791: LEV A, CN792: LEV B, CN793: LEV C,
CN794: LEV D,
CN795: LEV E (**MXZ-5E**)
Is there normal resistance to LEV coil?
(Refer to 11-5.)

Yes → Replace the outdoor control P.C. board.

No

Replace LEV coil.

CN791	Outdoor control P.C. board
CN792	
CN793	
CN794	
CN795	

- When heating, room does not get warm.
- When cooling, room does not get cool.

Ⓔ How to check inverter/compressor

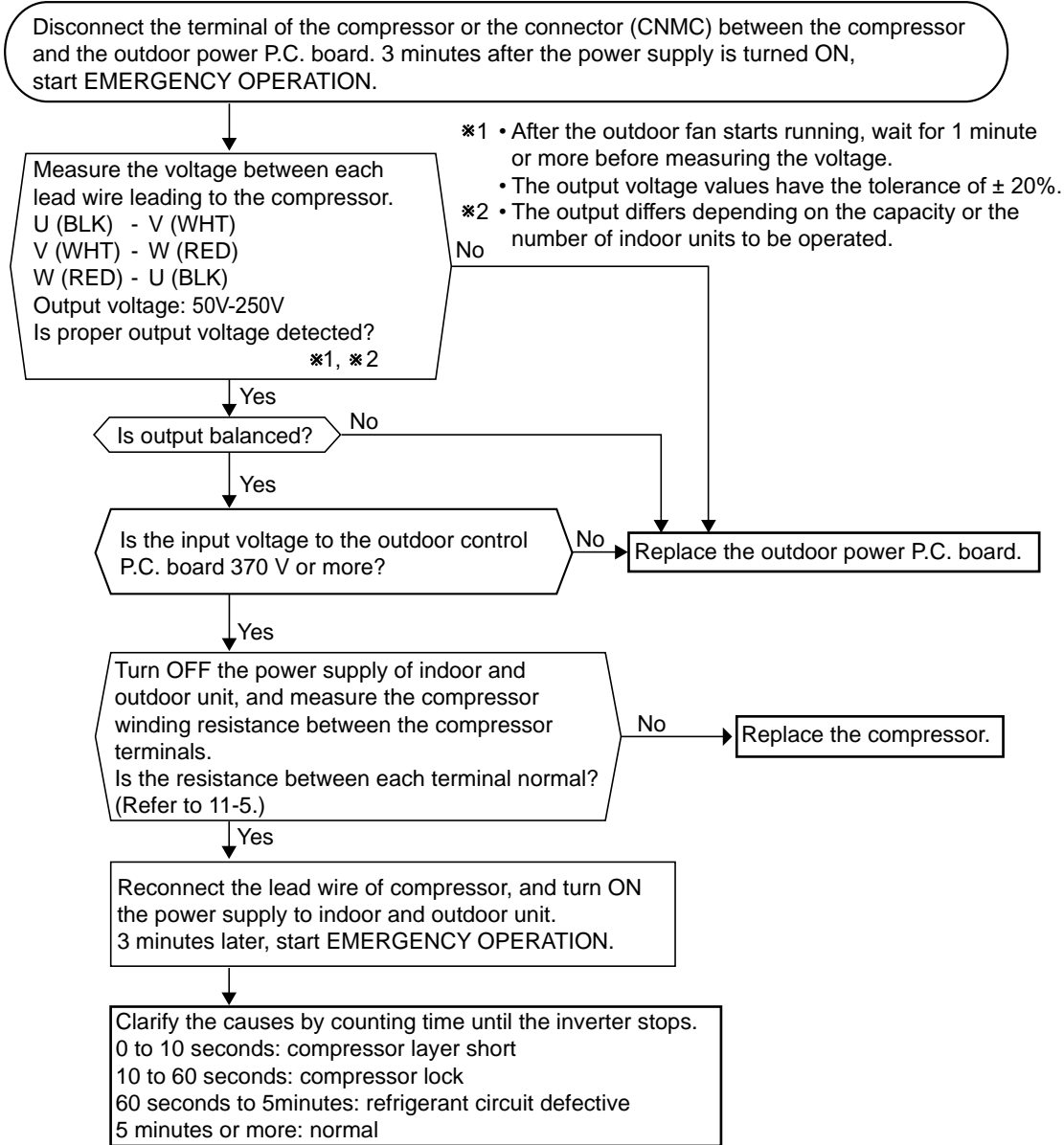

• When thermistor is abnormal.

⑤ Check of outdoor thermistors

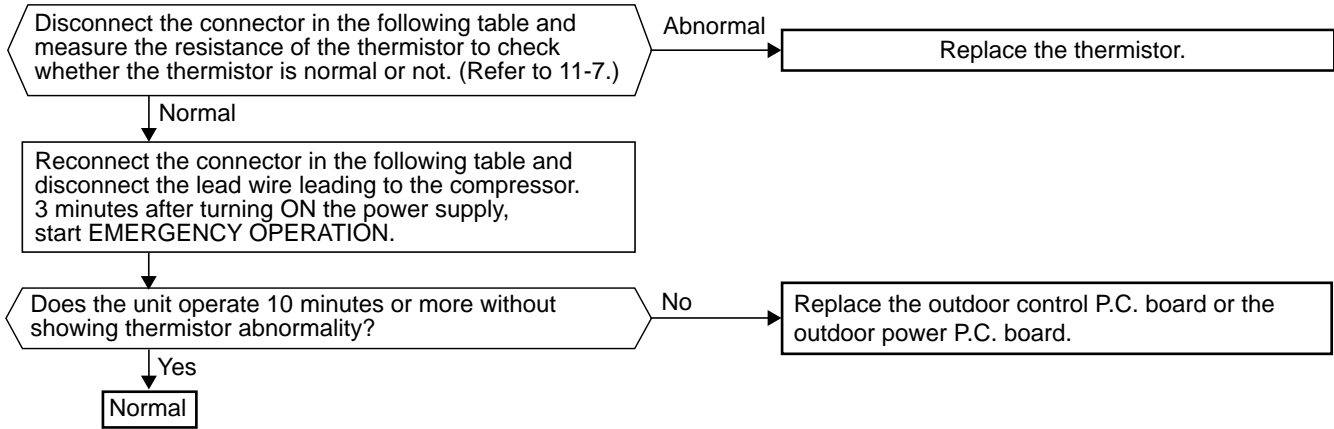

Thermistor	Symbol	Connector, Pin No.	Board
Defrost	RT61	Between CNTH1 pin1 and pin2	Outdoor control P.C. board
Discharge temperature	RT62	Between CNTH1 pin3 and pin4	
Outdoor heat exchanger temperature	RT68	Between CNTH1 pin7 and pin8	
Ambient temperature	RT65	Between CNTH2 pin1 and pin2	Outdoor power P.C. board
Fin temperature	RT64	Between CN171 pin1 and pin2	

• Fan motor does not operate or stops operating shortly after starting the operation.

⑥ Check of outdoor fan motor

Disconnect CNF1 and measure the resistance of the outdoor fan motor.

Is the resistance of outdoor fan motor normal? (Refer to right table)

No → Replace the outdoor fan motor.

Yes

Does the outdoor fan motor rotate smoothly?

No → Replace the outdoor fan motor.

Yes

Turn on the power supply to start operation and measure the voltage of connector CNF1.

CNF1	Voltage
pin 1 - pin 4	325 VDC
pin 5 - pin 4	15 VDC
pin 6 - pin 4	1 - 5 VDC

CNF1	Outdoor control P.C. board
Measuring points	Resistance
pin 1 - pin 4	∞
pin 5 - pin 4	60 kΩ
pin 6 - pin 4	160 kΩ
pin 7 - pin 4	∞

Measuring points	Resistance
pin 1 - pin 4	∞
pin 5 - pin 4	60 kΩ
pin 6 - pin 4	160 kΩ
pin 7 - pin 4	∞

* To measure the resistance, connect the negative (-) end of the tester to pin 4.

Is the voltage of connector CNF1 normal? (Refer to right table.)

No → Replace the outdoor control P.C. board.

Yes

Turn OFF the power supply and connect the connector CNF1. Turn ON the power supply and measure the voltage of connector CNF1 while rotating the motor by the hand.

* To measure the voltage, connect the negative (-) end of the tester to pin 4.
* Voltage between pin 4 and 6 should be measured within 1 minute after the operation starts.

Does the voltage between pin 7 and pin 4 of connector CNF1 repeat 0V and 5V?

No → Replace the outdoor fan motor.

Yes

Start operation.

Does the fan motor operate for about 5 seconds?

No → Replace the outdoor fan motor.

Yes

Replace the outdoor control P.C. board.

• When the operation frequency does not go up from the lowest frequency.

⊕ Check of HPS

CN63H	Outdoor control P.C. board
-------	----------------------------

1. Disconnect the connector CN63H in the outdoor control P.C. board.
2. Check the resistance of HPS after 1 minute has passed since the outdoor unit power supply was turned OFF.

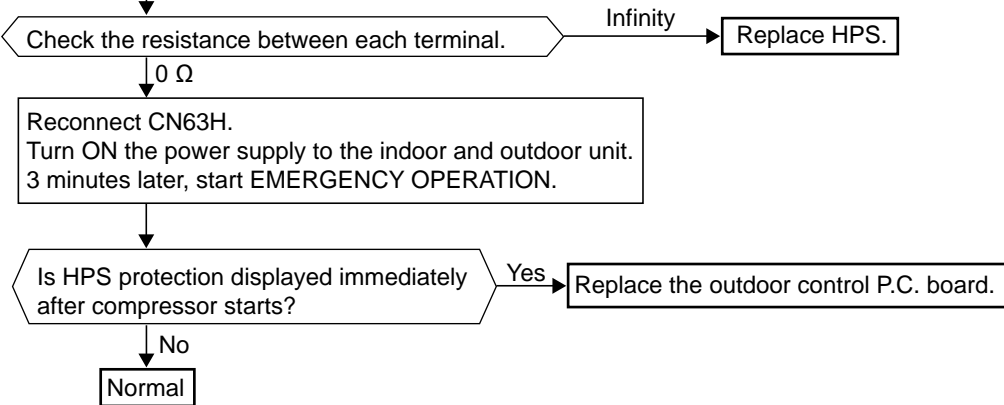

① The other cases

- Indoor unit does not operate. (different operating models in multi system)
- When you try to run two indoor units simultaneously, one for cooling and the other for heating, the unit which transmits signal to the outdoor units first decides the operation mode.
 - When the above situation occurs, set all the indoor units to the same mode, turn OFF the indoor units, and then turn them back ON.
 - Though the top of the indoor unit sometimes gets warm, this does not mean malfunction. The reason is that the refrigerant gas continuously flows into the indoor unit even while it is not operating.

Ⓜ Check of bus-bar voltage

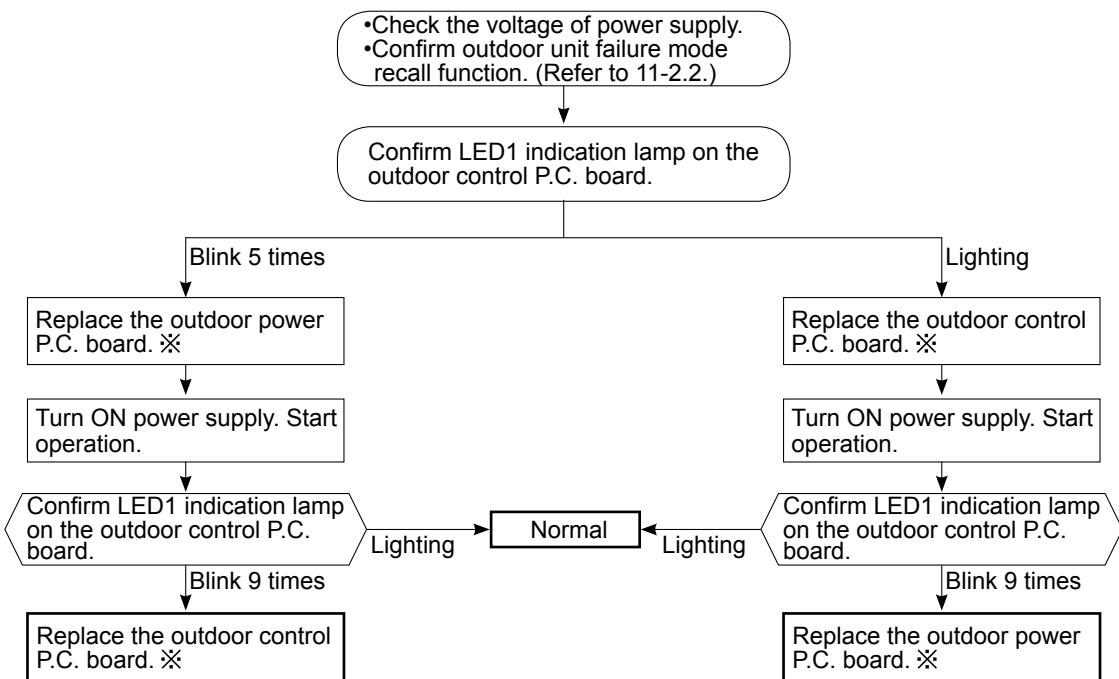

✖ Turn OFF power supply before removing P.C. board.

11-7. TEST POINT DIAGRAM AND VOLTAGE

1. Outdoor control P.C. board

MXZ-4E83VA MXZ-5E102VA

Defrost thermistor (RT61)
 Ambient temperature thermistor (RT65)
 Outdoor heat exchanger thermistor (RT68)

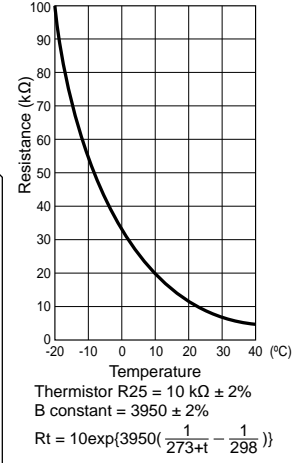
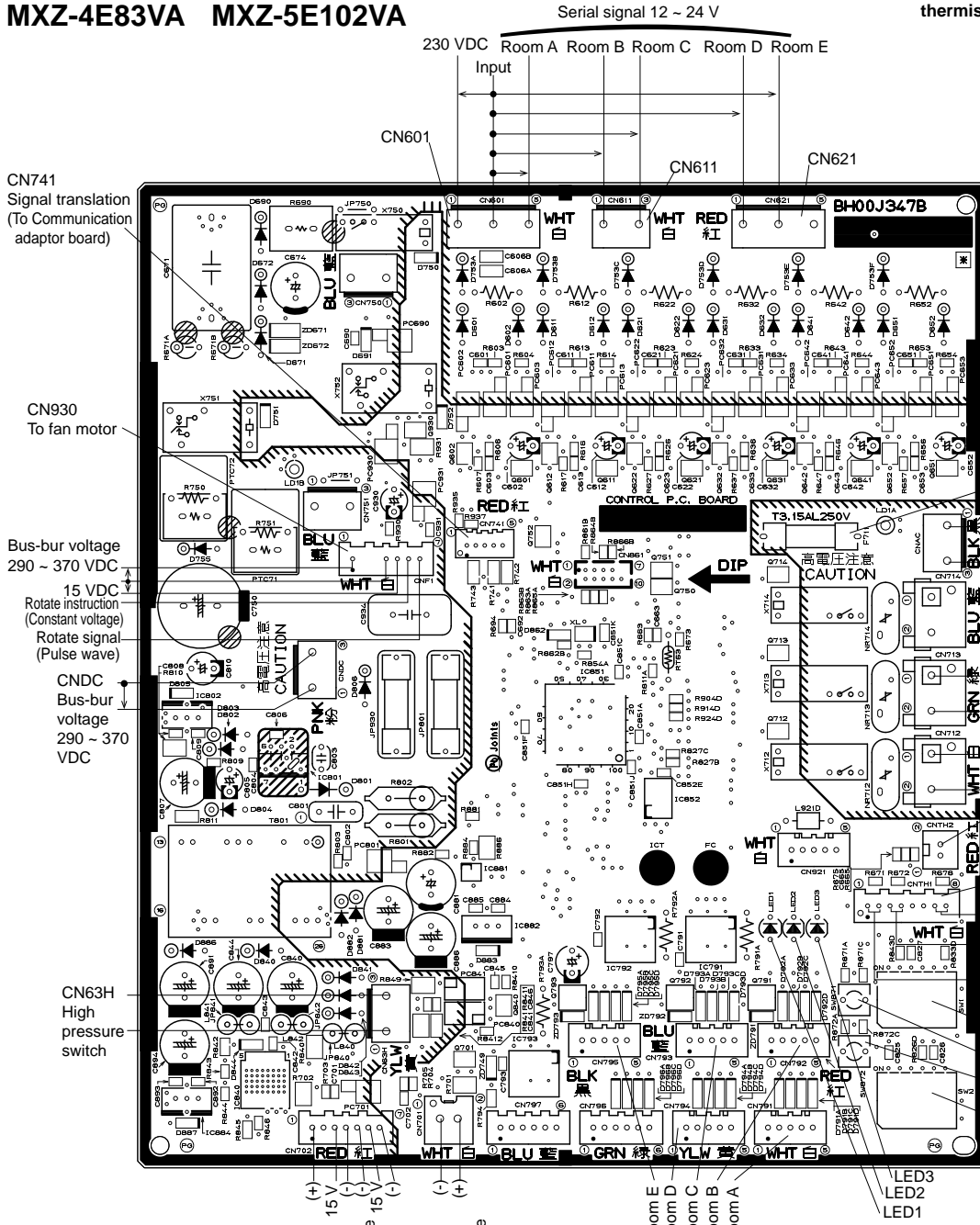

CN930
To fan motor

Bus-bur voltage
290 ~ 370 VDC

15 VDC
Rotate instruction
(Constant voltage)

Rotate signal
(Pulse wave)

CNDC
Bus-bur voltage
290 ~ 370 VDC

F711 FUSE
T3.15AL250V

CNAC
to outdoor power P.C.
board 230 VAC
Input

CN713 Valve coil
230 VAC
Input

CN712 R.V. coil
230 VAC
Input

CNTH2
Ambient temperature
thermistor
(RT65)

CNTH1
Outdoor heat exchanger
temperature thermistor
(RT68)

Discharge temperature
thermistor (RT62)
Defrost thermistor
(RT61)

SW1
SW871
SW872
SW2

CN702 Signal
transmission
(to power board)
5 VDC pulse wave

CN701 Signal
transmission
(to power board)
5 VDC pulse wave

CN795 LEV Room E
CN794 LEV Room D
CN793 LEV Room C
CN792 LEV Room B
CN791 LEV Room A

LEV: 12 VDC
pulse wave

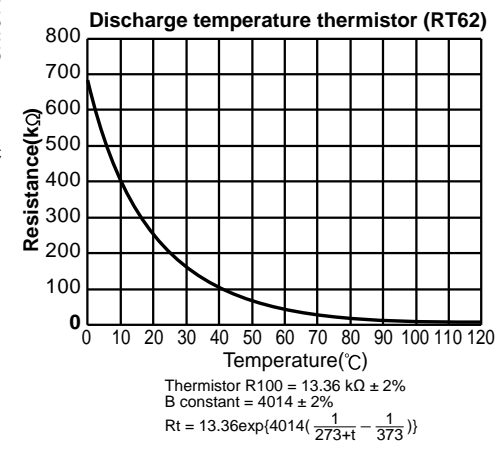

2. Outdoor power P.C. board
MXZ-4E83VA MXZ-5E102VA

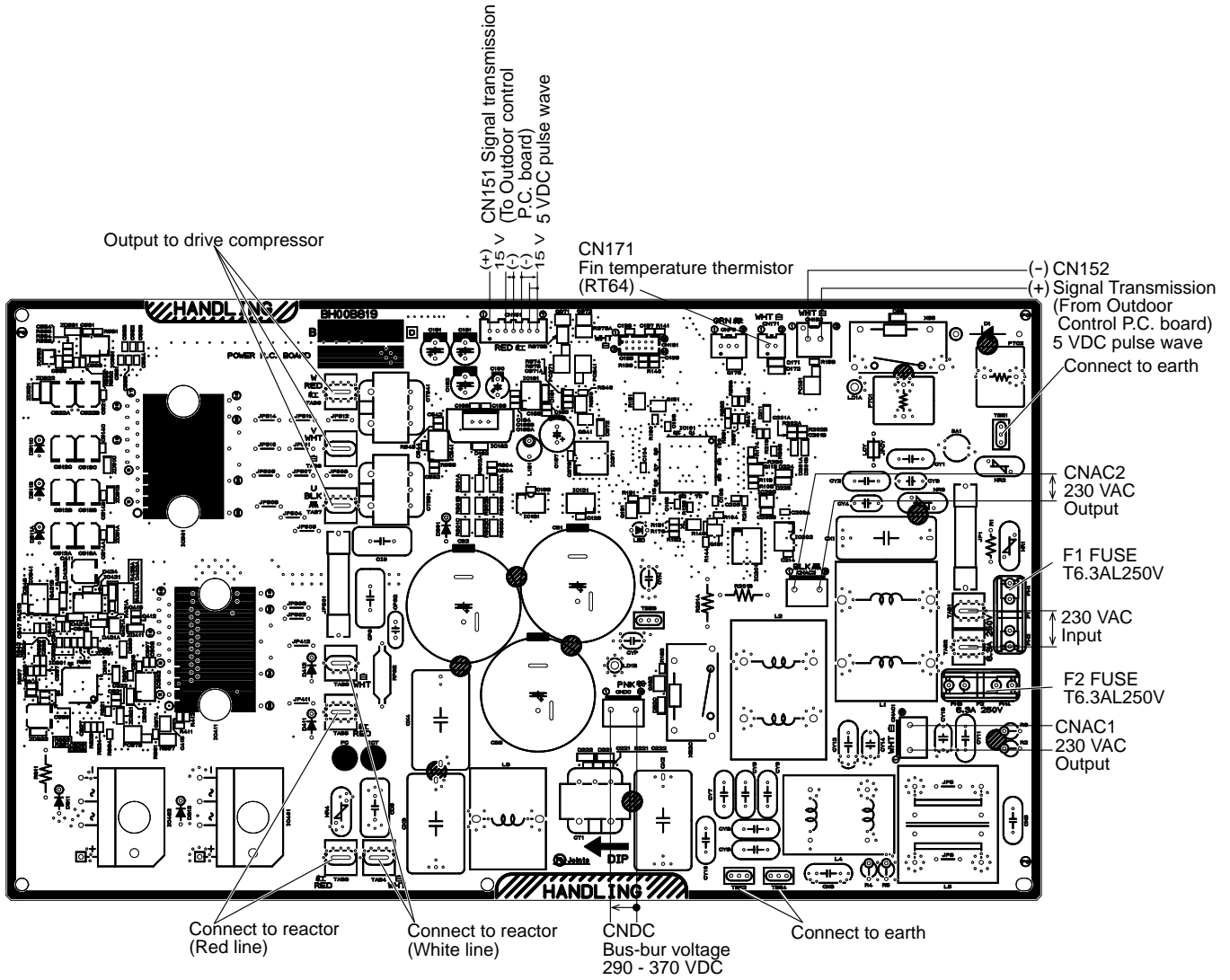

Fin temperature thermistor (RT64)

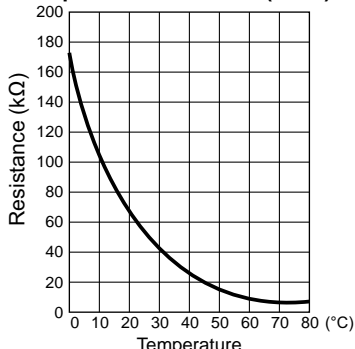

Thermistor R50 = 17 kΩ ± 2%
 B constant = 4150 ± 3%
 $R_t = 17 \exp\left\{4150 \left(\frac{1}{273+t} - \frac{1}{323} \right)\right\}$

<"Terminal with locking mechanism" Detaching points>

The terminal which has the locking mechanism can be detached as shown below. There are two types (Refer to (1) and (2)) of the terminal with locking mechanism. The terminal without locking mechanism can be detached by pulling it out. Check the shape of the terminal before detaching.

(1) Slide the sleeve and check if there is a locking lever or not.

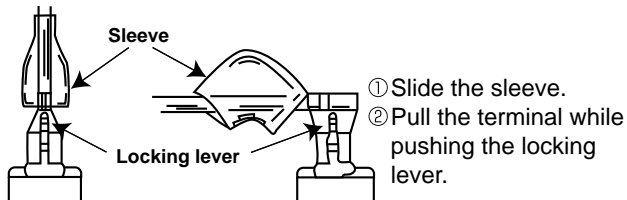

(2) The terminal with this connector has the locking mechanism.

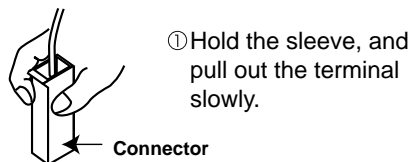

12-1. MXZ-4E83VA MXZ-5E102VA

NOTE: Turn OFF the power supply before disassembly.

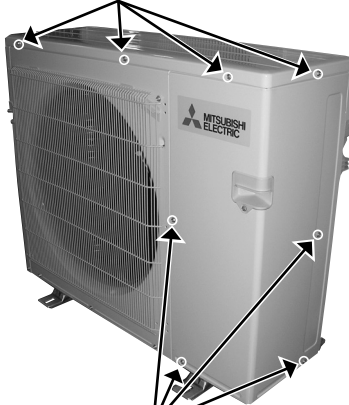
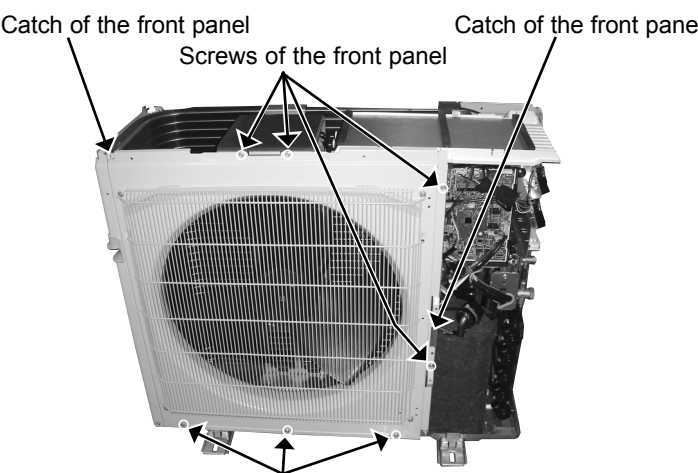
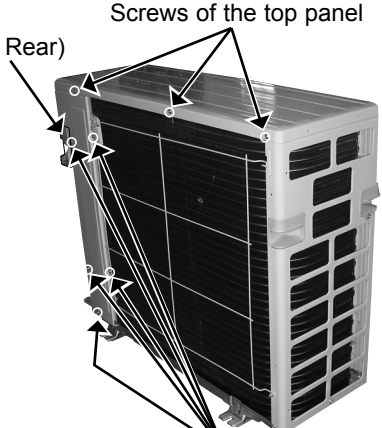
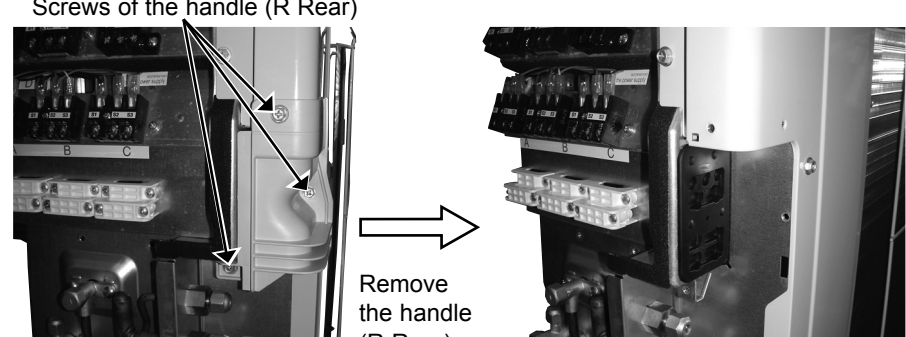
OPERATING PROCEDURE	PHOTOS
<p>1. Removing the panels</p> <ol style="list-style-type: none"> (1) Remove the screws fixing the service panel, and remove the service panel. (2) Remove the screws fixing the top panel and remove the top panel. (3) Remove the screws fixing the handle (R Rear), and remove the handle (R Rear). (4) Disconnect the power supply and indoor/outdoor connecting wire. (5) Remove the screws fixing the front panel, and remove the front panel. (6) Remove the screws fixing the back panel, and remove the back panel. 	<p>Photo 1</p> <p>Screws of the top panel</p>  <p>Screws of the service panel</p>
<p>Photo 3</p> <p>Catch of the front panel</p> <p>Screws of the front panel</p>  <p>Screws of the front panel</p>	<p>Photo 2</p> <p>Handle (R Rear)</p> <p>Screws of the top panel</p>  <p>Screws of the back panel</p>
<p>Photo 4</p> <p>Screws of the handle (R Rear)</p>  <p>Remove the handle (R Rear).</p>	

OPERATING PROCEDURE

2. Removing the outdoor control P.C. board, the reactor and the outdoor power P.C. board

- (1) Remove the service panel and the top panel (Refer to 1).
- (2) Disconnect the power supply and indoor/outdoor connecting wire.
- (3) Disconnect the connectors on the outdoor control P.C. board.
- (4) Remove the screws fixing the outdoor control P.C. board holder, and remove the outdoor control P.C. board.
- (5) Disconnect the lead wire from the reactor.
- (6) Remove the screws fixing the reactor, and remove the reactor.
- (7) Disconnect the lead wire of the power P.C. board.
- (8) Disconnect the catches of the PB cover, and remove the PB cover.
- (9) Remove the outdoor power P.C. board.

Photo 7



Screws of the reactor

PHOTOS

Photo 5

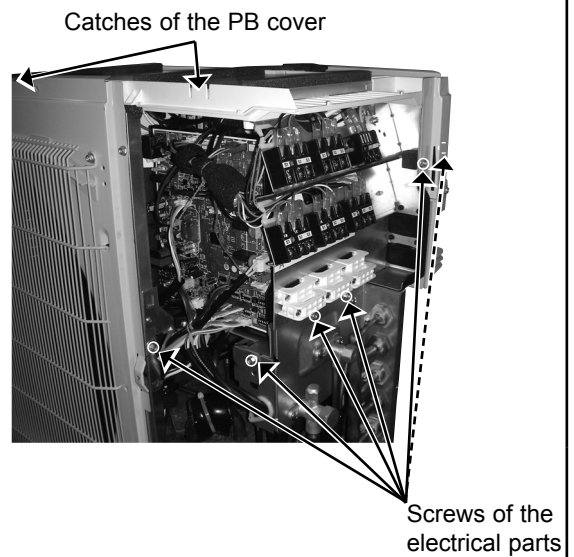

Photo 6



Screws of the outdoor control P.C. board holder

OPERATING PROCEDURE

3. Removing the fan motor

- (1) Remove the service panel, the top panel and the front panel (Refer to 1).
- (2) Disconnect the power supply and indoor/outdoor connecting wire.
- (3) Disconnect the connector CNF1 on the outdoor control P.C. board.
- (4) Remove the propeller fan.
- (5) Remove the fan motor.

4. Removing the expansion valve

- (1) Remove the service panel and the top panel (Refer to 1).
- (2) Disconnect the power supply and indoor/outdoor connecting wire.
(Gas recovery is not required if the unit is pumped down.)
- (3) Remove the LEV coils.
- (4) Detach the brazed parts of the expansion valves and pipes.

PHOTOS

Photo 8

Propeller fan

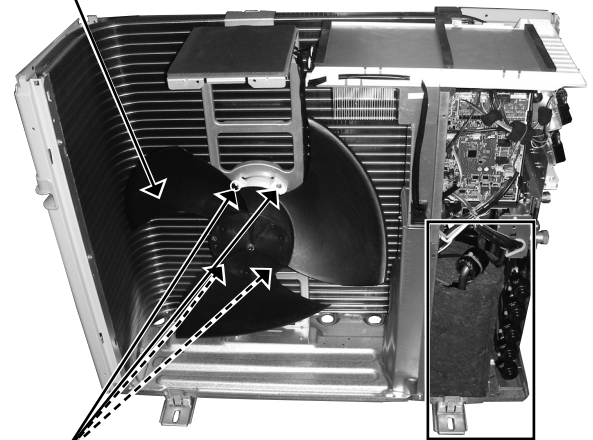

Screws of the outdoor fan motor

Photo 9

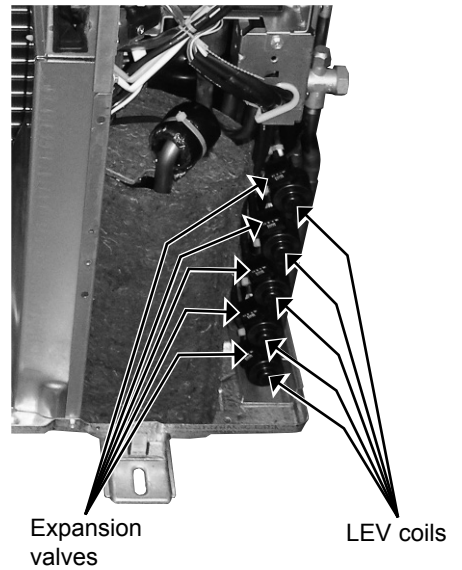

Expansion valves

LEV coils

OPERATING PROCEDURE

5. Removing the compressor and 4-way valve

- (1) Remove the service panel, the top panel, the handle (R Rear), the back panel and the front panel (Refer to 1).
- (2) Disconnect the power supply and indoor/outdoor connecting wire, and remove the back panel.
- (3) Recover gas from the refrigerant circuit.
NOTE: Recover gas from the pipes until the pressure gauge shows 0 kg/cm² (0 MPa).
- (4) Disconnect the compressor lead wire from the terminal of the compressor (U, V, W).
- (5) Disconnect the outdoor control P.C. board connectors: CNF1, CNTH1, CNTH2, CN63H, CN712, CN791, CN792, CN793, CN794, CN795 (**MXZ-5E**)
- (6) Remove the screws fixing the electrical parts, and remove the electrical parts (Photo 5).
- (7) Remove the propeller fan.
- (8) Remove the screws fixing the separator, and remove the separator.
- (9) Remove the sound proof felt.
- (10) Detach the brazed parts of the compressor suction and discharge pipes.
- (11) Remove the compressor nuts and remove the compressor.
- (12) Detach the brazed parts of 4-way valve and pipes.

PHOTOS

Photo 10

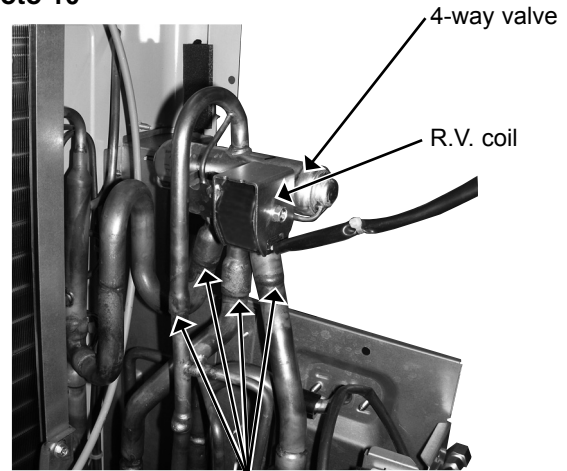

Brazed parts

Photo 11

Discharge pipe brazed part

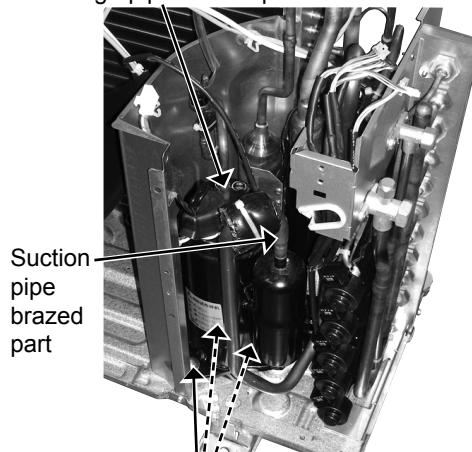

Compressor nuts

MITSUBISHI ELECTRIC CORPORATION

HEAD OFFICE: TOKYO BLDG., 2-7-3, MARUNOUCHI, CHIYODA-KU, TOKYO 100-8310, JAPAN

© Copyright 2015 MITSUBISHI ELECTRIC CORPORATION
Distributed in Apr. 2015. No. OBH723
Made in Japan

New publication, effective Apr. 2015
Specifications are subject to change without notice.

OBH723