

## INSTALLATION MANUAL

Model **MXZ-2A30VA**  
**MXZ-2A40VA**  
**MXZ-2A52VA**



## CONTENTS

1. THE FOLLOWING SHOULD ALWAYS BE OBSERVED FOR SAFETY .....	2
2. INSTALLATION DIAGRAM & ACCESSORIES .....	2
3. SELECTING THE INSTALLATION LOCATION .....	3
4. OUTDOOR UNIT INSTALLATION .....	4
5. INDOOR/OUTDOOR UNITS CONNECTION FINISHING AND TEST RUN .....	5

Refer to the installation manual of each indoor unit for indoor unit installation.

**FOR INSTALLER**

English

Deutsch

Français

Nederlands

Español

Italiano

Ελληνικά

Português

Dansk

Svenska

Türkçe

Русский

# 1. THE FOLLOWING SHOULD ALWAYS BE OBSERVED FOR SAFETY

- Please provide an exclusive circuit for the air conditioner and make sure that no other electrical appliances are connected to it.
- Be sure to read "THE FOLLOWING SHOULD ALWAYS BE OBSERVED FOR SAFETY" before installing the air conditioner.
- Be sure to observe the cautions specified here as they include important items related to safety.
- The indications and meanings are as follows.

⚠ **WARNING:** Could lead to death, serious injury, etc.

⚠ **CAUTION:** Could lead to serious injury in particular environments when operated incorrectly.

- After reading this manual, be sure to keep it together with the OPERATING INSTRUCTIONS in a handy place on the customer's site.

## ⚠ WARNING

- **Do not install the unit by yourself (customer).** Incomplete installation could cause injury due to fire, electric shock, the unit falling or leakage of water. Consult the dealer from whom you purchased the unit or special installer.

- **Install the unit securely in a place which can bear the weight of the unit.**

When installed in an insufficient strong place, the unit could fall causing injury.

- **Use the specified wires to connect the indoor and outdoor units securely and attach the wires firmly to the terminal block connecting sections so the stress of the wires is not applied to the sections.**

Incomplete connecting and fixing could cause fire.

- **Do not use intermediate connection of the power cord or the extension cord and do not connect many devices to one AC outlet.**

It could cause a fire or an electric shock due to defective contact, defective insulation, exceeding the permissible current, etc.

- **Check that the refrigerant gas due not leak after installation has completed.**

If refrigerant gas leaks indoors, and comes into contact with the fire of a fan heater, space heater, stove, etc., harmful substances will be generated.

- **Perform the installation securely referring to the installation manual.**

Incomplete installation could cause a personal injury due to fire, electric shock, the unit falling or leakage of water.

- **Perform electrical work according to the installation manual and be sure to use an exclusive circuit.**

If the capacity of the power circuit is insufficient or there is insufficient electrical work, it could result in a fire or an electric shock.

- **Attach the electrical cover to the indoor unit and the service panel to the outdoor unit securely.**

If the electrical cover in the indoor unit and/or the service panel in the outdoor unit are not attached securely, it could result in a fire or an electric shock due to dust water, etc.

- **Be sure to use the part provided or specified parts for the installation work.**

The use of defective parts could cause an injury due to a fire, an electric shock, the unit falling, leakage of water, etc.

- **Be sure to cut off the main power in case of setting up the indoor electronic control P.C. board or wiring works.**

It could cause an electric shock.

- **The appliance shall be installed in accordance with national wiring regulations.**

- **When installing or relocating the unit, make sure that no substance other than the specified refrigerant (R410A) enters the refrigerant circuit.**

Any presence of foreign substance such as air can cause abnormal pressure rise or an explosion.

## ⚠ CAUTION

- **Perform earthing.**

Do not connect the earth wire to a gas pipe, water pipe, lightning rod or telephone earth wire. Defective earthing could cause an electric shock.

- **Do not install the unit in a place where an inflammable gas leaks.**

If gas leak and accumulate in the area surrounding the unit, it could cause an explosion.

- **Fasten a flare nut with a torque wrench as specified in this manual.**

When fastened too tight, a flare nut may broken after a long period and cause a leakage of refrigerant.

- **Install an earth leakage breaker depending on the installation place (Where it is humid).** If a earth leakage breaker is not installed, it could cause an electric shock.

- **Perform the drainage/piping work securely according to the installation manual.**

If there is a defect in the drainage/piping work, water could drop from the unit and household goods could be wet and damaged.

# 2. INSTALLATION DIAGRAM & ACCESSORIES

## Before installation

This installation manual is only for the outdoor unit installation. In installing the indoor units, refer to the installation manual attached to each indoor unit. Any structural alternations necessary for the installation must comply with the local building code requirements.

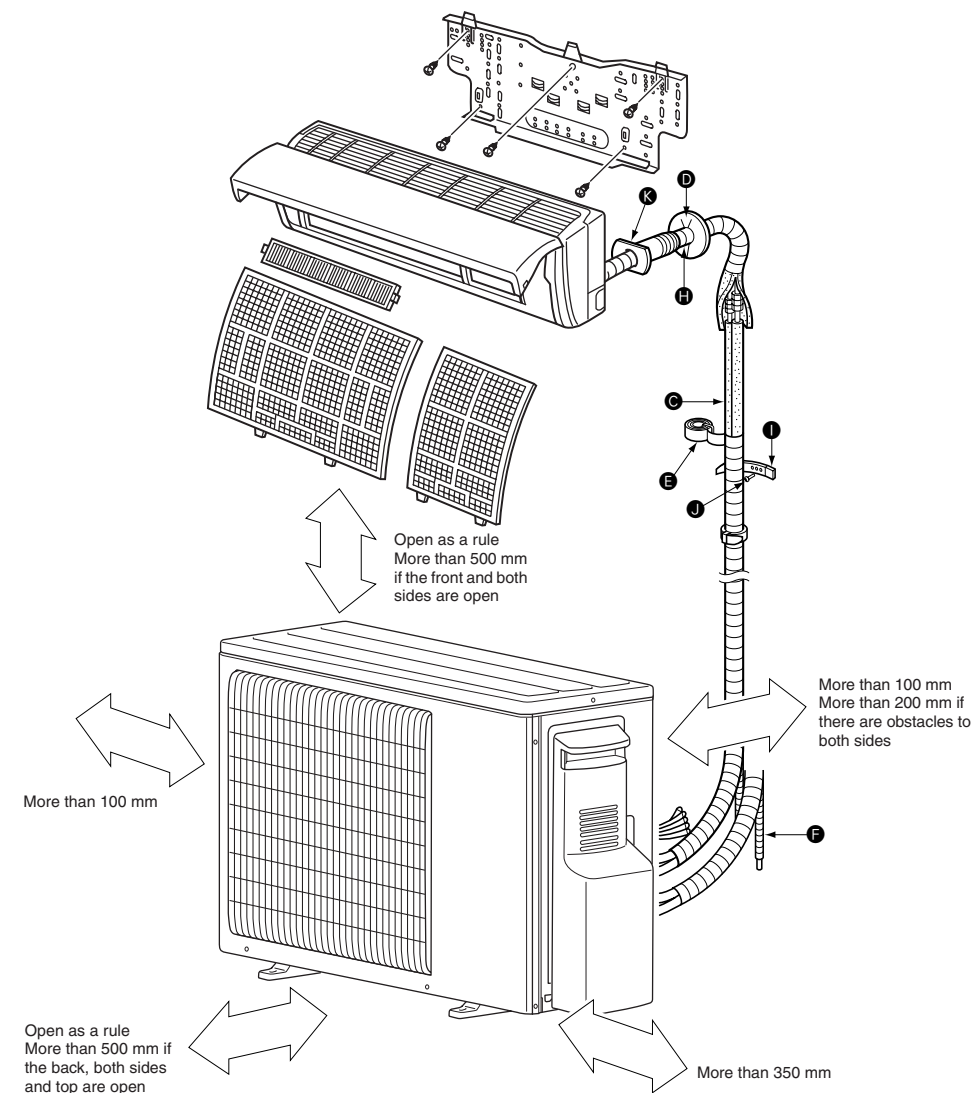

### Note:

The dimensions given along the arrows above are required to guarantee the air conditioner's performance. Install the unit in as wide a place as possible for later service or repairs.

### 3. SELECTING THE INSTALLATION LOCATION

#### ACCESSORIES

Check the following parts before installation.

<Outdoor unit>

①	Drain socket	1
---	--------------	---

#### Parts to be locally procured

Ⓐ	Power supply cord (3-core 2.5 mm <sup>2</sup> )	1
Ⓑ	Indoor/outdoor unit connecting wire (4-core 1.0 mm <sup>2</sup> /1.5 mm <sup>2</sup> )	1
Ⓒ	Extension pipe According to "Selecting pipe size"	1
Ⓓ	Wall hole cover	1
Ⓔ	Piping tape	1
Ⓕ	Extension drain hose (or soft vinyl chloride hose of 15 mm in internal dia. or hard vinyl chloride pipe VP16)	1
Ⓖ	Refrigeration oil	Little amount
Ⓗ	Putty	1
Ⓘ	Pipe fixing band (The number depends on the pipe length.)	2 to 7
Ⓝ	Fixing screw for ① (The number depends on the pipe length.)	2 to 7
Ⓚ	Wall hole sleeve	1
Ⓛ	Soft vinyl chloride hose of 25 mm in internal dia. or hard vinyl chloride pipe VP25	1

#### NOTE:

- Do not use the drain socket and the drain cap in the cold region.  
Drain may freeze and it makes the fan stop.

- The "Q'ty" for Ⓑ to Ⓚ in the above table is the quantity to be used per indoor unit.

#### ⚠ WARNING:

Be sure to use specified accessories and supplied parts for installation work. If there is some deficiency in parts, it may cause a risk of fire, electric shock, injury by a unit fall or water leakage.

#### Constraints On Indoor Unit Installation

You should note that indoor unit that can be connected to this outdoor unit have the following constraints on them.

- Indoor units with model numbers 22, 25 and 35 can be connected. Refer to the table below for possible indoor unit combinations.

##### MXZ-2A30VA Combination

2 UNIT	22+22	22+25	25+25
--------	-------	-------	-------

##### MXZ-2A40VA Combination

2 UNIT	22+22	22+25	22+35	25+25	25+35
--------	-------	-------	-------	-------	-------

##### MXZ-2A52VA Combination

2 UNIT	22+22	22+25	22+35	25+25	25+35	35+35
--------	-------	-------	-------	-------	-------	-------

- Where it is not exposed to strong wind.
- Where airflow is good and dustless.
- Where it is not exposed to rain and direct sunshine.
- Where neighbours are not annoyed by operation sound or hot air.
- Where rigid wall or support is available to prevent the increase of operation sound or vibration.
- Where there is no risk of combustible gas leakage.
- When installing the unit at a high level, be sure to fix the unit legs.
- Where it is at least 3 m away from the antenna of TV set or radio. Operation of the air conditioner may interfere with radio or TV reception in areas where reception is weak. An amplifier may be required for the affected device.
- Install the unit horizontally.
- Please install it in an area not affected by snowfall or blowing snow. In areas with heavy snow, please install a canopy, a pedestal and/or some baffle boards.

#### Note:

It is advisable to make a piping loop near outdoor unit so as to reduce vibration transmitted from there.

#### ⚠ WARNING:

Be sure to install the unit in a place that well sustains its weight.

Installing in a place with less strength may result in a unit falling, causing a risk of injury.

#### ⚠ CAUTION:

Avoid the following places for installation where air conditioner trouble is liable to occur.

- Where flammable gas could leak.
- Where there is much machine oil.
- Salty places such as the seaside.
- Where sulfide gas is generated such as a hot spring.
- Where there is high-frequency or wireless equipment.

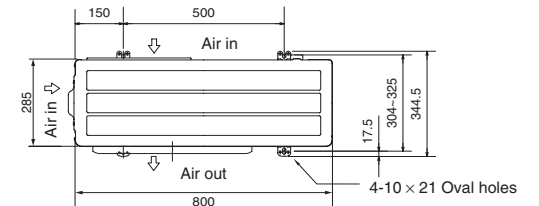

(Unit: mm)

#### Note:

When operating the air conditioner in low outside temperature, be sure to follow the instructions described below.

- Never install the outdoor unit in a place where its air inlet/outlet side may be exposed directly to wind.
- To prevent exposure to wind, install the outdoor unit with its air inlet side facing the wall.
- To prevent exposure to wind, it is recommended to install a baffle board on the air outlet side of the outdoor unit.

## 4. OUTDOOR UNIT INSTALLATION

### 4-1 INSTALLING THE UNIT

- Be sure to fix the unit's legs with bolts when installing it.
- Be sure to install the unit firmly to ensure that it does not fall by an earthquake or a gust.
- Refer to the figure in the right for concrete foundation.

### 4-2 MOUNTING ARRANGEMENT OF DRAIN SOCKET

Please perform the drain piping work only when draining from one place.

**⚠ CAUTION:**  
Do not use drain socket and drain cap in the cold region.  
Drain may freeze and it makes the fan stop.

- ① Please choose one hole to discharge drain and install the drain socket to the hole.
- ② Please close the rest of the holes with the drain caps.
- ③ Please connect a vinyl hose of 25 mm in the inside diameter on the market with the drain socket and lead drain.

### 4-3 INDOOR/OUTDOOR WIRE CONNECTION AND OUTDOOR POWER SUPPLY CORD CONNECTION

- Be sure to lead in the power supply cord **A** to the air conditioner in accordance with the specification table below and "Technical Standards for Electrical Installation".
- Be sure to use special circuits for room air conditioner.

**⚠ CAUTION:**  
Attach an earth leakage breaker according to your installation location. If any breaker is not attached, it may cause a risk of electric shock.

**⚠ WARNING:**  
Be sure to comply with "Technical Standards for Electrical Installation", follow this manual and use special circuits for electrical work. If there is a lack of circuit capacity or some deficiency in installation, it may cause a risk of fire or electric shock.  
Overcurrent that might be produced may include DC substances. Be careful to choose the correct type of overcurrent protection switch.

Rated Voltage	Breaker capacity	Connect to the supply terminals and leave a contact separation of at least 3 mm at each pole to disconnect the source power pole. (When the power switch is shut off, it must disconnect all poles.)
230 V	2A30:10 A 2A40/2A52:15 A	

- Peel off both ends of the cables as shown in the right.
- Take care not to let the cables contact the pipes inside the unit.
- Take enough care to connect the indoor/outdoor unit connecting wire correctly between the respective indoor units and the outdoor unit.
- Make earth wire a little longer than the others. (more than 35 mm)

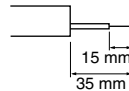

- For the power supply cord and the indoor/outdoor unit connecting wires, be sure to use the ones in compliance with the standards.
- Be sure to push the core until it is hidden and pull each cable to make sure that it is not pulled up. Incomplete insertion may cause a risk of burning the terminal blocks.

Power supply cord Specification	Cable 3-core 2.5 mm <sup>2</sup> , in conformity with Design 60345 IEC 57.
Indoor and Outdoor connecting wire Specification	Cable 4-core 1.0/1.5 mm <sup>2</sup> , in conformity with Design 60345 IEC 57.

This installation manual is only for the outdoor unit installation. In installing the indoor units, refer to the installation manual attached to each indoor unit.

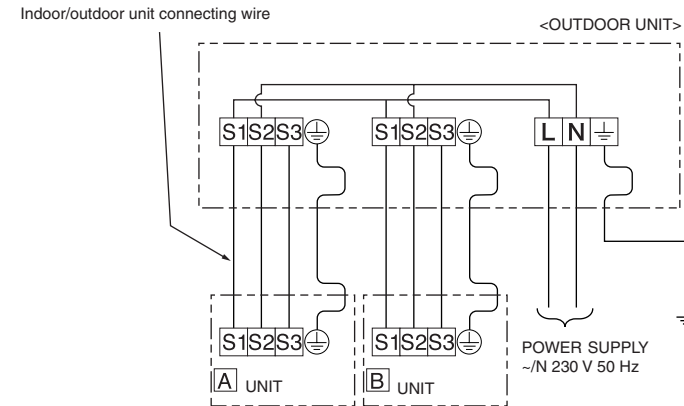

- ① Remove the service panel.
- ② Remove fixing screw of terminal cover.
- ③ Connect the indoor/outdoor wire and power supply cable to the terminal block.
- ④ Replace the terminal cover securely.

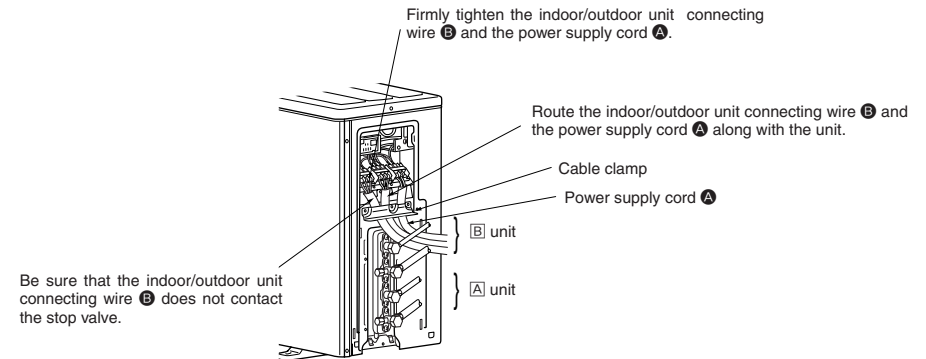

- ⚠ WARNING:**
- Be sure to attach the service panel of the outdoor unit securely, otherwise it may result in a fire or an electric shock from dust or water.
  - Use the indoor/outdoor unit connecting wire that meets the Standards to connect the indoor and outdoor units and fix the wire to the terminal block securely so that no external force is conveyed to the connecting section of the terminal block. Incomplete connection or fixing of the wire could result in a fire.
  - Be sure to attach the terminal block cover on the both indoor and outdoor units. If the terminal block cover is incorrectly attached, it may cause a risk of fire or electric shock due to dust or water penetration.

## 5. INDOOR/OUTDOOR UNITS CONNECTION FINISHING AND TEST RUN

### 5-1 FLARED CONNECTIONS

#### PIPE LENGTH AND HEIGHT DIFFERENCE

Limits	2A30VA	2A40VA	2A52VA
Pipe length per indoor unit	15 m max.	20 m max.	20 m max.
Total pipe length for multi-system	20 m max.	30 m max.	30 m max.
Height difference	10 m max.	*15 m max.	*15 m max.
No. of bends per indoor unit	15 max.	20 max.	20 max.
Total No. of bends for multi-system	20 max.	30 max.	30 max.

\* If the outdoor unit is installed higher than the indoor unit, max. height difference is reduced to 10 m.

Refrigerant adjustment ..... If pipe length exceeds 20 m, additional refrigerant (R410A) charge is required. (The outdoor unit is charged with refrigerant for total pipe length up to 20 m.)

Pipe length	Up to 20 m	No additional charge is required.
	Exceeding 20 m	Additional charge is required. (Refer to the table below.)
Refrigerant to be added	20 g/m × (refrigerant piping length(m)-20)	

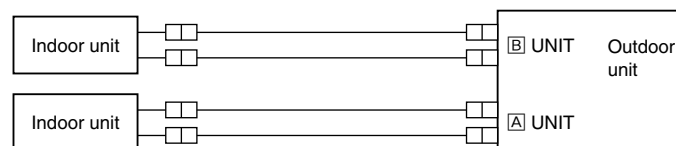

• For pipe size, see the table below.

#### SELECTING PIPE SIZE

The diameter of connection pipes differs according to the type and capacity of indoor units. Match the diameters of connection pipes for indoor and outdoor units according to the following table.

Model name	Pipe size for indoor unit		Allowable connection pipe size
22	Liquid pipe	ø6.35 mm	ø6.35 mm
25	Gas pipe	ø9.52 mm	ø9.52 mm
35			

#### MXZ-2A30VA MXZ-2A40VA MXZ-2A52VA

Valve size for outdoor unit		
A UNIT	Liquid pipe	ø6.35 mm
	Gas pipe	ø9.52 mm
B UNIT	Liquid pipe	ø6.35 mm
	Gas pipe	ø9.52 mm

### PIPING PREPARATION

① If you use commercially available copper pipes, use the following table for pipe specifications.

	Outside diameter	Wall thickness
Liquid pipe	ø6.35 mm	0.8 mm
Gas pipe	ø9.52 mm	0.8 mm

② For insulation material, use 8 mm-thick heat-insulating expanded polyethylene with a specific gravity of 0.045.

③ Ensure that the 2 refrigerant pipes are insulated to prevent condensation.

④ Refrigerant pipe bending radius must be 100 mm or more.

#### ⚠ CAUTION:

**Be sure to use the insulation of specified thickness. Excessive thickness may cause incorrect installation of the indoor unit and lack of thickness may cause dew dripage.**

### 5-2 FLARING WORK

• Main cause of gas leakage is defect in flaring work.  
Perform flaring work correctly in the following procedure.

#### 1. Pipe cutting

• Cut the copper pipe correctly with pipe cutter.

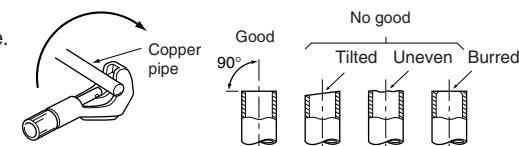

#### 2. Burrs removal

• Completely remove all burrs from the cut cross section of the pipe.  
• Put the end of the copper pipe downward to prevent burrs from dropping in the pipe.

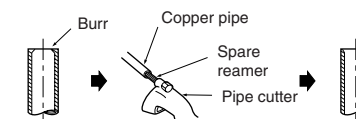

#### 3. Putting nut on

• Remove flare nuts attached to indoor and outdoor units, then put them on pipe having completed burr removal.  
(not possible to put them on after flaring work)  
• Flare nut for R410A pipe may differ from R22 pipe depending on the diameter of pipe.

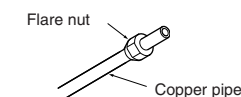

#### 4. Flaring work

- Perform flaring work using flaring tool as shown in the right.

Outside diameter	A (mm)		
	Flare tool for R410A clutch type	Conventional flare tool	
		Clutch type	Wing nut type
ø6.35 mm	0 to 0.5	1.0 to 1.5	1.5 to 2.0
ø9.52 mm	0 to 0.5	1.0 to 1.5	1.5 to 2.0

Firmly hold copper pipe in a die in the dimension shown in the table above.

#### 5. Check

- Compare the flared work with the figure below.
- If flare is noted to be defective, cut off the flared section and perform flaring work again.

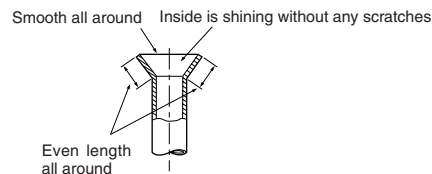

### 5-3 PIPE CONNECTION

#### Note:

Fasten a flare nut with a torque wrench as specified in the table below.

When fastened too tight, a flare nut may be broken after a long period and cause a leakage of refrigerant.

#### 1. Indoor unit connection

- Connect both liquid pipe and gas pipe to indoor unit.
  - Apply a thin coat of refrigeration oil to the seat surface of pipe.
  - For connection, align the center of both pipe and union, then tighten the first 3 to 4 turns in flare nut by hand.
  - For tightening the union part of the indoor unit side, use the table below as a standard and tighten the flare nut with two wrenches. Excessive tightening damages the flared section.

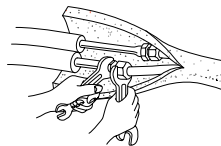

Pipe diameter	Tightening torque	
	N·m	kgf·cm
ø6.35 mm	13.7 to 17.7	140 to 180
ø9.52 mm	34.3 to 41.2	350 to 420



#### 2. Outdoor unit connection

- Connect pipes to the pipe joint part of the stop valve in the same method as the indoor unit.
  - For tightening, use the same tightening torque applied for indoor unit and tighten the flare nut with torque wrench or spanner.

#### INSULATION AND TAPING

- Cover piping joints with pipe cover.
- For outdoor unit side, surely insulate every piping including valves.
- Using piping tape , apply taping starting from the entry of outdoor unit.
- Fix the end of piping tape  with adhesive tape.
- When piping has to be arranged through above ceiling, closet or area where the temperature and humidity are high, wind additional commercially sold insulation for prevention of condensation.

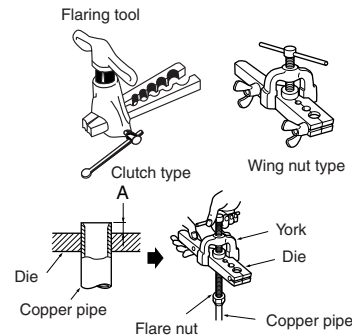

### 5-4 PURGING PROCEDURES • LEAK TEST

- Perform the manifold valve work securely according to the installation manual of the manifold valve.

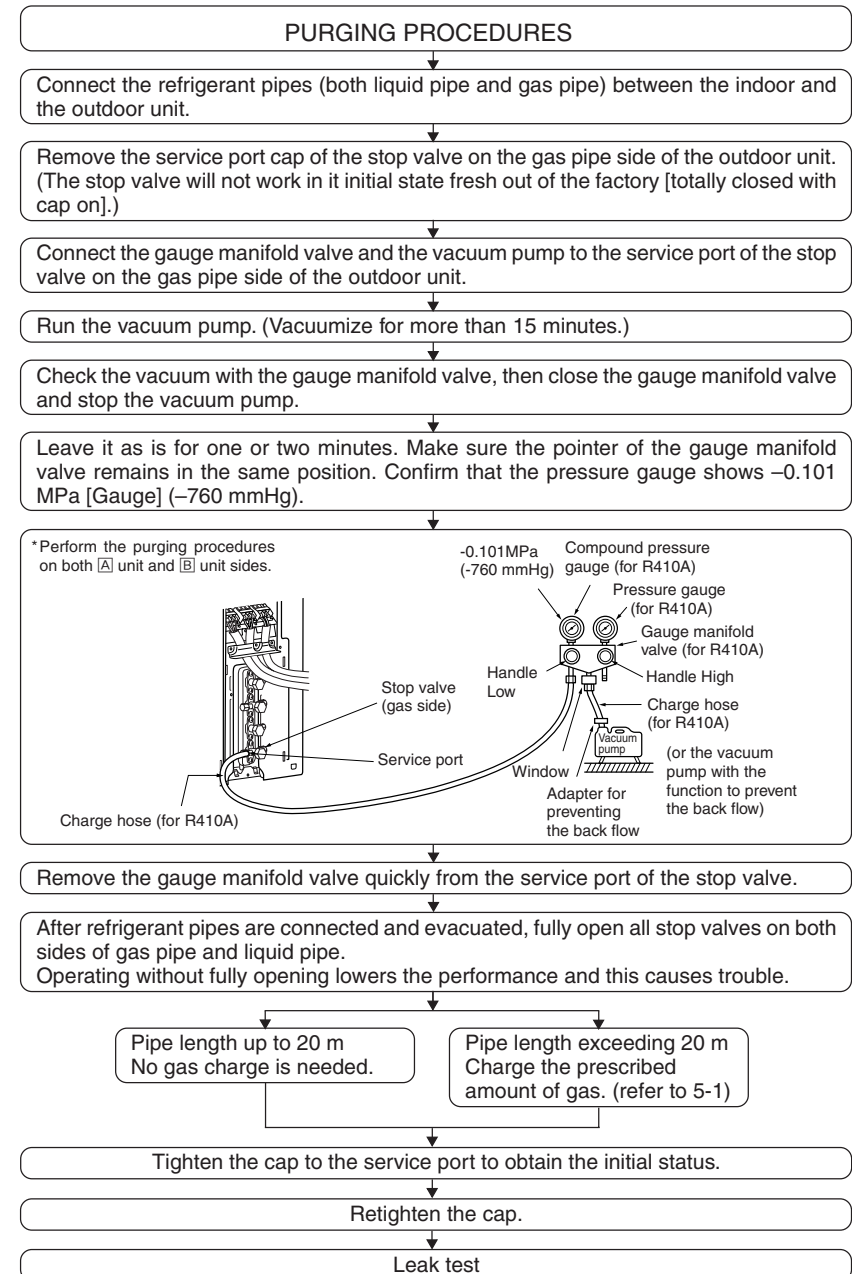



**⚠ WARNING:**

When installing or moving the unit, do not mix anything other than specified refrigerant (R410A) into the refrigerating cycle. If air is mixed, it may cause the refrigerating cycle to get abnormally high temperature, causing a risk of burst.

	Tightening torque	
	N·m	kgf·cm
Cap for service port	13.7 to 17.7	140 to 180
Cap for stop valve	19.6 to 29.4	200 to 300

## 5-5 EARTHING WORK

Put the earth circuit to the ground in accordance with “Technical Standards for Electrical Installation”.

**⚠ CAUTION:**

Do not connect the earth cable to any gas pipe, water pipe, lightning rod or telephone earth cable. If there is some deficiency in earthing work, it may cause a risk of electric shock.

The product incorporates a frequency inverter and so requires earthing in order to observe electric charge and noise caused by static electricity.

## 5-6 LOCKING THE OPERATION MODE OF THE AIR CONDITIONER (COOL, DRY, HEAT)

- Description of the function:  
With this function, you can lock the operation mode of the outdoor unit. Once the operation mode is locked to either COOL/DRY mode or HEAT mode, the air conditioner operates in that mode only.

- \* Initial setting is required to activate this function. Please explain about this function to your customers and ask them whether they want to use it.

### [How to lock the operation mode]

- Be sure to turn off the main power for the air conditioner before making the setting.
- Set the 2nd Dip Switch of SW1 on the outdoor controller board to ON to enable this function.
- To lock the operation mode in COOL/DRY mode, set the 1st Dip Switch of SW1 on the outdoor controller board to OFF. To lock the operation in HEAT mode, set the same switch to ON.
- Turn on the main power for the air conditioner.

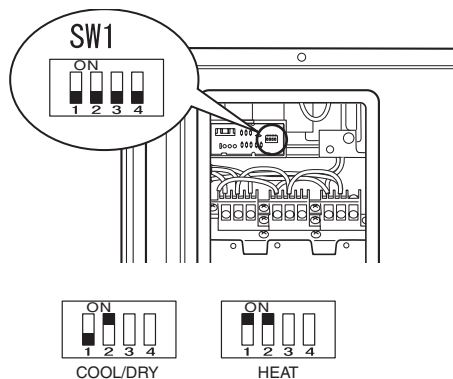

## 5-7 LOWERING THE OPERATING NOISE OF THE OUTDOOR UNIT

- Description of the function:  
With this function, you can lower the operating noise of the outdoor unit when the operation load is small, for example, during nighttime in COOL mode. However, please note that the cooling and heating capacity can also be lowered if this function is activated.

- \* Initial setting is required to activate this function. Please explain about this function to your customers and ask them whether they want to use it.

### [How to lower the operating noise]

- Be sure to turn off the main power for the air conditioner before making the setting.
- Set the 3rd Dip Switch of SW1 on the outdoor controller board to ON to enable this function.
- Turn on the main power for the air conditioner.

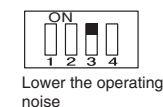
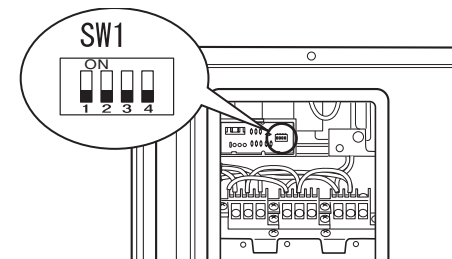

## 5-8 CHECKING AFTER INSTALLATION

After finishing the installation, check the following items again by marking .

- Have special circuits been provided?
- Is power supply voltage as specified?
- Has indoor/outdoor connecting wire been inserted into terminal block?
- Has indoor/outdoor connecting wire been secured firmly?
- Has intermediary connection between power cable and indoor/outdoor connecting wire been carried out?
- Is combination of connection pipes and indoor/outdoor connecting wire correct (Room A, Room B, Room C, Room D)?
- Is earth cable connection correct?
- Has leak test been carried out?
- Has air purge been carried out?
- Is stop valve fully open?
- Has drain discharge been checked?
- Is insulation over connection pipe joints correct?
- Is strength of installation location well enough?
- Have all of ⚠ WARNING and ⚠ CAUTION items in “1. THE FOLLOWING SHOULD ALWAYS BE OBSERVED FOR SAFETY” been checked?

## 5-9 GAS CHARGE

Perform gas charge to unit.

- Connect gas cylinder to the service port of stop valve.
- Perform air purge of the pipe (or hose) coming from refrigerant gas cylinder.
- Replenish specified amount of the refrigerant, while operating the air conditioner for cooling.

**Note:**

In case of adding refrigerant, comply with the quantity specified for the refrigerating cycle.

**⚠ CAUTION:**

**When charging the refrigerant system with additional refrigerant, be sure to use liquid refrigerant. Adding gas refrigerant may change the composition of the refrigerant in the system and affect normal operation of the air conditioner. Also, charge the system slowly, otherwise the compressor will be locked.**

To maintain the high pressure of the gas cylinder, warm the gas cylinder with warm water (under 40°C) during cold season. But never use naked fire or steam.

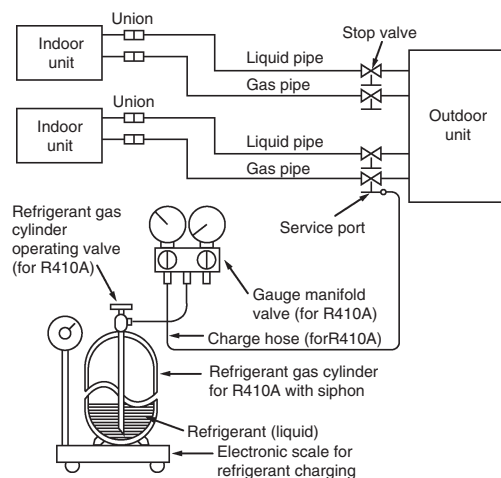

## 5-10 TEST RUN

- Be sure to perform the test run for each unit. Make sure each indoor unit operates properly following the installation manual attached to the unit.
- If you perform the test run for all indoor units at once, you cannot detect any erroneous connection, if any, of the refrigerant pipes and the indoor/outdoor unit connecting wires.

### About the restart protective mechanism

Once the compressor stops, the restart preventive device operates so the compressor will not operate for 3 minutes to protect the air conditioner.

## 5-11 EXPLANATION TO THE CUSTOMER

- Recommend the customer to read the OPERATING INSTRUCTIONS carefully.
- Using the OPERATING INSTRUCTIONS for each unit, explain the following to the customer, how to control temperature, how to remove the air filters, how to remove or put the remote controller in the remote controller holder, how to clean, precautions for operation, etc.

If the customer (user) is absent, explain to the purchaser (owner, building's controller, etc) about those points.