



MSZ-GA60VA

Inverter Heat Pump

R410A Wall Mounted System

This model has been completely redesigned and features the new Catechin filter system. It offers industry leading noise levels and also includes a wide swing & long airflow mode.

- **Anti-Allergy Enzyme filter is optional**



Pictures not to scale

Product Details

MSZ-GA60VA Indoor Unit

Capacity (kW):	
Heating (Nominal) (Low - High)	6.80 (0.90 - 8.10)
Cooling (Nominal) (Low - High)	6.00 (0.90 - 6.70)
Heating (UK) (Low - High)	5.65 (0.75 - 6.75)
Cooling (UK) (Low - High)	5.95 (0.90 - 6.65)
SHF R410A (Nominal)	0.79
COP / EER (Nominal)	3.51 / 3.11
Energy Label Heating / Cooling	B / B
Width - mm	1100
Depth - mm	258
Height - mm	325
Weight - kg	16
Airflow (m3/min) (Heating /Cooling) - Lo-Mi-Hi	8.7-13.1-17.2 / 8.7-12.8-17.2
Noise (dBA) (Heating/Cooling) - Lo-Mi-Hi	32-40-54 / 32-40-54
Pipe Size Gas mm (in)	15.88 (5/8)
Pipe Size Liquid mm (in)	6.35 (1/4)
Electrical Supply	Fed by Outdoor Unit
Phase	Single
Fuse Rating (BS88) - HRC (A)	6
Interconnecting Cable No. Cores	4

MUZ-GA60VA Outdoor Unit

Width - mm	840
Depth - mm	330
Height - mm	850
Weight - kg	53
Noise (dBA) (Heating/Cooling) - Lo-Hi	53-55 / 51-53
Electrical Supply	220-240v, 50Hz
Phase	Single
Fuse Rating (BS88) - HRC (A)	20
SystemPower Input (kW) - Heating (Nominal)	1.94
SystemPower Input (kW) - Cooling (Nominal)	1.93
SystemPower Input (kW) - Heating (UK)	1.77
SystemPower Input (kW) - Cooling (UK)	1.54
Starting Current (A)	8.93
SystemRunning Current (A) - Heating / Cooling	8.93 / 8.83
Mains Cable No. Cores	3
Max Pipe Length (m)	30
Max Height Difference (m)	15
Charge (kg) - 7m	1.8

Dimensions

MSZ-GA60VA

Upper View >



Front View >

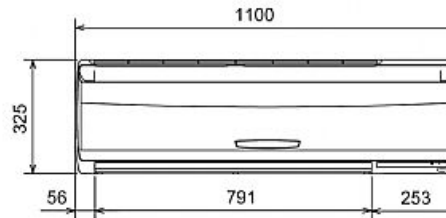

Side View >

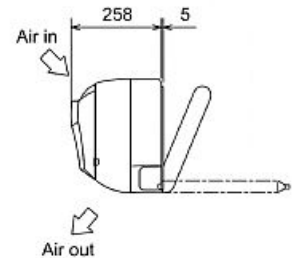

MUZ-GA60VA

Upper View >

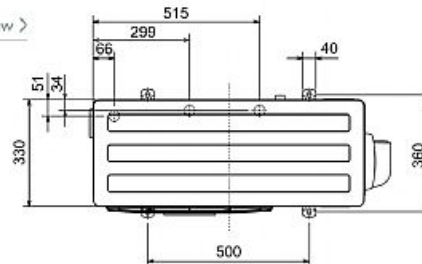

Front View >

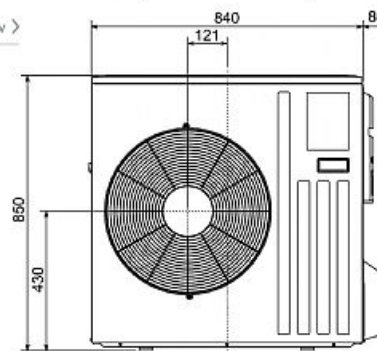

Side View >

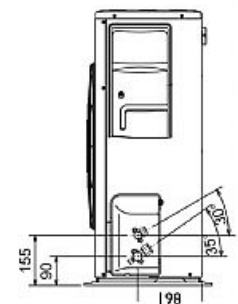

Telephone: 01707 282880

Email: air.conditioning@meuk.mee.com Website: <http://www.mitsubishielectric.co.uk/aircon>

Tel:
Fax:

Mitsubishi Electric reserves the right to make any variation in technical specification to the equipment described, or to withdraw or replace products without prior notification or public announcement.

