



MSZ-FD25VA

Inverter Heat Pump

R410A Wall Mounted System

The MSZ-FD Series is our most efficient M Series wall mounted unit to date. These high COP models feature the new Plasma Duo filter system. These models also offer industry leading noise levels and has a distinctively styled front panel that not only looks appealing but also helps make the cleaning of the unit easier.

Also incorporated is an I-See Sensor, providing even temperature distribution and further reducing energy consumption.



Pictures not to scale

Product Details

MSZ-FD25VA Indoor Unit

Capacity (kW):	
Heating (Nominal) (Low - High)	3.20 (1.50 - 6.30)
Cooling (Nominal) (Low - High)	2.50 (1.10 - 3.50)
Heating (UK) (Low - High)	2.65 (1.25 - 5.25)
Cooling (UK) (Low - High)	2.50 (1.10 - 3.45)
SHF R410A (Nominal)	0.85
COP / EER (Nominal)	5.33 / 5.15
Energy Label Heating / Cooling	A / A
Width - mm	798
Depth - mm	257
Height - mm	295
Weight - kg	12
Airflow (m ³ /min) (Heating /Cooling) - Lo-Mi1-Mi2-Hi	4.5-6.7-9.2-12.1 / 4.6-6.3-8.6-11.2
Noise (dBA) (Heating /Cooling) - Lo-Mi1-Mi2-Hi	20-29-36-43 / 20-29-36-42
Pipe Size Gas mm (in)	9.52 (3/8)
Pipe Size Liquid mm (in)	6.35 (1/4)
Electrical Supply	Fed by Outdoor Unit
Phase	Single
Fuse Rating (BS88) - HRC (A)	6
Interconnecting Cable No. Cores	4

MUZ-FD25VABH Outdoor Unit

Width - mm	800
Depth - mm	285
Height - mm	550
Weight - kg	36
Noise (dBA) (Heating /Cooling)	46 / 46
Electrical Supply	220-240v, 50Hz
Phase	Single
Fuse Rating (BS88) - HRC (A)	10
SystemPower Input (kW) - Heating (Nominal)	0.6
SystemPower Input (kW) - Cooling (Nominal)	0.485
SystemPower Input (kW) - Heating (UK)	0.546
SystemPower Input (kW) - Cooling (UK)	0.388
Starting Current (A)	2.9
SystemRunning Current (A) - Heating / Cooling	2.9 / 2.4
Mains Cable No. Cores	3
Max Pipe Length (m)	20
Max Height Difference (m)	12
Charge (kg) - 7m	1.15

Dimensions

MSZ-FD25VA

Upper View >

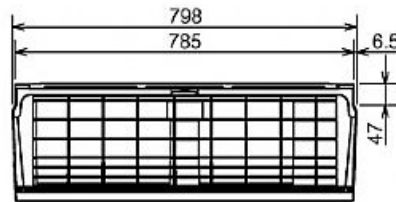

Front View >

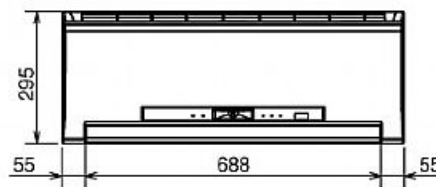

Side View >

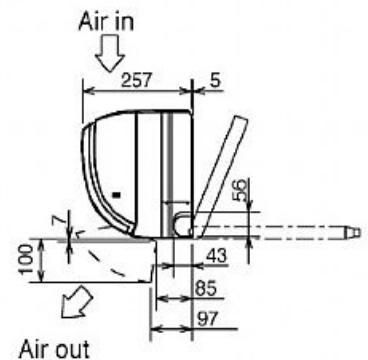

MUZ-FD25VABH

Upper View >

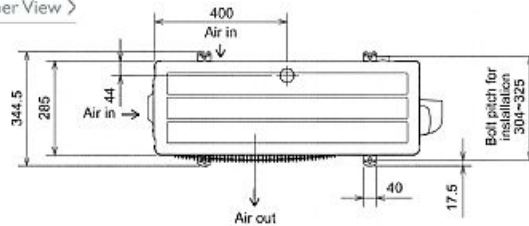

Front View >

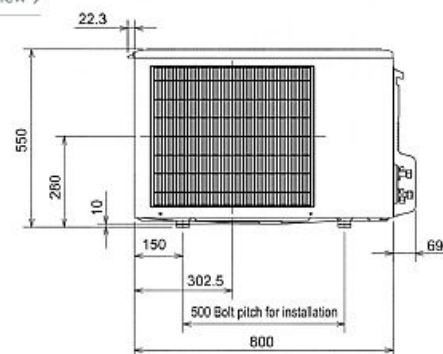

Side View >

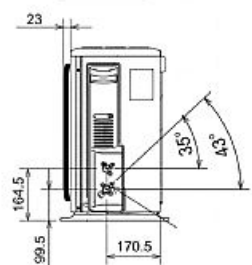

Telephone: 01707 282880

Email: air.conditioning@meuk.mee.com Website: <http://www.mitsubishielectric.co.uk/aircon>

Mitsubishi Electric reserves the right to make any variation in technical specification to the equipment described, or to withdraw or replace products without prior notification or public announcement.

Tel:
Fax:

