

## SPLIT-TYPE AIR CONDITIONERS

### INDOOR UNIT

MSZ-FD25VA MSZ-FD35VA  
MSZ-FD25VAS MSZ-FD35VAS



#### OPERATING INSTRUCTIONS

For user

- To use this unit correctly and safely, be sure to read these operating instructions before use.

#### BEDIENUNGSANLEITUNG

For den Anwender

- Für einen sicheren und ordnungsgemäßen Gebrauch des Geräts unbedingt diese Bedienungsanleitung vor der Inbetriebnahme durchlesen.

#### NOTICE D'UTILISATION

A l'attention des clients

- Pour avoir la certitude d'utiliser cet appareil correctement et en toute sécurité, veuillez lire cette notice d'instructions avant de mettre le climatiseur sous tension.

#### BEDIENINGSINSTRUCTIES

Voor de klant

- Om dit apparaat correct en veilig te kunnen gebruiken moet u deze bedieningsinstructies voor gebruik eerst doorlezen.

#### MANUAL DE INSTRUCCIONES

Para los clientes

- Para utilizar esta unidad de forma correcta y segura, lea previamente estas instrucciones de funcionamiento.

#### LIBRETTO D'ISTRUZIONI

Per gli utenti

- Per utilizzare correttamente ed in tutta sicurezza questo apparecchio, leggere il presente libretto d'istruzioni prima dell'uso.

#### ΟΔΗΓΙΕΣ ΛΕΙΤΟΥΡΓΙΑΣ

Για το χρήστη

- Για να χρησιμοποιήσετε αυτή τη μονάδα σωστά και με ασφάλεια, βεβαιωθείτε ότι έχετε διαβάσει αυτό το εγχειρίδιο οδηγιών πριν από τη χρήση.

#### INSTRUÇÕES DE OPERAÇÃO

Para o utilizador

- Para utilizar esta unidade correctamente e com segurança, certifique-se de que lê estas instruções de operação antes da utilização.

#### BETJENINGSVEJLEDNING

Til kunden

- Læs denne betjeningsvejledningen før brug, så enheden bruges korrekt og sikkert.

#### BRUKSANVISNING

För användaren

- Läs bruksanvisningen innan enheten tas i bruk så att den används säkert och på rätt sätt.

#### ÇALIŞTIRMA TALİMATLARI

Kullanıcı için

- Bu üniteyi doğru ve güvenli bir biçimde kullanmak için, kullanmadan önce bu işletim talimatlarını okuduğunuzdan emin olun.

#### ИНСТРУКЦИИ ПО ЭКСПЛУАТАЦИИ

Для пользователя

- В целях правильной и безопасной эксплуатации данного устройства обязательно перед его использованием прочтите настоящее руководство по эксплуатации.

English

Deutsch

Français

Nederlands

Español

Italiano

Ελληνικά

Português

Dansk

Svenska

Türkçe

Русский



# CONTENTS

■ SAFETY PRECAUTIONS	1
■ DISPOSAL	2
■ NAME OF EACH PART	3
■ PREPARATION BEFORE OPERATION	3
■ AREA SETTING	4
■ SELECTING OPERATION MODES	5
■ FAN SPEED AND AIRFLOW DIRECTION ADJUSTMENT	6
■ ECONO COOL OPERATION	7
■ TIMER OPERATION (ON/OFF TIMER)	7
■ PLASMA OPERATION	7
■ CLEAN OPERATION	7
■ CLEANING	8
■ WHEN YOU THINK THAT TROUBLE HAS OCCURRED	9
■ WHEN THE AIR CONDITIONER IS NOT GOING TO BE USED FOR A LONG TIME	10
■ INSTALLATION PLACE AND ELECTRICAL WORK	10
■ SPECIFICATIONS	10







# SAFETY PRECAUTIONS





- Since rotating parts and parts which could cause an electric shock are used in this product, be sure to read these "Safety Precautions" before use.
- Since the cautionary items shown here are important for safety, be sure to observe them.
- After reading this manual, keep it together with the installation manual in a handy place for easy reference.





## Marks and their meanings

-  **WARNING :** Incorrect handling could cause serious hazard, such as death, serious injury, etc. with a high probability.
-  **CAUTION :** Incorrect handling could cause serious hazard depending on the conditions.



## Meanings of symbols used in this manual



-  : Be sure not to do.
-  : Be sure to follow the instruction.
-  : Never insert your finger or stick, etc.
-  : Never step onto the indoor/outdoor unit and do not put anything on them.
-  : Danger of electric shock. Be careful.
-  : Be sure to disconnect the power supply plug from the power outlet.
-  : Be sure to shut off the power.

 <b>WARNING</b>	
	<p><b>Do not connect the power cord to an intermediate point, use an extension cord, or connect multiple devices to a single AC outlet.</b></p> <ul style="list-style-type: none"> <li>• This may cause overheating, fire, or electric shock.</li> </ul>
	<p><b>Make sure the power plug is free of dirt and insert it securely into the outlet.</b></p> <ul style="list-style-type: none"> <li>• A dirty plug may cause fire or electric shock.</li> </ul>
	<p><b>Do not bundle, pull, or modify the power cord, and do not apply heat or place heavy objects on it.</b></p> <ul style="list-style-type: none"> <li>• This may cause fire or electric shock.</li> </ul>
	<p><b>Do not turn the breaker OFF/ON or disconnect/connect the power plug during operation.</b></p> <ul style="list-style-type: none"> <li>• This may create sparks, which can cause fire.</li> <li>• After the indoor unit is switched OFF with the remote controller, make sure to turn the breaker OFF or disconnect the power plug.</li> </ul>
	<p><b>Do not expose your body directly to cool air for a prolonged length of time.</b></p> <ul style="list-style-type: none"> <li>• This could be detrimental to your health.</li> </ul>
	<p><b>The unit should not be installed, relocated, or repaired by the user.</b></p> <ul style="list-style-type: none"> <li>• An improperly handled air conditioner may cause fire or electric shock.</li> </ul>
 	<p><b>Do not insert your finger, a stick, or other objects into the air inlet or outlet.</b></p> <ul style="list-style-type: none"> <li>• This may cause injury, since the fan inside rotates at high speeds during operation.</li> </ul>





 	<p><b>In case of an abnormal condition (such as a burning smell), stop the air conditioner and disconnect the power plug or turn the breaker OFF.</b></p> <ul style="list-style-type: none"> <li>• A continued operation in the abnormal state may cause a malfunction, fire, or electric shock. In this case, consult your dealer.</li> </ul>
	<p><b>When the air conditioner does not cool or heat, there is a possibility of refrigerant leakage. In this case, consult your dealer. If a repair involves recharging the unit with refrigerant, ask the service technician for details.</b></p> <ul style="list-style-type: none"> <li>• The refrigerant used in the air conditioner is safe. Normally, it does not leak. However, if refrigerant leaks and comes in contact with a heat source such as a fan heater, kerosene heater, or cooking stove, it will create a harmful gas.</li> </ul>
 <b>CAUTION</b>	
	<p><b>Do not touch the air inlet or the aluminum fins of the indoor/outdoor unit.</b></p> <ul style="list-style-type: none"> <li>• This may cause injury.</li> </ul>
	<p><b>Do not use insecticides or flammable sprays on the unit.</b></p> <ul style="list-style-type: none"> <li>• This may cause a fire or deformation of the unit.</li> </ul>
	<p><b>Do not expose pets or houseplants to direct airflow.</b></p> <ul style="list-style-type: none"> <li>• This may cause injury to the pets or plants.</li> </ul>
	<p><b>Do not place other electric appliances or furniture under the indoor/outdoor unit.</b></p> <ul style="list-style-type: none"> <li>• Water may drip down from the unit, which may cause damage or malfunction.</li> </ul>
	<p><b>Do not leave the unit on a damaged installation stand.</b></p> <ul style="list-style-type: none"> <li>• The unit may fall and cause injury.</li> </ul>

# SAFETY PRECAUTIONS

 <b>CAUTION</b>	
	<p><b>Do not step on an unstable bench to operate or clean the unit.</b></p> <ul style="list-style-type: none"> <li>This may cause injury if you fall down.</li> </ul>
	<p><b>Do not pull the power cord.</b></p> <ul style="list-style-type: none"> <li>This may cause a portion of the core wire to break, which may cause overheating or fire.</li> </ul>
	<p><b>Do not charge or disassemble the batteries, and do not throw them into a fire.</b></p> <ul style="list-style-type: none"> <li>This may cause the batteries to leak, or cause a fire or explosion.</li> </ul>
	<p><b>Do not operate the unit for a long time at high humidity (80% RH or more), such as with a door or window left open.</b></p> <ul style="list-style-type: none"> <li>The water condensation in the air conditioner may drip down, wetting or damaging the furniture.</li> </ul>
	<p><b>Do not use the unit for special purposes, such as storing food, raising animals, growing plants, or preserving precision devices or art objects.</b></p> <ul style="list-style-type: none"> <li>This may cause deterioration of quality, or harm to animals and plants.</li> </ul>
	<p><b>Do not expose combustion appliances to direct airflow.</b></p> <ul style="list-style-type: none"> <li>This may cause incomplete combustion.</li> </ul>
	<p><b>Before cleaning the unit, switch it OFF and disconnect the power plug or turn the breaker OFF.</b></p> <ul style="list-style-type: none"> <li>This may cause injury, since the fan inside rotates at high speeds during operation.</li> </ul>
	<p><b>When the unit will be unused for a long time, disconnect the power plug or turn the breaker OFF.</b></p> <ul style="list-style-type: none"> <li>The unit may accumulate dirt, which may cause overheating or fire.</li> </ul>
	<p><b>Replace all batteries of the remote controller with new ones of the same type.</b></p> <ul style="list-style-type: none"> <li>Using an old battery together with a new one may cause overheating, leakage, or explosion.</li> </ul>
	<p><b>If the battery fluid comes in contact with your skin or clothes, wash them thoroughly with clean water.</b></p> <ul style="list-style-type: none"> <li>If the battery fluid comes in contact with your eyes, wash them thoroughly with clean water and immediately seek medical attention.</li> </ul>
	<p><b>Ensure that the area is well-ventilated when the unit is operated together with a combustion appliance.</b></p> <ul style="list-style-type: none"> <li>Inadequate ventilation may cause oxygen starvation.</li> </ul>
	<p><b>Turn the breaker OFF when you hear thunder and there is a possibility of a lightning strike.</b></p> <ul style="list-style-type: none"> <li>The unit may be damaged if lightning strikes.</li> </ul>
	<p><b>After the air conditioner is used for several seasons, perform inspection and maintenance in addition to normal cleaning.</b></p> <ul style="list-style-type: none"> <li>Dirt or dust in the unit may create an unpleasant odor or clog the drain passage, and cause water to leak from the indoor unit. Consult your dealer for inspection and maintenance, which require specialized knowledge and skills.</li> </ul>

	<p><b>Do not operate switches with wet hands.</b></p> <ul style="list-style-type: none"> <li>This may cause electric shock.</li> </ul>
	<p><b>Do not clean the air conditioner with water or place an object that contains water, such as a flower vase, on it.</b></p> <ul style="list-style-type: none"> <li>This may cause fire or electric shock.</li> </ul>
	<p><b>Do not step on or place any object on the outdoor unit.</b></p> <ul style="list-style-type: none"> <li>This may cause injury if you or the object falls down.</li> </ul>

## For installation

 <b>WARNING</b>	
	<p><b>Consult your dealer for installing the air conditioner.</b></p> <ul style="list-style-type: none"> <li>It should not be installed by the user since installation requires specialized knowledge and skills. An improperly installed air conditioner may cause water leakage, fire, or electric shock.</li> </ul>
	<p><b>Provide a dedicated power supply for the air conditioner.</b></p> <ul style="list-style-type: none"> <li>A non-dedicated power supply may cause overheating or fire.</li> </ul>
	<p><b>Do not install the unit where flammable gas could leak.</b></p> <ul style="list-style-type: none"> <li>If gas leaks and accumulates around the outdoor unit, it may cause an explosion.</li> </ul>
	<p><b>Earth the unit correctly.</b></p> <ul style="list-style-type: none"> <li>Do not connect the earth wire to a gas pipe, water pipe, lightning rod, or a telephone ground wire. Improper earthing may cause electric shock.</li> </ul>
 <b>CAUTION</b>	
	<p><b>Install an earth leakage breaker depending on the installation location of the air conditioner (such as highly humid areas).</b></p> <ul style="list-style-type: none"> <li>If an earth leakage breaker is not installed, it may cause electric shock.</li> </ul>
	<p><b>Ensure that the drain water is properly drained.</b></p> <ul style="list-style-type: none"> <li>If the drain passage is improper, water may drip down from the indoor/outdoor unit, wetting and damaging the furniture.</li> </ul>
<p><b>In case of an abnormal condition</b> Immediately stop operating the air conditioner and consult your dealer.</p>	

# DISPOSAL

To dispose of this product, consult your dealer.



Fig. 1

### Note:

This symbol mark is for EU countries only.  
This symbol mark is according to the directive 2002/96/EC Article 10 Information for users and Annex IV, and/or to the directive 2006/66/EC Article 20 Information for end-users and Annex II.

Your MITSUBISHI ELECTRIC product is designed and manufactured with high quality materials and components which can be recycled and/or reused. This symbol means that electrical and electronic equipment, batteries and accumulators, at their end-of-life, should be disposed of separately from your household waste.

If a chemical symbol is printed beneath the symbol (Fig. 1), this chemical symbol means that the battery or accumulator contains a heavy metal at a certain concentration. This will be indicated as follows:

Hg: mercury (0,0005%), Cd: cadmium (0,002%), Pb: lead (0,004%)

In the European Union there are separate collection systems for used electrical and electronic products, batteries and accumulators.

Please, dispose of this equipment, batteries and accumulators correctly at your local community waste collection/recycling centre.

Please, help us to conserve the environment we live in!

# NAME OF EACH PART

## Indoor unit

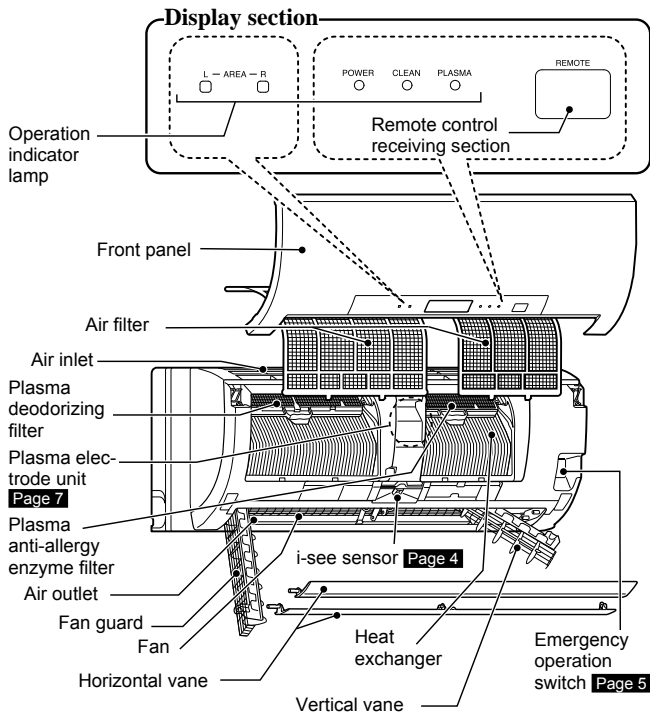

## Outdoor unit

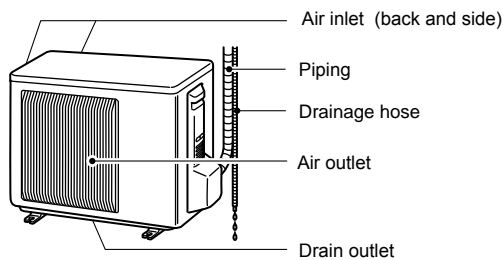

Outdoor units may be different in appearance.

## Remote controller

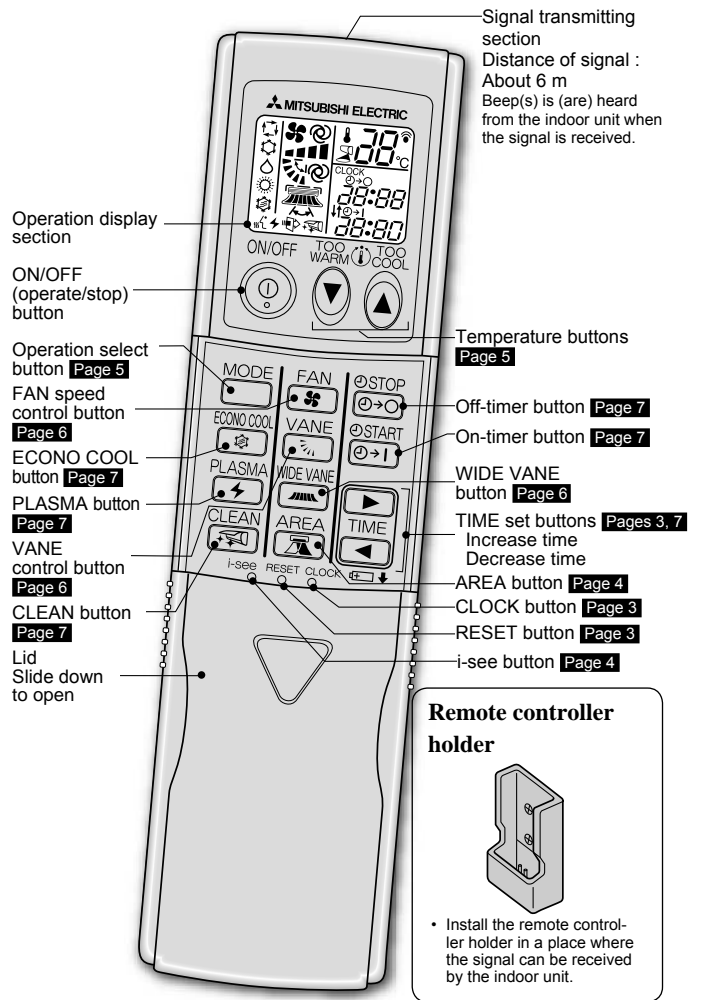

Only use the remote controller provided with the unit.  
Do not use other remote controllers.

# PREPARATION BEFORE OPERATION

**Before operation:** Insert the power supply plug into the power outlet and/or turn the breaker on.

## Installing the remote controller batteries

Be sure to set the installation position before installing the batteries. **Page 4**

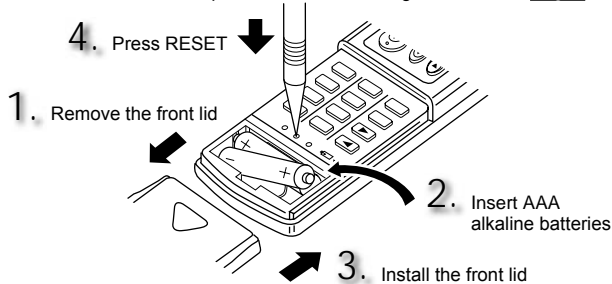

- Make sure the polarity of the batteries is correct.
- Do not use manganese batteries. The remote controller could malfunction.
- Do not use rechargeable batteries.
- Replace all batteries with new ones of the same type.
- Batteries can be used for approximately 1 year. However, batteries with expired shelf lives last shorter.
- Press RESET gently using a thin instrument.  
If the RESET button is not pressed, the remote controller may not operate correctly.

## Setting current time

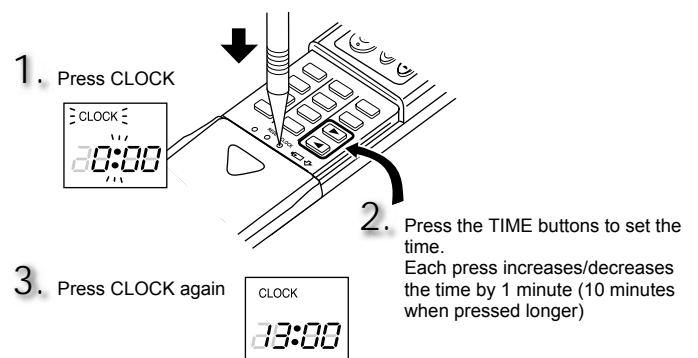

- Press CLOCK gently using a thin instrument.

# PREPARATION BEFORE OPERATION

## Setting the installation position

Be sure to set the slide switch inside the remote controller in accordance with the installed position of the indoor unit.

### Installation position:

- Left: Distance to objects (wall, cabinet, etc.) is less than 50 cm to the left
- Center: Distance to objects (wall, cabinet, etc.) is more than 50 cm to the left and right
- Right: Distance to objects (wall, cabinet, etc.) is less than 50 cm to the right

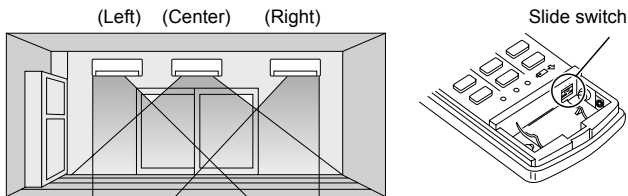

Area	Left	Center	Right
Slide switch	L . C . R	L . C . R	L . C . R
Remote controller display			

Press during COOL mode to activate i-see control operation.

- Press gently using a thin instrument.
- lights. (Operation display section)
- The default setting is "active".

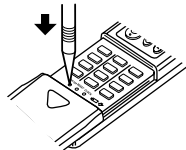

Press again to release i-see control operation.

## i-see control operation

The sensors constantly measure the room and floor/wall temperature to automatically adjust to the set temperature by estimating the temperature actually perceived by a person inside the room ("sensible temperature").

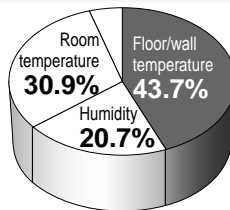

## i-see sensor

When the AREA setting is not activated, the sensing range of the move eye sensor differs depending on the installation location of the air conditioner.

Installation position	Left	Center	Right
Sensing range			

**Note:** Do not touch the i-see sensor. This may cause malfunction of the i-see sensor.

# AREA SETTING

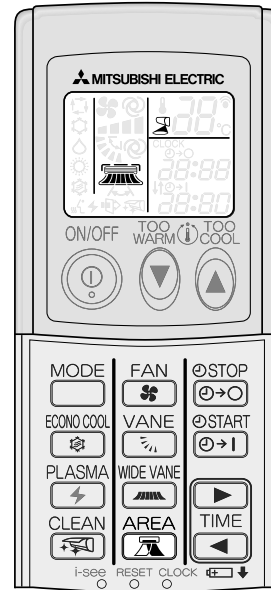

Press to select AREA. Each press changes AREA in the following order:

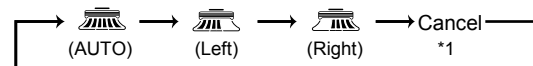

- The i-see control operation has to be active to select AREA.
- Horizontal airflow direction cannot be selected when AREA is set.
- \*1 Horizontal airflow direction set by . **Page 6**

Press until "Cancel" is selected to release AREA setting.

- Pressing also releases AREA setting.

## Area

(AUTO) ....The i-see sensor detects temperature disparities, efficiently cooling/heating the whole room.

In COOL mode:

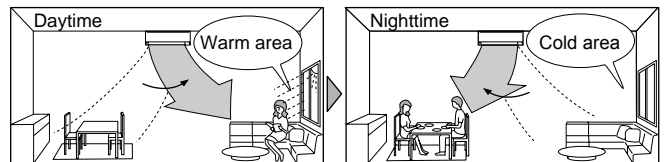

(LEFT) / (RIGHT)  
Select the desired area to be air conditioned.

## Indoor unit display

Horizontal airflow direction:

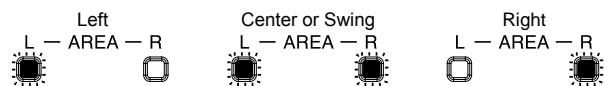

Lighted Not lighted

# SELECTING OPERATION MODES

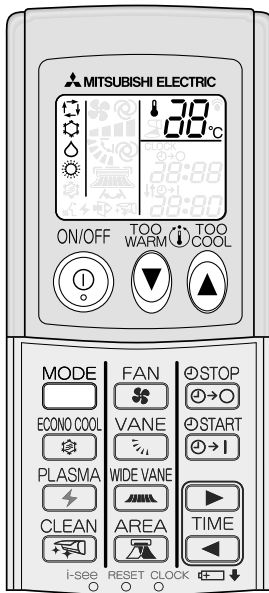

**1** Press to start the operation.

**2** Press to select operation mode. Each press changes mode in the following order:

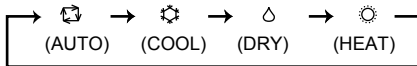

**3** Press or to set the temperature. Each press raises or lowers the temperature by 1°C.

Press to stop the operation.  
 • The same setting is selected the next time by simply pressing .

## Multi system operation

Two or more indoor units can be operated by one outdoor unit. When several indoor units are operated simultaneously, cooling and heating operations cannot be done at the same time. When COOL is selected with one unit and HEAT with another or vice versa, the unit operated later becomes standby mode. The power lamp blinks (display section).

## AUTO mode (Auto change over)

The unit selects the operation mode according to the difference between the room temperature and the set temperature. During AUTO mode, the unit changes mode (COOL↔HEAT) when the room temperature is 2°C away from the set temperature for more than 15 minutes.

Note:

### Multi system operation

Two or more indoor units can be operated by one outdoor unit. When several indoor units are operated simultaneously, the unit may not be able to switch operation mode between COOL and HEAT. In this case, the indoor unit becomes standby mode.

## COOL mode

Enjoy cool air at your desired temperature.

Note:

Do not operate COOL mode at very low outside temperatures (less than -10°C). Water condensed in the unit may drip and wet or damage furniture, etc.

## DRY mode

Dehumidify your room. The room may be cooled slightly. Temperature cannot be set during DRY mode.

## HEAT mode

Enjoy warm air at your desired temperature.

## Emergency operation

### When the remote controller cannot be used...

Emergency operation can be activated by pressing the emergency operation switch (E.O.SW) on the indoor unit.

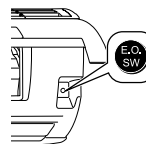

Each time the E.O.SW is pressed, the operation changes in the following order:

#### Operation indicator lamp

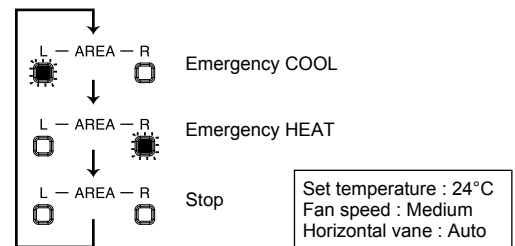

Note:

The first 30 minutes of operation is test run. Temperature control does not work, and fan speed is set to High.

## Auto restart function

If a power failure occurs or the main power is turned off during operation, "Auto restart function" automatically starts operation in the same mode as the one set with the remote controller just before the shutoff of the main power. When timer is set, timer setting is cancelled and the unit starts operation when power is resumed.

If you do not want to use this function, please consult the service representative because the setting of the unit needs to be changed.

# FAN SPEED AND AIRFLOW DIRECTION ADJUSTMENT

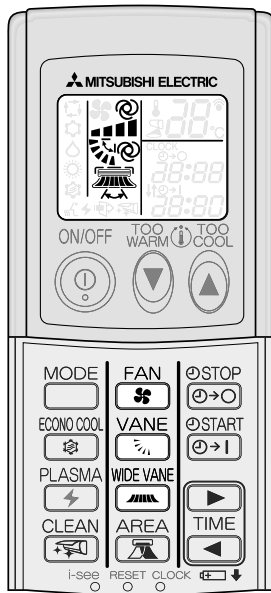

## Vertical airflow direction

### ⊗ (AUTO)

The vane is set to the most efficient airflow direction. COOL/DRY:horizontal position. HEAT:downward position.

### ☼ (Manual)

For efficient air conditioning, select upper position for COOL/DRY, and lower position for HEAT. During COOL/DRY, when the vane is set to position (4) or (5), the vane automatically moves to horizontal position after 1 hour to prevent any condensation from dripping.

### ↕ (Swing)

The vane moves up and down intermittently.

**FAN**  
Press to select fan speed. Each press changes fan speed in the following order:



- Two short beeps are heard from the indoor unit when set to AUTO.
- Use (Super High) to cool/heat the room more efficiently. It is recommended to lower the fan speed once the room is cool/warm.
- If the operating sound of the air conditioner disturbs your sleep, use (Low).

**VANE**  
Press to select vertical airflow direction. Each press changes airflow direction in the following order:

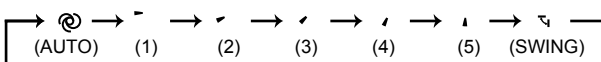

- Two short beeps are heard from the indoor unit when set to AUTO.

**WIDE VANE**  
Press to select horizontal airflow direction. Each press changes airflow direction in the following order:

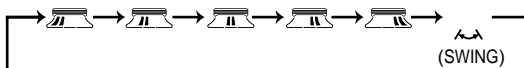

# ECONO COOL OPERATION

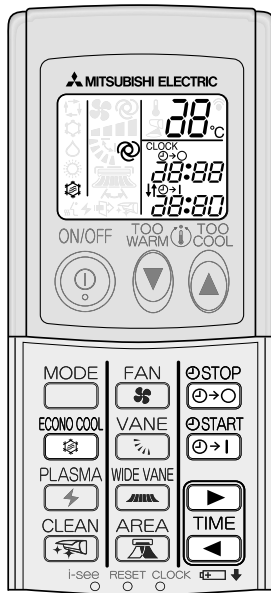

**ECONO COOL**  
Press during COOL mode **page 5** to start ECONO COOL operation.  
The unit performs swing operation vertically in various cycle according to the temperature of the unit. Set temperature is set 2°C higher automatically.

**ECONO COOL**  
Press again to cancel ECONO COOL operation.  
• ECONO COOL operation also is canceled when the VANE button is pressed.

**What is "ECONO COOL"?**  
Swing air flow (change of air flow) makes you feel cooler than constant air flow. So, even though the set temperature is automatically set 2°C higher, it is possible to perform cooling operation with keeping comfort. As a result, energy can be saved.

# TIMER OPERATION (ON/OFF TIMER)

**1** Press or during operation to set the timer.

(ON timer) : The unit turns ON at the set time.

(OFF timer) : The unit turns OFF at the set time.

- \* or blinks.
- \* Make sure that the current time is set correctly. **Page 3**

**2** Press (Increase) and (Decrease) to set the time of timer.  
Each press increases or decreases the set time by 10 minutes.

**3** Press or again to cancel timer.

**Note:**  
• ON and OFF timers can be set together. mark indicates the order of timer operations.  
• If power failure occurs while ON/OFF timer is set, see **page 5** "Auto restart function".

# PLASMA OPERATION

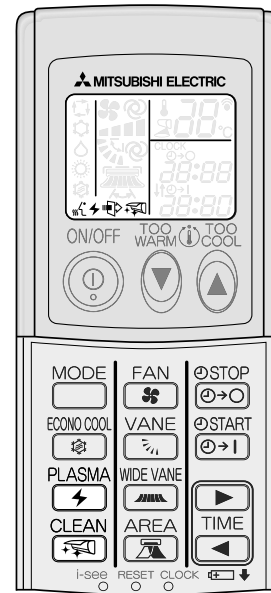

**PLASMA**  
Press to start PLASMA operation.  
• PLASMA lamp turns on. (Display section)

**PLASMA**  
Press again to cancel PLASMA operation.

**What is "PLASMA operation"?**  
Plasma operation consists of deodorizing and air purifying features. Particles of odor-releasing substances are absorbed and decomposed by the plasma deodorizing filter. Particles of allergens such as pollens and house dust are collected by the plasma anti-allergy filter. These filters work with negative ions generated by the plasma electrode unit.

# CLEAN OPERATION

**CLEAN**  
Press to activate CLEAN operation.  
• The unit performs CLEAN operation when it is stopped with the button or OFF timer after COOL/DRY operation. CLEAN lamp turns on. (Display section)  
• CLEAN operation is not performed when: COOL is operated less than 3 minutes/ DRY is operated less than 6 minutes.

**CLEAN**  
Press again to deactivate CLEAN operation.  
• Pressing does not deactivate CLEAN operation.

**What is "CLEAN operation"?**  
CLEAN operation function helps to keep the unit clean and prevents mold growth by generating small amount of ozone (<sup>1</sup>) and performing FAN operation for about 40 minutes. It is recommended to keep CLEAN operation active at all times.  
<sup>1</sup> About 0.01 ppm at the air outlet. This is the same level found in nature, such as in forests, and there is no effect on the human body.

**Note:**  
• Fan is stopped for the first 15 minutes of CLEAN operation.  
• During multi system operation, air from the unit may become warm. In this case, CLEAN operation is cancelled automatically to prevent undesirable rise in room temperature.



# CLEANING

## Instructions:

- Switch off the power supply or turn off the breaker before cleaning.
- Be careful not to touch the metal parts with your hands.
- Do not use benzene, thinner, polishing powder, or insecticide.
- Use only diluted mild detergents.
- Do not expose parts to direct sunlight, heat, or fire to dry.
- Do not use water hotter than 50°C.

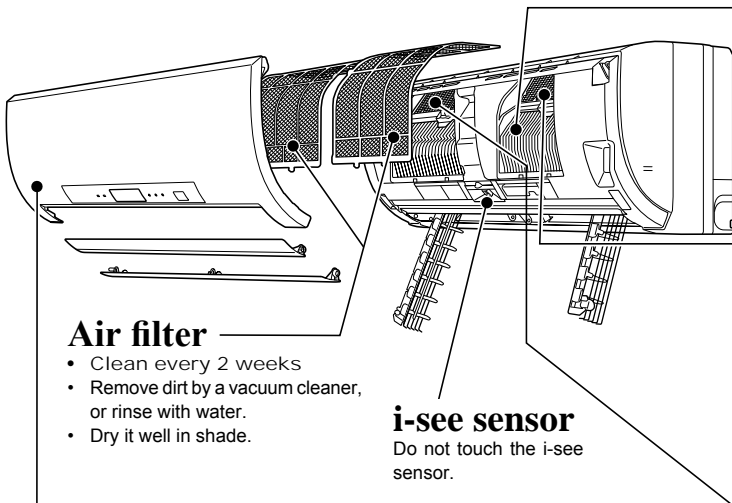

### Air filter

- Clean every 2 weeks
- Remove dirt by a vacuum cleaner, or rinse with water.
- Dry it well in shade.

**i-see sensor**  
Do not touch the i-see sensor.

### Heat exchanger

- Wear gloves to protect your hands.
- Use the QUICK CLEAN KIT (option).  
Parts Number **MAC-093SS-E**
- Refer to the instructions described in the QUICK CLEAN KIT for details.

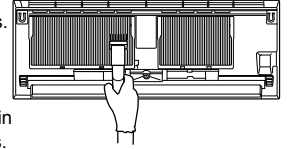

### Plasma anti-allergy enzyme filter

- Every 3 months:
- Remove dirt by a vacuum cleaner.
- When dirt cannot be removed by vacuum cleaning:
- Soak the filter together with its frame in lukewarm water and rinse it.
  - After washing, dry it well in shade.

- Every year:
- Replace it with a new air cleaning filter for best performance.
  - Parts Number **MAC-417FT-E**

### Front panel

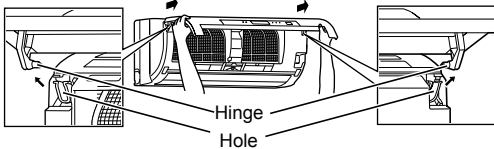

1. Lift the front panel until a "click" is heard.
2. Hold the hinges and pull to remove as shown in the above illustration.
  - Wipe with a soft dry cloth or rinse it with water.
  - Do not soak it in water for more than two hours.
  - Dry it well in shade.

3. Install the panel by following the removal procedure in reverse. Close the front panel securely and press the positions indicated by the arrows.

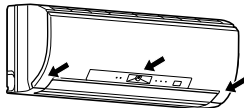

### Plasma deodorizing filter

- Every 3 months:
- Remove dirt by a vacuum cleaner, or soak the filter in lukewarm water (30 to 40°C) for about 15 minutes. Rinse well.
  - After washing, dry it well in shade.
  - Deodorizing feature recovers by cleaning the filter.
- When dirt or smell cannot be removed by cleaning:
- Replace it with a new air cleaning filter.
  - Parts Number **MAC-307FT-E**

### Note:

- Clean the filters regularly for best performance and to reduce power consumption.
- Do not touch the i-see sensor.

## Air outlet and Fan (before cleaning, make sure that the fan is stopped)

- 1 Turn the horizontal vanes downward. Then, remove the upper vane as shown in ① and ②.

- Repeat ① and ② for the lower vane.

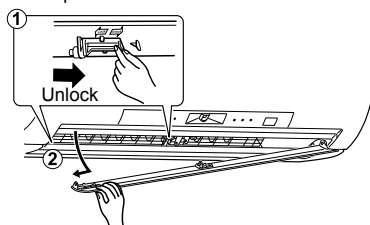

- 2 Swing out the two vertical vanes one by one.

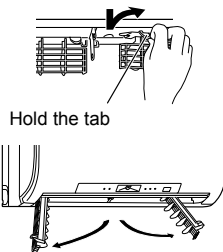

- 3 Clean the air outlet and fan.
  - Wipe with a soft dry cloth.

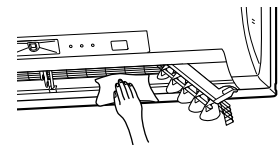

- 4 Put the vertical vanes back to their original positions correctly one by one, into their respective guide.
  - Push the vanes until they click into place.

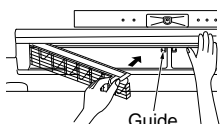

- 5 Install the horizontal vane by following the removal procedure in reverse.
  - If the horizontal vane is not installed correctly, all LED lamps blink when power is turned on.

- Clean the fan.
- Use the QUICK CLEAN KIT (option).  
Parts Number **MAC-093SS-E**
  - Refer to the instructions described in the QUICK CLEAN KIT for details.

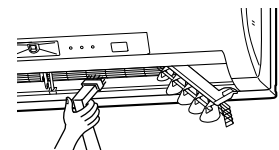

### Note:

- Do not apply excessive force to the fan or fan guard.

# WHEN YOU THINK THAT TROUBLE HAS OCCURRED

Even if these items are checked, when the unit does not recover from the trouble, stop using the air conditioner and consult your dealer.

Symptom	Explanation & Check points
<b>Indoor Unit</b>	
The unit cannot be operated.	<ul style="list-style-type: none"> <li>Is the breaker turned on?</li> <li>Is the power supply plug connected?</li> <li>Is the ON timer set? <a href="#">Page 7</a></li> </ul>
All LED lamps on the indoor unit are blinking.	<ul style="list-style-type: none"> <li>Are the horizontal vanes installed correctly? <a href="#">Page 8</a></li> </ul>
The horizontal vane does not move.	<ul style="list-style-type: none"> <li>Are the horizontal vane and the vertical vane installed correctly? <a href="#">Page 8</a></li> <li>Is the fan guard deformed?</li> </ul>
The unit cannot be operated for about 3 minutes when restarted.	<ul style="list-style-type: none"> <li>This protects the unit according to instructions from the microprocessor. Please wait.</li> </ul>
Mist is discharged from the air outlet of the indoor unit.	<ul style="list-style-type: none"> <li>The cool air from the unit rapidly cools moisture in the air inside the room, and it turns into mist.</li> </ul>
The swing operation of the HORIZONTAL VANE is suspended for a while, then restarted.	<ul style="list-style-type: none"> <li>This is for the swing operation of the HORIZONTAL VANE to be performed normally.</li> </ul>
The air flow direction changes during operation. The direction of the horizontal vane cannot be adjusted with the remote controller.	<ul style="list-style-type: none"> <li>When the unit is operated in COOL or DRY mode, if the operation continues with air blowing down for 0.5 to 1 hour, the direction of the air flow is automatically set to position (1) to prevent water from condensing and dripping.</li> <li>In the heating operation, if the air flow temperature is too low or when defrosting is being done, the horizontal vane is automatically set to horizontal position.</li> </ul>
The operation is stopped for about 10 minutes in the heating operation.	<ul style="list-style-type: none"> <li>Defrosting of the outdoor unit is being done. Since this is completed in max. 10 minutes, please wait. (When the outside temperature is too low and humidity is too high, frost is formed.)</li> </ul>
The unit starts operation by itself when the main power is turned on, though it isn't operated with the remote controller.	<ul style="list-style-type: none"> <li>These models are equipped with an auto restart function. When the main power is turned off without stopping the unit with the remote controller and is turned on again, the unit starts operation automatically in the same mode as the one set with the remote controller just before the shutoff of the main power. Refer to "Auto restart function" <a href="#">page 5</a>.</li> </ul>
The operation does not stop, or air is blown even when the ON/OFF button is pressed.	<ul style="list-style-type: none"> <li>Is the CLEAN lamp lighted? When the CLEAN lamp is lighted, CLEAN operation is performed. <a href="#">Page 7</a></li> </ul>
CLEAN lamp is lighted.	<ul style="list-style-type: none"> <li>CLEAN operation is performed. <a href="#">Page 7</a></li> </ul>
<b>Multi system</b>	
The indoor unit which is not operating becomes warm and a sound, similar to water flowing, is heard from the unit.	<ul style="list-style-type: none"> <li>A small amount of refrigerant continues to flow into the indoor unit even though it is not operating.</li> </ul>
When heating operation is selected, operation does not start right away.	<ul style="list-style-type: none"> <li>When operation is started during defrosting of outdoor unit is done, it takes a few minutes (max. 10 minutes) to blow out warm air.</li> </ul>
<b>Outdoor Unit</b>	
The fan of the outdoor unit does not rotate even though the compressor is running. Even if the fan starts to rotate, it stops soon.	<ul style="list-style-type: none"> <li>When the outside temperature is low during cooling operation, the fan operates intermittently to maintain sufficient cooling capacity.</li> </ul>
Water leaks from the outdoor unit.	<ul style="list-style-type: none"> <li>During COOL and DRY operations, pipe or pipe connecting sections are cooled and this causes water to condense.</li> <li>In the heating operation, water condensed on the heat exchanger drips down.</li> <li>In the heating operation, the defrosting operation makes water frozen on the outdoor unit melt and drip down.</li> </ul>

Symptom	Explanation & Check points
<b>Outdoor Unit</b>	
White smoke is discharged from the outdoor unit.	<ul style="list-style-type: none"> <li>In the heating operation, vapor generated by the defrosting operation looks like white smoke.</li> </ul>
<b>Remote controller</b>	
The display on the remote controller does not appear or it is dim. The indoor unit does not respond to the remote control signal.	<ul style="list-style-type: none"> <li>Are the batteries exhausted? <a href="#">Page 3</a></li> <li>Is the polarity (+, -) of the batteries correct? <a href="#">Page 3</a></li> <li>Are any buttons on the remote controller of other electric appliances being pressed?</li> </ul>
<b>Does not cool or heat</b>	
The room cannot be cooled or heated sufficiently.	<ul style="list-style-type: none"> <li>Is the temperature setting appropriate? <a href="#">Page 5</a></li> <li>Is the fan setting appropriate? Please change fan speed to higher setting. <a href="#">Page 6</a></li> <li>Is the filter clean? <a href="#">Page 8</a></li> <li>Is the fan or heat exchanger of the indoor unit clean? <a href="#">Page 8</a></li> <li>Are there any obstacles blocking the air inlet or outlet of the indoor or outdoor unit?</li> <li>Is a window or door open?</li> </ul>
The room cannot be cooled sufficiently.	<ul style="list-style-type: none"> <li>When a ventilation fan or a gas cooker is used in a room, the cooling load increases, resulting in an insufficient cooling effect.</li> <li>When the outside temperature is high, the cooling effect may not be sufficient.</li> </ul>
The room cannot be heated sufficiently.	<ul style="list-style-type: none"> <li>When the outside temperature is low, the heating effect may not be sufficient.</li> </ul>
Air does not blow out soon in the heating operation.	<ul style="list-style-type: none"> <li>Please wait as the unit is preparing to blow out warm air.</li> </ul>
<b>Airflow</b>	
The air from the indoor unit smells strange.	<ul style="list-style-type: none"> <li>Is the filter clean? <a href="#">Page 8</a></li> <li>Is the fan or heat exchanger of the indoor unit clean? <a href="#">Page 8</a></li> <li>The unit may suck in an odor adhering to the wall, carpet, furniture, cloth, etc. and blow it out with the air.</li> <li>During PLASMA operation, you may smell ozone that is generated in small quantities from the plasma electrode unit. This is not a malfunction.</li> </ul>
<b>Sound</b>	
Cracking sound is heard.	<ul style="list-style-type: none"> <li>This sound is generated by the expansion/contraction of the front panel, etc. due to change in temperature.</li> </ul>
"Bubbling" sound is heard.	<ul style="list-style-type: none"> <li>This sound is heard when the outside air is absorbed from the drain hose by turning on the range hood or the ventilation fan, making water flowing in the drain hose to spout out. This sound is also heard when the outside air blows into the drain hose in case the outside wind is strong.</li> </ul>
Mechanical sound is heard from the indoor unit.	<ul style="list-style-type: none"> <li>This is the switching sound in turning on/off the fan or the compressor.</li> </ul>
The sound of water flowing is heard.	<ul style="list-style-type: none"> <li>This is the sound of refrigerant or condensed water flowing in the unit.</li> </ul>
Hissing sound is sometimes heard.	<ul style="list-style-type: none"> <li>This is the sound when the flow of refrigerant inside the unit is switched.</li> </ul>

In the following cases, stop using the air conditioner and consult your dealer.

- When water leaks or drips from the indoor unit.
- When the POWER lamp blinks.
- When the breaker trips frequently.
- The remote control signal is not received in a room where an electronic ON/OFF type fluorescent lamp (inverter-type fluorescent lamp, etc.) is used.
- Operation of the air conditioner interferes with radio or TV reception. An amplifier may be required for the affected device.
- When an abnormal sound is heard.

## WHEN THE AIR CONDITIONER IS NOT GOING TO BE USED FOR A LONG TIME

- 1 Set to the highest temperature in manual COOL mode, and operate for 3 to 4 hours. **Page 5**  
This dries the inside of the unit.
- 2 Press  to stop the operation.
- 3 Turn off the breaker and/or disconnect the power supply plug.
- 4 Remove all batteries from the remote controller.

## When using the air conditioner again:

- 1 Clean the air filter. **Page 8**
- 2 Check that the air inlet and outlet of the indoor and outdoor units are not blocked.
- 3 Check that the earth is connected correctly.

## INSTALLATION PLACE AND ELECTRICAL WORK

### Installation place

Avoid installing the air conditioner in the following places.

- Where there is much machine oil.
- Salty places such as the seaside.
- Where sulfide gas is generated such as a hot spring.
- Where oil is splashed or where the area is filled with oily smoke.
- Where there is high-frequency or wireless equipment.
- Where the air from the outdoor unit air outlet is blocked.
- Where the operation sound or air from the outdoor unit does not bother the house next door.

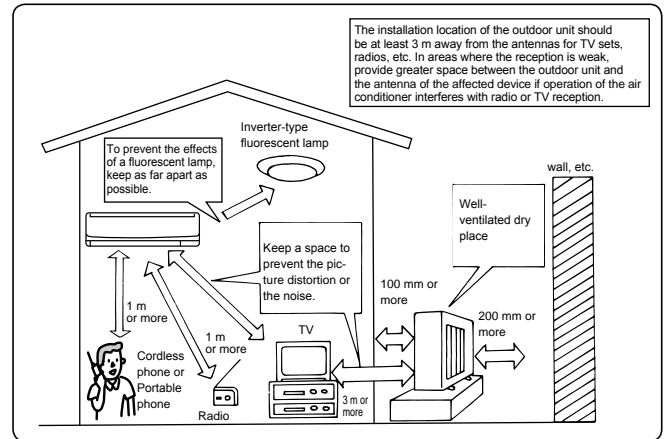

### Electrical work

- Provide an exclusive circuit for the power supply of the air conditioner.
- Be sure to observe the breaker capacity.

If you have any questions, consult your dealer.

## SPECIFICATIONS

Model	Indoor		MSZ-FD25VA		MSZ-FD25VA		MSZ-FD25VA		MSZ-FD35VA		MSZ-FD35VA		MSZ-FD35VA	
	Outdoor		MUZ-FD25VA		MUZ-FD25VAH		MUZ-FD25VABH		MUZ-FD35VA		MUZ-FD35VAH		MUZ-FD35VABH	
Function			Cooling	Heating	Cooling	Heating	Cooling	Heating	Cooling	Heating	Cooling	Heating	Cooling	Heating
Power supply			~ /N, 230 V, 50 Hz											
Capacity		kW	2.5	3.2	2.5	3.2	2.5	3.2	3.5	4.0	3.5	4.0	3.5	4.0
Input		kW	0.485	0.610	0.485	0.610	0.485	0.600	0.850	0.865	0.835	0.850	0.835	0.840
Weight	Indoor	kg	12						12					
	Outdoor	kg	36						36					
Refrigerant filling capacity (R410A)		kg	1.15						1.15					
IP code	Indoor		IP 20						IP 20					
	Outdoor		IP 24						IP 24					
Permissible excessive operating pressure	LP ps	MPa	1.64						1.64					
	HP ps	MPa	4.15						4.15					
Noise level	Indoor (Super High/High/Med./Low)	dB(A)	42/36/29/20	43/36/29/20	42/36/29/20	43/36/29/20	42/36/29/20	43/36/29/20	43/36/29/21	44/36/29/21	43/36/29/21	44/36/29/21	43/36/29/21	44/36/29/21
	Outdoor	dB(A)	46						47 50 47 50 47 50					

### Guaranteed operating range

		Indoor	Outdoor		
			MUZ-FD25/35VA	MUZ-FD25/35VAH	MUZ-FD25/35VABH
Cooling	Upper limit	32°C DB 23°C WB	46°C DB —	46°C DB —	46°C DB —
	Lower limit	21°C DB 15°C WB	-10°C DB —	-10°C DB —	-10°C DB —
Heating	Upper limit	27°C DB —	24°C DB 18°C WB	24°C DB 18°C WB	24°C DB 18°C WB
	Lower limit	20°C DB —	-15°C DB -16°C WB	-20°C DB -21°C WB	-25°C DB -26°C WB

### Note:

Rating condition  
 Cooling — Indoor: 27°C DB, 19°C WB  
               Outdoor: 35°C DB  
 Heating — Indoor: 20°C DB  
               Outdoor: 7°C DB, 6°C WB

DB: Dry Bulb  
 WB: Wet Bulb



---

HEAD OFFICE: TOKYO BLDG., 2-7-3, MARUNOUCHI, CHIYODA-KU, TOKYO 100-8310, JAPAN

SG79F181H03