

VL-100U-E

Operating Instructions

(For Customer)

Before using this Lossnay Ventilator, please read through these instructions. Keep these instructions in a safe place for future reference.

Do not install the unit yourself. (Safety and performance can not be guaranteed. in the case.)







Essential Safety Precautions

- Before proceeding with operation, please be sure to read “Essential Safety Precautions” as it will tell you how to operate the product properly and safely.
- The displays have the following significance.

	WARNING	This applies to mishandling or mis-operation of the product which may lead to a fatal or serious injury.
---	----------------	--

	CAUTION	This applies to mishandling or mis-operation of the product, which will lead to an injury or damage to your home, household effects, etc.
---	----------------	---

- The graphic symbols have the following significance.

	Prohibited
	Do NOT disassemble.
	Do NOT touch.
	Use is prohibited wherever water is present.
	You must follow the instructions given.
	Disconnect the power plug.

Contents

Page

Before use

Safety precautions	2
When using the unit	3
Names of parts	3

Using the unit







Operation	3
-----------------	---





Maintenance/troubleshooting

Maintenance	4
Troubleshooting	6
After-sales servicing	6
Specifications	6

Safety Precautions

English

 WARNING	
	<ul style="list-style-type: none"> • Do not turn the Lossnay's switch ON or OFF if there is a flammable gas leak. (Sparks from electric contacts may cause explosions.) Open a window and ventilate the room.
	<ul style="list-style-type: none"> • Do not attempt to disassemble or alter the unit. (Fire, electric shock or injury may result.)
	<ul style="list-style-type: none"> • Do not let the unit get wet. (Fire, electric shock may result.) • Do not use the unit in a bathroom or other highly humid location. (Fire or electric shock may result.)
	<ul style="list-style-type: none"> • Use the unit at the rated voltage and within the control capacity range. (Failure to do so may result in fire or electric shock.) • Check there is no dust on the power plug. Insert the plug completely into the socket, making sure it is not loose. (Failure to do so may result in fire or electric shock.) • Make sure the outside air intake opening is positioned so that it will not take in combustion gases or other exhaust. (If intake air is not fresh, oxygen may become depleted in the room.)
	<ul style="list-style-type: none"> • Be sure to remove the power plug from the wall outlet when performing maintenance. Do not insert or remove the power plug with wet hands. (electric shock or injury may result) • If you smell burning, or another malfunction occurs, turn the unit off and remove the power plug. (Continuing operation may result in breakdown, electric shock or fire.)

 CAUTION	
	<ul style="list-style-type: none"> • Do not place combustion equipment in the direct path of the air from the unit. (Incomplete combustion may result in accidents.) • Do not use the unit in excessively hot areas, areas of oily smoke, or near open flames. (Fire may result)
	<ul style="list-style-type: none"> • A fan rotates inside the unit during operation. Never stick anything inside the unit during operation. (injury may result)
	<ul style="list-style-type: none"> • Never attach the unit to the ceiling. (it can only be attached to a wall) • If the power cord becomes damaged, request that your place of purchase repair it. (Not having the cord repaired could result in electric shock.) • Attach parts securely after maintenance. (Dropping parts could result in injury.) • Check that the unit and outdoor weather covers are attached securely. (Rainwater entering the unit could result in electric shock, fire or indoor items getting wet.)
	<ul style="list-style-type: none"> • Never remove the power plug by pulling on the cord. Always grasp the plug itself. (Failure to do so could result in electric shock or fire from a short-circuit.) • Be sure to remove the power plug from the wall outlet when not using the unit for an extended period. (Failure to do so could cause insulation deterioration, resulting in electric shock or fire from a short-circuit.)

When using the unit

- **Do not place objects around the unit.**

The air outlet or intake openings may be blocked or servicing of the Lossnay core may become impossible. It may become impossible to remove the power plug from the wall outlet.

- **Do not use aerosol sprays (such as insect sprays, hair sprays or cleansers) directly on the unit.**

The panel may degenerate or become damaged.

- **Do not obstruct the panel.**

Sufficient ventilation may be impeded.

- **Do not pull the cord diagonally.**

The unit will not operate correctly.

- **To prevent freezing or damage to the Lossnay Core, stop the unit if the outside temperature falls below -10°C or the room's humidity rises above 40%.**

Names of parts

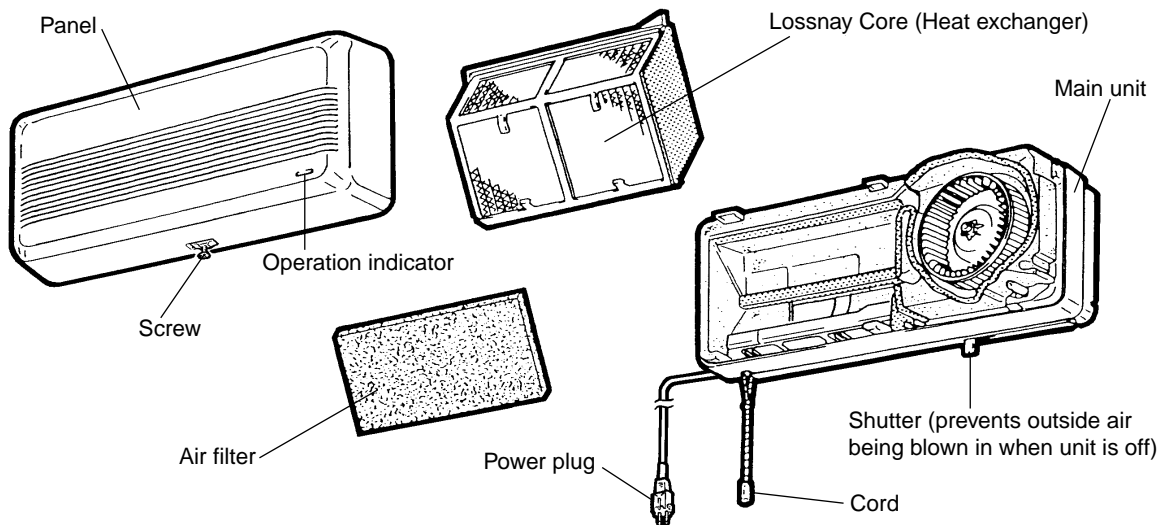

Operation

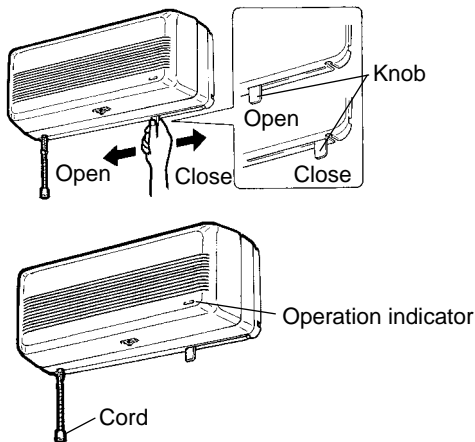

1. Insert the power plug into the wall outlet.
2. Slide the shutter knob to the left (open) position. (The shutter must be open for ventilation.)
3. Pull the cord.

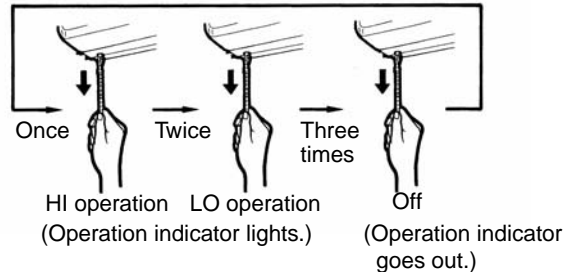

- When the unit is not operating slide the shutter to the closed position if the weather is windy.
- You can open the shutter when the unit is off to use it as a natural ventilation.

Maintenance

To maximize the life of Lossnay, clean off any accumulated dirt and dust on the air filter and Lossnay Core at least once every six months.

■ Be sure to stand on a stable surface when attaching or removing parts during maintenance.

⚠ WARNING

- Always remove the power plug from the wall outlet before starting maintenance work. Do not insert or remove the plug with wet hands. (electric shock or injury could result)

English

1

1. Pull the cord to turn off.
2. Make sure the fan has stopped turning.
3. Remove the power plug from the wall outlet.

2

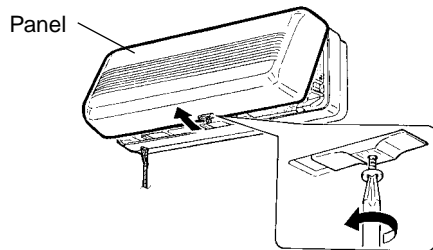

Make sure the fan has stopped turning and then remove the panel.

- Loosen the screw holding the panel, and pull the panel forward to remove it.

3

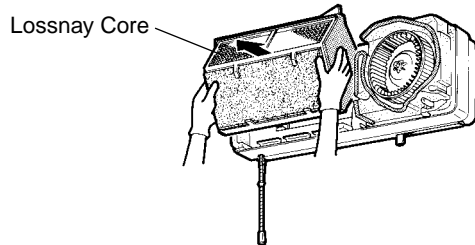

Remove the Lossnay Core.

- Pull it forward to remove it.

4

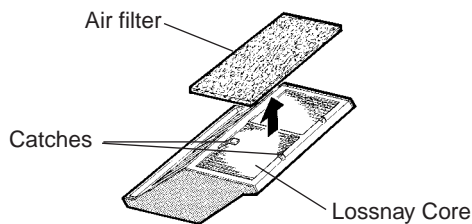

Remove the air filter.

- Remove it from the catches on the Lossnay Core.

Cleaning the outside air filter

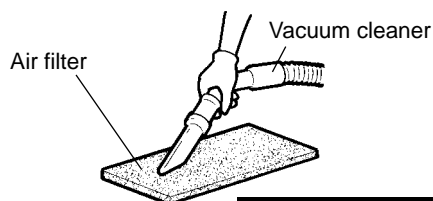

Can be rinsed

Note

- The filter may be damaged by rinsing it with hot water or scrubbing it.
- After rinsing, be sure to dry the filter.
- Do not forget to put the filter back.

Cleaning: Use a vacuum cleaner to remove dust.

- You can also rinse it with lukewarm water or wash it with a neutral detergent solution.

Replacement: Replace the filter with the separately sold parts (P-30F) when it has been rinsed about five or six times. You will need to trim the filter to a size of 346 x 115 (mm).

Cleaning the Lossnay Core

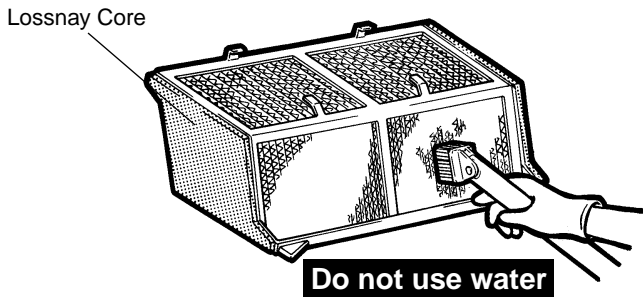

Use a vacuum cleaner to remove surface dirt and dust.

- Apply the vacuum cleaner's nozzle lightly to the surface.

Note

- Do not let water, chemicals or volatile solutions come into contact with the Lossnay Core.
- Do not place the Lossnay Core close to a flame.
- Do not press wires, screwdrivers or vacuum cleaners with hard nozzles into the surface.

Cleaning the panel/main unit

- If the panel or main unit becomes dirty, wipe it with a well-wrung cloth soaked in a solution of neutral detergent and lukewarm water, then with a clean cloth to remove any traces of detergent.

Note

- Use of the following substances may cause deterioration or discoloration: Paint thinner, alcohol, benzene, gasoline, kerosene, sprays, alkaline detergents, or chemical cleansers.

Re-assembly and checking after maintenance

1

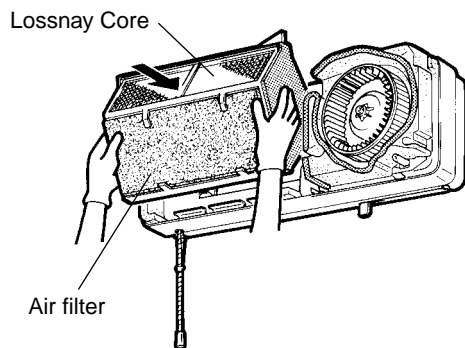

CAUTION

- After maintenance, re-attach parts securely.
(Falling parts may cause injuries.)

Air filter/Lossnay Core

1. Attach the air filter to the Lossnay Core.
2. Push in the Lossnay Core with the air filter at the bottom.

Panel attachment/checking

1. Hang the panel at the top of the main unit, and hold the bottom while pressing it in.
2. Tighten the loosened screw to secure the panel in place.
3. Insert the power plug into the wall outlet.

Note

- Be sure to insert the power plug after installing the panel.
4. Check the following:
 - (1) Are the main unit and panel attached securely?
 - (2) Is the unit making a strange noise?
 - (3) Is air coming out of the unit normally?
(Be sure to check the unit while in operation.)

2

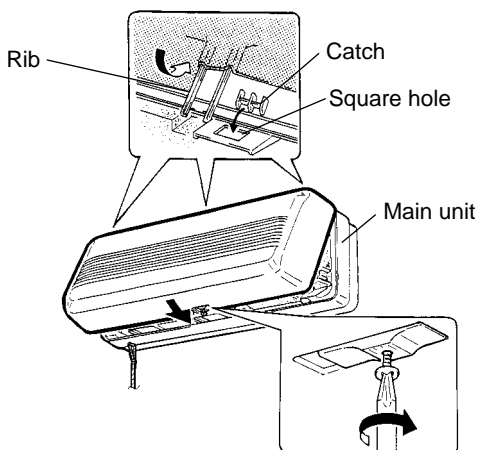

Troubleshooting

Check the unit if any of the following problems occurs. If the problem is not listed below, or the problem persists after checking, contact your place of purchase being sure to first remove the power plug from the wall outlet.

Problem	Cause	Check the following
Unit does not operate.	No power to main unit.	<ul style="list-style-type: none"> • Check the power plug. • Check that a circuit breaker (fuse) has not tripped. • Check a power failure has not occurred.
Unit is making a strange noise.	Panel or filter is not attached securely.	Re-attach panel or filter.
	Filter is clogged.	Clean filter.
	Shutter is closed.	Open shutter.
Less air than normal is coming out of unit.	Filter is clogged.	Clean filter.
	Shutter is closed.	Open shutter.

If the power cord becomes damaged, request that your place of purchase replace the cord to prevent an accident from occurring.

After-sales servicing

Contact your place of purchase for service of your Lossnay Ventilator.

Specifications

Model	Supply voltage (V)	Power line frequency (Hz)	Notch	Power consumption (W)	Air volume (m ³ /hr)	Temperature exchange efficiency (%)	Noise (dB)	Weight (kg)
VL-100U-E	220-240	50	HI	26	105	70	39	6.5
			LO	23	65	77	29.5	
	220	60	HI	26	90	73	37	
			LO	21	50	80	26	

Noise values may be higher than those listed depending on the structure of the room.