

## TECHNICAL MANUAL

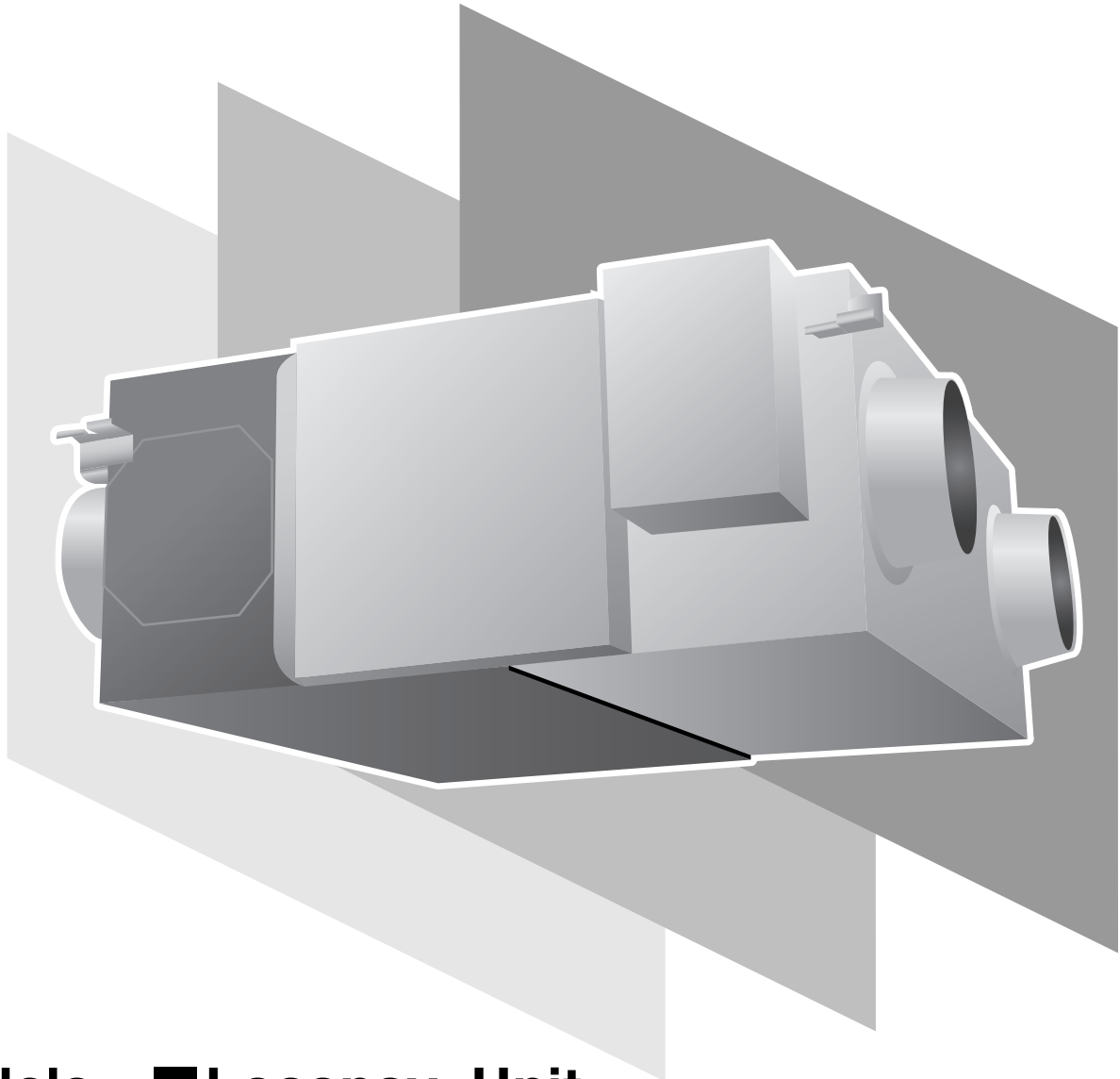

### Models ■ Lossnay Unit

LGH-15RX<sub>5</sub>-E

LGH-25RX<sub>5</sub>-E

LGH-35RX<sub>5</sub>-E

LGH-50RX<sub>5</sub>-E

LGH-65RX<sub>5</sub>-E

LGH-80RX<sub>5</sub>-E

LGH-100RX<sub>5</sub>-E

LGH-150RX<sub>5</sub>-E

LGH-200RX<sub>5</sub>-E

### ■ Lossnay Remote Controller

PZ-60DR-E

PZ-41SLB-E

PZ-52SF-E

# CONTENTS

## — Lossnay Unit —

### CHAPTER 1 Ventilation for Healthy Living

1. Necessity of Ventilation .....	U-2
2. Ventilation Standards .....	U-4
3. Ventilation Method .....	U-5
4. Ventilation Performance .....	U-8
5. Ventilation Load .....	U-10

### CHAPTER 2 Lossnay Construction and Technology

1. Construction and Features .....	U-16
2. Lossnay Core Construction and Technology .....	U-16
3. Total Energy Recovery Efficiency Calculation .....	U-18
4. What is a Psychrometric Chart? .....	U-19
5. Lossnay Energy Recovery Calculation .....	U-20

### CHAPTER 3 General Technical Considerations

1. Lossnay Energy Recovery Effect .....	U-22
2. Calculating Lossnay Cost Savings .....	U-24
3. Psychrometric Chart .....	U-26
4. Determining Lossnay Core Resistance to Bacterial Cross-Contamination and Molds .....	U-27
5. Lossnay Core Fire : retardant property .....	U-29
6. Lossnay Core Sound Reducing Properties Test .....	U-30
7. Changes in the Lossnay Core .....	U-31
8. Comparing Energy Recovery Techniques .....	U-33

### CHAPTER 4 Characteristics

1. How to Read the Characteristic Curves .....	U-36
2. Calculating Static Pressure Loss .....	U-36
3. How to Obtain Efficiency from Characteristic Curves .....	U-40
4. Sound .....	U-41
5. NC Curves .....	U-47

### CHAPTER 5 System Design Recommendations

1. Lossnay Operating Environment .....	U-52
2. Sound Levels of Lossnay units with Built-in Fans .....	U-53
3. Attaching Air Filters .....	U-53
4. Constructing the Ductwork .....	U-53
5. Bypass Ventilation .....	U-53
6. Night purge function .....	U-53
7. Transmission Rate of Various Gases and Maximum Workplace Concentration Levels .....	U-54
8. Solubility of Odors and Toxic Gases, etc., in Water and the Effect on the Lossnay Core .....	U-55
9. Automatic Ventilation Switching .....	U-56
10. Alternate Installation for Lossnay .....	U-57
11. Installing Supplementary Fan Devices .....	U-58

## **CHAPTER 6 Examples of Lossnay Applications**

1. Large Office Building .....	U-60
2. Small-Scale Urban Building .....	U-64
3. Hospitals .....	U-65
4. Schools .....	U-67
5. Convention Halls, Wedding Halls in Hotels .....	U-68
6. Public Halls (Facilities such as Day-care Centers) .....	U-69

## **CHAPTER 7 Installation Considerations**

1. LGH-Series Lossnay Ceiling Embedded-Type (LGH-RX <sub>5</sub> Series) .....	U-72
--	------

## **CHAPTER 8 Filters**

1. Importance of Filters .....	U-76
2. Dust .....	U-76
3. Calculation Table for Dust Collection Efficiency for Each Lossnay Filter .....	U-77
4. Comparing Dust Collection Efficiency Measurement Methods .....	U-79
5. Calculating Dust Concentration Levels .....	U-81
6. Certificate in EU .....	U-81

## **CHAPTER 9 Service Life and Maintenance**

1. Service Life .....	U-84
2. Cleaning the Lossnay Core and Pre-filter .....	U-84

## **CHAPTER 10 Ventilation Standards in Each Country**

1. Ventilation Standards in Each Country .....	U-88
2. United States of America .....	U-89
3. United Kingdom .....	U-89

## **CHAPTER 11 Lossnay Q and A .....**

**Note:** The word “LGH-15 to 200RX<sub>5</sub>” in this Lossnay Technical Manual expresses both the products for 50Hz area and 60Hz area, except for some parts where model name difference are written clearly.

# — Lossnay Remote Controller —

<b>1. Summary</b>	C-3
<b>2. Applicable Models</b>	C-3
<b>3. Terminology</b>	C-4
<b>4. System Features and Examples</b>	
4.1 Features	C-5
4.2 System Examples	C-6
4.3 System Selection	C-8
4.4 Basic System	C-11
4.5 Interlocking with Mr. Slim	C-13
4.6 Combining with City Multi	C-14
<b>5. Examples of Applications Using Various Input and Output Terminals</b>	
5.1 External Control Operating Mode Selection	C-23
5.2 Delayed Interlocked Operation	C-24
5.3 Multiple External Device Operation (PZ-60DR-E, PZ-41SLB-E, M-NET)	C-24
5.4 Multiple Lossnay Units Interlocked with One Indoor Unit (M-NET only)	C-25
5.5 Operation monitor output	C-26
5.6 Malfunction monitor output	C-26
5.7 By-pass operation monitor output	C-26
5.8 Connection Method	C-26
5.9 When switching High/Low/Extra-Low fan speed externally (when CO <sub>2</sub> sensor or other equipment is connected)	C-28
5.10 When switching By-pass externally	C-29
5.11 When using the remote/local switching and the ON/OFF input (level signal)	C-29
5.12 When connecting to the City Multi, Lossnay remote controller (PZ-52SF-E) or Mitsubishi Electric Air-Conditioner Network System (MELANS)	C-30
<b>6. Precautions When Designing M-NET Systems</b>	
6.1 M-NET Transmission Cable Power Supply	C-31
6.2 Restrictions When the Lossnay Units are Connected to the Central Controller M-NET Transmission Cable	C-31
6.3 Wiring Example	C-32
6.4 Power Supply to the Indoor Unit Transmission Cable	C-33
<b>7. M-NET Cable Installation</b>	
7.1 Precautions When Installing Wiring	C-34
7.2 Electrical Wiring	C-35
7.3 Control Cable Length	C-36
<b>8. M-NET System Designs</b>	
8.1 Address Definitions	C-37
8.2 Precautions When Setting the Groups (when not interlocked with City Multi indoor units)	C-39
8.3 Precautions When Performing Interlock Settings (when interlocked with City Multi indoor units)	C-39

## 9. Automatic Ventilation Switching

9.1	Effect of Automatic Ventilation Mode .....	C-40
9.2	Ventilation mode control .....	C-40

## 10. Troubleshooting

10.1	Service Flow .....	C-44
10.2	Checklist .....	C-45

## 11. Installation method

11.1	Electrical installation .....	C-64
11.2	Connecting the power supply cable .....	C-66
11.3	System configuration .....	C-66
11.4	Function Setting .....	C-72
11.5	Trial operation .....	C-76

## 12. Lossnay Remote Controller (PZ-60DR-E)

12.1	Parts Names .....	C-78
12.2	Setting the Day of the Week and Time .....	C-79
12.3	Using the Remote Controller .....	C-79
12.4	Care and Maintenance .....	C-83
12.5	Servicing .....	C-83
12.6	How to Install .....	C-84
12.7	Test Run .....	C-85
12.8	Function Selection .....	C-86

## 13. Lossnay Remote Controller (PZ-41SLB-E)..... C-91

## 14. Lossnay M-NET Remote Controller (PZ-52SF-E)..... C-92

## 15. Appendix

15.1	Centralized Controller (AG-150A) .....	C-93
15.2	Remote Controllers for Mr. Slim indoor units .....	C-100
15.3	ME Remote Controller (PAR-F27MEA) .....	C-103



# — Lossnay Unit —

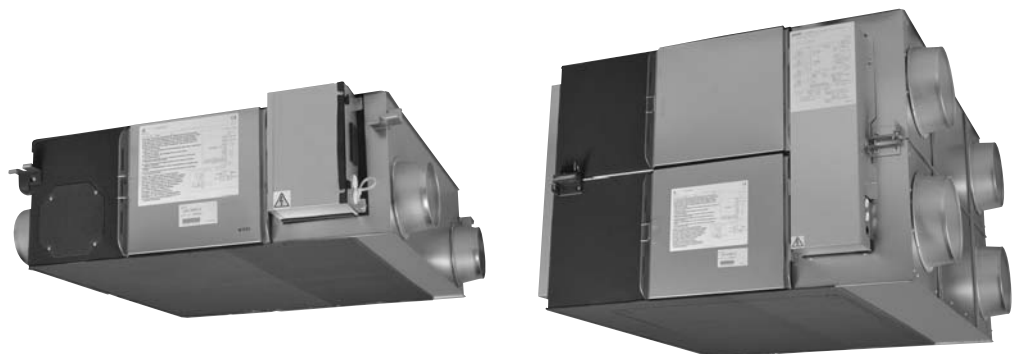





**CHAPTER 1**  
**Ventilation for Healthy Living**

## CHAPTER 1 ● Ventilation for Healthy Living

Ventilation air must be introduced constantly at a set ratio in an air-conditioning system. The ventilation air introduced is to be mixed with the return air to adjust the temperature and humidity, supply oxygen, reduce odors, remove tobacco smoke, and to increase the air cleanliness.

The standard ventilation (outdoor air intake) volume is determined according to the type of application, estimated number of occupants in the room, room area, and relevant regulations. Systems that accurately facilitate these requirements are increasingly being required in buildings.

### 1. Necessity of Ventilation

The purpose of ventilation is basically divided into “oxygen supply”, “air cleanliness”, “temperature control” and “humidity control”. Air cleanliness includes eliminating “odors”, “gases”, “dust” and “bacteria”. Ventilation needs are divided into “personal comfort”, “optimum environment for animals and plants”, and “optimum environment for machinery and constructed materials”.

In Japan ventilation regulations are detailed in the “Building Standard Law Enforcement Ordinance” and the “Building Management Law” for upholding a sanitary environment in buildings. These are similar to regulations in other countries.

#### 1.1 Room Air Environment in Buildings

In Japan, the “Building Management Law”, a law concerning the sanitary environment in buildings, designates 11 applications including offices, shops, and schools with a total floor area of 3,000m<sup>2</sup> or more, as buildings. Law maintenance and ventilation, water supply, discharge management according to the Environmental Sanitation Management Standards is obligatory.

The following table gives a specific account of buildings in Tokyo.  
(Tokyo Food and Environment Guidance Center Report)

##### Specific Account of Buildings in Tokyo (March, 2003)

	Number of Buildings	%
Offices	1,467	56.7
Shops	309	22.0
Department Stores	63	2.4
Schools	418	16.2
Inns	123	4.8
Theaters	86	3.3
Libraries	12	0.5
Museums	11	0.4
Assembly Halls	63	2.4
Art Museums	8	0.3
Amusement Centers	27	1.0
Total	2,587	100.0

**Note:** Excludes buildings with an expanded floor space of 3,000 to 5,000m<sup>2</sup> in particular areas.

Results of the air quality measurement public inspection and the standard values that were not met (percentage of unsuitability) for the approximately 500 buildings examined in 1980 are shown in the chart at the right.

There was a large decrease in high percentages of floating particles, but there was almost no change in temperature and carbon dioxide. The highest percentage of unsuitability in 2006 is relative humidity with 36%, followed by carbon dioxide at 28%.

Percentage Unsuitable Air Quality by Year

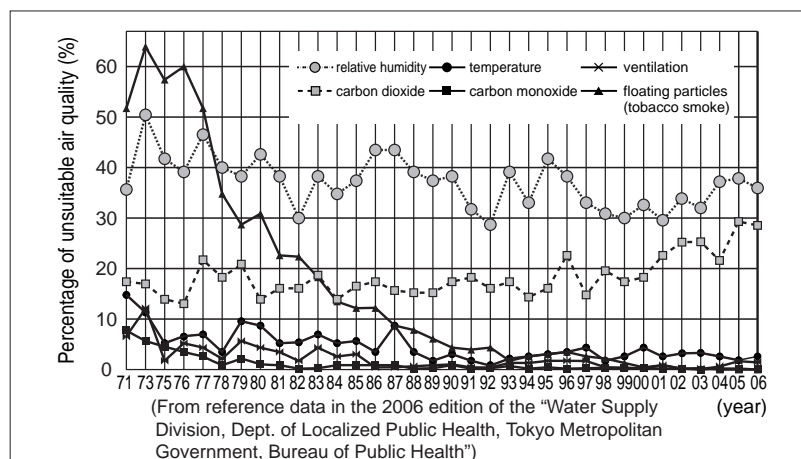

In Japan, an Instruction Guideline based on these regulations has been issued, and unified guidance is followed. Part of the Instruction Guideline regarding ventilation is shown below.

- The ventilation air intake must be 10m or higher from ground level, and be located at an appropriate distance from the exhaust air outlet. (Neighbouring buildings must also be considered.)
- The ventilation air intake volume must be 25 to 30 m<sup>3</sup>/h-occupant.
- An air volume measurement access hole must be installed at an appropriate position to measure the treated air volume of the ventilating device.
- Select the position and shape of the supply diffuser and return grille to evenly distribute the ventilation air in the room.

## 1.2 Effect of Air Contamination

### Effect of Oxygen (O<sub>2</sub>) Concentration

Concentration (%)	Standards and Effect of Concentration Changes
Approx. 21	Standard atmosphere.
20.5	Ventilation air volume standard is a guideline where concentration does not decrease more than 0.5% from normal value. (The Building Standard Law of Japan)
20 - 19	Oxygen deficiency of this amount does not directly endanger life in a normal air pressure, but if there is a combustion device in the area, the generation of CO will increase rapidly due to incomplete combustion.
18	Industrial Safety and Health Act. (Hypoxia prevention regulations.)
16	Normal concentration in exhaled air.
16 - 12	Increase in pulse and breathing; resulting in dizziness and headaches.
15	Flame in combustion devices will extinguish.
12	Short term threat to life.
7	Fatal

### Effect of Carbon Monoxide (CO)

10,000 ppm = 1%

Concentration (ppm)	Effect of Concentration Changes
0.01 - 0.2	Standard atmosphere.
5	Tolerable long-term value.
10	The Building Standard Law of Japan, Law for Maintenance of Sanitation in Buildings. Environmental standard for a 24-hour average.
20	Considered to be the tolerable short-term value. Environmental standard for an 8-hour average.
50	Tolerable concentration for working environment. (Japan Industrial Sanitation Association)
100	No effect for 3 hours. Effect noticed after 6 hours. Headache, illness after 9 hours; harmful for long-term but not fatal.
200	Light headache in the frontal lobe in 2 to 3 hours.
400	Headache in the temporal lobe, nausea in 1 to 2 hours; headache in the back of head in 2.5 to 3 hours.
800	Headache, dizziness, nausea, convulsions in 45 minutes. Comatose in 2 hours.
1,600	Headache, dizziness in 20 minutes. Death in 2 hours.
3,200	Headache, dizziness in 5 to 10 minutes. Death in 30 minutes.
6,400	Death in 10 to 15 minutes.
12,800	Death in 1 to 3 minutes.
Several 10,000 ppm (Several %)	Level may be found in automobile exhaust.

Approx. 5 ppm is the annual average value in city environments. This value may exceed 100 ppm near roads, in tunnels and parking areas.

## CHAPTER 1 ● Ventilation for Healthy Living

### Effect of Carbon Dioxide (CO<sub>2</sub>)

Concentration (%)	Effect of Concentration Changes	
0.03 (0.04)	Standard atmosphere.	
0.04 - 0.06	City air.	
0.07	Tolerable concentration when many occupants stay in the space for long time.	There is no toxic level in CO <sub>2</sub> alone. However, these tolerable concentrations are a guideline of the contamination estimated when the physical and chemical properties of the air deteriorate in proportion to the increase of CO <sub>2</sub> .
0.10	General tolerable concentration. The "Building Standard Law" of Japan, "Law for Maintenance of Sanitation in Buildings".	
0.15	Tolerable concentration used for ventilation calculations.	
0.2 - 0.5	Relatively poor.	
0.5 or more	Very poor.	
0.5	Long-term safety limits (U.S. Labor Sanitation) ACGIH, regulation of working offices.	
2	Depth of breathing and inhalation volume increases 30%.	
3	Work and physical functions deteriorate, increase breathing doubles.	
4	Normal exhalation concentration.	
4 - 5	The respiratory center is stimulated; depth and times of breathing increases. Dangerous if inhaled for a long period. If an O <sub>2</sub> deficiency also occurs, conditions will rapidly deteriorate and become dangerous.	
8	When inhaled for 10 minutes, breathing difficulties, redness in the face and headaches will occur. Conditions will worsen when there is also an O <sub>2</sub> deficiency .	
18 or more	Fatal	

**Note:** According to Facility Check List published by Kagekuni-sha.

### 1.3 Effect of Air Contamination in Buildings

- Dirtiness of interior

New ceilings, walls and ornaments will turn yellow from dust and tobacco smoke tar in 1 to 2 years.

## 2. Ventilation Standards

The legal standards for ventilation differ according to each country. Please follow the standards set by your country. In the U.S., ASHRAE revised their standards in 1989 to become more strict.

In Japan, regulations are set in the "The Building Standard Law of Japan Enforcement Ordinance", the so-called "Building Management Law" for securing a sanitary buildings environment. According to the "Building Standards Law", a minimum of 20 m<sup>3</sup>/h per occupant of ventilation air is required.

### 3. Ventilation Method

#### 3.1 Ventilation Class and Selection Points

An appropriate ventilation method must be selected according to the purpose of the space. Ventilation is composed of “Supply air” and “Exhaust air”. These functions are classified according to natural flow or mechanical ventilation using a fan (forced ventilation).

Ventilation Classification (According to Building Standards Law)

	Supply	Exhaust	Ventilation Volume	Room Pressure
Class 1	Mechanical	Mechanical	Random (constant)	Random
Class 2	Mechanical	Natural	Random (constant)	Positive pressure
Class 3	Natural	Mechanical	Random (constant)	Negative pressure
Class 4	Natural	Mechanical & natural	Limited (inconstant)	Negative pressure

#### Mechanical Ventilation Classification

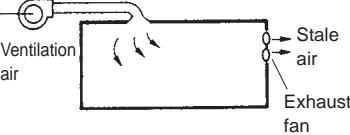
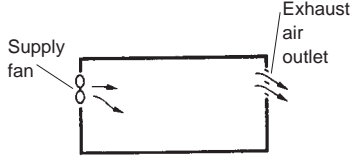
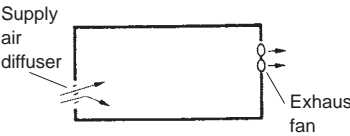
	Ex. of Application	System Effect	Design and Construction Properties	Selection Points
<p><b>1. Class 1 Ventilation</b> Ventilation air is mechanically brought in and simultaneously, the stale air in the room is mechanically discharged.</p> 	<ul style="list-style-type: none"> <li>• Ventilation of air conditioned rooms. (buildings, hospitals, etc.)</li> <li>• Ventilation of room not facing an exterior wall. (basement, etc.)</li> <li>• Ventilation of large rooms. (office, large conference room, hall, etc.)</li> </ul>	By changing the balance of the supply fan and exhaust fan's air volumes, the pressure in the room can be balanced, without restrictions, and the interrelation with neighboring spaces can be set without restrictions.	<ul style="list-style-type: none"> <li>• An ideal design in which the supply air diffuser and exhaust air outlet position relation and air volume, etc., can be set.</li> <li>• A system that adjusts the temperature and humidity of the supply air diffuser flow to the room environment can be incorporated.</li> <li>• The supply and exhaust volume can be set according to the changes in conditions.</li> </ul>	<ul style="list-style-type: none"> <li>• Accurate supply air diffuser can be maintained.</li> <li>• The room pressure balance can be maintained.</li> <li>• The supply air diffuser temperature and humidity can be adjusted and dust treatment is possible.</li> </ul>
<p><b>2. Class 2 Ventilation</b> Ventilation air is mechanically brought in and the exhaust air is discharged from the exhaust air outlet (natural).</p> 	<ul style="list-style-type: none"> <li>• Surgery theater.</li> <li>• Cleanrooms.</li> <li>• Food processing factories.</li> </ul>	As the room is pressurized, odors and dust, etc., from neighboring areas can be prevented from entering.	<ul style="list-style-type: none"> <li>• The position and shape of the supply air diffuser can be set.</li> <li>• The temperature and humidity of the supply air diffuser flow can be set accordingly, and dust can be removed as required.</li> </ul>	<ul style="list-style-type: none"> <li>• The pressure is positive.</li> <li>• The supply air diffuser temperature and humidity can be adjusted, and dust treatment is possible.</li> <li>• The relation of the exhaust air outlet to the supply air diffuser is important.</li> </ul>
<p><b>3. Class 3 Ventilation</b> The stale air in the room is mechanically discharged and simultaneously ventilation air is mechanically introduced from the supply air diffuser (natural).</p> 	<ul style="list-style-type: none"> <li>• Local ventilation in kitchens.</li> <li>• Ventilation of hot exhaust air from machine rooms, etc.</li> <li>• Ventilation of humid exhaust air from indoor pools, bathrooms, etc.</li> <li>• General ventilation.</li> </ul>	The exhaust air is removed from an area in the room, and dispersing of the stale air can be prevented by applying negative pressure.	<ul style="list-style-type: none"> <li>• Effective exhausting of dispersed stale air is possible from an exhaust air outlet.</li> <li>• Ventilation in which the air flow is not detected is possible with the supply air diffuser setting method.</li> </ul>	<ul style="list-style-type: none"> <li>• The room pressure is negative.</li> <li>• Local exhaust is possible.</li> <li>• Ventilation without dispersing stale air is possible.</li> <li>• Ventilation with reduced air flow is possible.</li> <li>• The relation of the exhaust air outlet to the supply air diffuser is important.</li> </ul>

### 3.2 Comparing of Ventilation Methods

There are two main types of ventilation methods.

#### Centralized Ventilation Method

Mainly used in large buildings, with the ventilation air intake being installed in one machine room. For this method, primary treatment of the ventilation air, such as energy recovery to the intake air and dust removal, is performed via distribution to the building by ducts.

#### Independent Zoned Ventilation Method

Mainly used in small to medium sized buildings, with areas being ventilated using ventilation air intake via independent ventilation devices. The use of this method has recently increased as independent control is becoming more feasible.

#### Centralized Ventilation Method

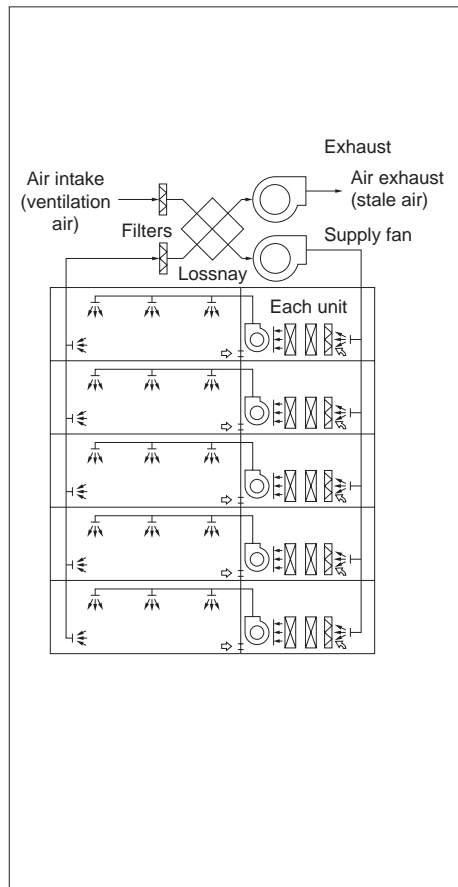

#### Independent Zoned Ventilation Method

##### 1) System operation with cassette-type indoor units of air conditioner

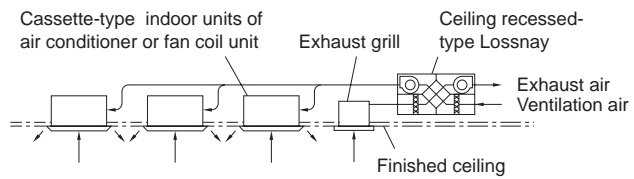

##### 2) System operation with ceiling embedded-type indoor units of air conditioner

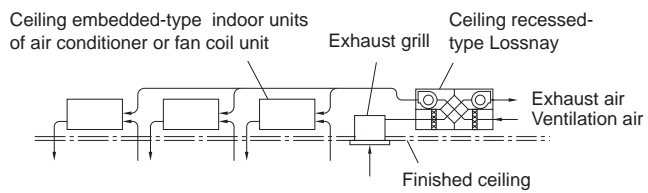

##### 3) Independent operation with ceiling suspended-type indoor units of air conditioner

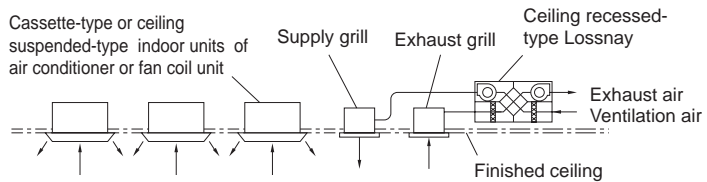

Comparing Centralized Ventilation and Independent Zoned Ventilation Methods

		Centralized Ventilation Method	Independent Zoned Ventilation Method
System Flexibility	Fan Power	The air transfer distance is long, thus requiring much fan power.	As the air transfer distance is short, the fan power is small.
	Installation Area	<ul style="list-style-type: none"> <li>Independent equipment room is required.</li> <li>Duct space is required.</li> <li>Penetration of floors with vertical shaft is not recommended in terms of fire prevention.</li> </ul>	<ul style="list-style-type: none"> <li>Independent equipment room is not required.</li> <li>Piping space is required only above the ceiling.</li> </ul>
	Zoning	Generalized per system.	Can be used for any one area.
	Design	<ul style="list-style-type: none"> <li>Design of outer wall is not lost.</li> <li>The indoor supply air diffuser and return grille can be selected without restrictions for an appropriate design.</li> </ul>	<ul style="list-style-type: none"> <li>The number of intakes and exhaust air outlets on an outside wall will increase; design must be considered.</li> <li>The design will be fixed due to installation fittings, so the design of the intakes and exhaust air outlets must be considered.</li> </ul>
Control		<ul style="list-style-type: none"> <li>As the usage set time and ventilation volume control, etc., are performed in a central monitoring room, the user's needs may not be met appropriately.</li> <li>A large amount of ventilation is required even for a few occupants.</li> </ul>	<ul style="list-style-type: none"> <li>The user in each zone can operate the ventilator without restrictions.</li> <li>The ventilator can be operated even during off-peak hours.</li> </ul>
Comfort		<ul style="list-style-type: none"> <li>An ideal supply air diffuser and return grille position can be selected as the supply air diffuser and return grille can be positioned without restrictions.</li> <li>The only noise in the room is the sound of air movement.</li> <li>Antivibration measures must be taken as the fan in the equipment room is large.</li> </ul>	<ul style="list-style-type: none"> <li>Consideration must be made because of the noise from the main unit.</li> <li>Antivibration measures are often not required as the unit is compact and any generated vibration can be dispersed.</li> </ul>
System Management	Maintenance and Management	<ul style="list-style-type: none"> <li>Centralized management is easy as it can be performed in the equipment room.</li> <li>The equipment can be inspected at any time.</li> </ul>	<ul style="list-style-type: none"> <li>Work efficiency is poor because the equipment is not centrally located.</li> <li>An individual unit can be inspected only when the room it serves is vacant.</li> </ul>
	Trouble influence	<ul style="list-style-type: none"> <li>The entire system is affected.</li> <li>Immediate inspection can be performed in the equipment room.</li> </ul>	<ul style="list-style-type: none"> <li>Limited as only independent units are affected.</li> <li>Consultation with the tenant is required prior to inspection of an individual unit.</li> </ul>
	Costs	Because there are many common-use areas, if the building is a tenant building, an accurate assessment of operating cost is difficult.	Invoicing for each zone separately is possible, even in a tenant building.

## **4. Ventilation Performance**

The ventilation performance is largely affected by the installation conditions. Optimum performance may not be achieved unless the model and usage methods are selected according to the conditions.

Generally, the ventilation performance is expressed by “air volume” and “wind pressure (static pressure)”.

### **4.1 Air Volume**

Air volume equals the volume of air exhausted (or supplied) by the unit in a given period, and is expressed in m<sup>3</sup>/hr (hour).

### **4.2 Wind Pressure**

When a piece of paper is placed in front of a fan then released, the piece of paper will be blown away. The force that blows the paper away is called wind pressure and is normally expressed in Pa. units. Wind pressure is divided into the following three types:

#### **4.2.1 Static Pressure**

The force that effects the surroundings when the air is contained such as in an automobile tyre or rubber balloon. For example, in a water gun, the hydraulic pressure increases when pressed by a piston. If there is a small hole, the water is forced out of that opening. The pressure of the water is equivalent to air static pressure. The higher the pressure, the farther the water (air) can be forced out.

#### **4.2.2 Dynamic Pressure**

The speed at which air flows; for example, the force at which a typhoon presses against a building.

#### **4.2.3 Total Pressure**

The total force that wind has, and is the sum of the static pressure and dynamic pressure.



### 4.3 Measuring the Air Volume and Static Pressure

Mitsubishi Electric measures the Lossnay's air volume and static pressure with a device as shown below according to Japan Industrial Standards (JIS B 8628).

**Measuring Device Using Orifice (JIS B 8628 Standards)**

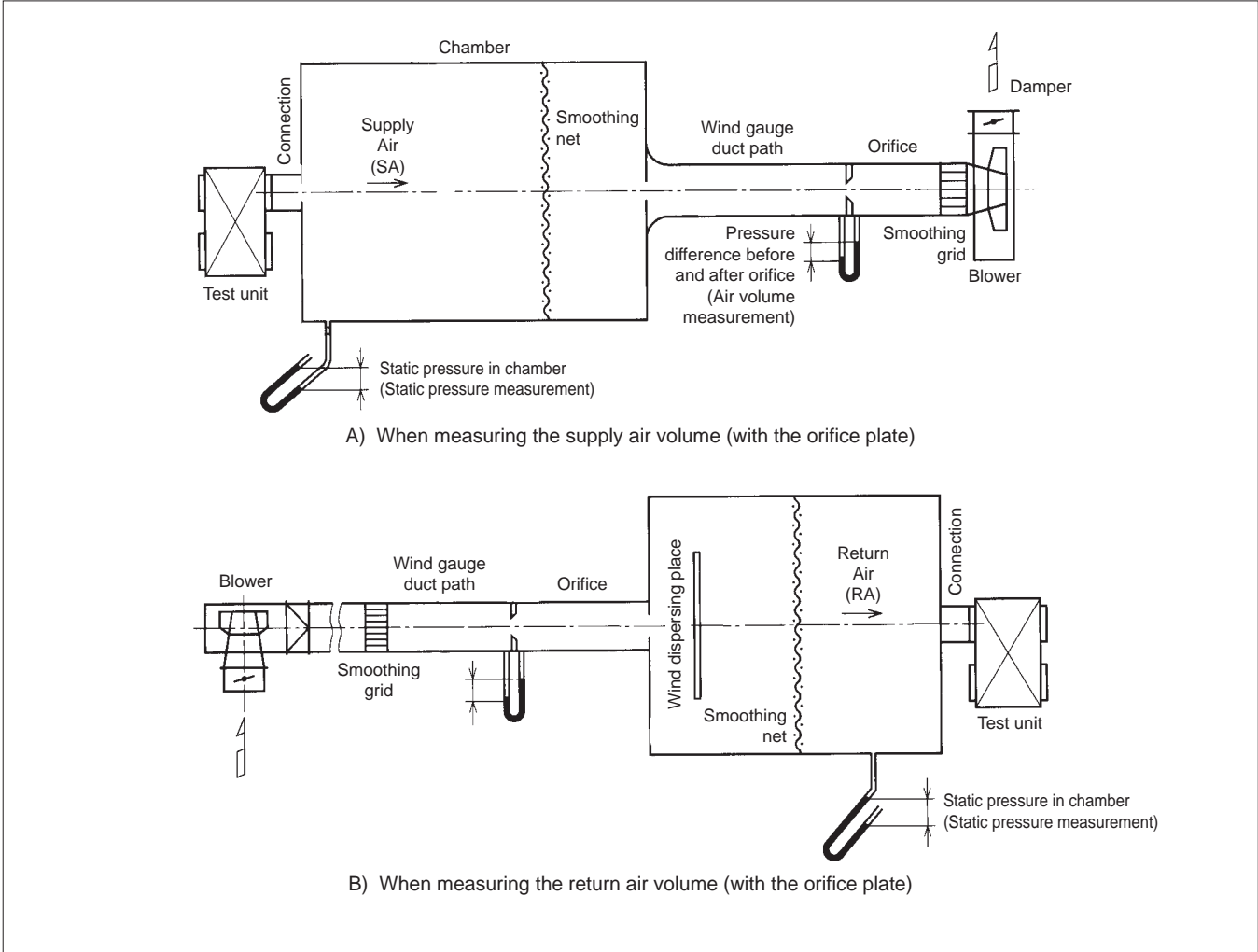

**Measurement Method**

The unit is operated with the throttle device fully closed. There is no air flow at this time, and the air volume is 0. The maximum point of the static pressure (Point A, the static pressure at this point is called the totally closed pressure) can be obtained. Next, the throttle device is gradually opened, the auxiliary fan is operated, and the median points (Points B, C and D) are obtained. Finally, the throttle device is completely opened, and the auxiliary fan is operated until the static pressure in the chamber reaches 0. The maximum point of the air volume (Point E, the air volume at this point is called the fully opened air volume) is obtained. The points are connected as shown below, and are expressed as air volume, static pressure curves (Q-H curve).

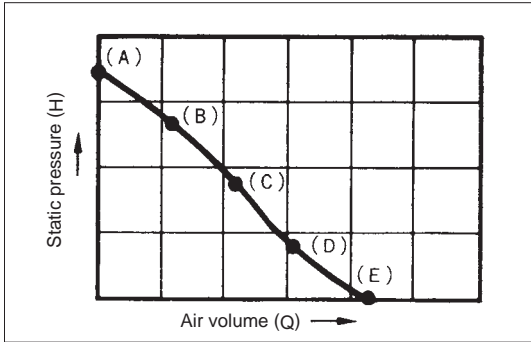

## 5. Ventilation Load

### 5.1 How to Calculate Each Approximate Load

The ventilation air load can be calculated with the following formula if the required ventilation intake volume “Q m<sup>3</sup>/h” is known:

$$\begin{aligned} \text{(Ventilation air load)} &= \gamma \cdot QF \cdot (iO - iR) \\ &= \gamma \text{ [kg/m}^3\text{]} \times S \text{ [m}^2\text{]} \times k \times n \text{ [occupant/m}^2\text{]} \times Vf \text{ [m}^3\text{/h-occupants]} \times (iO - iR) \cdot \Delta i \text{ [kJ/kg]} \end{aligned}$$

$\gamma$  : Specific air gravity - 1.2 kg/m<sup>3</sup>

S : Building's air-conditioned area

k : Thermal coefficient; generally 0.7 - 0.8.

n : The average population concentration is the inverse of the occupancy area per occupant. If the number of occupants in the room is unclear, refer to the Floor space per occupant table below.

Vf : Ventilation air intake volume per occupant

Refer to the Required ventilation air intake volume per occupant table below.

iO : Ventilation air enthalpy - kJ/kg

iR : Indoor enthalpy - kJ/kg

#### Floor Space per Occupant (m<sup>2</sup>)

(According to the Japan Federation of Architects and Building Engineers Associations)

	Office Building	Department Store, Shop			Restaurant	Theater or Cinema Hall
		Average	Crowded	Empty		
General Design	4 - 7	0.5 - 2	0.5 - 2	5 - 8	1 - 2	0.4 - 0.6
Value	5	3.0	1.0	6.0	1.5	0.5

#### Required Ventilation Air Intake Volume Per Occupant (m<sup>3</sup>/h-occupant)

Amount of Cigarette Smoking	Application Example	Required Ventilation Volume	
		Recommended Value	Minimum Value
Extremely Heavy	Broker's office Newspaper editing room Conference room	85	51
Quite Heavy	Bar Cabaret	51	42.5
Heavy	Office Restaurant	25.5	17 20
Light	Shop Department store	25.5	17
None	Theater	25.5	17
	Hospital room	34	25.5

#### Caution

The amount of smoking that could be present in each type of room must be carefully considered when obtaining the required ventilation volume shown in the table above.

See below for Calculation examples of determining ventilation load during both cooling and heating.

## 5.2 Ventilation Load During Cooling (In an Office Building)

### ● Cooling Load Classifications

	Class	Heat Load
(a)	Indoor penetration heat	Heat generated from walls ( $q_{ws}$ ) Heat generated from glass { from direct sunlight ( $q_{gs}$ ) from conduction and convection ( $q_{cs}$ ) Accumulated heat load in walls ( $q_{ss}$ )
(b)	Indoor generated heat	Generated heat from occupants { Sensible heat ( $q_{HS}$ ) Latent heat ( $q_{HL}$ ) Generated heat from electrical equipment { Sensible heat ( $q_{ES}$ ) Latent heat ( $q_{EL}$ )
(c)	Reheating load	( $q_{RL}$ )
(d)	Outdoor air load	{ Sensible heat ( $q_{FS}$ ) Latent heat ( $q_{FL}$ )

(a) Is the heat penetrating the room, and often is 30 to 40% of the entire cooling load?

(b) Is the heat generated in the room?

(c) Is applies only when reheating is necessary?

(d) Is the heat generated when ventilation air is mixed into part of the supply air diffuser volume and introduced into the room? The ventilation air is introduced to provide ventilation for the room occupants, and is referred to as the ventilating load.

### Typical Load Values During Cooling

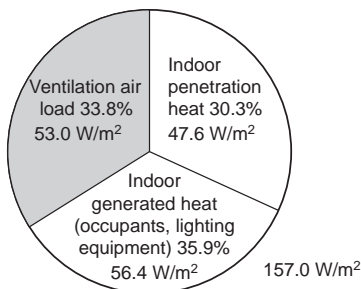

Load Type		Load
Ventilation Air Load		53.0 W/m²
Indoor Generated Heat	Occupants	26.4 W/m²
	Lighting Equipment	30.0 W/m²
Indoor Penetration Heat		47.6 W/m²
Total		157.0 W/m²

Conditions: Middle south-facing floor of a typical office building.

### Cooling Load Per Unit Area

When the volume of ventilation air per occupants is 25 m³/h, and the number of occupants per 1 m² is 0.2, the cooling load will be approximately 157.0 W/m².

### ● Ventilation Load

Standard design air conditions in Tokyo

		Dry Bulb Temp.	Relative Humidity	Wet Bulb Temp.	Enthalpy	Enthalpy Difference
Cooling	Outdoor Air	33 °C	63%	27 °C	85 kJ/kg	31.8 kJ/kg
	Indoor Air	26 °C	50%	18.7 °C	53.2 kJ/kg	

When the load per floor area of 1 m² with a ventilation volume of 25 m³/h-occupant is calculated with the air conditions detailed above, the following is obtained:

$$\text{Ventilation air load} = 1.2 \text{ kg/m}^3 \text{ (Specific gravity of air)} \times 0.2 \text{ occupant/m}^2 \text{ (number of occupants per 1 m}^2\text{)} \\ \times 25 \text{ m}^3\text{/h-occupants (ventilation air volume)} \times 31.8 \text{ kJ/kg (air enthalpy difference indoor/outdoor)} = 190.8 \text{ kJ/h-m}^2 \text{ (53.0 W/m}^2\text{)}$$

The Lossnay recuperates approximately 70% of the exhaust air load and saves on approximately 20% of the total load.

## CHAPTER 1 ● Ventilation for Healthy Living

---

### ● Determining Internal Heat Gain

When classifying loads, the internal heat gain (indoor generated heat + indoor penetration heat) is the ventilation air load subtracted from the approximate cooling load when it is assumed that there is no reheating load.

$$\begin{aligned} & \text{(Internal heat gain)} \\ & = 157.0 \text{ W/m}^2 - 53.0 \text{ W/m}^2 = 104.0 \text{ W/m}^2 \end{aligned}$$

- The value of internal heat gain is based on assumptions for typical loads. To determine individual levels of internal heat gain, the following is suggested:

### ● Indoor Generated Heat

- (1) Heat generated from occupants

Heat generation design value per occupant in the office:

$$\begin{aligned} \text{Sensible heat (SH)} &= 63.0 \text{ W-occupant} \\ \text{Latent heat (LH)} &= 69.0 \text{ W-occupant} \\ \text{Total heat (TH)} &= 132.0 \text{ W-occupant} \end{aligned}$$

The heat generated per 1 m<sup>2</sup> of floor space:

$$\text{Heat generated from occupants} = 132.0 \text{ W-occupant} \times 0.2 \text{ occupant/m}^2 = 26.4 \text{ W/m}^2$$

- (2) Heat generated from electrical equipment (lighting)

The approximate value of the lighting and power required for a general office with lighting of 300 - 350 Lux, is 20 - 30 W/m<sup>2</sup>.

$$\text{Heat generated from electrical equipment (lighting)} = 30 \text{ W/m}^2$$

### ● Indoor Penetration Heat

The heat that penetrates into the building from outside, which can be determined by subtracting the amount of heat generated by occupants and lighting from the internal heat gain.

$$\begin{aligned} & \text{(Indoor infiltration heat)} \\ & = 104.0 - (26.4 + 30.0) = 47.6 \text{ W/m}^2 \end{aligned}$$

### 5.3 Ventilation Load During Heating

● Classification of Heating Load

	Class	Heat Load
(a)	Indoor heat loss	Heat escaping from walls ( $q_{ws}$ ) Heat escaping from glass ( $q_{gs}$ ) Heat loss from conduction and convection ( $q_{cs}$ ) Accumulated heat load in walls ( $q_{ss}$ )
(b)	Ventilation load	Sensible heat ( $q_{fs}$ ) Latent heat ( $q_{fL}$ )

During heating, the heat generated by occupants and electrical equipment in the room can be subtracted from the heating load. If the warming-up time at the start of heating is short, however, the generated heat may be ignored in some cases.

Percentage of Load

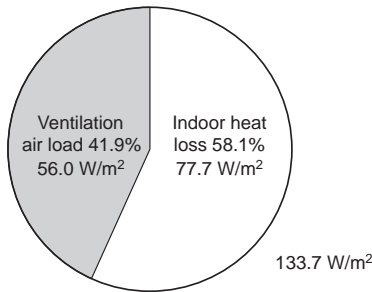

Type of Load	Load
Ventilation Air Load	56.0 W/m <sup>2</sup>
Internal Heat	77.7 W/m <sup>2</sup>
Total	133.7 W/m <sup>2</sup>

Conditions: Middle south-facing floor of a typical office building.

● Heating Load Per Unit Area

When the ventilation air volume per occupant is 25 m<sup>3</sup>/h, and the number of occupants per 1 m<sup>2</sup> is 0.2, the heating load will be approximately 133.7 W/m<sup>2</sup>.

● Internal Heat Loss

In terms of load classification, the internal heat loss is the value of the ventilation air load subtracted from the approximate heating load.

$$\text{Internal heat loss} = 133.7 \text{ W/m}^2 - 56.0 \text{ W/m}^2 = 77.7 \text{ W/m}^2$$

● Ventilation Load

Standard design air conditions in Tokyo

		Dry Bulb Temp.	Relative Humidity	Wet Bulb Temp.	Enthalpy	Enthalpy Difference
Heating	Outdoor Air	0 °C	50%	-3 °C	5.0 kJ/kg	33.5 kJ/kg
	Indoor Air	20 °C	50%	13.7 °C	38.5 kJ/kg	

When the load per 1 m<sup>2</sup> of floor area with a ventilation volume of 25 m<sup>3</sup>/h-occupant is calculated with the air conditions detailed above, the following is obtained:

$$\text{Ventilation air load} = 1.2 \text{ kg/m}^3 \times 0.2 \text{ occupants/m}^2 \times 25 \text{ m}^3/\text{h-occupant} \times 33.5 \text{ kJ/kg} = 201.0 \text{ kJ/h}\cdot\text{m}^2 \text{ (56 W/m}^2\text{)}$$

The Lossnay recuperates approximately 70% of the ventilation load and saves on approximately 30% of the total load.



## **CHAPTER 2**

### **Lossnay Construction and Technology**

## 1. Construction and Features

### ● Construction

Lossnay is constructed so that the exhaust air passage from the indoor side to the outdoor side (RA → EA) and the ventilation air passage from the outdoor side to the indoor side (OA → SA) cross. The Lossnay Core is located at this crosspoint, and recovers the heat by conduction through the separating medium between these airflows. This enables the heat loss during exhaust to be greatly reduced.

- \* RA : Return Air
- EA : Exhaust Air
- OA : Outdoor Air
- SA : Supply Air

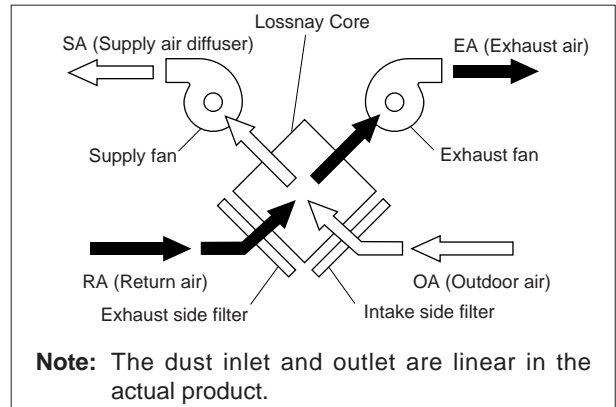

### Main Features

- (1) Cooling and heating maintenance fees are reduced while ventilating.
- (2) The system size of Heating/cooling system and cooling/heating load can be reduced.
- (3) Dehumidifying during summer and humidifying during winter is possible.
- (4) Comfortable ventilation is possible with the outdoor air can be adjusted to parallel the room temperature.
- (5) Sound can be reduced.

## 2. Lossnay Core Construction and Technology

### ● Simple Construction

The Lossnay core is a cross-air passage total energy recovery unit constructed from specially treated paper with a corrugated structure.

The fresh air and exhaust air passages are totally separated allowing the fresh air to be introduced without mixing with the exhaust air.

### ● Principle

The Lossnay Core uses the heat transfer properties and moisture permeability of the treated paper. Total heat (sensible heat plus latent heat) is transferred from the stale exhaust air to the ventilation air being introduced into the system when they pass through the Lossnay.

### ● Treated Paper

The paper partition plates are treated with special chemicals so that the Lossnay Core is an appropriate energy recovery unit for the ventilator.

The membrane has many unique properties:

- (1) Incombustible and strong.
- (2) Has selective hydroscopicity and moisture permeability that permits the passage of only water vapor (including some water-soluble gases).
- (3) Has gas barrier properties that does not permit gases such as CO<sub>2</sub> from entering the conditioned space.

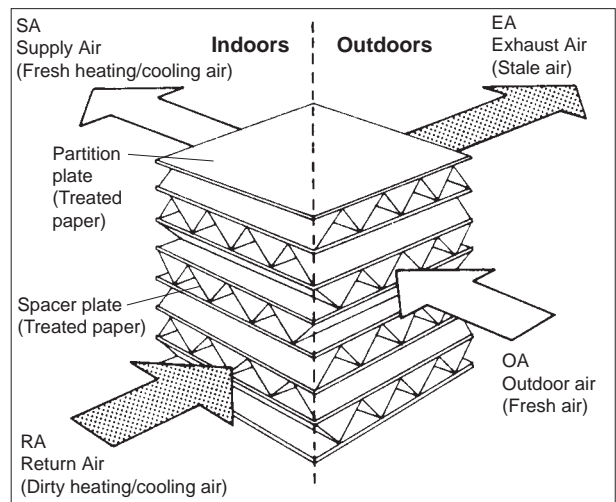



● **Total Energy Recovery Mechanism**

**Sensible Heat and Latent Heat**

The heat that enters and leaves in accordance with rising or falling temperatures is called sensible heat. The heat that enters and leaves due to the changes in a matter's physical properties (evaporation, condensation) is called latent heat.

**(1) Temperature (Sensible Heat) Recovery**

- 1) Heat conduction and heat passage is performed through a partition plate from the high temperature to low temperature side.
- 2) As shown in the diagram at right, the energy recovery efficiency is affected by the resistance of the partition plate. For Lossnay, there is little difference when compared to materials such as copper or aluminium that also have high thermal conductivity.

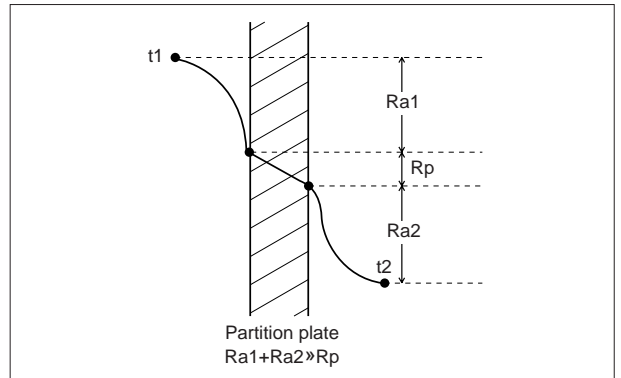

**Heat Resistance Coefficients**

	Treated Paper	Cu	Al
Ra1	10	10	10
Rp	1	0.00036	0.0006
Ra2	10	10	10
Total	21	20.00036	20.0006

**(2) Humidity (Latent Heat) Recovery**

- Water vapor travels through the partition plate from the high humidity to low humidity side via the differential pressure in the vapor.

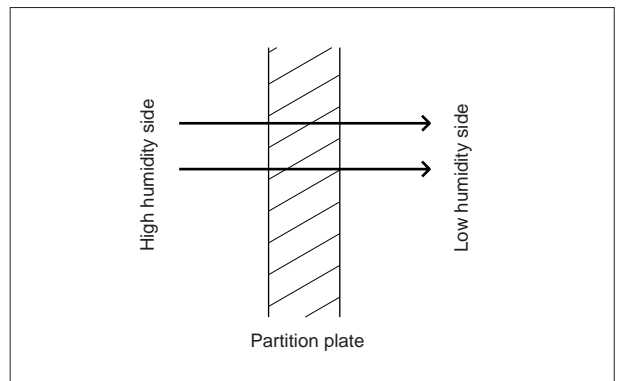

### 3. Total Energy Recovery Efficiency Calculation

The Lossnay Core's energy recovery efficiency can be considered using the following three transfer rates:

- (1) Temperature (sensible heat) recovery efficiency
- (2) Humidity (latent heat) recovery efficiency
- (3) Enthalpy (total heat) recovery efficiency

The energy recovery effect can be calculated if two of the above efficiencies are known.

- Each energy efficiency can be calculated with the formulas in the table.
- When the supply and exhaust air volumes are equal, the energy recovery efficiencies on the supply and exhaust sides are the same.
- When the supply and exhaust air volumes are not equal, the total energy recovery efficiency is low if the exhaust volume is lower, and high if the exhaust volume is higher.

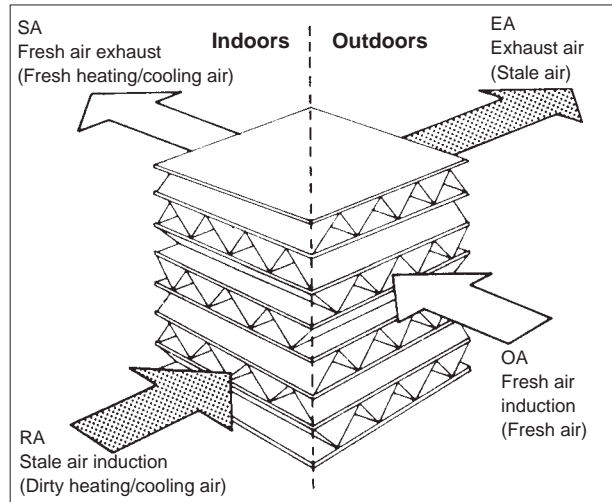

Item	Formula
Temperature recovery efficiency (%)	$\eta_t = \left( \frac{t_{OA} - t_{SA}}{t_{OA} - t_{RA}} \right) \times 100$
Enthalpy recovery efficiency (%)	$\eta_i = \left( \frac{i_{OA} - i_{SA}}{i_{OA} - i_{RA}} \right) \times 100$

$\eta$  : Efficiency (%)  
 $t$  : Dry bulb temperature (°C)  
 $i$  : Enthalpy (kJ/kg)

#### Calculation of Supply Air Condition After Passing Through Lossnay

If the Lossnay energy recovery efficiency and the conditions of the room and outdoor air are known, the conditions of the air entering the room and the air exhausted outdoors can be determined with the following formulas in the following table.

	Supply Side	Exhaust Side
Temperature	$t_{SA} = t_{OA} - (t_{OA} - t_{RA}) \times \eta_t$	$t_{EA} = t_{RA} + (t_{OA} - t_{RA}) \times \eta_t$
Enthalpy	$i_{SA} = i_{OA} - (i_{OA} - i_{RA}) \times \eta_i$	$i_{EA} = i_{RA} + (i_{OA} - i_{RA}) \times \eta_i$

## 4. What is a Psychrometric Chart?

A chart that shows the properties of humid air is called a psychrometric chart. The psychrometric chart can be used to find the (1) Dry bulb temperature, (2) Wet bulb temperature, (3) Absolute humidity, (4) Relative humidity, (5) Dew point and (6) Enthalpy (total heat) of a certain air condition. If two of these values are known, the other values can be found with the chart. Now air conditions will change when it is heated, cooled, humidified or dehumidified can also be seen easily on the chart.

### (1) Dry Bulb Temperature $t$ (°C)

Generally referred to as standard temperature, the DB temperature is obtained by using a dry bulb thermometer (conventional thermometer).

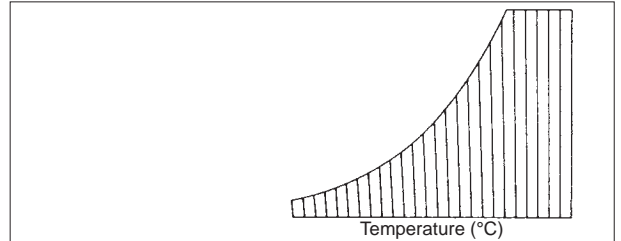

### (2) Wet Bulb Temperature $t'$ (°C)

When a dry bulb thermometer is wrapped in a piece of wet gauze and an ample air flow (3 m/s or more) is applied, the heat from the air and evaporating water vapor applied to the wet bulb will balance at an equal state and the wet bulb temperature is obtained.

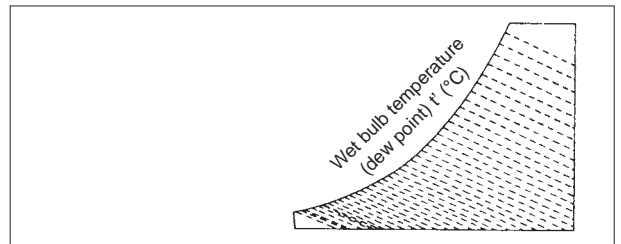

### (3) Absolute Humidity $x$ (kg/kg')

Weight (kg) of the water vapor that corresponds to the weight (kg') of the dry air in the humid air.

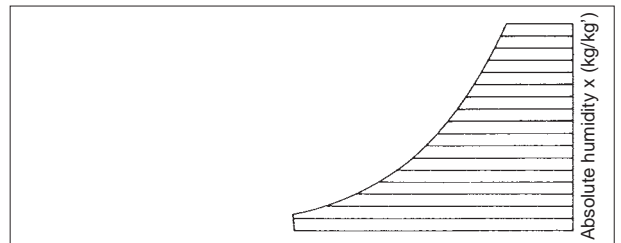

### (4) Relative Humidity $\varphi$ (%)

Ratio of the water vapor pressure  $P_w$  in the humid air and the water vapor pressure  $P_{ws}$  in the saturated air at the same temperature. Relative humidity is obtained with the following formula:

$$\varphi R = P_w / P_{ws} \times 100$$

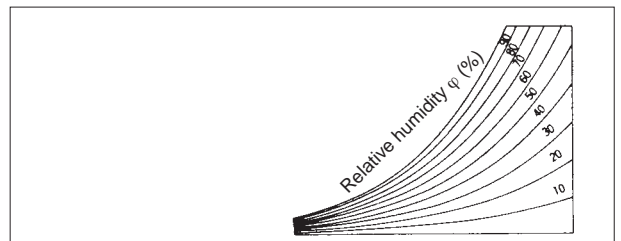

### (5) Dew Point $t''$ (°C)

Water content in the air will start to condense when air is cooled and the dry bulb temperature at that condition is the dew point.

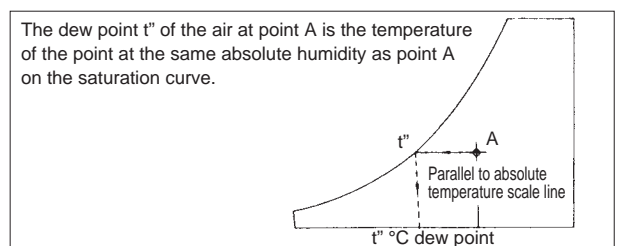

### (6) Enthalpy $i$ (kJ/kg)

Physical matter has a set heat when it is at a certain temperature and state. The retained heat is called the enthalpy, with dry air at 0 °C being set at 0.

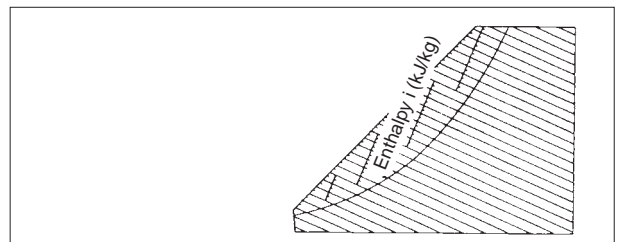

## 5. Lossnay Energy Recovery Calculation

The following diagram shows the various air conditions when ventilation air is introduced through the Lossnay Core. If a conventional sensible energy recovery unit is used alone and is assumed to have the same energy recovery efficiency as Lossnay, the condition of the air supplied to the room is expressed by Point A in the figure. Point A shows that the air is very humid in summer and very dry in winter.

The air supplied to the room with Lossnay is indicated by Point S in the figure. The air is precooled and dehumidified in the summer, and preheated and humidified in the winter before it is introduced to the room.

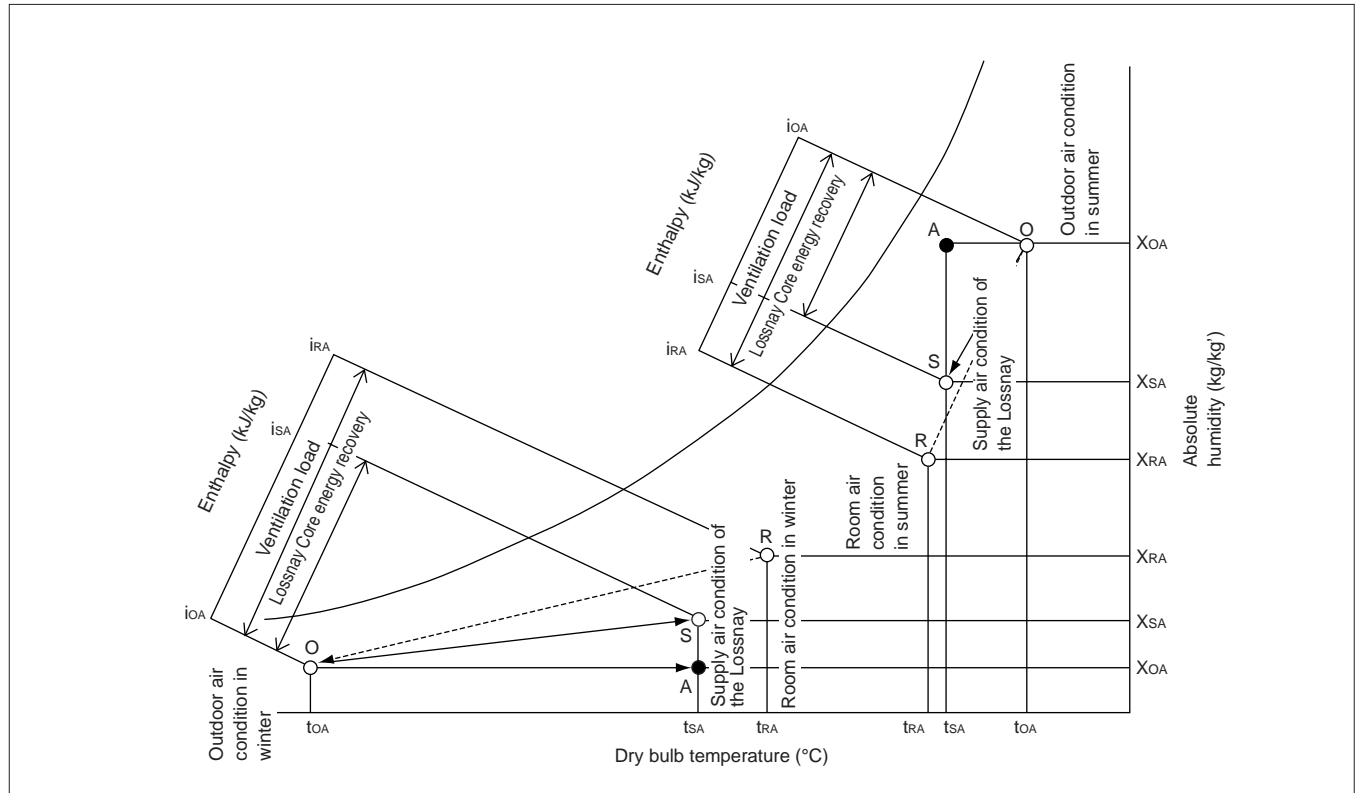

The quantity of heat recovered by using the Lossnay Core can be calculated with the formula below:

$$\begin{aligned} \text{Total heat recovered: } q_T &= \gamma \times Q \times (i_{OA} - i_{SA}) \text{ [W]} \\ &= \gamma \times Q \times (i_{OA} - i_{RA}) \times \eta_i \end{aligned}$$

Where  $\gamma$  = Specific weight of the air under standard conditions 1.2 (kg/m<sup>3</sup>)

$Q$  = Treated air volume (m<sup>3</sup>/h)

$t$  = Temperature (°C)

$x$  = Absolute humidity (kg/kg)

$i$  = Enthalpy (kJ/kg)

$\eta$  = Energy recovery efficiency (%)

OA : Outdoor air

RA : Return air

SA : Supply air

**CHAPTER 3**  
**General Technical Considerations**

# 1. Lossnay Energy Recovery Effect

## 1.1 Comparing Ventilation Load of Various Ventilators

Examples of formulas that compare the energy recovered and ventilation load when ventilating with the Lossnay (total energy recovery unit), a sensible energy recovery ventilation unit (sensible HRV), and a conventional ventilator unit are shown below.

### (1) Cooling During Summer

Conditions

- Model LGH-100RX5-E (at 50Hz, high speed)
- Ventilation rate: 1,000 m<sup>3</sup>/h (specific gravity of air ρ = 1.2 kg/m<sup>3</sup>)

- Energy recovery efficiency table (%) (For summer)

	Lossnay Unit	Sensible HRV Unit	Conventional Ventilator Unit
Temperature (Sensible Heat)	76	76	–
Enthalpy (Total Heat)	71	17*	–

\* Calculated volume under conditions below.

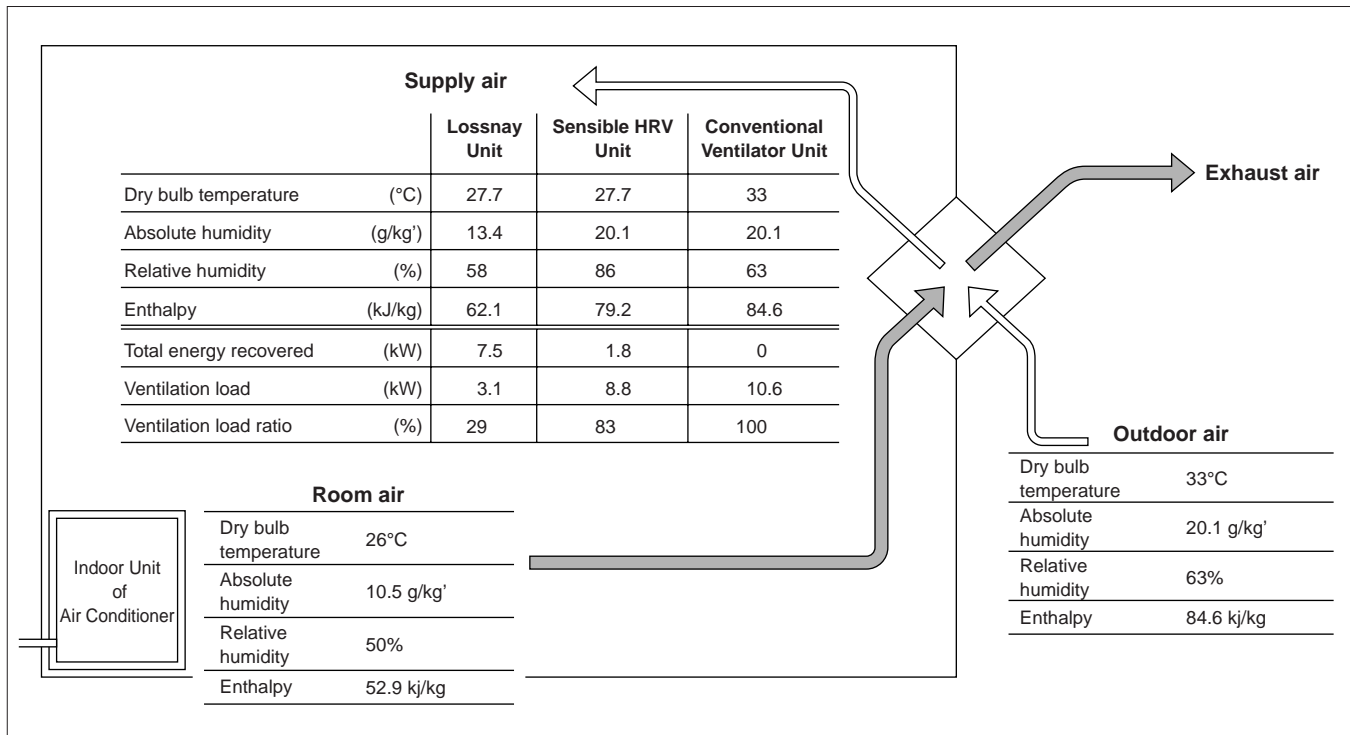

### Calculation Example

#### ● Lossnay Unit

(Supply air diffuser temperature) = 33°C – (33°C – 26°C) × 0.76 = 27.7°C  
 (Supply air diffuser enthalpy) = 84.6 – (84.6 – 52.9) × 0.71 = 62.1 kJ/kg  
 Heat recovered = (84.6 – 62.1) × 1.2 × 1,000 = 27,000 kJ/kg = 7.5 kW  
 Ventilation load = (62.1 – 52.9) × 1.2 × 1,000 = 11,040 kJ/kg = 3.1 kW

#### ● Sensible HRV Unit

(Supply air diffuser temperature) = 33°C – (33°C – 26°C) × 0.76 = 27.7°C  
 (Supply air diffuser enthalpy) h<sub>SA</sub> = 79.2 kJ/kg (from psychrometric chart)  
 Heat recovered = (84.6 – 79.2) × 1.2 × 1,000 = 6,480 kJ/kg = 1.8 kW  
 Ventilation load = (79.2 – 52.9) × 1.2 × 1,000 = 31,560 kJ/kg = 8.8 kW  
 [Calculated enthalpy recovery efficiency 1.8 ÷ (1.8 + 8.8) × 100 = 17.0%]

#### ● Conventional Ventilator Unit

If a conventional ventilator unit is used, the energy recovered will be 0 as the supply air diffuser is equal to the outdoor air.

The ventilation load is:

(84.6 – 52.9) × 1.2 × 1,000 = 38,040 kJ/h = 10.6 kW

### Summer Conditions

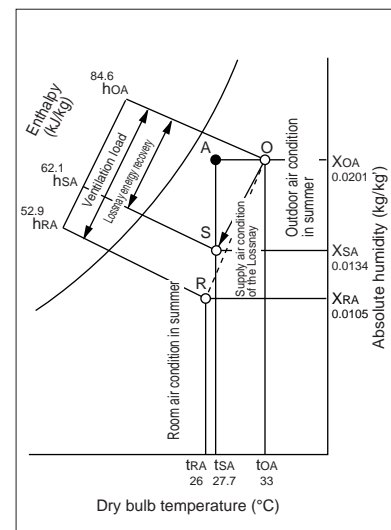

**(2) Heating During Winter**

Conditions:

- Model LGH-100RX5-E (at 50Hz, high speed)
- Ventilation rate: 1,000 m<sup>3</sup>/h (Specific gravity of air ρ = 1.2 kg/m<sup>3</sup>)

- Energy recovery efficiency table (%) (For winter)

	Lossnay Unit	Sensible HRV Unit	Conventional Unit
Temperature (Sensible Heat)	80	80	–
Enthalpy (Total Heat)	72.5	49*	–

\* Calculated volume under conditions below .

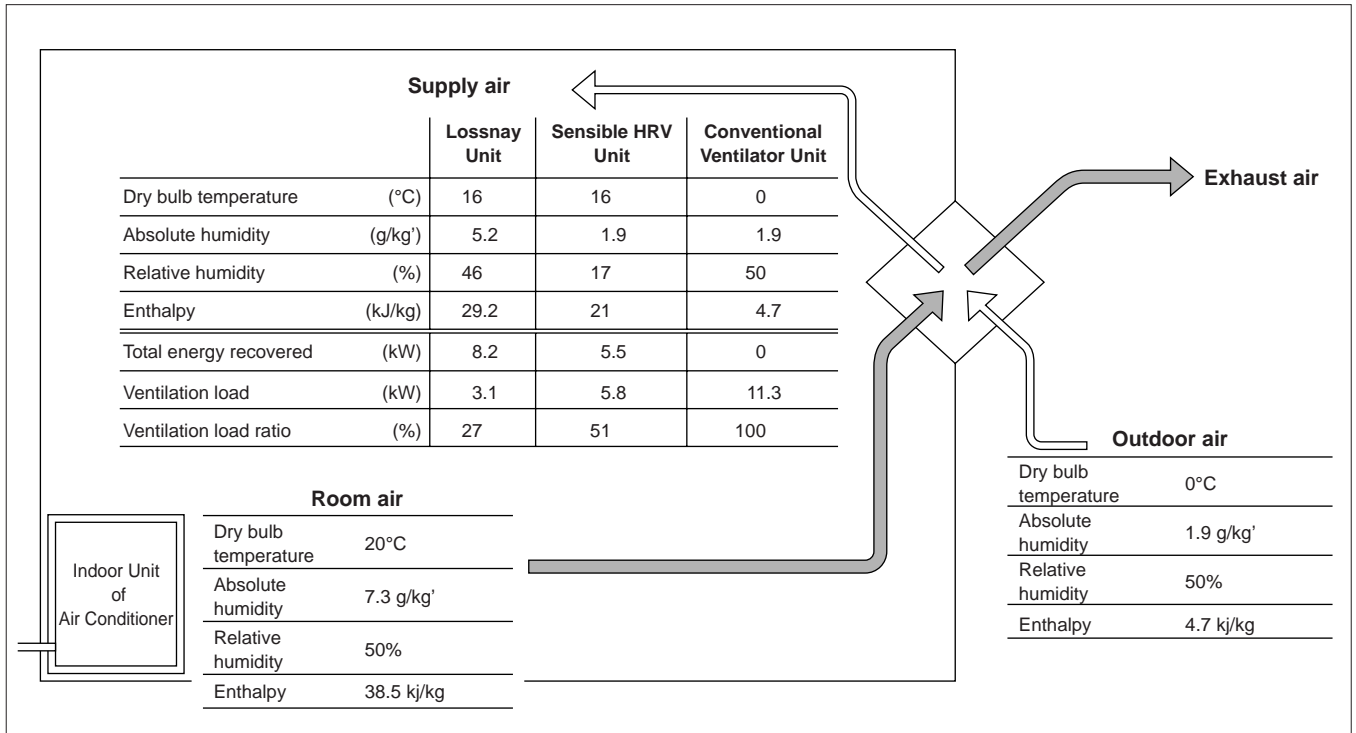

**Calculation Example**

- **Lossnay Unit**  
 (Supply air diffuser temperature)  $t_{SA} = (20^{\circ}\text{C} - 0^{\circ}\text{C}) \times 0.8 + 0^{\circ}\text{C} = 16^{\circ}\text{C}$   
 (Supply air diffuser enthalpy)  $h_{SA} = (38.5 - 4.7) \times 0.725 + 4.7 = 29.2 \text{ kJ/kg}$   
 Heat recovered  $(29.2 - 4.7) \times 1.2 \times 1,000 = 29,400 \text{ kJ/h} = 8.2 \text{ kW}$   
 Ventilation load  $(38.5 - 29.2) \times 1.2 \times 1,000 = 11,160 \text{ kJ/h} = 3.1 \text{ kW}$
- **Sensible HRV Unit**  
 (Supply air diffuser temperature)  $t_{SA} = (20^{\circ}\text{C} - 0^{\circ}\text{C}) \times 0.8 + 0^{\circ}\text{C} = 16^{\circ}\text{C}$   
 (Supply air diffuser enthalpy)  $h_{SA} = 21 \text{ kJ/kg}$  (from psychrometric chart)  
 Heat recovered  $(21 - 4.7) \times 1.2 \times 1,000 = 19,560 \text{ kJ/h} = 5.5 \text{ kW}$   
 Ventilation load  $(38.5 - 21) \times 1.2 \times 1,000 = 21,000 \text{ kJ/h} = 5.8 \text{ kW}$   
 [Calculated enthalpy recovery efficiency  $5.4 \div (5.4 + 5.8) \times 100 = 48\%$ ]
- **Conventional Ventilator Unit**  
 If a conventional ventilator is used, the supply air diffuser is the same as the outdoor air and the exhaust is the same as the room air.  
 Thus the energy recovered is 0 kcal and the Ventilation load is  $(38.5 - 4.7) \times 1.2 \times 1,000 = 40,560 \text{ kJ/h} = 11.3 \text{ kW}$

**Winter Conditions**

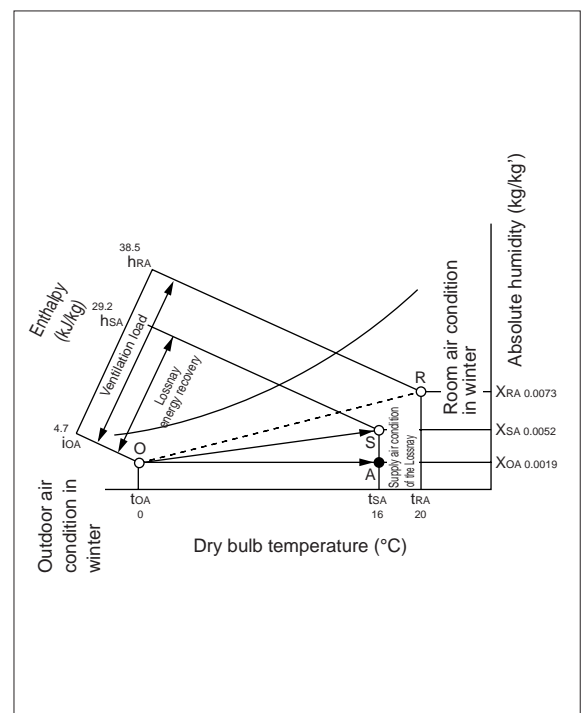

## 2. Calculating Lossnay Cost Savings

Use the following pages to assess the economical benefits of using the Lossnay in particular applications.

### (1) Conditions

- Return air volume (RA) = m<sup>3</sup>/Hr
- Outdoor air volume (OA) = m<sup>3</sup>/Hr
- Air volume ratio (RA/OA) =
- Air conditions

Season	Winter Heating					Summer Cooling				
	Dry bulb temp. DB [°C]	Wet bulb temp. WB [°C]	Relative humidity RH [%]	Absolute humidity × [kg/kg']	Enthalpy i kJ/kg (kcal/kg')	Dry bulb temp. DB [°C]	Wet bulb temp. WB [°C]	Relative humidity RH [%]	Absolute humidity × [kg/kg']	Enthalpy i kJ/kg (kcal/kg')
Outdoors										
Indoors										

- Operation time: Heating = hours/day × days/month × months/year = hours/year  
Cooling = hours/day × days/month × months/year = hours/year
- Energy: Heating = Type: Electricity Cost: yen/kWh  
Cooling = Type: Electricity Cost: yen/kWh  
Power rates: Winter: yen/kWh Summer: yen/kWh

### (2) Lossnay Model

- Model name:
- Processing air volume per unit RA = m<sup>3</sup>/Hr, OA = m<sup>3</sup>, Air volume ratio (RA/OA) =
- Energy recovery efficiency: Energy recovery efficiency = %,  
Enthalpy recovery efficiency (cooling) = %,  
Enthalpy recovery efficiency (heating) = %
- Static pressure loss (unit-type) RA= Pa OA = Pa (Note: Each with filters)
- Power consumption (pack-type) = none because of unit type

### (3) Indoor Blow Air Conditions

	Heating	Cooling
Temperature [°C]	= (Indoor temperature – outdoor air temperature) × energy recovery efficiency + outdoor air temperature =	= Outdoor air temperature – (outdoor air temperature – indoor temperature) × energy recovery efficiency =
Enthalpy [kJ/kg]	= (Indoor enthalpy – outdoor air enthalpy) × enthalpy recovery efficiency + outdoor air enthalpy =	= Outdoor air enthalpy – (outdoor air enthalpy – indoor enthalpy) × enthalpy recovery efficiency =
Data obtained from above equation and psychrometric chart	<ul style="list-style-type: none"> <li>● Dry-bulb temperature = °C</li> <li>● Wet-bulb temperature = °C</li> <li>● Relative humidity = %</li> <li>● Absolute humidity = kg/kg'</li> <li>● Enthalpy = kg/kg</li> </ul>	<ul style="list-style-type: none"> <li>● Dry-bulb temperature = °C</li> <li>● Wet-bulb temperature = °C</li> <li>● Relative humidity = %</li> <li>● Absolute humidity = kg/kg'</li> <li>● Enthalpy = kg/kg</li> </ul>



(4) Ventilation Load and Energy Recovery

	Heating	Cooling
Ventilation load without Lossnay (q <sub>1</sub> )	= Air specific gravity × ventilation volume × (indoor enthalpy – outdoor air enthalpy) =	= Air specific gravity × ventilation volume × (outdoor air enthalpy – indoor enthalpy) =
Ventilation load with Lossnay (q <sub>2</sub> )	= Ventilation load (q <sub>1</sub> ) × ( 1 – enthalpy recovery efficiency) = or = Air specific gravity × ventilation volume × (indoor enthalpy – indoor blow enthalpy)	= Ventilation load (q <sub>1</sub> ) × ( 1 – enthalpy recovery efficiency) = or = Air specific gravity × ventilation volume × (indoor blow enthalpy – indoor enthalpy)
Energy recovery (q <sub>3</sub> )	= q <sub>1</sub> – q <sub>2</sub> = – = or = Ventilation load (q <sub>1</sub> ) × enthalpy recovery efficiency	= q <sub>1</sub> – q <sub>2</sub> = – = or = Ventilation load (q <sub>1</sub> ) × enthalpy recovery efficiency
Ventilation load (%)	● Ventilation load = W = % ● Ventilation load with Lossnay = W = % ● Energy recovered = W = %	● Ventilation load = W = % ● ventilation load with Lossnay = W = % ● Energy recovered = W = %

(5) Recovered Money (Power Rates)

	Heating	Cooling
Cost savings (yen)	= Energy recovered: kW × Unit price ¥/kWh × operation time Hr/year = kW × ¥/kWh × Hr/year =	= Energy recovered: kW × Unit price ¥/kWh × operation time Hr/year = kW × ¥/kWh × Hr/year =

### 3. Psychrometric Chart

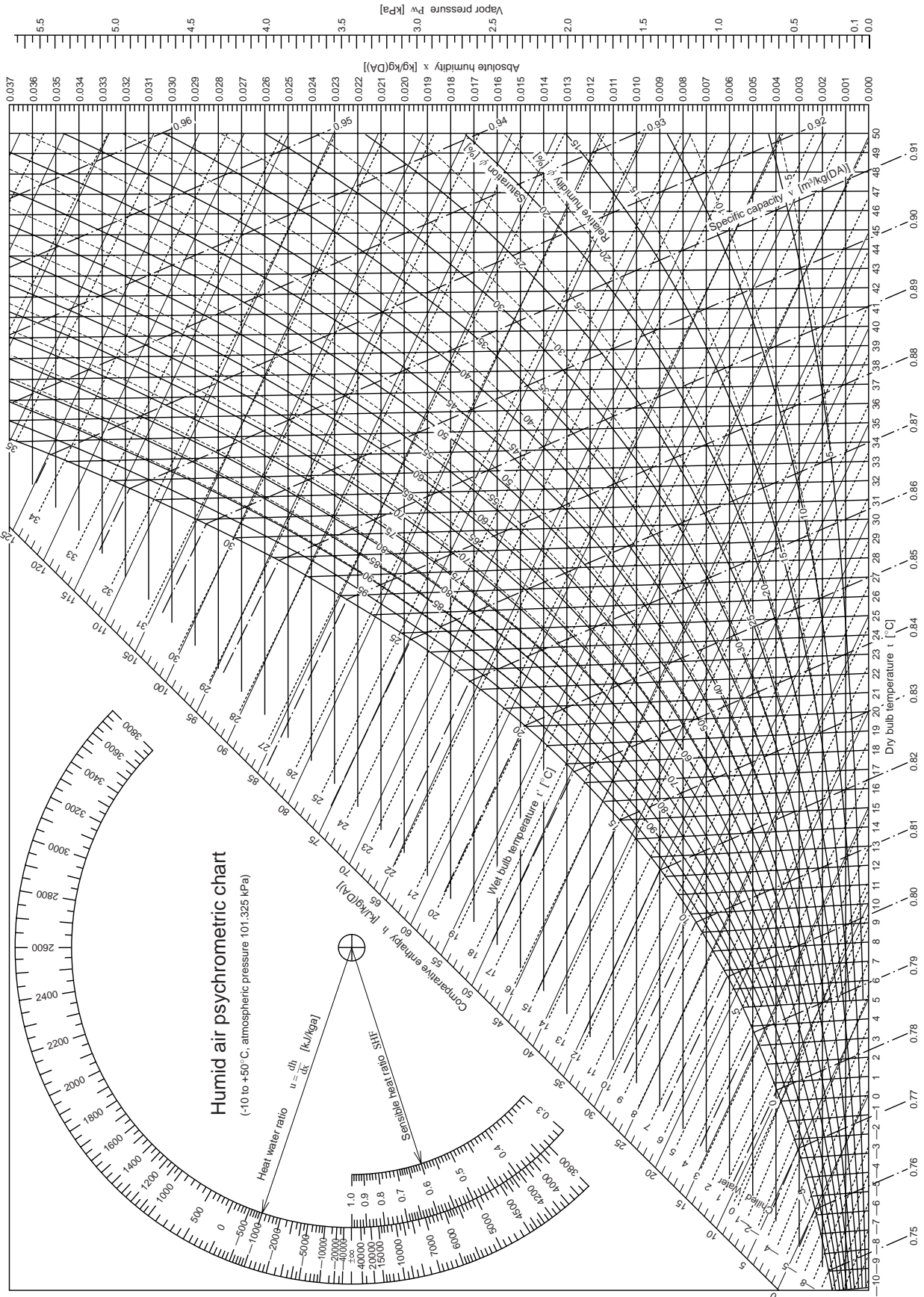

## 4. Determining Lossnay Core Resistance to Bacterial Cross-Contamination and Molds

### Test Report

#### (1) Object

To verify that there is no bacterial cross-contamination from the outlet air to the inlet air of the Lossnay Core.

#### (2) Client

mitsubishi electric co. nakatsugawa works.

#### (3) Test Period

April 26, 1999 - May 28, 1999

#### (4) Test Method

The test bacteria suspension is sprayed in the outlet duct at a pressure of 1.5 kg/cm<sup>2</sup> with a sprayer whose dominant particle size is 0.3 - 0.5 μm. The air sampling tubes are installed at the center of Locations A, B, C, D (see diagram below), in the Lossnay inlet/outlet ducts so that the openings are directly against the air flow, and then connected to the impingers outside the ducts. The impingers are filled with 100 mL physiological salt solution. The airborne bacteria in the duct air are sampled at the rate of 10L air/minute for three minutes.

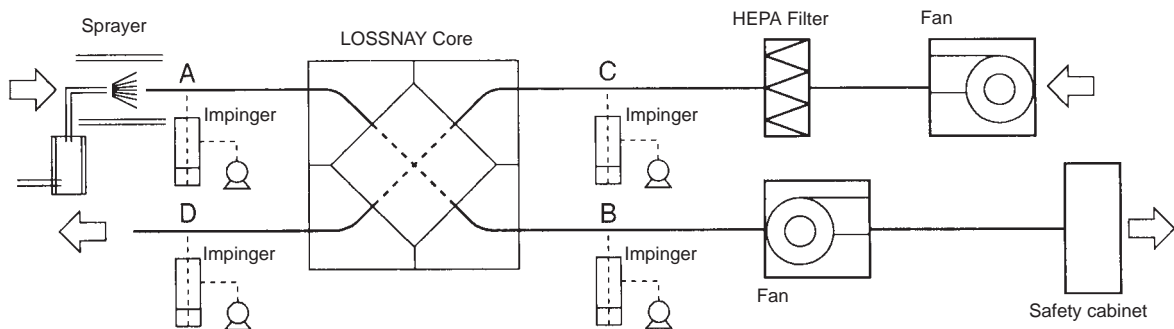

#### (5) Test Bacteria

The bacteria used in this test are as followed;

Bacillus subtilis: IFO 3134

Pseudomonas diminuta: IFO 14213 (JIS K 3835: Method of testing bacteria trapping capability of precision filtration film elements and modules; applicable to precision filtration film, etc. applied to air or liquid.)

#### (6) Test Result

The result of the test with Bacillus subtilis is shown in Table 1.

The result of the test with Pseudomonas diminuta is shown in Table 2.

**Table 1 Test Results with *Bacillus Subtilis* (CFU/30L air)**

No.	A	B	C	D
1	$5.4 \times 10^4$	$5.6 \times 10^4$	$< 10^3$	$< 10^3$
2	$8.5 \times 10^3$	$7.5 \times 10^3$	$< 10^3$	$< 10^3$
3	$7.5 \times 10^3$	$< 10^3$	$< 10^3$	$< 10^3$
4	$1.2 \times 10^4$	$1.2 \times 10^4$	$< 10^3$	$< 10^3$
5	$1.8 \times 10^4$	$1.5 \times 10^3$	$< 10^3$	$< 10^3$
Average	$2.0 \times 10^4$	$1.5 \times 10^4$	$< 10^3$	$< 10^3$

**Table 2 Test Results with *Pseudomonas Diminuta* (CFU/30L air)**

No.	A	B	C	D
1	$3.6 \times 10^5$	$2.9 \times 10^5$	$< 10^3$	$< 10^3$
2	$2.5 \times 10^5$	$1.2 \times 10^5$	$< 10^3$	$< 10^3$
3	$2.4 \times 10^5$	$7.2 \times 10^5$	$< 10^3$	$< 10^3$
4	$3.4 \times 10^5$	$8.4 \times 10^5$	$< 10^3$	$< 10^3$
5	$1.7 \times 10^5$	$3.8 \times 10^5$	$< 10^3$	$< 10^3$
Average	$2.7 \times 10^5$	$4.7 \times 10^5$	$< 10^3$	$< 10^3$

**(7) Considerations**

*Bacillus subtilis* is commonly detected in the air and resistant to dry conditions. *Pseudomonas diminuta* is susceptible to dry conditions and only a few bacterium exists in the air; however, it is used to test filter performance because the particle size is small (Cell diameter: 0.5 μm; Cell length: 1.0 to 4.0 μm).

Both *Bacillus subtilis* and *Pseudomonas diminuta* are detected at Locations A and B in the outlet side duct where they are sprayed, but neither them are detected at Location C (in the air filtered by the HEPA filter) and Location D on the inlet side.

Because the number of bacteria in Location A is substantially equal to one in Location B, it is estimated that only a few bacteria are present in the Lossnay Core on the outlet side. Also, no test bacteria are detected at Location D. The conclusion is, therefore, that the bacteria present in the outlet side will not pass through the inlet side even after the energy is exchanged.

Shunji Okada  
 Manager, Biological Section  
 Kitasato Research Center of Environmental Sciences

## 5. Lossnay Core Fire : retardant property

The Lossnay Core was also tested at General Building Research Corporation of Japan according to the fire retardancy test methods of thin materials for construction as set forth by JIS A 1322. The material was evaluated as a Class 2 flame retardant.

III C070036 (1) -2/3

JIS A 1322 <sup>-1966</sup> 「Testing Method for Incombustibility of Thin Materials for Buildings」					
THE CERTIFICATE OF FLAME RETARDANT TEST					
Test organization	General Building Research Corporation of Japan		Name of client	Mitsubishi Electric Corp., Nakatsugawa Works	
Receipt No.	III C - 0 7 - 0 0 3 6 ( 1 )		Address of client	1-3, Komaba-cho, Nakatsugawa, Gifu	
Material(s) name	Three-layer single faced corrugated fibre board		Trade name	Lossnay Core(Total heat recovery unit)	
Shape	Flat board		Weight	0.27 kg/m <sup>2</sup>	Thickness 6 mm
The outline of the test specimen					
Material composition of the test specimen (Unit : mm)					
<p>Three-layer single faced corrugated fibre board                      ...Thickness : 6mm, Weight : 0.27kg/m<sup>2</sup>                      (Single faced corrugated fibre board with 2mm cell size laminated alternately at right angle)</p> <p>Composition                      { First layer : Single faced corrugated fibre board... Thickness : 2mm, Weight : 85g/m<sup>2</sup>                      Adhesive agent : Vinyl acetate resin... Weight : 7g/m<sup>2</sup>(Solid)                      Second layer : Same as first layer                      Adhesive agent : Vinyl acetate resin... Weight : 7g/m<sup>2</sup>(Solid)                      Third layer : Same as first layer</p>					
The above description is based on client submission.					
Specimen notation	Size (mm)			Weight (g)	
No.1	296 (the long side) × 198 (the short side) × 6 (thickness)			16.7	
No.2	296 (the long side) × 198 (the short side) × 6 (thickness)			16.6	
No.3	296 (the long side) × 198 (the short side) × 6 (thickness)			16.7	
Test method					
Test standard	Pretreatment of specimen	Heating time (min)	Heating surface and directionality	Remarks	
JIS A 1322 <sup>-1966</sup> 「Testing Method for Incombustibility of Thin Materials for Buildings」 (45° Meeker burner method)	Method A (Dry method)	3	Heating surface···The smooth face Directionality····None	The smooth face of product was heated	
Date of test	28th June, 2007		Examination room condition	Room temperature: 24°C Relative humidity: 60%	
Test results					
Specimen notation	Remaining flame (sec)	Afterglow (1 minute after the heating end)	Length of carbonization (length×width) (cm)	Observation items	
No.1	0	Nothing	9.2×5.5	Soon after the start of the test, the specimen surface changed to black and smoked. After about 15sec, the specimen back surface changed to black. After about 90sec, the flame passed through the specimen.	
No.2	0	Nothing	8.5×5.4	Soon after the start of the test, the specimen surface changed to black and smoked. After about 14sec, the specimen back surface changed to black. After about 80sec, the flame passed through the specimen.	
No.3	0	Nothing	9.0×5.0	Soon after the start of the test, the specimen surface changed to black and smoked. After about 15sec, the specimen back surface changed to black. After about 90sec, the flame passed through the specimen.	
Judgment of test results	Satisfied JIS A 1322 <sup>-1966</sup> 「Testing Method for Incombustibility of Thin Materials for Buildings」 Anti-flaming Grade2 (Heating time: 3 min)				
Chief engineer	Tsuneto Tsuchihashi		Engineer	Tsuneto Tsuchihashi	

General Building Research Corporation of Japan

## 6. Lossnay Core Sound Reducing Properties Test

Because the Lossnay Core is made of paper and the permeable holes are extremely small, the core has outstanding sound reducing properties and is appropriate for ventilation in soundproof rooms.

For example, LGH-100RX<sub>3</sub>-E has sound reducing characteristics of 35.0dB with a center frequency of 500Hz, which means that a sound source of 84.4dB can be shielded to 49.4dB.

Sound Reducing Effect Test Results							
Client	Test number	IVA-01-06					
	Name	Mitsubishi Electric Corporation 1-3, Komaba-cho, Nakatsugawa-shi,					
Test Specimen	Address	Gifu 508-8666, Japan					
	Trade name	LGH-100RX <sub>3</sub> -E					
	Main composition	Air-to-Air Energy Recovery Ventilator					
	Manufacture date	May 18, 2001					
	Size (unit : mm)	W1231 × H398 × D1521 (ANNEXED DRAWINGS No.1,2 show details.)					
Note	Joint adapter in the sound receiving room side (Portion A in ANNEXED DRAWING No.1) had been filled with oil clay and then covered with onefold aluminum tape, sound insulation sheet and glass wool around duct successively.						
Standard		Test method was determined according to JIS A 1416 : 1994 "Method for laboratory measurement of sound transmission loss" and Architectural Institute of Japan Standard "Measurement method on sound transmission loss of small building elements".					
Test Method		<p>Fig. 1 Testing setup (Unit : mm)</p>					
Date of test		May 18, 2001					
Sound transmitting size		φ254 mm × 2					
Air temperature, Relative humidity		22.0°C, 62%RH (Receiving room)					
Test Results	Center frequency (Hz)	Average sound pressure level (dB)	Equivalent absorption area in receiving room A (m²)	Sound transmission loss TL (dB)	Revised sound transmission loss TLc (dB)		
		Source room Ls	Receiving room Lr	Level difference D			
	100	83.3	59.3	24.0	2.65	10	11
	125	83.8	62.8	21.0	3.21	6	6
	160	85.5	61.0	24.5	3.69	9	10
	200	86.0	58.7	27.3	3.48	12	13
	250	86.1	58.3	27.8	3.54	12	13
	315	85.0	57.0	28.0	3.96	12	12
	400	86.2	54.3	31.9	4.40	16	16
	500	84.4	49.4	35.0	4.62	18	19
	630	84.7	50.7	34.0	4.80	17	17
	800	85.5	48.7	36.8	5.06	20	20
	1000	87.0	47.7	39.3	5.58	22	22
	1250	89.2	47.7	41.5	6.26	24	24
	1600	89.3	47.4	41.9	7.03	23	23
	2000	90.7	47.0	43.7	7.57	25	25
	2500	92.8	48.2	44.6	8.62	25	25
3150	83.4	48.2	45.2	10.19	25	25	
4000	95.0	48.8	46.2	12.42	25	25	
5000	95.0	47.6	47.4	15.51	26	26	
<b>Notes:</b> 1. The graph shows level difference with (revised) sound transmission loss. 2. Test specimen area (Sound transmitting area) is: $S = 0.10134\text{m}^2$ (φ254mm × 2) for calculating (revised) sound transmission loss. 3. An arithmetic mean of revised sound transmission loss (1/3 octave, 125Hz - 4000Hz)....18.4dB							
Test laboratory		Heat & Acoustics Laboratory, Building Physics Dept. General Building Research Corporation of Japan 5-8-1 Fujishirodai, Suita-shi, Osaka 565-0873, Japan					
Responsible parties		Iwao Kurahashi (Head) Takao Waki (Section chief) Mitsuo Morimoto (Section chief)					

## 7. Changes in the Lossnay Core

An example of a building with Lossnay units installed, that has been used as a case study to assess the changes in the units.

### 7.1 Building Where Lossnay is Installed

- (1) **Building** : Meiji Seimei, Nagoya Office/shop building  
1-1 Shinsakae-machi Naka-ku, Nagoya
- (2) **No. of Floors** : 16 above ground, 2-story penthouse, 4 basement floors
- (3) **Total Floor Space** : 38,893 m<sup>2</sup>
- (4) **Reference Floor Space** : 1,388 m<sup>2</sup>

### 7.2 Specifications of Installed Ventilation Equipment

- (1) **Air Handling Method** : 4 fan coil units (perimeter zone) per floor  
**Chilling Unit** : Absorption-type 250 kT × 1 unit, turbo 250 kT × 2 units  
**Gas Direct Heating/Cooling Boiler** : 340 kT, heating 1,630 kW
- (2) **Ventilation Method** : Air - air total energy recovery unit "Lossnay"  
 LS-200 × 18 units installed in penthouse.  
 Outdoor air treatment volume: 46,231 CMH,  
 Exhaust air treatment volume: 54,335 CMH.

+

- (3) **Lossnay Units Used** : LS-200\* (with four Lossnay Cores)

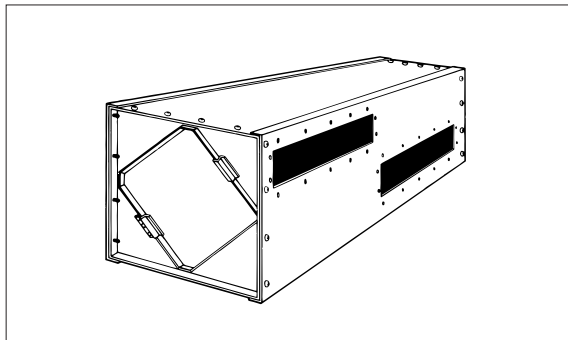

Lossnay Duct System Diagram

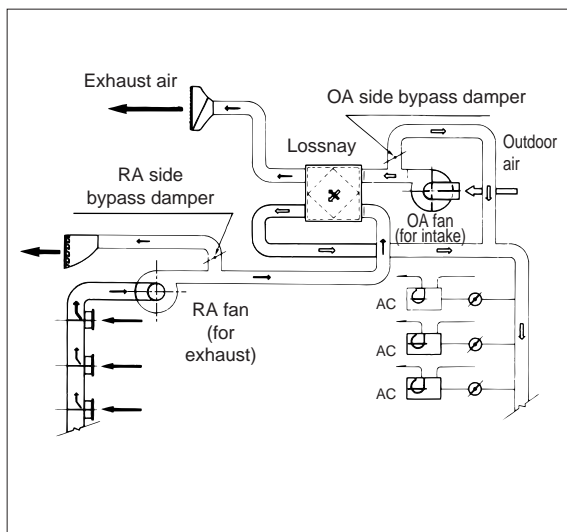
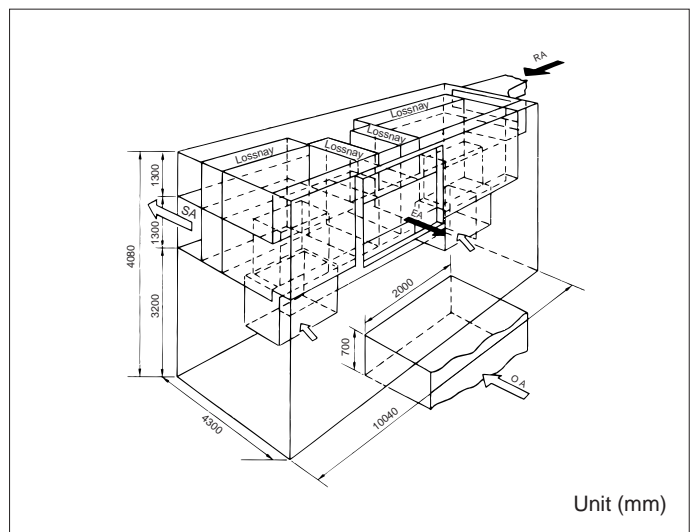

Diagram of Lossnay Penthouse Installation



### 7.3 Lossnay Operation

- (1) **Unit Operation Began** : September 1972  
**Daily Operation Began** : 7:00  
**Daily Operation Stops** : 18:00 } Average daily operation: 11 hours
- (2) **Inspection Date** : November 1983
- (3) **Months When Units are in Bypass Operation** : Three months of April, May, June
- (4) **Total Operation Time** : (134 – 33) months × 25 days/month × 11 hours/day = 27,775 hours

### 7.4 Changes Detected in the Lossnay Core

Two Lossnay Cores were removed from the 18 Lossnay LS-200 installed, and static pressure loss and exchange efficiencies were measured. See chart on right that compares initial operation to same unit 11 years later. The appropriate air volume for one Lossnay Core was 500 m<sup>3</sup>/hr, and the measurement point was ±200 m<sup>3</sup>/hr of that value.

Changes Detected in the Lossnay Core

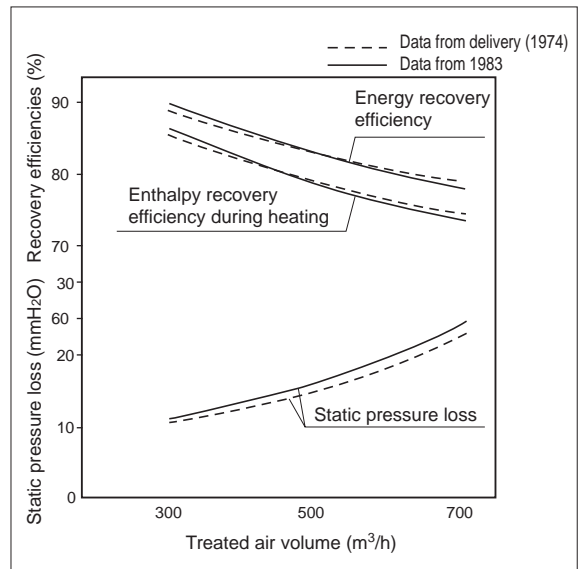

### 7.5 Conclusion

- (1) Changes in the the Lossnay Core after approximately 11 years of use and an estimated 28,000 operation hours were not found.  
 The static pressure loss was 150 to 160 Pa at 500 m<sup>3</sup>/hr, which was a 10 Pa increase. The exchange efficiencies had decreased slightly to above 500 m<sup>3</sup>/hr, however, this is considered to be insignificant and remained in the measurement error range.
- (2) The Core surface was black with dust, but there were no gaps, deformed areas, or mold that would pose problems during practical use.



## 8. Comparing Energy Recovery Techniques

### Basic Methods of Total Energy Exchangers

Energy recovery principle	Type	Method	Air flow	Country of development
Energy recovery principle	Static (Mitsubishi Lossnay)	Conductive transmission type	Cross-flow	Japan
	Rotary type	Heat accumulation/ humidity accumulation type	Counterflow	Sweden

### 8.1 Principle Construction of Rotary-type Energy Recovery Techniques

- Rotary-type energy recovery units have a rotor that has a layered honeycomb structure made of kraft paper, drive motor and housing.

A large quantity of moisture absorbent material (lithium chloride, etc.) is applied onto the rotor, and humidity is transferred. The rotor rotates eight times a minute by the drive motor.

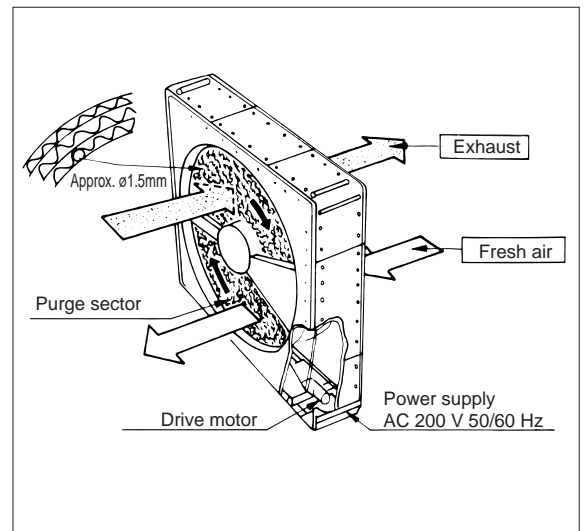

- Rotary-type energy recovery units, when cooling, the high temperature and high humidity ventilation air passes through the rotor, with the heat and humidity being absorbed by the rotor. When the rotor rotates, it moves into the exhaust air passage, and the heat and humidity is discharged to the outdoors because the exhaust is cool and has low humidity. The rotor rotates and returns to the ventilation air passage to absorb the heat and humidity again.

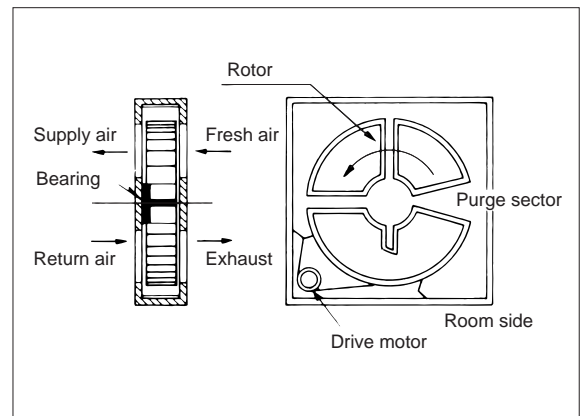

- Function of the purge sector

There are two separation plates (purge sectors) in the front and back of the rotor to separate airflow. Because one of the plates is slightly shifted, part of the ventilation air always flows into the exhaust air passage to prevent the exhaust air and ventilation air from mixing. (A balanced pressure difference is required.)

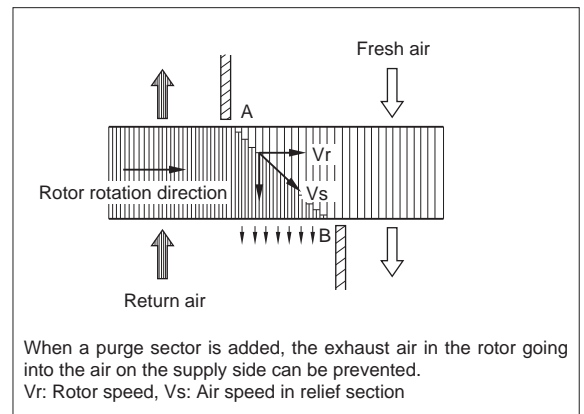

## 8.2 Comparing Static-type and Rotary-type Energy Recovery Units

Specification	Static-type		Rotary-type	
Construction/ Principle	Conductive transmission-type: cross-flow Static-type transmission total energy recovery unit with orthogonally layered honeycomb-shaped treated paper formed into multiple layers. ● As the supply air and exhaust air pass through different passages (sequentially layered), the air passages are completely separated.		Heat accumulation/humidity accumulation-type: counterflow The rotor core has honeycomb-shaped kraft paper, etc., to which a moisture absorbent is applied (lithium chloride, etc.). The rotor rotates, and heat accumulation/humidity accumulation - heat discharge/humidity discharge of total energy exchange is performed by passing the exhaust and intake airflows into a honeycomb passage. × Supply air and exhaust airflows go into the same air passage because of the rotary-type construction.	
Moving Parts	● None Fixed core		× Rotor driven with belt by gear motor Rotor core (8 rpm)	
Material Quality	Treated paper		Treated paper, aluminum plates, etc.	
Prefilter	Required (periodic cleaning required)		Required (periodic cleaning required)	
Element Clogging	● Occurs (State where dirt adheres onto the element air passage surface; however, this is easily removed with a vacuum cleaner.)		× Occurs (Dust is smeared into element air passage filter.) (The dust adhered onto the core surface is smeared into the air passage by the purge sector packing. It cannot be removed easily and thus the air volume decreases.)	
Air Leakage Gas Transmission Rate	Approximately 2.5% air leak at standard fan position. Leaks found on the air supply side can be reduced to 0 by leaking the loss air volume (approx. 10%) on the exhaust side with the fan position to the core. ● Gas transmission ( Ammonia : 28%, hydrogen sulfide : approx. 6.7%)		× Purged air volume occurs To prevent exhaust leaking to the air intake side, a purge air volume (6 to 14%) leak is created on the exhaust side. Thus, there are problems in the purge sector operation conditions (pressure difference, speed), and the air volume must be balanced. × Gas transmission ( Ammonia : 45-57%, hydrogen sulfide : approx. 3.2-4%)	
Bacteria Transmission Rate	● Low (Because air intake/exhaust outlets are separate, transmission is low.)		× High (Because air intake/exhaust outlets are the same, transmission is high.)	
Operation During Off Seasons	Bypass circuit required (Permitted on one side of air intake and exhaust air outlet passage)		Bypass circuit required (Required on both air intake and exhaust air outlet sides) (In theory, operation is possible by stopping the rotation, but the core will over-absorb, and cause damage.)	
Maintenance	Core cleaning: More than once a year The core surface will clog with lint and dirt, but cleaning is easy with a vacuum cleaner. Only the two core air passage intakes need to be cleaned.		Core cleaning: Once every one to two years Cleaning is difficult as dust is smeared into core by the purge sector packing. × Gear motor for rotor drive : Periodic inspection × Rotor bearing, rotor drive belt : Periodic inspection	
Life	Core: Semi-permanent (10 years or more) Static-type units do not break.)		Core: Semi-permanent (10 years or more) (Periodic replacement is required because of the rotor bearings and the core clogging.) × Rotor drive belt : Periodic replacement × Drive motor, rotor bearing : Periodic replacement	
Model is Available	○ Available from small to large. ○ Characteristic design of small and medium models are possible. Large models are easy to match to a machine room layout.	Example LU-1605	Large type only × Small models are difficult to design because of the rotor magnitude.	Example EV-1500
Standard Treatment Air Volume	40 to 25,000 m <sup>3</sup> /h	8,000 m <sup>3</sup> /h	○ 100 to 63,000 m <sup>3</sup> /h	8,000 m <sup>3</sup> /h
Enthalpy Recovery Efficiency		Temperature: 77% Enthalpy Heating: 71% Cooling: 66%		74%
Pressure Loss		170 Pa		180 Pa
Installation Space (W × D × H) (mm)	Effective for small to medium capacity (Layout depends on combination chosen.)	600 × 2100 × 2540	Large capacity models are effective	320 × 1700 × 1700

Measure of useability

● : High ○ : Average × : Poor

**CHAPTER 4**  
**Characteristics**

# 1. How to Read the Characteristic Curves

## 1.1 Obtaining Characteristics from Static Pressure Loss

- (1) Static pressure loss from a straight pipe duct length (at required air volume)
- (2) Static pressure loss at a curved section (at required air volume)
- (3) Static pressure loss of related parts (at required air volume)

↓  
Total static pressure loss

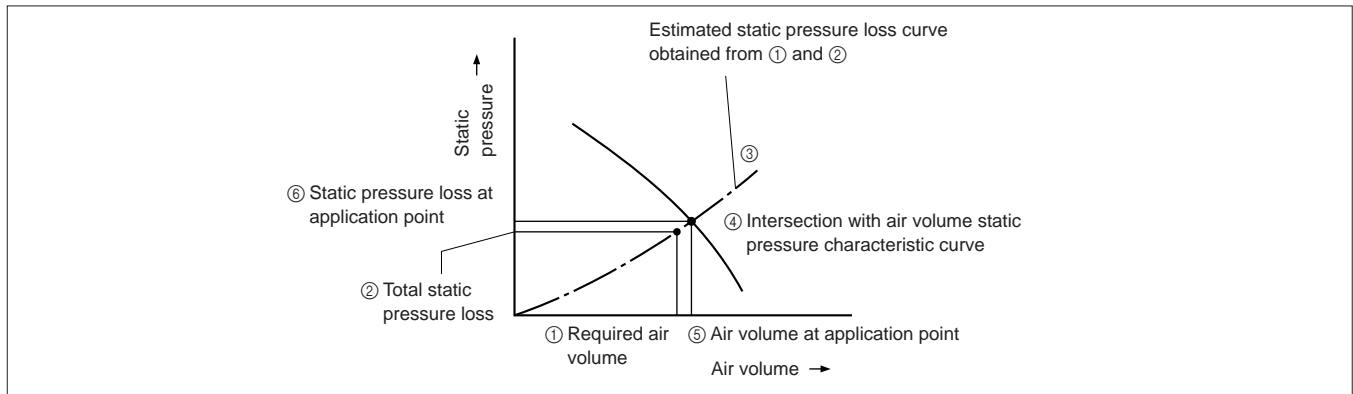

## 2. Calculating Static Pressure Loss

### 2.1 How to Read the Air Volume - Static Pressure Curve

It is important to know the amount of static pressure loss applied onto the Lossnay when using ducts for the air distribution. If the static pressure increases, the air volume will decrease. The air volume - static pressure curve (Q-H curve) example shows the percentage at the decrease. A static pressure of 65 Pa is applied to Point A, and the air volume is 500 m<sup>3</sup>/h. The duct resistivity curve shows how the static pressure is applied when a duct is connected to the Lossnay. Thus, the L = 9.97 m duct resistivity curve in the diagram shows how the static pressure is applied when a 10 m duct is connected. Intersecting Point A on the Lossnay Q-H curve is the operation point.

#### Example

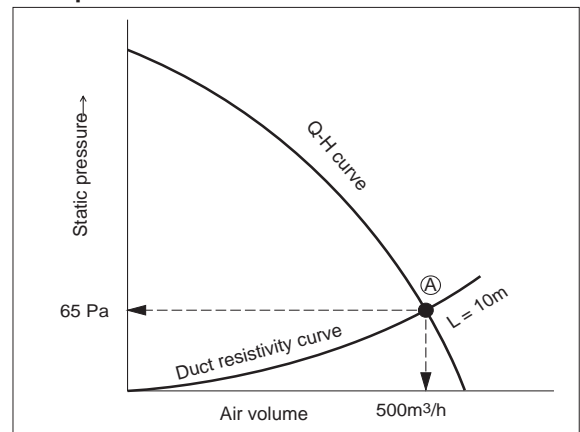

#### Duct Resistivity Curve

The duct resistivity curve shows how much static pressure a duct will apply on the Lossnay.

In general, the relation between the duct and static pressure is as follows:

Duct	Static Pressure
When duct is long	Increases
If length is the same but the air volume increases	Increases
If the duct diameter is narrow	Increases
If the duct inner surface is rough (such as a spiral)	Increases

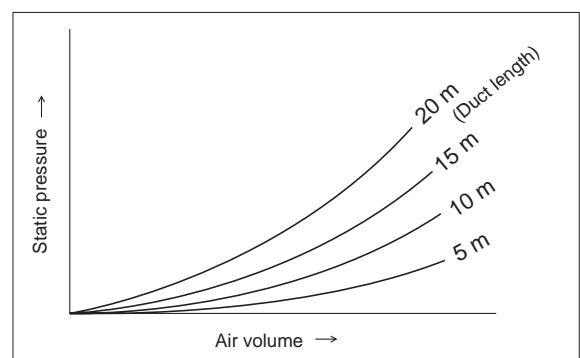

Reference

Pressure loss caused by velocity (Pa)

$$= \frac{r}{2} \times V^2 = \frac{1.2}{2} \times (\text{velocity})^2$$

- { r : Air weight 1.2 kg/m<sup>3</sup>
- { v : Velocity (m/s)

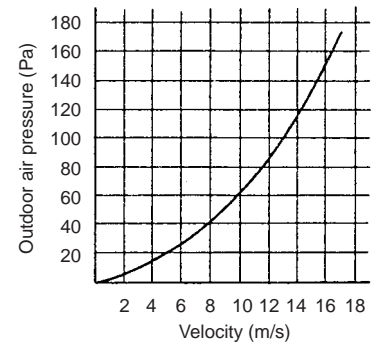

2.2 Calculating of Duct Pressure Loss

When selecting a model that is to be used with a duct, calculate the volumes according to Tables 3, 4, 5 and 6, and then select the unit according to the air volume and static pressure curve.

(1) Calculating a Rectangular Pipe

Table 3. Conversion Table from Rectangular Pipe to Round Pipe

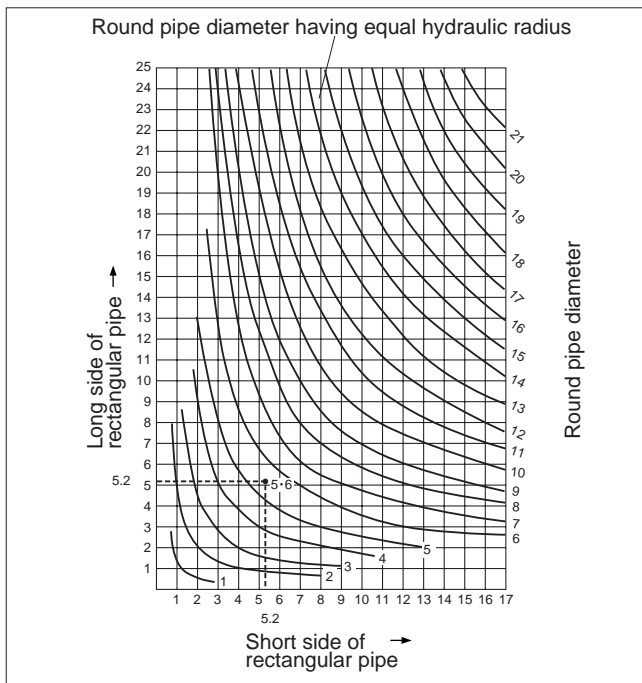

How to read Table 3

Convert a rectangular pipe (in this case, a square pipe: 520 mm each side, for example) to a round pipe in diameter, using this table. The maximum value for the short side of rectangular pipe is 17 in the table, therefore divide 520 by 100 and it results in 5.2. The round pipe diameter 5.6 is shown by the cross-point of two lines: long side of rectangular pipe 5.2 and short side of rectangular pipe 5.2. Finally, multiply 5.6 by 100 and find that the rectangular (square) pipe is equal to the ø 560 mm round pipe.

(2) Obtaining the Duct Resistivity

Table 4. Round Duct Friction Loss (steel plate duct, inner roughness ε = 0.18 mm)

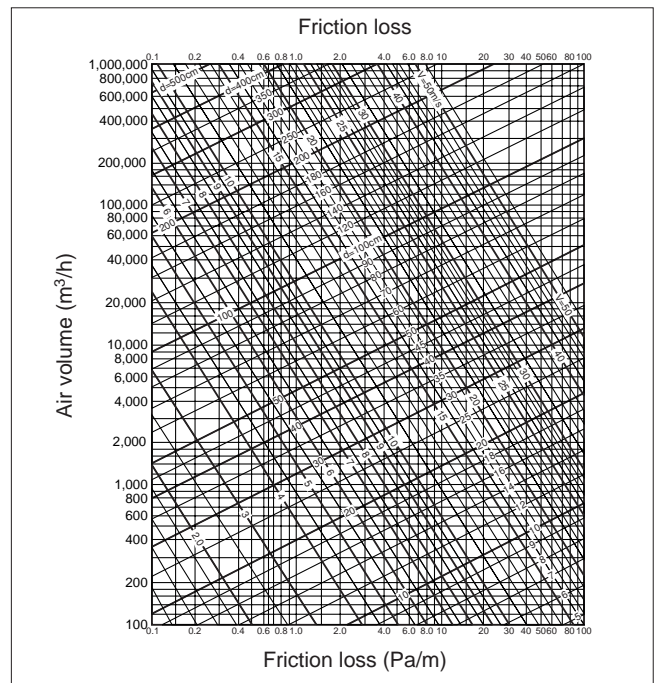

How to read Table 4

The point where the line of the round duct diameter (left slanting line) and of the required air velocity (horizontal line) intersect is the pressure loss per 1 m of duct. The value of the slanted line on the lower right of the intersecting point is the average velocity.

(Outline of Table 4)

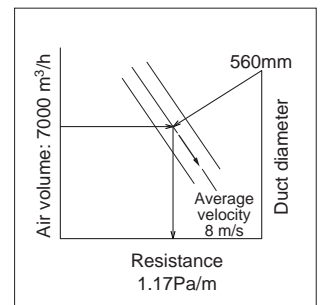

## CHAPTER 4 ● Characteristics

Data obtained from Table 4 must then be corrected for duct type at various velocities using Table 5 below.

**Table 5. Friction Coefficient Compensation Table**

Inside Surface of Duct	Example	Average Velocity (m/sec.)			
		5	10	15	20
Very Rough	Concrete Finish	1.7	1.8	1.85	1.9
Rough	Mortar Finish	1.3	1.35	1.35	1.37
Very Smooth	Drawn Steel Pipe, Vinyl Pipe	0.92	0.85	0.82	0.8

An alternative, more detailed method for determining the pressure loss in duct work uses the following formula:

Round pipe section pressure loss	$\lambda$ : Friction resistance coefficient (smooth pipe 0.025)
$\Delta p = \lambda \cdot \frac{\ell}{d} \cdot \frac{\rho}{2} \cdot v^2$ (Pa)	C : Local loss coefficient (refer to Table 6)
	d : Duct diameter (m)
	$\ell$ : Duct length (m)
	$\rho$ : Air weight (1.2 kg/m <sup>2</sup> )
	v : Wind velocity (m/s)
$\Delta p = C \cdot \frac{\rho}{2} \cdot v^2$ (Pa)	
= 0.6 C · v <sup>2</sup>	

(3) How to Calculate Curved Sections in Ductwork

Table 6. Pressure Losses in Each Duct Area

No.	Duct Area	Outline Diagram	Conditions	C Value	Length of Equivalent Round Pipe	No.	Duct Area	Outline Diagram	Conditions	C Value	Length of Equivalent Round Pipe																											
1	90° Smooth Elbow		R/D = 0.5	0.73	43D	12	Transformer			0.15	9D																											
			= 0.75	0.38	23D																																	
			= 1.0	0.26	15D																																	
			= 1.5	0.17	10D																																	
			= 2.0	0.15	9D																																	
2	Rectangular Radius Elbow		W/D	R/D		13	Short Entrance			0.50	30D																											
			0.5	0.5	1.30							79D																										
				0.75	0.47							29D																										
				1.0	0.28							17D																										
				1.5	0.18							11D																										
			1-3	0.5	0.95							57D																										
				0.75	0.33							20D																										
				1.0	0.20							12D																										
				1.5	0.13							8D																										
				3	Rectangular Vaned Radius Elbow								No. of vanes	R/D		14	Short Exit			1.0	60D																	
1	0.5	0.70				42D																																
	0.75	0.16	10D																																			
	1.0	0.13	8D																																			
	1.5	0.12	7D																																			
2	0.5	0.45	27D																																			
	0.75	0.12	7D																																			
	1.0	0.10	6D																																			
	1.5	0.15	9D																																			
	4	90° Miter Elbow					0.87	53D	15	Bell-shaped Entrance				0.03	2D																							
				5	Rectangular Square Elbow			1.25				76D				16	Bell-shaped Exit			1.0	60D																	
6							Rectangular Vaned Square Elbow															0.35	21D	17	Re-entering inlet			0.85	51D									
												7										Rectangular Vaned Square Junction									0.87	53D	18	Sharp edge, round orifice		Loss is for V2	2.8	170D
																														0.25							2.4	140D
	0.50	1.9	110D																																			
	0.75	1.5	90D																																			
1	1.0	60D																																				
8	Rectangular Vaned Radius Junction			0.87	53D	19	Pipe inlet (with circular hood)		beta	20°	0.02																											
			40°							0.03																												
			60°							0.05																												
			90°							0.11																												
			120°							0.20																												
9	45° Smooth Elbow		With or without vanes, rectangular or round	1/2 times value for similar 90°		20	Pipe inlet (with rectangular hood)		beta	20°	0.03																											
			a = 5°	0.17	10D																																	
			10°	0.28	17D																																	
			20°	0.45	27D																																	
			30°	0.59	36D																																	
40°	0.73	43D																																				
10	Expansion		Loss is for hV1 - hV2			21	Short contraction			Loss is for V2	0.5	30D																										
			0.25	0.45	27D																																	
			0.50	0.32	19D																																	
			0.75	0.18	11D																																	
11	Contraction		Loss is for V2			22	Short expansion			Loss is for V1	1.0	60D																										
			a = 30°	0.02	1D																																	
			45°	0.04	2D																																	
			60°	0.07	4D																																	
23	Suction inlet (punched narrow plate)		Free are ratio			23				0.2	35																											
			0.4	7.6																																		
			0.6	3.0																																		
			0.8	1.2																																		

### 3. How to Obtain Efficiency from Characteristic Curves

#### How to Read Characteristic Curve

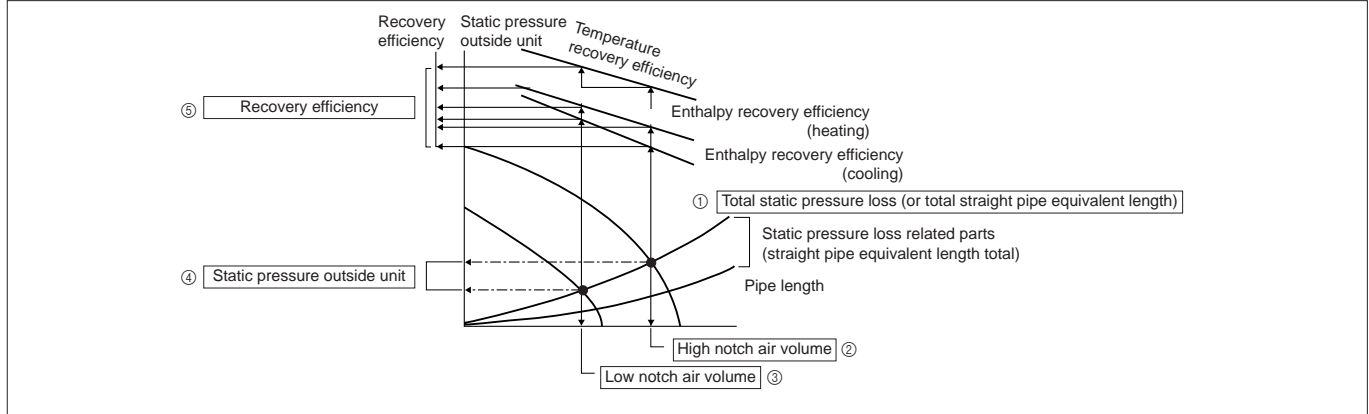

- Obtaining the efficiency when supply air and exhaust air volumes are different. The efficiency obtained from the intake side air volume in each characteristic curve can be corrected with the air volume ratio in the bottom right chart. If the intake side and exhaust side duct lengths are greatly different or if a differential air volume is required, obtain the intake side efficiency from the bottom right chart.

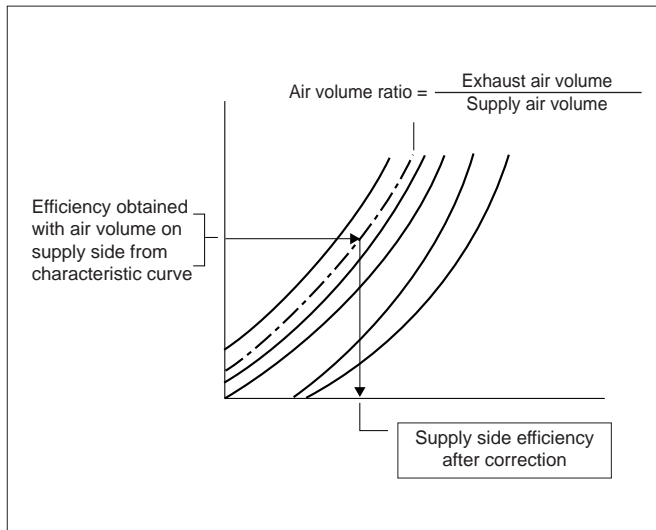

#### Energy Recovery Efficiency Correction Curve

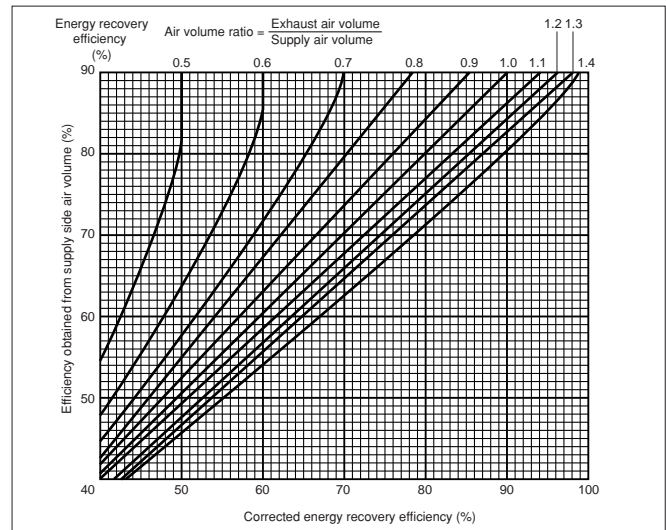



## 4. Sound

Sound is vibration transmitted through an object. The object that vibrates is called the sound source, and energy that is generated at the source is transmitted through the air to the human ear at certain frequencies.

### 4.1 Sound Levels and Auditory Perception

Sound level is the sound wave energy that passes through a unit area in a unit time, and is expressed in dB (decibel) units.

The sound heard by the human ear is different according to the strength of the sound and the frequency, and the relation to the tone (see chart on the right). The vertical line shows the strength of the sound and the horizontal line shows the frequency. For frequencies between 20 Hz to 15,000 Hz which can be detected by the human ear, the strength of sound that can be detected that is equivalent to a 1,000 Hz sound is obtained for each frequency. The point where these cross is the sound level curve, and a sound pressure level numerical value of 1,000 Hz is expressed. These are called units of phons; for example, the point on the 60 curve is perceived as 60 phons.

- On average, the human detects sounds that are less than 1,000 Hz as rather weak, and sounds between 2,000 to 5,000 Hz as strong.

ISO Audio Perception Curve

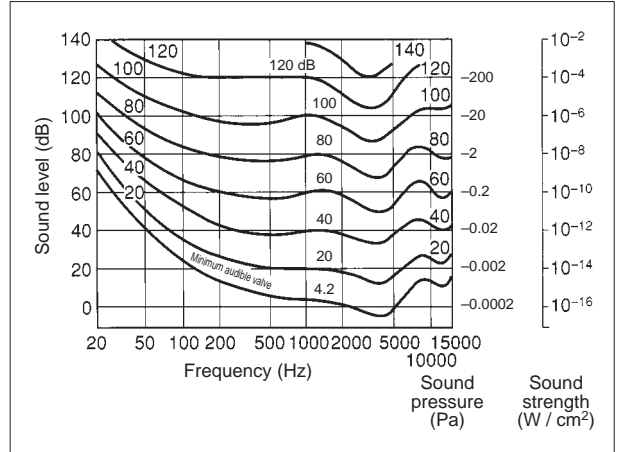

### 4.2 How to Measure Sound Levels

A sound level meter (JIS C 1502, IEC 651) is used to measure sound levels and has three characteristics (A\*<sup>1</sup>, C\*<sup>2</sup> and Flat) as shown on the right. These represent various sound wave characteristics. Generally, Characteristic A, which is the most similar to the human ear, is used. The value measured with the Lossnay unit operating includes noise caused by the unit and background noise\*<sup>3</sup>.

- \*1. Characteristic A is a sound for which the low tones have been adjusted to be similar to the auditory perception of the human ear.
- \*2. Characteristic C is a sound for which the high and low tones have been adjusted slightly.
- \*3. Background noise: any sound present in the target location when no sound is being produced.

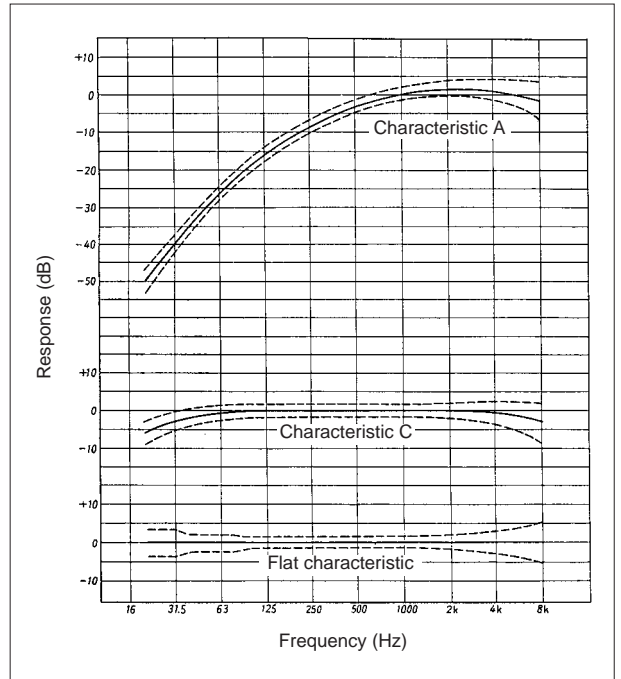

### 4.3 Sound Frequency Analysis

The human ear detects sound differently according to the frequency; however, the sound generated from vibrations is not limited to one frequency, but instead, various frequencies are generated at different levels. NC curve will show how the various frequencies are generated at different levels, which is determined according to the difficulty of detecting conversations.

- Even if the sound is a very low level, it can be detected if it has a specific and loud frequency.  
 These sounds are low during product design stages, but sounds may become very disturbing if resonating on ceilings, walls, etc.

**Example: Continuous Frequency Analysis**

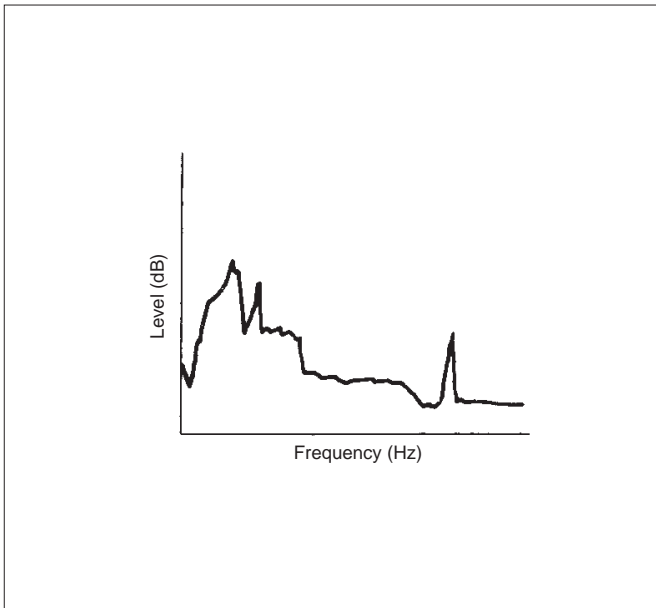

**NC Curve**

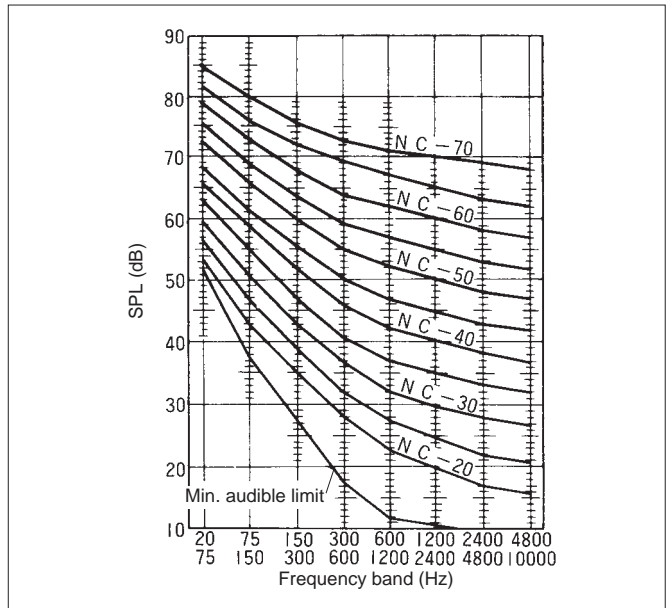

● **Tolerable Sound Levels and NC Values According to Room Application**

Room Application	dB	NC Value	Room Application	dB	NC Value
Broadcasting studio	25	15 - 20	Cinema	40	30
Music hall	30	20	Hospital	35	30
Theater (approx. 500 seats)	35	20 - 25	Library	40	30
Classroom	40	25	Small office	45	30 - 35
Conference room	40	25	Restaurant	50	45
Apartment	40	25 - 30	Gymnasium	55	50
Hotel	40	25 - 30	Large conference room	50	45
House (living room)	40	25 - 30	Factory	70	50 or more

- \* Approximate values of sound levels using practical examples  
The following diagram shows typical everyday sounds.  
Approximate degree of sound levels can be seen.
- \* Sound levels and perception

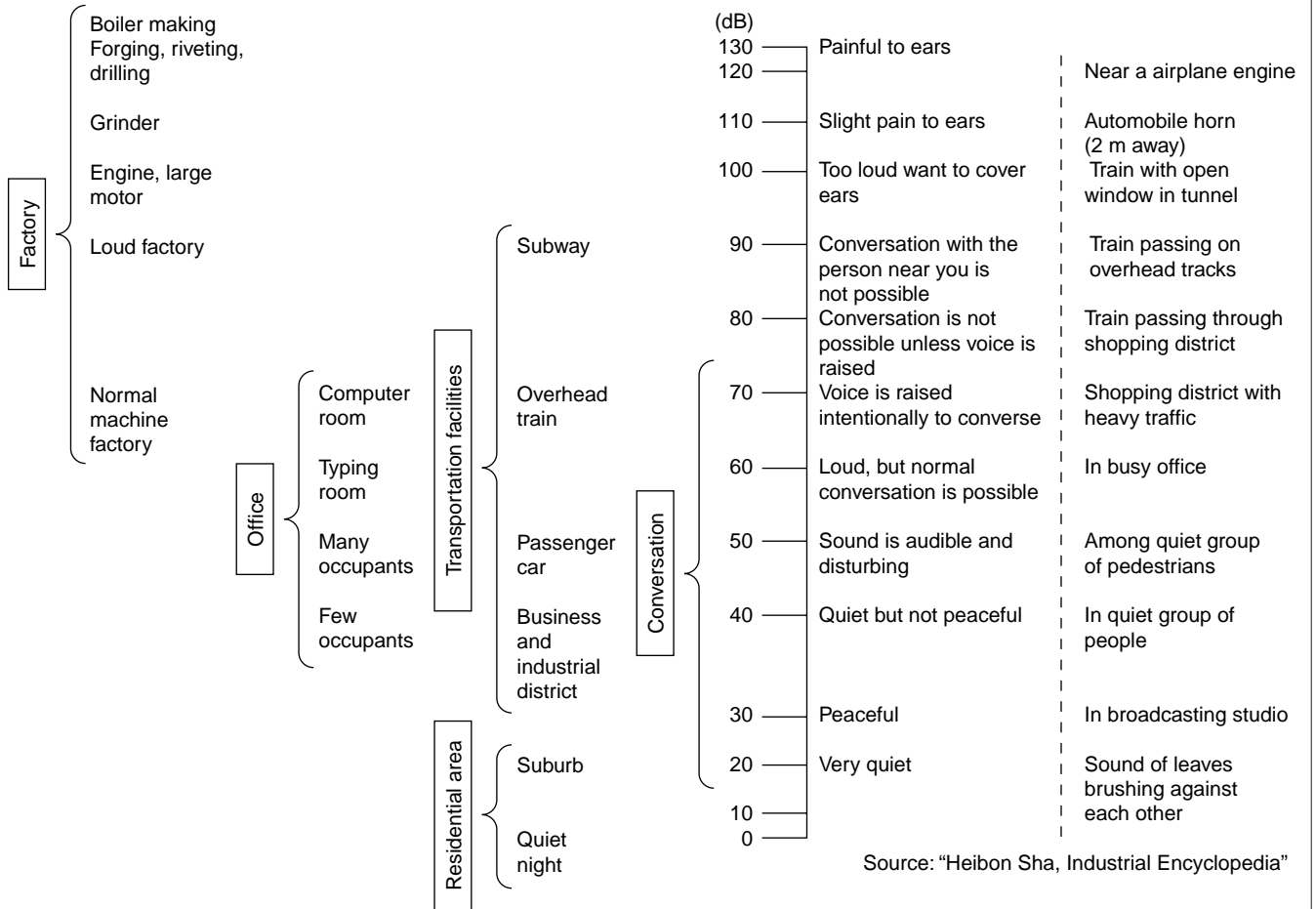

## 4.4 Indoor Sounds

### (1) Indoor Sounds Principles

1) Power Levels

The Power level of the sound source (PWL) must be understood when considering the effects of sound. See formula below to obtain PWL from the measured sound pressure data in an anechoic chamber.

$$PWL = SPL_o + 20 \log (r_o) + 11 \text{ [dB]} \dots\dots\dots (I)$$

{

PWL : Sound source power level (dB)

SPL<sub>o</sub> : Measured sound pressure in anechoic chamber (dB)

r<sub>o</sub> : Distance from the unit to measuring point (m)

2) Principal Model

Consider the room shown in Figs. 1 and 2.

- Fig. 1 shows an example of an integrated unit (similar to a cassette-type Lossnay unit) and supply air diffuser (with return grille).
- Fig. 2 shows an example of a separated unit (similar to a ceiling-embedded type Lossnay unit) and supply air diffuser (with return grille).
- (a) is the direct sound from the supply air diffuser (return grille), and (b) is the echo sound. (c) (c<sub>1</sub> to c<sub>3</sub>) is the direct sound emitted from the unit and duct that can be detected through the finished ceiling. (d) is the echo sound of (c).

3) Position of Sound Source and Sound Value

$$SPL \text{ [dB]} = PWL + 10 \log \left\{ \frac{Q}{4\pi r^2} + \frac{4}{R} \right\} \dots\dots\dots (II)$$

$\frac{Q}{4\pi r^2}$   
 (i)

$\frac{4}{R}$   
 (ii)

- {
- SPL : Sound pressure level at reception point [dB]
  - PWL : Power level of sound source [dB]
  - Q : Directivity factor (Refer to Fig. 3)
  - r : Distance from sound source [m]
  - R : Room constant [R =  $\bar{\alpha}S / (1 - \bar{\alpha})$ ]
  - $\bar{\alpha}$  : Average sound absorption ratio in room (Normally, 0.1 to 0.2)
  - S : Total surface area in room [m<sup>2</sup>]

Fig. 1.

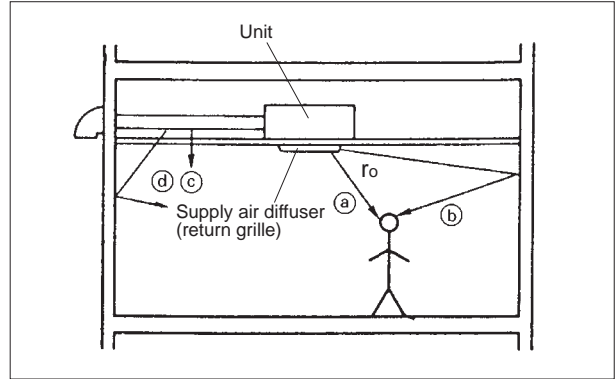

Fig. 2.

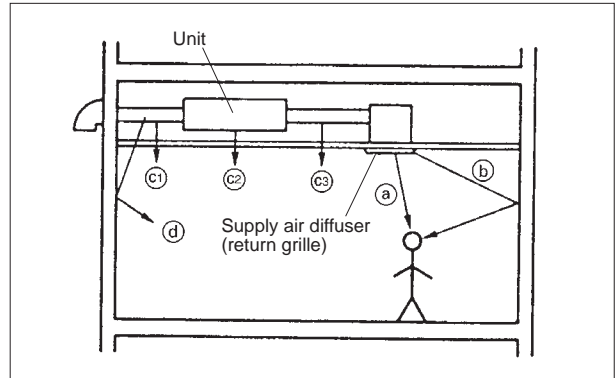
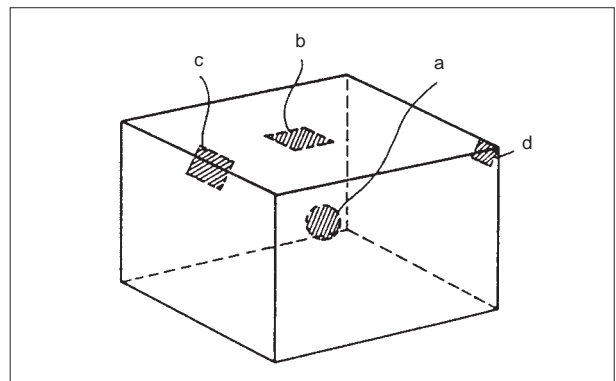

Fig. 3. (Position of Sound Source and Directivity Factor Q)



	Position of Sound Source	Q
a	Center of room	1
b	Center of ceiling	2
c	Edge	4
d	Corner	8

- For the supply air diffuser (and return grille) in Fig. 2, PWL must be corrected for the sound transmission loss from the duct work (TL) such that:

$$PWL' = PWL - TL$$

- Item (i) in formula (II) page 48 is the direct sound ( (a), (c) ), and (ii) is the echo sound ( (b), (d) ).
- The number sources of sound in the room (main unit, supply air diffuser, return grille etc.) is obtained by calculating formula (II), and combining the number with formula (III).

$$SPL = 10 \log (10^{SPL_1/10} + 10^{SPL_2/10}) \dots\dots\dots(III)$$

- The average sound absorption rate in the room and the ceiling transmission loss differ according to the frequency, so formula (II) is calculated for each frequency band, and calculated values are combined by formula (III) for an accurate value. (When A-range overall value is required, subtract A-range correction value from calculated values of formula (II), and then combine them by formula (III).)

**Transmission Loss in Ceiling Material (dB) Example**

	Plaster Board (7mm thick)	Plaster Board (9mm thick)	Lauan Plywood (12mm thick)
Average	20	22	23
Frequency band (Hz)	125	10	20
	250	11	21
	500	19	23
	1,000	26	26
	2,000	34	35
4,000	42	39	—

**(2) Reducing Lossnay Unit Operating Sound**

- 1) When the airflow of the unit from above the ceiling is the sound source.  
(See page 48: Fig. 1 (c), (d), Fig. 2 (c1) to (c3), (d))
  - (A) Do not install the unit using the following specifications if disturbing sound could be emitted from large units. (Refer to Fig. 4)
    - a) Decrease in diameters in the ductwork:  
(Ex.  $\phi 250 \rightarrow \phi 150$ ,  $\phi 200 \rightarrow \phi 100$ )
    - b) Curves in aluminum flexible ducts, etc.  
(Especially if immediately installed after unit outlet)
    - c) Opening in ceiling panels
    - d) Hanging the unit on materials that cannot support the weight.
  - (B) The following countermeasures should be taken. (Refer to Fig. 5)
    - a) Use ceiling material with high soundproofing properties (high transmission loss). (Care is required for low frequency components as the difference in material is high).
    - b) Adding of soundproofing materials to areas below the source of the sound.  
(The entire surface must be covered with soundproofing sheets. Note that in some cases, covering the area around the unit may not be possible due to generated heat.)

**Fig. 4. Large Unit Installation (Example)**

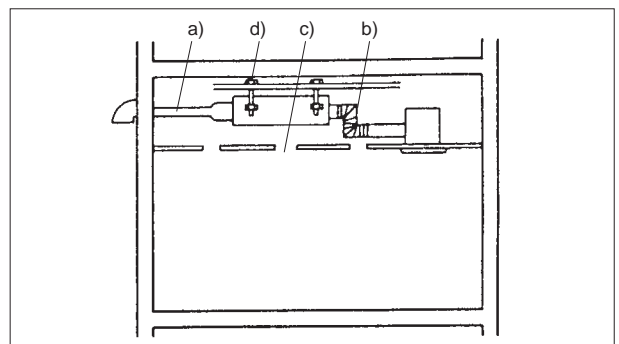

**Fig. 5. Countermeasure (Example)**

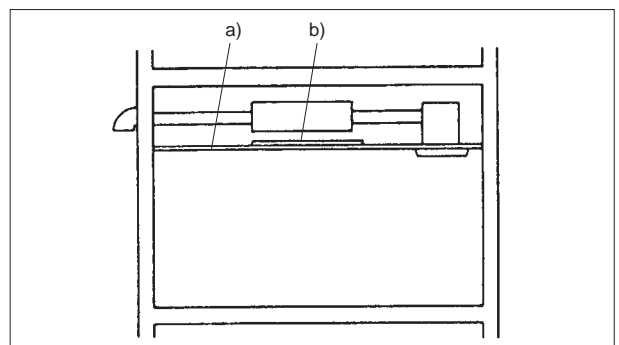

2) When supply air diffuser (and return grille) is the source of the sound  
Part 1

(A) If the main unit is separated from the supply air diffuser (and return grille) as shown in Fig. 6, installing an a) silencer box, b) silence duct or c) silence grille is recommended.

**Fig. 6 Sound from Supply Air Diffuser**

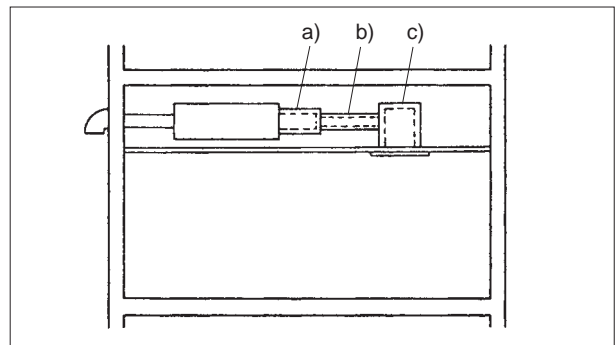

(B) If sound is being emitted from the supply air diffuser (and return grille), a) branch the flow as shown in Fig. 7, b) add a grille to lower the flow velocity and add a silencer duct to section b). (If the length is the same, a silencer duct with a small diameter is more effective.)

**Fig. 7 Countermeasure (Example)**

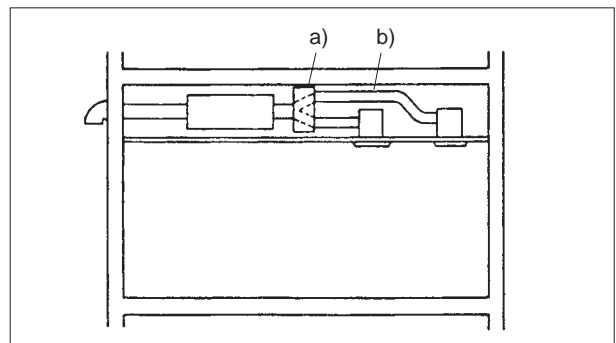

3) When supply air diffuser (and return grille) is the source of the sound  
Part 2

(A) If the main unit and supply air diffuser (and return grille) are integrated as shown in Fig. 8, or if the measures taken in 2) (A) and (B) are inadequate, add soundproofing material that has a high sound absorbency as shown in Fig. 8 a). This is not, however, very effective with direct sounds.

**Fig. 8 Additional Countermeasure (Example)**

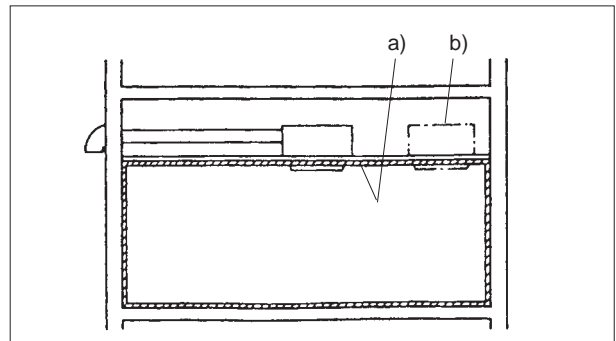

(B) Installing the sound source in the corner of the room as shown in Fig. 8 b) is effective with sound emitted from center of the room, but will be inadequate towards sound emitted from corner of the room.

## 5. NC Curves ( Products for 50Hz area )

### LGH-15RX5-E

Background noise : 25 dB or less (A range)  
 Measurement site : Anechoic chamber  
 Operation conditions : Lossnay ventilation  
 Power supply : 220 V 50 Hz

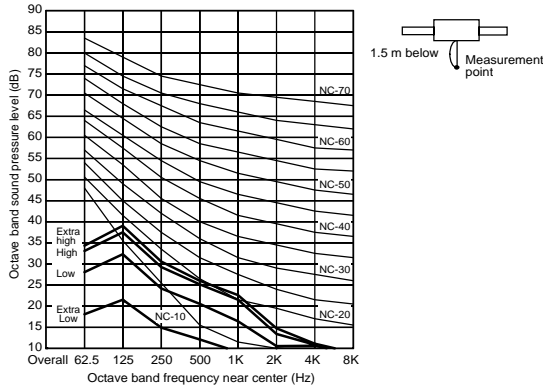

Background noise : 25 dB or less (A range)  
 Measurement site : Anechoic chamber  
 Operation conditions : Lossnay ventilation  
 Power supply : 240 V 50 Hz

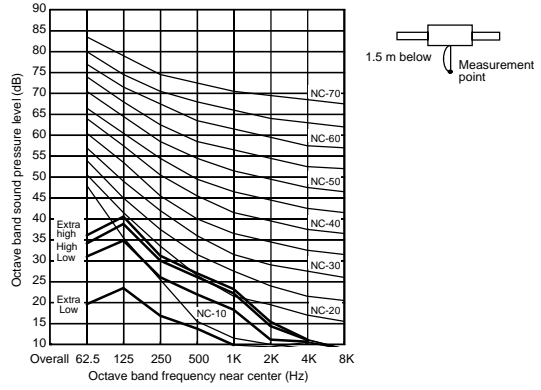

### LGH-25RX5-E

Background noise : 25 dB or less (A range)  
 Measurement site : Anechoic chamber  
 Operation conditions : Lossnay ventilation  
 Power supply : 220 V 50 Hz

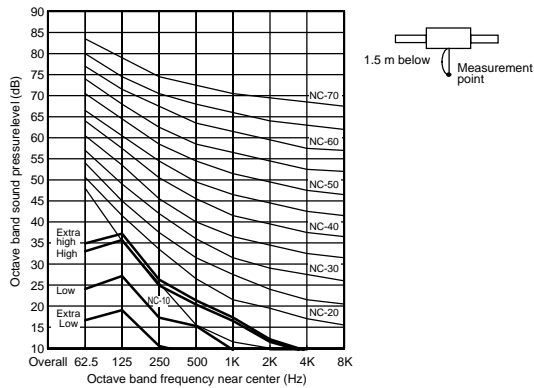

Background noise : 25 dB or less (A range)  
 Measurement site : Anechoic chamber  
 Operation conditions : Lossnay ventilation  
 Power supply : 240 V 50 Hz

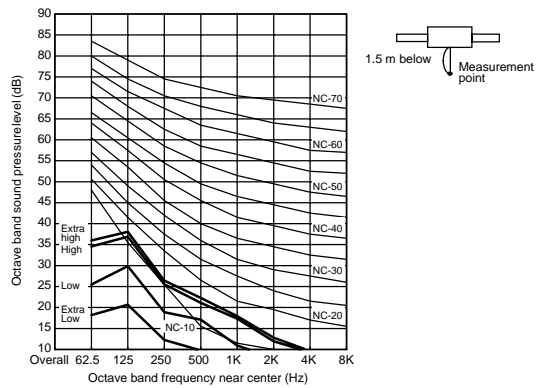

### LGH-35RX5-E

Background noise : 25 dB or less (A range)  
 Measurement site : Anechoic chamber  
 Operation conditions : Lossnay ventilation  
 Power supply : 220 V 50 Hz

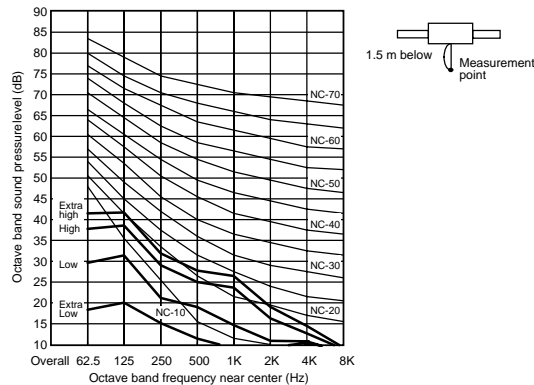

Background noise : 25 dB or less (A range)  
 Measurement site : Anechoic chamber  
 Operation conditions : Lossnay ventilation  
 Power supply : 240 V 50 Hz

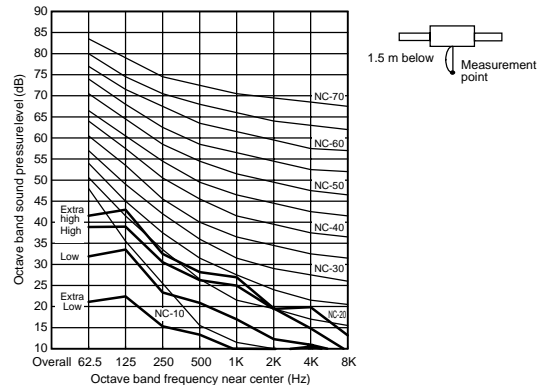

# CHAPTER 4 ● Characteristics

## LGH-50RX5-E

Background noise : 25 dB or less (A range)  
 Measurement site : Anechoic chamber  
 Operation conditions : Lossnay ventilation  
 Power supply : 220 V 50 Hz

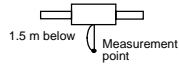
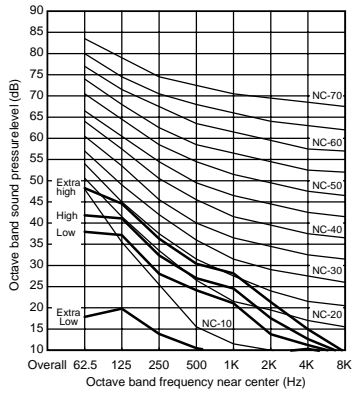

Background noise : 25 dB or less (A range)  
 Measurement site : Anechoic chamber  
 Operation conditions : Lossnay ventilation  
 Power supply : 240 V 50 Hz

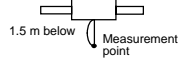
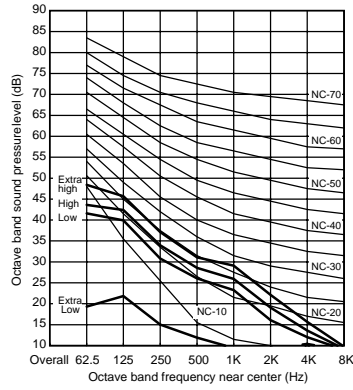

## LGH-65RX5-E

Background noise : 25 dB or less (A range)  
 Measurement site : Anechoic chamber  
 Operation conditions : Lossnay ventilation  
 Power supply : 220 V 50 Hz

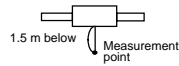
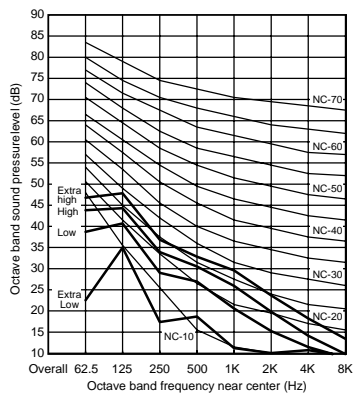

Background noise : 25 dB or less (A range)  
 Measurement site : Anechoic chamber  
 Operation conditions : Lossnay ventilation  
 Power supply : 240 V 50 Hz

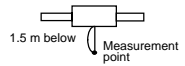
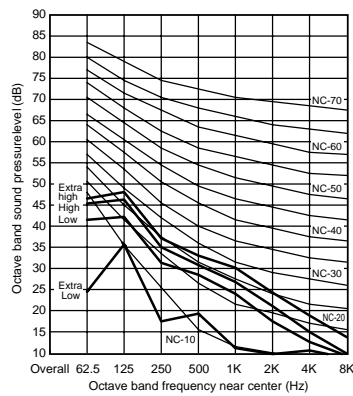

## LGH-80RX5-E

Background noise : 25 dB or less (A range)  
 Measurement site : Anechoic chamber  
 Operation conditions : Lossnay ventilation  
 Power supply : 220 V 50 Hz

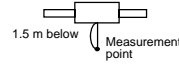
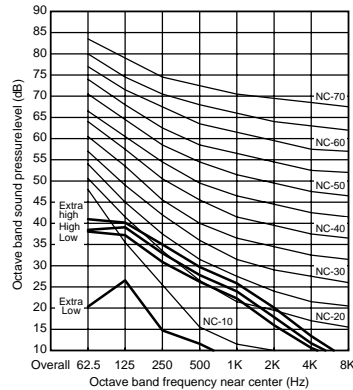

Background noise : 25 dB or less (A range)  
 Measurement site : Anechoic chamber  
 Operation conditions : Lossnay ventilation  
 Power supply : 240 V 50 Hz

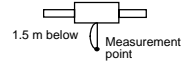
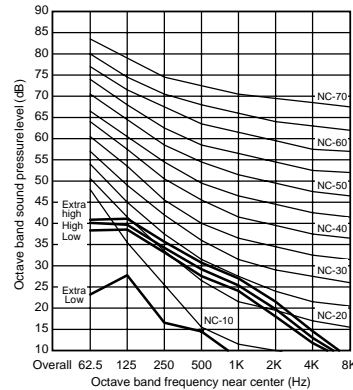



**LGH-100RX5-E**

Background noise : 25 dB or less (A range)  
 Measurement site : Anechoic chamber  
 Operation conditions : Lossnay ventilation  
 Power supply : 220 V 50 Hz

Background noise : 25 dB or less (A range)  
 Measurement site : Anechoic chamber  
 Operation conditions : Lossnay ventilation  
 Power supply : 240 V 50 Hz

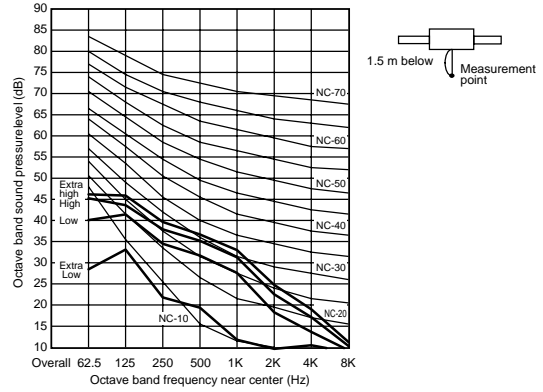
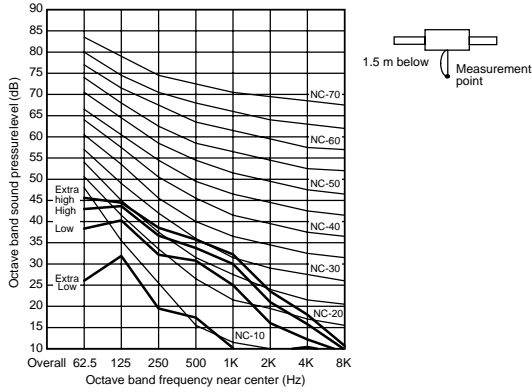

**LGH-150RX5-E**

Background noise : 25 dB or less (A range)  
 Measurement site : Anechoic chamber  
 Operation conditions : Lossnay ventilation  
 Power supply : 220 V 50 Hz

Background noise : 25 dB or less (A range)  
 Measurement site : Anechoic chamber  
 Operation conditions : Lossnay ventilation  
 Power supply : 240 V 50 Hz

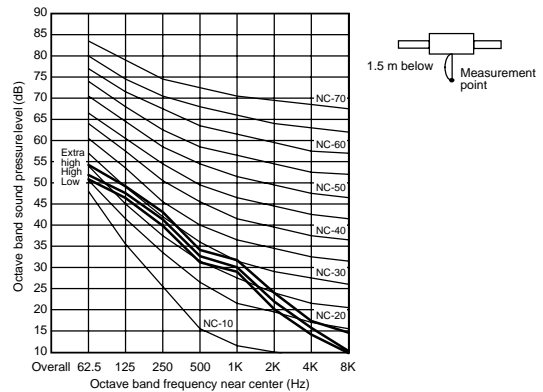
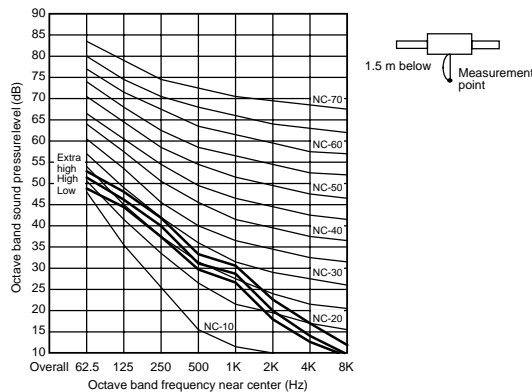

**LGH-200RX5-E**

Background noise : 25 dB or less (A range)  
 Measurement site : Anechoic chamber  
 Operation conditions : Lossnay ventilation  
 Power supply : 220 V 50 Hz

Background noise : 25 dB or less (A range)  
 Measurement site : Anechoic chamber  
 Operation conditions : Lossnay ventilation  
 Power supply : 240 V 50 Hz

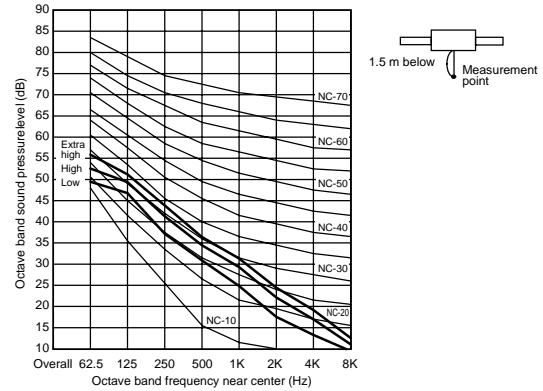
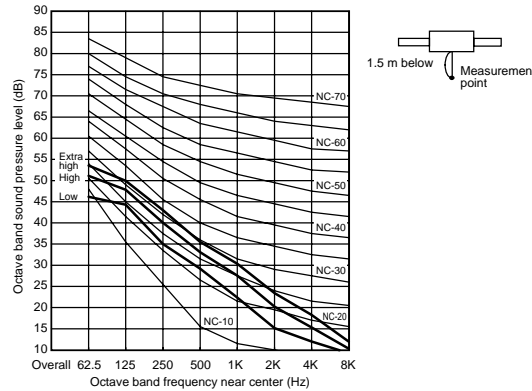



**CHAPTER 5**  
**System Design Recommendations**

# 1. Lossnay Operating Environment

	Main Unit Installation Conditions	OA ( Outdoor Air ) conditions	RA ( Return Air ) conditions
Commercial use Lossnay	-10°C to 40°C RH80% or less	-15°C to 40°C RH80% or less	-10°C to 40°C RH80% or less

Pay special attention to extreme operating conditions.

## 1.1 Cold Weather Area Intermittent Operation

When the OA temperature falls below -10°C during operation, the SA-fan will change to intermittent operation. OFF for 10 minutes, ON for 60 minutes.

## 1.2 In Cold Climates with Outdoor Temperature of -5°C or Less

Plot the Lossnay intake air conditions A and B on a psychrometric chart (see right). If the high temperature side air B intersects the saturation curve such as at C, moisture condensation or frost will build on Lossnay. In this case, the low temperature side air A should be warmed up to the temperature indicated by Point A' so that Point C shifts to the Point C'.

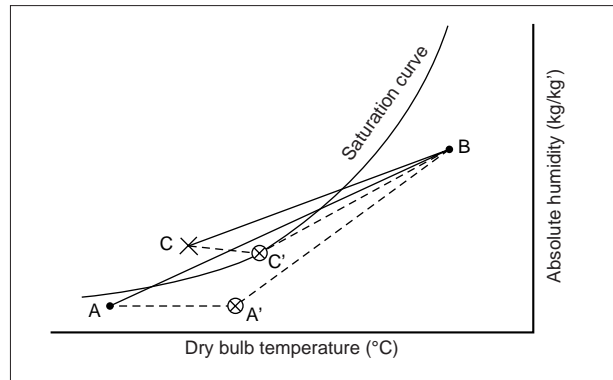

## 1.3 In High Humidity Conditions with Relative Humidity of 80% or More

When using the system in high humidity conditions such as heated indoor pools, bathrooms, mushroom cultivation houses, high-fog areas etc., moisture will condense inside the Core, and drainage will occur. General-purpose Lossnay units that use treated paper cannot be installed in those types of environments.

## 1.4 Other Special Conditions

- Lossnay units cannot be installed in locations where toxic gases and corrosive elements such as acids, alkalis, organic solvents, oil mist or paints exist.
- Cannot be installed where heat is recovered from odiferous air and supplied to another area.
- Avoid installing in a location where unit could be damaged by salt or hot water.

## **2. Sound Levels of Lossnay Units with Built-in Fans**

The sound levels specified for Lossnay units are generated from tests conducted in an anechoic chamber. The sound levels may increase by 8 to 11 dB according to the installation construction material and room contents.

When using Lossnay units in a quiet room, it is recommended silencer duct, silencer intake/exhaust grill or silencer box be installed.

## **3. Attaching Air Filters**

An air filter must be mounted to both the intake and exhaust air inlets to clean the air and to prevent the Core from clogging. Periodically clean the filter for optimum Lossnay unit performance.

## **4. Constructing the Ductwork**

- Always add insulation to the two ducts on the outdoor side (outdoor air intake and exhaust outlet) to prevent frost or condensation from forming.
- The outdoor duct gradient must be 1/30 or more (to wall side) to prevent rain water from going into the system.
- Do not use standard vent caps or round hoods where those may come into direct contact with rain water.  
(A deep hood is recommended.)

## **5. Bypass Ventilation**

Do not operate “bypass ventilation” when heating during winter. Frost or condensation may form on the main unit.

## **6. Night purge function**

Do not use the night purge function if fog or heavy rain is expected. Rain water may enter the unit during the night.

## 7. Transmission Rate of Various Gases and Maximum Workplace Concentration Levels

Measurement Conditions	Gas	Air Volume Ratio Q <sub>SA</sub> /Q <sub>RA</sub>	Exhaust Air Concentration C <sub>RA</sub> (ppm)	Supply Air Concentration C <sub>SA</sub> (ppm)	Transmission Rate (%)	Max. Workplace Concentrations (ppm)
Measurement method	Hydrogen fluoride	1.0	36	<0.5	- 0	0.6
• Chemical analysis with colorimetric method for H <sub>2</sub> SO <sub>4</sub> , HCHO	Hydrogen chloride	1.0	42	<0.5	- 0	5
	Nitric acid	1.0	20	<0.5	- 0	10
	Sulfuric acid	1.0	2.6 mg/m <sup>3</sup>	- 0 mg/m <sup>3</sup>	- 0	0.25
	Trichlene	1.0	85	2.5	2.9	200
• Ultrasonic method with gas concentration device for CO, SF <sub>6</sub>	Acetone	1.0	5	0.13	2.5	1,000
	Xylene	1.0	110	2.5	2.3	150
• Infrared method with gas concentration device for CO <sub>2</sub>	Isopropyl alcohol	1.0	2,000	50	2.5	400
	Methanol	1.0	41	1.0	2.4	200
	Ethanol	1.0	35	1.0	2.9	1,000
• Gas chromatography for others	Ethyl acetate alcohol	1.0	25	0.55	2.2	400
	Ammonia	1.0	70	2	2.9	50
The fans are positioned at the air supply/exhaust suction positions of the element	Hydrogen sulfide	1.0	15	0.44	2.9	10
	Carbon monoxide	1.0	71.2	0.7	1.0	
	Carbon dioxide	1.0	44,500	1,400	1.8	
	Smoke	1.0	–	–	1 - 2	
Measurement conditions: 27°C, 65% RH	Formaldehyde	1.0	0.5	0.01	2	0.08
	Sulfur hexafluoride	1.0	27.1	0.56	2.1	
* OA density for CO <sub>2</sub> is 600 ppm.	Skatole	1.0	27.1	0.56	2.0	
	Indole	1.0	27.1	0.56	2.0	
	Toluene	1.0	6.1	0.14	2.3	

## 8. Solubility of Odors and Toxic Gases, etc., in Water and the Effect on the Lossnay Core

Main Generation Site	Gas	Molecular Formula	Gas Type	Hazardous level	Solubility in Water		Max. Workplace Concentration	Useability of Lossnay
					mℓ/mℓ	g/100g		
Chemical plant or chemical laboratory	Sulfuric acid	H <sub>2</sub> SO <sub>4</sub>	Mist	Toxic		2,380	0.25	×
	Nitric acid	HNO <sub>3</sub>	Mist	Toxic		180	10	×
	Phosphoric acid	H <sub>3</sub> PO <sub>4</sub>	Mist	Toxic		41	0.1	×
	Acetic acid	CH <sub>3</sub> COOH	Mist	Bad odor		2,115	25	×
	Hydrogen chloride	HCl	Gas	Toxic	427	58	5	×
	Hydrogen fluoride	HF	Gas	Toxic		90	0.6	×
	Sulfur dioxide	SO <sub>2</sub>	Gas	Toxic	32.8		0.25	△
	Hydrogen sulfide	H <sub>2</sub> S	Gas	Toxic	2.3		10	△
	Ammonia	NH <sub>3</sub>	Gas	Bad odor	635	40	50	×
	Phosphine	PH <sub>3</sub>	Gas	Toxic	0.26		0.1	○
	Methanol	CH <sub>3</sub> OH	Vapor	Toxic	Soluble		200	△
	Ethanol	CH <sub>3</sub> CH <sub>2</sub> OH	Vapor	Toxic	Soluble		1,000	△
Ketone		Vapor	Toxic	Soluble		1,000	△	
Toilet	Skatole	C <sub>9</sub> H <sub>9</sub> N	Gas	Bad odor	Minute			○
	Indole	C <sub>9</sub> H <sub>7</sub> N	Gas	Bad odor	Minute			○
	Ammonia	NH <sub>3</sub>	Gas	Bad odor	635	40	50	×
Others	Nitric monoxide	NO			0.0043		50	○
	Ozone	O <sub>3</sub>				0.00139	0.1	○
	Methane	CH <sub>4</sub>			0.0301			○
	Chlorine	Cl <sub>2</sub>			Minute		0.5	○
Air (reference)	Air	Mixed gases	Gas	Non-toxic	0.0167			○
	Oxygen	O <sub>2</sub>	Gas	Non-toxic	0.0283			○
	Nitrogen	N <sub>2</sub>	Gas	Non-toxic	0.0143			○
	Carbon monoxide	CO	Gas	Toxic	0.0214			○
	Carbon dioxide	CO <sub>2</sub>	Gas	Non-toxic	0.759			○

○ : Recommended      △ : Not recommend      × : Avoid

- Note:**
1. Lossnay should not be used in environments with water soluble gases and mists because the amount that is transmitted with the water is too high.
  2. Lossnay should not be used in environments with acidic gases and mists because these will accumulate in the Core and cause damage.
  3. The table data above apply to only Lossnay treated paper of total energy recovery units.

# 9. Automatic Ventilation Switching

## (Refer to technical manual (Control) page C-40)

### Effect of Automatic Ventilation Mode

The automatic damper mode automatically provides the correct ventilation for the conditions in the room. It eliminates the need for manual switch operations when setting the Lossnay ventilator to “bypass” ventilation. The following shows the effect “bypass” ventilation will have under various conditions.

#### (1) Reduces Cooling Load

If the air outside is cooler than the air inside the building during the cooling season (such as early morning or at night), “bypass” ventilation will draw in the cooler outside air and reduce the cooling load on the system.

#### (2) Cooling Using Outdoor Air

During cooler seasons (such as between spring and summer or between summer and fall), if the occupants in a room cause the temperature of the room to rise, “bypass” ventilation will draw in the cool outside air and use it as is to cool the room.

#### (3) Night Purge

“Bypass” ventilation can be used to release hot air from inside the building that has accumulated during the hot summer season.

LGH-RX5-E series has night purge function, that is used in the summer to automatically ventilate a room at night while the air conditioner is stopped, to discharge accumulated heat and thereby reduce the air conditioning load the next morning. (Selectable function)

#### (4) Cooling the Office Equipment Room

During cold season, outdoor air can be drawn in and used as is to cool rooms where the temperature has risen due to office equipment use. (Only when interlocked with City Multi and Mr. Slim indoor units.)



## 10. Alternate Installation for Lossnay

### 10.1 Top/bottom Reverse Installation

All LGH-RX<sub>5</sub> models can be installed in top/bottom reverse.

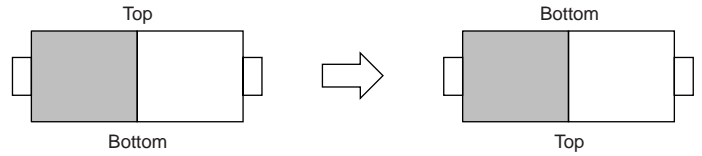

### 10.2 Vertical and Slanted Installation

All LGH-RX<sub>5</sub> models should not be used in both vertical and slanted installation to avoid any problems (motor noise, water incoming etc).

## 11. Installing Supplementary Fan Devices

On occasions it may be necessary to install additional fans in the ductwork following LGH-type Lossnay units because of the addition of extra components such as control dampers, high-efficiency filters, sound attenuators, etc. which create a significant extra static pressure to the airflow. An example of such an installation is as shown below.

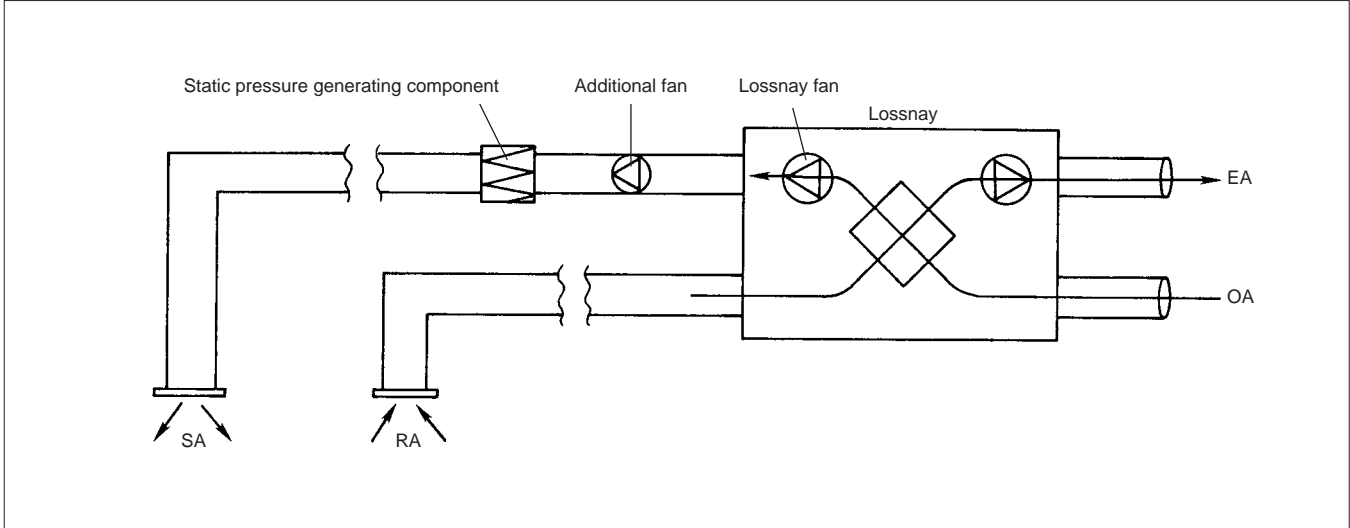

For such an installation, avoid undue stress on the fan motors. Referring to the diagrams below, Lossnay with extra fans should be used at the point of left side from A.

**Q-H for Lossnay Without Extra Fan**

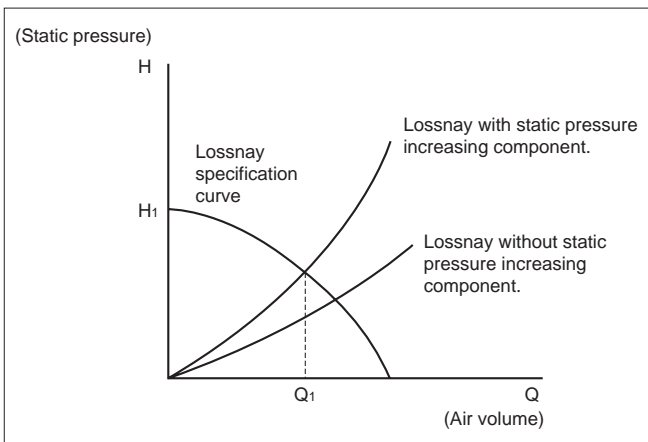

**Q-H for Lossnay With Extra Fan**

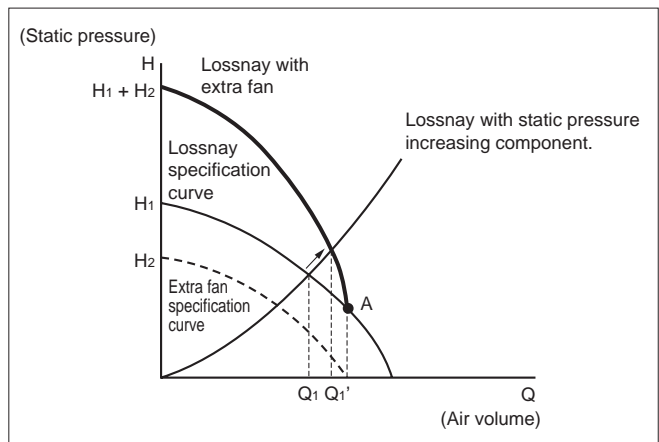

**CHAPTER 6**  
**Examples of Lossnay Applications**

## CHAPTER 6 ● Examples of Lossnay Applications

This chapter proposes Lossnay ventilation systems for eight types of applications. These systems were planned for use in Japan, and actual systems will differ according to each country - the ventilation systems listed here should be used only as reference.

# 1. Large Office Building

## 1.1 System Design Challenges

Conventional central systems in large buildings, run in floor and ducts, had generally been preferred to individual room units; thus, air conditioning and ventilation after working hours only in certain rooms was not possible.

In this plan, an independent dispersed ventilation method applied to resolve this problem. The main advantage to such a system was that it allows 24-hour operation.

A package-type indoor unit of air conditioner was installed in the ceiling, and ventilation was performed with a ceiling-embedded-type Lossnay. Ventilation for the toilet, kitchenette and elevator halls, etc., was performed with a straight centrifugal fan.

### System Design

- Building specifications: Basement floor SRC (Slab Reinforced Concrete), seven floors above ground floor  
Total floor space 30,350 m<sup>2</sup>
- Basement : Employee cafeteria
- Ground floor : Lobby, conference room
- 2nd to 7th floor : Offices, salons, board room
- Air conditioning system: Package air conditioning
- Ventilation : Ceiling embedded-type Lossnay, straight centrifugal fan

## 1.2 System Requirements

- (1) Operation system that answers individual needs was required.
  - Free independent operation system
  - Simple control
- (2) Effective use of floor space  
(Eliminating the equipment room)
- (3) Application to Building Management Laws
  - Effective humidification
  - Eliminating indoor dust
- (4) Energy conservation

## 1.3 Details

### (1) Air Conditioning

- In general offices, the duct method would applied with several ceiling-embedded multiple cooling heat pump packages in each zone to allow total zone operation.
- Board rooms, conference rooms, and salons would air conditioned with a ceiling embedded-type or cassette-type multiple cooling heat pump package.

#### Installation of an office system air conditioning system

– The air supplied from the Lossnay unit was introduced into the intake side of the indoor unit of air conditioner, and the stale air from the room was directly removed from the inside of the ceiling.

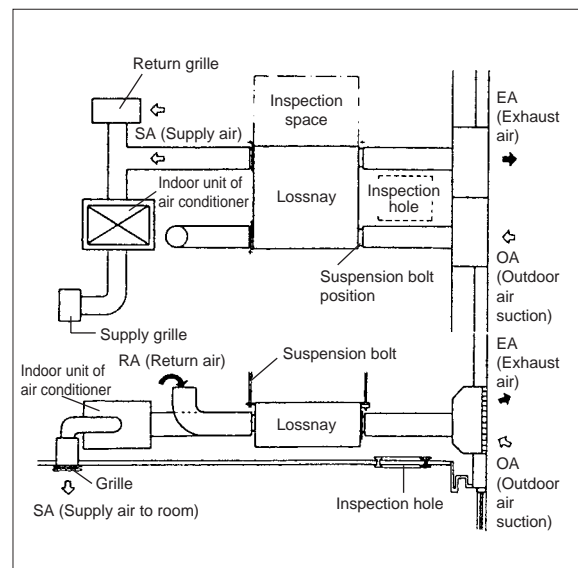

(2) Ventilation

- For general offices, a ceiling embedded-type Lossnay unit would be installed. The inside of the ceiling would be used as a return chamber for exhaust, and the air from the Lossnay unit would be supplied to the air-conditioning return duct and mixed with the air in the air conditioning passage. (Exhaust air was taken in from the entire area, and supply air was introduced into the indoor units of air conditioner to increase the effectiveness of the ventilation for large rooms.)
- For board rooms, conference rooms, and salons, a ceiling embedded-type Lossnay unit would be installed. The stale air would be exhausted from the discharge grille installed in the center of the ceiling. The supply air would be discharged into the ceiling, where, after mixing with the return air from the air conditioner, it was supplied to the air conditioner.
- The air in the toilet, kitchenette, and elevator hall, etc., would be exhausted with a straight centrifugal fan. The OA supply would use the air supplied from the Lossnay unit. (The OA volume would be obtained by setting the Lossnay supply fan in the general office to the extra-high mode.)

Installation of air conditioning system for board rooms, conference rooms, salons - the air supplied from the Lossnay unit was blown into the ceiling, and the stale air was removed from the discharge grille.

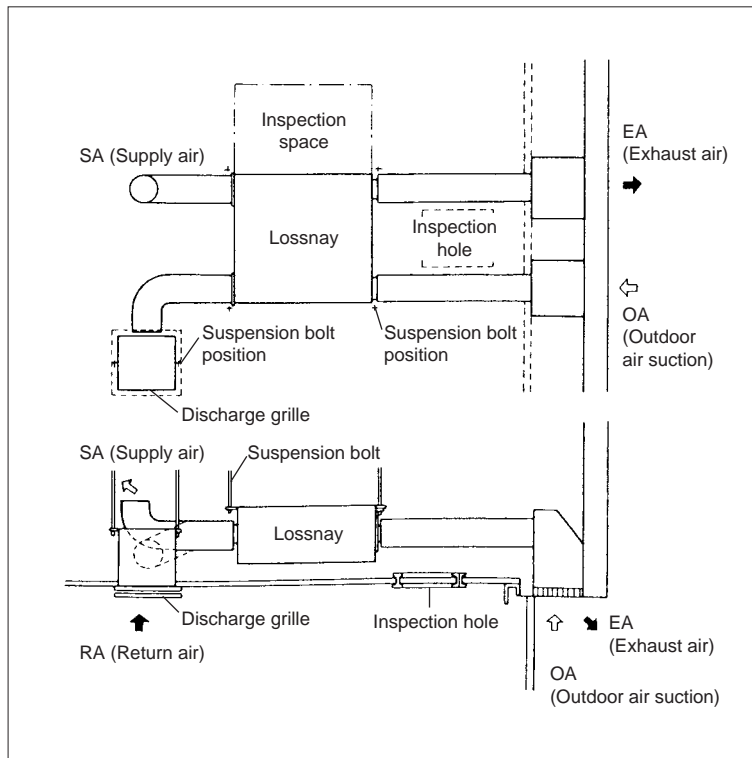

## CHAPTER 6 ● Examples of Lossnay Applications

- A gallery for the exhaust air outlets would be constructed on the outside wall to allow for blending in with the exterior.

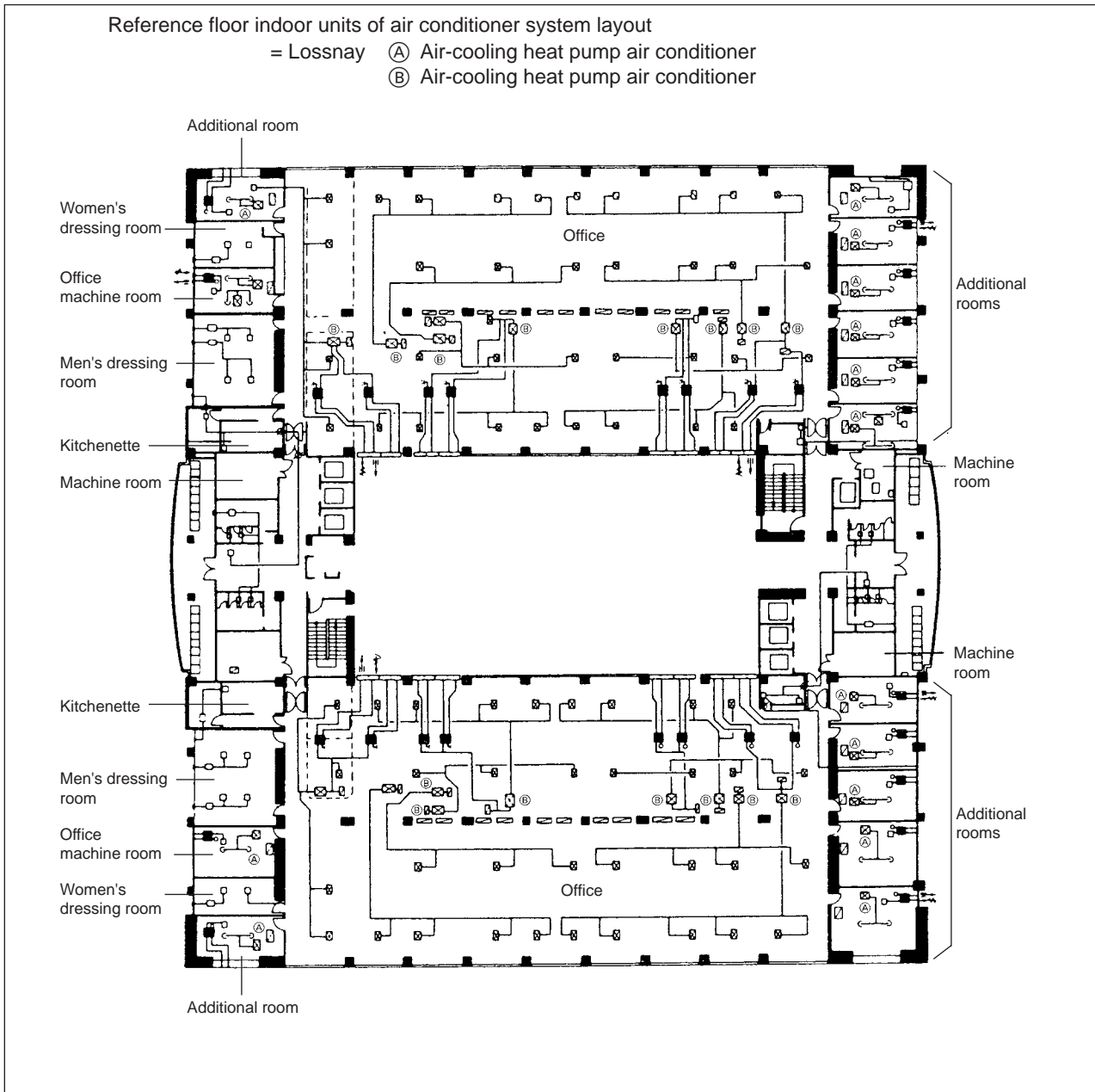

**(3) Humidification**

If the load fluctuation of the required humidification amount was proportional to the ventilation volume, it was ideal to add a humidifier with the ventilation system. For this application, the humidifier was installed on with the air supply side of the Lossnay unit.

**(4) Conforming to Building Laws**

Many laws pertaining the building environments were concerned with humidification and dust removal; in these terms, it was recommended that a humidifier was added to the air conditioning system to allow adequate humidification.

Installing of a filter on each air-circulation system in the room was effective for dust removal, but if the outdoor air inlet was near a source of dust, such as a road, a filter should also be installed on the ventilation system.

**1.4 Outcome**

- (1) Air conditioning and ventilation needs were met on an individual room or were basis.
- (2) Operation was possible with a 24-hour system.
- (3) Operation was simple because the switches were accessible in the room. (A controller was not required.)
- (4) Floor space was saved.
- (5) Energy was conserved with the independent energy recovery function.
- (6) Air-conditioning with ventilation was possible with the independent system.

## 2. Small-Scale Urban Building

### 2.1 System Design Challenges

The system was designed effectively using limited available air conditioner and ventilator installation space. For this application, air flow must be considered for the entire floor and the ventilator was installed in the ceiling plenum.

#### System Design

- Application : Office
- Building specification: RC (Reinforced Concrete)
- Total floor space : 552 m<sup>2</sup> (B1 to 5F)
- Application per floor : B1: Parking area  
GF to 5F: Office
- Air conditioning system : Package air conditioner
- Ventilation : Ceiling-embedded-type and cassette-type Lossnay, straight centrifugal fan, duct ventilation fan.

### 2.2 System Requirements

- (1) Three sides of the building were surrounded by other buildings, and windows could not be installed; therefore mechanical ventilation needed to be reliable.
- (2) Ample fresh outdoor air could not be supplied. (Generally, only “Class 3” ventilation (forced exhaust) was possible.)
- (3) If the exhaust in the room was large, odors from other areas could have affected air quality.
- (4) Humidification during winter was not possible.

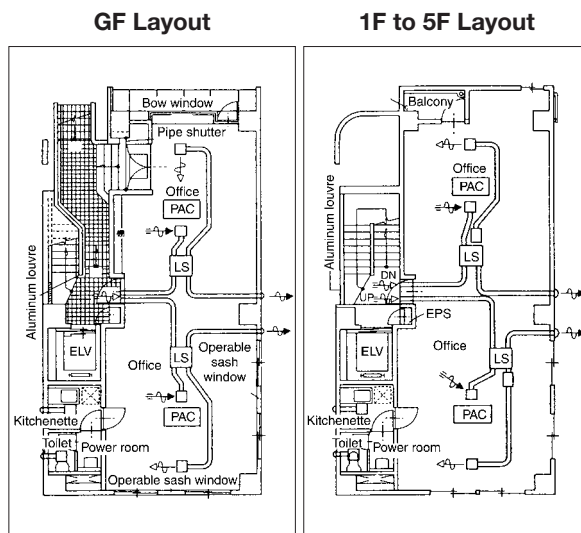

PAC : Package air conditioner  
LS : Lossnay

### 2.3 Details

- (1) Air conditioning
  - Space efficiency and comfort during cooling/heating was improved with ceiling-embedded cassette-type package air conditioner.
- (2) Ventilation
  - Room } Entire area was ventilated by installing several ceiling-embedded-type Lossnay units.
  - Salon } Humidification was possible by adding a humidifier.  
(Outdoor air was supplied to the toilet and kitchenette by setting the selection switch on the Lossnay unit for supply to the extra-high.)
  - Conference room } Area was independently ventilated by installing a ceiling-embedded-type or cassette-type
  - Board room } Lossnay in each room.
  - Toilet, powder room } Area was exhausted with a straight centrifugal fan or duct ventilation fan.
  - Kitchenette } (An adequate exhaust volume was obtained by introducing outdoor air into the space with the toilet being ventilated constantly.)
  - Location of air intake/exhaust air outlets on outside wall  
The freshness of the outdoor air taken in by the Lossnay was important, and because the building was surrounded by other buildings, the intake and exhaust ports must be placed as far apart as possible.



## 2.4 Outcome

- (1) Appropriate ventilation was possible with “Class 1” ventilation (forced simultaneous air intake/exhaust) using Lossnay units.
- (2) Outdoor air to the toilet and kitchenette was possible with Lossnay units, and appropriate ventilation was possible even in highly sealed buildings.
- (3) Odors infiltrating into other rooms was prevented with constant ventilation using an adequate ventilation air volume.
- (4) Humidification was possible by adding a simple humidifying unit to the Lossnay unit.

## 3. Hospitals

### 3.1 System Design Challenges

Ventilating a hospitals required adequate exhaust air from the generation site and ensuring a supply of ample fresh outdoor air. An appropriate system was an independent ventilation system with “Class 1” ventilation (forced simultaneous air intake/exhaust).

The fan coil and package air conditioning were according to material and place, and the air conditioned room was ventilated with ceiling-embedded-type Lossnay units. The toilet and kitchenette, etc., were ventilated with a straight centrifugal fan.

#### System Design

- Building specification : RC (Reinforced Concrete)
- Total floor space : 931 m<sup>2</sup> (GF to 2F)
- Application per floor : GF : Waiting room, diagnosis rooms, surgery theater, director room, kitchen  
                                   1F : Patient rooms, nurse station, rehabilitation room, cafeteria  
                                   2F : Patient rooms, nurse station, head nurse room, office
- Air conditioning system : Fan coil unit, package air conditioner
- Ventilation : Ceiling-embedded-type Lossnay, straight centrifugal fan

### 3.2 System Requirements

- (1) Prevented in-hospital disease transmission.  
(Meeting needs for operating rooms, diagnosis rooms, waiting rooms and patient rooms were required.)
- (2) Adequate ventilation for places where odors were generated  
(Preventing odors generated from toilets from infiltrating into other rooms was required.)
- (3) Blocking external sound  
(Blocking sound from outside of the building and from adjacent rooms and hallway was required.)
- (4) Assuring adequate humidity

### 3.3 Details

#### (1) Air Conditioning

- Centralized heat-source control using a fan coil for the general system allowed efficient operation timer control and energy conservation.
- A 24-hour system using a package air conditioner for special rooms (surgery theater, nurse station, special patient rooms, waiting room) was the most practical.

#### (2) Ventilation

##### ● Hallway

Independent system using centralized control with LP Lossnay units, or independent system with ceiling suspended-type Lossnay units.

##### ● Surgery theater

Combination of LP Lossnay and package air-conditioner with HEPA filter on room supply air outlet.

##### ● Diagnosis rooms and examination room

Patient rooms

Nurse stations

Independent ventilation for each room using ceiling suspended/embedded-type Lossnay.

- Integral system with optional humidifier for required rooms.
- Positive/negative pressure adjustment, etc., was possible by setting main unit selection switch to extra-high mode (25R, 50R models) according to the room.

##### ● Toilet/kitchenette

Straight centrifugal fan or duct ventilation fan

##### ● Storage/linen closet

Positive pressure ventilation fan or duct ventilation fan.

The outdoor air was supplied from the hallway ceiling with the straight centrifugal fan, and was distributed near the indoor unit of air conditioner after the air flow was reduced.

##### ● Kitchen

Exhaust with negative pressure ventilation fan or straight centrifugal fan. Outdoor air was supplied with the straight centrifugal fan.

##### ● Machine room

Exhaust with positive pressure ventilation fan.

GF Layout

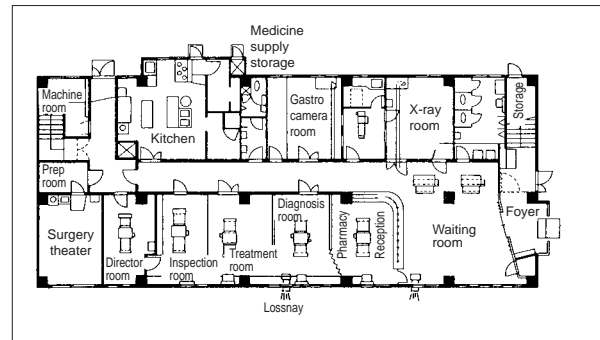

1F Layout

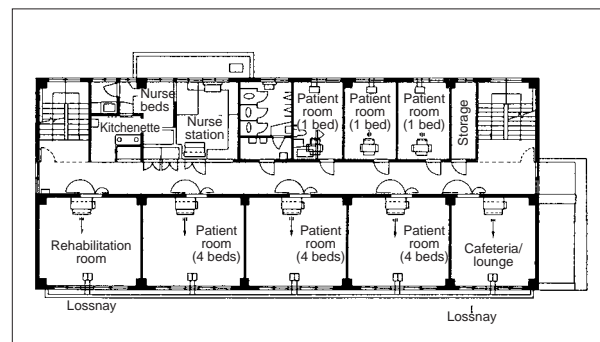

2F Layout

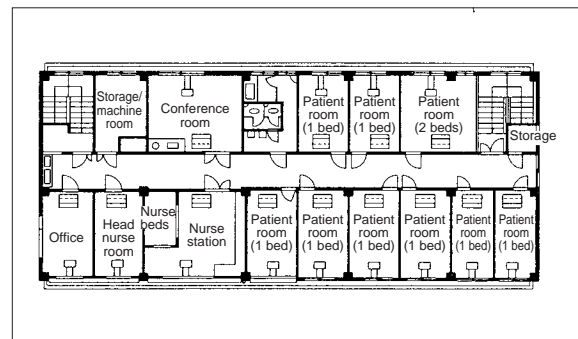

### 3.4 Outcome

- (1) The following outcomes were possible by independently ventilating the air-conditioned rooms with Lossnay units:
  - Disease transmission could be prevented by shielding the air between rooms.
  - Lossnay Core's sound reducing properties reduced outside sound.
  - Because outdoor air did not need to be taken in from the hallway, doors could be sealed, shutting out sounds from the hallway.
  - Humidification was possible by adding a humidifier.
- (2) By exhausting the toilet, etc., and supplying outdoor air to the hallway:
  - Odors infiltrating into other rooms were prevented.



## 5. Convention Halls, Wedding Halls in Hotels

### 5.1 System Design Challenges

Hotels often included conference, wedding, and banquet halls.

Air conditioning systems in these spaces had to have a ventilation treatment system that could handle extremely large fluctuations in loads, any generated tobacco smoke, and odor removal.

### 5.2 Systems Requirements

The presence of CO and CO<sub>2</sub> at permissible values, odor removal, and generated tobacco smoke were often considered in ventilation standards; often the limit was set at 30 m<sup>3</sup>/h-person to 35 m<sup>3</sup>/h-person. Several package air conditioners with ventilation or air-handling unit facilities were often used, but these were greatly affected by differences in capacity, ratio of smokers, and length of occupancy in the area.

### 5.3 Details

The proposed plan had two examples using a Lossnay unit as a ventilator for total energy recovery in the air-conditioned conference room, and using several package air conditioners with ventilation for convention and banquet halls.

#### A) Conference room

Energy recovery ventilation was executed with continuous operation of the Lossnay unit, but when the number of persons increased and the CO<sub>2</sub> concentration reached a set level (for example, 1,000 ppm in the Building Management Law), a separate centrifugal fan turned on automatically. The system could also be operated manually to rapidly remove smoke and odors.

#### B) Convention and banquet halls

The system included several outdoor air introduction-type package air conditioners and straight centrifugal fans for ventilation. However, an inverter controller was connected to the centrifugal fan so that it constantly operated at 50 percent, to handle fluctuations in ventilation loads. By interlocking with several package air-conditioners, detailed handling of following up the air condition loads in addition to the ventilation volume was possible.

Systems using Lossnay were also possible.

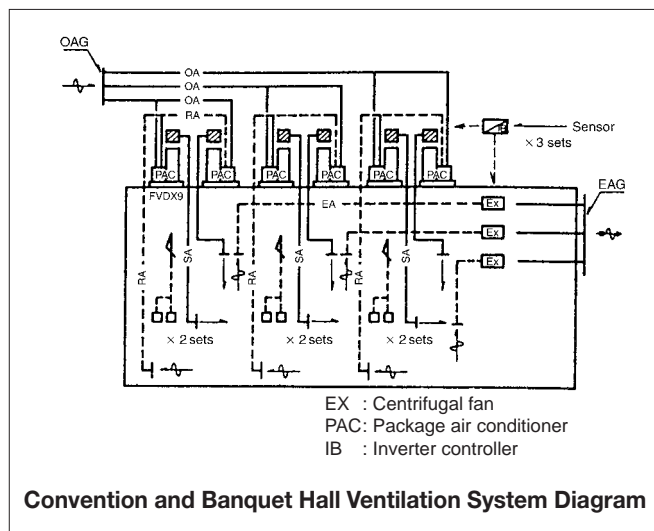
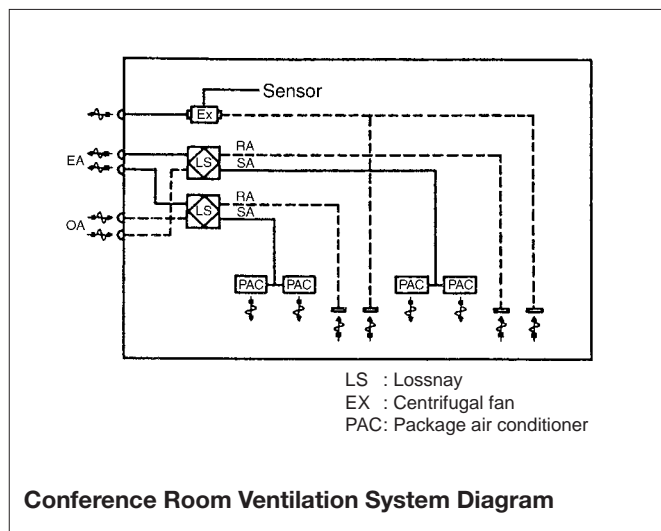

### 5.4 System Trends

The load characteristics at hotels was complex compared to general buildings, and were greatly affected by the occupancy, and operation. Because of the high ceilings in meeting rooms and banquet halls preheating and precooling also needs to be considered. Further research on management and control systems and product development would be required to achieve even more comfortable control within these spaces.

## 6. Public Halls (Facilities Such as Day-care Centers)

### 6.1 System Design Challenges

For buildings located near airports and military bases, etc., that required soundproofing, air conditioning and ventilation facilities had conventionally been of the centralized type. However, independent dispersed air conditioning and ventilation systems had been necessary due to the need for zone control, as well as for energy conservation purposes. The system detailed below was a plan for these types of buildings.

#### System Design

- Building specifications: Two floors above ground floor, Total floor space: 385 m<sup>2</sup>
- Application : GF Study rooms (two rooms), office, day-care room, lounge  
1F . . . . . Meeting room
- Air conditioning : GF Air-cooling heat pump chiller and fan coil unit  
1F . . . . . Air-cooling heat pump package air conditioner
- Ventilation : Ceiling-embedded Lossnay unit

### 6.2 System Requirements

- (1) Conventional systems used centralized units with air-handling units, and air conditioning and ventilation were performed together.
- (2) Topics
  - 1) Special knowledge was required for operation, and there were problems in response to the users' needs.
  - 2) When the centralized method was used, the air even in rooms that were not being used was conditioned, increasing operation costs.
  - 3) Machine room space was necessary.
  - 4) Duct space was necessary.

### 6.3 Details

#### (1) Air-conditioning Facilities

- 1) Small rooms : Air-cooling heat pump chiller and fan coil unit combination
- 2) Meeting rooms : Single duct method with air-cooling heat pump package air conditioner

#### (2) Ventilation Facilities

- 1) A ceiling-embedded-type Lossnay unit was used in each room, and a silence chamber, silence-type supply/return grille, silence duct, etc. was incorporated on the outer wall to increase the total soundproofing effect.

### 6.4 Outcome

- (1) Operation was possible without special training, so system management was easy.
- (2) Zone operation was possible, and was thus energy-saving.
- (3) Soundproof ventilation was possible with the separately installed ventilators.
- (4) Energy saving ventilation was possible with the energy recovery ventilation.
- (5) Ceiling-embedded-type Lossnay unit saved space.

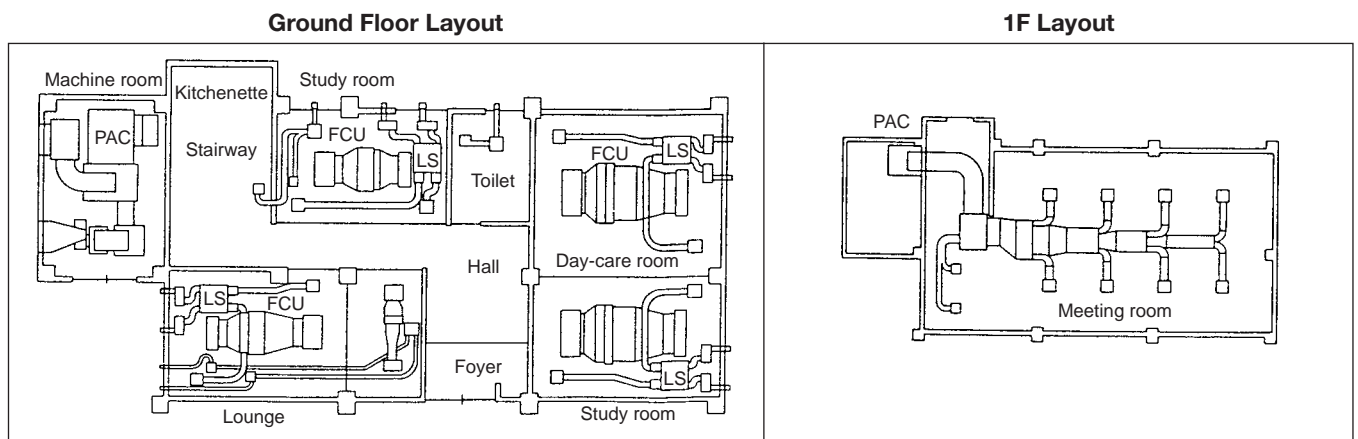



**CHAPTER 7**  
**Installation Considerations**

# 1. LGH-Series Lossnay Ceiling Embedded-Type (LGH-RX5 Series)

LGH-15 · 25 · 35 · 50 · 65 · 80 · 100RX5 models

■ Installation diagram

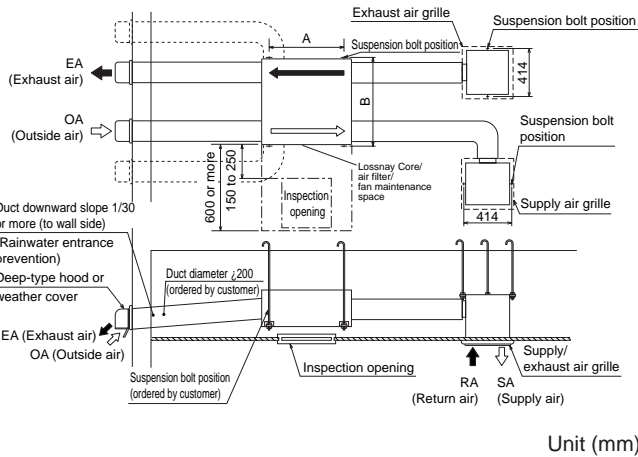

Unit (mm)

- Always leave inspection holes (□ 450 or □ 600) on the air filter and Lossnay Core removal side.
- Always insulate the two ducts outside the room (intake air and exhaust air ducts) to prevent condensation.
- It is possible to change the direction of the outside air ducts (OA and EA side).
- Do not install the vent cap or round hood where it will come into direct contact with rain water.

Air volume (m <sup>3</sup> /h)	Model	Dimension	
		A	B
150	LGH-15RX5	768	782
250	LGH-25RX5	768	782
350	LGH-35RX5	875	921
500	LGH-50RX5	875	1,063
650	LGH-65RX5	895	1,001
800	LGH-80RX5	1,010	1,036
1000	LGH-100RX5	1,010	1,263

LGH-150 · 200RX5

■ Installation diagram

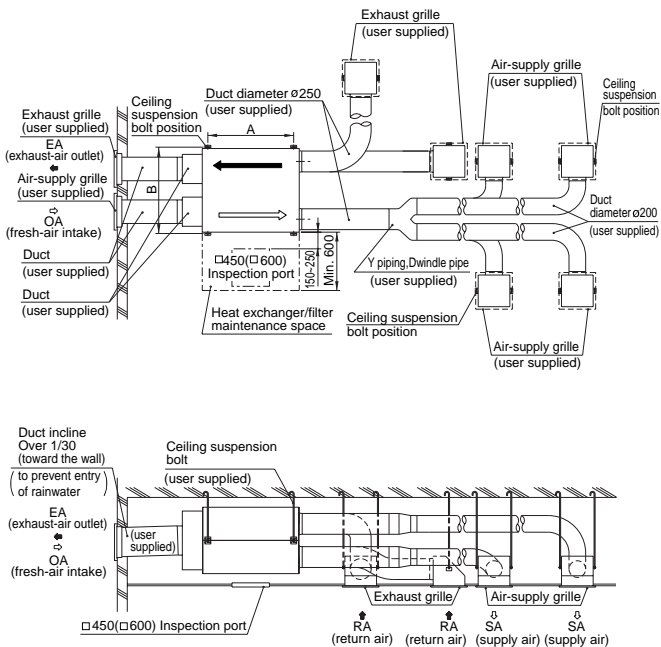

Unit (mm)

- Always leave inspection holes (□ 450 or □ 600) on the air filter and Lossnay Core removal side.
- Always insulate the two ducts outside the room (intake air and exhaust air ducts) to prevent condensation.
- If necessary, order a weather cover to prevent rain water from direct contact or entering the unit.

Air volume (m <sup>3</sup> /h)	Model	Dimension	
		A	B
1500	LGH-150RX5	1,010	1,045
2000	LGH-200RX5	1,010	1,272

● Ducting

Indoor

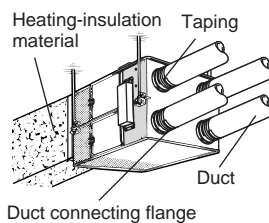

Should secure with airtight tape to prevent air leakage.

Outdoor

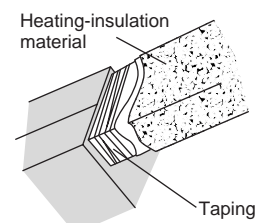

Should secure with airtight tape to prevent air leakage. Cover duct with insulation foam prevent condensation.

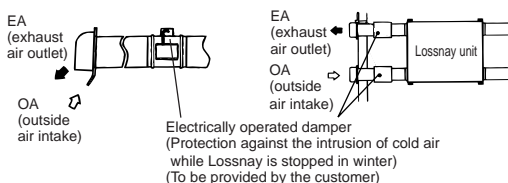

- In a region where there is risk of freezing in winter, it is recommended to install an Electrically operated damper, or the like, in order to prevent the intrusion of (cold) outdoor air while Lossnay is stopped.



### 1.1 Choosing the Duct Attachment

Choose between two directions for the outside duct (OA, EA) piping direction for alternative installation.

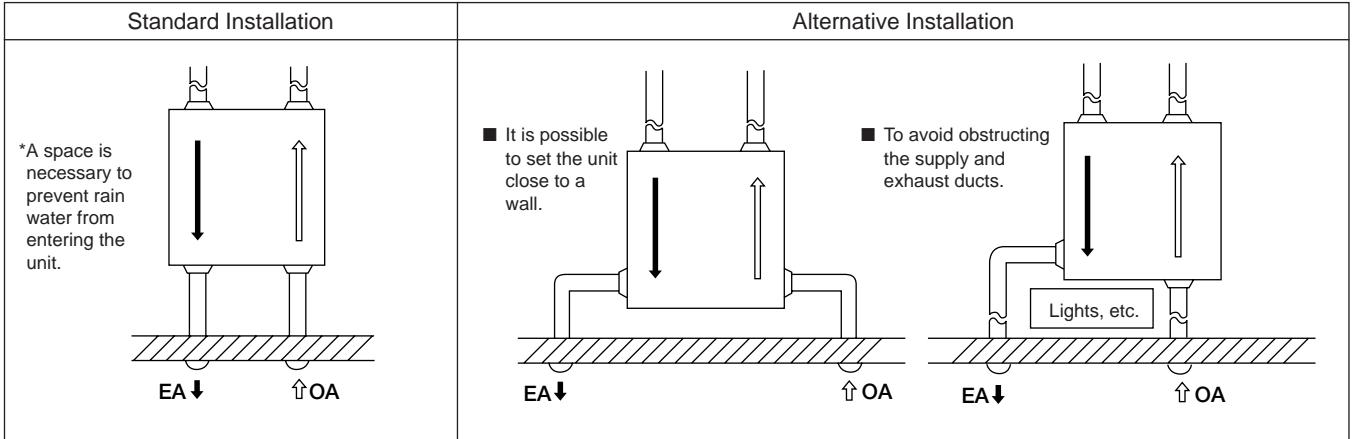

### 1.2 Installation and Maintenance

- (1) Always leave an inspection hole (a square, 450 mm each side) to access the filter and Lossnay Core.
- (2) Always insulate the two ducts outside the room (intake air and exhaust air ducts) to prevent frost from forming.
- (3) Prevent rainwater from entering.
  - Apply a slope of 1/30 or more towards the wall to the intake air and exhaust air ducts outside the room.
  - Do not install the vent cap or round hood where it will come into direct contact with rainwater.
- (4) Use the optional “control switch” (Ex. PZ-60DR-E, etc.) for the RX5-type. A MELANS centralized controller can also be used.

### 1.3 Installation Applications

**(1) Installing Two Units to One Outside Air Duct**

The main unit’s supply outlet and suction inlet and the room side and outdoor side positions cannot be changed. However, the unit can be installed upside-down, and installed as shown below. (This is applicable when installing two units in one classroom, etc.)

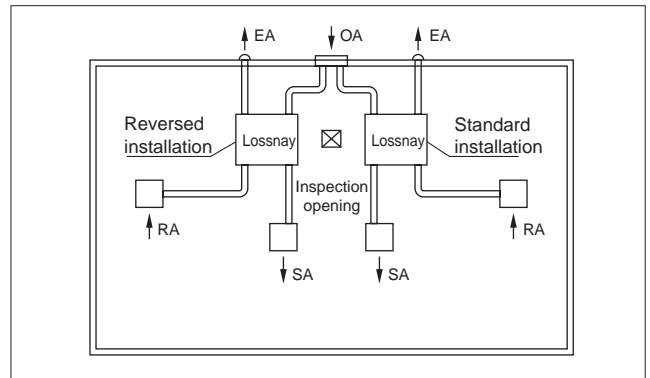

**(2) System Operation with Indoor Unit of Air Conditioner**

There is an increased use of air conditioning systems with independent multiple air-conditioner unit due to their features such as improved controllability, energy conservation and saving space. For these types of air conditioning systems, combining the operation of the dispersed air conditioners to Lossnay is possible.

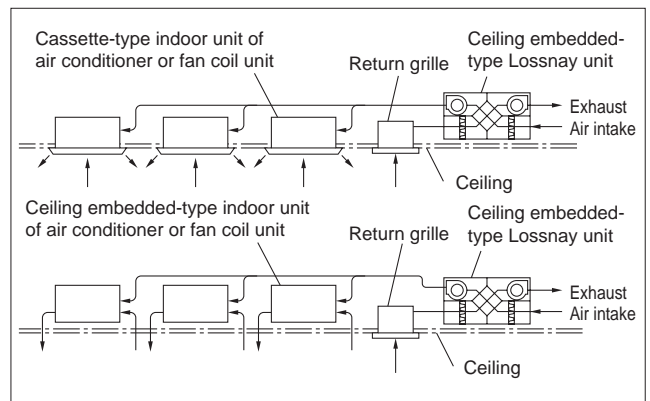



# **CHAPTER 8**

## **Filters**

# 1. Importance of Filters

Clean air is necessary for comfort and health. Besides atmospheric pollution that has been generated with the development of modern industries, the increased use of automobiles, air pollution in air-tight room has progressed to the point where it has an adverse effect on occupants. Also, demands for preventing pollen from entering inside spaces are increasing.

# 2. Dust

The particle diameter of dust and applicable range of filters are shown in Table 1, and representative data regarding outdoor air dust concentrations and indoor dust concentrations is shown in Table 2.

**Table 1. Aerosol particle diameters and applicable ranges of various filters**

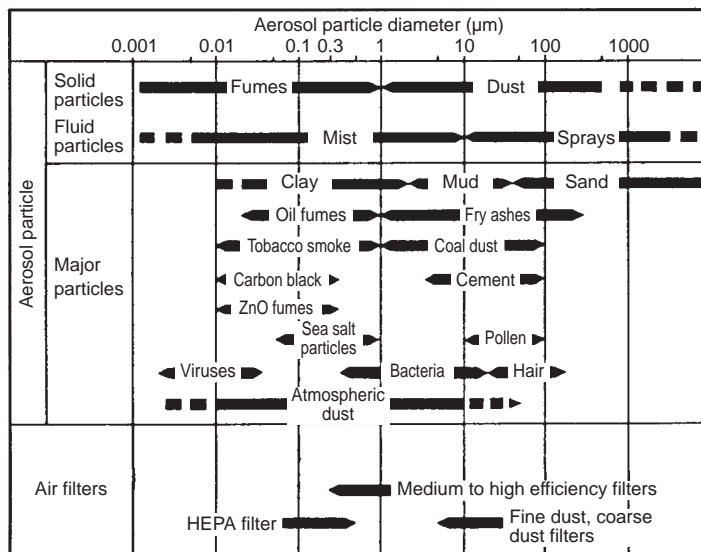

**Table 2. Dust Concentrations**

Type	Reference Data	
Outdoor air dust concentration	Large city	0.1 - 0.15 mg/m <sup>3</sup>
	Small city	0.1 mg/m <sup>3</sup> or less
	Industrial districts	0.2 mg/m <sup>3</sup> or more
Indoor dust concentration	General office	10 mg/h per person
	Stores	5 mg/h per person
	Applications with no tobacco smoke	5 mg/h per person

**Remarks:**

- Outdoor dust is said to have a diameter of 2.1 µm; the 11 types of dust (average diameter 2.0 µm) as listed by JIS Z8901 for performance test particles are employed.
- Dust in office rooms is largely generated by cigarette smoke, and its diameter is 0.72 µm. The 14 types of dust (average 0.8 µm) as listed by JIS Z 8901 for performance test particles are employed.
- Dust generated in rooms where there is no smoking has approximately the same diameter as outdoor air.
- Smoking in general offices (Japan):
  - Percentage of smokers : Approx. 70% (adult men)
  - Average number of cigarettes : Approx. 1/person-h (including non-smokers)
  - Length of cigarette (tobacco section) : Approx. 4 cm
  - Amount of dust generated by one cigarette : Approx. 10 mg/cigarette

### 3. Calculation Table for Dust Collection Efficiency of Each Lossnay Filter

Measurement method Tested dust		Applicable model	AFI Gravitational method	ASHRAE Colorimetric method	Certificate in EU	Counting method (DOP method)		Application
			Compound dust	Atomspheric dust		JIS 14 types DOP 0.8 μm	DOP 0.3 μm	
Filter type								
Pre-filter	NP/400	Commercial Lossnay (LGH)	82%	8% - 12%	G3 (EU3)	5% - 9%	2% - 5%	Protection of heat recovery element
High efficiency filter	Model PZ-15RFM - 100RFM	Optional Part for model LGH-15RX <sub>5</sub> - 200RX <sub>5</sub>	99%	65%	F7 (EU7)	60%	25%	Assurance of sanitary environment (According to Building Management Law)

#### 3.1 High-Efficiency Filter (Optional Parts)

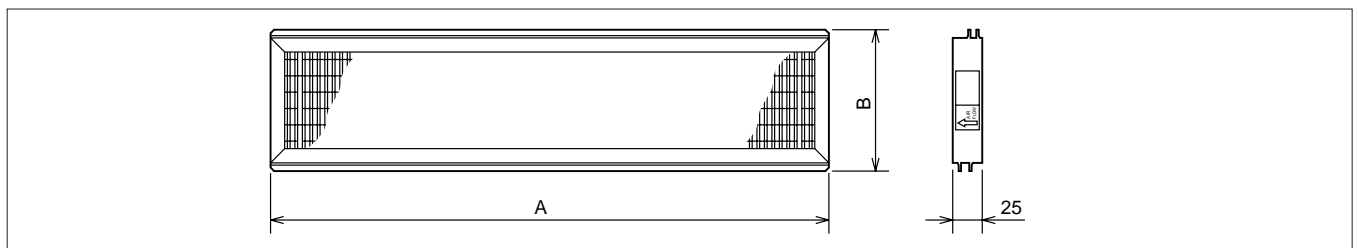

Model		PZ-15RFM-E	PZ-25RFM-E	PZ-35RFM-E	PZ-50RFM-E	PZ-65RFM-E	PZ-80RFM-E	PZ-100RFM-E
Applicable Model		—	LGH-15RX <sub>5</sub> -E LGH-25RX <sub>5</sub> -E	LGH-35RX <sub>5</sub> -E	LGH-50RX <sub>5</sub> -E	LGH-65RX <sub>5</sub> -E	LGH-80RX <sub>5</sub> -E LGH-150RX <sub>5</sub> -E (2sets)	LGH-100RX <sub>5</sub> -E LGH-200RX <sub>5</sub> -E (2sets)
Dimension(mm)	A	553	327	393	464	427	446	559
	B	119	144	171	171	205	232	232
Number of filters per set		1	2	2	2	2	2	2

**Note:** This is one set per main body.

#### 3.2 Pressure Loss

##### ■ Pressure Loss Characteristics

**PZ-15RFM-E**

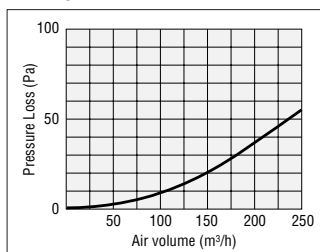

**PZ-25RFM-E**

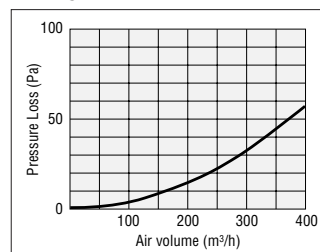

**PZ-35RFM-E**

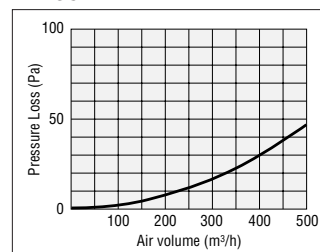

**PZ-50RFM-E**

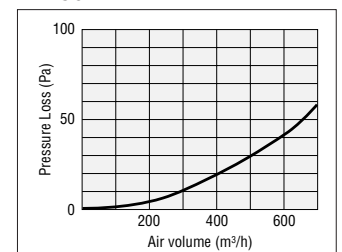

**PZ-65RFM-E**

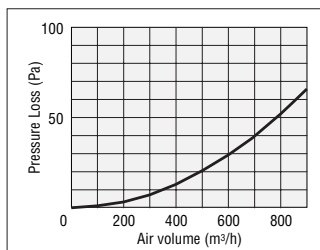

**PZ-80RFM-E**

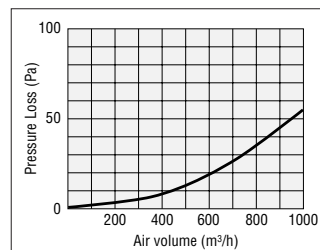

**PZ-100RFM-E**

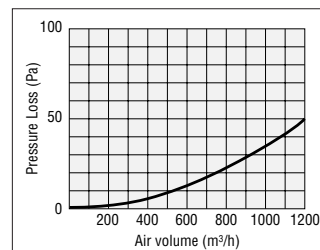

## CHAPTER 8 ● Filters

Effectiveness of the filters used in the Lossnay units are shown below, expressed in terms of collection ratio (%).

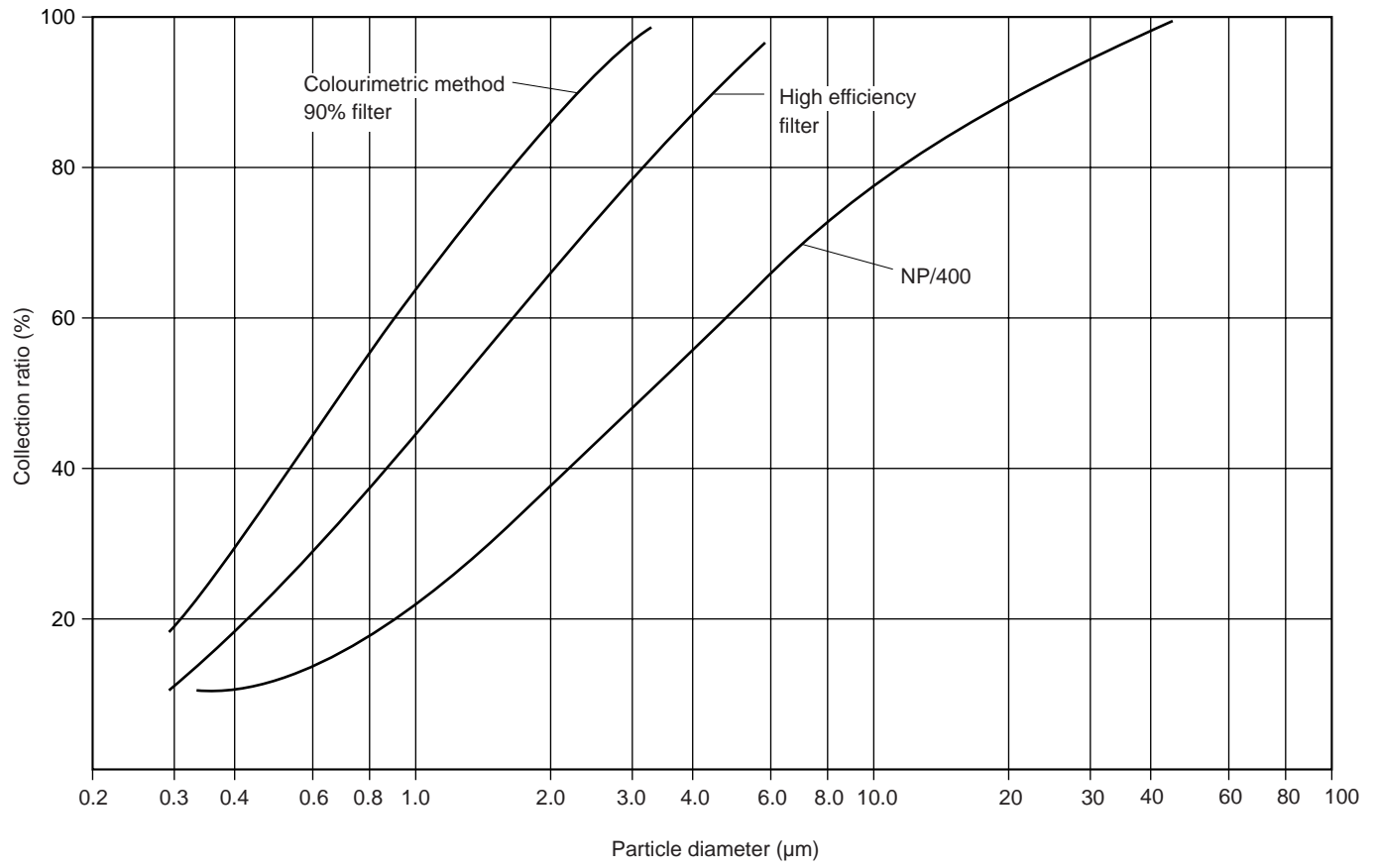

## 4. Comparing Dust Collection Efficiency Measurement Methods

The gravitational, colorimetric, and counting methods used for measuring dust collection efficiency each have different features and must be used according to filter application.

Test Method	Test Dust	Inward Flow Dust Measurement Method	Outward Flow Dust Measurement Method	Efficiency Indication Method	Type of Applicable Filters
AFI Gravitational method	Synthetic: • Dust on standard road in Arizona: 72% • K-1 carbon black: 25% • No. 7 cotton lint: 3%	Dust weight measured beforehand	• Filter passage air volume measured • Weigh the dust remaining on the filter and compare	Gravitational ratio	Synthetic dust filters
NBS Colorimetric method	Atmospheric dust	Degree of contamination of white filter paper	Degree of contamination of white filter paper	Comparison of contamination of reduction in degree of contamination	Electrostatic dust percentage of (for air conditioning)
DOP Counting method	Diameter of dioctyl-phthalate small drop particles: 0.3 µm	Electrical counting measurement using light aimed at DOP	Same as left	Counting ratio	Absolute filter and same type of high efficiency filter
ASHRAE Gravitational method	Synthetic: • Regulated air cleaner fine particles: 72% • Morocco Black: 23% • Cotton linter: 5%	Dust weight measured beforehand	• Filter passage air volume measured • Weigh the dust remaining on the filter and compare	Gravitational ratio	Pre-filter Filter for air conditioning (for coarse dust)
ASHRAE Colorimetric method	Atmospheric dust	Degree of contamination of white filter paper	Degree of contamination of white filter paper	Comparison of percentage of reduction in degree of contamination	Filter for air conditioning (for fine dust) Electrostatic dust collector
Air filter test for air conditioning set by Japan Air Cleaning Assoc. (Colorimetric test)	JIS 11-type dust	Degree of contamination of white filter paper	Degree of contamination of white filter paper	Comparison of percentage of reduction in degree of contamination	Filter for air conditioning
Pre-filter test set by Japan Air Cleaning Assoc. (Gravitational test)	JIS 8-type dust	Dust weight measured beforehand.	• Filter passage air volume measured • Weigh the dust remaining on the filter and compare.	Gravitational ratio	Pre-filter
Electrostatic air cleaning device test set by Japan Air Cleaning Assoc. (Colorimetric test)	JIS 11-type dust	Degree of contamination of white filter paper	Degree of contamination of white filter paper	Comparison of percentage of reduction in degree of contamination	Electrostatic dust collector

### Gravitational Method

This method is used for air filters that remove coarse dust (10 µm or more). The measurement method is determined by the gravitational ratio of the dust amount on the in-flow and out-flow sides.

$$\text{Dust collection ratio} = \frac{\text{In-flow side dust amount} - \text{Out-flow side dust amount}}{\text{In-flow side dust amount}} \times 100 (\%)$$

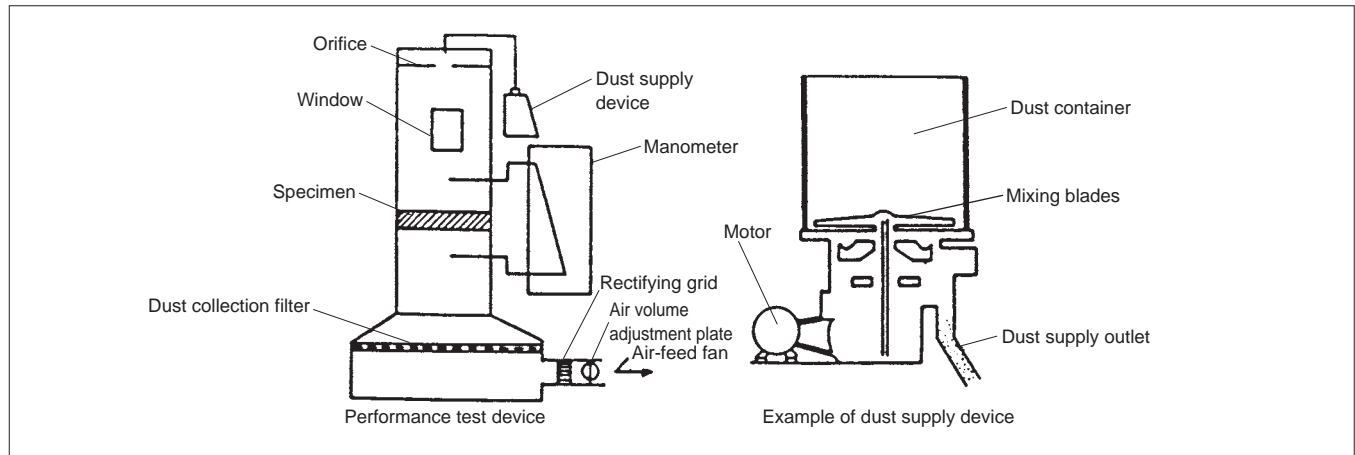

### Colorimetric Method

The in-flow side air and out-flow side air are sampled using a suction pump and passed through filtering paper. The sampled air is adjusted so that the degree of contamination on both filter papers is the same, and the results are determined by the sampled air volume ratios on both sides.

$$\text{Dust collection ratio} = \frac{\text{Out-flow side sampling amount} - \text{In-flow side sampling amount}}{\text{Out-flow side sampling amount}} \times 100 (\%)$$

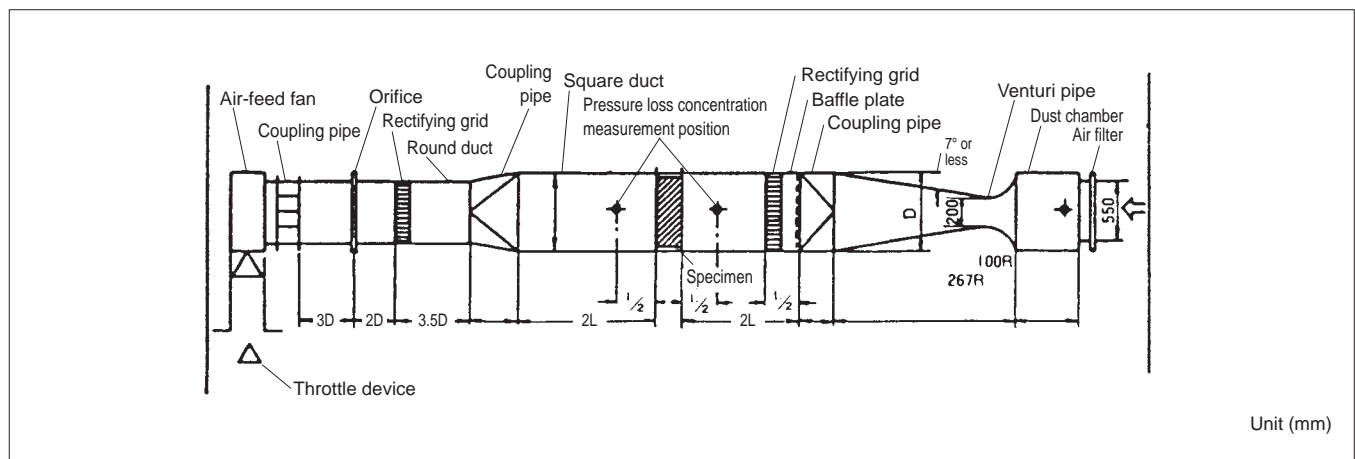



## 5. Calculating Dust Concentration Levels

An air conditioning system using Lossnay units is shown below. Dust concentration levels can be easily determined using this diagram.

Dust Concentration Study Diagram

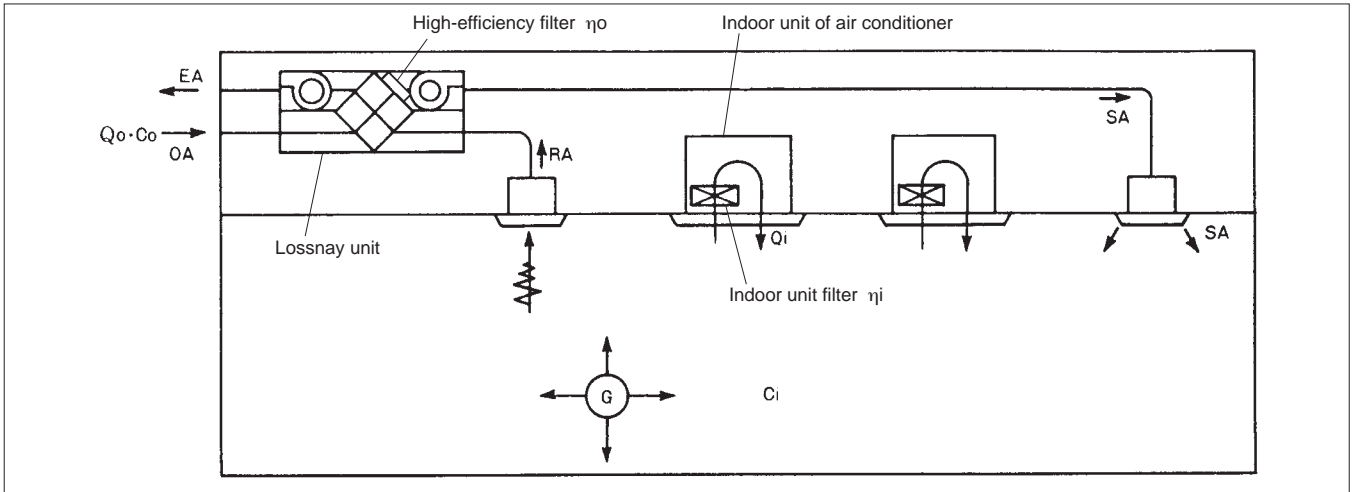

- Q<sub>o</sub> : Outdoor air intake amount (m<sup>3</sup>/h)
- Q<sub>i</sub> : Indoor unit of air conditioner air volume (Total air volume of indoor unit) (m<sup>3</sup>/h)
- η<sub>o</sub> : Filtering efficiency of humidifier with high efficiency filter % (colorimetric method)
- η<sub>i</sub> : Efficiency of the filter for the indoor unit of air conditioner % (colorimetric method)
- C<sub>o</sub> : Outdoor air dust concentration (mg/m<sup>3</sup>)
- C<sub>i</sub> : Indoor dust concentration (mg/m<sup>3</sup>)
- G : Amount of dust generated indoors (mg/h)

When the performance of each machine is known, the indoor dust concentration C<sub>i</sub> may be obtained with the filter performance, η<sub>o</sub> and η<sub>i</sub> having been set to specific values as per manufacturer's data. The following formula is used:

$$C_i = \frac{G + C_o Q_o (1 - \eta_o)}{Q_o + Q_i \eta_i}$$

Also, with the value of C<sub>i</sub> and η<sub>o</sub> known, indoor unit of air conditioner efficiency can be found using:

$$\eta_i = \frac{G + C_o Q_o (1 - \eta_o) - C_i Q_o}{C_i Q_i} \times 100$$

## 6. Certificate in EU

Pre-filter of LGH-RX5 series are certificated as G3(EU3), and High-efficiency filter of model PZ-15-100RFM are certificated as F7(EU7) under BS EN779 : 1993 / Eurovent 4/5 Filter Test.

Certificate No. C18070A/3



Certificate No. C18070B/2

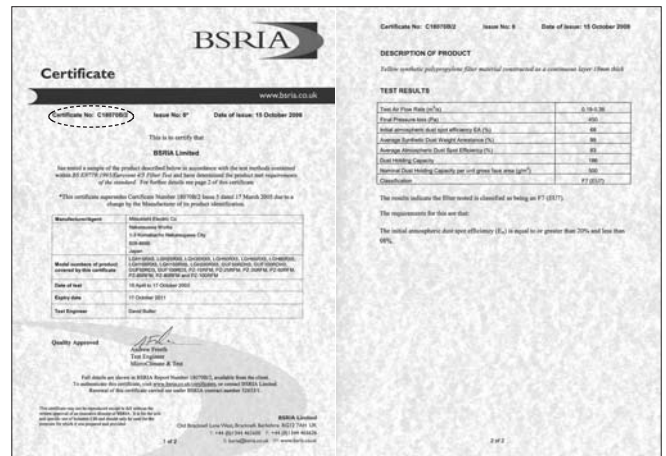

**Note:** The model names shown in these certifications are only LGH-15 to 200RX5-E for 50Hz area.



**CHAPTER 9**  
**Service Life and Maintenance**

# 1. Service Life

The Lossnay Core has no moving parts, which eliminates vibration problems and permits greater installation flexibility. In addition, chemicals are not used in the energy recovery system. Performance characteristics remain constant throughout the period of service.

A lifetime test, currently in progress and approaching thus for 17,300 hours, has revealed no evidence of either reduction in energy recovery efficiency or material deterioration. If 2,500 hours is assumed to be the number of hours an air conditioner is used during a year, 17,300 hours equals to about seven (7) years.

(This is not a guarantee of the service life.)

# 2. Cleaning the Lossnay Core and Pre-filter

Remove all dust and dirt on air filters and Lossnay cores at regular intervals in order to prevent a deterioration in the Lossnay functions.

Guideline: Clean the air filters once a year. (or when "FILTER" and "CLEANING" are indicated on the remote controller)

Clean the Lossnay cores once two year. (Clean the Lossnay cores once a year If possible.)

(Frequency should be increased depending on the extent of dirt.)

## 2.1 Removing the parts

### 1) Maintenance cover

Locate and remove the cover fixing screw. Pull back the hinged clip. Open the door and lift off of the hinge brackets.

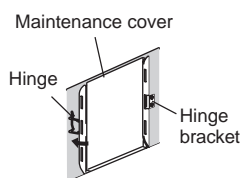

Models LGH-15 to 100RXs

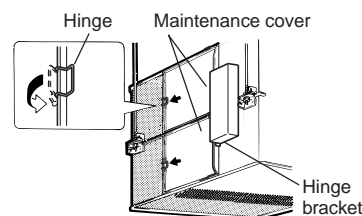

Models LGH-150 and 200RXs

### 2) Lossnay cores

Take hold of the handle and draw the Lossnay cores out from the main unit.

- Models LGH-15 to 100 RXs: ..... 2 cores
- Models LGH-150 and 200 RXs: ..... 4 cores

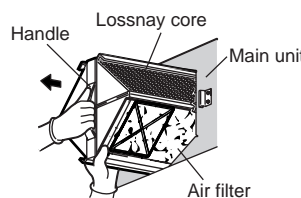

Models LGH-15 to 100RXs

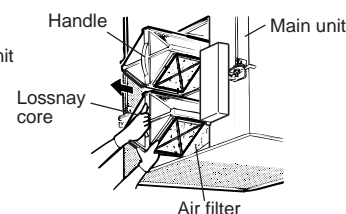

Models LGH-150 and 200RXs

### 3) Air filters

After pulling out the Lossnay cores, undo filter guides, then remove the air filters, located at the bottom left and right of the Lossnay cores, as below.

- Models LGH-15 to 100 RXs: ..... 4 filters
- Models LGH-150 and 200 RXs: ..... 8 filters

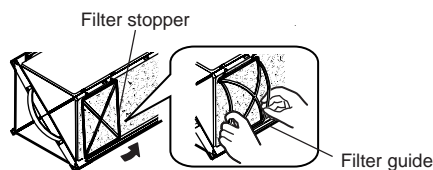

### ⚠ CAUTION

- Bow filter stoppers a little to remove them from filter guide.
- Take filter stoppers careful not to break them.

## 2.2 Cleaning the parts

### 1) Air filters

Use a vacuum cleaner to remove light dust. To remove stubborn dirt wash in a mild solution of detergent and lukewarm water. (under 40°C)

#### ⚠ CAUTION

- Never wash the filters in very hot water and never wash them by rubbing them.
- Do not dry the filters by exposing them to a flame.

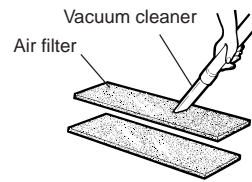

### 2) Lossnay cores

Use a vacuum cleaner to suck up the dust and dirt on the exposed surfaces of the Lossnay cores.

Use a soft brush only to clean exposed surface areas.

#### ⚠ CAUTION

- Do not use the hard nozzle of the vacuum cleaner. It may damage the exposed surfaces of the Lossnay cores.
- Under no circumstances should the Lossnay cores be washed in water.

**Do NOT wash in water.**

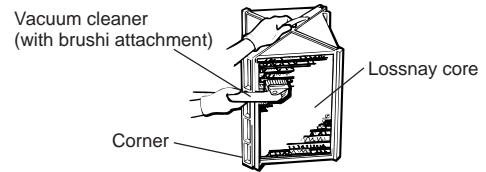

## 2.3 Assembly after maintenance

Bearing in mind the following points, assemble the parts following the sequence for their removal in reverse.

- Arrange the Lossnay core with the air filter side as shown in the name plate on the Lossnay unit.
- The filter for LGH-35RXs has front and back side. Set the "FRONT" (printed) side of the filter on the outer side.

#### Note

- If "FILTER" and "CLEANING" are indicated on the remote controller, turn off the indication, after maintenance.



**CHAPTER 10**  
**Ventilation Standards in Each Country**

# 1. Ventilation Standards in Each Country

## 1.1 Japan

### Summary of Laws Related to Ventilation

Item Related Laws	Acceptable Range	Room Environment Standard Values	Remarks												
Law for Maintenance of Sanitation in Buildings	Buildings of at least 3,000 m <sup>2</sup> (for schools, at least 8,000 m <sup>2</sup> ).	<p>If a central air quality management system or mechanical ventilation equipment is installed, comply with the standard target values shown in the table below.</p> <table border="1"> <tr> <td><b>Impurity Volume of Particles</b></td> <td>Less than 0.15 mg per 1 m<sup>3</sup> of air</td> </tr> <tr> <td><b>CO Rate</b></td> <td>Less than 10 ppm. (Less than 20 ppm when outside supply air has a CO rate of more than 10 ppm.)</td> </tr> <tr> <td><b>CO<sub>2</sub> Rate</b></td> <td>Less than 1,000 ppm.</td> </tr> <tr> <td><b>Temperature</b></td> <td>1) Between 17°C and 28°C 2) When making the room temperature cooler than the outside temperature, do not make the difference too great.</td> </tr> <tr> <td><b>Relative Humidity</b></td> <td>40% - 70%</td> </tr> <tr> <td><b>Ventilation</b></td> <td>Less than 0.5 m/sec.</td> </tr> </table>	<b>Impurity Volume of Particles</b>	Less than 0.15 mg per 1 m <sup>3</sup> of air	<b>CO Rate</b>	Less than 10 ppm. (Less than 20 ppm when outside supply air has a CO rate of more than 10 ppm.)	<b>CO<sub>2</sub> Rate</b>	Less than 1,000 ppm.	<b>Temperature</b>	1) Between 17°C and 28°C 2) When making the room temperature cooler than the outside temperature, do not make the difference too great.	<b>Relative Humidity</b>	40% - 70%	<b>Ventilation</b>	Less than 0.5 m/sec.	Applicable buildings are those designed to serve a specific purpose.
<b>Impurity Volume of Particles</b>	Less than 0.15 mg per 1 m <sup>3</sup> of air														
<b>CO Rate</b>	Less than 10 ppm. (Less than 20 ppm when outside supply air has a CO rate of more than 10 ppm.)														
<b>CO<sub>2</sub> Rate</b>	Less than 1,000 ppm.														
<b>Temperature</b>	1) Between 17°C and 28°C 2) When making the room temperature cooler than the outside temperature, do not make the difference too great.														
<b>Relative Humidity</b>	40% - 70%														
<b>Ventilation</b>	Less than 0.5 m/sec.														
The Building Standard Law of Japan	<p>Buildings with requirements for ventilation equipment.</p> <ol style="list-style-type: none"> <li>1) Windowless rooms.</li> <li>2) Rooms in theaters, movie theaters, assembly halls, etc.</li> <li>3) Kitchens, bathrooms, etc.</li> </ol> <p>Rooms with equipment or devices using fire.</p>	<p>Central air quality management system ventilation capacity and characteristics</p> <p>Effective ventilation capacity <math>V \geq 20Af/N(\text{m}^3)</math>                      Af: Floor space (m<sup>2</sup>); N: Floor space occupied by one person</p> <table border="1"> <tr> <td><b>Impurity Volume of Particles</b></td> <td>Less than 0.15 mg per 1 m<sup>3</sup> of air</td> </tr> <tr> <td><b>CO Rate</b></td> <td>Less than 10 ppm.</td> </tr> <tr> <td><b>CO<sub>2</sub> Rate</b></td> <td>Less than 1,000 ppm.</td> </tr> <tr> <td><b>Temperature</b></td> <td>1) Between 17°C and 28°C 2) When making the room temperature cooler than the outside temperature, do not make the difference too great.</td> </tr> <tr> <td><b>Relative Humidity</b></td> <td>40% - 70%</td> </tr> <tr> <td><b>Ventilation</b></td> <td>Less than 0.5 m/sec.</td> </tr> </table>	<b>Impurity Volume of Particles</b>	Less than 0.15 mg per 1 m <sup>3</sup> of air	<b>CO Rate</b>	Less than 10 ppm.	<b>CO<sub>2</sub> Rate</b>	Less than 1,000 ppm.	<b>Temperature</b>	1) Between 17°C and 28°C 2) When making the room temperature cooler than the outside temperature, do not make the difference too great.	<b>Relative Humidity</b>	40% - 70%	<b>Ventilation</b>	Less than 0.5 m/sec.	Applicable buildings are those with ventilation equipment requirements.
<b>Impurity Volume of Particles</b>	Less than 0.15 mg per 1 m <sup>3</sup> of air														
<b>CO Rate</b>	Less than 10 ppm.														
<b>CO<sub>2</sub> Rate</b>	Less than 1,000 ppm.														
<b>Temperature</b>	1) Between 17°C and 28°C 2) When making the room temperature cooler than the outside temperature, do not make the difference too great.														
<b>Relative Humidity</b>	40% - 70%														
<b>Ventilation</b>	Less than 0.5 m/sec.														
Industrial Safety and Health Act	Offices. (Office sanitation regulated standards)	<p>For general ventilation, the effective ventilation area opening is at least 1/20 of the floor space, and the ventilation equipment installed gives a CO density of 50 ppm and CO<sub>2</sub> density of 5,000 ppm or less. If a central air quality management system or mechanical ventilation equipment is installed, comply with the standard target values shown in the table below.</p> <table border="1"> <tr> <td><b>Impurity Volume of Particles</b></td> <td>Air (1 atmospheric pressure, 25°C) less than 0.15 mg per 1 m<sup>3</sup> of air</td> </tr> <tr> <td><b>CO Rate</b></td> <td>Less than 10 ppm. (Less than 20 ppm when outside supply air has a CO rate of more than 10 ppm.)</td> </tr> <tr> <td><b>CO<sub>2</sub> Rate</b></td> <td>Less than 1,000 ppm.</td> </tr> <tr> <td><b>Air Flow</b></td> <td>Air flow in room is less than 0.5 m/s, and air taken into the room does not blow directly on or reach occupants.</td> </tr> <tr> <td><b>Heat and Humidity Conditions</b></td> <td>Heat between 17°C - 28°C Relative humidity 40% - 70%</td> </tr> </table>	<b>Impurity Volume of Particles</b>	Air (1 atmospheric pressure, 25°C) less than 0.15 mg per 1 m <sup>3</sup> of air	<b>CO Rate</b>	Less than 10 ppm. (Less than 20 ppm when outside supply air has a CO rate of more than 10 ppm.)	<b>CO<sub>2</sub> Rate</b>	Less than 1,000 ppm.	<b>Air Flow</b>	Air flow in room is less than 0.5 m/s, and air taken into the room does not blow directly on or reach occupants.	<b>Heat and Humidity Conditions</b>	Heat between 17°C - 28°C Relative humidity 40% - 70%			
<b>Impurity Volume of Particles</b>	Air (1 atmospheric pressure, 25°C) less than 0.15 mg per 1 m <sup>3</sup> of air														
<b>CO Rate</b>	Less than 10 ppm. (Less than 20 ppm when outside supply air has a CO rate of more than 10 ppm.)														
<b>CO<sub>2</sub> Rate</b>	Less than 1,000 ppm.														
<b>Air Flow</b>	Air flow in room is less than 0.5 m/s, and air taken into the room does not blow directly on or reach occupants.														
<b>Heat and Humidity Conditions</b>	Heat between 17°C - 28°C Relative humidity 40% - 70%														



## 2. United States of America

ASHRAE Standard 62 - 2001

Application	Outdoor Air Requirements	Estimated Maximum* Occupancy P/1000 ft <sup>2</sup> or 100 m <sup>2</sup>
Commercial dry cleaner	30 cfm/person	30
Dining rooms	20 cfm/person	70
Bars, cocktail lounges	30 cfm/person	100
Kitchens (cooking)	15 cfm/person	20
Hotel bedrooms	30 cfm/room	—
Hotel living rooms	30 cfm/room	—
Hotel lobbies	15 cfm/person	30
Gambling casinos	30 cfm/person	120
Office space	20 cfm/person	7
Conference room	20 cfm/person	50
Smoking lounge	60 cfm/person	70

\* Net occupiable space.

## 3. United Kingdom

CIBSE

Application	Outdoor air			Smoking
	Recommended	Minimum		
		Per person	Per person	
Factories	8 l/s /person	5 l/s /person	0.8 l/s / m <sup>2</sup>	None
Offices (open plan)	8 l/s /person	5 l/s /person	1.3 l/s / m <sup>2</sup>	Some
Shops, department stores, and supermarkets	8 l/s /person	5 l/s /person	3.0 l/s / m <sup>2</sup>	Some
Theaters	8 l/s /person	5 l/s /person	—	Some
Dance halls	12 l/s /person	8 l/s /person	—	Some
Hotel bedrooms	12 l/s /person	8 l/s /person	1.7 l/s / m <sup>2</sup>	Heavy
Laboratories	12 l/s /person	8 l/s /person	—	Some
Offices (private)	12 l/s /person	8 l/s /person	1.3 l/s / m <sup>2</sup>	Heavy
Residences (average)	12 l/s /person	8 l/s /person	—	Heavy
Restaurant (cafeteria)	12 l/s /person	8 l/s /person	—	Heavy
Cocktail bars	18 l/s /person	12 l/s /person	—	Heavy
Conference rooms (average)	18 l/s /person	12 l/s /person	—	Some
Residence	18 l/s /person	12 l/s /person	—	Heavy
Restaurant	18 l/s /person	12 l/s /person	—	Heavy
Board rooms, executive offices, and conference rooms	25 l/s /person	18 l/s /person	6.0 l/s / m <sup>2</sup>	Very Heavy
Corridors	N/A	N/A	1.3 l/s / m <sup>2</sup>	N/A
Kitchens (domestic)	N/A	N/A	10.0 l/s / m <sup>2</sup>	N/A
Kitchens (restaurant)	N/A	N/A	20.0 l/s / m <sup>2</sup>	N/A
Toilets	N/A	N/A	10.0 l/s / m <sup>2</sup>	N/A



**CHAPTER 11**  
**Lossnay Q and A**

## CHAPTER 11 ● Lossnay Q and A

	Question	Answer	Remarks
1	Paper is used for the material, but does it have an adequate life span?	The cellulose membrane will last an adequate amount of time unless it is intentionally damaged, placed in water or in direct sunlight (ultra-violet rays). The life is longer than metal as it does not rust.	Depending on conditions, the cellulose membrane can be stored for up to 2,000 years without deteriorating.
2	Is the paper an insulation material? (Poor conductor of heat)	The cellulose membrane is very thin, and thus the conductivity of the material is low, with heat being transferred approximately the same as metal. This can be tested placing a piece of paper between hands and feel the warmth of the palms. The recovery of humidity can also be felt by blowing on the paper and feeling the moisture in the breath being transferred to the palm.	
3	If the paper can recover humidity, will it not become wet?	It is similar to the phenomenon during heating in winter where the window pane is wet but the paper blinds are dry - humidity is transferred through the paper membrane.	
4	When is the forced simultaneous air intake/exhaust-type more efficient?	When a building is sealed and normal ventilation is used, accurate exhaust is not possible unless a suction inlet is created. Lossnay units have both an air-supply fan and air-exhaust fan so "Class 1" ventilation is possible.	
5	What are the energy conservation properties of Lossnay units?	For an example, in an approx. 13 m <sup>2</sup> room with five people, a ventilation volume of 100 m <sup>3</sup> /h is required. The amount of power consumed in this case is approximately 45 W, and the amount of energy recovered during cooling is approximately 700 W or more. The coefficient of performance (C.O.P.) obtained when converted with the unit power generation amount is 16. When compared to a popular heat pump has a C.O.P. of 2 to 3, the Lossnay can serve a high amount of energy. If a general-purpose ventilator is installed, the cooled air will be lost, thus increasing electrical costs throughout the year.	

	Question	Answer	Remarks																											
6	<p>What are the economical factors? (Using Japan specifications)</p>	<p>Between 55 to 60% of the heat energy that escapes with ventilation is recovered by Lossnay unit, so the cooling/heating cost can be reduced by approximately 43,000 yen per year. The initial costs can be reduced down to a 59,000 yen increase when comparing an air conditioner, Lossnay, and ventilator (fixed price base).</p> <p><b>Calculation conditions</b>                      Cooling:                      Room temperature/humidity: 26°C, 50%                      Outdoor air temperature/humidity: 32°C, 70%                      Heating:                      Room temperature/humidity: 20°C, 50%                      Outdoor air temperature/humidity: 0°C, 50%                      Building:                      General office facing south on middle floor: 100 m<sup>2</sup>                      Cooling load (room): 104 W/m<sup>2</sup>                      Heating load (room): 77.7 W/m<sup>2</sup>                      Ventilation volume: 500 m<sup>3</sup>/h                      Without Lossnay: Straight lock fan BFS-50SU . . . . . Two units                      With Lossnay: Lossnay LGH-50RX type . . . . . One unit                      Cooling/heating load (W):</p> <table border="1" data-bbox="523 878 1209 1028"> <thead> <tr> <th rowspan="2"></th> <th colspan="3">Without Lossnay</th> <th colspan="3">With Lossnay</th> </tr> <tr> <th>Room</th> <th>Outdoors</th> <th>Total</th> <th>Room</th> <th>Outdoors</th> <th>Total</th> </tr> </thead> <tbody> <tr> <td>Cooling</td> <td>10,400</td> <td>5,560</td> <td>15,960</td> <td>10,400</td> <td>2,340</td> <td>12,740</td> </tr> <tr> <td>Heating</td> <td>7,770</td> <td>5,630</td> <td>13,400</td> <td>7,770</td> <td>2,140</td> <td>9,910</td> </tr> </tbody> </table> <p>Air conditioner:                      Without Lossnay : Ceiling-suspended cassette-type air conditioner PLZ-J140KA9G9 . . . . . One unit                      With Lossnay : PLZ-J112KA9G9 . . . . . One unit                      Operation time:                      Cooling 10 hours/day, 26 days/month, 4 months/year,                      operation ratio: 0.7                      Heating 10 hours/day, 26 days/month, 5 months/year,                      operation ratio: 0.7                      Power costs (Tokyo Power special industrial power 6 kV supply)                      Summer: 16.15 yen /kWh, Other 14.65/kWh</p>		Without Lossnay			With Lossnay			Room	Outdoors	Total	Room	Outdoors	Total	Cooling	10,400	5,560	15,960	10,400	2,340	12,740	Heating	7,770	5,630	13,400	7,770	2,140	9,910	<p>There are also "savings in maintenance costs", "ventilation functions", "soundproofing" as well as "comfort" and "safety".</p>
	Without Lossnay			With Lossnay																										
	Room	Outdoors	Total	Room	Outdoors	Total																								
Cooling	10,400	5,560	15,960	10,400	2,340	12,740																								
Heating	7,770	5,630	13,400	7,770	2,140	9,910																								
7	<p>If the air ventilated from the toilet is included in heat-recovery, will the odors be transferred to other rooms?</p>	<p>For an example; if the total ventilation volume is 100, and the amount of odors generated from the toilet, etc., is 30, the total volume of conditioned air is still three times the ventilation amount. Thus, if the leakage rate of odors is 7% (hydrogen sulphide), it will be: <math>100 \times 30\% \times 1/3 \times 7\% = 0.7\%</math>, and there are no problems in terms of total air conditioned air volume. However, exhaust is usually performed with a separate system. In the case of ammonia, the rate is 2.8% using the same formula.</p> <p><b>Note:</b> (The rotary-type has approximately the same transmission rate, but for ammonia, the transmission rate is 50% or more than the Lossnay energy recovery method.)</p>	<p>&lt;Gas/smoke transmission rate&gt;                      CO : 1%                      CO<sub>2</sub> : 2%                      H<sub>2</sub>S : 3%                      NH<sub>3</sub> : 3%                      Smoke : 1% - 2%                      Conditions (Supply and exhaust fans installed for suction feed. Standard treatment air volume.)</p>																											

**CHAPTER 11 ● Lossnay Q and A**

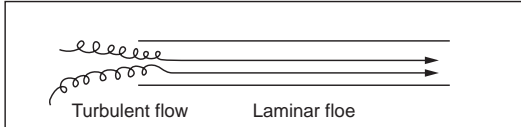
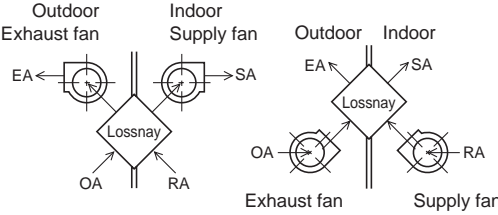
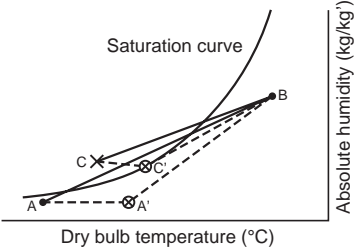
	Question	Answer	Remarks
8	Can Lossnay units be used for hospital air conditioning?	<p>According to the results from a test performed by the Tokyo University Hospital (Inspection Center, Prof. Kihachiro Shimizu), as the supply air and exhaust air pass through different passages, bacteria transmission from exhaust side to supply side is low. They found:</p> <ol style="list-style-type: none"> <li>1) Bacteria do not propagate in the Lossnay Core.</li> <li>2) Even if bacteria accumulated in the Lossnay unit, it died off in approximately two weeks.</li> </ol>	
9	Because entry into the Lossnay Core is small, won't it clog easily?	<p>Normally the original state of the filter can be regained by cleaning it with a vacuum more than once every year, and the two intake side surfaces of the Lossnay Core more than once every two years. Dust will not accumulate in the passage due to the laminar flow if the air is normal.</p> 	<p>“Normal air” refers to air that does not contain oil mist, etc. When exhausting air contains oil mist, etc., install a filter at return grille.</p>
10	What is the air leakage rate?	<p>This will be different depending on the position of the fans, but for “both suction” or “both forced”, the rate is 2% to 3%. LGH type fan position is “both forced”.</p>  <p>For using LU type, if the difference in static pressure between SA and RA, and EA and OA is 500 Pa, the air leakage rate will be 2.5% and 3.4% respectively. This value is not a problem for actual use. However, the single suction or single forced methods will have a leakage rate of 10% or higher and should be avoided.</p>	
11	Can Lossnay units be used in extreme cold climates (-10°C or lower)?	<p>If the winter room air temperature is above 20°C, humidity is above 50%, and the outdoor temperature is -10°C or lower, moisture condensation or frost will develop on the Lossnay Core. In this case, the intake air must be preheated.</p> <p>Plot the Lossnay intake side air conditions A and B on a psychrometric chart as shown below. If the high temperature side air B intersects the saturation curve such as at C, moisture condensation or frost will accumulate on the Lossnay unit. In this case, the air should be warmed up to the temperature indicated by Point A' so that Point C reaches the C' point.</p> 	

	Question	Answer	Remarks																										
12	Will tobacco and tar affect the Lossnay Core?	Tobacco smoke tends to adhere to dust, and when it passes through the Lossnay Core, most of the nicotine and tar will be filtered by the air filter. However, in very smoky places (ex. gambling parlors, casinos), or when used for a long period, the tobacco will accumulate and move to the intake side. In this case, the Core and filter should be replaced.	Ample filtering will not be possible with a net air filter.																										
13	What are the guidelines for ventilation. (These are Japan guidelines.)	<p>According to the “The Building Standard Law of Japan”, a ventilation volume of 20 m<sup>3</sup>/h-person is required if the windows cannot be opened for ventilation.</p> <p>In buildings to which the Law for Maintenance of Sanitation in Buildings is applied, the carbon gas concentration must be 0.1% or less, so a ventilation of 34 m<sup>3</sup>/h-person is required. In Tokyo, the guideline is set at 25 to 30 m<sup>3</sup>/h-person.</p> <p>The required ventilation volume per person is noted below.</p> <table border="1" data-bbox="523 689 1209 1173"> <thead> <tr> <th rowspan="2">Degree of Smoking</th> <th rowspan="2">Application Example</th> <th colspan="2">Required Ventilation Volume (m<sup>3</sup>/h)</th> </tr> <tr> <th>Recommended Value</th> <th>Minimum Value</th> </tr> </thead> <tbody> <tr> <td>Extremely heavy</td> <td>Broker’s office Newspaper editing room Conference room</td> <td>85</td> <td>51</td> </tr> <tr> <td>Quite Heavy</td> <td>Bar Cabaret</td> <td>51</td> <td>42.5</td> </tr> <tr> <td>Heavy</td> <td>Office Restaurant</td> <td>25.5 25.5</td> <td>17 20</td> </tr> <tr> <td>Light</td> <td>Shop Department store</td> <td>25.5</td> <td>17</td> </tr> <tr> <td>None</td> <td>Theater Hospital room</td> <td>25.5 34</td> <td>17 25.5</td> </tr> </tbody> </table>	Degree of Smoking	Application Example	Required Ventilation Volume (m <sup>3</sup> /h)		Recommended Value	Minimum Value	Extremely heavy	Broker’s office Newspaper editing room Conference room	85	51	Quite Heavy	Bar Cabaret	51	42.5	Heavy	Office Restaurant	25.5 25.5	17 20	Light	Shop Department store	25.5	17	None	Theater Hospital room	25.5 34	17 25.5	
Degree of Smoking	Application Example	Required Ventilation Volume (m <sup>3</sup> /h)																											
		Recommended Value	Minimum Value																										
Extremely heavy	Broker’s office Newspaper editing room Conference room	85	51																										
Quite Heavy	Bar Cabaret	51	42.5																										
Heavy	Office Restaurant	25.5 25.5	17 20																										
Light	Shop Department store	25.5	17																										
None	Theater Hospital room	25.5 34	17 25.5																										
14	Are there any locations where Lossnay units cannot be used?	Lossnay units cannot be used where toxic gases and corrosives such as acids, alkalis, organic solvents, oil mist or paints exist. The Lossnay cannot be used in energy recovery in air containing odors.																											

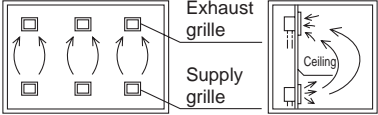
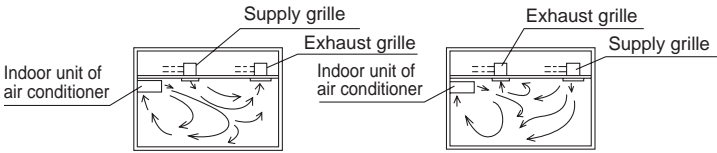
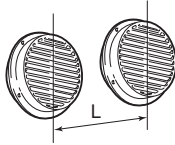
	Question	Answer	Remarks										
16	What is the short circulation of the air intake/exhaust air outlet?	<p>The Lossnay unit uses the forced simultaneous supply/exhaust method, so insufficient ventilation found in standard ventilators without air intake is found.</p> <p><b>⚠ Caution</b></p> <p>(1) The fresh outdoor air supplied to the room should not short circulate and be drawn back into the return grille - should flow through the entire room.</p>  <p>(2) The relation of the supply and suction air flows must be also considered.</p> <p>&lt; good example &gt;      &lt; bad example &gt;</p>  <p>■ The air intake/exhaust grille on the outside wall is out in the open, so there is a natural wind, and short circulation will not occur easily. However, if the wind blows from the exhaust grille towards the intake grille, short circulation may occur, so the grilles should be placed as far apart as possible. Distance should be three times the duct diameter.</p> <table border="1" data-bbox="504 1106 807 1294"> <thead> <tr> <th>Duct Diameter</th> <th>L (mm)</th> </tr> </thead> <tbody> <tr> <td>ø100</td> <td>300</td> </tr> <tr> <td>ø150</td> <td>450</td> </tr> <tr> <td>ø200</td> <td>600</td> </tr> <tr> <td>ø250</td> <td>750</td> </tr> </tbody> </table> 	Duct Diameter	L (mm)	ø100	300	ø150	450	ø200	600	ø250	750	
Duct Diameter	L (mm)												
ø100	300												
ø150	450												
ø200	600												
ø250	750												
17	Is total operation possible via the switches?	Several units can be operated with the optional control switch.											
18	What is the difference between the rotary-type and static-type?	Refer to "Chapter 3, Section 8 Comparing Energy Recovery Techniques."											
19	Is an inspection hole necessary?	For the ceiling-embedded-type, the unit is installed in the false ceiling, so an inspection hole is required to access the Core and filter, section and for fan maintenance. Refer to the installation manual for details.											
20	What must be performed during maintenance?	Periodic inspection and cleaning of the Lossnay Core and air filter is necessary. Refer to "Chapter 9, Service Life and Maintenance" for details.											
21	Can the Lossnay be used in factories?	Do not install in machine or chemical factories, where hazardous substances such as acidic gases, alkaline gases, organic solvent fumes, paint fumes, or gases containing corrosive components are generated.											



	Question	Answer	Remarks																									
22	What are “Class 1” ventilating facilities?	<p>“Class 1” ventilation refers to mechanical ventilation (forced simultaneous air supply/exhaust) using both intake and exhaust fans for suction feed. All Lossnay models (with built-in air-feed fans) are “Class 1” ventilators. The ventilation method is classified in relation to the degree of natural and/or mechanical ventilation employed.</p> <p><b>Classification of Ventilation</b></p> <table border="1" data-bbox="523 468 1217 792"> <thead> <tr> <th></th> <th>Intake</th> <th>Exhaust</th> <th>Ventilation Volume</th> <th>Room Pressure</th> </tr> </thead> <tbody> <tr> <td>Class 1</td> <td>Mechanical</td> <td>Mechanical</td> <td>Random (constant)</td> <td>Random</td> </tr> <tr> <td>Class 2</td> <td>Mechanical</td> <td>Natural</td> <td>Random (constant)</td> <td>Positive pressure</td> </tr> <tr> <td>Class 3</td> <td>Natural</td> <td>Mechanical</td> <td>Random (constant)</td> <td>Negative pressure</td> </tr> <tr> <td>Class 4</td> <td>Natural</td> <td>Assisted natural</td> <td>Limited (inconstant)</td> <td>Negative pressure</td> </tr> </tbody> </table>		Intake	Exhaust	Ventilation Volume	Room Pressure	Class 1	Mechanical	Mechanical	Random (constant)	Random	Class 2	Mechanical	Natural	Random (constant)	Positive pressure	Class 3	Natural	Mechanical	Random (constant)	Negative pressure	Class 4	Natural	Assisted natural	Limited (inconstant)	Negative pressure	
	Intake	Exhaust	Ventilation Volume	Room Pressure																								
Class 1	Mechanical	Mechanical	Random (constant)	Random																								
Class 2	Mechanical	Natural	Random (constant)	Positive pressure																								
Class 3	Natural	Mechanical	Random (constant)	Negative pressure																								
Class 4	Natural	Assisted natural	Limited (inconstant)	Negative pressure																								
23	Can the high-efficiency filter (PZ-RFM)* be installed on the supply air side?	<p>Install the high efficiency filter only on the outside air side.</p> <ul style="list-style-type: none"> <li>● If installed on the supply air side, primary dirty air will enter the Lossnay before passing through the prefilter and accelerate clogging for the Core.</li> <li>● Moisture prevention measures may also be required.</li> </ul>																										
24	What are the anti-vibration measures for Lossnay units?	Measures are not required.																										
25	Can the LGH-RX5-E types be installed vertically?	LGH-RX5-E should not be used in vertical installation.																										

\* Please consult with the nearest Lossnay supplier about part availability.

