

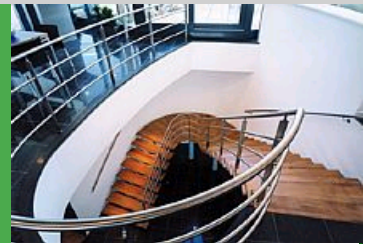

LGH-15RX5-E

Lossnay

Commercial Series



This commercially orientated system can be utilised virtually anywhere to extract stale air and then recover the heating or cooling energy to either warm or cool incoming fresh air.

- **Effective fresh air ventilation**
- **High heat recovery**
- **Free cooling function**
- **Good sound attenuation**
- **New "Hyper Eco Core". At only 25um the Lossnay core uses the thinnest paper in the world to achieve high enthalpy exchange efficiency**



Pictures not to scale

Product Details

LGH-15RX5-E

Airflow (m3/h) - Lossnay Ventilation - Lo-Hi-ExHi	70-150-150
Noise (dBA) - Lossnay Ventilation - Lo-Hi-ExHi	18-27-28
Noise (dBA) - Bypass Ventilation - Lo-Hi-ExHi	19-28-29
Width - mm	735
Depth - mm	780
Height - mm	273
Weight - kg	20
Electrical Supply	220-240v, 50Hz
Fuse Rating (BS88) - HRC (A)	6
Duct Size (mm)	100
Power Input (W) - Low	59
Power Input (W) - High	90
Power Input (W) - Extra high	110
Starting Current (A)	0.8
Running Current - Low	0.25
Running Current - High	0.38
Running Current - Extra High	0.46
Mains Cable No. Cores	3
Temperature Exchange Efficiency (%) - Low	84
Temperature Exchange Efficiency (%) - High	82
Temperature Exchange Efficiency (%) - Extra High	82

Dimensions

LGH-15RX5-E

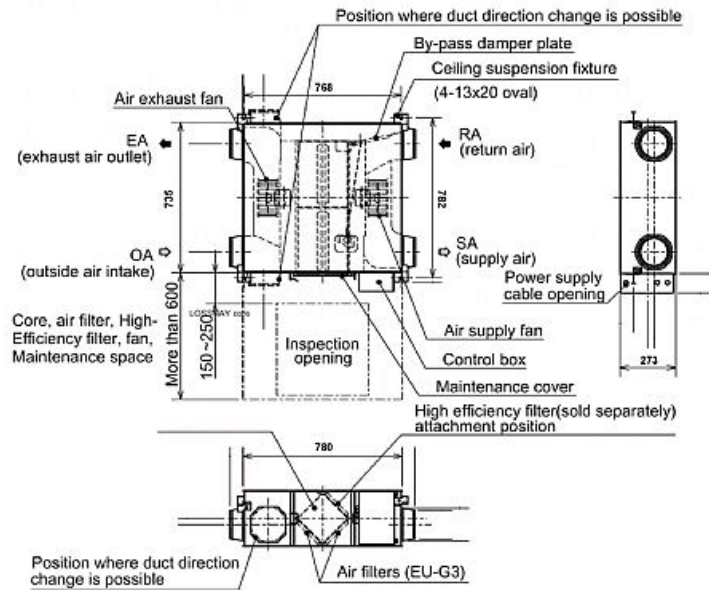

Telephone: 01707 282880

Email: air.conditioning@meuk.mee.com Website: <http://www.mitsubishielectric.co.uk/aircon>

Mitsubishi Electric reserves the right to make any variation in technical specification to the equipment described, or to withdraw or replace products without prior notification or public announcement.

Tel:
Fax:

