

Lossnay Energy Recovery Ventilator

Models:

LGH-15RX₅-E,

LGH-25RX₅-E,

LGH-35RX₅-E

LGH-50RX₅-E,

LGH-65RX₅-E,

LGH-80RX₅-E

LGH-100RX₅-E,

LGH-150RX₅-E,

LGH-200RX₅-E

Operating Instructions







(For the user)



Please read this manual carefully before use for proper and safe use.

Do not attempt to install the product by yourself.

Safety precautions

The following signs indicate that death or serious injury may be caused by failure to heed the precautions described below.

 WARNING	
 Prohibited	Do not turn the remote controller on or off when flammable gas has leaked. (It could catch fire or cause explosion with sparks released from electric contactor.) Open windows to ventilate.
 Do not disassemble	Do not modify or disassemble. (It could cause fire, electric shock or injury.)
 Do not wet	Do not apply water to the unit and remote controller. (Electrical shock can result.)
 Do not touch	Do not poke your fingers or sticks into the air intake and outlet while the product is operating. (Failure to heed this warning may result in injury.)
 Wet hands prohibited	Don't operate with wet hands. (Electrical shock can result.)
 The instructions given must be followed.	Use the specified power supply and voltage. (Use of incorrect power supply could cause fire or electric shock.) Make sure the power supply isolator is turned off on the power distribution panel before starting maintenance. (It could cause electric shock or injury if it is turned on.) When any abnormal conditions (burning smell, or others) are observed, stop operation, turn off the power supply isolator on the power distribution panel and consult your dealer. (Continuing operation under such conditions could cause electric shock, fire, or damage.)

 CAUTION	
 Prohibited	Do not place a burning appliance in a place where it is exposed directly to the wind from Lossnay. (It could cause an accident as a result of incomplete combustion.) Don't operate with the "BY-PASS" when heating the room in winter. (Condensed water may drip from the unit and wet the surface of ceiling.) Do not use at a place where exposed to high temperatures (40°C or higher), naked flames, or in environment with heavy fumes. (It could cause fire.) Do not use in an environment such as a chemical factory, where hazardous gases such as acidic gases, alkaline gases, organic solvent fumes, paint fumes, or gases containing corrosive components are generated. (It could malfunction.)
 The instructions given must be followed.	Securely install parts after maintenance. (It could cause injury if parts fall.) Put on gloves during maintenance. (It could cause injury.) Make sure the power supply isolator is turned off on the power distribution panel when Lossnay is not used for a long period of time. (It could cause electric shock, power leakage, or fire as a result of deteriorated insulation.) The appliance is not to be used by children or persons with reduced physical, sensory or mental capabilities, or lack of experience and knowledge, unless they have been given supervision or instruction. Children should be supervised to ensure that they do not play with the appliance.

Names of the parts

Models LGH-15 to 100 RX₅

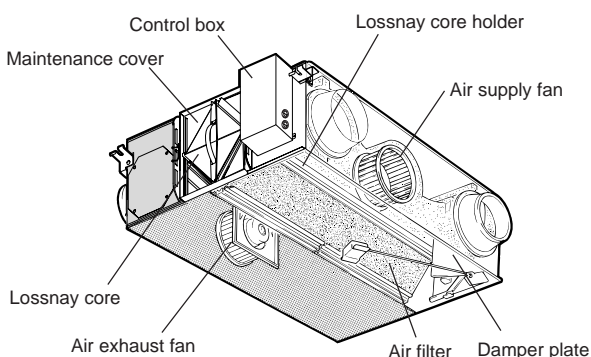

Models LGH-150 and 200 RX₅

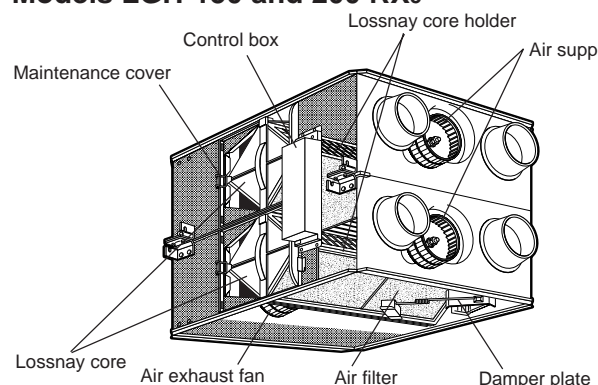

Operation

Lossnay can be connected with Lossnay remote controllers (PZ-60DR-E, PZ-41SLB-E, PZ-52SF-E), and other Systems (City multi, Mr. slim, Central controller (MELANS))

Following shows the use of PZ-60DR-E, Please refer to the manuals for the other systems.

For connection of a Lossnay remote controller (PZ-60DR-E)

If the Lossnay's operation is linked with the operation of an external device such as an air conditioner, the method of use will differ, so carry out the appropriate operation in accordance with the following table. Also, please see the installation and user's manual for the Lossnay remote controller (PZ-60DR-E).

<If not connected to an external device> (PZ-41SLB-E can not be used together with PZ-60DR-E)

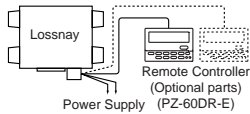
Example of System	Operation	Function
	Run using the remote controller.	<ul style="list-style-type: none"> If 2 remote controllers are used, the last controller to be used has priority. (Last Command)

<If connected to an external device> (PZ-41SLB-E can not be used together with PZ-60DR-E)

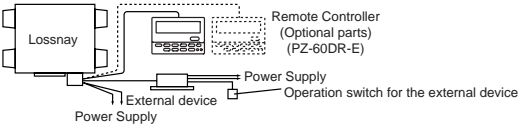
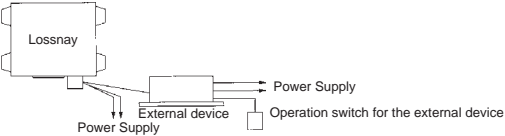
	If an external device is connected the "On/Off" function of this device will also control the Lossnay operation.	<ul style="list-style-type: none"> If you would like to turn ON the Lossnay alone while the external device is OFF, operate it by the Lossnay remote controller. The fan speed is on "High". The ventilation mode is "Ventilation Mode Auto Select".
		

■ Display and Function button (PZ-60DR-E)

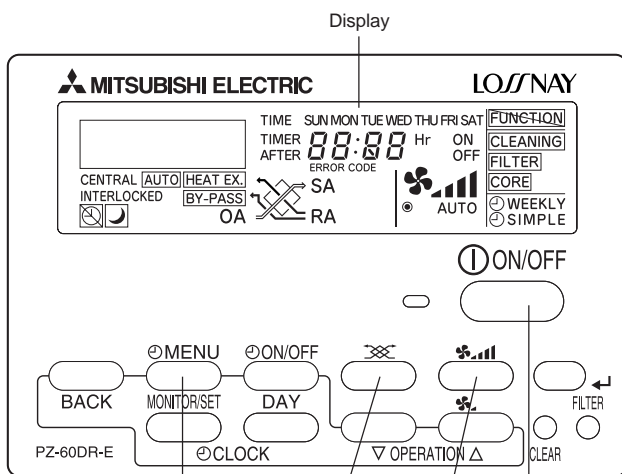

Timer Menu button (Monitor / Set button) Function selector button Fan speed Adjustment button ON/OFF button

■ LOSSNAY ENERGY RECOVERY VENTILATE setting

Both fresh air supply and return air pass through the energy recovery cores. Resulting in total heat exchange. Energy recovery ventilation makes the fresh air temperature close to the indoor temperature in the winter and the summer season.

Models LGH-15 to 100 RXs

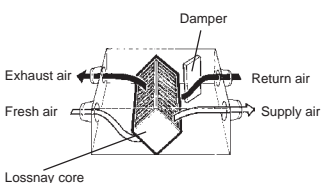

Models LGH-150 and 200 RXs

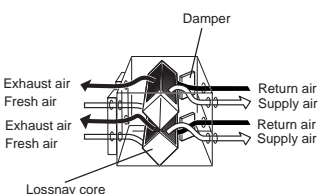

■ BY-PASS VENTILATE setting

The fresh air passes through the Lossnay cores and the return room air is exhausted direct. Lossnay bypass ventilate is normally operated during the spring/autumn months.

Models LGH-15 to 100 RXs

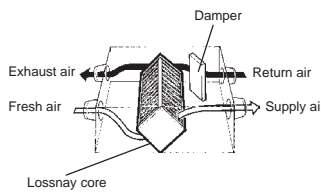

Models LGH-150 and 200 RXs

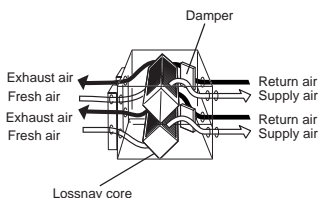

■ AUTOMATIC VENTILATION setting

The automatic damper mode automatically provides the correct ventilation for the conditions in the room. The following shows the effect "By-pass" ventilation will have under various conditions.

1. Reduces cooling load

If the air outside is cooler than the air inside the building during the cooling season (such as early morning or at night), "By-pass" ventilation will draw in the cooler outside air and reduce the cooling load on the system.

2. Night purge

"By-pass" ventilation can be used to release hot air from inside the building that has accumulated in buildings a business district during the hot summer season.

3. Office equipment room cooling

During cold season, fresh air can be drawn in and used as is to cool rooms where the temperature has risen due to the use of office equipment.

⚠ In the case of "By-pass" ventilation, the supply air temperature slightly rises more than the outside air temperature because of the heat effect around the ducts or the unit motors.

Maintenance

Remove all dust and dirt on air filters and Lossnay cores at regular intervals in order to prevent a deterioration in the Lossnay functions.

Guideline: Clean the air filters once a year.
(or when "FILTER" and "CLEANING" are indicated on the remote controller)

Clean the Lossnay cores once two year.
(Clean the Lossnay cores once a year If possible.)
(Frequency should be increased depending on the extent of dirt.)

Removing the parts

1) Maintenance cover

Locate and remove the cover fixing screw. Pull back the hinged clip. Open the door and lift off of the hinge brackets.

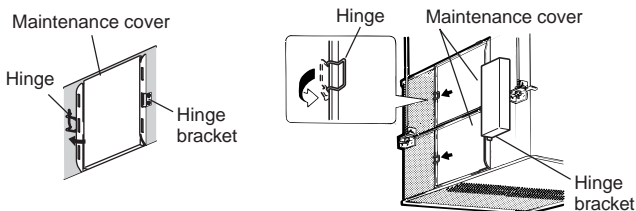

Models LGH-15 to 100RXs

Models LGH-150 and 200RXs

2) Lossnay cores

Take hold of the handle and draw the Lossnay cores out from the main unit.

Models LGH-15 to 100 RXs: 2 cores
Models LGH-150 and 200 RXs: 4 cores

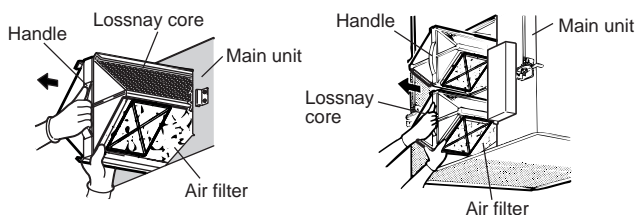

Models LGH-15 to 100RXs

Models LGH-150 and 200RXs

3) Air filters

After pulling out the Lossnay cores, undo filter guides, then remove the air filters, located at the bottom left and right of the Lossnay cores, as below.

Models LGH-15 to 100 RXs: 4 filters
Models LGH-150 and 200 RXs: 8 filters

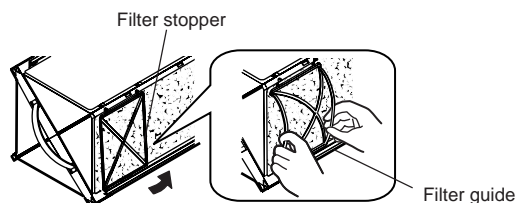

CAUTION

- Bow filter stoppers a little to remove them from filter guide.
- Take filter stoppers careful not to break them.

Cleaning the parts

1) Air filters

Use a vacuum cleaner to remove light dust. To remove stubborn dirt wash in a mild solution of detergent and lukewarm water. (under 40°C)

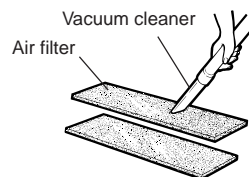

CAUTION

- Never wash the filters in very hot water and never wash them by rubbing them.
- Do not dry the filters by exposing them to a flame.

2) Lossnay cores

Use a vacuum cleaner to suck up the dust and dirt on the exposed surfaces of the Lossnay cores.
Use a soft brush only to clean exposed surface areas.

Do NOT wash in water.

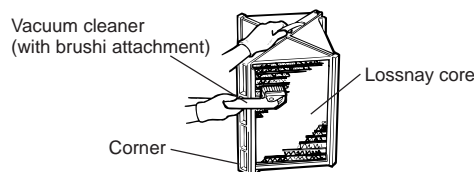

CAUTION

- Do not use the hard nozzle of the vacuum cleaner. It may damage the exposed surfaces of the Lossnay cores.
- Under no circumstances should the Lossnay cores be washed in water.

Assembly after maintenance

Bearing in mind the following points, assemble the parts following the sequence for their removal in reverse.

- Arrange the Lossnay core with the air filter side as shown in the name plate on the Lossnay unit.
- The filter for LGH-35RXs has front and back side. Set the "FRONT" (printed) side of the filter on the outer side.

Note

- If "FILTER" and "CLEANING" are indicated on the remote controller, turn off the indication after maintenance.

Specifications

Voltage (V) : 1-Phase 220 - 240

Model name	Line frequency (Hz)	Current (A)	Power consumption (W)	Air volume		Static pressure		Exchange efficiency (%)			Noise (dB(A)) Below the unit	Weight (kg)
				(m ³ /h)	(L/S)	(mmH ₂ O)	(Pa)	Temperature	Enthalpy			
									Heating	Cooling		
LGH-15RX ₅	50	0.37-0.38	80-90	150	42	6.6-7.1	65-70	82	75	73	26.5-27	20
LGH-25RX ₅	50	0.47-0.48	102-114	250	69	5.1-6.1	50-60	79	69.5	68	25-26	20
LGH-35RX ₅	50	0.74-0.74	160-169	350	97	7.6-8.2	75-80	80	71.5	71	28.5-29.5	29
LGH-50RX ₅	50	1.0-1.0	207-228	500	139	6.6-9.2	65-90	78	69	66.5	30.5-32	32
LGH-65RX ₅	50	1.5-1.5	308-322	650	181	6.1-8.2	60-80	77	68.5	66	32-33	40
LGH-80RX ₅	50	1.6-1.6	345-370	800	222	10.7-12.2	105-120	79	71	70	32-33	53
LGH-100RX ₅	50	2.1-2.1	445-475	1000	278	10.2-11.2	100-110	80	72.5	71	34-35	59
LGH-150RX ₅	50	3.2-3.2	690-740	1500	417	13.3-13.8	130-135	80	72	70.5	36-37.5	105
LGH-200RX ₅	50	4.2-4.2	910-980	2000	556	10.2-10.7	100-105	80	72.5	71	37-38	118

(1mmH₂O = 9.80665Pa)

- * The above values apply during Lossnay ventilation when the fan speed is set to high speed.
- * The values given in the table for the noise level reflect the levels measured at a position 1.5 meters immediately below the unit in an anechoic chamber.
- * Noise change or increase may occur because of the Bypass-Automatic function or Automatic fan speed change by timer setting.
- * Temperature Exchange efficiency (%) are based on winter condition.

After-sales servicing

Consult with your dealer about the after-sales services provided for this Lossnay product.

If you hear strange sounds, if no air is blown out or if some other trouble occurs, switch off the power and contact your dealer. Consult with your dealer concerning the cost of inspection or repair work.