

Models:

**LGH-15RX<sub>3</sub>-E,**

**LGH-25RX<sub>3</sub>-E,**

**LGH-35RX<sub>3</sub>-E**

**LGH-50RX<sub>3</sub>-E,**

**LGH-80RX<sub>3</sub>-E,**

**LGH-100RX<sub>3</sub>-E**

**LGH-100RX<sub>3</sub>-E-60, LGH-150RX<sub>3</sub>-E**

**LGH-200RX<sub>3</sub>-E, LGH-200RX<sub>3</sub>-E-60**

# Installation Instructions (For use by dealer/contractor)

Models LGH-15RX<sub>3</sub>-E to LGH-100RX<sub>3</sub>-E

Models LGH-150RX<sub>3</sub>-E and LGH-200RX<sub>3</sub>-E

## Contents

Safety precautions .....	1
Outline drawings .....	2
Standard installation examples ...	3
Installation method .....	3
Function settings .....	10
Trial operation .....	11

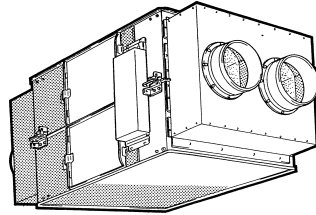
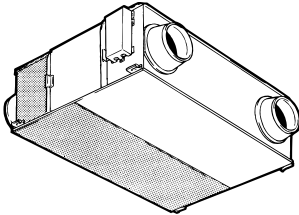

Please take the time to read through these instructions before commencing with the installation work. They will help to install the Lossnay properly and safely.

**The separate Operating Instructions are for the user. Make sure that they are handed over to the customer.**

## Safety precautions

### ⚠ WARNING



No disassembly

- This product must not be disassembled under any circumstances. Only authorized repair technicians are qualified to conduct disassembly and repairs. (Failure to heed this warning may result in fire, electrical shock or injury.)



Prohibited

- Do not install this product in a refrigerated warehouse, heated swimming pool or other location where the temperature and humidity are significantly different. (Failure to heed this warning may result in electrical shock or malfunctioning.)
- Do not install this product where it will be directly exposed to the rain. (Failure to heed this warning may result in electrical shock or malfunctioning.)
- Do not install this product in a location where acid, alkali or organic solvent vapors, paints or other toxic gases, gases containing corrosive components or high concentrations of oily smoke are present. (Failure to heed this warning may result not only in malfunctioning but also fire, power leakage and electrical shock.)
- Do not use this product outside the range of its rated voltage and control capacity.  
LGH-15 to 80 and 150 RX<sub>3</sub> :  
Single phase, 220-240V 50 Hz 220V 60Hz  
LGH-100 and 200 RX<sub>3</sub> :  
Single phase, 220-240V 50 Hz  
LGH-100 and 200 RX<sub>3</sub> :  
Single phase, 220V 60 Hz (60Hz : Invalid in EU)  
(Failure to heed this warning may result in fire or electrical shock.)



Instructions must be followed

- Install this product in an environment where the temperature ranges from -10°C to +40°C and the relative humidity is less than 80%. If condensation is expected to form, heat up the fresh outside air using a duct heater, etc.



Connect the grounding wire.



- Install this product in an environment where the outside air intake meets the following conditions: temperature range is between -15°C and +40°C and the relative humidity is 80% or less.
- Select a position for introducing the outside air where no exhaust or combustion gases will be sucked into the product and where it will not be covered by snow. (Failure to ensure a supply of fresh air can result in producing a state of oxygen deficiency inside the room.)
- Select an adequately sturdy position for installing the product and install it properly and securely. (Injury may result if the product should fall.)
- Use the designated electrical wires for the terminal board connections, and connect the wires securely so that they will not become disconnected. (Failure to ensure proper connections may result in fire.)
- When passing metal ducts through wooden buildings clad with metal laths, wire laths or metal, these ducts must be installed in such a way that they will not make electrical contact with the metal laths, wire laths or metal sheets. (Power leakage can cause ignition.)
- The outside ducts must be tilted at a gradient (1/30 or more) down toward the outdoor area from Lossnay unit, and properly insulated. (The entry of rain water may cause power leaks, fire or damage to household property.)
- Gloves should be worn when doing the installation work. (Failure to heed this warning may result in injury.)
- A dedicated circuit breaker must be installed at the origin of mains power supply. This circuit breaker must be provided with a means for locking (lock and key).
- Connect the product properly to ground. (Malfunctioning or power leaks can cause electrical shock.)
- An isolator switch having a minimum contact gap of 3 mm in all poles must be provided as a means of disconnecting the power supply.

# Outline drawings

## LGH-15 to 100 RX<sub>3</sub>

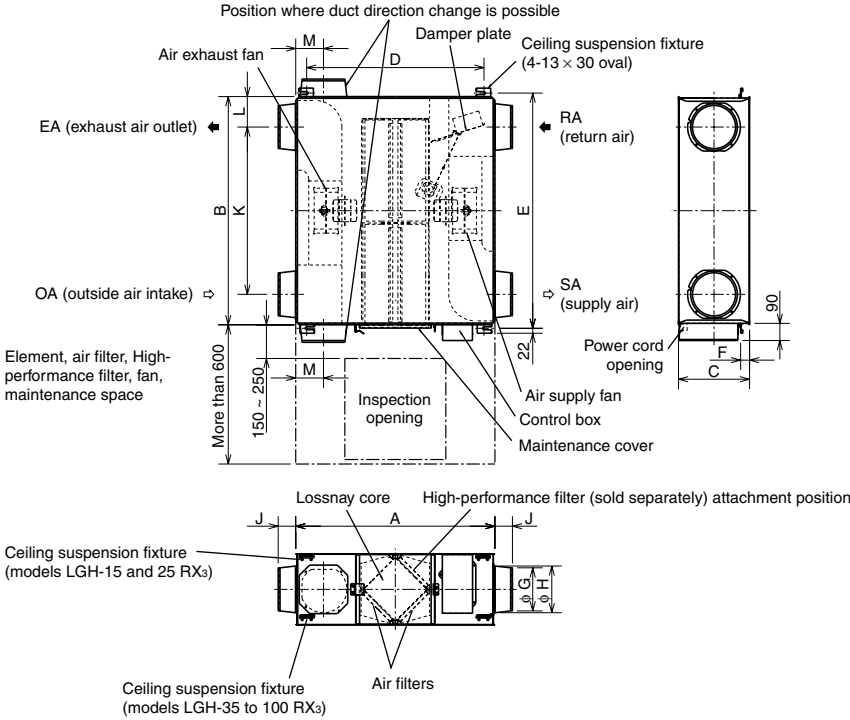

## Accessory parts

- Mounting screws ..... x18
- Duct connecting flanges ..... x4 (double flanges at SA and EA sides)
- Protective cover ..... x1 <For installing upside down>
- Slim-Lossnay connection cable (gray: two wires) ..... x1

Unit (mm)

Model	Dimensions			Ceiling suspension fixture pitch			Nominal diameter	Duct connecting flange			Duct pitch			Weight (kg)
	A	B	C	D	E	F		G	H	J	K	L	M	
LGH-15 RX <sub>3</sub>	780	610	275	700	641	10*	φ 100	97.5	110	54	450	80	119	17
LGH-25 RX <sub>3</sub>	780	735	275	700	765	10*	φ 150	142	160	63	530	102.5	102	21
LGH-35 RX <sub>3</sub>	888	874	317	790	906	40	φ 150	142	160	63	650	112	124	30
LGH-50 RX <sub>3</sub>	888	1016	317	790	1048	40	φ 200	192	208	79	745	135.5	124	33
LGH-80 RX <sub>3</sub>	1164	1004	398	1030	1036	10	φ 250	242	258	79	690	157	149	61
LGH-100 RX <sub>3</sub>	1164	1231	398	1030	1263	10	φ 250	242	258	79	920	155.5	149	72

\* Shows the distance from the ceiling.

## LGH-150 and 200 RX<sub>3</sub>

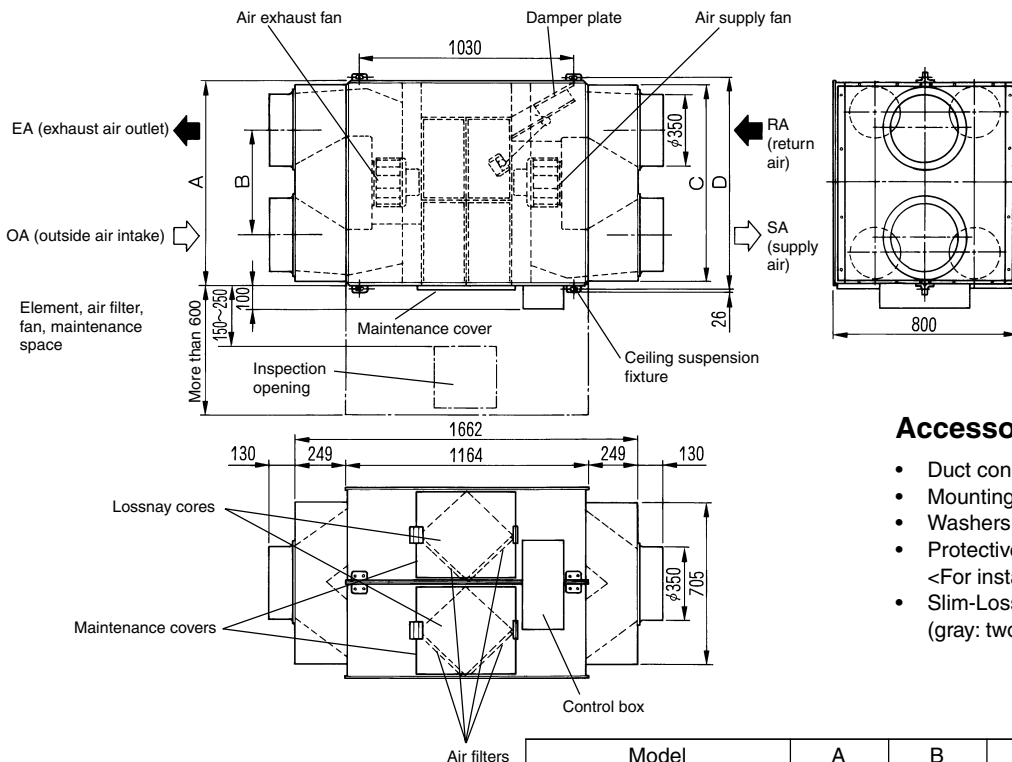

## Accessory parts

- Duct connecting flanges ..... x4
- Mounting screws ..... x34
- Washers ..... x32
- Protective cover ..... x1 <For installing upside down>
- Slim-Lossnay connection cable (gray: two wires) ..... x1

Unit (mm)

Model	A	B	C	D	Weight (kg)
LGH-150 RX <sub>3</sub>	1004	510	964	1046	154
LGH-200 RX <sub>3</sub>	1231	740	1194	1273	179

# Standard installation examples

- Duct length

Model	Distance
LGH-15 to 50 RX <sub>3</sub>	1 m or more
LGH-80 and 100 RX <sub>3</sub>	2.5 m or more
LGH-150 and 200 RX <sub>3</sub>	3 m or more

- **The parts can also be installed upside down.** Remove the maintenance cover, rotate the parts by 180°, and re-install.

- Use with the following static pressure

Model	Static pressure (Pa)
LGH-80 RX <sub>3</sub>	29 or more
LGH-100 RX <sub>3</sub>	49 or more
LGH-150 and 200 RX <sub>3</sub>	69 or more

- LGH-15 and LGH-25 RX<sub>3</sub> cannot be installed vertically.

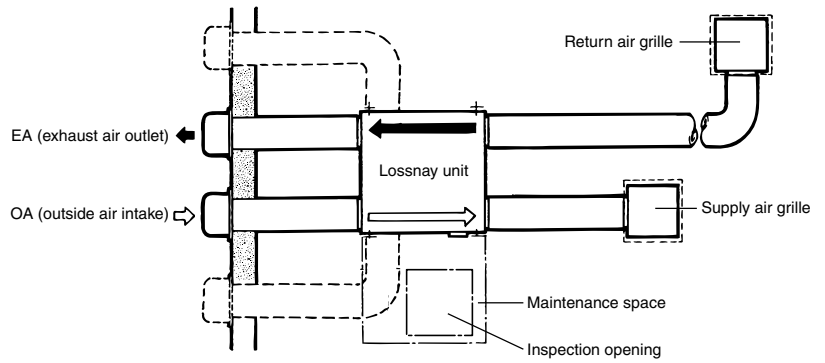
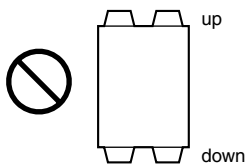

Downward gradient of duct: 1/30 or more (toward wall side) and provision of distance in table below (to prevent rain water from seeping in)

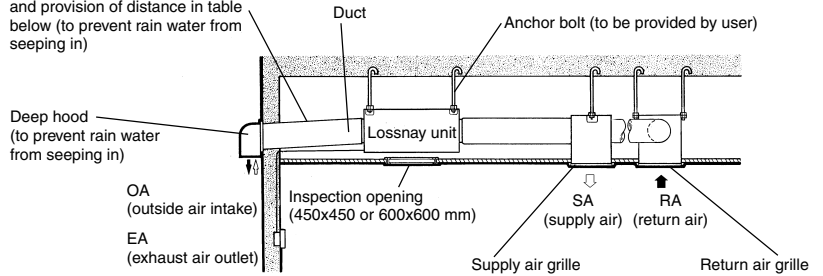

## Installation method

### Installing the Lossnay unit

#### 1. Preparing the anchor bolts

Mount the washers (outer diameter of >21 mm for M10, >24 mm for M12) and nuts onto the pre-recessed anchor bolts (M10 or M12), as shown in the figure below.

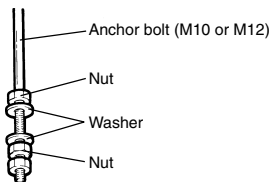

#### 2. Attaching the duct connecting flanges

Use the screws supplied to secure the duct connecting flanges to the Lossnay unit. For the models LGH-150 and 200 RX<sub>3</sub>, use screws and washers provided as well to secure the flanges.

##### Models LGH-15 to 100 RX<sub>3</sub>

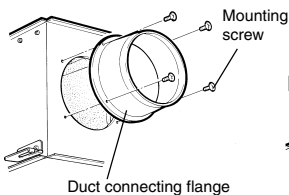

##### Models LGH-150 and 200 RX<sub>3</sub>

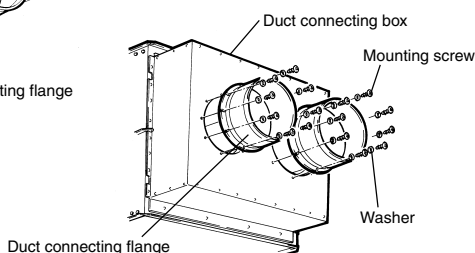

### CAUTION

- Before attaching the duct connecting flanges, check that no foreign matter (scraps of paper, vinyl, etc.) has found its way inside to Lossnay unit.
- Attach the duct connecting flanges with the packing at the SA and RA sides.

#### 3. Mounting Lossnay unit

- (1) Hang the ceiling suspension fixtures on the anchor bolts and adjust in such a way that Lossnay unit is level.
- (2) Tighten up securely using double nuts.

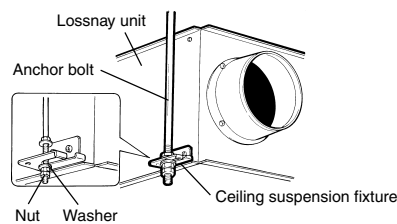

##### For the models LGH-150 and 200 RX<sub>3</sub>

Remove the packing box mounting plate if it should interfere with the installation work. Make sure that the screws which were removed are screwed back in their original positions in order to prevent air leaks.

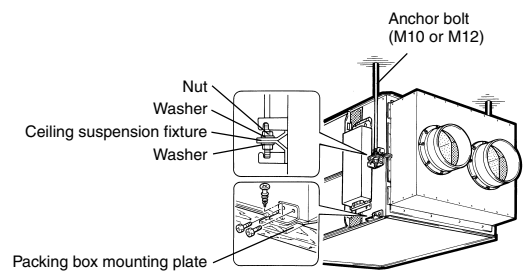

### CAUTION

- When suspending Lossnay unit from the ceiling, do not handle it in such a way that force will be applied to the control box.

# Installation method (continued)

## If the suspension bolts are short, change the mounting hardware.

### For the models LGH-35 and 50 RX<sub>3</sub>

- (1) Remove the hanger cover that is in the upper mounting position.
- (2) Remove the suspension fixture and retainer fixture and mount at the upper mounting position.
- (3) Mount the hanger cover to the holes of the suspension fixture that has been removed to prevent air leakage.

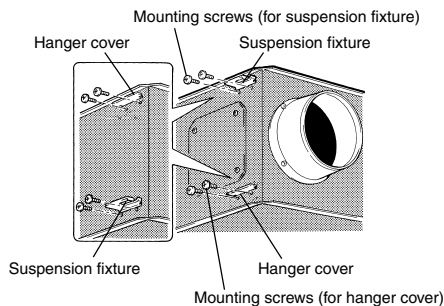

Models LGH-35 and 50 RX<sub>3</sub>

## CAUTION

- The screws for mounting the hanger cover and the suspension fixture are different. Use care not to use the wrong ones.

### For the models LGH-80 and 100 RX<sub>3</sub>

- (1) Remove the suspension fixture and mount it to the upper mounting position.
- (2) Replace screws in the holes for the suspension fixture that has been removed to prevent air leakage.

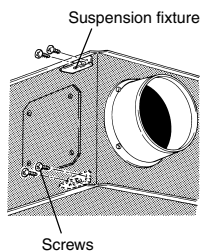

Models LGH-80 and 100 RX<sub>3</sub>

## 4. Connecting the ducts

- (1) Fasten the duct securely to the duct connecting flange, and wrap aluminum tape (available commercially) around the joints so that there is no air leakage.
- (2) Suspend the ducts from the ceiling so that their weight will not be applied to the Lossnay unit.
- (3) The two outdoor ducts must be covered with heat-insulating material in order to prevent condensation from forming.

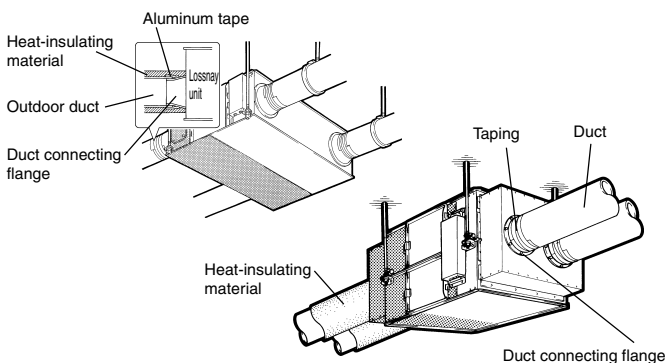

## CAUTION

- Before connecting the ducts, check that no debris or any other foreign matter (scraps of paper, vinyl, etc.) has found its way inside the ducts.
- Do not touch the damper plate inside Lossnay unit when connecting the ducts.

Do not carry out the following types of duct construction. (Doing so could cause a drop in the air volume and generate abnormal noises.)

- Extremely sharp bends
- Multiple bends
- Bends right next to the outlet
- Extreme reduction in the diameter of the connected ducts

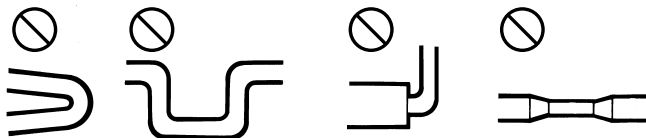

## 5. When changing the direction of the out door side duct (EA/OA)....Except on LGH-150 and 200 RX<sub>3</sub>

### Remove the flange cover, hanger cover and suspension fixture.

- (1) Remove the four mounting screws for the flange cover and remove the flange cover.
  - For the LGH-15 RX<sub>3</sub>, two of mounting screws shown in the drawing below are tightened together with the main body. Tighten to the main body after removing the flange cover.
- (2) On the LGH-35 to 100 RX<sub>3</sub>, remove the two mounting screws for the hanger cover suspension fixture and remove the hanger cover, suspension fixture and retainer (35 and 50 RX<sub>3</sub> only).
  - Do not remove on the LGH-15 and 25 RX<sub>3</sub>.

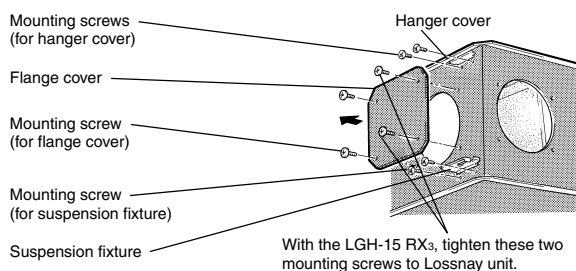

### Mounting the duct connection flange

- (1) Use the mounting screws provided to mount the duct connection flange to the main body.
- (2) Use the four mounting screws that were removed to attach the flange cover.
  - On the LGH-15 RX<sub>3</sub>, there are two mounting screws mounted to the main body (as shown in the drawing on the bottom). Remove these two mounting screws and use them for mounting the flange cover.
- (3) On the LGH-35 to 100 RX<sub>3</sub>, change the suspension fixture and retainer (35 and 50 RX<sub>3</sub> only) to the top position and the hanger cover to the lower position.

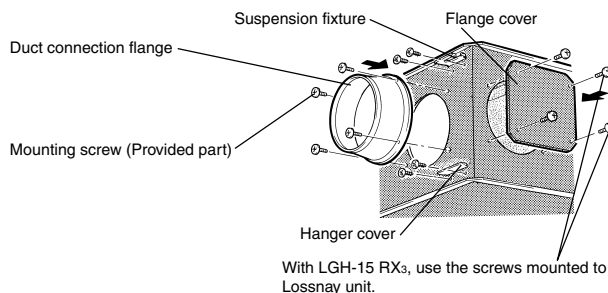

## CAUTION

- The screws for mounting the hanger cover and the suspension fixture are different. Use care not to use the wrong ones.

# Installation method (continued)

## Electrical installation

With this product, the wiring installation method will vary according to the design of the system. Perform electrical installation for each of the required sections.

### Names of components in control box

#### LGH-15 to LGH-100 RX<sub>3</sub>

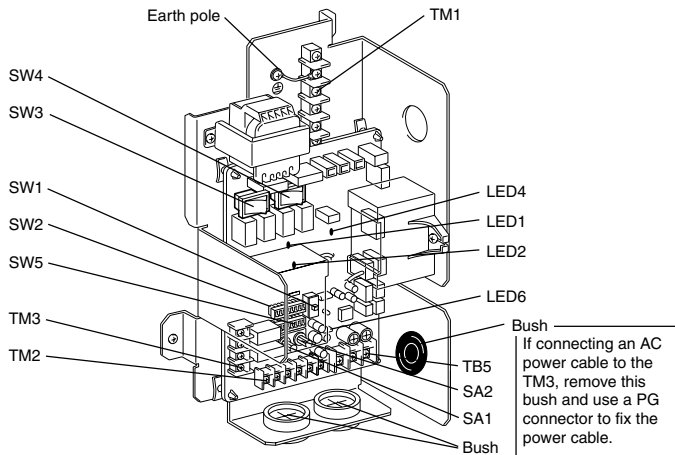

#### LGH-150 and LGH-200 RX<sub>3</sub>

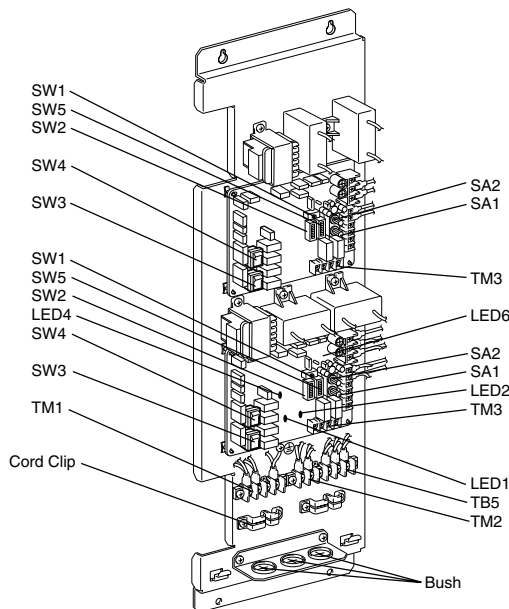

### Wire connection diagram ----- Models LGH-15 to 100 RX<sub>3</sub>

- \* Connect the wires shown as dotted lines.
- \* Be sure to connect the grounding wire.
- \* Breaker should be provided by the customer.

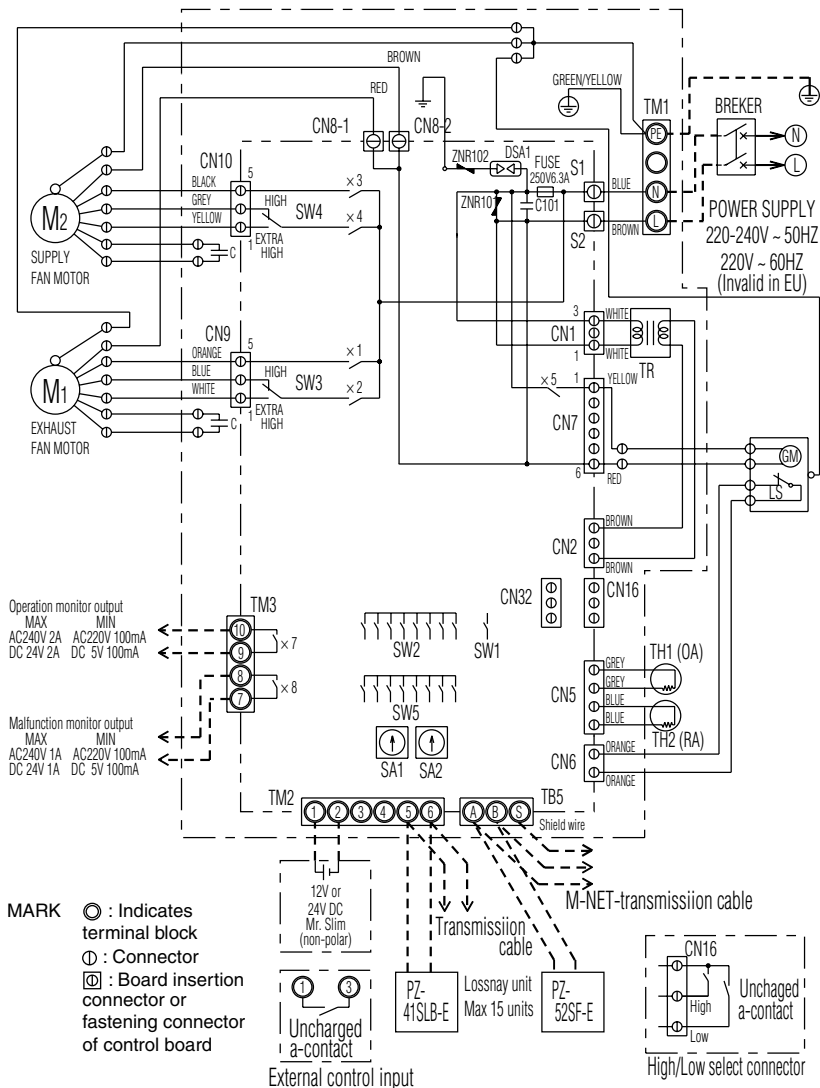

**MARK** ● : Indicates terminal block  
 ⊕ : Connector  
 ⊞ : Board insertion connector or fastening connector of control board

Symbol explanation			
M1:	Motor for exhaust fan	X8:	Relay contact (For malfunction monitor output)
M2:	Motor for supply fan	CN1:	Connector (Transformer primary)
C:	Capacitor	CN2:	Connector (Transformer secondary)
GM:	Motor for Bypass movement	CN5:	Connector (Thermistor)
LS:	Microswitch	CN6:	Connector (Microswitch)
TH1:	Thermistor for outside air	CN7:	Connector (Motor for bypass operation)
TH2:	Thermistor for return air	CN8-1:	Tab connector (Fan motor)
SW1:	Switch (Main/sub change)	CN8-2:	Tab connector (Fan motor)
SW2,5:	Switch (Function selection)	CN9:	Connector (Fan motor)
SW3:	High/E.High select switch (Exhaust fan)	CN10:	Connector (Fan motor)
SW4:	High/E.High select switch (Supply fan)	CN16:	Connector (High/Low switch)
TM1:	Terminal block (Power supply)	CN32:	Connector (Remote control selection)
TM2:	Terminal block (Transmission cable and external control input)	SA1:	Address setting rotary switch (10 digit)
TM3:	Terminal block (Monitor output)	SA2:	Address setting rotary switch (1 digit)
TB5:	Terminal block (M-NET Transmission cable)	LED1:	Inspection indicator lamp
S1,S2:	Connector (Power supply)	LED2:	Inspection indicator lamp
TR:	Control circuit transformer	LED4:	Power supply indicator lamp
X7:	Relay contact (For operation monitor output)	LED6:	M-NET indicator lamp

- PZ-41SLB-E and PZ-52SF-E cannot be used simultaneously.

# Installation method (continued)

## Wire connection diagram ---- Models LGH-150 and 200 RX3

- \* Connect the wires shown as dotted lines.
- \* Be sure to connect the grounding wire.
- \* Breaker should be provided by the customer.

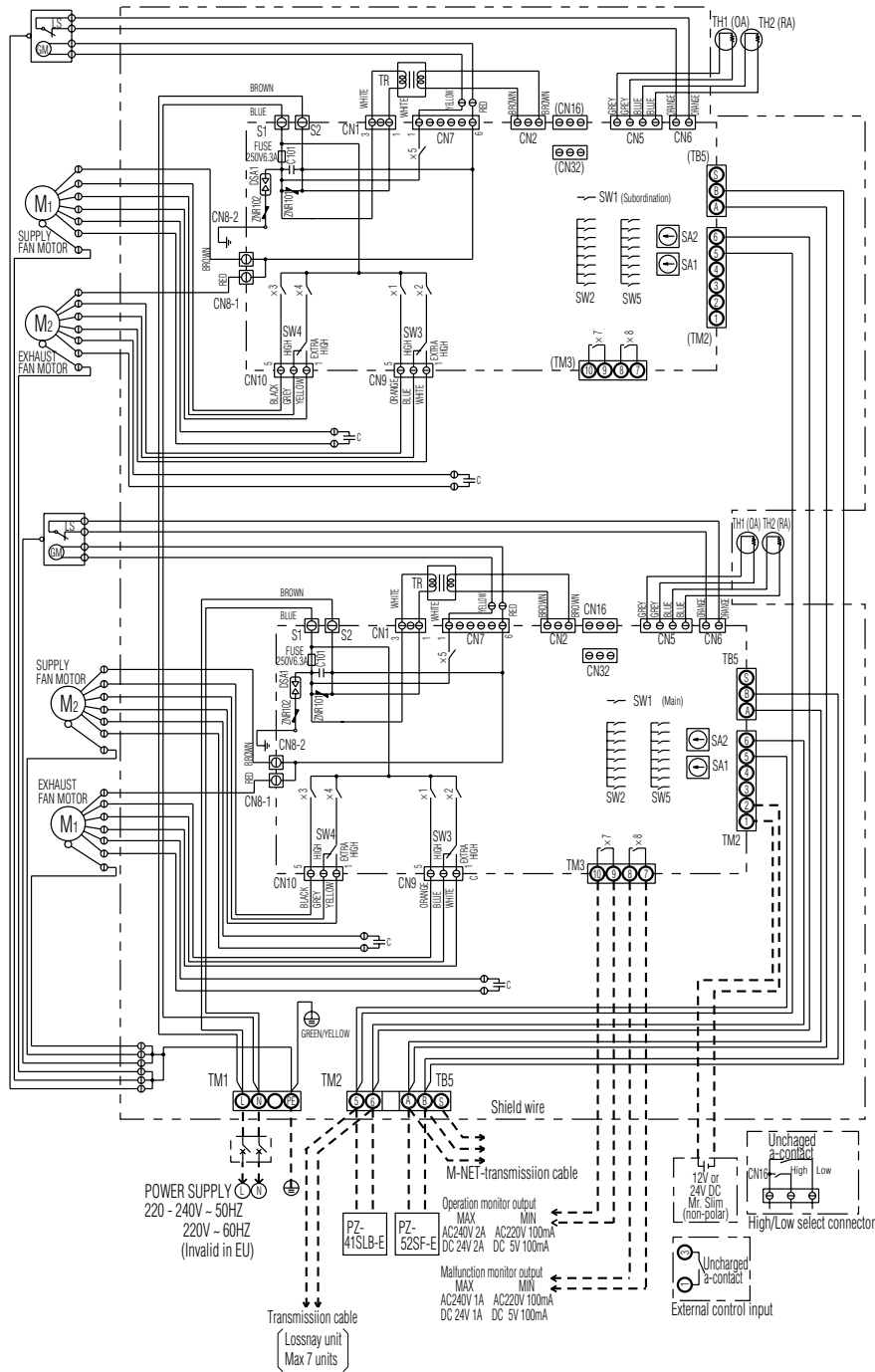

### Symbol explanation

M1: Motor for exhaust fan	TM1: Terminal block (Power supply)	X8: Relay contact (For malfunction monitor output)	CN10: Connector (Fan motor)
M2: Motor for supply fan	TM2: Terminal block (Transmission cable and external control input)	CN1: Connector (Transformer primary)	CN16: Connector (High/Low switch)
C: Capacitor	TM3: Terminal block (Monitor output)	CN2: Connector (Transformer secondary)	CN32: Connector (Remote control selection)
GM: Motor for Bypass movement	TB5: Terminal block (M-NET Transmission cable)	CN5: Connector (Thermistor)	SA1: Address setting rotary switch (10 digit)
LS: Microswitch	S1,S2: Connector (Power supply)	CN6: Connector (Microswitch)	SA2: Address setting rotary switch (1 digit)
TH1: Thermistor for outside air	TR: Control circuit transformer	CN7: Connector (Motor for bypass operation)	MARK ○ : Indicates terminal block
TH2: Thermistor for return air	X7: Relay contact (For operation monitor output)	CN8-1: Tab connector (Fan motor)	⊞ : Connector
SW1: Switch(Main/sub change)		CN8-2: Tab connector (Fan motor)	⊞ : Board insertion connector or fastening connector of control board
SW2,5: Switch (Function selection)		CN9: Connector (Fan motor)	
SW3: High/E.High select switch (Exhaust fan)			
SW4: High/E.High select switch (Supply fan)			

- PZ-41SLB-E and PZ-52SF-E cannot be used simultaneously.

# Installation method (continued)

## Connecting the power supply cable

### 1. Remove the screws and open the control box cover

LGH-15 to 100 RX<sub>3</sub>

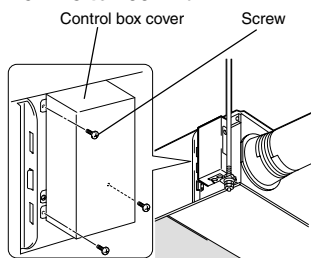

LGH-150 and 200 RX<sub>3</sub>

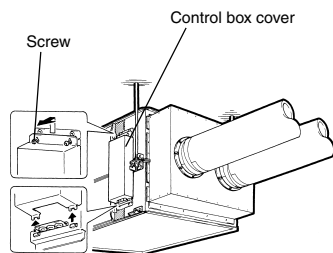

### 2. Connecting the power supply cable and transmission cable

Pass the power cable through the bush\* and connect to the TM1 terminal block using the round terminals. Connect the grounding wire to the grounding terminal and secure tightening the bush. (\*: for PG connection or the like)

LGH-15 to 100 RX<sub>3</sub>

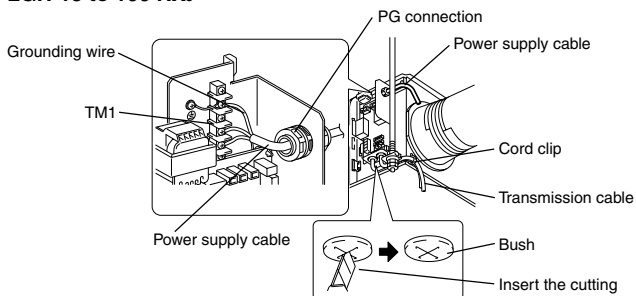

LGH-150 and 200 RX<sub>3</sub>

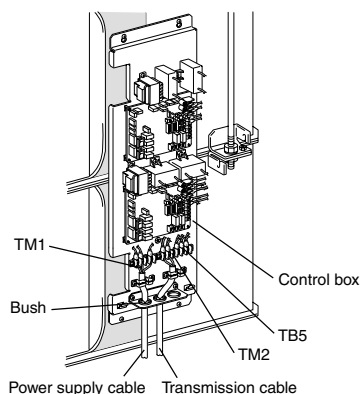

#### CAUTION

- Always separate the power supply cable and transmission cable by 5 cm or more to prevent malfunctioning of the unit.
- If the length of the stripped power cables wires is too long, the conductors may touch and cause shorting.

- (1) Refer to the wiring diagram and screw down the grounding wire and transmission cables to the terminal block.
- (2) Secure the power supply cable and transmission cables using the cord clamp.

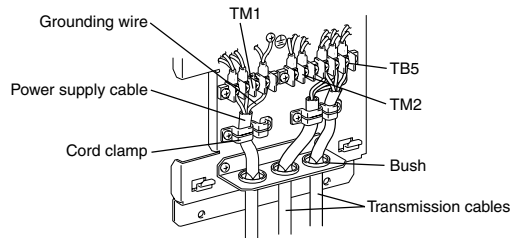

Upon completion of the wiring connections, replace the control box cover.

### 3. When installing upside down

LGH-15 to 100 RX<sub>3</sub>

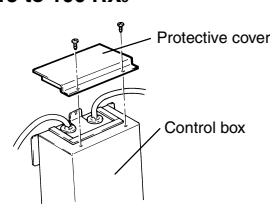

<When installing upside down>

LGH-150 and 200 RX<sub>3</sub>

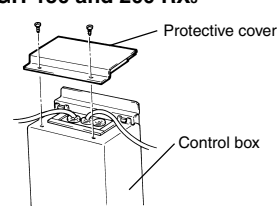

<When installing upside down>

#### CAUTION

- If installing and using this product upside down, the power supply cable outlet will be at the top. Be sure to attach the protective cover so that no drops of water can get inside the control box.

### 4. Changing the switch for High and Extra High

To increase the air volume, change the switch from "high" to "extra high".

- The factory setting is "High".
- Can be switched for each supply and exhaust separately.

LGH-15 to 100 RX<sub>3</sub>

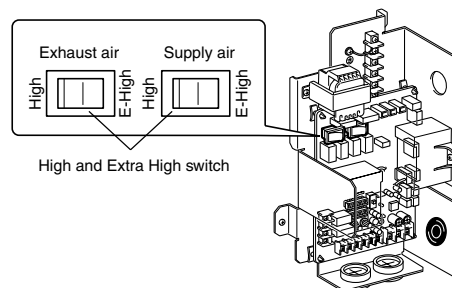

LGH-150 and 200 RX<sub>3</sub>

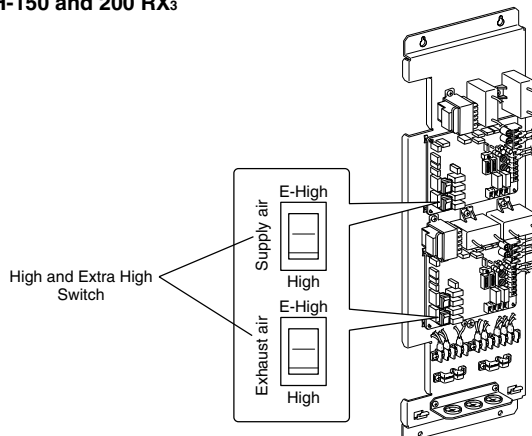

# Installation method (continued)

The following system configuration can be created. Connect the necessary parts.

1. When connecting with remote controller (PZ-41SLB-E).
2. When interlocking with air conditioner or other external device.
3. When interlocking with a pulse output device.
4. When operating multiple Lossnay units.
5. When connecting to CO<sub>2</sub> sensor when switching the high-low switch externally.
6. When connecting to City Multi, Lossnay remote controller (PZ-52SF-E) or Mitsubishi Electric Air-Conditioner Network System (MELANS).

## 1. When connecting to remote controller (PZ-41SLB-E)

\* The PZ-41SLB-E cannot be used when centralized control of the Lossnay is used. Then follow the procedure for connecting the wire shown in 6. and use the Lossnay remote controller (PZ-52SF-E).

Securely connect the transmission cable (PVC insulated PVC jacketed and either between  $\phi$  0.65 and  $\phi$  1.2, or between 0.3 mm<sup>2</sup> and 1.25 mm<sup>2</sup> in cross section) from the remote controller to 5 and 6 of the input terminal block (TM2). (No polarity)

- If there are two remote controllers, connect them in the same way.

### Note

- Up to four 0.3 mm<sup>2</sup> stranded wires or  $\phi$  0.65 PVC wires can be connected to one input terminal.
- For other types of wire up to two can be connected.

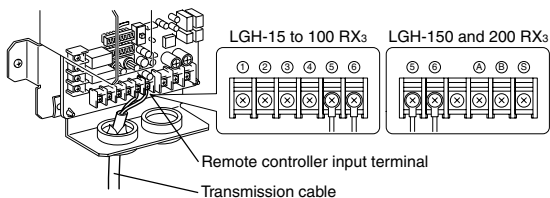
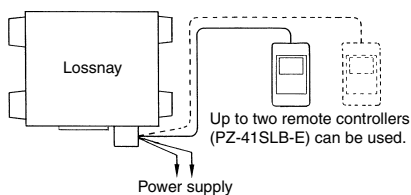

## 2. When interlocked with air conditioner or other external device

(1) Connect the output signal cable from the external device to the input terminal block (TM2) of the external controller.

- LGH-150 and 200 RX<sub>3</sub> are connected to the lower circuit board. (Main circuit board)

### CAUTION

- The connection may vary according to the output signal type of the external unit.

(2) Confirm that the pulse input switch (SW2-2) is set to "OFF". (Set to "OFF" at time of shipment.)

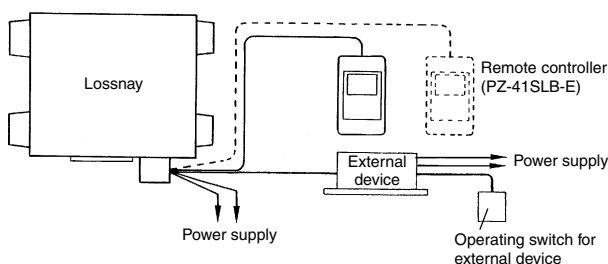

When using Mitsubishi Mr. Slim air conditioner and (A control or K control) Interlock operation of except Mr. Slim (A control or K control) unit is not possible.

Connect the interlocking cable connector side to CN2L on the circuit board for the indoor Mr. Slim unit and connect the lead wire side to the ① and ② of the input terminal block (TM2) for the Lossnay external controller input. (No polarity)

- Always separate the power supply cable and the Slim-Lossnay connection cable for the Lossnay by 5 cm or more to prevent malfunctioning of the unit.
- The Slim-Lossnay connection cable is 0.25 m long. When wiring, extend it as far as necessary.

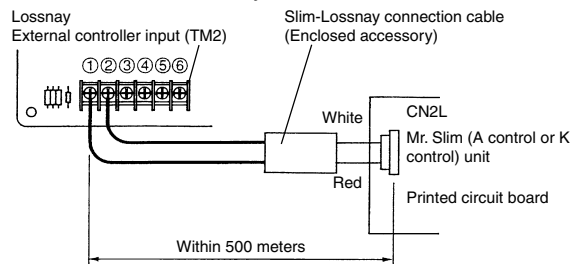

### Note

- The Lossnay remote controller (PZ-41SLB-E) cannot be used with this system.
- The ventilation mode is "automatic ventilation".
- The Slim-Lossnay connection cable may be extended to a maximum length of 500m (Extension cable specifications are as detailed below). Ensure that all connections are secure and that the appropriate insulation is provided. Extension cable sheathed PVC cable or cable-0.5 mm<sup>2</sup> to 1.0 mm<sup>2</sup>.

When the external device has a charged operating signal of 12V DC or 24 VDC

- Connect the operating signal (wire) from the external device via the remote output retrieval component (sold separately) to ① and ② on the external control input terminal block (TM2). (No polarity)

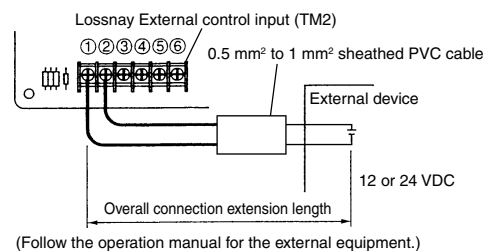

When the external device has an uncharged a-contact signal

- Connect the operating signal (wire) from the external device via the remote output retrieval component (sold separately) to ① and ③ on the external control input terminal block (TM2).

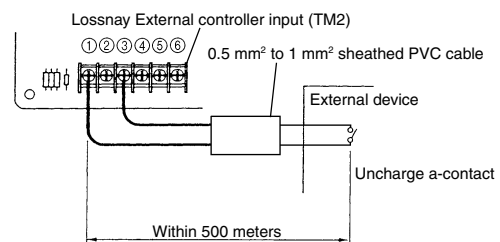

### CAUTION

- If an optocoupler or any other type of polar coupler is used at the uncharged a-contact, connect the positive side to ③ and the negative side to ①.



# Installation method (continued)

## 3. When interlocking with a pulse output device

- Move the pulse input switch [SW2-2] to the ON position. On the LGH-150 and 200 RX<sub>3</sub>, set both the upper and lower circuit boards the same.
- Connect the pulse output device (i.e., building management system) to the external control input terminal block [TM2]. The LGH-150 and 200 RX<sub>3</sub> connected to the lower circuit board. (Main circuit board)
  - A pulse width of at least 200 msec will be needed.
- Wiring is to be performed in the same way as for item 2 above.

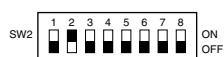

## 4. When operating multiple Lossnay units

- Connect from Lossnay Unit 1 to Lossnay Unit 2, and from Unit 2 to Unit 3 and so on up to a maximum of 15 units (7 units for types 150 and 200) using a transmission cable (PVC insulated PVC jacketed and either between  $\phi$  0.65 and  $\phi$  1.2, or between 0.3 mm<sup>2</sup> and 1.25 mm<sup>2</sup> in cross section).
- Change the setting on the main/sub switch (SW1) on the second and subsequent Lossnay units to "sub".

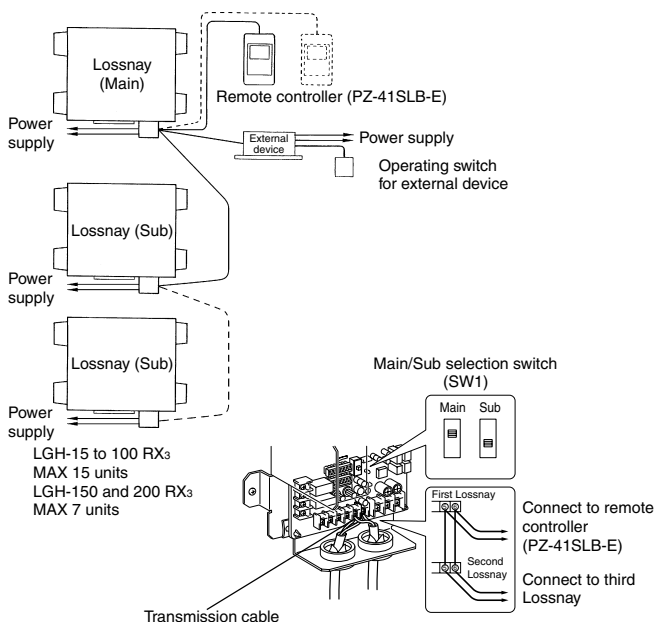

(The upper control circuit for LGH-150 and 200 RX<sub>3</sub> is normally set to "Sub".)

### NOTE

- Up to four 0.3 mm<sup>2</sup> stranded wires or  $\phi$  0.65 PVC wires can be connected to one input terminal.
- For other types of wire up to two can be connected.
- The operation signal and pulse signal can be connected to the external device of the main Lossnay only.
- Connect the power to each respective Lossnay unit.

## 5. When switching high/low speed externally (when CO<sub>2</sub> sensor or other device is connected)

If a commercially available CO<sub>2</sub> sensor or other such device is used as shown in the drawing, connect by inserting Remote ON/OFF Adaptor (PAC-SE55RA-E) (sold separately) to the CN16 connector (for switching between high/low).

- The LGH-150 and 200 RX<sub>3</sub> are connected to the lower circuit board. (Main circuit board)
- Note that if the remote controller is connected to a CO<sub>2</sub> sensor, the actual high and low fan speeds may not match on the remote controller.

### ■ To force high speed externally

When external switch is "on" fan speed of the Lossnay will be set to "high". Regardless of the remote control setting.

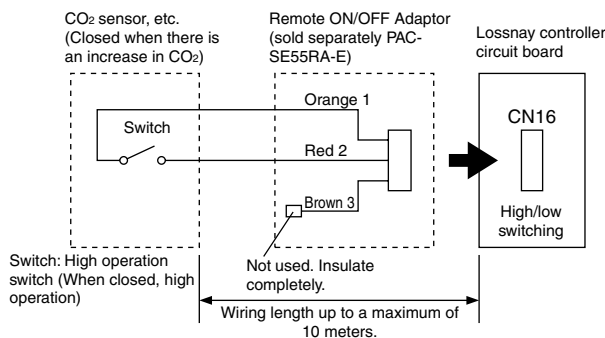

### ■ To force low speed externally

When external switch is "on" fan speed of the Lossnay will be set to "low". Regardless of the remote control setting.

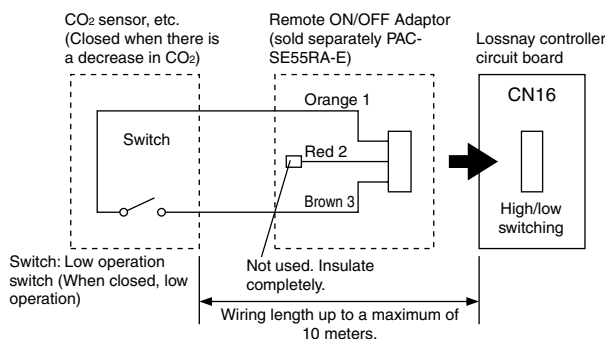

## 6. When connecting to the City Multi, Lossnay remote controller (PZ-52SF-E) or Mitsubishi Electric Air-Conditioner Network System (MELANS)

\* If centralized control is performed according the wire connection shown in this section, the remote controller (PZ-41SLB-E) cannot be used.

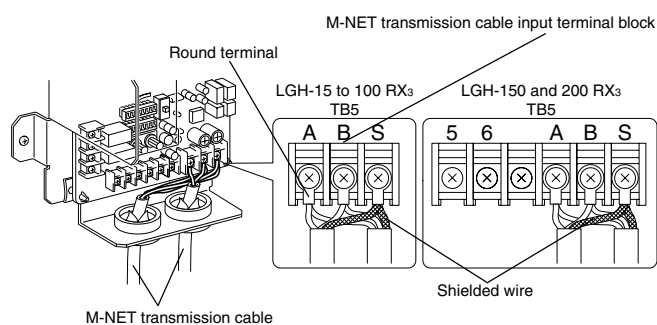

- One shielded wire is connected to the other shielded wire. (Terminal connection)
- Address setting is required. (Refer to function setting section.)
- M-NET transmission cable: Connect any of the following -- City Multi indoor unit, Lossnay remote controller (PZ-52SF-E) or Mitsubishi Electric Air-Conditioner Network System (MELANS) - to the Lossnay.
- Type: (Shielded wire, CVVS/CPEVS)
- Wire diameter: 1.25 mm<sup>2</sup> to 2.0 mm<sup>2</sup>
- Securely connect the M-NET transmission cable to ① and ② on the transmission cable input terminal block (TB5). (No-Polar)

# Installation method (continued)

## When interlocking with the City Multi

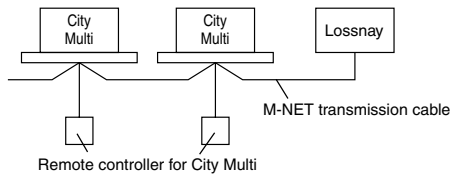

\* Keep the overall length of the transmission cable within 500 meters. Note that the wiring length between the Lossnay and power supply unit (sold separately) or outdoor unit should be 200 meters or less.

## Lossnay remote controller (PZ-52SF-E) or MELANS

- Connect the power supply unit (PAC-SC34 KUA)

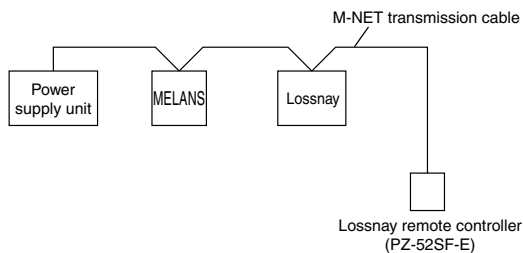

## ■ To use the power supply unit

Install the power supply unit on the control panel box as follows.

- (1) Screw the M4 SCREWS into the control panel box enough to keep them from falling out of place. Set them towards the top of the box.
- (2) Hang the power supply unit (from the top end) on the M4 screws.
- (3) Lock the bottom end down with the M4 SCREW.
- (4) Tighten the top end screw securely.
- (5) Once installed, close the control panel box door for safety reasons and lock with the key or screw.

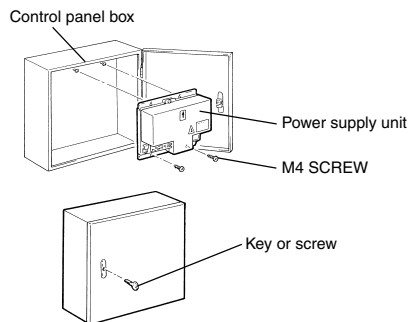

For more information, see the installation manual of the power supply unit.

# Function settings

You must set the address when connecting to the City Multi, Lossnay remote controller (PZ-52SF-E) and MELANS.

## Setting the address

Use the following procedure when performing the address setting for dedicated Lossnay.

(The method to be employed in the determination of addresses will be dependent on the existing system. Refer to the appropriate technical documents for details.)

- (1) Remove the control box cover.
  - (2) Use a straight-blade screwdriver to turn the address setting switch on the circuit board.
- SA1 indicates the 10 digit and SA2 indicates the 1 digit.
  - The factory setting is "00"
  - On the LGH-150 and 200 RX<sub>3</sub>, each upper and lower circuit board has an address. The lower circuit board takes the smaller number and the upper board takes the larger number.

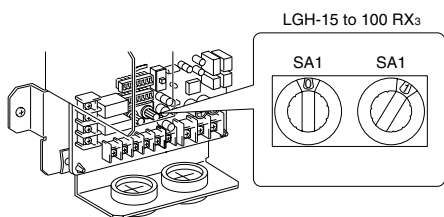

\* When the address number has been changed, the data in the memory is automatically reset.

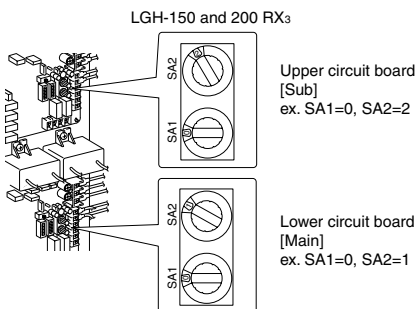

## Switching function selection switches (SW-2 and 5)

Perform the necessary function settings using the function selection switches (SW-2 and 5).

- The setting can be changed at any time.
- On the LGH-150 and 200 RX<sub>3</sub>, set both the upper and lower circuit boards the same.

### 1. Settings for pulse input

Set as shown when connecting the pulse signal equipment from a building maintenance system to an external input.

	OFF	ON	Mode
SW2	2	<input type="checkbox"/>	No pulse input (factory setting)
	2	<input checked="" type="checkbox"/>	Pulse input

### 2. Setting for selection of fan speed method

Set when operation is fixed at high speed or low speed operation. There are three modes that can be set.

	OFF	ON	Mode	Operation
SW2	4	<input type="checkbox"/>	Normal (Factory setting)	Switches high/low by operation of the fan speed from remote control.
	5	<input checked="" type="checkbox"/>		
	4	<input checked="" type="checkbox"/>	Fixed at high mode	Normally operated at high speed.
SW2	4	<input type="checkbox"/>	Fixed at low mode	Normally operated at low speed.
	5	<input checked="" type="checkbox"/>		

### 3. Power supply start/stop function (cannot be set when PZ-41SLB-E is used)

Set can be switch when operation and stopping is performed by turning the power supply (220-240 V) for the Lossnay on and off.

	OFF	ON	Mode	Operation
SW2	6	<input type="checkbox"/>	Off (factory setting)	Stopping and operation is performed according to settings of SW5-4 when the power is on.
	6	<input checked="" type="checkbox"/>	On	Operation possible by turning power on and off.

## Function settings (continued)

### 4. Settings for delay (of operation at start-up of heating or cooling)

This is the mode for delaying the operation of the Lossnay for 30 minutes when the City Multi or Mr. Slim is started and when an external device is started. (If the PZ-41SLB-E is used, set it at the remote control.)

	OFF	ON	Mode
SW5	<input checked="" type="checkbox"/>	<input type="checkbox"/>	No operation delay (factory setting)
	<input type="checkbox"/>	<input checked="" type="checkbox"/>	Operation delay of 30 minutes * This function is invalid with in 2 hours' restart

### 5. Supply air fan monitor

	OFF	ON	Mode
SW5	<input checked="" type="checkbox"/>	<input type="checkbox"/>	Corresponds to operation mode output (TM3 ⑨ ⑩) exhaust fan (factory setting)
	<input type="checkbox"/>	<input checked="" type="checkbox"/>	Corresponds to operation mode output (TM3 ⑨ ⑩) supply fan (The operation monitor output is off when the supply fan is stopped for operation in cold regions or during the City Multi or Mr. Slim defrosting.)

### 6. Stopping exhaust fan when defrosting air conditioner

Sets the operation of the exhaust fan (when the air supply fan is stopped) during defrosting of the air conditioner when Mr. Slim or City Multi indoor unit is connected to a duct.

	OFF	ON	Operation
SW5	<input checked="" type="checkbox"/>	<input type="checkbox"/>	Exhaust fan operation (factory setting)
	<input type="checkbox"/>	<input checked="" type="checkbox"/>	Exhaust fan stopped

### 7. Settings for automatic recovery following power supply interruption (cannot be set when PZ-41SLB-E is used)

Sets for automatic recovery following power supply interruption.

	OFF	ON	Mode	Operation
SW5	<input checked="" type="checkbox"/>	<input type="checkbox"/>	No automatic recovery (factory setting)	Stop after recovery
	<input type="checkbox"/>	<input checked="" type="checkbox"/>	Automatic recovery	Recover to operate in mode used before power outage

## Trial operation

After the overall system has been installed, before the ceiling panel is installed, make sure that no wires are wrongly connected, then carry out trial operation, referring to the user's manual for the remote controller.

### 1. Trial operation with the remote controllers (PZ-41SLB-E and PZ-52SF-E)

Follow the procedure shown in the operator's manual for the remote controller for confirming the following items.

- (1) Starting operation.
- (2) Fan speed selection.
- (3) Function selection.
- (4) Stopping operation.

### 8. Settings for filter cleaning

Set the time for filter cleaning based on the estimated concentration of dust in the air. The factory setting is unlimited. (If the PZ-41SLB-E is used, set it at the remote control.)

The four combinations of settings shown in the drawing to the bottom are available settings for filter cleaning.

	OFF	ON	Maintenance time
SW5	<input checked="" type="checkbox"/>	<input type="checkbox"/>	3000 hours
	<input type="checkbox"/>	<input checked="" type="checkbox"/>	1500 hours
	<input type="checkbox"/>	<input type="checkbox"/>	4500 hours
	<input type="checkbox"/>	<input checked="" type="checkbox"/>	Unlimited (No "FILTER" display on remote controller) (factory setting)

### ⚠ CAUTION

- When the setting for the cumulative operation time of the Lossnay is exceeded, the filter cleaning display will appear on the air conditioner remote controller or the remote controller for the Lossnay. After cleaning the filter, the filter cleaning display can be reset by following the procedure for canceling the cumulative operation time as shown in the manual.

### 9. Settings for interlock mode

These settings will indicate how the Lossnay should operate when external devices are started or stopped. (If the PZ-41SLB-E is used, set it at the remote control.)

	OFF	ON	Mode	Operation
SW5	<input checked="" type="checkbox"/>	<input type="checkbox"/>	On/Off interlock (Factory setting)	The Lossnay will start and stop in accordance with starting and stopping of the external devices. Subsequent operation will be possible using the remote controller for the Lossnay or MELANS.
	<input type="checkbox"/>	<input checked="" type="checkbox"/>	On interlock	The Lossnay will operate whenever the external devices are operated. Stopping of the Lossnay will be possible using its remote controller or MELANS.
	<input type="checkbox"/>	<input type="checkbox"/>	Off operation	The Lossnay will stop whenever the external devices are stopped. Starting of the Lossnay will be possible using its remote controller or MELANS.
	<input type="checkbox"/>	<input checked="" type="checkbox"/>	External input given priority	The Lossnay will start and stop in accordance with starting and stopping of the external devices. Control using the remote controller for the Lossnay or MELANS will only be possible when the external devices are stopped.

### 2. Lossnay independent trial operation

- (1) Remove the control box cover.
- (2) Turn the trial operation switch (SW2-1 and SW2-3) "On."
  - Operation will start with the "High" setting and with Bypass ventilation operating. (This will take approximately 45 seconds after the power is turned on.)
  - On the LGH-150 and 200 RX<sub>3</sub>, set both the upper and lower circuit boards the same.
- (3) Turn the trial operation switch (SW2-1 and SW2-3) "Off."
- (4) Install the cover in its original position on the control box.

	OFF	ON	Operation
SW2	<input type="checkbox"/>	<input checked="" type="checkbox"/>	Power will be supplied to the motor for the Lossnay fan and operation will be performed at the "High" setting.
	<input type="checkbox"/>	<input checked="" type="checkbox"/>	Power will be supplied to the motor for the Lossnay bypass and operation of the damper plate will be performed.

# Trial operation (continued)

## 3. Trial operation within the complete system

### ■ Interlock system containing an air conditioner and/or external device

- Use the remote controller for the air conditioner or the operating switches for the external device and confirm that the air conditioner and Lossnay are interlocked.
- If delay time has been set, check that the Lossnay operates after the delay time has passed.

### ■ If MELANS System

- Use MELANS to confirm the operation of the Lossnay.

## 4. If trouble occurs during trial operation

Symptom	Remedy												
Will not operate even when the operation switch for the remote controller (PZ-41SLB-E) and/or operation switch for the Lossnay remote controller (PZ-52SF-E) is pressed.	<ul style="list-style-type: none"> <li>• Check the power supply. (The specified power supply is single-phase 220-240V ~ 50Hz and 220V ~ 60Hz.)</li> <li>• Check for a short circuit or disconnection in the transmission cable. (Check that the voltage between terminals in the transmission cables is 9 to 15 VDC for the PZ-41SLB-E and 20 to 30 VDC for the PZ-52SF-E.)</li> <li>• Check that there is 5 cm or more separating the transmission cable from the power supply cable and any other transmission cables.</li> <li>• Run the Lossnay independently using the trial operation switch (SW2-1) and check if it runs. <table border="1" style="margin-left: 20px;"> <tr> <td>Lossnay runs</td> <td>→ Check the signal lines</td> </tr> <tr> <td>Lossnay doesn't run</td> <td>→ Check the power supply</td> </tr> </table> </li> <li>• Check if there are three or more remote controller connected (PZ-41SLB-E). (The maximum is two.)</li> </ul>	Lossnay runs	→ Check the signal lines	Lossnay doesn't run	→ Check the power supply								
Lossnay runs	→ Check the signal lines												
Lossnay doesn't run	→ Check the power supply												
"HO" flashes in remote controller for Lossnay (PZ-52SF-E).	<ul style="list-style-type: none"> <li>• Perform the registration operation using the remote controller for the Lossnay (PZ-52SF-E) or MELANS. (Refer to the installation instructions for the remote controller for the Lossnay or MELANS.)</li> </ul>												
Does not operate even when the operation switch for remote controller for Lossnay (PZ-52SF-E) or MELANS is pressed.	<ul style="list-style-type: none"> <li>• Check whether or not there is a power supply unit and that the power has been turned on. (On systems with only a Lossnay, a power supply unit is required.)</li> </ul>												
Air conditioner or external device does not interlock.	<ul style="list-style-type: none"> <li>• Check if the pulse input switch (SW2-2) is off.</li> <li>• Check the overall length between the air conditioner or external device and Lossnay. (Refer to technical publications or other such documents.)</li> <li>• Check the connections at the external control input terminal block (TM2). In the case of voltage charged 12 or 24 VDC output device: Connect to external control input terminals ① and ②. In the case of uncharged a-contact output device: Connect to external control input terminals ① and ③. In the case of Mr. Slim (A control or K control): Connect to external control input terminals ① and ②.</li> <li>• Perform the registration operation using the remote control for the air conditioner or MELANS. (Refer to the installation instructions for the remote control for the air conditioner or MELANS.)</li> <li>• Check if the delay has been set.</li> <li>• Check the overall length of the transmission cable between the external device and Lossnay. (Refer to technical publications or other such documents.)</li> <li>• Check if the transmission cable from the external device has come off of the external control input terminal. <table border="1" style="margin-left: 20px;"> <thead> <tr> <th></th> <th>Operation signal</th> <th>Stop signal</th> </tr> </thead> <tbody> <tr> <td>Charged 12 or 24 VDC output device</td> <td>12 or 24 VDC</td> <td>0 VDC</td> </tr> <tr> <td>Uncharged a-contact output device</td> <td>Resistance: 0 Ω</td> <td>Unlimited resistance Ω</td> </tr> <tr> <td>Mr. Slim (A control or K control)</td> <td>2 to 6 VDC</td> <td>2 to 6 VDC</td> </tr> </tbody> </table> </li> <li>• Check, in the case of multiple units, whether the Main/Sub selection switch on the Lossnay unit which is connected to the external control input terminal is set on the Master setting, and check whether the Main/Sub selection switch on other Lossnay units are set to Sub.</li> </ul>		Operation signal	Stop signal	Charged 12 or 24 VDC output device	12 or 24 VDC	0 VDC	Uncharged a-contact output device	Resistance: 0 Ω	Unlimited resistance Ω	Mr. Slim (A control or K control)	2 to 6 VDC	2 to 6 VDC
	Operation signal	Stop signal											
Charged 12 or 24 VDC output device	12 or 24 VDC	0 VDC											
Uncharged a-contact output device	Resistance: 0 Ω	Unlimited resistance Ω											
Mr. Slim (A control or K control)	2 to 6 VDC	2 to 6 VDC											
Lossnay does not stop.	<ul style="list-style-type: none"> <li>• Check that the trial operation switch (SW2-1) is set to off.</li> </ul>												
The inspection indicator lamp (LED 1 Green) in the control box flashes.	<table border="1" style="width: 100%;"> <tr> <td style="width: 15%;">2 flashes</td> <td style="width: 55%;">Failure of Lossnay circuit</td> <td rowspan="4" style="width: 30%;">Turn off the power and immediately contact your dealer.</td> </tr> <tr> <td>3 flashes</td> <td>Failure of damper motor system</td> </tr> <tr> <td>4 flashes</td> <td>Failure of Lossnay (OA side) motor system</td> </tr> <tr> <td>5 flashes</td> <td>Failure of Lossnay (RA side) motor system</td> </tr> <tr> <td>On</td> <td>In delay period</td> <td>If there is no remote controller (PZ-41SLB-E), the lamp will go out after 30 minutes (of operation) has passed.</td> </tr> </table>	2 flashes	Failure of Lossnay circuit	Turn off the power and immediately contact your dealer.	3 flashes	Failure of damper motor system	4 flashes	Failure of Lossnay (OA side) motor system	5 flashes	Failure of Lossnay (RA side) motor system	On	In delay period	If there is no remote controller (PZ-41SLB-E), the lamp will go out after 30 minutes (of operation) has passed.
2 flashes	Failure of Lossnay circuit	Turn off the power and immediately contact your dealer.											
3 flashes	Failure of damper motor system												
4 flashes	Failure of Lossnay (OA side) motor system												
5 flashes	Failure of Lossnay (RA side) motor system												
On	In delay period	If there is no remote controller (PZ-41SLB-E), the lamp will go out after 30 minutes (of operation) has passed.											
The inspection indicator lamp (LED 2 Red) in the control box flashes.	<table border="1" style="width: 100%;"> <tr> <td style="width: 15%;">1 to 8 flashes</td> <td style="width: 55%;">Error in M-NET communication</td> <td rowspan="2" style="width: 30%;">Turn off the power and immediately contact your dealer.</td> </tr> <tr> <td>On</td> <td>Registration operation has not been performed.</td> </tr> <tr> <td></td> <td></td> <td>Use the controller to perform the registration.</td> </tr> </table>	1 to 8 flashes	Error in M-NET communication	Turn off the power and immediately contact your dealer.	On	Registration operation has not been performed.			Use the controller to perform the registration.				
1 to 8 flashes	Error in M-NET communication	Turn off the power and immediately contact your dealer.											
On	Registration operation has not been performed.												
		Use the controller to perform the registration.											

- When an inspection number blinks on the remote controller, follow the procedures shown in the installation and operating manuals provided with the switch.

- If the remote controller is not used, operate approximately 45 seconds after turning on the power for the Lossnay.