

AIR CONDITIONING SYSTEMS

**HYBRID**  
CITY MULTI

**DATA BOOK**

MODEL

**PURY-M200-300YNW-A (-BS)**

**PURY-EM200-300YNW-A (-BS)**

Heat Recovery R2-Series



PURY-M200YNW-A(-BS)  
PURY-M300YNW-A(-BS)

PURY-M250YNW-A(-BS)

**8, 10, 12HP**

Heat Recovery High efficiency R2-Series



PURY-EM200YNW-A(-BS)  
PURY-EM300YNW-A(-BS)

PURY-EM250YNW-A(-BS)

**8, 10, 12HP**

**PURY-M-YNW-A, PURY-EM-YNW-A**

1. SPECIFICATIONS .....	2
2. EXTERNAL DIMENSIONS .....	8
3. CENTER OF GRAVITY .....	12
4. ELECTRICAL WIRING DIAGRAMS .....	13
5. SOUND LEVELS .....	14
5-1. Sound levels in cooling mode .....	14
5-2. Sound levels in heating mode .....	16
6. VIBRATION LEVEL .....	18
7. OPERATION TEMPERATURE RANGE .....	19
8. CAPACITY TABLES .....	20
8-1. Correction by temperature .....	20
8-2. Correction by total indoor .....	28
8-3. Correction by piping length .....	30
8-4. Correction at frost and defrost .....	31
8-5. Correction by antifreeze solution concentration .....	32
9. ELECTRICAL WORK .....	33
9-1. Power supply for Outdoor unit .....	33
9-2. Power cable specifications .....	34
9-3. Power supply examples .....	35
10.M-NET CONTROL .....	36
10-1.Address setting .....	36
11.PIPING DESIGN .....	37
11-1.R32 Piping material .....	37
11-2.Piping Design .....	38
11-3.Refrigerant charging calculation .....	47
11-4.Water piping .....	48

# 1. SPECIFICATIONS

R2-Series

PURY-M-YNW-A, EM-YNW-A

Model			PURY-M200YNW-A (-BS)	
Power source			3-phase 4-wire 380-400-415 V 50/60 Hz	
Cooling capacity (Nominal)	*1	kW	22.4	
		kcal/h	20,000	
		BTU/h	76,400	
	Power input	kW	6.85	
		Current input	A	11.5-10.9-10.5
		EER	kW/kW	3.27
Temp. range of cooling	*3	Indoor	W.B.	15.0~24.0°C (59~75°F)
		Outdoor	D.B.	-5.0~52.0°C (23~126°F)
Heating capacity (Nominal)	*2	kW	25.0	
		kcal/h	21,500	
		BTU/h	85,300	
	Power input	kW	6.94	
		Current input	A	11.7-11.1-10.7
		COP	kW/kW	3.60
Temp. range of heating	*3	Indoor	D.B.	15.0~27.0°C (59~81°F)
		Outdoor	W.B.	-20.0~15.5°C (-4~60°F)
Indoor unit connectable	Total capacity		50~150% of outdoor unit capacity	
	Model/Quantity		WP10-WP125/1~30	
Sound pressure level (measured in anechoic room) *4		dB <A>	59.0/59.0	
Sound power level (measured in anechoic room) *4		dB <A>	76.0/78.0	
Refrigerant piping diameter	High pressure	mm (in.)	15.88 (5/8) Brazed	
	Low pressure	mm (in.)	19.05 (3/4) Brazed	
FAN	Type x Quantity		Propeller fan x 1	
	Air flow rate	m <sup>3</sup> /min	170	
		L/s	2,833	
		cfm	6,003	
	Control, Driving mechanism		Inverter-control, Direct-driven by motor	
	Motor output	kW	0.92 x 1	
*5 External static press.		0 Pa (0 mmH <sub>2</sub> O)		
Compressor	Type		Inverter scroll hermetic compressor	
	Manufacture		AC&R Works, MITSUBISHI ELECTRIC CORPORATION	
	Starting method		Inverter	
	Motor output	kW	6.0	
	Case heater	kW	- (- V)	
	Lubricant		MEL46EH	
External finish			Pre-coated galvanized steel sheets (+powder coating for -BS type) <MUNSELL 5Y 8/1 or similar>	
External dimension H x W x D		mm	1,858 (1,798 without legs) x 920 x 740	
		in.	73-3/16 (70-13/16 without legs) x 36-1/4 x 29-3/16	
Protection devices	High pressure protection		High pressure sensor, High pressure switch at 4.15 MPa (601 psi)	
	Inverter circuit (COMP./FAN)		Over-heat protection, Over-current protection	
	Compressor		-	
	Fan motor		-	
Refrigerant	Type x original charge		R32 x 5.2 kg (12 lbs)	
	Control		HBC controller	
Net weight		kg (lbs)	231 (510)	
Heat exchanger			Salt-resistant cross fin & copper tube	
HIC circuit (HIC: Heat Inter-Changer)			-	
Defrosting method			Auto-defrost mode (Reversed refrigerant cycle, Hot gas)	
Drawing	External		WKL94L647	
	Wiring		WKE94G951	
Standard attachment	Document		Installation Manual	
	Accessory		-	
Optional parts			Main HBC controller: CMB-WM108,1016V-AA Sub HBC controller: CMB-WM108,1016V-AB	
Remarks			Details on foundation work, duct work, insulation work, electrical wiring, power source switch, and other items shall be referred to the Installation Manual. Due to continuing improvement, above specifications may be subject to change without notice.	

Notes:	Unit converter
1. Nominal cooling conditions (subject to JIS B8615-2) Indoor: 27°C D.B./19°C W.B. (81°F D.B./66°F W.B.), Outdoor: 35°C D.B. (95°F D.B.) Pipe length: 7.5 m (24-9/16 ft.), Level difference: 0 m (0 ft.)	BTU/h = kW x 3,412
2. Nominal heating conditions (subject to JIS B8615-2) Indoor: 20°C D.B. (68°F D.B.), Outdoor: 7°C D.B./6°C W.B. (45°F D.B./43°F W.B.) Pipe length: 7.5 m (24-9/16 ft.), Level difference: 0 m (0 ft.)	cfm = m <sup>3</sup> /min x 35.31
3. -5°C D.B. (23°F D.B.)/-6°C W.B. (21°F W.B.) to 21°C D.B. (70°F D.B.)/15.5°C W.B. (60°F W.B.) with cooling/heating mixed operation.	lbs = kg/0.4536
4. Cooling mode/Heating mode	
5. External static pressure option is available (30 Pa, 60 Pa, 80 Pa/3.1 mmH <sub>2</sub> O, 6.1 mmH <sub>2</sub> O, 8.2 mmH <sub>2</sub> O). Consult your dealer about the specification when setting External static pressure option.	
6. R32 is flammable, and certain restrictions apply to the installation of units. When installing new units, moving the existing units, or changing the layout of the room, ensure that installation restrictions are observed. For detail, refer to the section in the Databook on installation restrictions.	*Above specification data is subject to rounding variation.

# 1. SPECIFICATIONS

Model			PURY-M250YNW-A (-BS)	
Power source			3-phase 4-wire 380-400-415 V 50/60 Hz	
Cooling capacity (Nominal)	*1	kW	28.0	
		kcal/h	25,000	
		BTU/h	95,500	
	Power input	kW	9.92	
	Current input	A	16.7-15.9-15.3	
EER			2.82	
Temp. range of cooling	*3	Indoor	W.B.	15.0~24.0°C (59~75°F)
		Outdoor	D.B.	-5.0~52.0°C (23~126°F)
Heating capacity (Nominal)	*2	kW	31.5	
		kcal/h	27,100	
		BTU/h	107,500	
	Power input	kW	10.06	
	Current input	A	16.9-16.1-15.5	
COP			3.13	
Temp. range of heating	*3	Indoor	D.B.	15.0~27.0°C (59~81°F)
		Outdoor	W.B.	-20.0~15.5°C (-4~60°F)
Indoor unit connectable	Total capacity		50~150% of outdoor unit capacity	
	Model/Quantity		WP10-WP125/1~37	
Sound pressure level (measured in anechoic room) *4		dB <A>	60.5/61.0	
Sound power level (measured in anechoic room) *4		dB <A>	78.5/80.0	
Refrigerant piping diameter	High pressure		mm (in.)	15.88 (5/8) Brazed
	Low pressure		mm (in.)	19.05 (3/4) Brazed
FAN	Type x Quantity		Propeller fan x 1	
	Air flow rate	m <sup>3</sup> /min	185	
		L/s	3,083	
		cfm	6,532	
	Control, Driving mechanism		Inverter-control, Direct-driven by motor	
Motor output	kW	0.92 x 1		
*5 External static press.		0 Pa (0 mmH <sub>2</sub> O)		
Compressor	Type		Inverter scroll hermetic compressor	
	Manufacture		AC&R Works, MITSUBISHI ELECTRIC CORPORATION	
	Starting method		Inverter	
	Motor output	kW	7.5	
	Case heater	kW	- (- V)	
	Lubricant		MEL46EH	
External finish			Pre-coated galvanized steel sheets (+powder coating for -BS type) <MUNSELL 5Y 8/1 or similar>	
External dimension H x W x D		mm	1,858 (1,798 without legs) x 920 x 740	
		in.	73-3/16 (70-13/16 without legs) x 36-1/4 x 29-3/16	
Protection devices	High pressure protection		High pressure sensor, High pressure switch at 4.15 MPa (601 psi)	
	Inverter circuit (COMP./FAN)		Over-heat protection, Over-current protection	
	Compressor		-	
	Fan motor		-	
Refrigerant	Type x original charge		R32 x 5.2 kg (12 lbs)	
	Control		HBC controller	
Net weight	kg (lbs)	231 (510)		
Heat exchanger			Salt-resistant cross fin & copper tube	
HIC circuit (HIC: Heat Inter-Changer)			-	
Defrosting method			Auto-defrost mode (Reversed refrigerant cycle, Hot gas)	
Drawing	External		WKL94L647	
	Wiring		WKE94G951	
Standard attachment	Document		Installation Manual	
	Accessory		-	
Optional parts			Main HBC controller: CMB-WM108,1016V-AA Sub HBC controller: CMB-WM108,1016V-AB	
Remarks			Details on foundation work, duct work, insulation work, electrical wiring, power source switch, and other items shall be referred to the Installation Manual. Due to continuing improvement, above specifications may be subject to change without notice.	

Notes:	Unit converter
1.Nominal cooling conditions (subject to JIS B8615-2) Indoor: 27°C D.B./19°C W.B. (81°F D.B./66°F W.B.), Outdoor: 35°C D.B. (95°F D.B.) Pipe length: 7.5 m (24-9/16 ft.), Level difference: 0 m (0 ft.)	BTU/h =kW x 3,412
2.Nominal heating conditions (subject to JIS B8615-2) Indoor: 20°C D.B. (68°F D.B.), Outdoor: 7°C D.B./6°C W.B. (45°F D.B./43°F W.B.) Pipe length: 7.5 m (24-9/16 ft.), Level difference: 0 m (0 ft.)	cfm =m <sup>3</sup> /min x 35.31
3.-5°C D.B. (23°F D.B.)-6°C W.B. (21°F W.B.) to 21°C D.B. (70°F D.B.)/15.5°C W.B. (60°F W.B.) with cooling/heating mixed operation.	lbs =kg/0.4536
4.Cooling mode/Heating mode	
5.External static pressure option is available (30 Pa, 60 Pa, 80 Pa/3.1 mmH <sub>2</sub> O, 6.1 mmH <sub>2</sub> O, 8.2 mmH <sub>2</sub> O). Consult your dealer about the specification when setting External static pressure option.	
6.R32 is flammable, and certain restrictions apply to the installation of units. When installing new units, moving the existing units, or changing the layout of the room, ensure that installation restrictions are observed. For detail, refer to the section in the Databook on installation restrictions.	*Above specification data is subject to rounding variation.

# 1. SPECIFICATIONS

R2-Series

PURY-M-YNW-A, EM-YNW-A

Model			PURY-M300YNW-A (-BS)	
Number of HBC controller			Single HBC	Double HBC
Power source			3-phase 4-wire 380-400-415 V 50/60 Hz	
Cooling capacity (Nominal)	*1	kW	33.5	
		kcal/h	30,000	
		BTU/h	114,300	
	Power input	kW	13.08	11.09
	Current input	A	22.0-20.9-20.2	18.7-17.7-17.1
EER	kW/kW	2.56	3.02	
Temp. range of cooling	*3 Indoor	W.B.	15.0~24.0°C (59~75°F)	
	Outdoor	D.B.	-5.0~52.0°C (23~126°F)	
Heating capacity (Nominal)	*2	kW	37.5	
		kcal/h	32,300	
		BTU/h	128,000	
	Power input	kW	12.45	11.68
	Current input	A	21.0-19.9-19.2	19.7-18.7-18.0
COP	kW/kW	3.01	3.21	
Temp. range of heating	*3 Indoor	D.B.	15.0~27.0°C (59~81°F)	
	Outdoor	W.B.	-20.0~15.5°C (-4~60°F)	
Heating unit connectable	Total capacity		50~150% of outdoor unit capacity	
	Model/Quantity		WP10~WP125/2~45	
Sound pressure level (measured in anechoic room) *4		dB <A>	61.0/67.0	
Sound power level (measured in anechoic room) *4		dB <A>	80.0/86.5	
Refrigerant piping diameter	High pressure	mm (in.)	15.88 (5/8) Brazed	
	Low pressure	mm (in.)	19.05 (3/4) Brazed	
FAN	Type x Quantity		Propeller fan x 1	
	Air flow rate	m <sup>3</sup> /min	240	
		L/s	4,000	
		cfm	8,474	
	Control, Driving mechanism		Inverter-control, Direct-driven by motor	
Motor output	kW	0.92 x 1		
*5 External static press.			0 Pa (0 mmH <sub>2</sub> O)	
Compressor	Type		Inverter scroll hermetic compressor	
	Manufacture		AC&R Works, MITSUBISHI ELECTRIC CORPORATION	
	Starting method		Inverter	
	Motor output	kW	8.5	
	Case heater	kW	- (- V)	
	Lubricant		MEL46EH	
External finish			Pre-coated galvanized steel sheets (+powder coating for -BS type) <MUNSELL 5Y 8/1 or similar>	
External dimension H x W x D		mm	1,858 (1,798 without legs) x 920 x 740	
		in.	73-3/16 (70-13/16 without legs) x 36-1/4 x 29-3/16	
Protection devices	High pressure protection		High pressure sensor, High pressure switch at 4.15 MPa (601 psi)	
	Inverter circuit (COMP./FAN)		Over-heat protection, Over-current protection	
	Compressor		-	
Fan motor		-		
Refrigerant	Type x original charge		R32 x 5.2 kg (12 lbs)	
	Control		HBC controller	
Net weight		kg (lbs)	231 (510)	
Heat exchanger			Salt-resistant cross fin & copper tube	
HIC circuit (HIC: Heat Inter-Changer)			-	
Defrosting method			Auto-defrost mode (Reversed refrigerant cycle, Hot gas)	
Drawing	External		WKL94L647	
	Wiring		WKE94G951	
Standard attachment	Document		Installation Manual	
	Accessory		-	
Optional parts			Main HBC controller: CMB-WM108,1016V-AA Sub HBC controller: CMB-WM108,1016V-AB	
Remarks			Details on foundation work, duct work, insulation work, electrical wiring, power source switch, and other items shall be referred to the Installation Manual. Due to continuing improvement, above specifications may be subject to change without notice.	

Notes:	Unit converter
1. Nominal cooling conditions (subject to JIS B8615-2) Indoor: 27°C D.B./19°C W.B. (81°F D.B./66°F W.B.), Outdoor: 35°C D.B. (95°F D.B.) Pipe length: 7.5 m (24-9/16 ft.), Level difference: 0 m (0 ft.)	BTU/h = kW x 3,412
2. Nominal heating conditions (subject to JIS B8615-2) Indoor: 20°C D.B. (68°F D.B.), Outdoor: 7°C D.B./6°C W.B. (45°F D.B./43°F W.B.) Pipe length: 7.5 m (24-9/16 ft.), Level difference: 0 m (0 ft.)	cfm = m <sup>3</sup> /min x 35.31
3. -5°C D.B. (23°F D.B.)/-6°C W.B. (21°F W.B.) to 21°C D.B. (70°F D.B.)/15.5°C W.B. (60°F W.B.) with cooling/heating mixed operation.	lbs = kg/0.4536
4. Cooling mode/Heating mode	
5. External static pressure option is available (30 Pa, 60 Pa, 80 Pa/3.1 mmH <sub>2</sub> O, 6.1 mmH <sub>2</sub> O, 8.2 mmH <sub>2</sub> O). Consult your dealer about the specification when setting External static pressure option.	
6. R32 is flammable, and certain restrictions apply to the installation of units. When installing new units, moving the existing units, or changing the layout of the room, ensure that installation restrictions are observed. For detail, refer to the section in the Databook on installation restrictions.	*Above specification data is subject to rounding variation.

# 1. SPECIFICATIONS

Model			PURY-EM200YNW-A (-BS)	
Power source			3-phase 4-wire 380-400-415 V 50/60 Hz	
Cooling capacity (Nominal)	*1	kW	22.4	
		kcal/h	20,000	
		BTU/h	76,400	
	Power input	kW	6.15	
		Current input	A	10.3-9.8-9.5
EER		kW/kW	3.64	
Temp. range of cooling	*3	Indoor	W.B.	15.0~24.0°C (59~75°F)
		Outdoor	D.B.	-5.0~52.0°C (23~126°F)
Heating capacity (Nominal)	*2	kW	25.0	
		kcal/h	21,500	
		BTU/h	85,300	
	Power input	kW	6.77	
		Current input	A	11.4-10.8-10.4
COP		kW/kW	3.69	
Temp. range of heating	*3	Indoor	D.B.	15.0~27.0°C (59~81°F)
		Outdoor	W.B.	-20.0~15.5°C (-4~60°F)
Indoor unit connectable	Total capacity		50~150% of outdoor unit capacity	
	Model/Quantity		WP10-WP125/1~30	
Sound pressure level (measured in anechoic room) *4		dB <A>	59.0/59.0	
Sound power level (measured in anechoic room) *4		dB <A>	76.0/78.0	
Refrigerant piping diameter	High pressure	mm (in.)	15.88 (5/8) Brazed	
	Low pressure	mm (in.)	19.05 (3/4) Brazed	
FAN	Type x Quantity		Propeller fan x 1	
	Air flow rate	m <sup>3</sup> /min	170	
		L/s	2,833	
		cfm	6,003	
	Control, Driving mechanism		Inverter-control, Direct-driven by motor	
	Motor output	kW	0.92 x 1	
*5	External static press.		0 Pa (0 mmH <sub>2</sub> O)	
Compressor	Type		Inverter scroll hermetic compressor	
	Manufacture		AC&R Works, MITSUBISHI ELECTRIC CORPORATION	
	Starting method		Inverter	
	Motor output	kW	6.0	
	Case heater	kW	- (- V)	
	Lubricant		MEL46EH	
External finish			Pre-coated galvanized steel sheets (+powder coating for -BS type) <MUNSELL 5Y 8/1 or similar>	
External dimension H x W x D		mm	1,858 (1,798 without legs) x 920 x 740	
		in.	73-3/16 (70-13/16 without legs) x 36-1/4 x 29-3/16	
Protection devices	High pressure protection		High pressure sensor, High pressure switch at 4.15 MPa (601 psi)	
	Inverter circuit (COMP./FAN)		Over-heat protection, Over-current protection	
	Compressor		-	
	Fan motor		-	
Refrigerant	Type x original charge		R32 x 5.2 kg (12 lbs)	
	Control		HBC controller	
Net weight		kg (lbs)	237 (523)	
Heat exchanger			Salt-resistant cross fin & aluminium tube	
HIC circuit (HIC: Heat Inter-Changer)			-	
Defrosting method			Auto-defrost mode (Reversed refrigerant cycle, Hot gas)	
Drawing	External		WKL94L648	
	Wiring		WKE94G951	
Standard attachment	Document		Installation Manual	
	Accessory		-	
Optional parts			Main HBC controller: CMB-WM108,1016V-AA Sub HBC controller: CMB-WM108,1016V-AB	
Remarks			Details on foundation work, duct work, insulation work, electrical wiring, power source switch, and other items shall be referred to the Installation Manual. Due to continuing improvement, above specifications may be subject to change without notice.	

Notes:	Unit converter
1.Nominal cooling conditions (subject to JIS B8615-2) Indoor: 27°C D.B./19°C W.B. (81°F D.B./66°F W.B.), Outdoor: 35°C D.B. (95°F D.B.) Pipe length: 7.5 m (24-9/16 ft.), Level difference: 0 m (0 ft.)	BTU/h =kW x 3,412
2.Nominal heating conditions (subject to JIS B8615-2) Indoor: 20°C D.B. (68°F D.B.), Outdoor: 7°C D.B./6°C W.B. (45°F D.B./43°F W.B.) Pipe length: 7.5 m (24-9/16 ft.), Level difference: 0 m (0 ft.)	cfm =m <sup>3</sup> /min x 35.31
3.-5°C D.B. (23°F D.B.)-6°C W.B. (21°F W.B.) to 21°C D.B. (70°F D.B.)/15.5°C W.B. (60°F W.B.) with cooling/heating mixed operation.	lbs =kg/0.4536
4.Cooling mode/Heating mode	
5.External static pressure option is available (30 Pa, 60 Pa, 80 Pa/3.1 mmH <sub>2</sub> O, 6.1 mmH <sub>2</sub> O, 8.2 mmH <sub>2</sub> O). Consult your dealer about the specification when setting External static pressure option.	
6.R32 is flammable, and certain restrictions apply to the installation of units. When installing new units, moving the existing units, or changing the layout of the room, ensure that installation restrictions are observed. For detail, refer to the section in the Databook on installation restrictions.	*Above specification data is subject to rounding variation.

# 1. SPECIFICATIONS

R2-Series

PURY-M-YNW-A, EM-YNW-A

Model			PURY-EM250YNW-A (-BS)		
Power source			3-phase 4-wire 380-400-415 V 50/60 Hz		
Cooling capacity (Nominal)	*1	kW	28.0		
		kcal/h	25,000		
		BTU/h	95,500		
	Power input	kW	8.77		
		Current input	A	14.8-14.0-13.5	
		EER	kW/kW	3.19	
Temp. range of cooling	*3	Indoor	W.B.	15.0~24.0°C (59~75°F)	
		Outdoor	D.B.	-5.0~52.0°C (23~126°F)	
Heating capacity (Nominal)	*2	kW	31.5		
		kcal/h	27,100		
		BTU/h	107,500		
	Power input	kW	9.84		
		Current input	A	16.6-15.7-15.2	
		COP	kW/kW	3.20	
Temp. range of heating	*3	Indoor	D.B.	15.0~27.0°C (59~81°F)	
		Outdoor	W.B.	-20.0~15.5°C (-4~60°F)	
Indoor unit connectable	Total capacity		50~150% of outdoor unit capacity		
	Model/Quantity		WP10-WP125/1-37		
Sound pressure level (measured in anechoic room) *4		dB <A>	60.5/61.0		
Sound power level (measured in anechoic room) *4		dB <A>	78.5/80.0		
Refrigerant piping diameter	High pressure	mm (in.)	15.88 (5/8) Brazed		
	Low pressure	mm (in.)	19.05 (3/4) Brazed		
FAN	Type x Quantity		Propeller fan x 1		
	Air flow rate	m <sup>3</sup> /min	185		
		L/s	3,083		
		cfm	6,532		
	Control, Driving mechanism		Inverter-control, Direct-driven by motor		
	Motor output	kW	0.92 x 1		
*5 External static press.		0 Pa (0 mmH <sub>2</sub> O)			
Compressor	Type		Inverter scroll hermetic compressor		
	Manufacture		AC&R Works, MITSUBISHI ELECTRIC CORPORATION		
	Starting method		Inverter		
	Motor output	kW	7.5		
	Case heater	kW	- (- V)		
	Lubricant		MEL46EH		
External finish			Pre-coated galvanized steel sheets (+powder coating for -BS type) <MUNSELL 5Y 8/1 or similar>		
External dimension H x W x D		mm	1,858 (1,798 without legs) x 920 x 740		
		in.	73-3/16 (70-13/16 without legs) x 36-1/4 x 29-3/16		
Protection devices	High pressure protection		High pressure sensor, High pressure switch at 4.15 MPa (601 psi)		
	Inverter circuit (COMP./FAN)		Over-heat protection, Over-current protection		
	Compressor		-		
	Fan motor		-		
Refrigerant	Type x original charge		R32 x 5.2 kg (12 lbs)		
	Control		HBC controller		
Net weight		kg (lbs)	237 (523)		
Heat exchanger			Salt-resistant cross fin & aluminium tube		
HIC circuit (HIC: Heat Inter-Changer)			-		
Defrosting method			Auto-defrost mode (Reversed refrigerant cycle, Hot gas)		
Drawing	External		WKL94L648		
	Wiring		WKE94G951		
Standard attachment	Document		Installation Manual		
	Accessory		-		
Optional parts			Main HBC controller: CMB-WM108,1016V-AA Sub HBC controller: CMB-WM108,1016V-AB		
Remarks			Details on foundation work, duct work, insulation work, electrical wiring, power source switch, and other items shall be referred to the Installation Manual. Due to continuing improvement, above specifications may be subject to change without notice.		

Notes:	Unit converter
1. Nominal cooling conditions (subject to JIS B8615-2) Indoor: 27°C D.B./19°C W.B. (81°F D.B./66°F W.B.), Outdoor: 35°C D.B. (95°F D.B.) Pipe length: 7.5 m (24-9/16 ft.), Level difference: 0 m (0 ft.)	BTU/h = kW x 3,412
2. Nominal heating conditions (subject to JIS B8615-2) Indoor: 20°C D.B. (68°F D.B.), Outdoor: 7°C D.B./6°C W.B. (45°F D.B./43°F W.B.) Pipe length: 7.5 m (24-9/16 ft.), Level difference: 0 m (0 ft.)	cfm = m <sup>3</sup> /min x 35.31
3. -5°C D.B. (23°F D.B.)/-6°C W.B. (21°F W.B.) to 21°C D.B. (70°F D.B.)/15.5°C W.B. (60°F W.B.) with cooling/heating mixed operation.	lbs = kg/0.4536
4. Cooling mode/Heating mode	
5. External static pressure option is available (30 Pa, 60 Pa, 80 Pa/3.1 mmH <sub>2</sub> O, 6.1 mmH <sub>2</sub> O, 8.2 mmH <sub>2</sub> O). Consult your dealer about the specification when setting External static pressure option.	
6. R32 is flammable, and certain restrictions apply to the installation of units. When installing new units, moving the existing units, or changing the layout of the room, ensure that installation restrictions are observed. For detail, refer to the section in the Databook on installation restrictions.	*Above specification data is subject to rounding variation.



# 1. SPECIFICATIONS

Model			PURY-EM300YNW-A (-BS)	
Number of HBC controller			Single HBC	Double HBC
Power source			3-phase 4-wire 380-400-415 V 50/60 Hz	
Cooling capacity (Nominal)	*1	kW	33.5	
		kcal/h	30,000	
		BTU/h	114,300	
	Power input	kW	11.79	10.02
	Current input	A	19.9-18.9-18.2	16.9-16.0-15.4
EER	kW/kW	2.84	3.34	
Temp. range of cooling	Indoor	W.B.	15.0~24.0°C (59~75°F)	
	*3 Outdoor	D.B.	-5.0~52.0°C (23~126°F)	
Heating capacity (Nominal)	*2	kW	37.5	
		kcal/h	32,300	
		BTU/h	128,000	
	Power input	kW	11.46	10.90
	Current input	A	19.3-18.3-17.7	18.4-17.4-16.8
COP	kW/kW	3.27	3.44	
Temp. range of heating	Indoor	D.B.	15.0~27.0°C (59~81°F)	
	*3 Outdoor	W.B.	-20.0~15.5°C (-4~60°F)	
Indoor unit connectable	Total capacity	50~150% of outdoor unit capacity		
	Model/Quantity	WP10-WP125/2-45		
Sound pressure level (measured in anechoic room) *4	dB <A>	61.0/67.0		
Sound power level (measured in anechoic room) *4	dB <A>	80.0/86.5		
Refrigerant piping diameter	High pressure	mm (in.)	15.88 (5/8) Brazed	
	Low pressure	mm (in.)	19.05 (3/4) Brazed	
FAN	Type x Quantity		Propeller fan x 1	
	Air flow rate	m <sup>3</sup> /min	240	
		L/s	4,000	
		cfm	8,474	
	Control, Driving mechanism		Inverter-control, Direct-driven by motor	
Motor output	kW	0.92 x 1		
*5 External static press.	0 Pa (0 mmH <sub>2</sub> O)			
Compressor	Type		Inverter scroll hermetic compressor	
	Manufacture		AC&R Works, MITSUBISHI ELECTRIC CORPORATION	
	Starting method		Inverter	
	Motor output	kW	8.5	
	Case heater	kW	- (- V)	
	Lubricant		MEL46EH	
External finish			Pre-coated galvanized steel sheets (+powder coating for -BS type) <MUNSELL 5Y 8/1 or similar>	
External dimension H x W x D	mm	1,858 (1,798 without legs) x 920 x 740		
	in.	73-3/16 (70-13/16 without legs) x 36-1/4 x 29-3/16		
Protection devices	High pressure protection		High pressure sensor, High pressure switch at 4.15 MPa (601 psi)	
	Inverter circuit (COMP./FAN)		Over-heat protection, Over-current protection	
	Compressor		-	
Fan motor		-		
Refrigerant	Type x original charge		R32 x 5.2 kg (12 lbs)	
	Control		HBC controller	
Net weight	kg (lbs)	237 (523)		
Heat exchanger			Salt-resistant cross fin & aluminium tube	
HIC circuit (HIC: Heat Inter-Changer)			-	
Defrosting method			Auto-defrost mode (Reversed refrigerant cycle, Hot gas)	
Drawing	External	WKL94L648		
	Wiring	WKE94G951		
Standard attachment	Document	Installation Manual		
	Accessory	-		
Optional parts			Main HBC controller: CMB-WM108,1016V-AA Sub HBC controller: CMB-WM108,1016V-AB	
Remarks			Details on foundation work, duct work, insulation work, electrical wiring, power source switch, and other items shall be referred to the Installation Manual. Due to continuing improvement, above specifications may be subject to change without notice.	

Notes:	Unit converter
1. Nominal cooling conditions (subject to JIS B8615-2) Indoor: 27°C D.B./19°C W.B. (81°F D.B./66°F W.B.), Outdoor: 35°C D.B. (95°F D.B.) Pipe length: 7.5 m (24-9/16 ft.), Level difference: 0 m (0 ft.)	BTU/h =kW x 3,412
2. Nominal heating conditions (subject to JIS B8615-2) Indoor: 20°C D.B. (68°F D.B.), Outdoor: 7°C D.B./6°C W.B. (45°F D.B./43°F W.B.) Pipe length: 7.5 m (24-9/16 ft.), Level difference: 0 m (0 ft.)	cfm =m <sup>3</sup> /min x 35.31
3. -5°C D.B. (23°F D.B.)-6°C W.B. (21°F W.B.) to 21°C D.B. (70°F D.B.)/15.5°C W.B. (60°F W.B.) with cooling/heating mixed operation.	lbs =kg/0.4536
4. Cooling mode/Heating mode	
5. External static pressure option is available (30 Pa, 60 Pa, 80 Pa/3.1 mmH <sub>2</sub> O, 6.1 mmH <sub>2</sub> O, 8.2 mmH <sub>2</sub> O). Consult your dealer about the specification when setting External static pressure option.	
6. R32 is flammable, and certain restrictions apply to the installation of units. When installing new units, moving the existing units, or changing the layout of the room, ensure that installation restrictions are observed. For detail, refer to the section in the Databook on installation restrictions.	*Above specification data is subject to rounding variation.

PURY-M200, 250, 300YNW-A(-BS)

Unit: mm

- Note 1. Please refer to next page for information regarding necessary spacing around the unit and foundation work.  
 2. The detachable leg can be removed at site.  
 3. At brazing of pipes, wrap the refrigerant service valve with wet cloth and keep the temperature of refrigerant service valve under 120 °C.

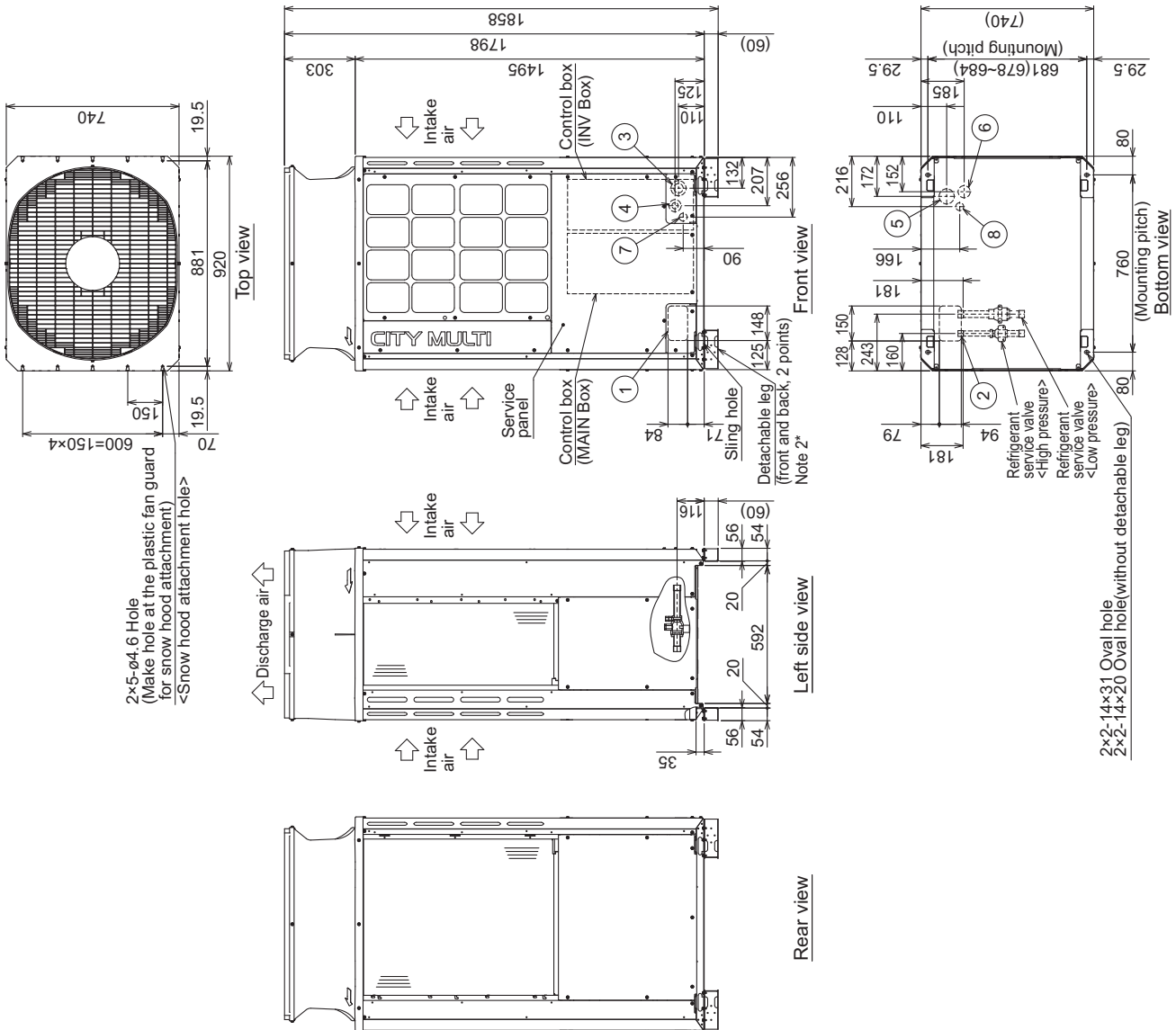

Connecting pipe specifications

Model	Refrigerant pipe		Service valve	
	High pressure	Low pressure	High pressure	Low pressure
M200	ø15.88 Brazed*1	ø19.05 Brazed*1	ø22.2	ø28.58
M250	ø15.88 Brazed*1	ø19.05 Brazed*1	ø22.2	ø28.58
M300	ø15.88 Brazed*1	ø19.05 Brazed*1	ø22.2	ø28.58

\*1 Connect the refrigerant pipe to the service valve according to the Installation Manual.

NO.	Usage	Specifications
①	For pipes	Front through hole 148 X 84 Knockout hole
②		Bottom through hole 150 X 94 Knockout hole
③	For wires	Front through hole ø65 or ø40 Knockout hole
④		Front through hole ø52 or ø27 Knockout hole
⑤		Bottom through hole ø65 Knockout hole
⑥		Bottom through hole ø52 Knockout hole
⑦	For transmission cables	Front through hole ø34 Knockout hole
⑧		Bottom through hole ø34 Knockout hole

**1. Required space around the unit**

● In case of single installation

- ① Secure enough space around the unit as shown in the figure below.

- With a space of at least 300mm to the wall on the back of the unit

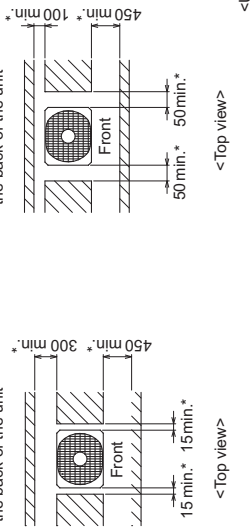

- ② When the height of the walls on the front, back or on the sides<H> exceeds the wall height limit as defined below add the height that exceeds the height limit <h> to the figures that are marked with an asterisk.

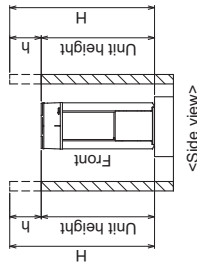

<Wall height limit> Front : Up to the unit height  
 Back : Up to the unit height  
 Side : Up to the unit height

● In case of collective installation

- ① When multiple units are installed adjacent to each other, secure enough space to allow for air circulation and walkway between groups of units as shown in the figures below.
- ② At least two sides must be left open.
- ③ As with the single installation, add the height that exceeds the height limit<h> to the figures that are marked with an asterisk.
- ④ If there is a wall at both the front and the rear of the unit, install up to six units consecutively in the side direction and provide a space of 1000mm or more as inlet space/ passage space for each six units.

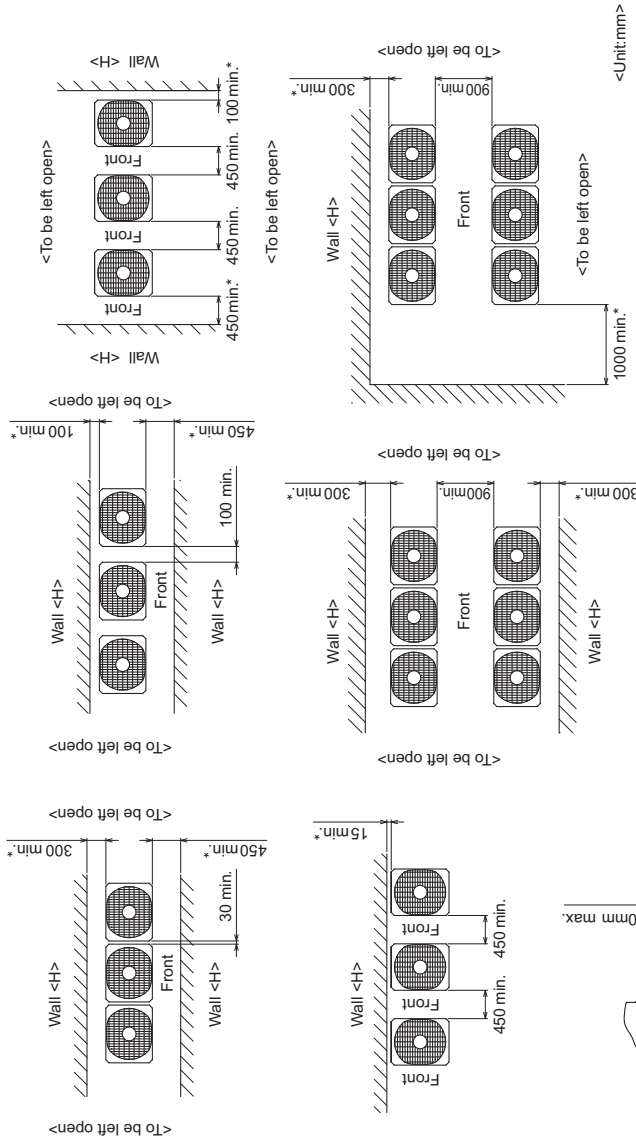

**2. Foundation work**

- ① Take into consideration the surface strength, water drainage route, piping route, and wiring route when preparing the installation site.  
 <Note that the drain water comes out of the unit during operation.>
- ② Build the foundation in such way that the corner of the installation leg is securely supported as shown in the right figure.(Fig.A,B)  
 When using a rubber-isolating cushion, please ensure it is large enough to cover the entire width of each of the unit's legs.
- ③ The protrusion length of the anchor bolt must not exceed 30mm.(Fig.A,B)
- ④ Use four fixing plates as shown in the right figure <field supply required> when using post-installed anchor bolts.(Fig.C,D)
- ⑤ To prevent small animals and water and snow from entering the unit and damaging its parts, close the gap around the edges of through holes for pipes and wires with filler plates <field supply required>.
- ⑥ When the pipes or cables are routed at the bottom of the unit, make sure that the through hole at the base of the unit does not get blocked with the installation base.
- ⑦ Refer to the Installation Manual when installing units on an installation base.

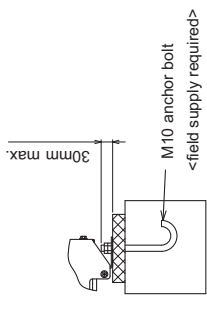

Fig.A (without detachable legs)

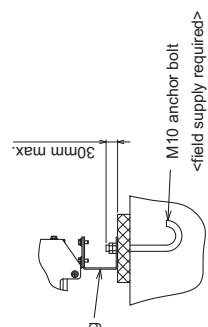

Fig.B (with detachable legs)



Fig.C (without detachable legs)

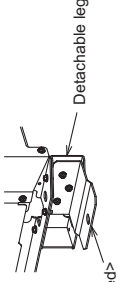
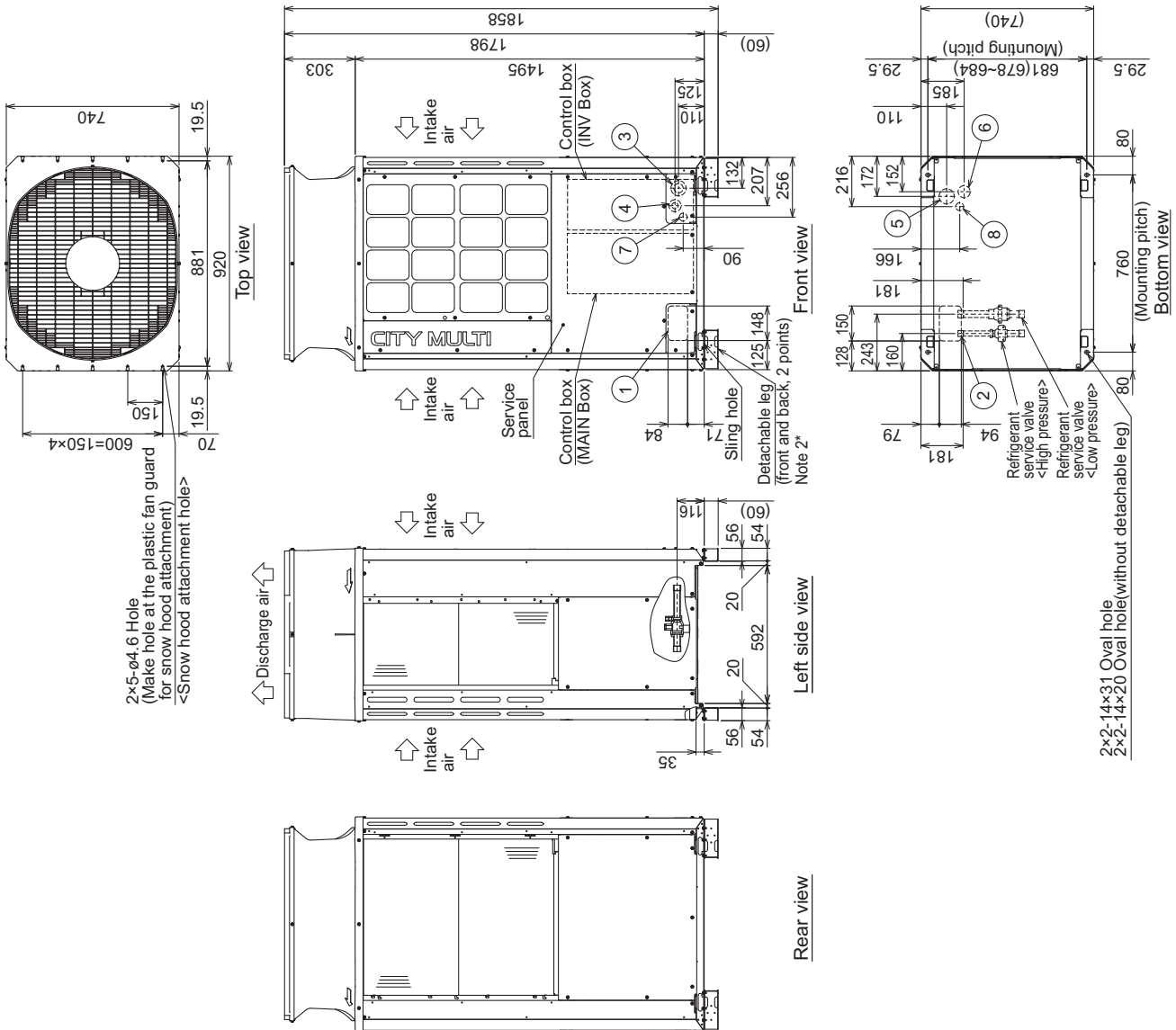

Fig.D (with detachable legs)

PURY-EM200, 250, 300YNW-A(-BS)

Unit: mm

- Note 1. Please refer to next page for information regarding necessary spacing around the unit and foundation work.  
 2. The detachable leg can be removed at site.  
 3. At brazing of pipes, wrap the refrigerant service valve with wet cloth and keep the temperature of refrigerant service valve under 120 °C.



Connecting pipe specifications

Model	Refrigerant pipe		Service valve	
	High pressure	Low pressure	High pressure	Low pressure
EM200	ø15.88 Brazed*1	ø19.05 Brazed*1	ø22.2	ø28.58
EM250	ø15.88 Brazed*1	ø19.05 Brazed*1	ø22.2	ø28.58
EM300	ø15.88 Brazed*1	ø19.05 Brazed*1	ø22.2	ø28.58

\*1 Connect the refrigerant pipe to the service valve according to the Installation Manual.

NO.	Usage	Specifications
①	For pipes	Front through hole 148 X 84 Knockout hole
②		Bottom through hole 150 X 94 Knockout hole
③	For wires	Front through hole ø65 or ø40 Knockout hole
④		Front through hole ø52 or ø27 Knockout hole
⑤		Bottom through hole ø65 Knockout hole
⑥		Bottom through hole ø52 Knockout hole
⑦	For transmission cables	Front through hole ø34 Knockout hole
⑧		Bottom through hole ø34 Knockout hole

**1. Required space around the unit**

● In case of single installation

- ① Secure enough space around the unit as shown in the figure below.

- With a space of at least 300mm to the wall on the back of the unit

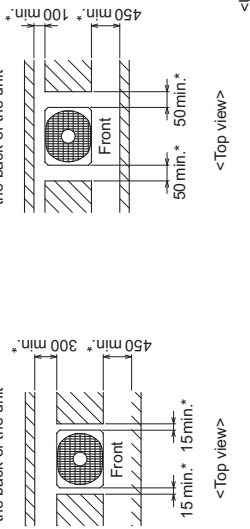

- ② When the height of the walls on the front, back or on the sides<H> exceeds the wall height limit as defined below add the height that exceeds the height limit <h> to the figures that are marked with an asterisk.

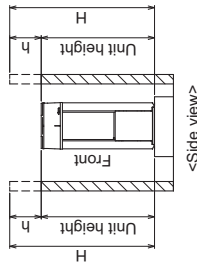

<Wall height limit> Front : Up to the unit height  
 Back : Up to the unit height  
 Side : Up to the unit height

**2. Foundation work**

- ① Take into consideration the surface strength, water drainage route, piping route, and wiring route when preparing the installation site.  
 <Note that the drain water comes out of the unit during operation.>
- ② Build the foundation in such way that the corner of the installation leg is securely supported as shown in the right figure.(Fig.A,B)  
 When using a rubber-isolating cushion, please ensure it is large enough to cover the entire width of each of the unit's legs.
- ③ The protrusion length of the anchor bolt must not exceed 30mm.(Fig.A,B)
- ④ Use four fixing plates as shown in the right figure <field supply required> when using post-installed anchor bolts.(Fig.C,D)
- ⑤ To prevent small animals and water and snow from entering the unit and damaging its parts, close the gap around the edges of through holes for pipes and wires with filler plates <field supply required>.
- ⑥ When the pipes or cables are routed at the bottom of the unit, make sure that the through hole at the base of the unit does not get blocked with the installation base.
- ⑦ Refer to the Installation Manual when installing units on an installation base.

● In case of collective installation

- ① When multiple units are installed adjacent to each other, secure enough space to allow for air circulation and walkway between groups of units as shown in the figures below.
- ② At least two sides must be left open.
- ③ As with the single installation, add the height that exceeds the height limit<h> to the figures that are marked with an asterisk.
- ④ If there is a wall at both the front and the rear of the unit, install up to six units consecutively in the side direction and provide a space of 1000mm or more as inlet space/ passage space for each six units.

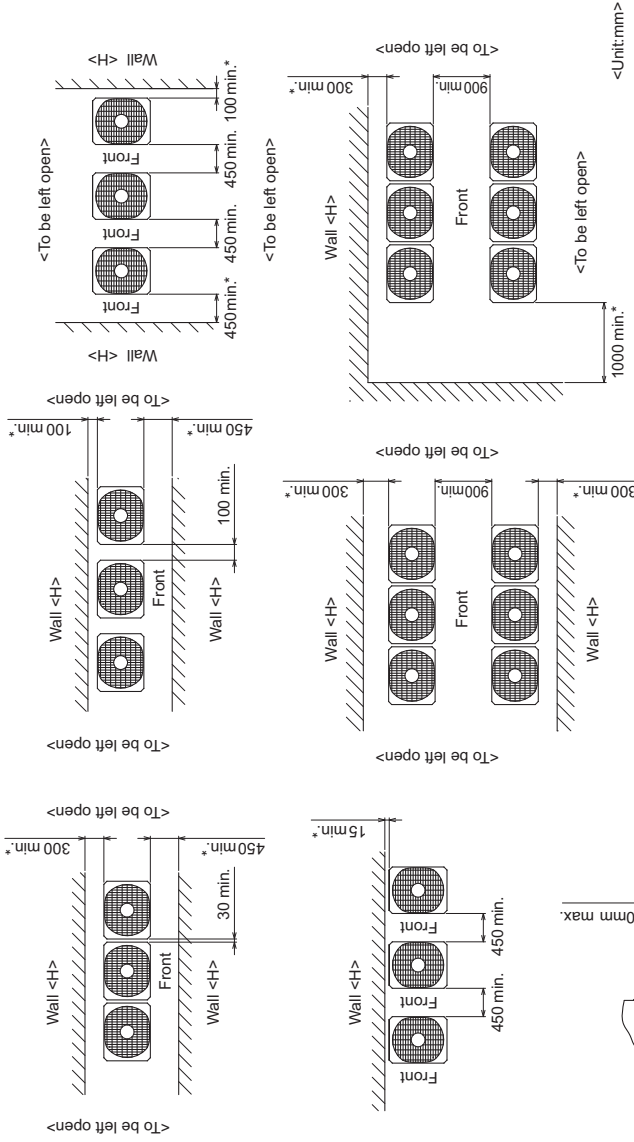

Fig.A (without detachable legs)

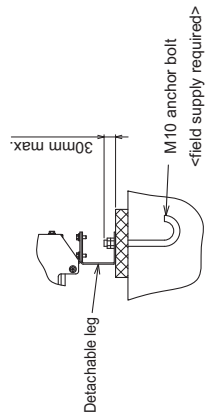

Fig.B (with detachable legs)



Fig.C (without detachable legs)

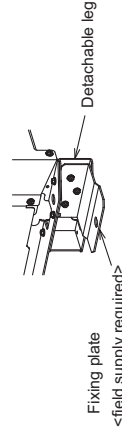
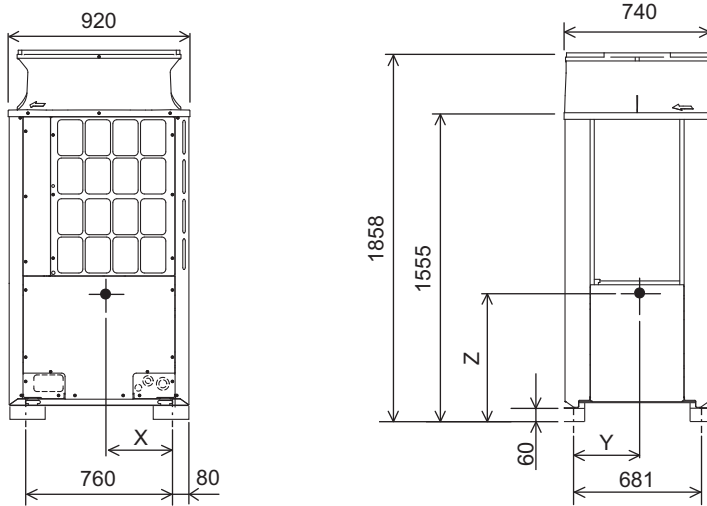

Fig.D (with detachable legs)

PURY-M200, 250, 300YNW-A (-BS)



Unit: mm

Model	X	Y	Z
PURY-M200YNW-A(-BS)	357	338	664
PURY-M250YNW-A(-BS)	357	338	664
PURY-M300YNW-A(-BS)	357	338	664

PURY-EM200, 250, 300YNW-A (-BS)

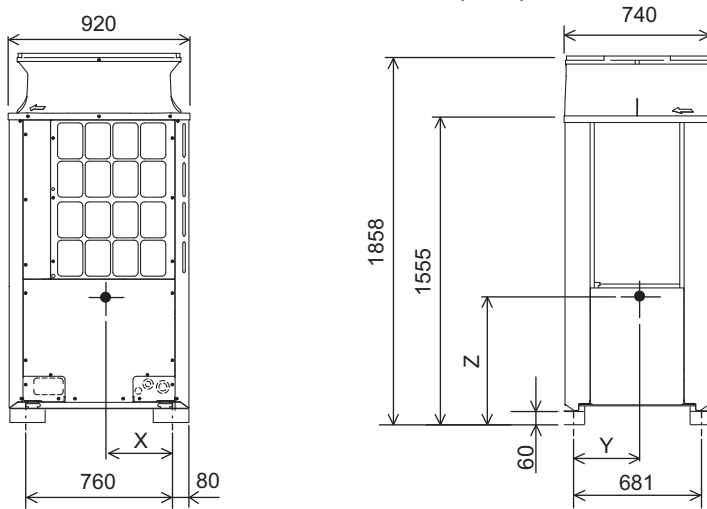

Unit: mm

Model	X	Y	Z
PURY-EM200YNW-A(-BS)	355	339	678
PURY-EM250YNW-A(-BS)	355	339	678
PURY-EM300YNW-A(-BS)	355	339	678

PURY-(E)M200, 250, 300YNW-A(-BS)

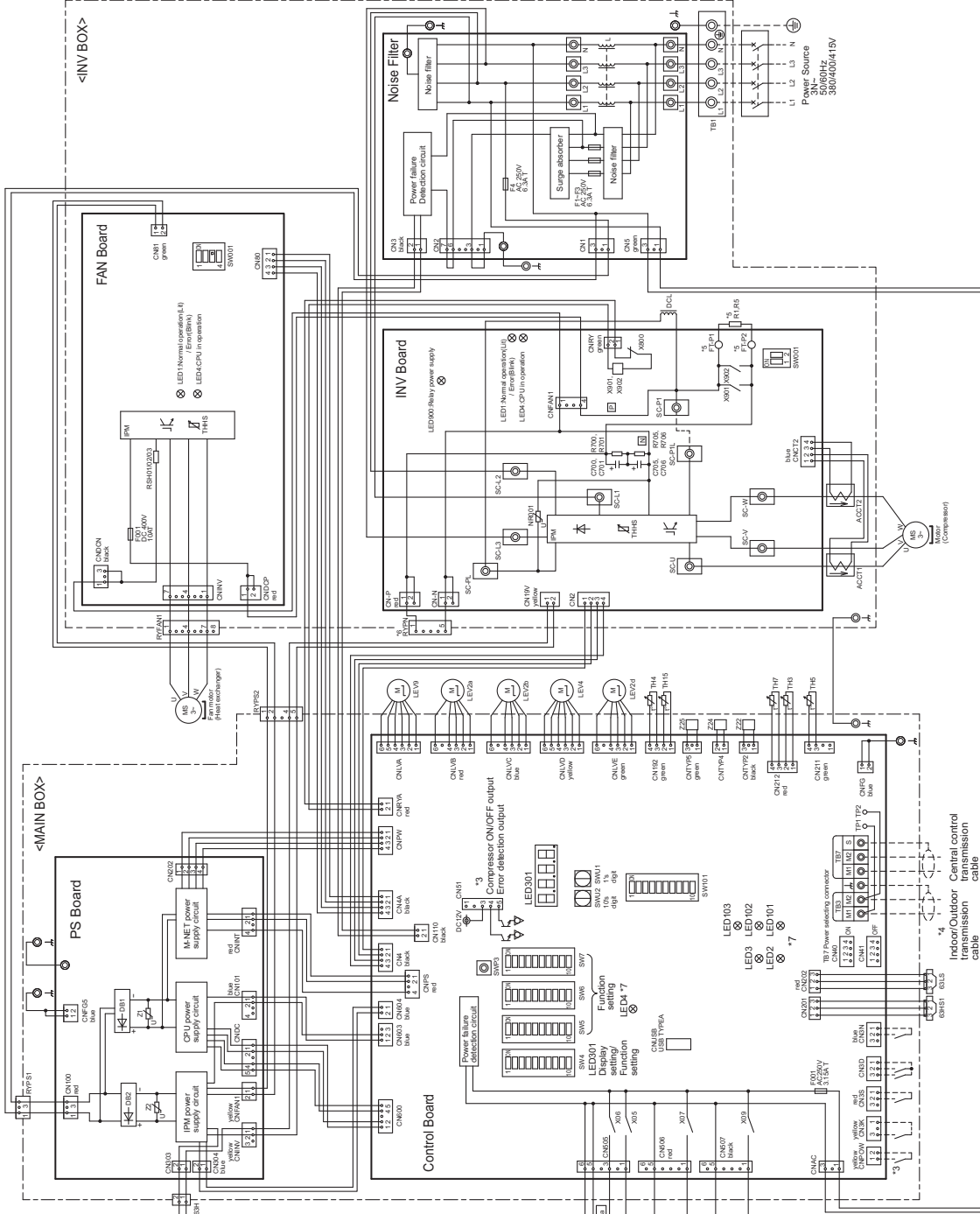

- \*1. Single-dotted lines indicate wiring not supplied with the unit.
- \*2. Dot-dash lines indicate the control box boundaries.
- \*3. Refer to the Data book for connecting input/output signal connectors.
- \*4. Daisy-chain terminals (TB3) on the outdoor units in the same refrigerant system together.
- \*5. Faston terminals have a locking function. Make sure the terminals are securely locked in place after insertion. Press the tab on the terminals to removed them.
- \*6. Control box houses high-voltage parts. Before inspecting the inside of the MAIN BOX or INV BOX, turn off the power, keep the unit off for at least 10 minutes, and confirm that the voltage of the connector RYPN on INV BOX has dropped to DC20V or less.
- \*7. Control board LED display.

LED3	Normal operation(L)/Error(Blink)
LED4	USB connection enable(L)/Disable(Unlit)
LED101	Normal operation(L)/Error(Unlit)
LED102	Normal operation(L)/Error(Blink) for central control transmission
LED103	Normal operation(L)/Error(Blink) for indoor/outdoor transmission

<Symbol explanation>

215A2b	4-way valve	Coil
215A4	Pressure switch	Heat exchanger switching
63H1	Pressure sensor	Cooling/Heating switching
63LS	Pressure sensor	High pressure protection for the outdoor unit
ACCT/AGCT2	Current sensor(AC)	Discharge pressure
C705/C706	Capacitor(inverter main circuit)	Low pressure
DCL	DC reactor	Compressor(inverter main circuit)
L	Choke coil (for high frequency noise reduction)	
LEV2a,b,d	Linear expansion valve	Pressure control, Refrigerant flow rate control
LEV9	Resistor	Compressor discharge temperature control
RT15	Subsoid valve	Heat exchanger for inverter
RSHD102/03	Switch	For inrush current prevention
SV1a	Valve	For opening/closing the bypass suction bypass
SV2	Valve	For opening/closing the discharge suction bypass
TB1	Terminal block	Power supply
TB3	Terminal block	Indoor/Outdoor transmission cable
TB7	Terminal block	Central control transmission cable
TH4	Thermistor	Pipe temperature
TH5	Thermistor	Discharge pipe temperature
TH6	Thermistor	ACC inlet pipe temperature
TH15	Thermistor	Compressor shell bottom temperature
THHS	Thermistor	IPM temperature
X801, X802	Magnetic relay(inverter main circuit)	
Z22, Z24, Z25	Function setting connector	

PURY-M-YNW-A, EM-YNW-A



5-1. Sound levels in cooling mode

PURY-M-YNW-A, EM-YNW-A

Measurement condition  
PURY-M200, 250, 300YNW-A(-BS)

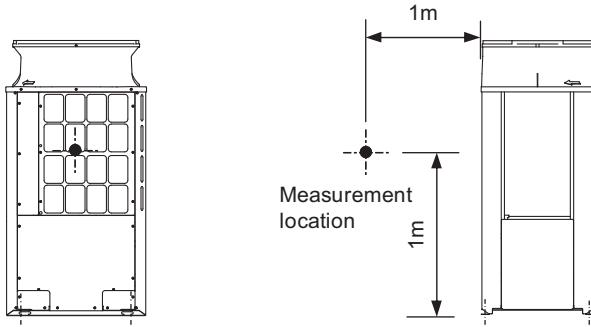

Sound level of PURY-M300YNW-A(-BS)

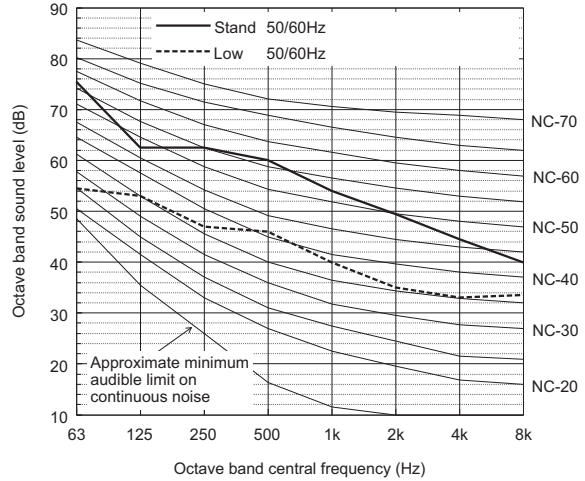

		63	125	250	500	1k	2k	4k	8k	dB(A)
Standard	50/60Hz	75.5	62.5	62.5	60.0	54.0	49.5	44.5	40.0	61.0
Low noise mode	50/60Hz	54.5	53.0	47.0	46.0	40.0	35.0	33.0	33.5	47.0

When Low noise mode is set, the A/C system's capacity is limited. The system could return to normal operation from Low noise mode automatically in the case that the operation condition is severe.

Sound level of PURY-M200YNW-A(-BS)

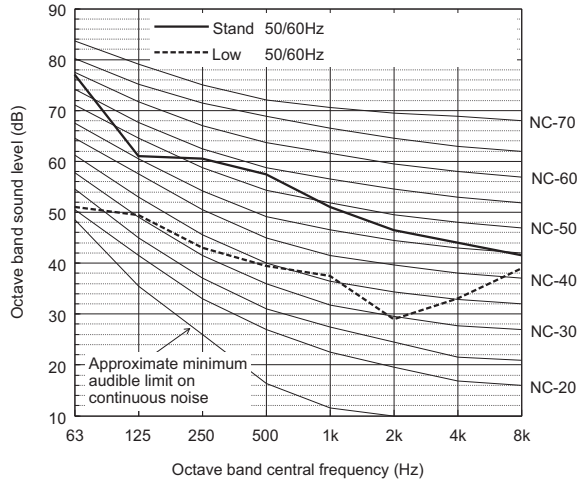

		63	125	250	500	1k	2k	4k	8k	dB(A)
Standard Cooling	50/60Hz	77.0	61.0	60.5	57.5	51.0	46.5	44.0	41.5	59.0
Low noise mode	50/60Hz	51.0	49.5	43.0	39.5	37.5	29.0	33.0	39.0	44.0

When Low noise mode is set, the A/C system's capacity is limited. The system could return to normal operation from Low noise mode automatically in the case that the operation condition is severe.

Sound level of PURY-M250YNW-A(-BS)

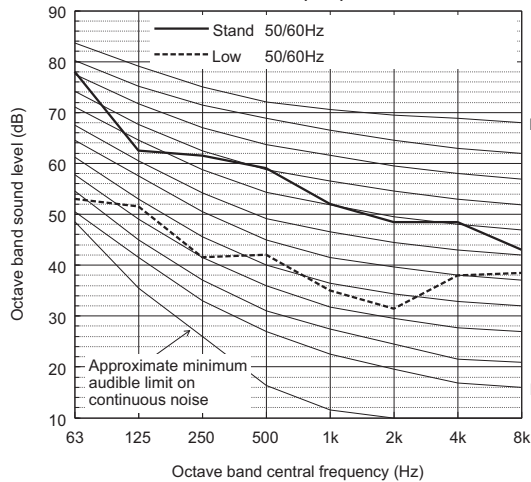

		63	125	250	500	1k	2k	4k	8k	dB(A)
Standard Cooling	50/60Hz	78.0	62.5	61.5	59.0	52.0	48.5	48.5	43.0	60.5
Low noise mode	50/60Hz	53.0	51.5	41.5	42.0	35.0	31.5	38.0	38.5	45.0

When Low noise mode is set, the A/C system's capacity is limited. The system could return to normal operation from Low noise mode automatically in the case that the operation condition is severe.

- Depending on the operation conditions, the unit generates noise caused by valve actuation, refrigerant flow, and pressure changes when operating normally. Please consider to avoid location where quietness is required. For HBC controller, it is recommended to be installed in places such as ceilings of corridor, rest rooms and plant rooms.



**Measurement condition**  
**PURY-EM200, 250, 300YNW-A(-BS)**

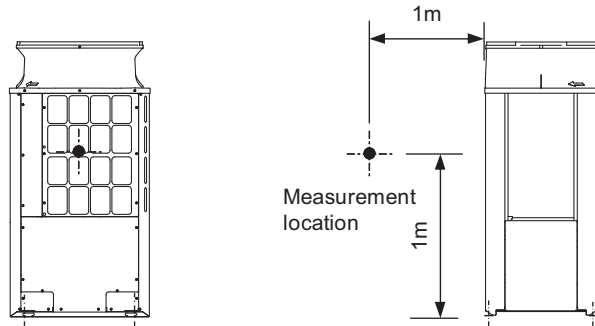

**Sound level of PURY-EM300YNW-A(-BS)**

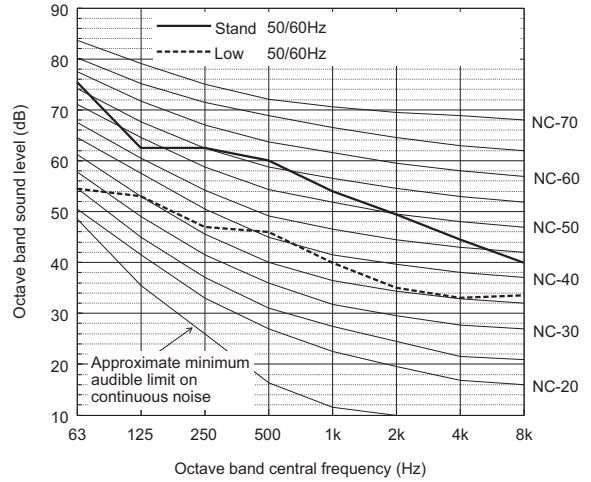

		63	125	250	500	1k	2k	4k	8k	dB(A)
Standard Cooling	50/60Hz	75.5	62.5	62.5	60.0	54.0	49.5	44.5	40.0	61.0
Low noise mode	50/60Hz	54.5	53.0	47.0	46.0	40.0	35.0	33.0	33.5	47.0

When Low noise mode is set, the A/C system's capacity is limited. The system could return to normal operation from Low noise mode automatically in the case that the operation condition is severe.

**Sound level of PURY-EM200YNW-A(-BS)**

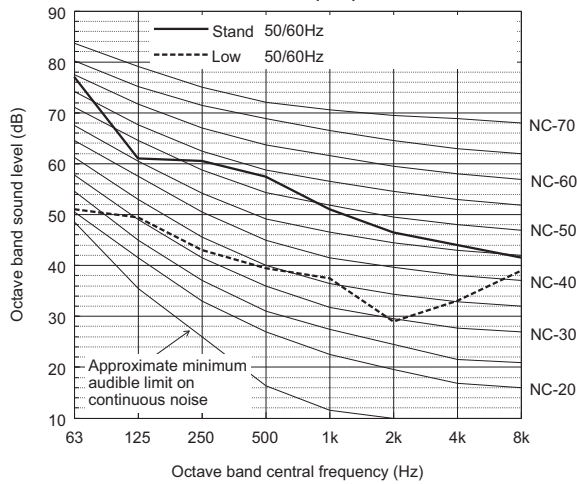

		63	125	250	500	1k	2k	4k	8k	dB(A)
Standard	50/60Hz	77.0	61.0	60.5	57.5	51.0	46.5	44.0	41.5	59.0
Low noise mode	50/60Hz	51.0	49.5	43.0	39.5	37.5	29.0	33.0	39.0	44.0

When Low noise mode is set, the A/C system's capacity is limited. The system could return to normal operation from Low noise mode automatically in the case that the operation condition is severe.

**Sound level of PURY-EM250YNW-A(-BS)**

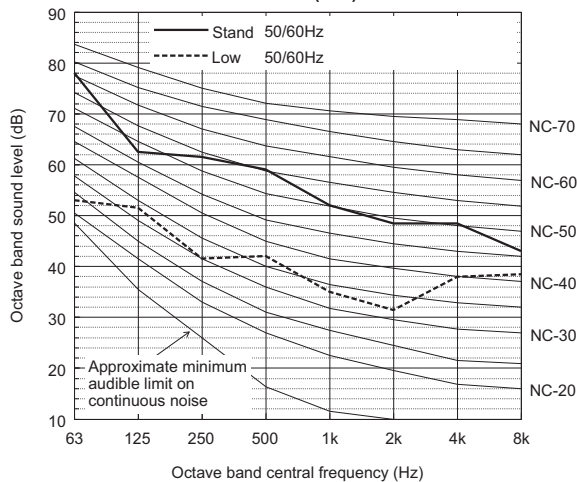

		63	125	250	500	1k	2k	4k	8k	dB(A)
Standard	50/60Hz	78.0	62.5	61.5	59.0	52.0	48.5	48.5	43.0	60.5
Low noise mode	50/60Hz	53.0	51.5	41.5	42.0	35.0	31.5	38.0	38.5	45.0

When Low noise mode is set, the A/C system's capacity is limited. The system could return to normal operation from Low noise mode automatically in the case that the operation condition is severe.

- ◆ Depending on the operation conditions, the unit generates noise caused by valve actuation, refrigerant flow, and pressure changes when operating normally. Please consider to avoid location where quietness is required. For HBC controller, it is recommended to be installed in places such as ceilings of corridor, rest rooms and plant rooms.

5-2. Sound levels in heating mode

Measurement condition  
 PURY-M200, 250, 300YNW-A(-BS)

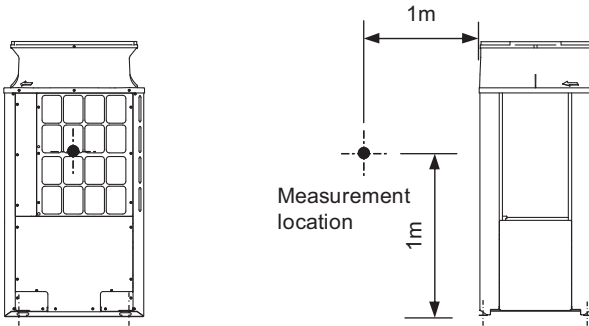

Sound level of PURY-M300YNW-A(-BS)

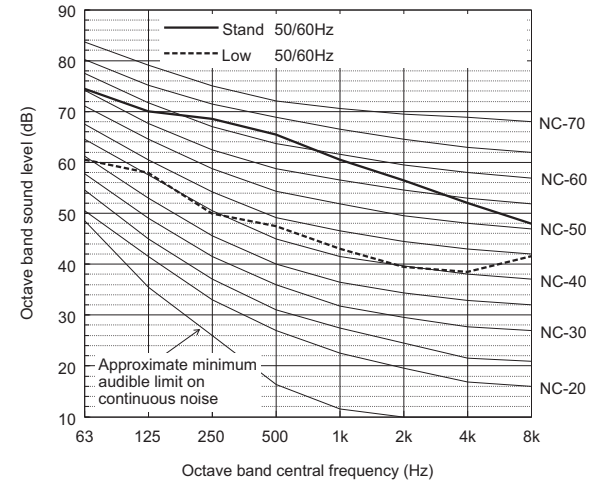

		63	125	250	500	1k	2k	4k	8k	dB(A)
Standard Heating	50/60Hz	74.5	70.0	68.5	65.5	60.5	56.5	52.0	48.0	67.0
Low noise mode	50/60Hz	60.5	58.0	50.0	47.5	43.0	39.5	38.5	41.5	50.5

When Low noise mode is set, the A/C system's capacity is limited. The system could return to normal operation from Low noise mode automatically in the case that the operation condition is severe.

Sound level of PURY-M200YNW-A(-BS)

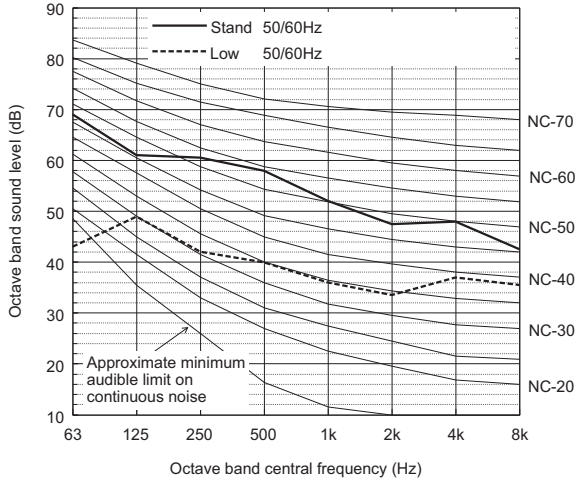

		63	125	250	500	1k	2k	4k	8k	dB(A)
Standard Heating	50/60Hz	69.0	61.0	60.5	58.0	52.0	47.5	48.0	42.5	59.0
Low noise mode	50/60Hz	43.0	49.0	42.0	40.0	36.0	33.5	37.0	35.5	44.0

When Low noise mode is set, the A/C system's capacity is limited. The system could return to normal operation from Low noise mode automatically in the case that the operation condition is severe.

Sound level of PURY-M250YNW-A(-BS)

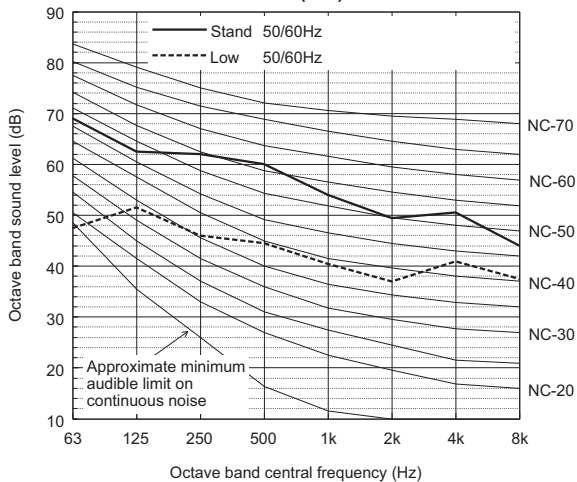

		63	125	250	500	1k	2k	4k	8k	dB(A)
Standard Heating	50/60Hz	69.0	62.5	62.0	60.0	54.0	49.5	50.5	44.0	61.0
Low noise mode	50/60Hz	47.5	51.5	46.0	44.5	40.5	37.0	41.0	37.5	48.0

When Low noise mode is set, the A/C system's capacity is limited. The system could return to normal operation from Low noise mode automatically in the case that the operation condition is severe.

- Depending on the operation conditions, the unit generates noise caused by valve actuation, refrigerant flow, and pressure changes when operating normally. Please consider to avoid location where quietness is required.
- For HBC controller, it is recommended to be installed in places such as ceilings of corridor, rest rooms and plant rooms.

**Measurement condition**  
**PURY-EM200, 250, 300YNW-A(-BS)**

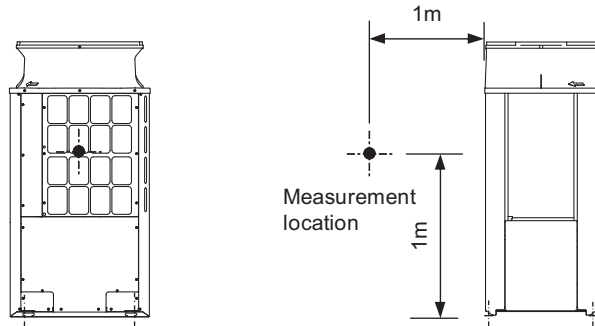

**Sound level of PURY-EM300YNW-A(-BS)**

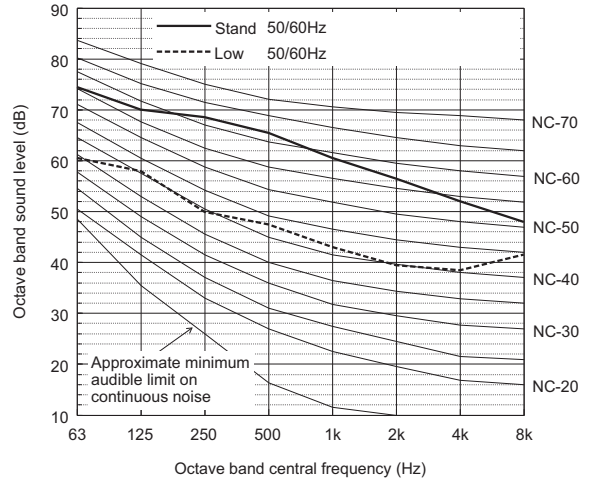

		63	125	250	500	1k	2k	4k	8k	dB(A)
Standard Heating	50/60Hz	74.5	70.0	68.5	65.5	60.5	56.5	52.0	48.0	67.0
Low noise mode	50/60Hz	60.5	58.0	50.0	47.5	43.0	39.5	38.5	41.5	50.5

When Low noise mode is set, the A/C system's capacity is limited. The system could return to normal operation from Low noise mode automatically in the case that the operation condition is severe.

**Sound level of PURY-EM200YNW-A(-BS)**

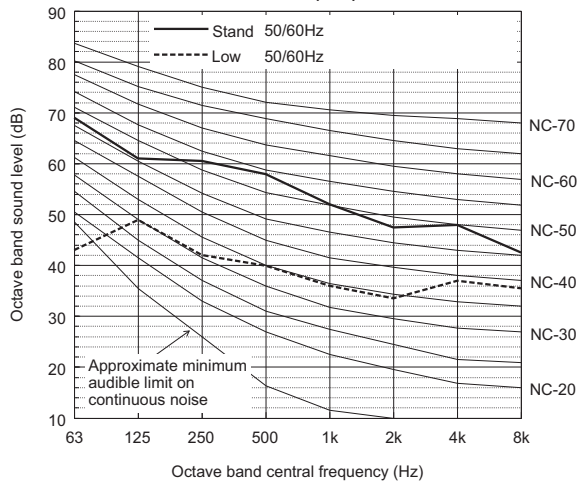

		63	125	250	500	1k	2k	4k	8k	dB(A)
Standard Heating	50/60Hz	69.0	61.0	60.5	58.0	52.0	47.5	48.0	42.5	59.0
Low noise mode	50/60Hz	43.0	49.0	42.0	40.0	36.0	33.5	37.0	35.5	44.0

When Low noise mode is set, the A/C system's capacity is limited. The system could return to normal operation from Low noise mode automatically in the case that the operation condition is severe.

**Sound level of PURY-EM250YNW-A(-BS)**

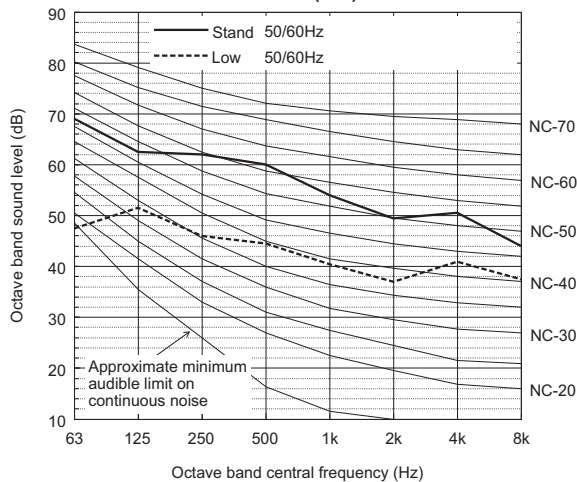

		63	125	250	500	1k	2k	4k	8k	dB(A)
Standard Heating	50/60Hz	69.0	62.5	62.0	60.0	54.0	49.5	50.5	44.0	61.0
Low noise mode	50/60Hz	47.5	51.5	46.0	44.5	40.5	37.0	41.0	37.5	48.0

When Low noise mode is set, the A/C system's capacity is limited. The system could return to normal operation from Low noise mode automatically in the case that the operation condition is severe.

- ◆ Depending on the operation conditions, the unit generates noise caused by valve actuation, refrigerant flow, and pressure changes when operating normally. Please consider to avoid location where quietness is required. For HBC controller, it is recommended to be installed in places such as ceilings of corridor, rest rooms and plant rooms.

**[PURY-M200-300YNW, PURY-EM200-300YNW]**

## Measurement condition

Measurement frequency: 1 Hz-80 Hz

Measurement point: Ground surface 20 cm away from the unit leg

Installation condition: Direct installation on the concrete floor

Power source: 3-phase 4-wire 380-400-415 V 50/60 Hz

Operation condition: JIS condition (cooling, heating)

Measurement device: Vibration level meter for vibration pollution VM-1220C (JIS-compliant product)

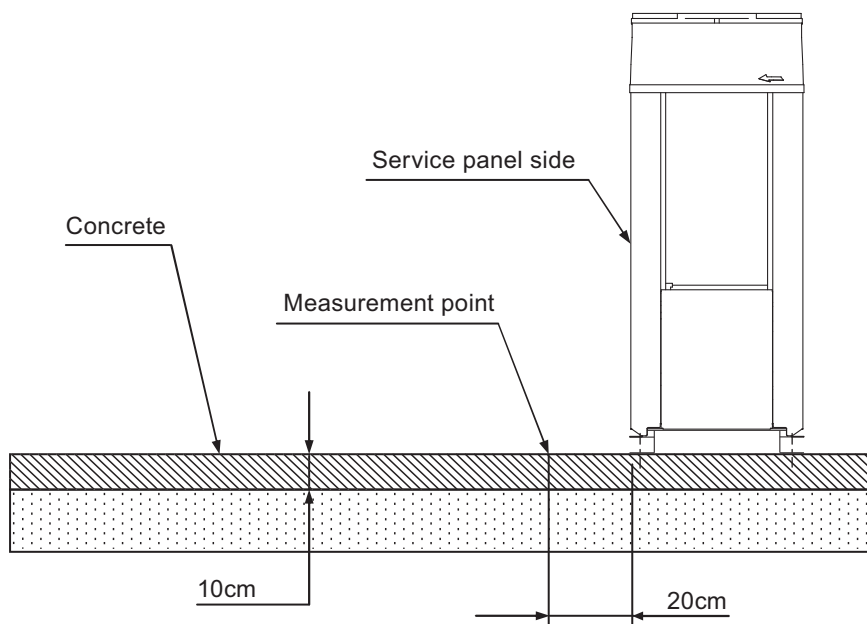

## Vibration level

Model	Vibration level (dB)
PURY-M200YNW-A (-BS)	45
PURY-M250YNW-A (-BS)	46
PURY-M300YNW-A (-BS)	47
PURY-EM200YNW-A (-BS)	45
PURY-EM250YNW-A (-BS)	46
PURY-EM300YNW-A (-BS)	47

\* Vibration level varies depending on the conditions of actual installation site.

• Cooling only

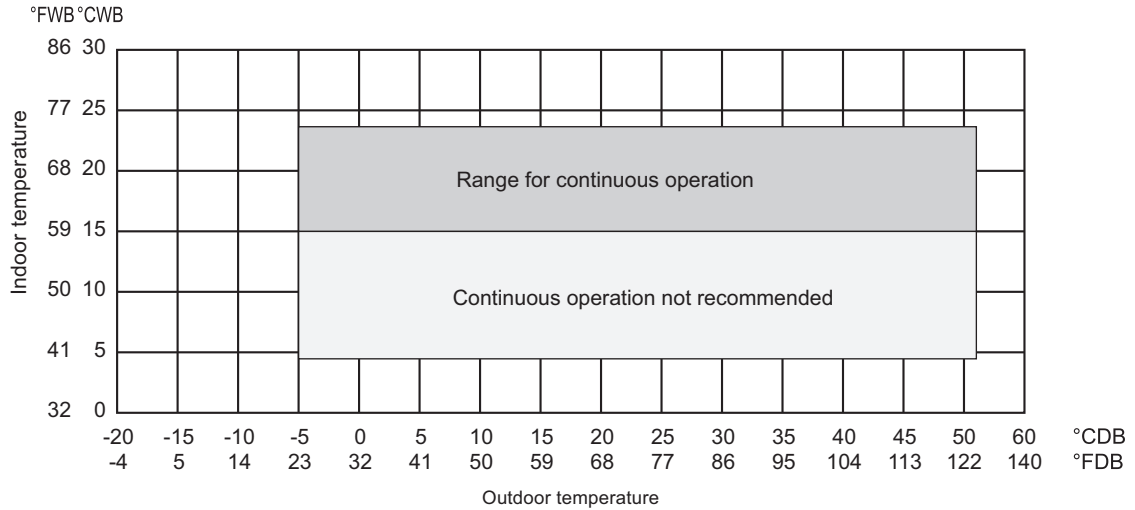

• Heating only

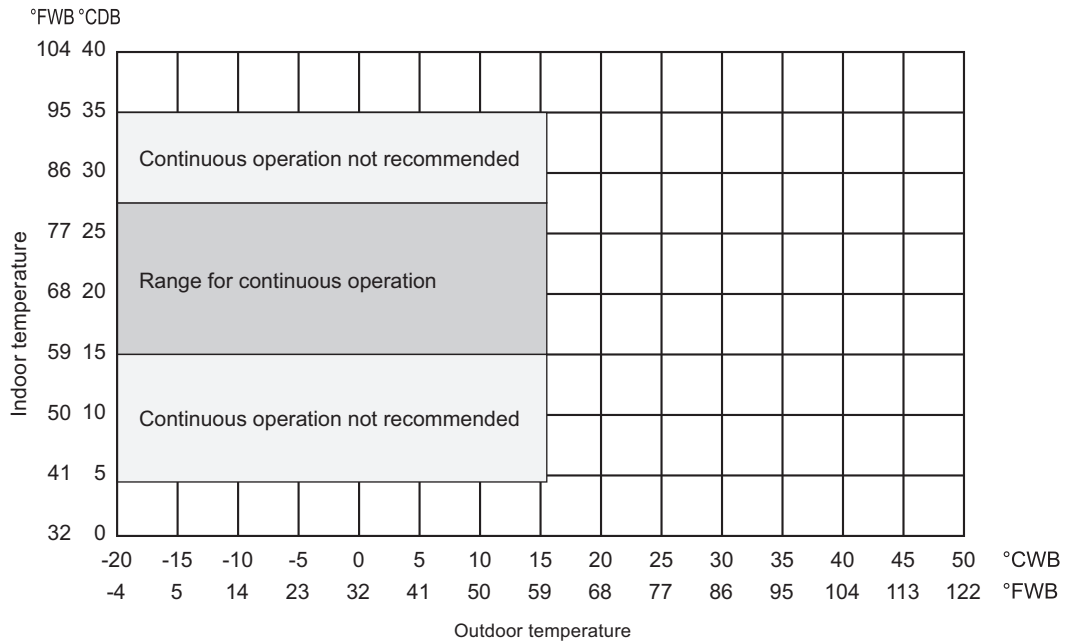

• Combination of cooling/heating operation (Cooling main or Heating main)

Outdoor temperature	Indoor temperature	
	Cooling	Heating
-10 to 21°CDB (14 to 70°FDB)	—	15 to 27°CDB (59 to 81°FDB)
-11 to 15.5°CWB (12.2 to 60°FWB)	15 to 24°CWB (59 to 75°FWB)	—

8-1. Correction by temperature

HYBRID CITY MULTI could have varied capacity at different designing temperature. Using the nominal cooling/heating capacity value and the ratio below, the capacity can be observed at various temperature.

PURY-		M200YNW-A	M250YNW-A
Nominal Cooling Capacity	kW	22.4	28.0
	BTU/h	76,400	95,500
Input	kW	6.85	9.92

PURY-		EM200YNW-A	EM250YNW-A
Nominal Cooling Capacity	kW	22.4	28.0
	BTU/h	76,400	95,500
Input	kW	6.15	8.77

Indoor unit temperature correction

To be used to correct indoor unit capacity only

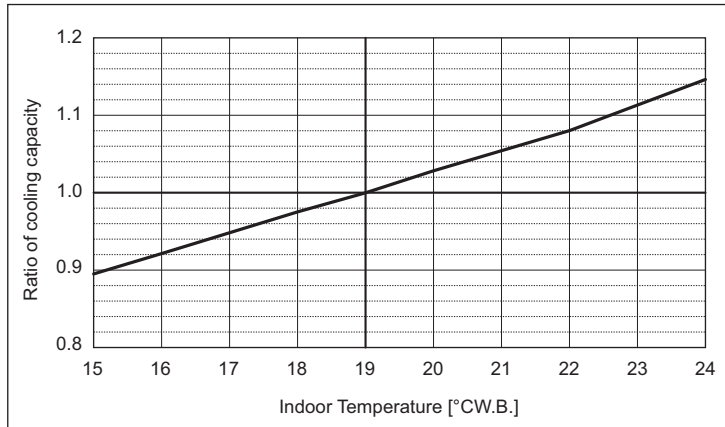

Outdoor unit temperature correction

To be used to correct outdoor unit only

Outdoor unit capacity is NOT affected by the indoor temperature.

Outdoor unit power input is affected by the indoor and outdoor temperatures. Please consult the sales office for details.

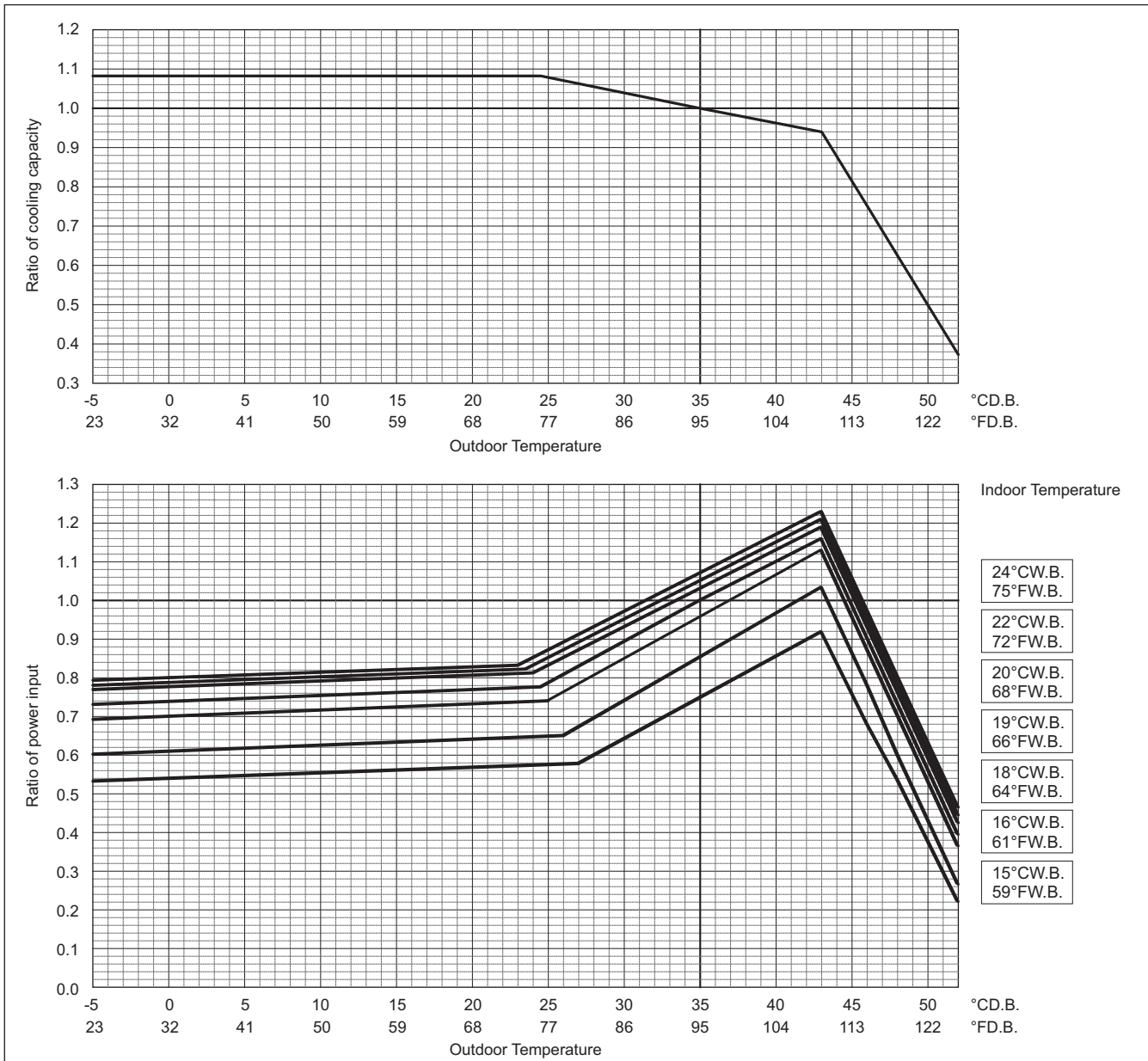

PURY-M-YNW-A, EM-YNW-A

	PURY-	M200YNW-A	M250YNW-A
Nominal Heating Capacity	kW	25.0	31.5
	BTU/h	85,300	107,500
Input	kW	6.94	10.06

	PURY-	EM200YNW-A	EM250YNW-A
Nominal Heating Capacity	kW	25.0	31.5
	BTU/h	85,300	107,500
Input	kW	6.77	9.84

**Indoor unit temperature correction**

To be used to correct indoor unit capacity only

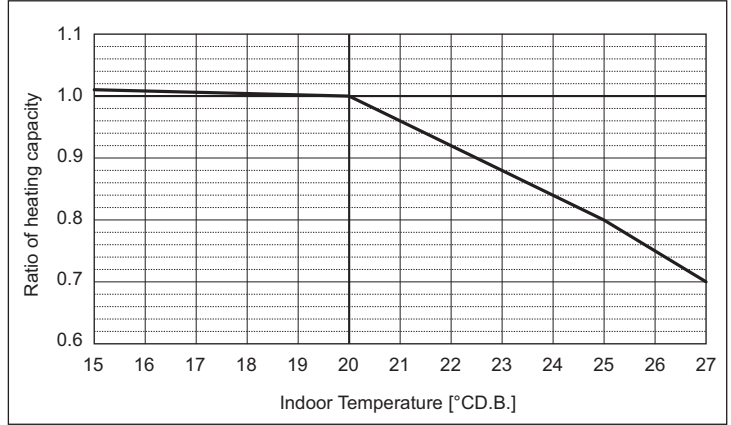

**Outdoor unit temperature correction**

To be used to correct outdoor unit only

Outdoor unit capacity is NOT affected by the indoor temperature.

Outdoor unit power input is affected by the indoor and outdoor temperatures. Please consult the sales office for details.

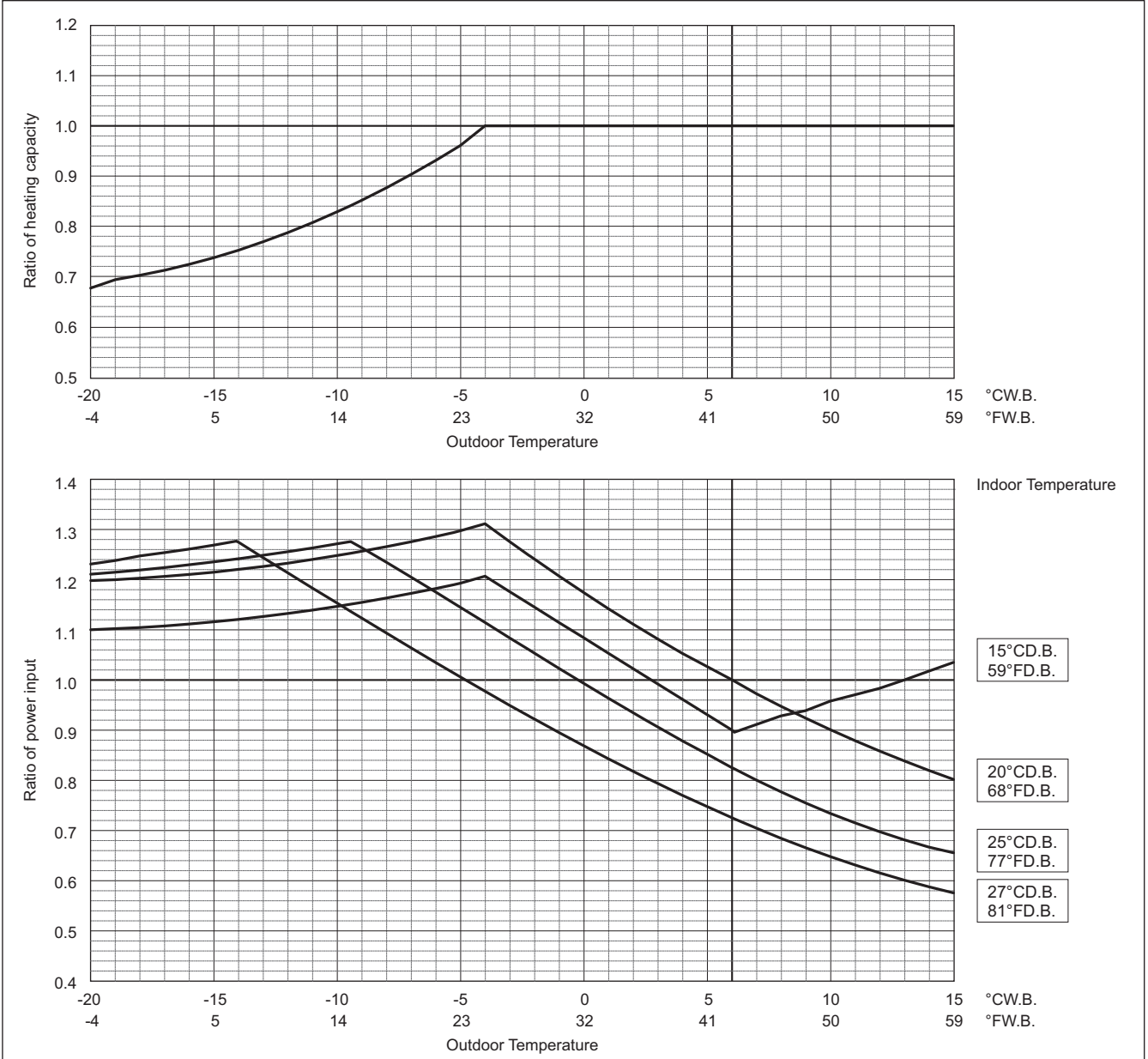

PURY-M-YNW-A, EM-YNW-A



PURY-		M300YNW-A
Nominal Cooling Capacity	kW	33.5
	BTU/h	114,300
Input	kW	11.09

PURY-		EM300YNW-A
Nominal Cooling Capacity	kW	33.5
	BTU/h	114,300
Input	kW	10.02

**Indoor unit temperature correction**  
To be used to correct indoor unit capacity only

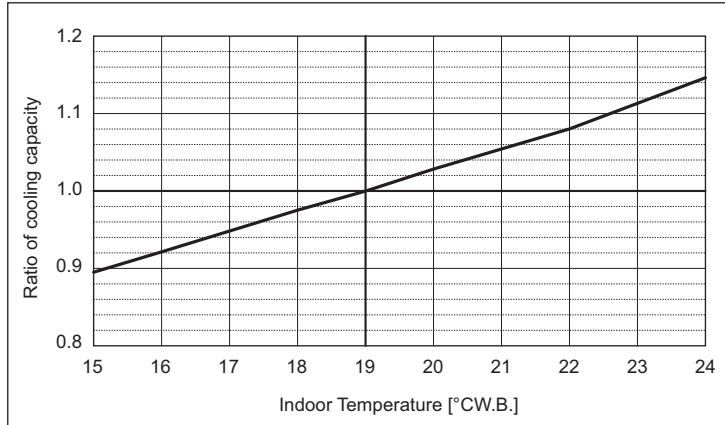

**Outdoor unit temperature correction**

To be used to correct outdoor unit only

Outdoor unit capacity is NOT affected by the indoor temperature.

Outdoor unit power input is affected by the indoor and outdoor temperatures. Please consult the sales office for details.

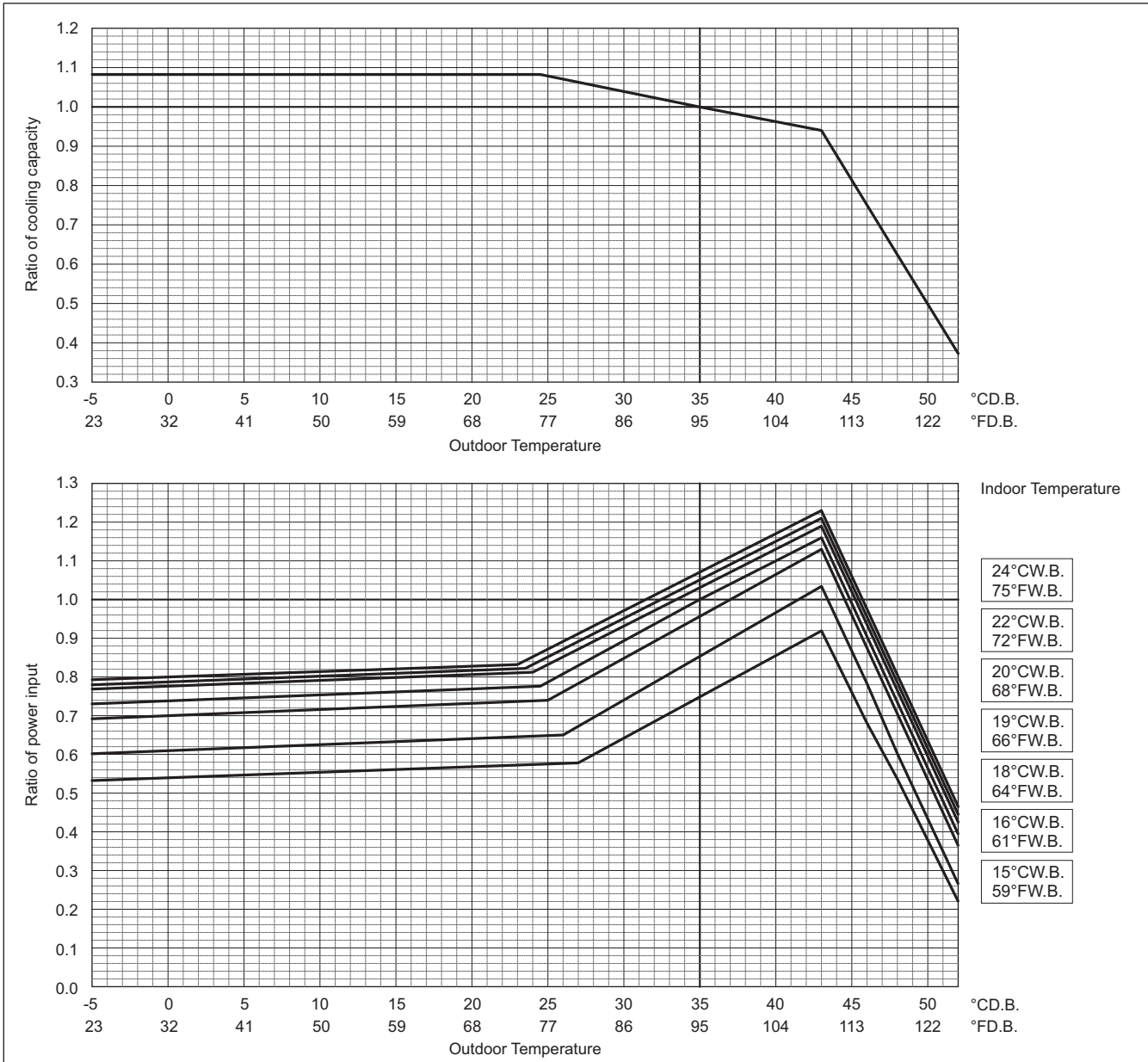



<b>PURY-</b>		<b>M300YNW-A</b>
Nominal Heating Capacity	kW	37.5
	BTU/h	128,000
Input	kW	11.68
<b>PURY-</b>		<b>EM300YNW-A</b>
Nominal Heating Capacity	kW	37.5
	BTU/h	128,000
Input	kW	10.90

**Indoor unit temperature correction**  
To be used to correct indoor unit capacity only

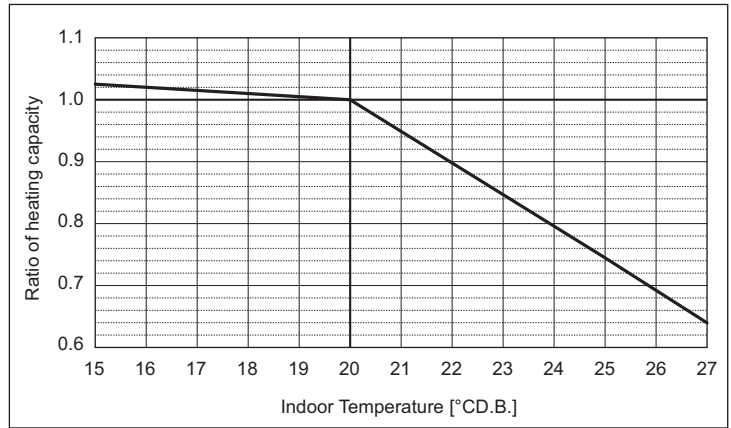

**Outdoor unit temperature correction**

To be used to correct outdoor unit only  
Outdoor unit capacity is NOT affected by the indoor temperature.  
Outdoor unit power input is affected by the indoor and outdoor temperatures. Please consult the sales office for details.

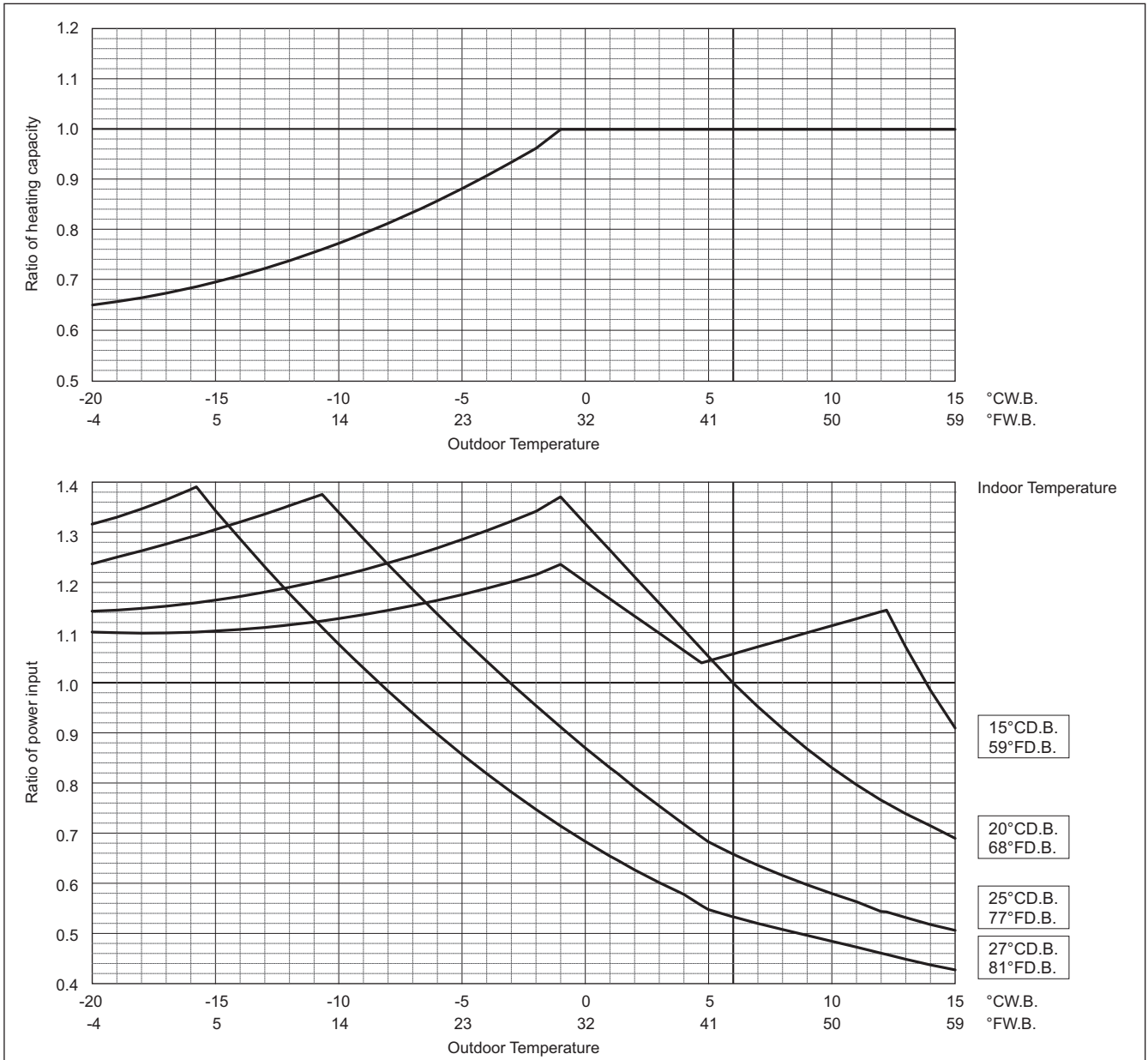

PURY-M-YNW-A, EM-YNW-A

**Correction by temperature (COP Priority Mode)**

HYBRID CITY MULTI could have various capacities at different designing temperatures. Using the nominal cooling/heating capacity values and the ratios below, the capacity can be found for various temperatures.

To select COP priority mode, SW4 (935) must be set to ON.

PURY-		M200YNW-A	M250YNW-A
Nominal Cooling Capacity	kW	22.4	28.0
	BTU/h	76,400	95,500
Input	kW	6.85	9.92

PURY-		EM200YNW-A	EM250YNW-A
Nominal Cooling Capacity	kW	22.4	28.0
	BTU/h	76,400	95,500
Input	kW	6.15	8.77

**Indoor unit temperature correction**

To be used to correct indoor unit capacity only

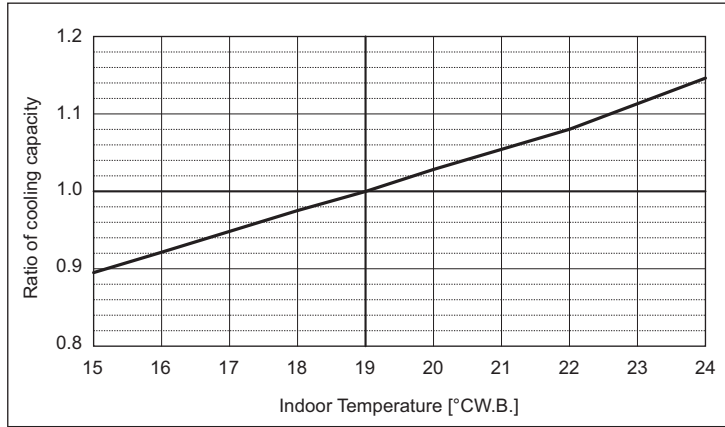

**Outdoor unit temperature correction**

To be used to correct outdoor unit only

Outdoor unit capacity is NOT affected by the indoor temperature.

Outdoor unit power input is affected by the indoor and outdoor temperatures. Please consult the sales office for details.

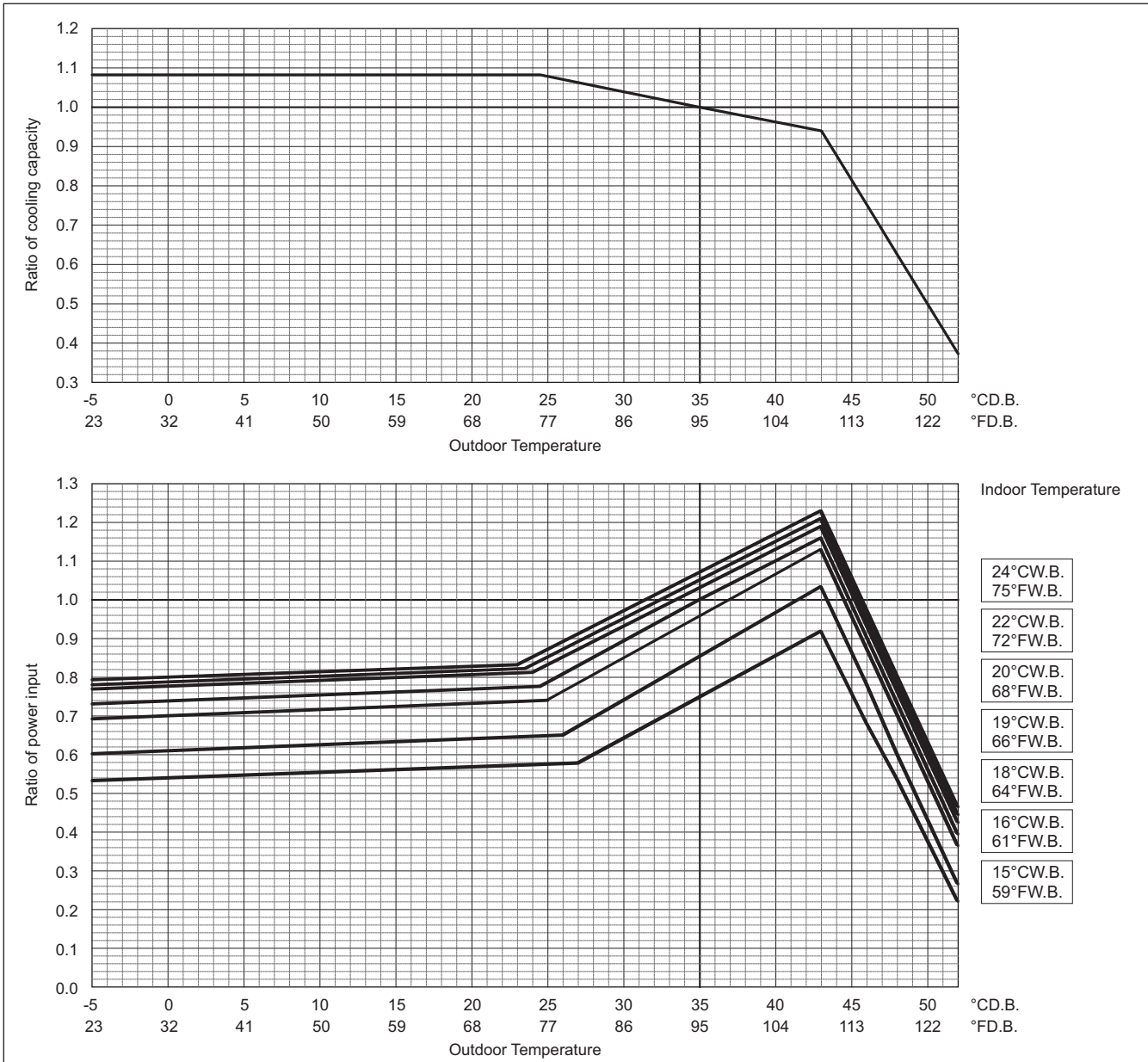

PURY-M-YNW-A, EM-YNW-A

COP Priority Mode

PURY-		M200YNW-A	M250YNW-A
Nominal Heating Capacity	kW	25.0	31.5
	BTU/h	85,300	107,500
Input	kW	6.94	10.06

PURY-		EM200YNW-A	EM250YNW-A
Nominal Heating Capacity	kW	25.0	31.5
	BTU/h	85,300	107,500
Input	kW	6.77	9.84

Indoor unit temperature correction

To be used to correct indoor unit capacity only

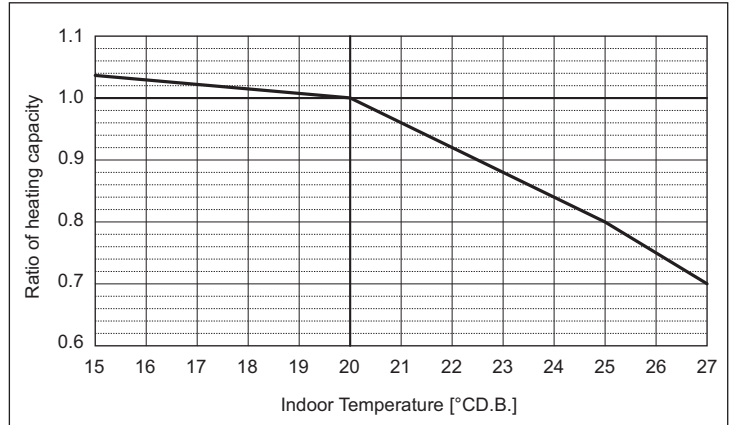

Outdoor unit temperature correction

To be used to correct outdoor unit only

Outdoor unit capacity is NOT affected by the indoor temperature.

Outdoor unit power input is affected by the indoor and outdoor temperatures. Please consult the sales office for details.

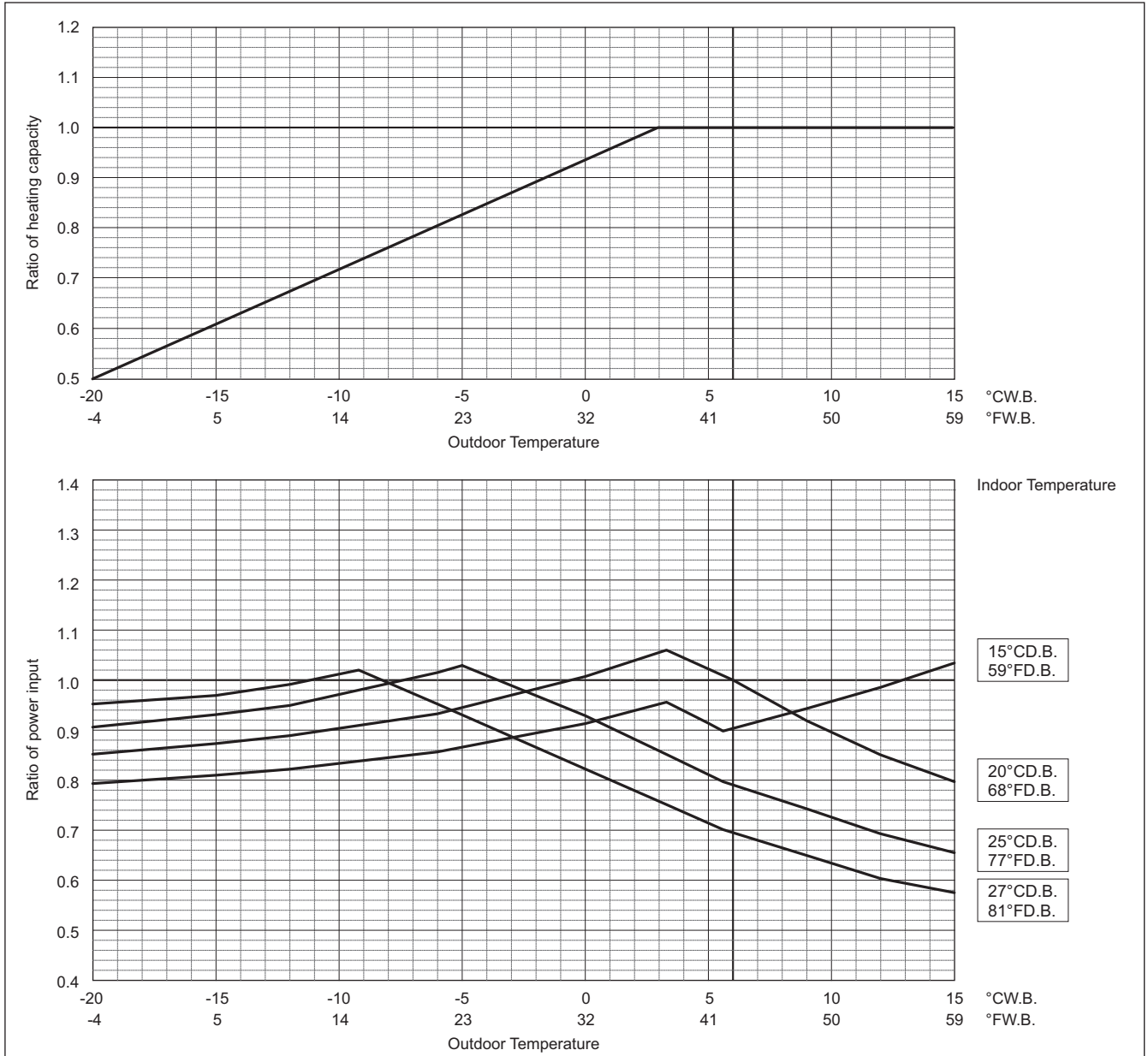

PURY-M-YNW-A, EM-YNW-A

PURY-M-YNW-A, EM-YNW-A

PURY-		M300YNW-A
Nominal Cooling Capacity	kW	33.5
	BTU/h	114,300
Input	kW	13.08

PURY-		EM300YNW-A
Nominal Cooling Capacity	kW	33.5
	BTU/h	114,300
Input	kW	11.79

**Indoor unit temperature correction**  
To be used to correct indoor unit capacity only

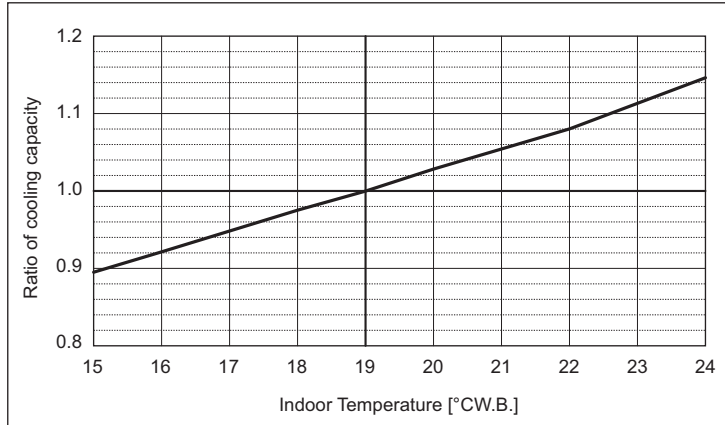

**Outdoor unit temperature correction**

To be used to correct outdoor unit only

Outdoor unit capacity is NOT affected by the indoor temperature.

Outdoor unit power input is affected by the indoor and outdoor temperatures. Please consult the sales office for details.

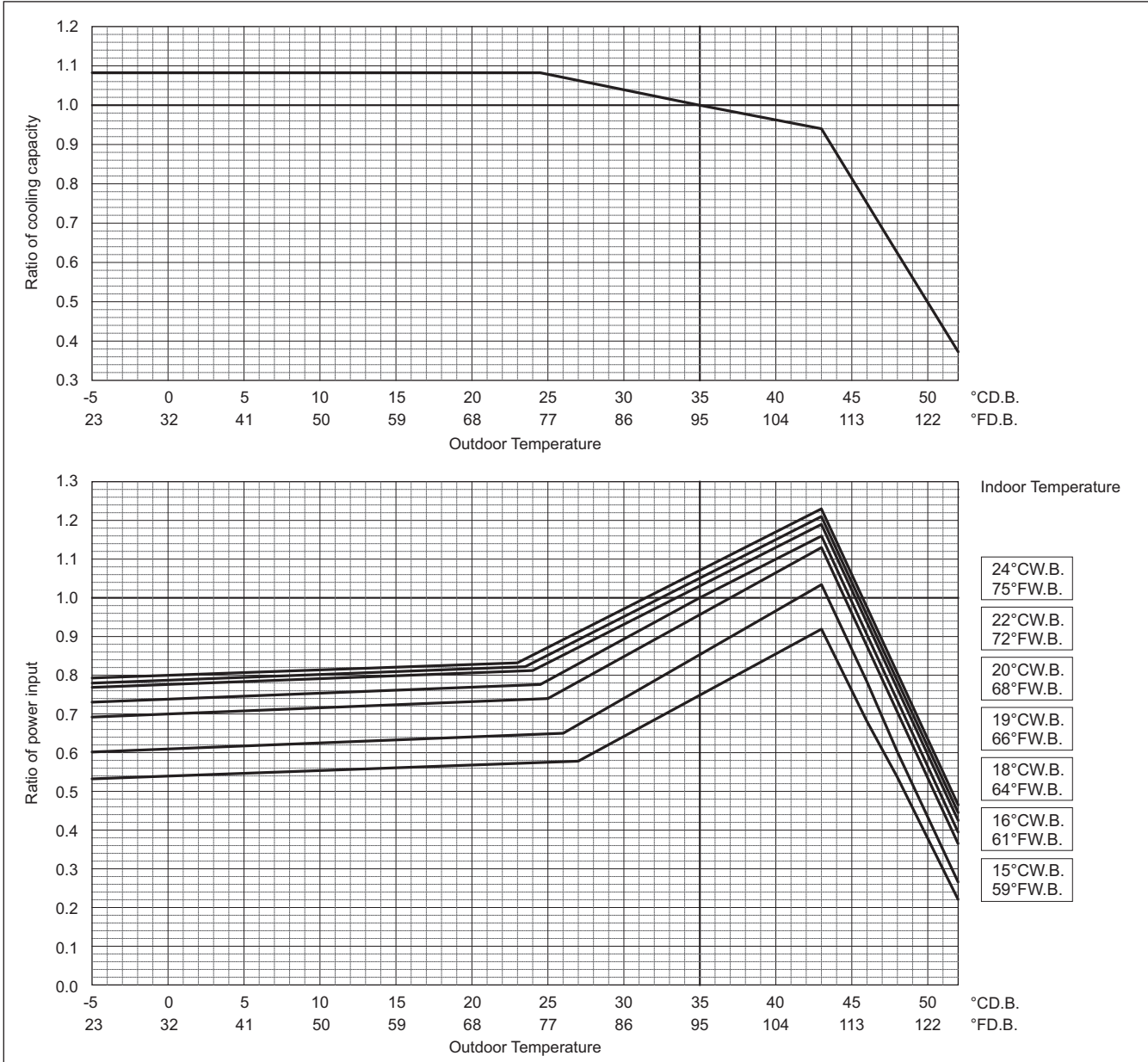

COP Priority Mode

PURY-		M300YNW-A
Nominal Heating Capacity	kW	37.5
	BTU/h	128,000
Input	kW	11.68

PURY-		EM300YNW-A
Nominal Heating Capacity	kW	37.5
	BTU/h	128,000
Input	kW	10.90

Indoor unit temperature correction

To be used to correct indoor unit capacity only

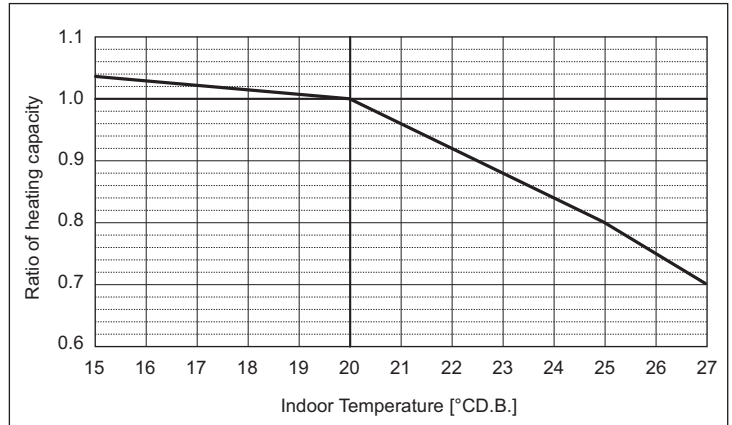

Outdoor unit temperature correction

To be used to correct outdoor unit only

Outdoor unit capacity is NOT affected by the indoor temperature.

Outdoor unit power input is affected by the indoor and outdoor temperatures. Please consult the sales office for details.

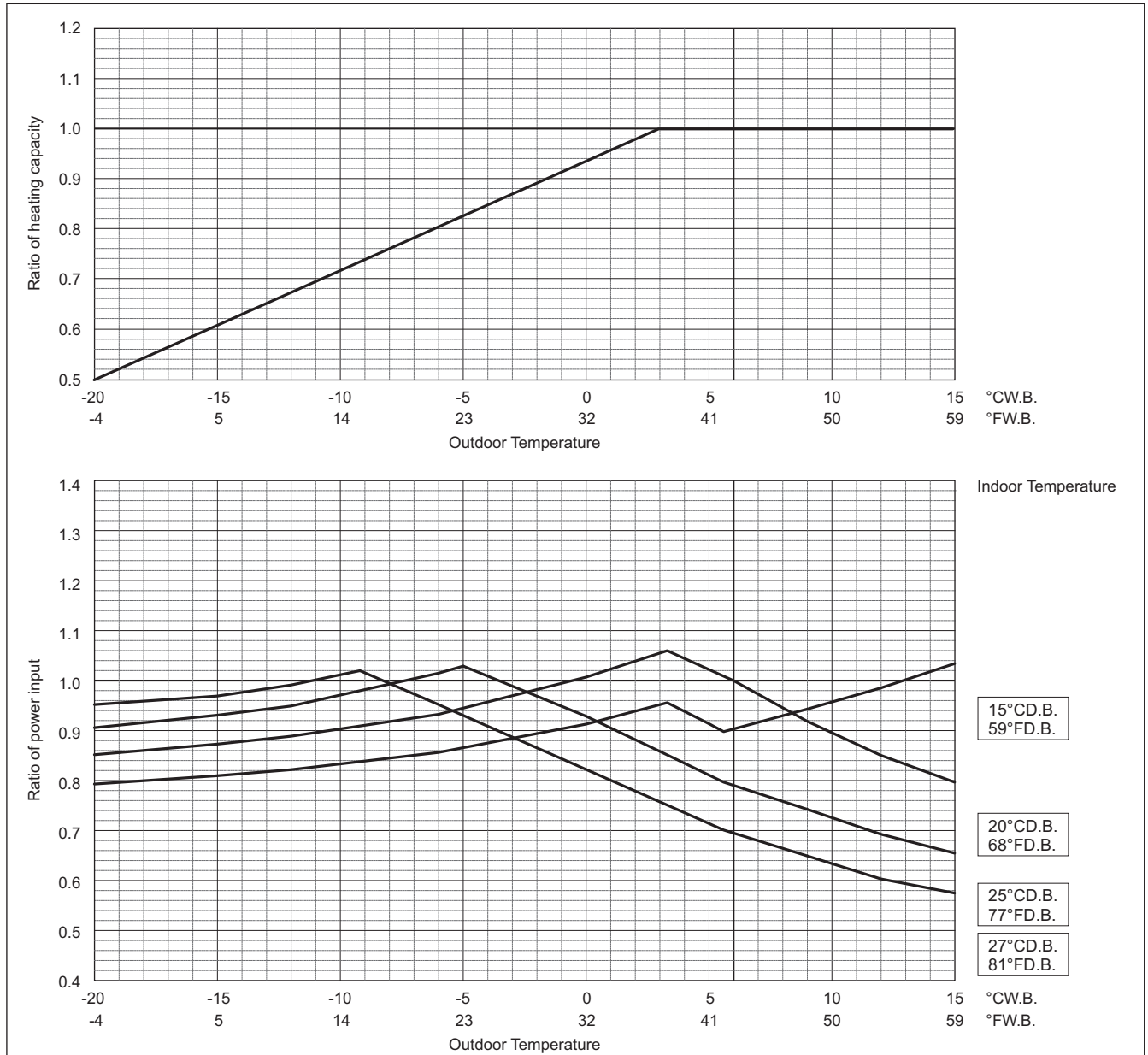

PURY-M-YNW-A, EM-YNW-A



8-2. Correction by total indoor

HYBRID CITY MULTI system has different capacities and inputs when many combinations of indoor units with different total capacities are connected. Using following tables, the maximum capacity can be found to ensure the system is installed with enough capacity for a particular application.

PURY-M-YNW-A, EM-YNW-A

PURY-M200YNW-A		
Nominal Cooling Capacity	kW	22.4
	BTU/h	76,400
Input	kW	6.85

PURY-M200YNW-A		
Nominal Heating Capacity	kW	25.0
	BTU/h	85,300
Input	kW	6.94

PURY-EM200YNW-A		
Nominal Cooling Capacity	kW	22.4
	BTU/h	76,400
Input	kW	6.15

PURY-EM200YNW-A		
Nominal Heating Capacity	kW	25.0
	BTU/h	85,300
Input	kW	6.77

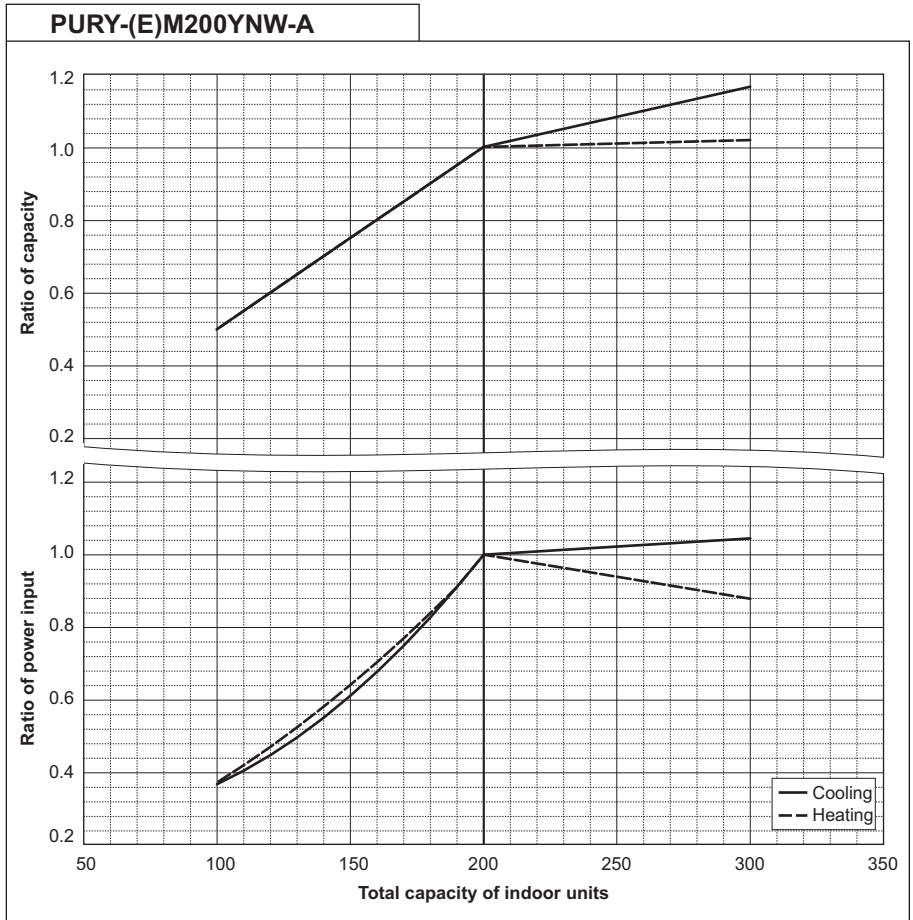

PURY-M250YNW-A		
Nominal Cooling Capacity	kW	28.0
	BTU/h	95,500
Input	kW	9.92

PURY-M250YNW-A		
Nominal Heating Capacity	kW	31.5
	BTU/h	107,500
Input	kW	10.06

PURY-EM250YNW-A		
Nominal Cooling Capacity	kW	28.0
	BTU/h	95,500
Input	kW	8.77

PURY-EM250YNW-A		
Nominal Heating Capacity	kW	31.5
	BTU/h	107,500
Input	kW	9.84

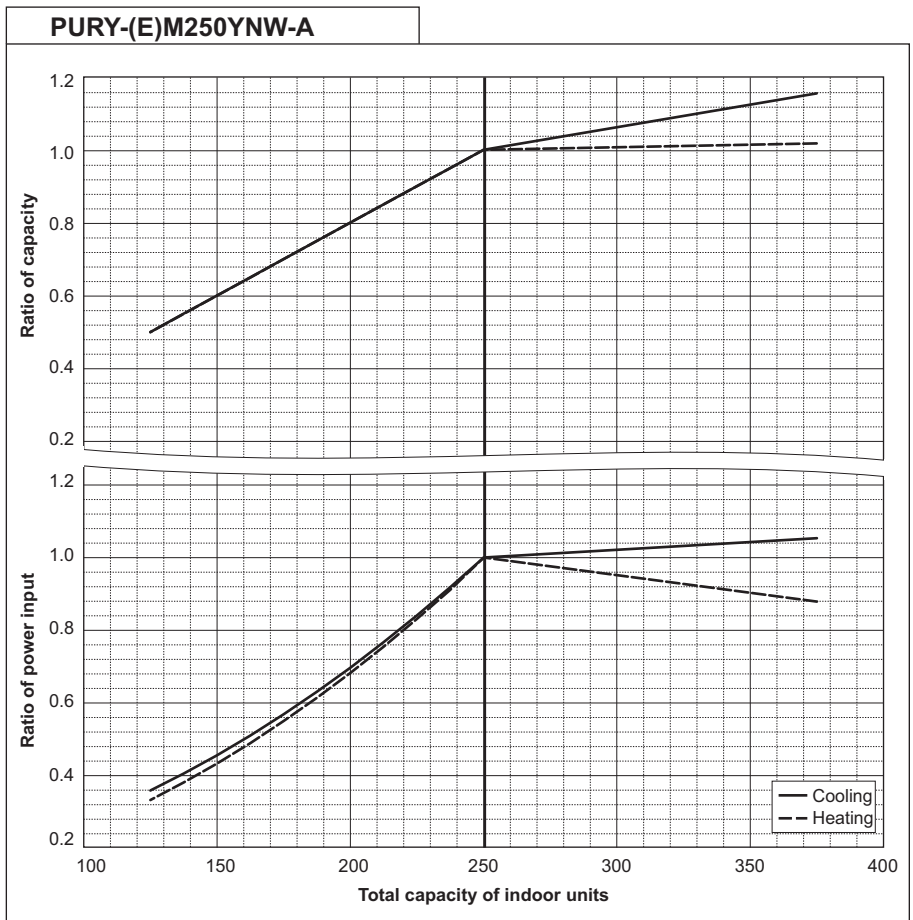

PURY-M300YNW-A		
Nominal Cooling Capacity	kW	33.5
	BTU/h	114,300
Input	kW	11.09

PURY-M300YNW-A		
Nominal Heating Capacity	kW	37.5
	BTU/h	128,000
Input	kW	11.68

PURY-EM300YNW-A		
Nominal Cooling Capacity	kW	33.5
	BTU/h	114,300
Input	kW	10.02

PURY-EM300YNW-A		
Nominal Heating Capacity	kW	37.5
	BTU/h	128,000
Input	kW	10.90

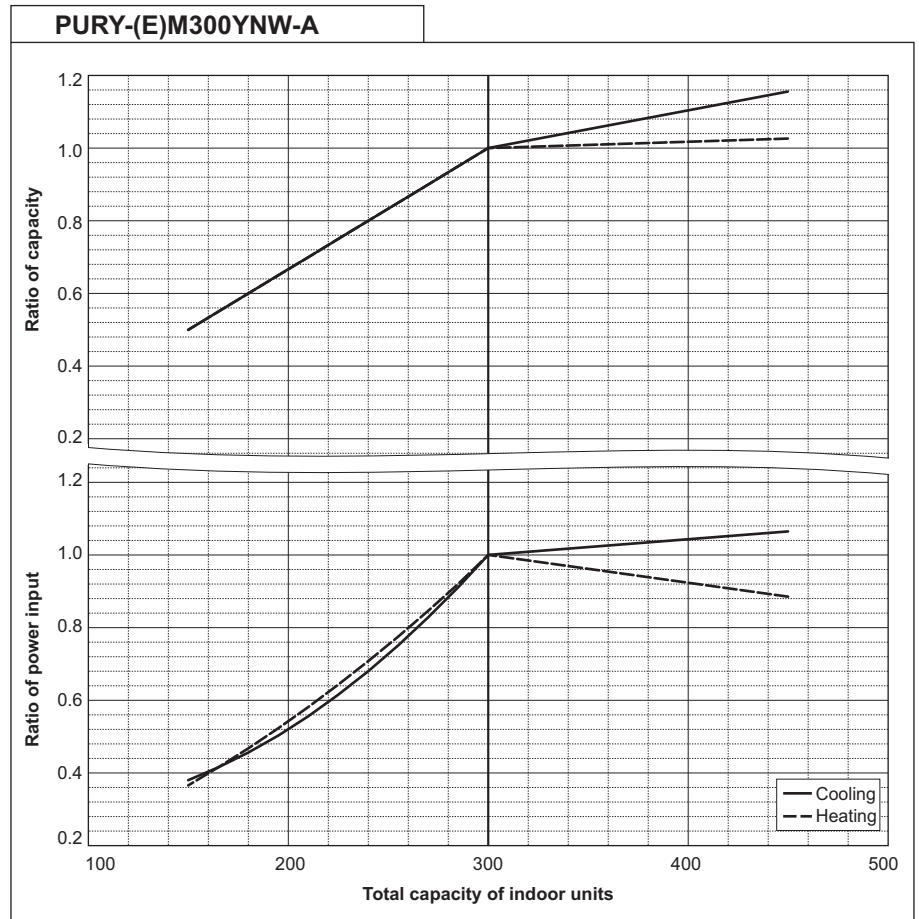

PURY-M-YNW-A, EM-YNW-A

### 8-3. Correction by piping length

A decrease in cooling/heating capacity will occur due to piping length increase. Using the following correction factors according to the equivalent length of the piping shown at 8-3-1 and 8-3-2 the capacity can be calculated. 8-3-3 shows how to obtain the equivalent length of piping. Refrigerant piping and water piping have separate correction factors.

#### 8-3-1. Cooling capacity correction

PURY-M-YNW-A, EM-YNW-A

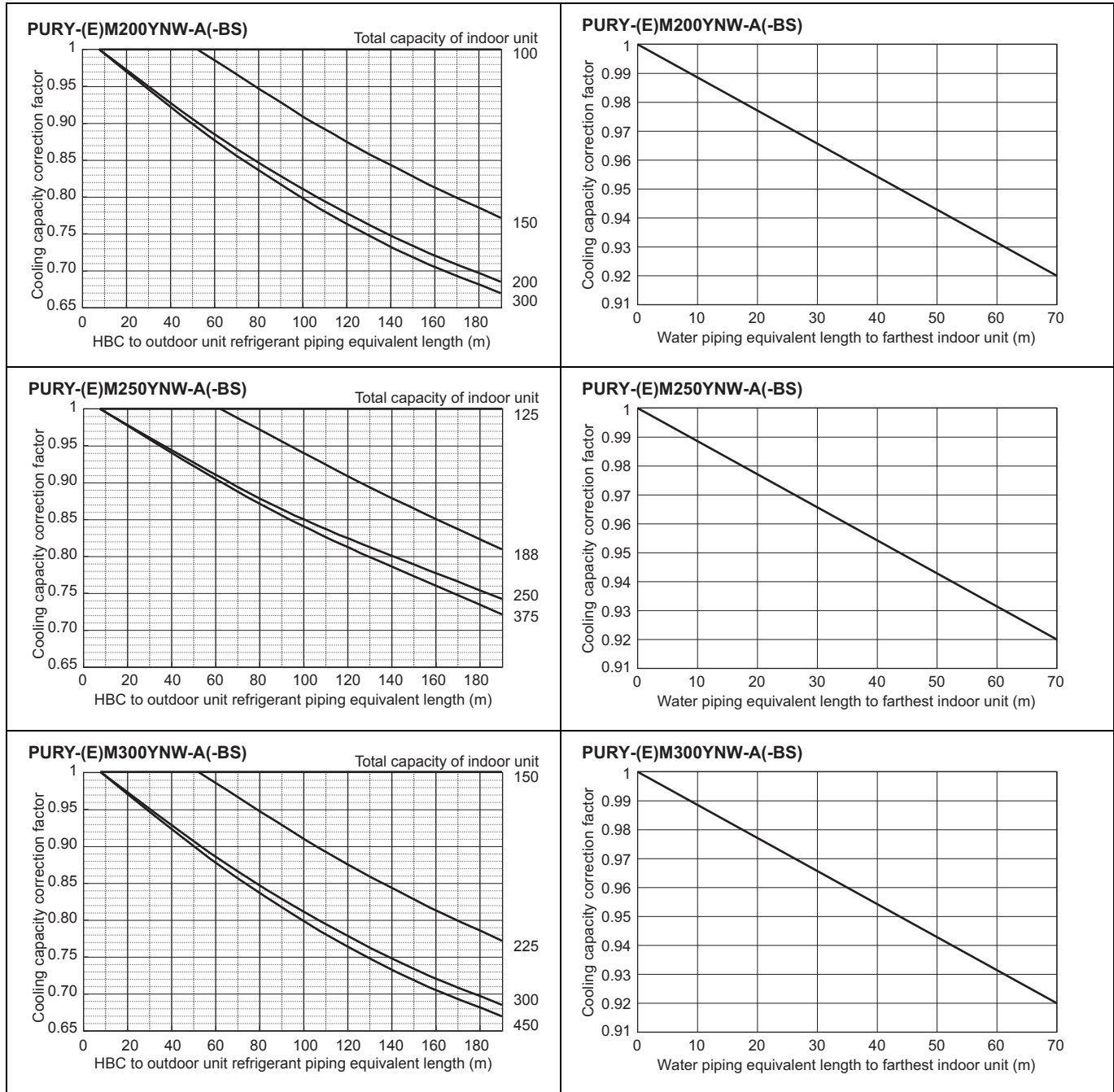



8-3-2. Heating capacity correction

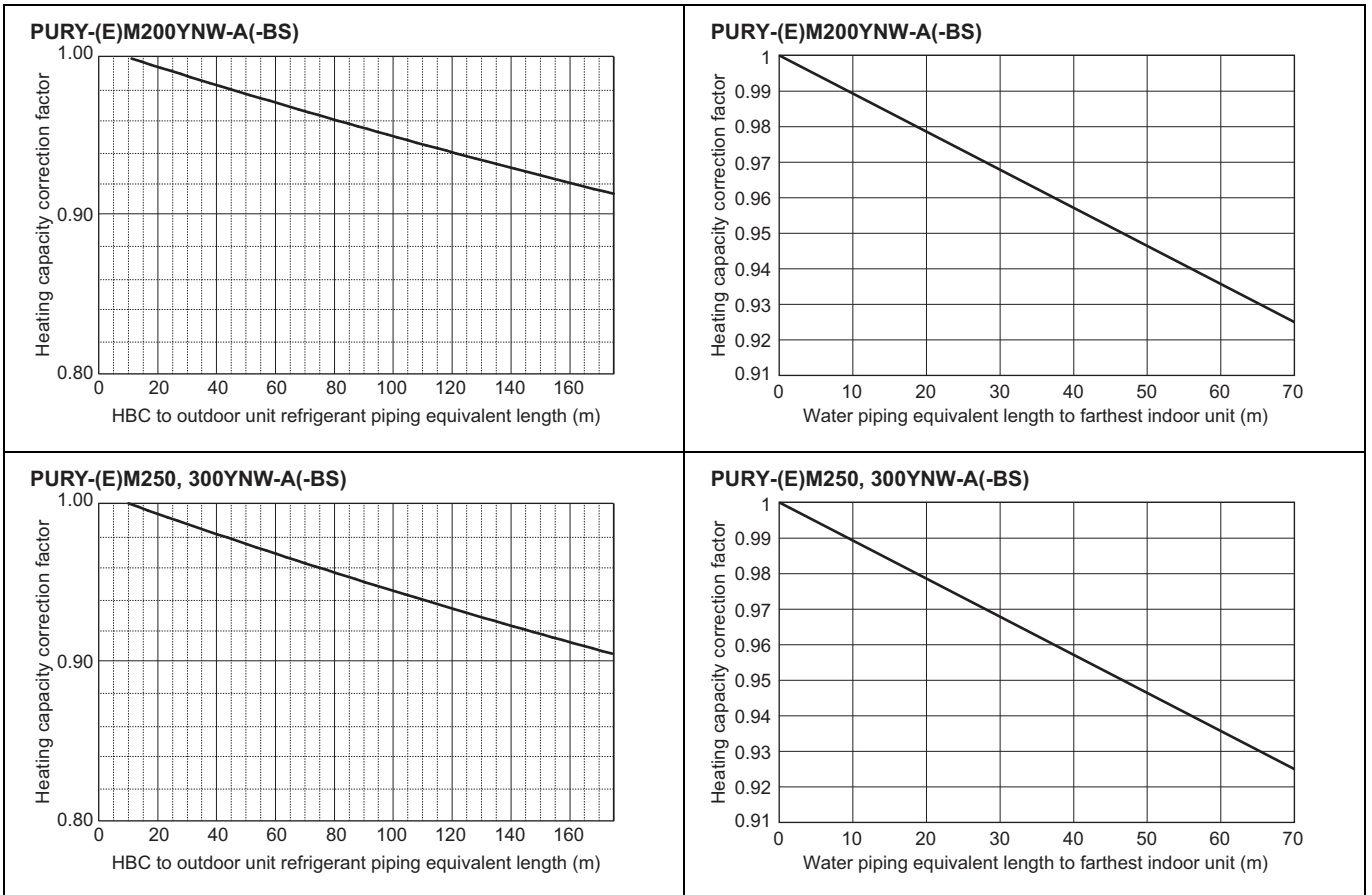

8-3-3. How to obtain the equivalent piping length

Refrigerant pipe

1. PURY-(E)M200, 250, 300YNW(-BS)

Equivalent length = (Actual piping length to the farthest indoor unit) + (0.35 × number of bends in the piping) [m]

Water pipe

Equivalent length = (Actual piping length to the farthest indoor unit) + (0.55 × number of bends in the piping) [m]

8-4. Correction at frost and defrost

Due to frost at the outdoor heat exchanger and the automatic defrost operation, the heating capacity of the outdoor unit can be calculated by multiplying the correction factor shown in the table below.

Table of correction factor at frost and defrost

Outdoor inlet air temp. °CWB	6	4	2	1	0	-2	-4	-6	-8	-10	-20
Outdoor inlet air temp. °FWB	43	39	36	34	32	28	25	21	18	14	-4
PURY-(E)M200YNW-A(-BS)	1.00	0.95	0.84	0.83	0.83	0.87	0.90	0.95	0.95	0.95	0.95
PURY-(E)M250YNW-A(-BS)	1.00	0.95	0.84	0.83	0.83	0.87	0.90	0.95	0.95	0.95	0.95
PURY-(E)M300YNW-A(-BS)	1.00	0.93	0.82	0.80	0.82	0.86	0.90	0.90	0.95	0.95	0.95

**8-5. Correction by antifreeze solution concentration**

In HYBRID CITY MULTI system, antifreeze solution should be used to prevent the system from freezing. Refer to the following graphs for the capacity correction by antifreeze solution. Refer to 8-5-1 for antifreeze solution concentration, 8-5-2 and 8-5-3 for capacity correction by antifreeze solution concentration.

**8-5-1. Antifreeze solution concentration**

Use propylene glycol solution for antifreeze.

Refer to the following graph to estimate the antifreeze solution concentration required for freeze protection.

DipSW setting (SW5-4 and 5-5) is required in HBC unit depending on the antifreeze solution concentration.

Refer the table A for the setting.

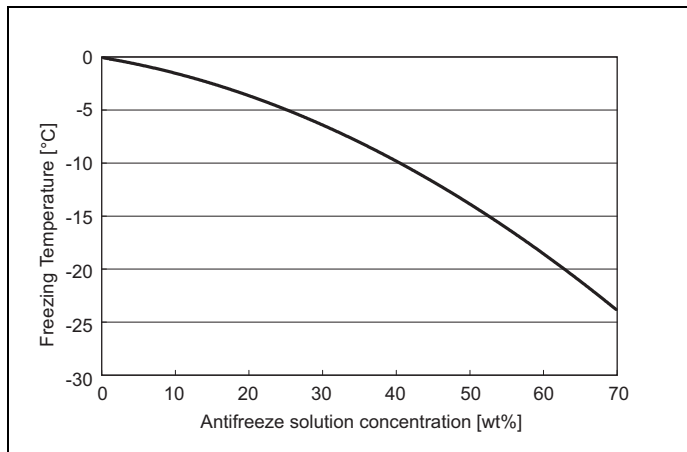
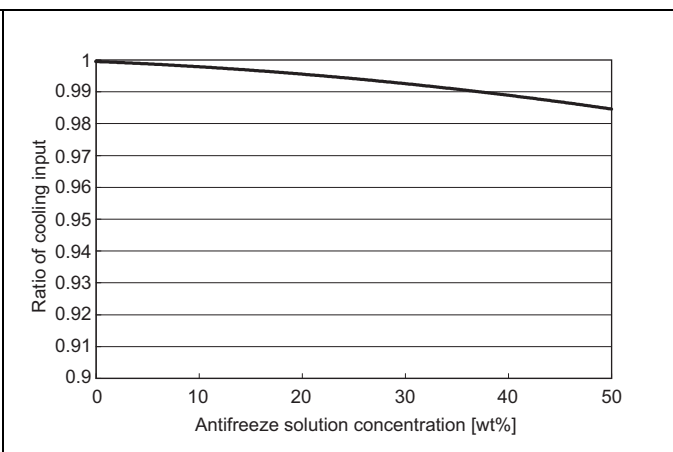
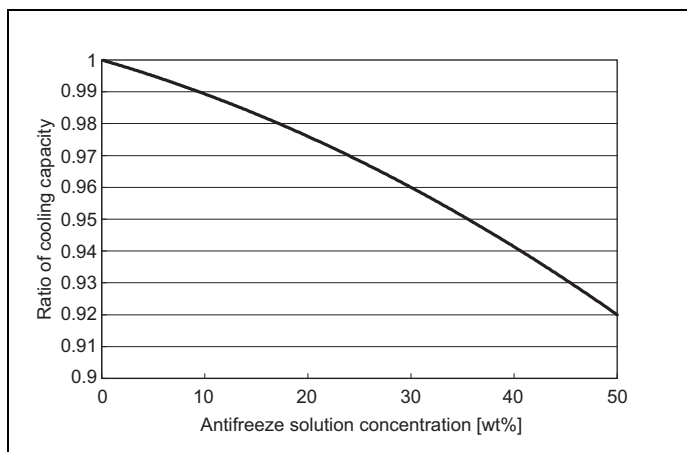

Table A

Brine concentration [%]	0 to 29%	30 to 49%	50 to 59%	60 to 70%
DipSW5-4	OFF	OFF	ON	ON
DipSW5-5	OFF	ON	OFF	ON
7seg LED	LD2	OFF	1	1
	LD3	OFF	1	1

**8-5-2. Capacity correction by antifreeze solution concentration (cooling)**



**8-5-3. Capacity correction by antifreeze solution concentration (heating)**

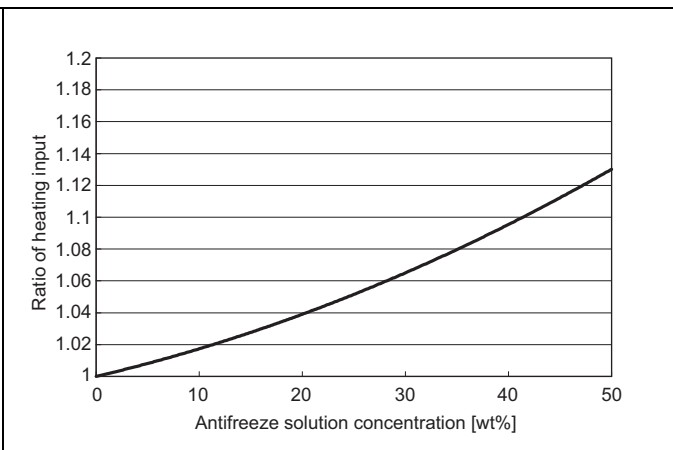
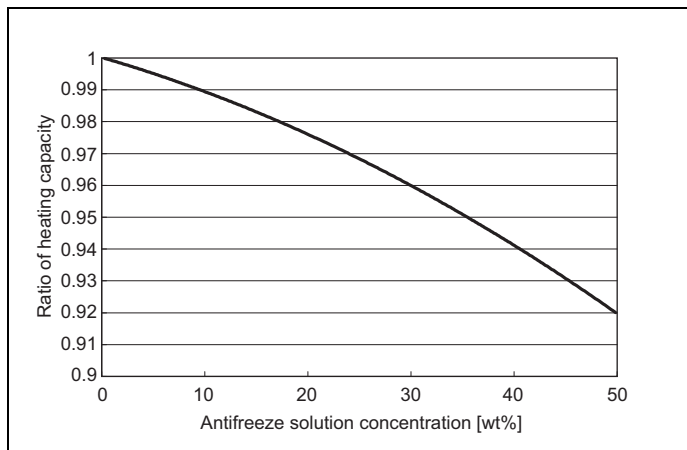

PURY-M-YNW-A, EM-YNW-A

9-1. Power supply for Outdoor unit

9-1-1. Electrical characteristics of the outdoor unit in cooling mode

Symbols: MCA: Max Circuit Amps

RLA: Rated Load Amps SC: Starting Current

PURY-M-YNW-A	Unit Combination	Units			Power supply	Compressor		FAN	RLA(A)(50/60Hz)	
		Hz	Volts	Voltage range	MCA(A)	Output (kW)	SC(A)	Output(kW)	Cooling	Heating
PURY-M200YNW-A(-BS)	-	50/60	380	Max:456V Min:342V	16.1	6.0	8	0.92	11.5/10.9/10.5	11.7/11.1/10.7
PURY-M250YNW-A(-BS)	-		400		20.4	7.5	8	0.92	16.7/15.9/15.3	16.9/16.1/15.5
PURY-M300YNW-A(-BS)	-		415		25.1	8.5	8	0.92	18.7/17.7/17.1	19.7/18.7/18.0

PURY-EM-YNW-A	Unit Combination	Units			Power supply	Compressor		FAN	RLA(A)(50/60Hz)	
		Hz	Volts	Voltage range	MCA(A)	Output (kW)	SC(A)	Output(kW)	Cooling	Heating
PURY-EM200YNW-A(-BS)	-	50/60	380	Max:456V Min:342V	16.1	6.0	8	0.92	10.3/9.8/9.5	11.4/10.8/10.4
PURY-EM250YNW-A(-BS)	-		400		19.8	7.5	8	0.92	14.8/14.0/13.5	16.6/15.7/15.2
PURY-EM300YNW-A(-BS)	-		415		23.4	8.5	8	0.92	16.9/16.0/15.4	18.4/17.4/16.8

PURY-M-YNW-A, EM-YNW-A

9-2. Power cable specifications

Thickness of wire for main power supply, capacities of the switch and system impedance

	Model	Minimum wire thickness (mm <sup>2</sup> )			Ground-fault interrupter *1	Local switch (A)		Breaker for wiring (A) (Non-fuse breaker)	Max. Permissible System Impedance
		Main cable	Branch	Ground		Capacity	Fuse		
Outdoor unit	PURY-(E)M200YNW-A	4.0	-	4.0	30A 100mA 0.1sec. or less	25	25	30	*2
	PURY-(E)M250YNW-A	4.0	-	4.0	30A 100mA 0.1sec. or less	32	32	30	*2
	PURY-(E)M300YNW-A	4.0	-	4.0	30A 100mA 0.1sec. or less	32	32	30	*2
Total operating current of the indoor unit	F0 = 20A or less *3	1.5	1.5	1.5	Current sensitivity *4	16	16	20	(apply to IEC61000-3-3)
	F0 = 30A or less *3	2.5	2.5	2.5	Current sensitivity *4	25	25	30	(apply to IEC61000-3-3)
	F0 = 40A or less *3	4.0	4.0	4.0	Current sensitivity *4	32	32	40	(apply to IEC61000-3-3)

\*1 The Ground-fault interrupter should support Inverter circuit. The Ground-fault interrupter should combine using of local switch or wiring breaker.

\*2 Meet technical requirements of IEC61000-3-3

\*3 Please take the larger of F1 or F2 as the value for F0.

F1 = Total operating maximum current of the indoor units × 1.2

F2 = {V1 × (Quantity of Type1)/C} + {V1 × (Quantity of Type2)/C} + {V1 × (Quantity of Type3)/C} + {V1 × (Quantity of Type4)/C}

Indoor unit		V1	V2
Type1	PEFY-VMS, PFFY-VLRMM	18.6	2.4
Type2	PEFY-VMA	38	1.6
Type3	PLFY-VBM	19.8	2.4
Type4	PLFY-VFM	17.1	2.4

C: Multiple of tripping current at tripping time 0.01s

Please pick up "C" from the tripping characteristic of the breaker.

<Example of "F2" calculation>

\*Condition PEFY-VMS × 4 + PEFY-VMA × 1, C = 8 (refer to right sample chart)

$$F2 = 18.6 \times 4/8 + 38 \times 1/8 = 14.05$$

→16 A breaker (Tripping current = 8 × 16 A at 0.01s)

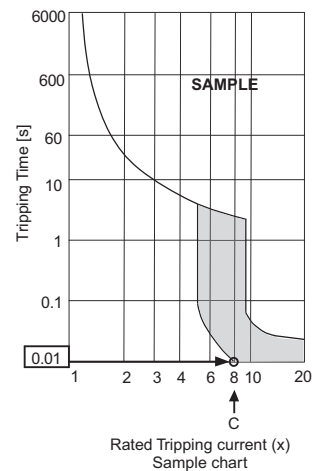

\*4 Current sensitivity is calculated using the following formula.

$$G1 = (V2 \times \text{Quantity of Type1}) + (V2 \times \text{Quantity of Type2}) + (V2 \times \text{Quantity of Type3}) + (V2 \times \text{Quantity of Type4})$$

G1	Current sensitivity	Wire thickness	V3
30 or less	30 mA 0.1sec or less	1.5 mm <sup>2</sup>	48
100 or less	100 mA 0.1sec or less	2.5 mm <sup>2</sup>	56
		4.0 mm <sup>2</sup>	66

1. Use dedicated power supplies for the outdoor unit and indoor unit. Ensure OC and OS are wired individually.
2. Bear in mind ambient conditions (ambient temperature, direct sunlight, rain water, etc.) when proceeding with the wiring and connections.
3. The wire size is the minimum value for metal conduit wiring. If the voltage drops, use a wire that is one rank thicker in diameter. Make sure the power-supply voltage does not drop more than 10%. Make sure that the voltage imbalance between the phases is 2% or less.
4. Specific wiring requirements should adhere to the wiring regulations of the region.
5. Power supply cords of parts of appliances for outdoor use shall not be lighter than polychloroprene sheathed flexible cord (design 60245 IEC57). For example, use wiring such as YZW.
6. A switch with at least 3 mm contact separation in each pole shall be provided when the Air Conditioner is installed.

**WARNING**

- ◆ Be sure to use specified wires for connections and ensure no external force is imparted to terminal connections. If connections are not fixed firmly, heating or fire may result.
- ◆ Be sure to use the appropriate type of overcurrent protection switch. Note that generated overcurrent may include some amount of direct current.

**CAUTION**

- ◆ The breakers for current leakage should support Inverter circuit. (e.g. Mitsubishi Electric's NV-S-Series or equivalent). If no earth leakage breaker is installed, it may cause an electric shock.
- ◆ Breakers for current leakage should combine using of switch.
- ◆ Do not use anything other than a breaker with the correct capacity. Using a breaker of too large capacity may cause malfunction or fire.
- ◆ If a large electric current flows due to malfunction or faulty wiring, earth-leakage breakers on the unit side and on the upstream side of the power supply system may both operate. Depending on the importance of the system, separate the power supply system or take protective coordination of breakers.

**Note**

- ◆ This device is intended for the connection to a power supply system with a maximum permissible system impedance shown in the above table at the interface point (power service box) of the user's supply.
- ◆ The user must ensure that this device is connected only to a power supply system which fulfils the requirement above. If necessary, the user can ask the public power supply company for the system impedance at the interface point.
- ◆ This equipment complies with IEC 61000-3-12 provided that the short-circuit power Ssc is greater than or equal to Ssc (\*2) at the interface point between the user's supply and the public system. It is the responsibility of the installer or user of the equipment to ensure, by consultation with the distribution network operator if necessary, that the equipment is connected only to a supply with a short-circuit power Ssc greater than or equal to Ssc (\*2).

Ssc(\*2)

Model	Ssc(MVA)
PURY-M200YNW-A	1.25
PURY-M250YNW-A	1.38
PURY-M300YNW-A	1.76
PURY-EM200YNW-A	1.25
PURY-EM250YNW-A	1.32
PURY-EM300YNW-A	1.58

PURY-M-YNW-A, EM-YNW-A

9-3. Power supply examples

The local standards and/or regulations is applicable at a higher priority.  
 PURY-(E)M200, 250, 300YNW-A

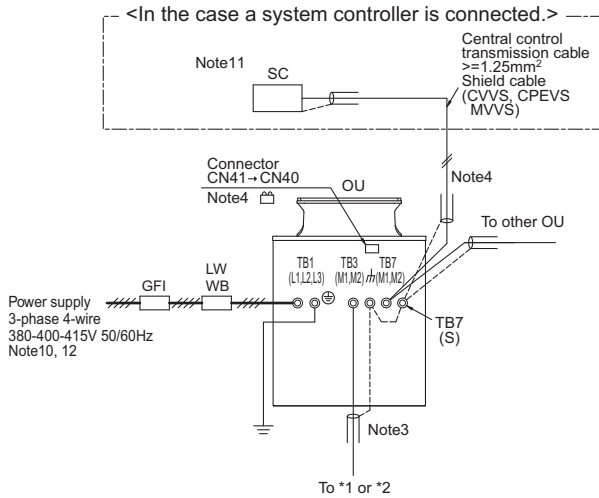

Note:

- 1 The transmission cable is not-polarity double-wire.
- 2 Symbol ⊙ means a screw terminal for wiring.
- 3 The shield wire of transmission cable should be connected to the grounding terminal at Outdoor unit. All shield wire of M-Net transmission cable among Indoor units should be connected to the S terminal at Indoor unit or all shield wire should be connected together. The broken line at the scheme means shield wire.
- 4 When the Outdoor unit connected with system controller, power-supply to TB7 of the outdoor unit(s) is needed. The connector change from CN41 to CN40 at one of the outdoor units will enable the outdoor unit to supply power to TB7, or an extra power supplying unit PAC-SC51KUA should be used. The transmission cable (above 1.25mm², shielded, CVVS/CPEVS/MVVS) among Outdoor units and system controllers is called central control transmission cable. The shield wire of the central control transmission cable must be grounded at the Outdoor unit whose CN41 is changed to CN40. When the power supplying unit PAC-SC51KUA is used, connect the shielded cable to the ground terminal on the PAC-SC51KUA.
- 5 MA R/C transmission cable (0.3-1.25mm²) must be less than 200m in length, while ME R/C transmission cable (0.3-1.25mm²) must be less than 10m in length. But transmission cable to the ME R/C can be extended using a M-NET cable (>=1.25mm²) when the length is counted in the M-Net length.
- 6 MA remote controller and ME remote controller should not be grouped together. When a PAR-CT01MA or PAR-3X MA-Series (X indicates 1, 2...) is connected to a group, no other MA remote controllers can be connected to the same group.
- 7 If using 1 or 2 (main/sub) MA remote controller to control more than 1 Indoor unit, use MA transmission cable to connect all the TB15 terminals of the Indoor units. It is called "Grouping".  
If using 1 or 2 (main/sub) ME remote controller control more than 1 indoor unit, set address to Indoor unit and ME remote controller. For the method, refer to 10-1. "Address setting".
- 8 Indoor board consumes power from TB3.
- 9 If Transmission booster is needed, be sure to connect the shield wires to the both sides to the booster.
- 10 The critical current for choosing power source equipment is approximate 1.4 times of total rated current of the Outdoor unit(s) or Indoor unit(s).
- 11 When System controller (SC) is connected to the system, turn the SW5-1 on.
- 12 The phases of electricity power must be confirmed to be right used. Phase-reverse, or phase-missing could break the controllers.

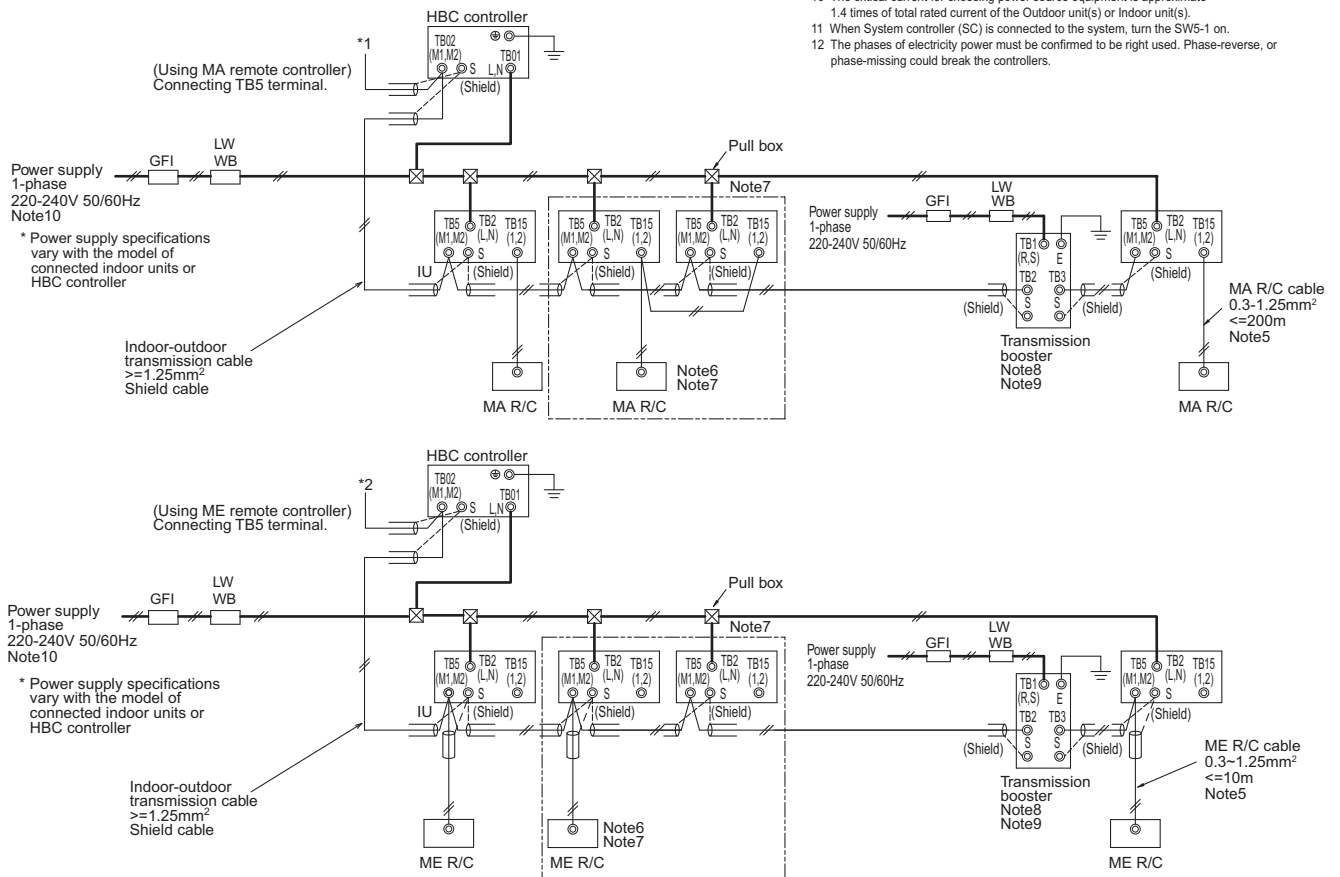



































Symbol	Model	Ground-fault interrupter *1, *2, *4	Local switch		Wiring breaker *4	Minimum Wire thickness		
			BKC <A>	OC P*3, *4 <A>	(NFB) <A>	Power wire <mm>	Earth wire <mm>	
GFI	Ground-fault interrupter	PURY-(E)M200YNW-A	30A 100mA 0.1sec. or less	25	25	30	4	4
LW	Local switch	PURY-(E)M250YNW-A	30A 100mA 0.1sec. or less	32	32	30	4	4
BKC	Breaker capacity	PURY-(E)M300YNW-A	30A 100mA 0.1sec. or less	32	32	30	4	4
OC P	Over-current protector							
WB	Wiring breaker							
NFB	Non-fuse breaker							
OU	Outdoor unit							
IU	Indoor unit							
SC	System controller							
MA R/C	MA remote controller							
ME R/C	ME remote controller							

\*1 The Ground-fault interrupter should support Inverter circuit. (e.g. Mitsubishi Electric's NV-S-Series or equivalent).  
 \*2 Ground-fault interrupter should combine using of local switch or wiring breaker.  
 \*3 It shows data for B-type fuse of the breaker for current leakage.  
 \*4 If a large electric current flows due to malfunction or faulty wiring, earth-leakage breakers on the unit side and on the centralized controller side may both operate.  
 Depending on the importance of the system, separate the power supply system or take protective coordination of breakers.

10-1. Address setting

10-1-1. Rule of setting address

Unit	Address setting	Example	Note	
Indoor unit	01 ~ 50	 	Use the most recent address within the same group of indoor units.	
Outdoor unit	51 ~ 99, 100 (Note1)	 	The smallest address of indoor unit in same refrigerant system + 50 Assign sequential address numbers to the outdoor units in one refrigerant circuit system. OC, OS1 and OS2 are automatically detected. (Note 2) * Please reset one of them to an address between 51 and 99 when two addresses overlap. * The address automatically becomes "100" if it is set as "01~ 50"	
HBC controller	52 ~ 99, 100	 	The address of the smallest address of indoor unit connected to the HBC controller +50 * Please reset one of them to an address between 51 and 99 when two addresses overlap. * The address automatically becomes "100" if it is set as "01~ 50"	
Local remote controller	ME Remote controller (Main)	101 ~ 150 Fixed	 	The smallest address of indoor unit in the group + 100 * The place of "100" is fixed to "1"
	ME Remote controller (Sub)	151 ~ 199, 200 Fixed	 	The address of main remote controller + 50 * The address automatically becomes "200" if it is set as "00"
System controller	ON/OFF remote controller	201 ~ 250	  	The smallest group No. to be managed + 200 * The smallest group No. to be managed is changeable.
	AE-200E/AE-50E AG-150A EW-50E AT-50B	000, 201 ~ 250	  	* AT-50B cannot be set to "000".
	PAC-YG50ECA	000, 201 ~ 250	  	* Settings are made on the initial screen of AG-150A.
	BAC-HD150	000, 201 ~ 250	  	* Settings are made with setting tool of BM ADAPTER.
	LMAP04-E	201 ~ 250 Fixed	 	
PI, AI, DIDO	PAC-YG60MCA	01 ~ 50	 	
	PAC-YG63MCA	01 ~ 50	 	
	PAC-YG66DCA	01 ~ 50	 	
Lossnay, OA processing unit	01 ~ 50	 	After setting the addresses of all the indoor units, assign an arbitrary address.	
PAC-IF01AHC	201 ~ 250 Fixed	 		

Note1: To set the address to "100", set it to "50"

Note2: Outdoor units OC, OS1 and OS2 in one refrigerant circuit system are automatically detected. OC, OS1 and OS2 are ranked in descending order of capacity. If units are the same capacity, they are ranked in ascending order of their address.

### 11-1. R32 Piping material

Refrigerant pipe for HYBRID CITY MULTI shall be made of phosphorus deoxidized copper, and has two types.

- A. Type-O: Soft copper pipe (annealed copper pipe), can be easily bent with human's hand.
- B. Type-1/2H pipe: Hard copper pipe (Straight pipe), being stronger than Type-O pipe of the same radical thickness.

The maximum operation pressure of R32 air conditioner is 4.30 MPa [623psi]. The refrigerant piping should ensure the safety under the maximum operation pressure. MITSUBISHI ELECTRIC recommends pipe size as Table 1, or You shall follow the local industrial standard. Pipes of radical thickness 0.7mm or less shall not be used.

Table 1. Copper pipe size and radial thickness for R32 HYBRID CITY MULTI.

Size (mm)	Size (inch)	Radial thickness (mm)	Radial thickness (mil)	Pipe type
ø6.35	ø1/4"	0.8	[32]	Type-O
ø9.52	ø3/8"	0.8	[32]	Type-O
ø12.7	ø1/2"	0.8	[32]	Type-O
ø15.88	ø5/8"	1.0	[40]	Type-O
ø19.05	ø3/4"	1.2	[48]	Type-O
ø19.05	ø3/4"	1.0	[40]	Type-1/2H or H
ø22.2	ø7/8"	1.0	[40]	Type-1/2H or H
ø25.4	ø1"	1.0	[40]	Type-1/2H or H
ø28.58	ø1-1/8"	1.0	[40]	Type-1/2H or H
ø31.75	ø1-1/4"	1.1	[44]	Type-1/2H or H
ø34.93	ø1-3/8"	1.2	[48]	Type-1/2H or H
ø41.28	ø1-5/8"	1.4	[56]	Type-1/2H or H

\* For pipe sized ø19.05 (3/4") for R32 air conditioner, choice of pipe type is up to you.

\* The figures in the radial thickness column are based on the Japanese standards and provided only as a reference. Use pipes that meet the local standards.

#### Flare

Due to the relative higher operation pressure of R32 compared to R22, the flare connection should follow dimensions mentioned below so as to achieve enough the air-tightness.

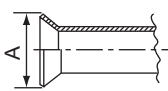
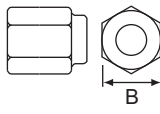
Flare pipe	Pipe size	A (For R32)	(mm[in.])	Flare nut	Pipe size	B (For R32)	(mm[in.])
	ø6.35 [1/4"]	9.1			ø6.35 [1/4"]	17.0	
	ø9.52 [3/8"]	13.2			ø9.52 [3/8"]	22.0	
	ø12.70 [1/2"]	16.6			ø12.70 [1/2"]	26.0	
	ø15.88 [5/8"]	19.7			ø15.88 [5/8"]	29.0	
	ø19.05 [3/4"]	24.0			ø19.05 [3/4"]	36.0	

11-2. Piping Design

11-2-1. Restrictions on pipe length

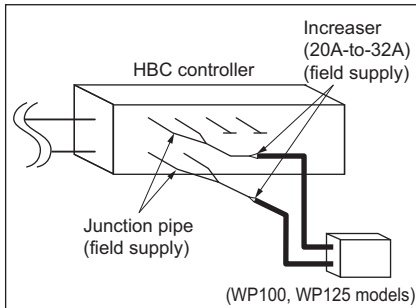
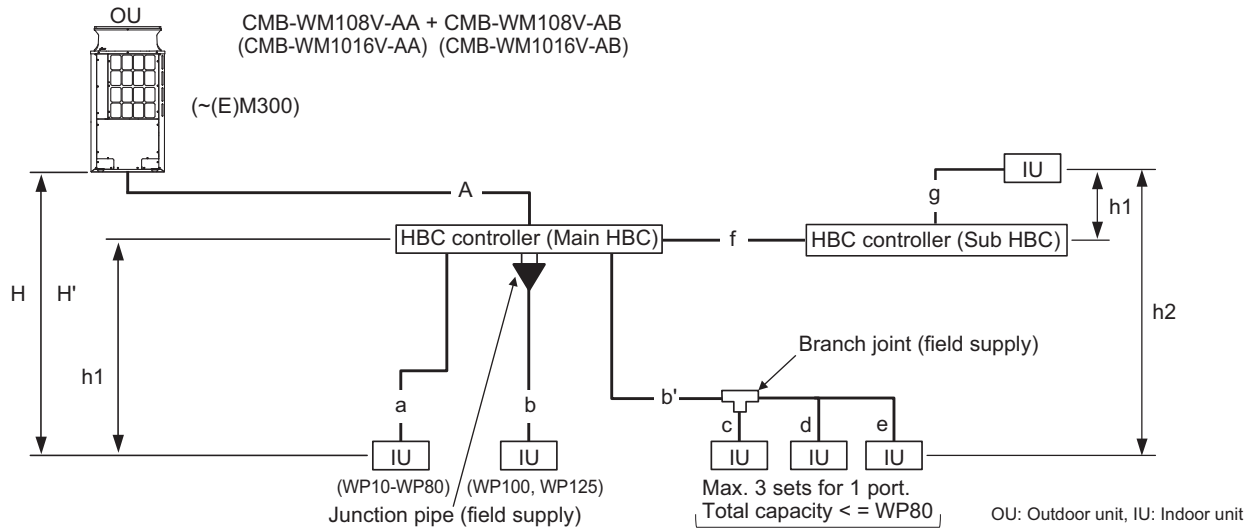
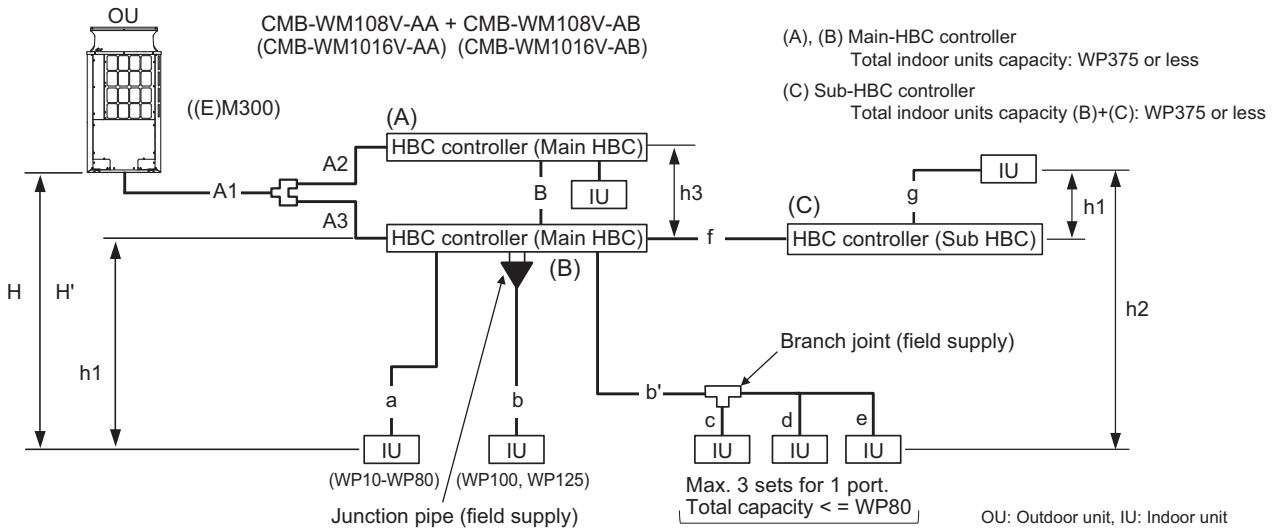

Fig. 11-2-1A

(Unit: m)			
		Item	Allowable value
Pipe Lengths	Between outdoor unit and HBC controller (refrigerant pipework)	A	110 or less
	Water pipework between indoor units and HBC controller	f + g	60 or less
Difference of elevation	Between HBC and outdoor units	Outdoor unit above HBC	H
		Outdoor unit below HBC	H'
Difference of elevation	Between indoor units and HBC controller	h1	15(10) or less*1
	Between indoor units	h2	15(10) or less*1

\*1. Values in ( ) are applied when indoor total capacity exceeds 130% of outdoor unit capacity



(Unit: m)			
		Item	Allowable value
Pipe Lengths	Between outdoor unit and HBC controller (refrigerant pipework)	A1 + A2 + A3	110 or less
	Water pipework between indoor units and HBC controller	f + g	60 or less
Difference of elevation	Between HBC and outdoor units	Outdoor unit above HBC	H
		Outdoor unit below HBC	H'
Difference of elevation	Between indoor units and HBC controller	h1	15(10) or less*1
	Between indoor units	h2	15(10) or less*1
Difference of elevation	Between HBC controllers	h3	15(10) or less*1

\*1. Values in ( ) are applied when indoor total capacity exceeds 130% of outdoor unit capacity



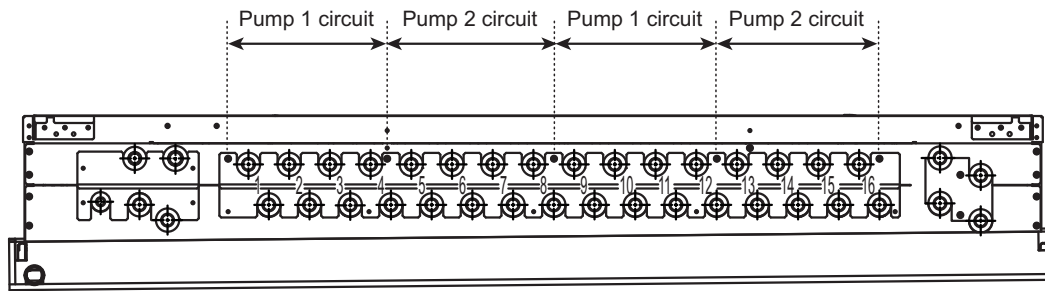

Fig. 11-2-1B

**Note: 1**

To connect multiple indoor units to a port

- ◆Maximum total capacity of connected indoor units: WP80 or below
- ◆Maximum number of connectable indoor units: 3 units
- ◆Branch joints are field-supplied.
 

All the indoor units that are connected to the same port must be in the same group and Thermo-ON/OFF operation simultaneously. For all the indoor units in the group, the room temperature needs to be monitored via the connected remote controller.
- ◆When connecting a WP71 through 125 model of indoor unit to an HBC controller, the pipes connecting the unit to the same set of HBC controller ports cannot be branched out to connect additional units.
- ◆When connecting multiple indoor units including a WP63 unit to the same set of HBC ports, use a size 32A pipe in the section indicated as "b" and "c" and connect the WP63 unit to the pipe indicated as "c" in the figure.
 

To the branch joint to which a WP63 is connected, either a WP10 or a WP15 unit is connectable.

**Note: 2**

Connecting WP100 or 125 indoor units to an HBC controller

- ◆When connecting WP100 or 125 indoor units to an HBC controller, connect each unit to two sets of two ports on the HBC controller, using two Junction pipes (Y-joints). (See Fig. 11-2-1A.)
- ◆Connect an increaser (20A-to-32A) to the merged side of each junction pipe. (See Fig. 11-2-1A.)
- ◆When connecting junction pipes to HBC ports, the branched sides of the junction pipes cannot be connected to combinations of ports "4 and 5," "8 and 9," or "12 and 13." (See Fig. 11-2-1B.)
- ◆When connecting a WP100 or a 125 model of indoor unit to an HBC controller, the pipes connecting the unit to the same set of HBC controller ports cannot be branched out to connect additional units.

**Note: 3**

Maximum connectable capacity of indoor units to HBC

- ◆HBC has two pumps. Each pump can accommodate the capacity of indoor units equivalent to P175.
 

Make sure that the total capacity of the indoor units connected to "ports 1 through 4 and 9 through 12" or "5 through 8 and 13 through 16" will not exceed P175. (See Fig. 11-2-1B.)

1. Refrigerant and water pipe size

(1) Refrigerant pipe between outdoor unit and HBC controller (Part A, A1, A2, and A3)

Use of one HBC controller

Unit model		HBC CONTROLLER		
		Model name	High pressure side	Low pressure side
Outdoor unit side	PURY-(E)M200	(HBC CONTROLLER) CMB-WM108V-AA CMB-WM1016V-AA	ø15.88 (Brazing)	ø19.05 (Brazing)
	PURY-(E)M250		ø15.88 (Brazing)	ø19.05 (Brazing)
	PURY-(E)M300		ø15.88 (Brazing)	ø19.05 (Brazing)

Use of two HBC controllers

Unit model		HBC CONTROLLER				
		Between outdoor unit and twining pipe		Between twining pipe and HBC		
Outdoor unit side	PURY-(E)M300	Model name	High pressure side	Low pressure side	High pressure side	Low pressure side
		(HBC CONTROLLER) CMB-WM108V-AA CMB-WM1016V-AA	ø15.88 (Brazing)	ø19.05 (Brazing)	ø15.88 (Brazing) for each HBC	ø19.05 (Brazing) for each HBC

(2) Water pipe between HBC controller and indoor units (Sections a, b, c, d, e, and g)

Indoor unit	Inlet pipe size	Outlet pipe size
WP10 - WP50	20A	20A
WP63 - WP125	32A	32A

\*The diameter of HBC ports is 20A.

20A-to-32A increasers are required to connect the models of indoor units between WP63 and WP125 to HBC controller ports.

(3) Water pipe between HBC controller and Sub-HBC

	Inlet pipe size	Outlet pipe size
Cold-water side	20A	20A
Hot-water side	20A	20A

(4) Refrigerant pipe between HBC controller and HBC controller

Unit: mm [inch]

ø15.88 [5/8" ] (Brazed connection)
------------------------------------

2. Connecting the HBC controller

(1) Size of the pipe that fits the standard HBC controller ports

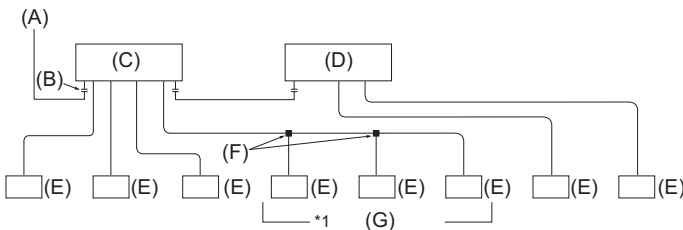

- (A) To outdoor unit
- (B) End connection (brazing)
- (C) Main-HBC controller
- (D) Sub-HBC controller
- (E) Indoor unit
- (F) Twinning pipe (field supply)
- (G) Up to three units for 1 branch hole; total capacity: below 80 (but same in cooling/heating mode)

**Note: 1**

To connect multiple indoor units to a port

- Maximum total capacity of connected indoor units: WP80 or below
- Maximum number of connectable indoor units: 3 units
- Branch joints are field-supplied.

All the indoor units that are connected to the same port must be in the same group and Thermo-ON/OFF operation simultaneously. For all the indoor units in the group, the room temperature needs to be monitored via the connected remote controller.

- When connecting a WP71 through 125 model of indoor unit to an HBC controller, the pipes connecting the unit to the same set of HBC controller ports cannot be branched out to connect additional units.
- When connecting multiple indoor units including a WP63 unit to the same set of HBC ports, use a size 32A pipe in the section indicated as "b" and "c" and connect the WP63 unit to the pipe indicated as "c" in the figure. (See page 38.)

**Note: 2**

Connecting WP100 or 125 indoor units to an HBC controller

- When connecting WP100 or 125 indoor units to an HBC controller, connect each unit to two sets of two ports on the HBC controller, using two Junction pipes (Y-joints). (See Fig. 11-2-1A.)
- Connect an increaser (20A-to-32A) to the merged side of each junction pipe. (See Fig. 11-2-1A.)
- When connecting junction pipes to HBC ports, the branched sides of the junction pipes cannot be connected to combinations of ports "4 and 5," "8 and 9," or "12 and 13." (See Fig. 11-2-1B.)
- When connecting a WP100 or a 125 model of indoor unit to an HBC controller, the pipes connecting the unit to the same set of HBC controller ports cannot be branched out to connect additional units.

**Note: 3**

Maximum connectable capacity of indoor units to HBC

- HBC has two pumps. Each pump can accommodate the capacity of indoor units equivalent to P175. Make sure that the total capacity of the indoor units connected to "ports 1 through 4 and 9 through 12" or "5 through 8 and 13 through 16" will not exceed P175. (See Fig. 11-2-1B.)

## 11-2-2. Drain piping work

### 1. Drain piping work

- Ensure that the drain piping is sloped downward (sloped gradient of more than 1/100) toward the discharge side.  
If it is impossible to take any downward pitch, use an optionally available drain pump to obtain a downward pitch of more than 1/100.
- Ensure that any horizontal drain piping sections that are longer than 20 m are supported with metal brackets to prevent it from bending, warping, or vibrating.
- Connect the supplied drain hose to the discharge port on the unit. Use hardvinyl chloride pipes VP-25 (ø32) for drain piping (2). Tighten the supplied drain hose onto the discharge port using the supplied hose band. (For this, do not use any adhesive because the drain hose will need to be removed for servicing at a later date.)
- Do not use any odor trap around the discharge port.

1

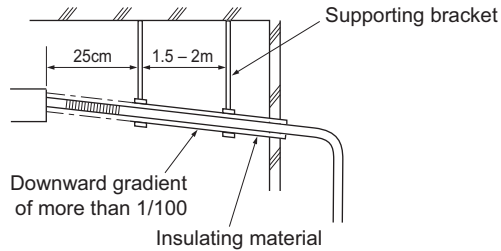

2

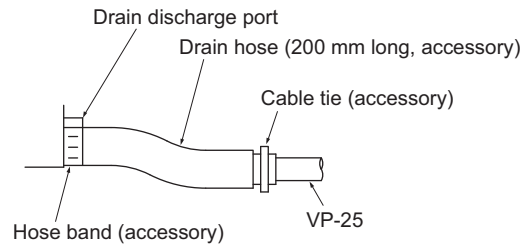

- As shown in 3, install a collecting pipe about 10 cm below the drain ports and give it a downward pitch of more than 1/100. This collecting pipe should be of VP-30.
- Set the end of drain piping in a place without any risk of odor generation.
- Do not put the end of the drain piping into any drain where ionic gases are generated.
- Drain piping may be installed in any direction. However, please be sure to observe the above instructions.

3

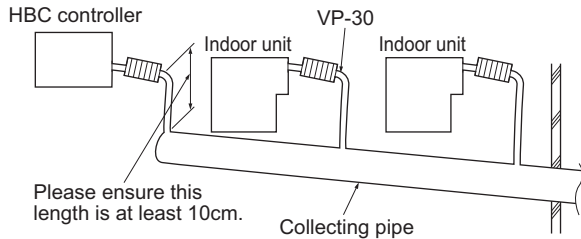

### 2. Discharge test

After completing drain piping work, open the HBC controller panel, and test drain discharge using a small amount of water. Also, check to see that there is no water leakage from the connections.

### 3. Insulating drain pipes

Provide sufficient insulation to the drain pipes just as for refrigerant pipes.

## ⚠ CAUTION

Be sure to provide drain piping with heat insulation in order to prevent excess condensation. Without drain piping, water may leak from the unit causing damage to your property.

### 11-2-3. Connecting water pipe work

Please observe the following precautions during installation.

#### 11-2-3-1 Important notes on water pipework installation

- The design pressure of the HBC water system is 0.6MPa.
- Use water pipe-work with a design pressure of at least 1.0MPa.
- When performing a water leak check, please do not allow the water pressure to go above 0.3MPa.
- Please connect the water pipework of each indoor unit to the correct port on the HBC. Failure to do so will result in incorrect running.
- Please list the indoor units on the naming plate in the HBC unit with addresses and end connection numbers.
- If the number of indoor units are less than the number of ports on the HBC, the unused ports must be capped. Without a cap, water will leak.
- Use the reverse-return method to insure proper pipe resistance to each unit.
- Provide some joints and valves around inlet/outlet of each unit for easy maintenance, checkup, and replacement.
- Install a suitable air vent on the water pipe. After flowing water through the pipe, vent any excess air.
- Secure the pipes with metal fittings, positioning them in locations to protect pipes against breakage and bending.
- Do not confuse the water intake and outlet piping. (Error code 5102 will appear on the remote controller if a test run is performed with the pipe-work installed incorrectly (inlet connected to outlet and vice versa).)
- This unit doesn't include a heater to prevent freezing within the pipe work. If the system is stopped for an extended period during low ambient conditions, drain the water out.
- The unused knockout holes should be closed and the refrigerant pipes, water pipes, power source and transmission wires access holes should be filled with putty.
- Install water pipe so that the water flow rate will be maintained.
- Wrap sealing tape as follows.
  1. Wrap the joint with sealing tape following the direction of the threads (clockwise), do not wrap the tape over the edge.
  2. Overlap the sealing tape by two-thirds to three-fourths of its width on each turn. Press the tape with your fingers so that it is tight against each thread.
  3. Do not wrap the 1.5th through 2nd farthest threads away from the pipe end.
- Hold the pipe on the unit side in place with a spanner when installing the pipes or strainer. Tighten screws to a torque of 40 N·m.
- If there is a risk of freezing, take precautions to prevent this happening.
- When connecting the HBC unit water piping and on site water piping, apply liquid sealing material for water piping over the sealing tape before connection.
- Please use copper or plastic pipes for the water circuit. Do not use steel or stainless steel pipework. Furthermore, when using copper pipe-work, use a non-oxidative brazing method. Oxidation of the pipe-work will reduce the pump life.

#### Example of heat source unit installation (using left piping)

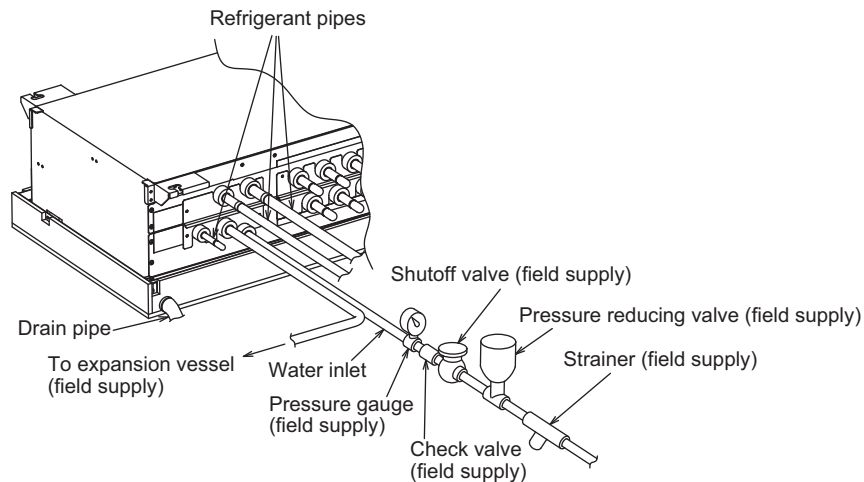

HBC controller sample installation (\*1)

\*1. Connect the pipes to the water pipes according to the local regulations.

- The HBC system must be serviced at least once a year.

11-2-3-2 Water pipe insulation

1. Connect the water pipes of each indoor unit to the same (correct) end connection numbers as indicated on the indoor unit connection section of each HBC controller. If connected to wrong end connection numbers, there will be no normal operation.
2. List indoor unit model names in the name plate on the HBC controller control box (for identification purposes), and HBC controller end connection numbers and address numbers in the name plate on the indoor unit side.  
Seal unused end connections using cover caps (field supply, dezincification resistant brass (DZR) or bronze only). Not replacing the rubber end caps will lead to water leakage.
3. Be sure to add insulation work to water piping by covering water pipework separately with enough thickness heat-resistant polyethylene, so that no gap is observed in the joint between indoor unit and insulating material, and insulating materials themselves. When insulation work is insufficient, there is a possibility of condensation, etc. Pay special attention to insulation work in the ceiling plenum.

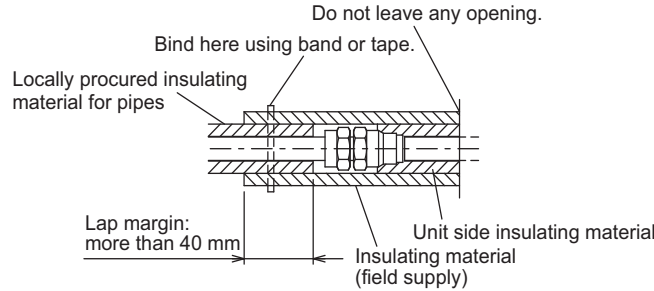

- Insulation materials for the pipes to be added on site must meet the following specifications:

HBC controller -indoor unit	20 mm or more
--------------------------------	---------------

- This specification is based on copper for water piping. When using plastic pipework, choose a thickness based on the plastic pipe performance.
- Installation of pipes in a high-temperature high-humidity environment, such as the top floor of a building, may require the use of insulation materials thicker than the ones specified in the chart above.
- When certain specifications presented by the client must be met, ensure that they also meet the specifications on the chart above.

4. Expansion vessel

- Install an expansion tank to accommodate expanded water.

Expansion vessel selection criteria:

- The water containment volume of the HBC, the indoor units, and pipe work.

(Unit: L)

Unit model	Water volume
CMB-WM108V-AA	10
CMB-WM1016V-AA	13
CMB-WM108V-AB	5
CMB-WM1016V-AB	9
PEFY-WP10VMS1-E	0.4
PEFY-WP15VMS1-E	0.7
PEFY-WP20VMS1-E	0.9
PEFY-WP25VMS1-E	
PEFY-WP32VMS1-E	1.0
PEFY-WP40VMS1-E	
PEFY-WP50VMS1-E	1.7
PEFY-WP20VMA-E	0.7
PEFY-WP25VMA-E	1.0
PEFY-WP32VMA-E	
PEFY-WP40VMA-E	1.8
PEFY-WP50VMA-E	
PEFY-WP63VMA-E	2.0
PEFY-WP71VMA-E	2.6
PEFY-WP80VMA-E	
PEFY-WP100VMA-E	
PEFY-WP125VMA-E	3.0
PLFY-WP32VBM-E	1.5
PLFY-WP40VBM-E	
PLFY-WP50VBM-E	
PLFY-WP10VFM-E	0.5
PLFY-WP15VFM-E	
PLFY-WP20VFM-E	0.9
PLFY-WP25VFM-E	
PLFY-WP32VFM-E	

(Unit: L)

Unit model	Water volume
PFFY-WP20VLRMM-E	0.9
PFFY-WP25VLRMM-E	1.3
PFFY-WP32VLRMM-E	
PFFY-WP40VLRMM-E	1.5
PFFY-WP50VLRMM-E	

- The maximum water temperature is 60°C.
- The minimum water temperature is 5°C.
- The circuit protection valve set pressure is 370-490kPa.
- The circulation pump head pressure is 0.24MPa.

5. Leakproof the water pipework, valves and drain pipework. Leakproof all the way to, and include pipe ends so that condensation cannot enter the insulated pipework.
6. Apply caulking around the ends of the insulation to prevent condensation getting between the pipework and insulation.
7. Add a drain valve so that the unit and pipework can be drained.
8. Ensure there are no gaps in the pipework insulation. Insulate the pipework right up to the unit.
9. Ensure that the gradient of the drain pan pipework is such that discharge can only flow out.
10. HBC water pipe connection sizes and pipe sizes.

	Connection size		Pipe size	
	Water inlet	Water outlet	Water out	Water return
Indoor unit (WP10-WP50)	Rc 3/4 screw	Rc 3/4 screw	I.D. 20 mm	I.D. 20 mm
Indoor unit (WP63-WP125)	Rc 1-1/4 screw	Rc 1-1/4 screw	I.D. 35 mm	I.D. 35 mm

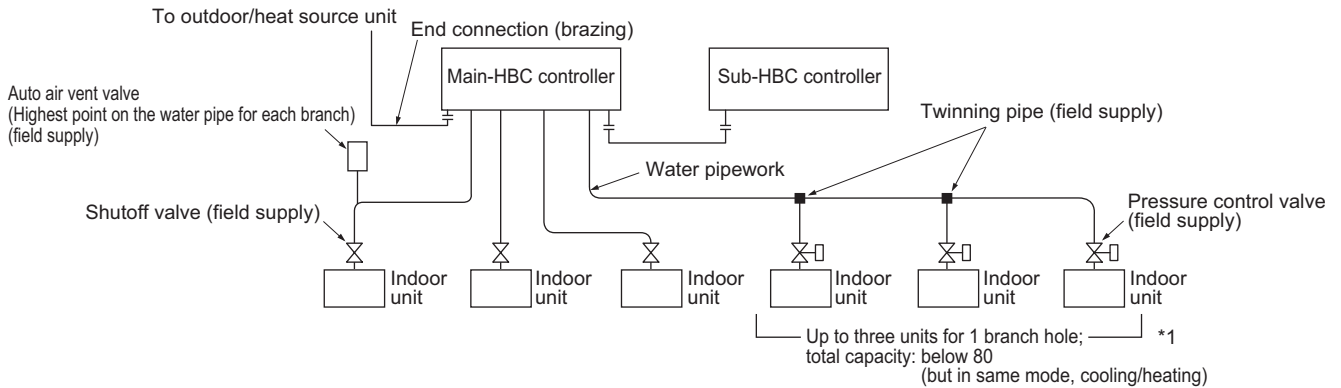

**Note: 1**

To connect multiple indoor units to a port

- Maximum total capacity of connected indoor units: WP80 or below
- Maximum number of connectable indoor units: 3 units
- Branch joints are field-supplied.

All the indoor units that are connected to the same port must be in the same group and Thermo-ON/OFF operation simultaneously. For all the indoor units in the group, the room temperature needs to be monitored via the connected remote controller.

- When connecting a WP71 through 125 model of indoor unit to an HBC controller, the pipes connecting the unit to the same set of HBC controller ports cannot be branched out to connect additional units.
- When connecting multiple indoor units including a WP63 unit to the same set of HBC ports, use a size 32A pipe in the section indicated as "b" and "c" and connect the WP63 unit to the pipe indicated as "c" in the figure. (See page 38.)

**Note: 2**

Connecting WP100 or 125 indoor units to an HBC controller

- When connecting WP100 or 125 indoor units to an HBC controller, connect each unit to two sets of two ports on the HBC controller, using two Junction pipes (Y-joints). (See Fig. 11-2-1A.)
- Connect an increaser (20A-to-32A) to the merged side of each junction pipe. (See Fig. 11-2-1A.)
- When connecting junction pipes to HBC ports, the branched sides of the junction pipes cannot be connected to combinations of ports "4 and 5," "8 and 9," or "12 and 13." (See Fig. 11-2-1B.)
- When connecting a WP100 or a 125 model of indoor unit to an HBC controller, the pipes connecting the unit to the same set of HBC controller ports cannot be branched out to connect additional units.

**Note: 3**

Maximum connectable capacity of indoor units to HBC

- HBC has two pumps. Each pump can accommodate the capacity of indoor units equivalent to P175. Make sure that the total capacity of the indoor units connected to "ports 1 through 4 and 9 through 12" or "5 through 8 and 13 through 16" will not exceed P175. (See Fig. 11-2-1B.)



11. Please refer to the figure below when connecting the water supply.

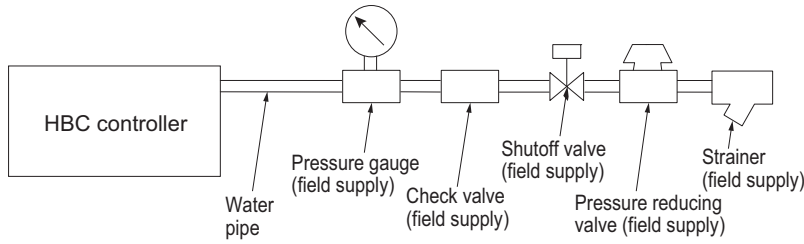

12. Use formula  $0.1 \leq 0.01 + 0.01 \times A \leq 0.16$  for the supply pressure range to be used.  
 (A: Head pressure (m) between the HBC and the highest indoor unit)  
 If the supply pressure is greater than 0.16 MPa, use a pressure reducing valve to keep the pressure within the range.  
 If the head pressure is unknown, set it to 0.16 MPa.
13. Install a shut off valve and strainer in a place that is easy to operate and makes maintenance work easy.
14. Apply insulation to the indoor unit pipework, strainer, shut off valve, and pressure reducing valve.
15. Please do not use a corrosion inhibitor in the water system.
16. When installing the HBC unit in an environment which may drop below 0°C, please add antifreeze (Propylene Glycol only) to the circulating water. For the brine selection, refer to 8-5. "Correction by antifreeze solution concentration".

**11-2-3-3 Water treatment and quality control**

To preserve water quality, use the closed type of water circuit. When the circulating water quality is poor, the water heat exchanger can develop scale, leading to a reduction in heat-exchange power and possible corrosion. Pay careful attention to water processing and water quality control when installing the water circulation system.

- Removing of foreign objects or impurities within the pipes.  
 During installation, make sure that foreign objects, such as welding fragments, sealant particles, or rust, do not enter the pipes.
- Water Quality Processing  
 Depending on the quality of the cold-temperature water used in the airconditioner, the copper piping of the heat exchanger may corrode. Regular water quality processing is recommended. If a water supply tank is installed, keep air contact to a minimum, and keep the level of dissolved oxygen in the water no higher than 1mg/l.

11-3. Refrigerant charging calculation

Example

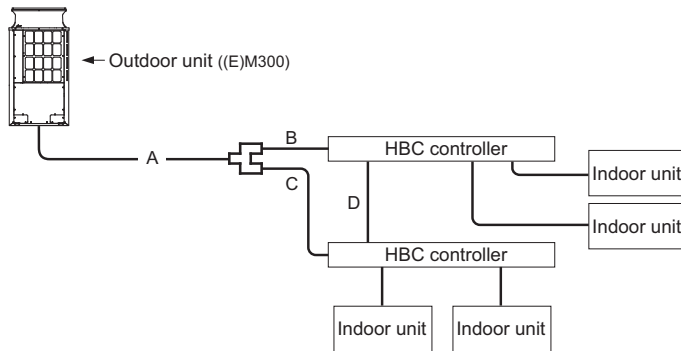
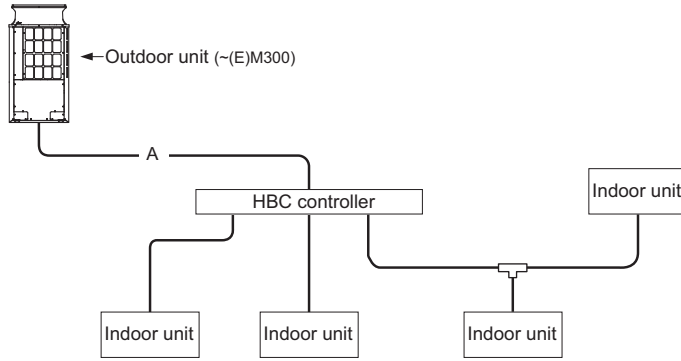

■ Sample calculation

Indoor 1: 50 A: ø15.88 42 m  
 2: 50  
 3: 50  
 4: 40  
 Outdoor M250

The total length of each liquid line is as follows:  
 ø15.88: A = 42 m, α<sub>1</sub> = 2.8  
 Therefore,  
 <Calculation example>  
 Additional refrigerant charge  
 = 42 × 0.09 + 2.8  
 = 6.58 kg  
 ≒ 6.6 kg

\* All pipe work except A is water pipe work.

Indoor 1: 50 A: ø15.88 18 m  
 2: 50 B: ø15.88 5 m  
 3: 50 C: ø15.88 10 m  
 4: 50 D: ø15.88 8 m  
 Outdoor M300

The total length of each liquid line is as follows:  
 ø15.88: A = 18 m, ø15.88: B + C + D = 23m, α<sub>1</sub> = 2.8 × 2  
 Therefore,  
 <Calculation example>  
 Additional refrigerant charge  
 = 18 × 0.09 + (5 + 10 + 8) × 0.09 + 2.8 × 2  
 = 9.29 kg  
 ≒ 9.3 kg

\* All pipe work except A, B, C, D is water pipe work.

<Amount of refrigerant to be added>

The amount of refrigerant that is shown in the table below is factory-charged to the outdoor units. The amount necessary for extended pipe (field piping) is not included and must be added on site.

Outdoor unit model	Amount of pre-charged refrigerant in the outdoor unit (kg)
M200YNW	5.2
M250YNW	5.2
M300YNW	5.2

Outdoor unit model	Amount of pre-charged refrigerant in the outdoor unit (kg)
EM200YNW	5.2
EM250YNW	5.2
EM300YNW	5.2

■ Calculation formula

The amount of refrigerant to be added depends on the size and the length of field piping. (unit in m[ft])

- When the distance between HBC and outdoor unit is longer than 10m:  
 Amount of added refrigerant (kg) = (0.09 × L<sub>1</sub>) + α<sub>1</sub>
- When the distance between HBC and outdoor unit is 10m or shorter:  
 Amount of added refrigerant (kg) = (0.11 × L<sub>1</sub>) + α<sub>1</sub>

L<sub>1</sub>: Length of ø15.88 [5/8"] high pressure pipe (m)  
 α<sub>1</sub>: Refer to the table below.

Use of one HBC controller

Outdoor unit index	Diameter of high-pressure pipe
(E)M200	ø15.88
(E)M250	ø15.88
(E)M300	ø15.88

Amount for the HBC controller
α <sub>1</sub> (kg)
2.8

Use of two HBC controllers

Outdoor unit index	Diameter of high-pressure pipe	Amount for the HBC controller
(E)M300	ø15.88	α <sub>1</sub> (kg)
		2.8

× 2

Round up the calculation result to the nearest 0.1kg. (Example: 18.04kg to 18.1kg)

■ Limitation of the amount of refrigerant to be charged

The above calculation result of the amount of refrigerant to be charged must become below the value in the table below.

Total index of the outdoor units		M200 YNW	M250 YNW	M300 YNW	EM200 YNW	EM250 YNW	EM300 YNW
Maximum refrigerant charge	Factory charged	kg	5.2	5.2	5.2	5.2	5.2
	Charged on site	kg	12.7	12.7	12.7	12.7	12.7
	Total for system	kg	17.9	17.9	17.9	17.9	17.9

## 11-4. Water piping

### 11-4-1. Precautions for water piping

Consider the following when installing a water piping system.

1. Design pressure of the water piping  
Use a water pipe that is strong enough to withstand the design pressure (1.0 MPa).
2. Water pipe type  
Use of plastic pipe is recommended.  
When using copper pipes, be sure to braze the pipes under a nitrogen purge. (Oxidation during may shorten the life of the pump.)
3. Expansion vessel  
Install an expansion vessel to accommodate expanded water.
4. Drain piping  
Install the drain pipe with a downward inclination of between 1/100 and 1/200. To prevent drain water from freezing in winter, install the drain pipe as steep an angle as practically possible and minimize the straight line. For cold climate installation, take an appropriate measure (e.g., drain heater) to prevent the drain water from freezing.
5. Insulation  
Cover the water pipe with insulating materials with the specified thickness or more to prevent thermal loss or condensation from collecting.
6. Air vent valve  
Install air vent valves to the highest places where air can accumulate.
7. Maintenance valve  
It is recommended to install valves on the inlet/outlet for each HBC controller branch for maintenance.
8. Water pressure gauge  
Install a water pressure gauge to check the charged pressure.

### 11-4-2. Notes on corrosion

#### 1. Water quality

It is important to check the water quality beforehand. See table below (Circulating water/Makeup Water Quality Standards).

Items		Lower mid-range temperature water system		Tendency	
		Recirculating water [20<T<60°C] [68<T<140°F]	Make-up water	Corrosive	Scale-forming
Standard items	pH (25°C[77°F])	7.0 ~ 8.0	7.0 ~ 8.0	○	○
	Electric conductivity (mS/m) (25°C[77°F]) (μS/cm) (25°C[77°F])	30 or less [300 or less]	30 or less [300 or less]	○	○
	Chloride ion (mg Cl <sup>-</sup> /ℓ)	50 or less	50 or less	○	
	Sulfate ion (mg SO <sub>4</sub> <sup>2-</sup> /ℓ)	50 or less	50 or less	○	
	Acid consumption (pH4.8) (mg CaCO <sub>3</sub> /ℓ)	50 or less	50 or less		○
	Total hardness (mg CaCO <sub>3</sub> /ℓ)	70 or less	70 or less		○
	Calcium hardness (mg CaCO <sub>3</sub> /ℓ)	50 or less	50 or less		○
	Ionic silica (mg SiO <sub>2</sub> /ℓ)	30 or less	30 or less		○
Reference items	Iron (mg Fe/ℓ)	1.0 or less	0.3 or less	○	○
	Copper (mg Cu/ℓ)	1.0 or less	0.1 or less	○	
	Sulfide ion (mg S <sup>2-</sup> /ℓ)	not to be detected	not to be detected	○	
	Ammonium ion (mg NH <sub>4</sub> <sup>+</sup> /ℓ)	0.3 or less	0.1 or less	○	
	Residual chlorine (mg Cl/ℓ)	0.25 or less	0.3 or less	○	
	Free carbon dioxide (mg CO <sub>2</sub> /ℓ)	0.4 or less	4.0 or less	○	
	Ryzner stability index	—	—	○	○

Reference : Guideline of Water Quality for Refrigeration and Air Conditioning Equipment. (JRA GL02E-1994)

#### 2. Debris in the water

Sand, pebbles, suspended solids, and corrosion products in water can damage the metal pipe and heat exchanger on the HBC controller and may cause corrosion. When installing, prevent debris from entering the water. If there is debris in the water, perform debris removal operation after test run by cleaning the strainers inside the HBC controller. (Refer to other sections for how to perform a test run.)

#### 3. Connecting pipes made of different materials

Connecting pipes used for HBC controller and indoor unit are copper alloy pipes. If steel pipes are connected to the pipes, the contact surface will corrode. Do not use steel pipes to avoid corrosion.

#### 4. Residual air

Residual air in the pipe results in water pump malfunction, noise, or water pipe corrosion in the water circuit. Ensure air is purged before use. (Refer to other sections for how to perform air vent operation.)



1. Installation information .....	2
1-1. General precautions .....	2
1-2. Precautions for Indoor unit and HBC controller .....	4
1-3. Precautions for Outdoor unit.....	5
1-4. Precautions for Control-related items .....	6

\* Refer to the enclosed Installation Manual for details on installation. Arrange to have an expert install the system correctly.

## 1-1. General precautions

### 1-1-1. Usage

- ♦The air-conditioning system described in this Data Book is designed for human comfort.
- ♦This product is not designed for preservation of food, animals, plants, precision equipment, or art objects. To prevent quality loss, do not use the product for purposes other than what it is designed for.
- ♦To reduce the risk of water leakage and electric shock, do not use the product for air-conditioning vehicles or vessels.

### 1-1-2. Installation environment

- ♦Do not install any unit other than the dedicated unit in a place where the voltage changes a lot, large amounts of mineral oil (e.g., cutting oil) are present, cooking oil may splash, or a large quantity of steam can be generated such as a kitchen.
- ♦Do not install the unit in acidic or alkaline environment.
- ♦Installation should not be performed in the locations exposed to chlorine or other corrosive gases. Avoid near a sewer.
- ♦To reduce the risk of fire, do not install the unit in a place where flammable gas may be leaked or inflammable material is present.
- ♦This air conditioning unit has a built-in microcomputer. Take the noise effects into consideration when deciding the installation position. Especially in a place where antenna or electronic device are installed, it is recommended that the air conditioning unit be installed away from them.
- ♦Install the unit on a solid foundation according to the local safety measures against typhoons, wind gusts, and earthquakes to prevent the unit from being damaged, toppling over, and falling.

### 1-1-3. Backup system

- ♦In a place where air conditioner's malfunctions may exert crucial influence, it is recommended to have two or more systems of single outdoor unit with multiple indoor units.

### 1-1-4. Unit characteristics

- ♦Heat pump efficiency of outdoor unit depends on outdoor temperature. In the heating mode, performance drops as the outside air temperature drops. In cold climates, performance can be poor. Warm air would continue to be trapped near the ceiling and the floor level would continue to stay cold. In this case, heat pumps require a supplemental heating system or air circulator. Before purchasing them, consult your local distributor for selecting the unit and system.
- ♦When the outdoor temperature is low and the humidity is high, the heat exchanger on the outdoor unit side tends to collect frost, which reduces its heating performance. To remove the frost, Auto-defrost function will be activated and the heating mode will temporarily stop for 3-10 minutes. Heating mode will automatically resume upon completion of defrost process.
- ♦Air conditioner with a heat pump requires time to warm up the whole room after the heating operation begins, because the system circulates warm air in order to warm up the whole room.
- ♦The sound levels were obtained in an anechoic room. The sound levels during actual operation are usually higher than the simulated values due to ambient noise and echoes. Refer to the section on "SOUND LEVELS" for the measurement location.
- ♦Depending on the operation conditions, the unit generates noise caused by valve actuation, refrigerant flow, and pressure changes even when operating normally. Please consider to avoid location where quietness is required. For BC/HBC controller, it is recommended to unit to be installed in places such as ceilings of corridor, restrooms and plant rooms.
- ♦The total capacity of the connected indoor units can be greater than the capacity of the outdoor unit. However, when the connected indoor units operate simultaneously, each unit's capacity may become smaller than the rated capacity.
- ♦When the unit is started up for the first time within 12 hours after power on or after power failure, it performs initial startup operation (capacity control operation) to prevent damage to the compressor. The initial startup operation requires 90 minutes maximum to complete, depending on the operation load.

### 1-1-5. Relevant equipment

- ♦Use an earth leakage breaker (ELB) with medium sensitivity, and an activation speed of 0.1 second or less.
- ♦Consult your local distributor or a qualified technician when installing an earth leakage breaker.
- ♦If the unit is inverter type, select an earth leakage breaker for handling high harmonic waves and surges.
- ♦Leakage current is generated not only through the air conditioning unit but also through the power wires. Therefore, the leakage current of the main power supply is greater than the total leakage current of each unit. Take into consideration the capacity of the earth leakage breaker or leakage alarm when installing one at the main power supply. To measure the leakage current simply on site, use a measurement tool equipped with a filter, and clamp all the four power wires together. The leakage current measured on the ground wire may not accurate because the leakage current from other systems may be included to the measurement value.
- ♦Do not install a phase advancing capacitor on the unit connected to the same power system with an inverter type unit and its equipment.
- ♦If a large current flows due to the product malfunctions or faulty wiring, both the earth leakage breaker on the product side and the upstream overcurrent breaker may trip almost at the same time. Separate the power system or coordinate all the breakers depending on the system's priority level.



**1-1-6. Unit installation**

- ♦Your local distributor or a qualified technician must read the Installation Manual that is provided with each unit carefully before performing installation work.
- ♦Consult your local distributor or a qualified technician when installing the unit. Improper installation by an unqualified person may result in water leakage, electric shock, or fire.
- ♦Ensure there is enough space around each unit.

**1-1-7. Optional accessories**

- ♦Only use accessories recommended by Mitsubishi Electric. Consult your local distributor or a qualified technician when installing them. Improper installation by an unqualified person may result in water leakage, electric leakage, system breakdown, or fire.
- ♦Some optional accessories may not be compatible with the air conditioning unit to be used or may not be suitable for the installation conditions. Check the compatibility when considering any accessories.
- ♦Note that some optional accessories may affect the air conditioner's external form, appearance, weight, operating sound, and other characteristics.

**1-1-8. Operation/Maintenance**

- ♦Read the Instruction Book that is provided with each unit carefully prior to use.
- ♦Maintenance or cleaning of each unit may be risky and require expertise. Read the Instruction Book to ensure safety. Consult your local distributor or a qualified technician when special expertise is required such as when the indoor unit needs to be cleaned.

## 1-2. Precautions for Indoor unit and HBC controller

### 1-2-1. Operating environment

- If the refrigerant leaks, the oxygen level may drop to harmful levels. If the air conditioner is installed in a small room, measures must be taken to prevent the refrigerant concentration from exceeding the safety limit even if the refrigerant should leak.
- If the units operate in the cooling mode at the humidity above 80%, condensation may collect and drip from the indoor units.

### 1-2-2. Unit characteristics

- The return air temperature display on the remote controller may differ from the ones on the other thermometers.
- The clock on the remote controller may be displayed with a time lag of approximately one minute every month.
- The temperature using a built-in temperature sensor on the remote controller may differ from the actual room temperature due to the effect of the wall temperature.
- Use a built-in thermostat on the remote controller or a separately-sold thermostat when indoor units installed on or in the ceiling operate the automatic cooling/heating switchover.
- The room temperature may rise drastically due to Thermo OFF in the places where the air conditioning load is large such as computer rooms.
- Be sure to use a regular filter. If an irregular filter is installed, the unit may not operate properly, and the operation noise may increase.
- The room temperature may rise over the preset temperature in the environment where the heating air conditioning load is small.

### 1-2-3. Unit installation

- The insulation for low pressure pipe between the HBC controller and outdoor unit shall be at least 20 mm thick. If the unit is installed on the top floor or in a high-temperature, high-humidity environment, thicker insulation may be necessary.
- Do not have any branching points on the downstream of the refrigerant pipe header.
- When a field-supplied external thermistor is installed or when a device for the demand control is used, abnormal stop of the unit or damage of the electromagnetic contactor may occur. Consult your local distributor for details.

### 1-3. Precautions for Outdoor unit

#### 1-3-1. Installation environment

- ♦Outdoor unit with salt-resistant specification is recommended to use in a place where it is subject to salt air.
- ♦Even when the unit with salt-resistant specification is used, it is not completely protected against corrosion. Be sure to follow the directions or precautions described in Instructions Book and Installation Manual for installation and maintenance. The salt-resistant specification is referred to the guidelines published by JRAIA (JRA9002).
- ♦Install the unit in a place where the flow of discharge air is not obstructed. If not, the short-cycling of discharge air may occur.
- ♦Provide proper drainage around the unit base, because the condensation may collect and drip from the outdoor units. Provide water-proof protection to the floor when installing the units on the rooftop.
- ♦In a region where snowfall is expected, install the unit so that the outlet faces away from the direction of the wind, and install a snow guard to protect the unit from snow. Install the unit on a base approximately 50 cm higher than the expected snowfall. Close the openings for pipes and wiring, because the ingress of water and small animals may cause equipment damage. If SUS snow guard is used, refer to the Installation Manual that comes with the snow guard and take caution for the installation to avoid the risk of corrosion.
- ♦When the unit is expected to operate continuously for a long period of time at outside air temperatures of below 0°C, take appropriate measures, such as the use of a unit base heater, to prevent icing on the unit base.
- ♦Install the snow guard so that the outlet/inlet faces away from the direction of the wind.
- ♦When the snow accumulates approximately 50 cm or more on the snow guard, remove the snow from the guard. Install a roof that is strong enough to withstand snow loads in a place where snow accumulates.
- ♦Provide proper protection around the outdoor units in places such as schools to avoid the risk of injury.
- ♦Salt-resistant unit is resistant to salt corrosion, but not salt-proof.

Please note the following when installing and maintaining outdoor units in marine atmosphere.

1. Install the salt-resistant unit out of direct exposure to sea breeze, and minimize the exposure to salt water mist.
2. Avoid installing a sun shade over the outdoor unit, so that rain will wash away salt deposits off the unit.
3. Install the unit horizontally to ensure proper water drainage from the base of the unit. Accumulation of water in the base of the outdoor unit will significantly accelerate corrosion.
4. Periodically wash salt deposits off the unit, especially when the unit is installed in a coastal area.
5. Repair all noticeable scratches after installation and during maintenance.
6. Periodically check the unit, and apply anti-rust agent and replace corroded parts as necessary.

#### 1-3-2. Unit characteristics

- ♦When the Thermo ON and OFF is frequently repeated on the indoor unit, the operation status of outdoor units may become unstable.

#### 1-3-3. Relevant equipment

- ♦Provide grounding in accordance with the local regulations.

## 1-4. Precautions for Control-related items

### 1-4-1. Product specification

- ◆ To introduce the MELANS system, a consultation with us is required in advance. Especially to introduce the electricity charge apportioning function or energy-save function, further detailed consultation is required. Consult your local distributor for details.
- ◆ Billing calculation for AE-200E/AE-50E/EW-50E/AG-150A/EB-50GU-J/TG-2000A, or the billing calculation unit is unique and based on our original method. (Backup operation is included.) It is not based on the metering method, and do not use it for official business purposes. It is not the method that the amount of electric power consumption (input) by air conditioner is calculated. Note that the electric power consumption by air conditioner is apportioned by using the ratio corresponding to the operation status (output) for each air conditioner (indoor unit) in this method.
- ◆ In the apportioned billing function for AE-200E/AE-50E/EW-50E/AG-150A and EB-50GU-J, use separate watt-hour meters for A-control units, K-control units, and packaged air conditioner for City Multi air conditioners. It is recommended to use an individual watt-hour meter for the large-capacity indoor unit (with two or more addresses).
- ◆ When using the peak cut function on the AE-200E/AE-50E/EW-50E/AG-150A or EB-50GU-J, note that the control is performed once every minute and it takes time to obtain the effect of the control. Take appropriate measures such as lowering the criterion value. Power consumption may exceed the limits if AE-200E/AE-50E/EW-50E/AG-150A or EB-50GU-J malfunctions or stops. Provide a back-up remedy as necessary.
- ◆ The controllers cannot operate while the indoor unit is OFF. (No error)  
Turn ON the power to the indoor unit when operating the controllers.
- ◆ When using the interlocked control function on the AE-200E/AE-50E/EW-50E/AG-150A/EB-50GU-J/PAC-YG66DCA or PAC-YG63MCA, do not use it for the control for the fire prevention or security. (This function should never be used in the way that would put people's lives at risk.) Provide any methods or circuit that allow ON/OFF operation using an external switch in case of failure.

### 1-4-2. Installation environment

- ◆ The surge protection for the transmission line may be required in areas where lightning strikes frequently occur.
- ◆ A receiver for a wireless remote controller may not work properly due to the effect of general lighting. Leave a space of at least 1 m between the general lighting and receiver.
- ◆ When the Auto-elevating panel is used and the operation is made by using a wired remote controller, install the wired remote controller to the place where all air conditioners controlled (at least the bottom part of them) can be seen from the wired remote controller. If not, the descending panel may cause damage or injury, and be sure to use a wireless remote controller designed for use with elevating panel (sold separately).
- ◆ Install the wired remote controller (switch box) to the place where the following conditions are met.
  - ◆ Where installation surface is flat
  - ◆ Where the remote controller can detect an accurate room temperature  
The temperature sensors that detect a room temperature are installed both on the remote controller and indoor unit. When a room temperature is detected using the sensor on the remote controller, the main remote controller is used to detect a room temperature. In this case, follow the instructions below.
    - ◆ Install the controller in a place where it is not subject to the heat source.  
(If the remote controller faces direct sunlight or supply air flow direction, the remote controller cannot detect an accurate room temperature.)
    - ◆ Install the controller in a place where an average room temperature can be detected.
    - ◆ Install the controller in a place where no other wires are present around the temperature sensor.  
(If other wires are present, the remote controller cannot detect an accurate room temperature.)
- ◆ To prevent unauthorized access, always use a security device such as a VPN router when connecting AE-200E/AE-50E/EW-50E/AG-150A/EB-50GU-J or TG-2000A to the Internet.

1. Caution for refrigerant leakage .....	2
1-1. Refrigerant property .....	2
1-2. Confirm the Critical concentration and take countermeasure .....	2
2. Installation restrictions .....	3
2-1. Outdoor units .....	3
2-2. HBC controllers .....	3

The installer and/or air conditioning system specialist shall secure safety against refrigerant leakage according to local regulations or standards. The following standard may be applicable if no local regulation or standard is available.

## 1-1. Refrigerant property

R32 refrigerant has lower flammability (A2L refrigerant: ISO817, 2014). The R32 is heavier than the indoor air in density. Leakage of the refrigerant in a room has possibility to lead to a hypoxia situation and fire. Therefore, the critical concentration specified below shall not be exceeded even if the leakage happens.

### • Critical concentration

Critical concentration hereby is the refrigerant concentration in which no human body would be hurt if immediate measures can be taken when refrigerant leakage happens.

**Critical concentration of R32: 0.063kg/m<sup>3</sup>**  
**(The weight of refrigeration gas per 1 m<sup>3</sup> air conditioning space.);**

\* The Critical concentration is subject to ISO5149 (2014), EN378-1 (2016).

For the HYBRID CITY MULTI system, the concentration of refrigerant leaked should not have a chance to exceed the critical concentration in any situation.

## 1-2. Confirm the Critical concentration and take countermeasure

The maximum refrigerant leakage concentration (Rmax) is defined as the result of the possible maximum refrigerant weight (Wmax) leaked into a room divided by its room capacity (V). The refrigerant of Outdoor unit here includes its original charge and additional charge at the site.

The additional charge is calculated according to the refrigerant charging calculation of each kind of Outdoor unit, and shall not be over charged at the site. Procedure 1-2-1~3 tells how to confirm maximum refrigerant leakage concentration (Rmax) and how to take countermeasures against a possible leakage.

1-2-1. Find the possible maximum leakage (Wmax) in the room. If a room has HBC(s) from more than 1 Outdoor unit, add up the refrigerant of the Outdoor units.

1-2-2. Divide (Wmax) by (V) to get the maximum refrigerant leakage concentration (Rmax).

1-2-3. Find if there is any room in which the maximum refrigerant leakage concentration (Rmax) is over 0.063kg/m<sup>3</sup>.

If no, then the HYBRID CITY MULTI is safe against refrigerant leakage.

If yes, following countermeasure is recommended to do at site.

Countermeasure 1: Smaller total charge (making Wmax smaller)

e.g. Avoid connecting more than 1 Outdoor unit to one room.

e.g. Using smaller model size but more Outdoor units.

e.g. Shorten the refrigerant piping as much as possible.

Note 1. In principle, MITSUBISHI ELECTRIC requires proper piping design, installation and air-tight testing after installation to avoid leakage happening.

In the area should earthquake happen, anti-vibration measures should be fully considered.

The piping should consider the extension due to the temperature variation.

Observe the following restrictions that apply to the installation of units.

2-1. Outdoor units

**⚠ WARNING**

- R32 is heavier than air—as well as other refrigerants—so tends to accumulate at the base (in the vicinity of the floor). If R32 accumulates around the base, it may reach a flammable concentration in case the room is small. To avoid ignition, maintain a safe work environment by ensuring appropriate ventilation. If the refrigerant leaks in a room or an area that has insufficient ventilation, refrain from using flames until the work environment is improved by ensuring appropriate ventilation.
- Do not install the outdoor unit in a semibasement, basement, or machinery room, where the refrigerant remains in the room when it leaks out.
- Install the outdoor unit in a space where at least one side is open.

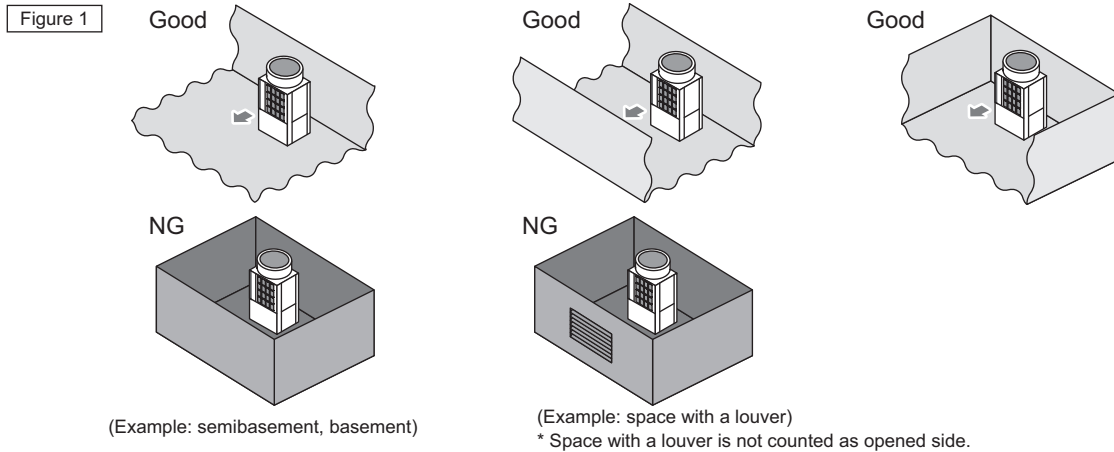

2-2. HBC controllers

**⚠ WARNING**

- There must be at least 1.8 meters from the floor to an HBC controller (indicated as H in Figure 2).

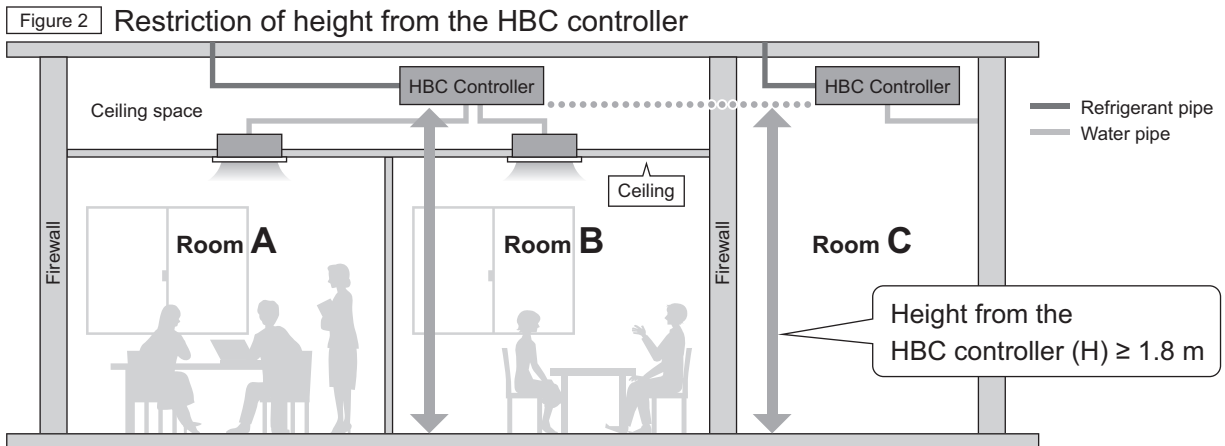

- Do not place an ignition source in a space where an HBC controller is installed or adjacent spaces not shielded by firewalls. Examples: Lighters, combustion heaters, combustion boilers, and combustion cookers
- Figure 3 shows the minimum floor areas required for given amounts of refrigerant in various refrigerant systems. Make sure the installation conditions meet the requirements shown in the figure (system refrigerant amount / minimum floor area  $\leq 0.11$ ).

Figure 3 Minimum floor area requirement (height from floor to HBC controller = 1.8 m)

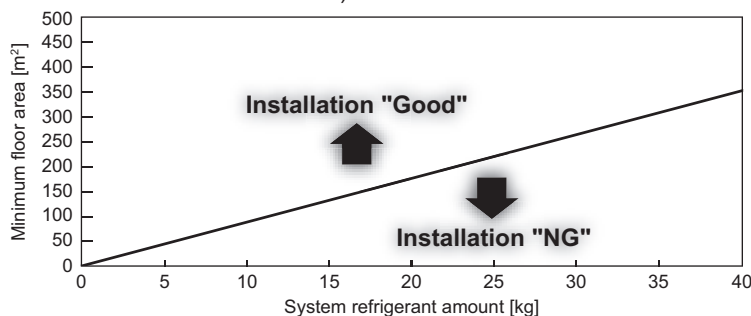

- All of the above-mentioned restrictions apply not only to new installations but also to relocations and layout changes.



Installation examples

1) When an HBC controller is installed in the ceiling space

**⚠ WARNING**

- When installing an HBC controller in a ceiling space, make sure the relationship between the total floor areas of the rooms that share the ceiling space and the total refrigerant amount in the system falls within the range. (refer to Figure 3)
- If the ceiling space is divided into separate areas by firewalls, calculate the refrigerant concentration based on the floor area of the room under the relevant enclosed ceiling area, and make sure the calculation results satisfy the installation restrictions (refer to Figure 3).
- The ceiling material should not be made of highly breathable materials (e.g., mesh ceiling).\*  
\* Highly breathable material indicates ceiling made of mesh which the unit is visible through the ceiling.
- Do not place ignition sources in the ceiling space where an HBC controller is installed.

Figure 4

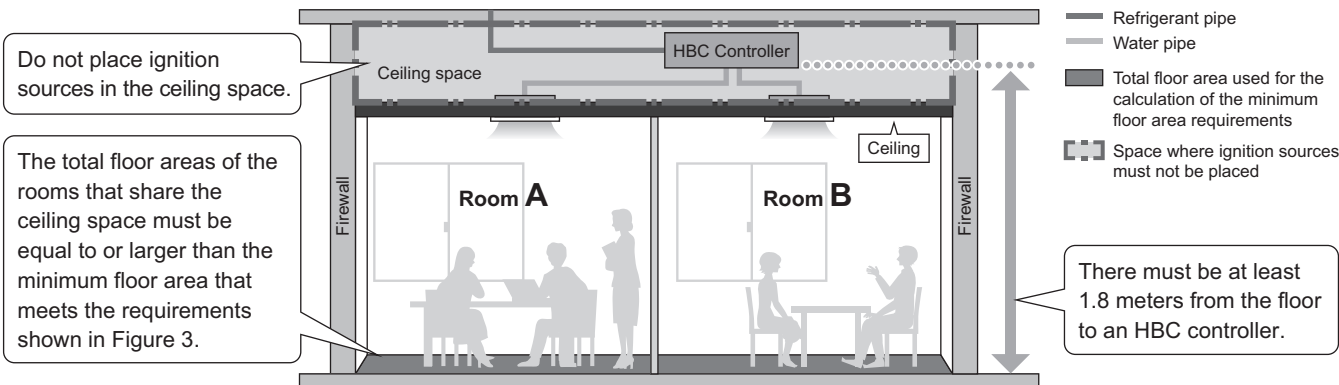

When an HBC controller is installed in the ceiling space above Room D and the ceiling is made of highly breathable material

When the ceiling is made of highly breathable material, observe the following installation instructions.

- Calculate the minimum floor area that meets the requirements shown in Figure 3 based only on the floor area of Room D.
- Do not place ignition sources in the ceiling space and Room D.

Figure 5

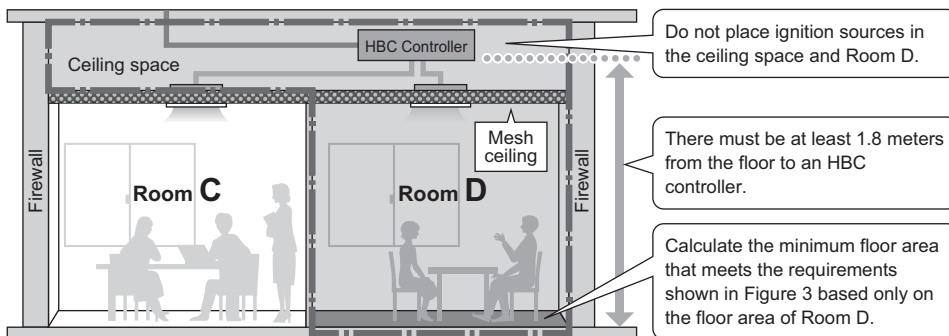

2) When an HBC controller is installed in a machine room or a riser

**⚠ WARNING**

- When installing an HBC controller in a machine room or a riser, minimum floor area requirements shown in Figure 3 (system refrigerant amount/ minimum floor area  $\leq 0.11$ ) must be observed, and the HBC controller must be installed at a height of 1.8 meters or higher.
- Do not place ignition sources where an HBC controller is placed.

Figure 6

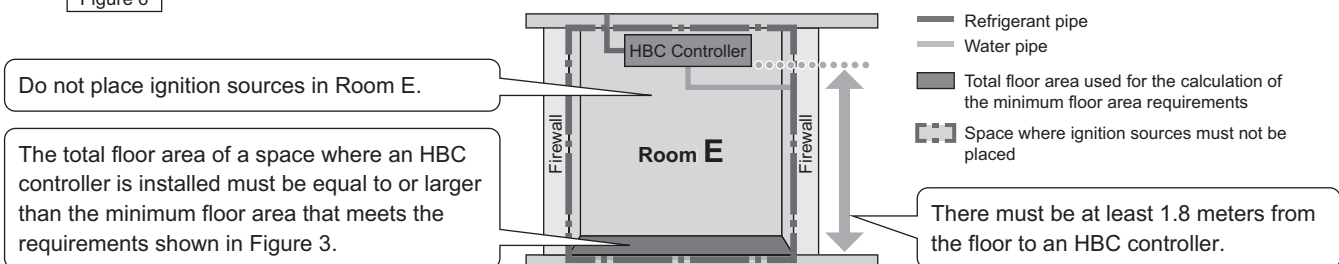



**for a greener tomorrow**

Eco Changes is the Mitsubishi Electric Group's environmental statement, and expresses the Group's stance on environmental management. Through a wide range of businesses, we are helping contribute to the realization of a sustainable society.

**⚠ Warning**

- Do not use refrigerant other than the type indicated in the manuals provided with the unit and on the nameplate.
  - Doing so may cause the unit or pipes to burst, or result in explosion or fire during use, repair, or at the time of disposal of the unit.
  - It may also be in violation of applicable laws.
  - MITSUBISHI ELECTRIC CORPORATION cannot be held responsible for malfunctions or accidents resulting from the use of the wrong type of refrigerant.
- Our air conditioning equipment and heat pumps contain a fluorinated greenhouse gas, R32.

**MITSUBISHI ELECTRIC CORPORATION**

[www.MitsubishiElectric.com](http://www.MitsubishiElectric.com)