

Air Conditioning

Product Information

PURY-P200YLM-A1
Heat Recovery Outdoor Unit (H-VRF)

Making a
World of
Difference

CITY MULTI



Throughout the year, many buildings require cooling in some areas and heating in others - even in adjacent rooms. The outstanding City Multi R2 system meets this requirement by distributing surplus heat from cooling operations (and vice versa) to rooms where it is needed. This efficiency can result in energy savings of up to 30% over conventional systems.

Key Features

- Unique 2-pipe technology means minimal disruption, quicker installation and less connections than 3 pipe equivalents
- Designed from day 1 for seasonal efficiency
- Flat tube aluminium micro-channel heat exchanger protected with a sacrificial zinc coating - a world's first in VRF providing higher heat transfer, improved efficiency and reduced weight, size and refrigerant volume
- Energy-saving inverter driven compressor with very low start currents
- Reduced standby power by up to 50% using induction heated compressor
- Utilise with the Hybrid Branch Controller (HBC) to promote all the benefits of VRF with water between the HBC and indoor unit



Air Conditioning | Heating
Ventilation | Controls

Air Conditioning

Product Information

PURY-P200YLM-A1

Heat Recovery Outdoor Unit (H-VRF)

Making a
World of
Difference

PURY - OUTDOOR UNIT		PURY-P200YLM-A1
CAPACITY (kW)	Heating (nominal)	25.0
	Cooling (nominal)	22.4
	High Performance Heating (UK)	25.0
	COP Priority Heating (UK)	22.8
	Cooling (UK)	20.0
POWER INPUT (kW)	Heating (nominal)	7.08
	Cooling (nominal)	7.00
	High Performance Heating (UK)	8.92
	COP Priority Heating (UK)	7.04
	Cooling (UK)	4.06
COP / EER (nominal)		3.53 / 3.20
SCOP / SEER (system)		5.08 / 8.50
MAX No. OF CONNECTABLE INDOOR UNITS		20
MAX CONNECTABLE CAPACITY		50~150% OU Capacity
AIRFLOW (m ³ /min)	High	185
	Gas	19.05 (3/4")
PIPE SIZE mm (in)	Liquid	15.88 (5/8")
SOUND PRESSURE LEVEL (dBA)		59
SOUND POWER LEVEL (dBA)		82.5
WEIGHT (kg)		205
DIMENSIONS (mm)	Width	920
	Depth	740
	Height (1650mm without legs)	1710
ELECTRICAL SUPPLY*		380-415v, 50Hz
PHASE*		Three
STARTING CURRENT (A)*		8
NOMINAL SYSTEM RUNNING CURRENT (A)* Heating / Cooling [MAX]		10.9 / 10.8 [16.1]
GUARANTEED OPERATING RANGE (°C) Heating / Cooling		-20~-15.5 / -5~-46
FUSE RATING (MCB sizes BS EN 60947-2) - (A)*		1 x 20
MAINS CABLE No. Cores*		4 + earth

Note: * A separate power supply is required for each module.

DIMENSIONS

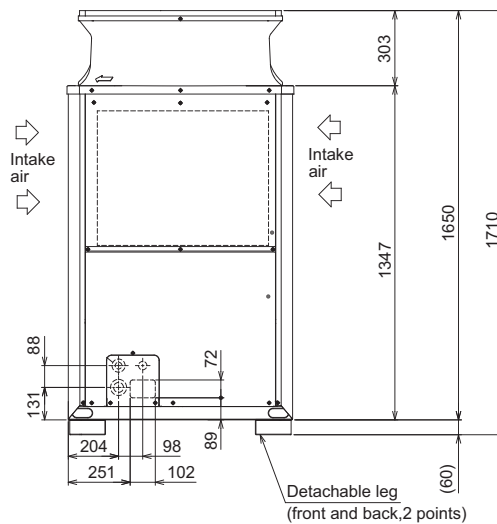
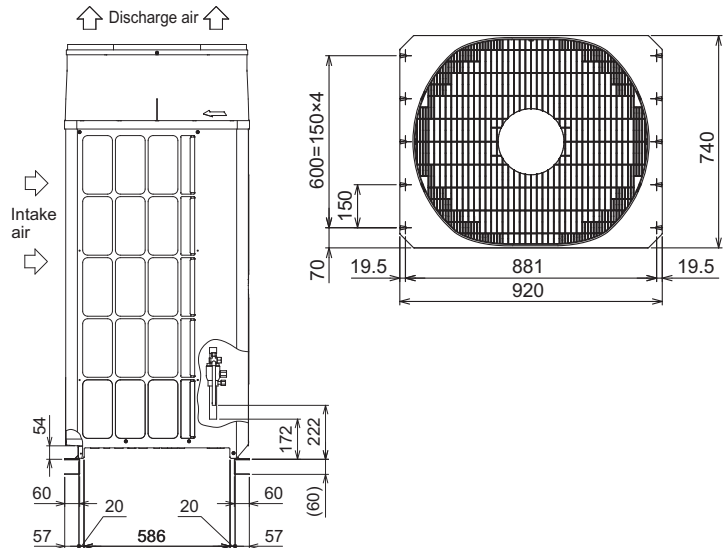

Telephone: 01707 282880

email: air.conditioning@meuk.mee.com web: www.airconditioning.mitsubishielectric.co.uk

UNITED KINGDOM Mitsubishi Electric Europe Living Environmental Systems Division
Travellers Lane, Hatfield, Hertfordshire, AL10 8XB, England General Enquiries Telephone: 01707 282880 Fax: 01707 278881

IRELAND Mitsubishi Electric Europe Westgate Business Park, Ballymount, Dublin 24, Ireland
Telephone: Dublin (01) 419 8800 Fax: Dublin (01) 419 8890 International code: (003531)

Country of origin: United Kingdom - Japan - Thailand - Malaysia. ©Mitsubishi Electric Europe 2016. Mitsubishi and Mitsubishi Electric are trademarks of Mitsubishi Electric Europe B.V. The company reserves the right to make any variation in technical specification to the equipment described, or to withdraw or replace products without prior notification or public announcement. Mitsubishi Electric is constantly developing and improving its products. All descriptions, illustrations, drawings and specifications in this publication present only general particulars and shall not form part of any contract. All goods are supplied subject to the Company's General Conditions of Sale, a copy of which is available on request. Third-party product and brand names may be trademarks or registered trademarks of their respective owners.



Note: The fuse rating is for guidance only. Please refer to the relevant databook for detailed specification. It is the responsibility of a qualified electrician/electrical engineer to select the correct cable size and fuse rating based on current regulation and site specific conditions. Mitsubishi Electric's air conditioning and heat pump systems contain fluorinated greenhouse gases R410A, R407C and R134a.



www.greengateway.mitsubishielectric.co.uk

Mitsubishi Electric UK's commitment to the environment

Follow us @meuk_les
Follow us @green_gateway

Mitsubishi Electric
Living Environmental Systems UK

YouTube
mitsubishielectric2

Effective as of February 2016