

Changes for the Better

Ground Source Heat Pump

for a greener tomorrow 

MODEL

CRHV-P600YA-HPB

DATA BOOK

Contents

I Product Specifications

1. Specifications2
2. External Dimensions.....4
3. Center of Gravity.....5
4. Electrical Wiring Diagrams6
5. Optional parts.....9
 - (1) Remote controller PAR-W21MAA
 - (2) Y-shaped strainer YS-50A
 - (3) Representative-water temperature sensor TW-TH16

II Product Data

1. Maximum capacity chart..... 11
2. Capacity tables 13
3. Correction by water flow rate 37
4. Water pressure drop 38
5. Operation temperature range..... 38
6. Characteristics of the brine 39
7. Sound pressure levels 40
8. Vibration levels..... 41

III Installation

1. Selecting the Installation Site..... 42
 - (1) Installation conditions
2. Installation of unit..... 43
 - (1) Product suspension method
 - (2) Installation on foundation

IV System Design

1. Water pipe installation 44
 - (1) Schematic Piping Diagram and Piping System Components
 - (2) Water piping attachment method
 - (3) Notes on Pipe Corrosion
 - (4) Installing the water pipes
2. Ensuring enough water in the water circuit .. 50
 - (1) Required amount of water
 - (2) Calculating the required amount of water in the water circuit
3. Pipe connection size and material..... 50

V Wiring Design

1. Electrical wiring installation 51
 - (1) Main Power Supply Wiring and Switch Capacity
 - (2) Cable connections
 - (3) Installing the conduit tube
2. System configurations 54
 - (1) Types of control cables
 - (2) System Configuration

VI Controller

1. PAR-W21MAA specifications 55

I | Product Specifications

1. Specifications

When using brine as heat source fluid (factory setting)

Model			CRHV-P600YA-HPB	
Power Source			3-phase 4-wire 380-400-415V 50Hz	
SCOP (TDesign60kW): EN14825	Heat source temp 0/-3, Hot water temp 30/35		4.33	
Average climate conditions	Heat source temp 0/-3, Hot water temp 47/55		2.86	
Capacity1 *1			kW	60.0
			kcal/h	51,600
			BTU/h	204,720
	Power input *2		kW	14.2
	Current input 380-400-415V		A	24.0 - 22.8 - 22.0
	COP (kW/kW)			4.23
	Hot water flow rate		m ³ /h	10.3
	Heat source flow rate		m ³ /h	14.7
Capacity2 *1			kW	45.0
			kcal/h	38,700
			BTU/h	153,540
	Power input *2		kW	10.2
	Current input 380-400-415V		A	17.2 - 16.4 - 15.8
	COP (kW/kW)			4.41
	Hot water flow rate		m ³ /h	7.7
	Heat source flow rate		m ³ /h	11.2
Maximum current input			A	44
Heat source fluid type			ethylene glycol 35WT% (freezing point -18°C (-0.4°F))	
Water pressure drop	Hot water side *3	kPa	14	
	Heat source side *3	kPa	38	
Temp range	Hot water side	°C	outlet water 30~65 *5	
		°F	outlet water 86~149 *5	
	Heat source side *4	°C	(inlet) less than 45, (outlet) -8~27	
		°F	(inlet) less than 104, (outlet) 17.6~80.6	
Circulating water volume range	Hot water side	m ³ /h	3.2 - 15.0	
	Heat source side *6	m ³ /h	2.0 - 16.0	
Sound pressure level (measured in anechoic room) at 1m *3			dB (A)	50
Sound power level (measured in anechoic room) *3			dB (A)	66
Diameter of water pipe (hot water side)	Inlet	mm (in.)	50.8 (R2") screw	
	Outlet	mm (in.)	50.8 (R2") screw	
Diameter of water pipe (heat source side)	Inlet	mm (in.)	50.8 (R2") screw	
	Outlet	mm (in.)	50.8 (R2") screw	
External finish			Unpainted steel plate	
External dimension H x W x D			mm	1,561 x 934 x 780
Net weight			kg (lbs)	395 (871)
Design pressure	R410A	MPa	4.15	
	Water	MPa	1.0	
Drawing	Wiring		WKC94L652	
	External		WKC94L810	
Heat exchanger	Hot water side		stainless steel plate and copper brazing	
	Heat source side		stainless steel plate and copper brazing	
Compressor	Type		Inverter scroll hermetic compressor	
	Maker		MITSUBISHI ELECTRIC CORPORATION	
	Starting method		Inverter	
	Case heater	kW	0.035 x 2	
	Lubricant		MEL32	
Protection	High pressure protection		High pres.Sensor & High pres.Switch at 4.15MPa (601psi)	
	Inverter circuit		Over-heat protection, Over current protection	
	Compressor		Over-heat protection	
Refrigerant	Type x original charge		R410A x 4.5(kg) x 2	
	Control		LEV and HIC circuit	

*1 Under Normal heating conditions at outlet hot water temp 35°C (95°F) outlet heat source temp -3°C (26.6°F) inlet hot water temp 30°C (86°F) inlet heat source temp 0°C (32°F). Heating performance indicates the performance with counter flow of brine and refrigerant at the heat source HEX. (Standard pipe connection)

*2 Includes pump input based on EN14511.

*3 Under Normal heating conditions at outlet hot water temp 35°C (95°F) outlet heat source temp -3°C (26.6°F) inlet hot water temp 30°C (86°F) inlet heat source temp 0°C (32°F) capacity 60kW hot water flow rate 10.3m³/h heat source flow rate 14.7m³/h Heating performance indicates the performance with counter flow of brine and refrigerant at the heat source HEX. (Standard pipe connection)

*4 When using in inlet heat source temp is more than 27°C, please change to parallel piping at the heat source side.

- If the heat source inlet temperature exceeds 45 °C, the compressor may not function due to over current.
- * Please don't use the steel material for the water piping material.
- * Please always make water circulate or pull out the circulation water completely when not using it.
- * Please do not use groundwater and well water in direct.
- * The water circuit must use the closed circuit.

* Due to continuing improvement, the above specifications may be subject to change without notice.

*5

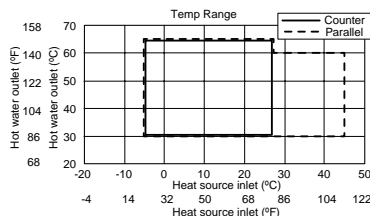

*6

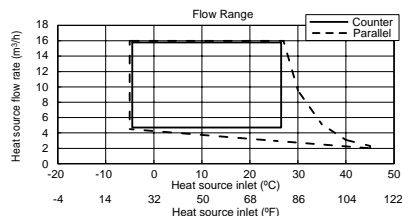

Unit converter
 kcal/h =kW x 860
 BTU/h =kW x 3,412
 lbs =kg/0.4536

When using water as heat source fluid

Model			CRHV-P600YA-HPB	
Power Source			3-phase 4-wire 380-400-415V 50Hz	
SCOP (TDesign60kW): EN14825	Heat source temp 10/7, Hot water temp 30/35		4.77	
Average climate conditions	Heat source temp 10/7, Hot water temp 47/55		3.11	
Capacity1 *1			kW	60.0
			kcal/h	51,600
			BTU/h	204,720
	Power input *2		kW	11.8
	Current input 380-400-415V		A	19.9 - 18.9 - 18.2
	COP (kW/kW)			5.08
	Hot water flow rate		m ³ /h	10.3
	Heat source flow rate		m ³ /h	13.8
Capacity2 *1			kW	45.0
			kcal/h	38,700
			BTU/h	153,540
	Power input *2		kW	8.8
	Current input 380-400-415V		A	14.9 - 14.1 - 13.6
	COP (kW/kW)			5.11
	Hot water flow rate		m ³ /h	7.7
	Heat source flow rate		m ³ /h	10.4
Maximum current input			A	44
Heat source fluid type			water (freezing point 0°C (32°F))	
Water pressure drop	Hot water side *3	kPa	14	
	Heat source side *3	kPa	24	
Temp range	Hot water side	°C	outlet water 30~65 *5	
		°F	outlet water 86~149 *5	
	Heat source side *4	°C	(inlet) less than 45, (outlet) 7~27	
		°F	(inlet) less than 104, (outlet) 44.6~80.6	
Circulating water volume range	Hot water side	m ³ /h	3.2 - 15.0	
	Heat source side *6	m ³ /h	2.0 - 16.0	
Sound pressure level (measured in anechoic room) at 1m *3			dB (A)	50
Sound power level (measured in anechoic room) *3			dB (A)	66
Diameter of water pipe (hot water side)	Inlet	mm (in.)	50.8 (R2") screw	
	Outlet	mm (in.)	50.8 (R2") screw	
Diameter of water pipe (heat source side)	Inlet	mm (in.)	50.8 (R2") screw	
	Outlet	mm (in.)	50.8 (R2") screw	
External finish			Unpainted steel plate	
External dimension H x W x D			mm	1,561 x 934 x 780
Net weight			kg (lbs)	395 (871)
Design pressure	R410A	MPa	4.15	
	Water	MPa	1.0	
Drawing	Wiring		WKC94L652	
	External		WKC94L810	
Heat exchanger	Hot water side		stainless steel plate and copper brazing	
	Heat source side		stainless steel plate and copper brazing	
Compressor	Type		Inverter scroll hermetic compressor	
	Maker		MITSUBISHI ELECTRIC CORPORATION	
	Starting method		Inverter	
	Case heater	kW	0.035 x 2	
	Lubricant		MEL32	
Protection	High pressure protection		High pres.Sensor & High pres.Switch at 4.15MPa (601psi)	
	Inverter circuit		Over-heat protection, Over current protection	
	Compressor		Over-heat protection	
Refrigerant	Type x original charge		R410A x 4.5(kg) x 2	
	Control		LEV and HIC circuit	

*1 Under Normal heating conditions at outlet hot water temp 35°C (95 F) outlet heat source temp 7°C (44.6 F) inlet hot water temp 30°C (86 F) inlet heat source temp 10°C (50 F). Heating performance indicates the performance with counter flow of brine and refrigerant at the heat source HEX. (Standard pipe connection)

*2 Includes pump input based on EN14511.

*3 Under Normal heating conditions at outlet hot water temp 35°C (95 F) outlet heat source temp 7°C (44.6 F) inlet hot water temp 30°C (86 F) inlet heat source temp 10°C (50 F) capacity 60kW hot water flow rate 10.3m³/h heat source flow rate 13.8m³/h Heating performance indicates the performance with counter flow of brine and refrigerant at the heat source HEX. (Standard pipe connection)

*4 When using in inlet heat source temp is more than 27°C, please change to parallel piping at the heat source side.

- If the heat source inlet temperature exceeds 45 °C, the compressor may not function due to over current.
- * Please don't use the steel material for the water piping material.
- * Please always make water circulate or pull out the circulation water completely when not using it.
- * Please do not use groundwater and well water in direct.
- * The water circuit must use the closed circuit.

* Due to continuing improvement, the above specifications may be subject to change without notice.

*5

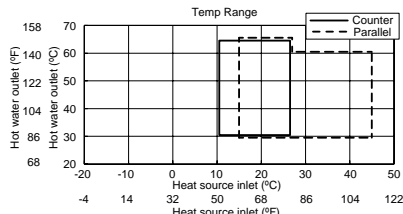

*6

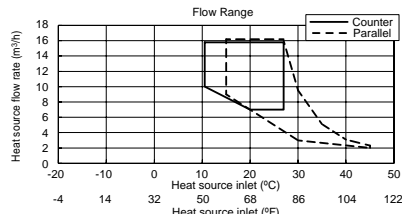

Unit converter
 kcal/h =kW x 860
 BTU/h =kW x 3,412
 lbs =kg/0.4536

2. External Dimensions

- CRHV-P600YA-HPB

Unit: mm

<Option YS-50A>
 . Y-shaped strainer 50A<Bronze> . . . 2 pieces
 (This is for the water piping.
 Please install it near
 the hotwater inlet and heat source water inlet.)

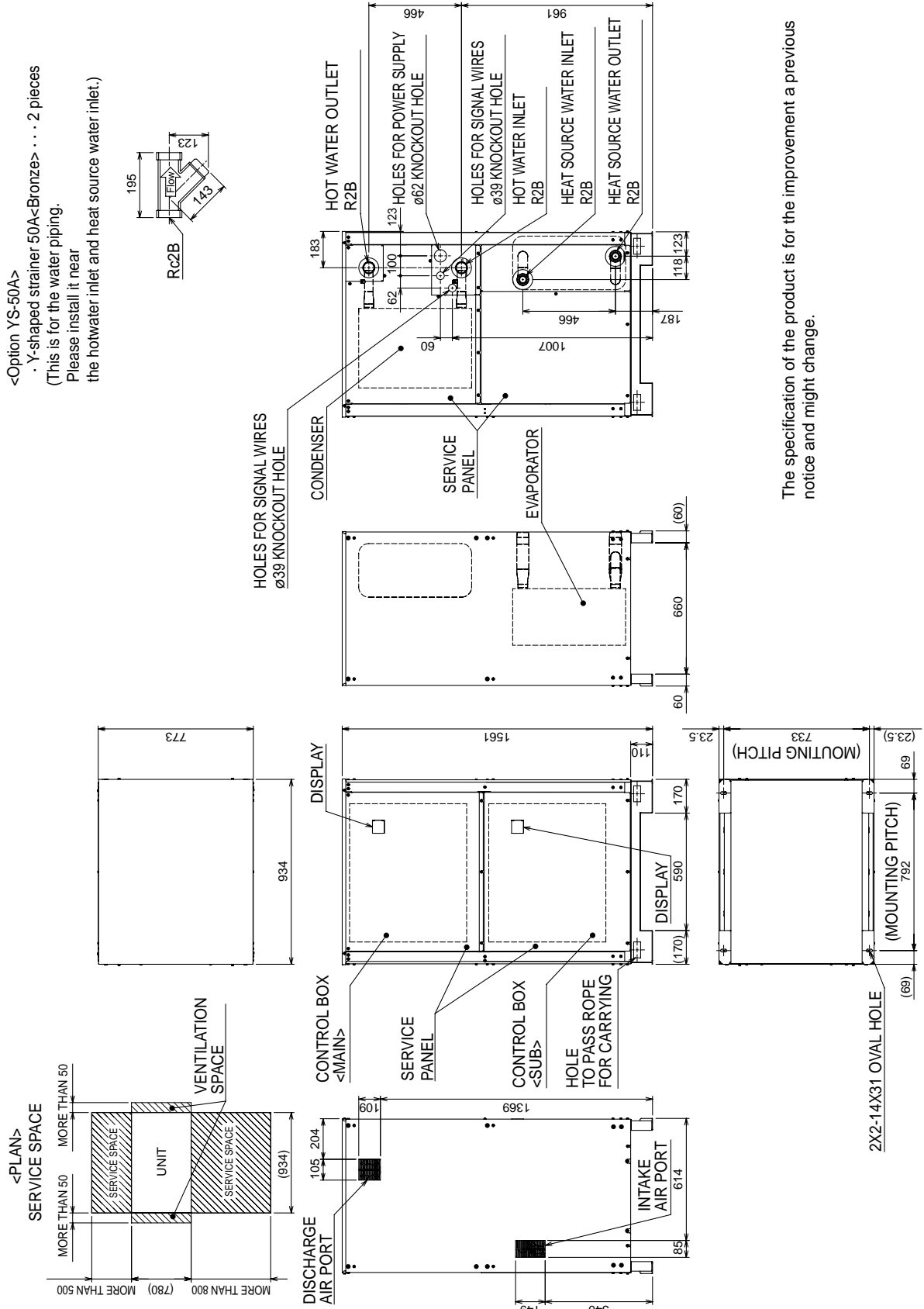
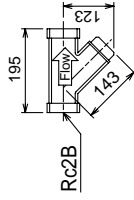

The specification of the product is for the improvement a previous notice and might change.

3. Center of Gravity

- CRHV-P600YA-HPB

Unit: mm

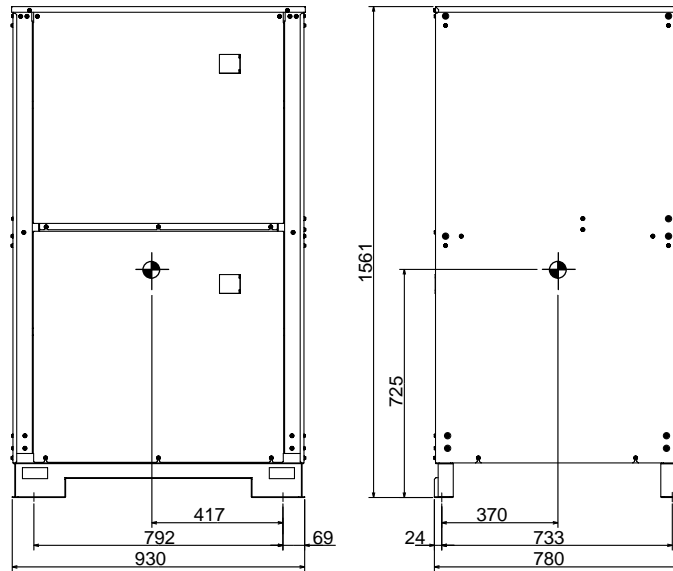

4. Electrical Wiring Diagrams

• CRHV-P600YA-HPB

- Note1. Single-dotted lines indicate field wiring.
- Note2. The symbols of the field connecting terminals are as follows.
○: Terminal block x-Connection by cutting the short circuit wire
- Note3. Faston terminals have a locking function.
Press the tab in the middle of the terminals to remove them.
Check that the terminals are securely locked in place after insertion.
- Note4. Remove the short circuit wire between the terminals 25 and 27 to connect a flow switch.
- Note5. Be sure to connect the wires from Terminals 11 and Terminals 12 to the interlock contact on the pump.
- Note6. A short-circuit may cause abnormal stop or malfunctions.
Operation signals can be received from through the dry contact.
- Note7. Need to select either Water temperature setting input signal or Capacity control input signal.
Set the SW421 and input the item code 21, 1051 (by SW2 and SW3) corresponding to the input signal as shown in the table below.

SW421-1/SW421-2	ITEM CODE 21	ITEM CODE 1051
4~20mA	ON	0
0~10V	OFF	1
1~5V	OFF	2
2~10V	OFF	3

- Note8. Use a 4-20mA signal output device with insulation.
- Note9. Make sure that on site terminal connection is correct.
With wrong connection, operation error may occur.
- Note10. After switching ON-OFF, the power reset function is enabled.
To prevent the heat exchanger from freezing, make sure to switch OFF if using water on the heat source.

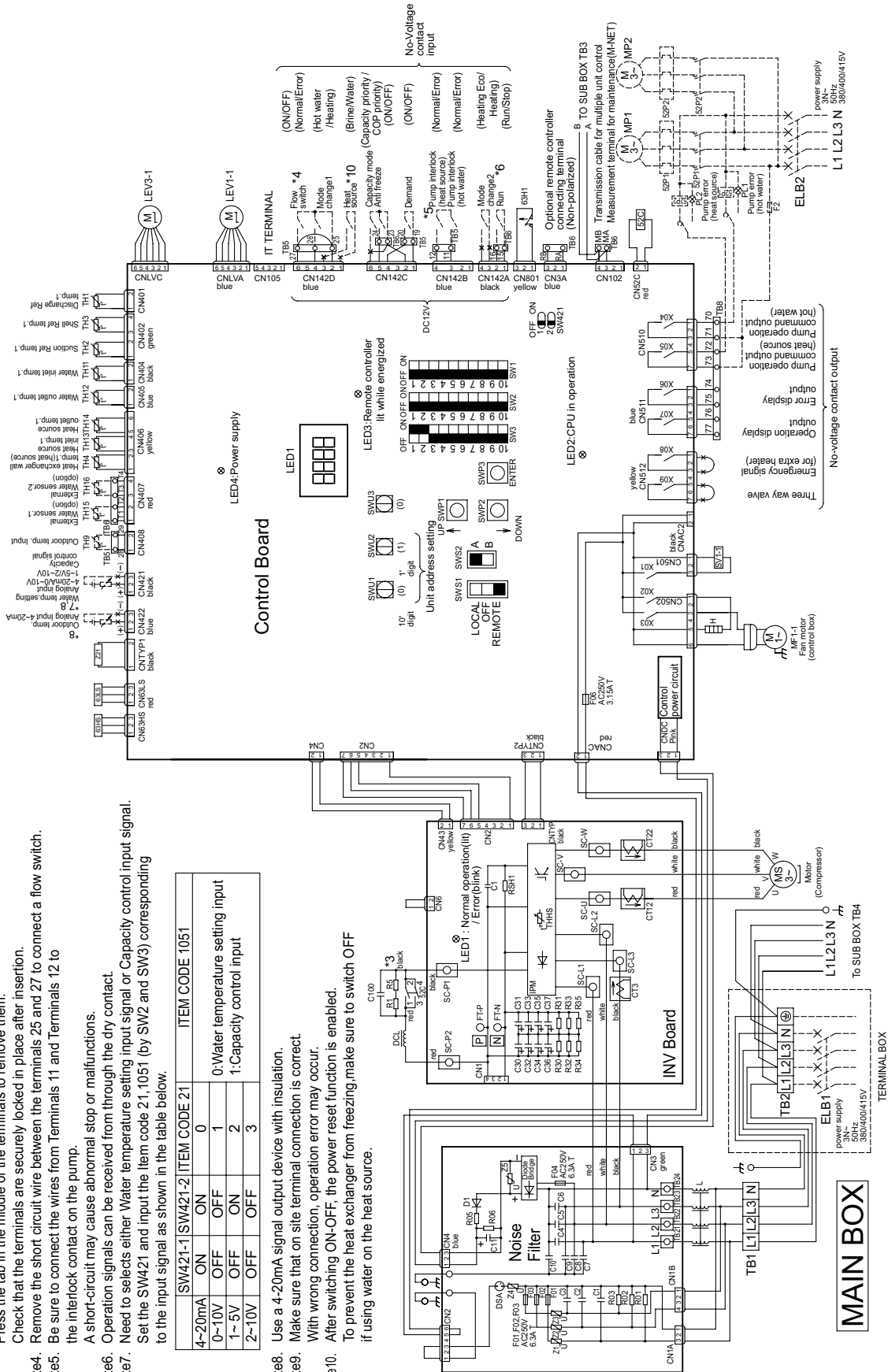

The specification of the product is for the improvement a previous notice and might change.

• CRHV-P600YA-HPB

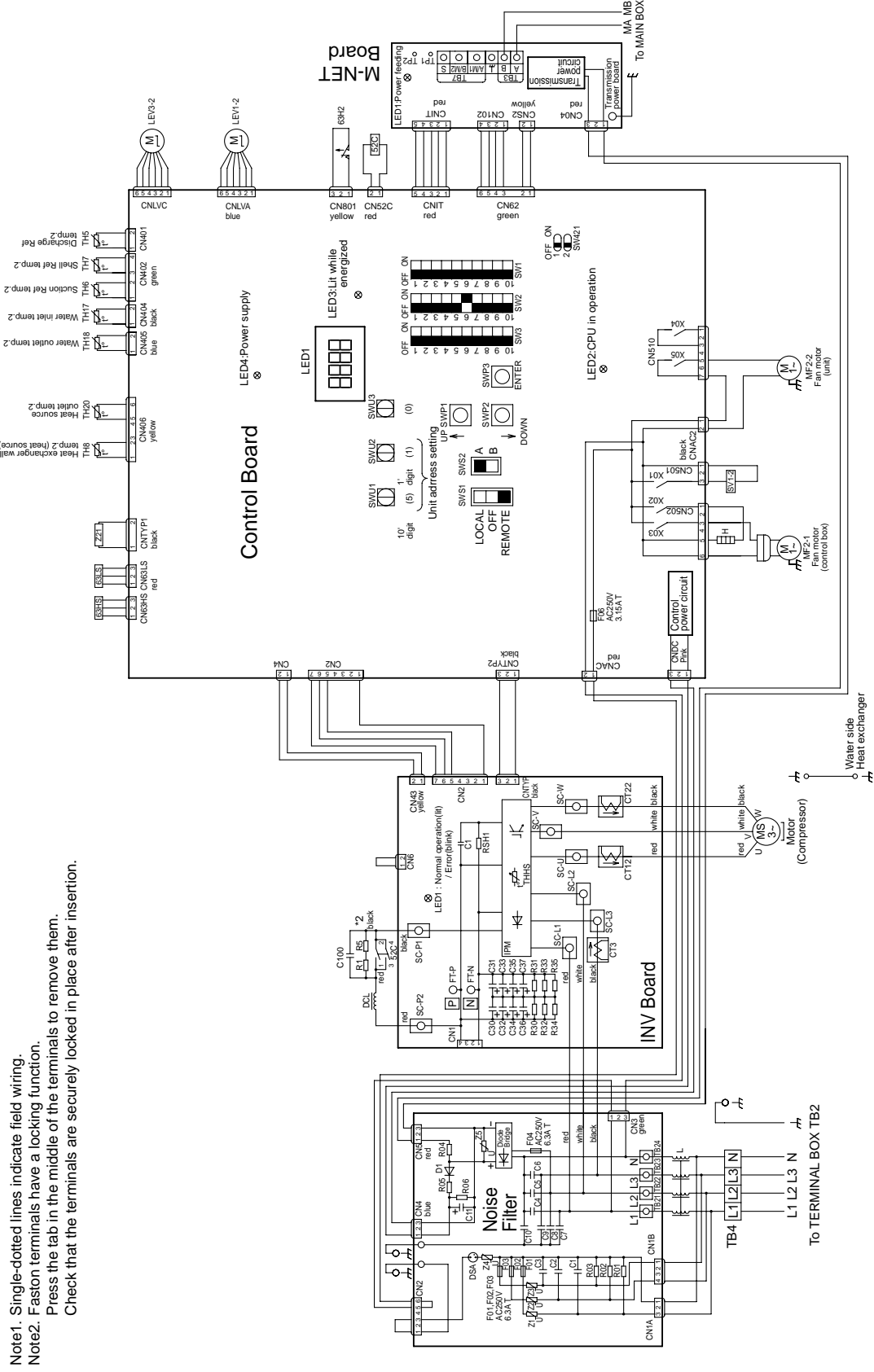

Note1. Single-dotted lines indicate field wiring.
 Note2. Faston terminals have a locking function.
 Press the tab in the middle of the terminals to remove them.
 Check that the terminals are securely locked in place after insertion.

Symbol explanation

Symbol	explanation
CT12	Ac current sensor
CT22	
CT13	Capacitor (Electrolysis)
CT100	DC reactor
DCL	
F01	Fuse (Noise Filter)
F02	
F03	
F04	Fuse (Control Board)
F06	Crankcase heater (for heating the compressor)
H1	Electrical resistance
R1	
R5	IPM temperature
THHS	Function setting connector
Z21	Electromagnetic relay (Inverter main circuit)
52C	Electromagnetic relay (Inverter main circuit)
63HS	High pressure sensor
63LS	Low pressure sensor
LEV1-1	Electronic expansion valve (Main circuit)
LEV3-1	Electronic expansion valve (Main injection circuit)
SV1-1	Solenoid valve (Main injection circuit)
TH1-4,11~16	Thermistor
63H1	Thermistor
LEV1-2	Electronic expansion valve (Main circuit)
LEV3-2	Electronic expansion valve (Sub circuit)
SV1-2	Electronic expansion valve (Sub injection circuit)
TH5,8,17,18,20	Solenoid valve (Injection circuit)
63H2	Thermistor
<F2>	High pressure switch (Sub circuit)
<ELB1,2>	Earth leakage breaker
<F2>	Fuse
<MP1,2>	Pump motor
<PL1,2>	Pilot lamp (Pump)
<TH9>	Thermistor
<51P1,2>	Overcurrent relay (Pump)
<52P1,2>	Electromagnetic contactor (Pump)

Note

- The broken lines indicate the optional parts, field-supplied parts, and field work.
- Make sure to connect a pump interlock contact.
- A short-circuit may cause abnormal stop or malfunctions. The preset temperature setting can be switched from the no-voltage contact or by setting time ranges.
- Leave a space of at least 5 cm between the low voltage external wiring (no-voltage contact input and remote controller wiring) and wiring of 100V or greater. Do not place them in the same conduit tube or cable tray as this will damage the circuit board.
- When cable tray is used for the control cable wiring, use a separate cable tray for the following wiring.
Using the same cable tray may cause malfunctions and damage to the unit.
(a) Optional remote controller wiring
(b) No-voltage contact input wiring
(c) No-voltage contact output wiring
(d) Remote water temperature setting
- Use a contact that takes 12VDC 5mA for no-voltage contact input.

5. Optional parts

(1) Remote controller PAR-W21MAA

Refer to Chapter VI "Controller", section 1. "PAR-W21MAA specifications".

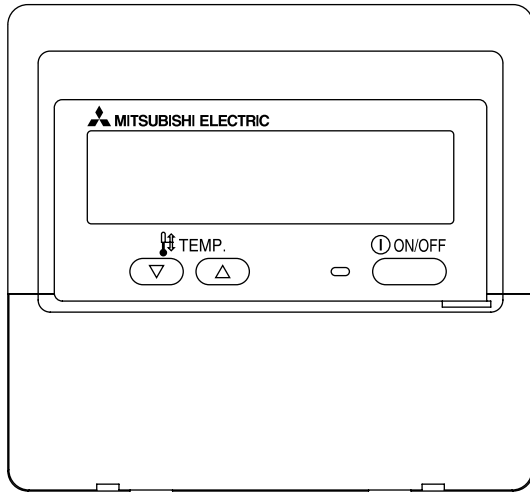

Panel closed

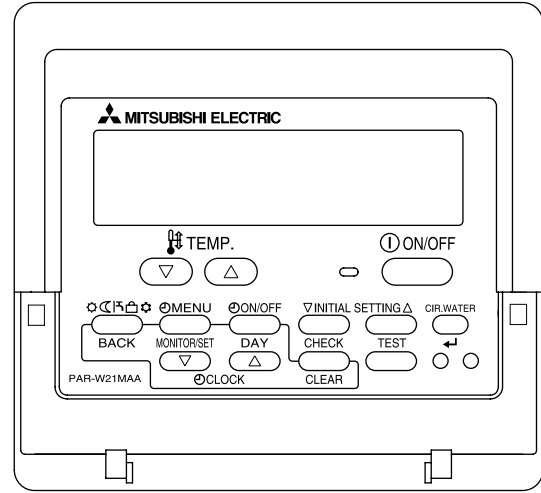

Panel open

(2) Y-shaped strainer YS-50A

Refer to Chapter IV "System Design", section 1. "Water pipe installation".

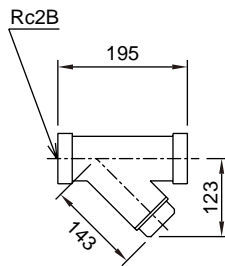

<Unit: mm>

Recommended torque : 200±20 (N·m)

(3) Representative-water temperature sensor TW-TH16

(3)-1 Required parts for installing a representative-water temperature sensor

- a) Representative-water temperature sensor
 - b) Cable for connecting between the sensor and the unit*
 - c) Cable terminal for connecting to the sensor and the unit terminal block*
(Terminals for M4 screws x 4)*
- * a) and b) are field-supplied.

Cable specifications

Size	2-core, 1.25 mm ² or larger
Type	CVVS or CPEVS
Length	20m

(3)-2 Installing a representative-water temperature sensor

As shown in the figures at right, install the sensor at the merged part of water pipes or the load-side tank. The sensor can be installed in either the vertical or the horizontal position.

When installing the sensor in the horizontal position, make sure to place the cable-access-hole side down.

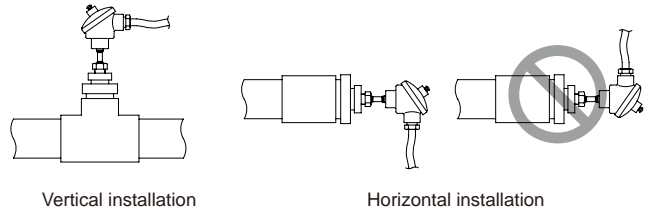

Vertical installation

Horizontal installation

(3)-3 Wiring for a representative-water temperature sensor

As shown in the figures below, connect the cable to the representative-water temperature sensor and the terminal block in the unit control box.

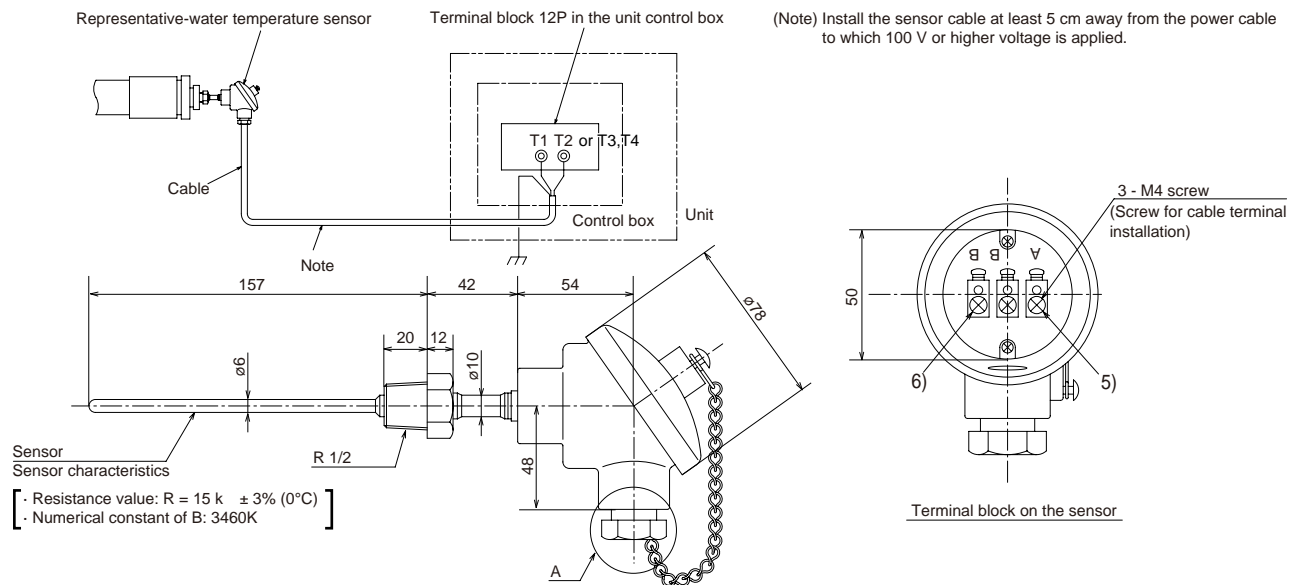

On the unit side, connect the sensor cable to the terminals T1 and T2 in the terminal block 12P in the unit control box.

Connect the shielded cable to the ground terminal.

On the sensor side, as shown in the figure at right, run the cable through 4), 3), and 2), attach the field-supplied terminals for M4 screws to the cable, and then connect the terminals to the screws 5) and 6) (terminal A and B).

Cut the shielded cable and leave it unconnected. (On the unit side, the shielded cable should be connected to the ground terminal already.)

Tighten the tightening screw 4), and caulk the gap between the tightening screw 4) and cable 1) to prevent water leakage.

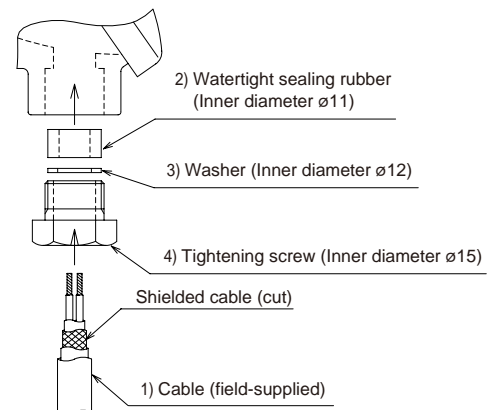

Enlarged view of area A: Cable installation

II | Product Data

1. Maximum capacity chart

• CRHV-P600YA-HPB

Ⓐ Heat source flow rate: 14.7m³/h
 Hot water flow rate: 10.3m³/h
 counter flow
 BRINE: ethylene glycol 35WT%

Ⓑ Heat source flow rate: 14.7m³/h
 Hot water flow rate: 3.9m³/h
 counter flow
 BRINE: ethylene glycol 35WT%

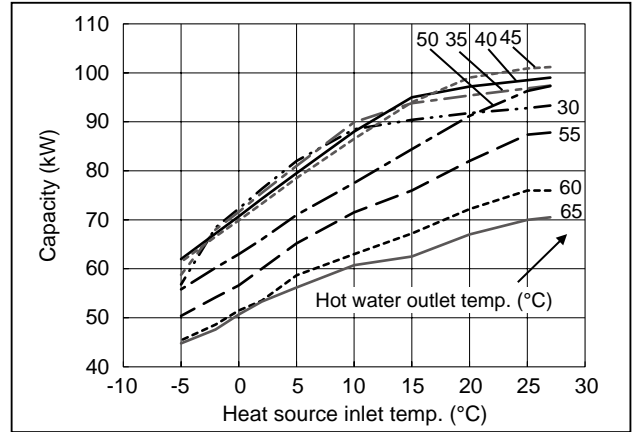
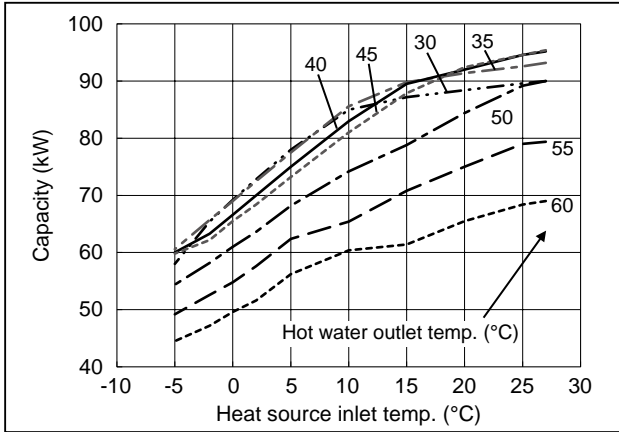

Ⓒ Inlet heat source: -5~35°C Inlet heat source: 40~45°C
 Heat source flow rate: 4.5m³/h Heat source flow rate: 2.3m³/h
 Hot water flow rate: 10.3m³/h Hot water flow rate: 10.3m³/h
 parallel flow
 BRINE: ethylene glycol 35WT%

Ⓓ Inlet heat source: -5~35°C Inlet heat source: 40~45°C
 Heat source flow rate: 4.5m³/h Heat source flow rate: 2.3m³/h
 Hot water flow rate: 3.9m³/h Hot water flow rate: 3.9m³/h
 parallel flow
 BRINE: ethylene glycol 35WT%

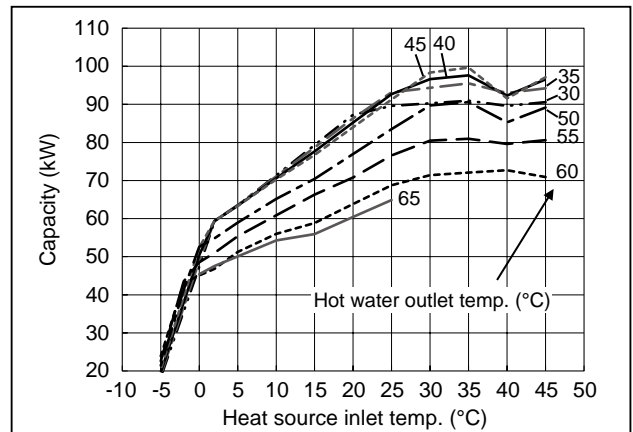
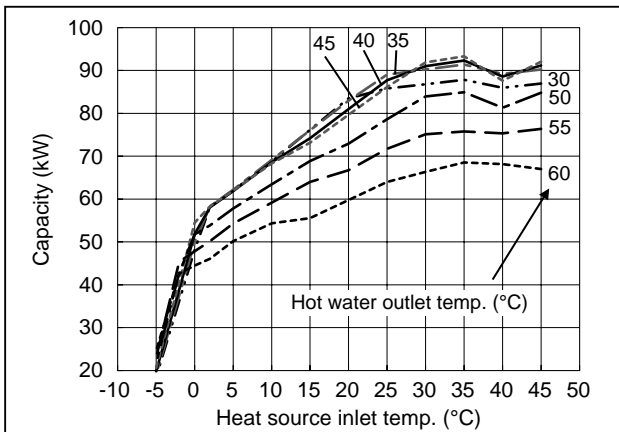

(E) Inlet heat source: 10~27°C
 Heat source flow rate: 13.8m³/h
 Hot water flow rate: 10.3m³/h
 counter flow
 water

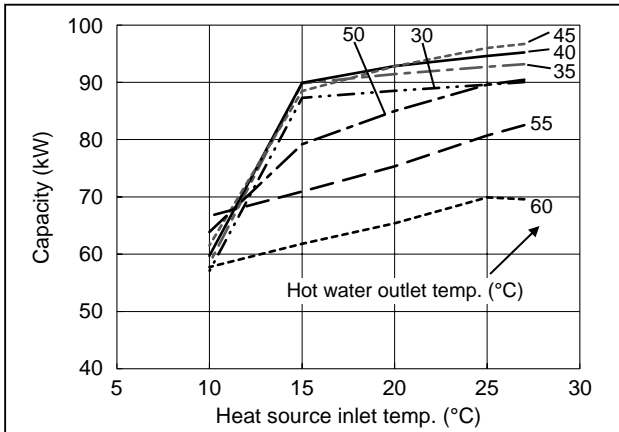

(F) Inlet heat source: 10~27°C
 Heat source flow rate: 13.8m³/h
 Hot water flow rate: 3.9m³/h
 counter flow
 water

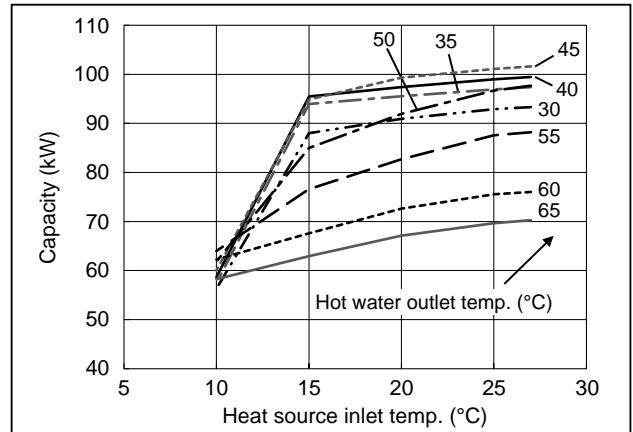

(G) Inlet heat source: 15~30°C Inlet heat source: 32~35°C
 Heat source flow rate: 9.0m³/h Heat source flow rate: 5.0m³/h
 Hot water flow rate: 10.3m³/h Hot water flow rate: 10.3m³/h

 Inlet heat source: 40~45°C
 Heat source flow rate: 2.3m³/h
 Hot water flow rate: 10.3m³/h
 parallel flow
 water

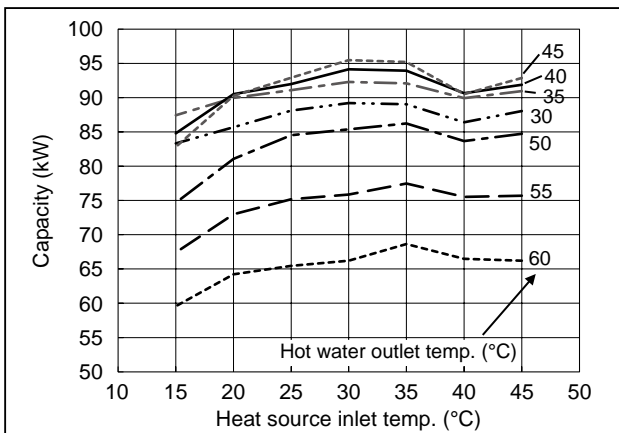

(H) Inlet heat source: 15~30°C Inlet heat source: 32~35°C
 Heat source flow rate: 9.0m³/h Heat source flow rate: 5.0m³/h
 Hot water flow rate: 3.9m³/h Hot water flow rate: 3.9m³/h

 Inlet heat source: 40~45°C
 Heat source flow rate: 2.3m³/h
 Hot water flow rate: 3.9m³/h
 parallel flow
 water

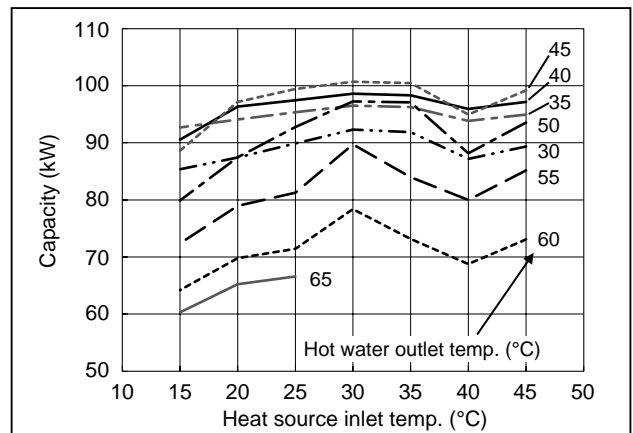

2. Capacity tables

(1)-1 counter flow, BRINE: ethylene glycol 35WT%

hot water flow rate	10.3 m ³ /h
heat source flow rate	14.7 m ³ /h

Capacity	inlet heat source temp (°C)	COP for heating								
		outlet hot water temp (°C)								
		30	35	40	45	50	55	60	65	
150% <90kW>	-5	-	-	-	-	-	-	-	-	-
	-2	-	-	-	-	-	-	-	-	-
	0	-	-	-	-	-	-	-	-	-
	2	-	-	-	-	-	-	-	-	-
	5	-	-	-	-	-	-	-	-	-
	10	-	-	-	-	-	-	-	-	-
	15	-	-	-	-	-	-	-	-	-
	20	-	5.17	4.92	4.52	-	-	-	-	-
	25	-	5.33	5.11	4.76	-	-	-	-	-
27	-	5.39	5.17	4.81	4.35	-	-	-	-	
125% <75kW>	-5	-	-	-	-	-	-	-	-	-
	-2	-	-	-	-	-	-	-	-	-
	0	-	-	-	-	-	-	-	-	-
	2	-	-	-	-	-	-	-	-	-
	5	5.03	4.49	-	-	-	-	-	-	-
	10	5.60	5.00	4.52	4.03	-	-	-	-	-
	15	6.00	5.39	4.88	4.38	3.87	-	-	-	-
	20	6.20	5.73	5.21	4.66	4.12	3.62	-	-	-
	25	6.30	5.95	5.40	4.84	4.29	3.83	-	-	-
27	6.36	5.95	5.43	4.87	4.31	3.87	-	-	-	
100% <60kW>	-5	4.05	3.68	3.35	-	-	-	-	-	-
	-2	4.48	4.03	3.66	3.30	-	-	-	-	-
	0	4.69	4.23	3.85	3.47	3.09	-	-	-	-
	2	4.92	4.41	4.03	3.61	3.23	-	-	-	-
	5	5.17	4.65	4.20	3.77	3.37	-	-	-	-
	10	5.61	5.04	4.58	4.11	3.64	3.23	-	-	-
	15	6.05	5.42	4.91	4.40	3.90	3.45	3.03	-	-
	20	6.45	5.77	5.22	4.69	4.14	3.68	3.23	-	-
	25	6.52	5.88	5.31	4.76	4.23	3.77	3.35	-	-
27	6.52	5.88	5.31	4.80	4.26	3.80	3.37	-	-	
75% <45kW>	-5	4.21	3.81	3.46	3.13	2.81	2.53	-	-	-
	-2	4.55	4.05	3.69	3.36	3.00	2.69	-	-	-
	0	4.74	4.25	3.85	3.44	3.06	2.74	-	-	-
	2	4.89	4.41	3.98	3.57	3.19	2.85	-	-	-
	5	5.23	4.64	4.21	3.78	3.36	3.00	-	-	-
	10	5.70	5.06	4.59	4.09	3.63	3.21	-	-	-
	15	6.06	5.44	4.94	4.43	3.91	3.47	-	-	-
	20	6.34	5.70	5.17	4.64	4.13	3.66	-	-	-
	25	6.34	5.70	5.23	4.69	4.17	3.72	-	-	-
27	6.34	5.77	5.23	4.69	4.17	3.72	-	-	-	
50% <30kW>	-5	4.23	3.80	3.45	3.13	2.78	2.52	-	-	-
	-2	4.48	4.05	3.66	3.30	2.97	2.65	-	-	-
	0	4.62	4.17	3.80	3.41	3.03	2.73	-	-	-
	2	4.76	4.29	3.90	3.53	3.16	2.83	-	-	-
	5	5.00	4.48	4.11	3.66	3.30	2.94	-	-	-
	10	5.36	4.76	4.35	3.95	3.49	3.13	-	-	-
	15	5.61	5.05	4.61	4.16	3.70	3.31	-	-	-
	20	(5.93)	5.17	4.76	4.29	3.85	3.41	-	-	-
	25	(5.77)	5.26	4.76	4.35	3.85	3.45	-	-	-
27	(5.77)	5.26	4.76	4.35	3.85	3.49	-	-	-	
42% <25kW>	-5	4.10	3.68	3.38	3.05	2.72	2.45	-	-	-
	-2	4.31	3.91	3.57	3.21	2.87	2.58	-	-	-
	0	4.46	4.03	3.68	3.29	2.94	2.66	-	-	-
	2	4.63	4.17	3.79	3.42	3.05	2.75	-	-	-
	5	4.81	4.31	3.91	3.57	3.16	2.84	-	-	-
	10	(5.36)	(4.76)	4.17	3.79	3.38	3.01	-	-	-
	15	(5.61)	(5.05)	(4.61)	(4.16)	(3.70)	3.21	-	-	-
	20	(5.93)	(5.17)	(4.76)	(4.29)	(3.85)	(3.41)	-	-	-
	25	(5.77)	(5.26)	(4.76)	(4.35)	(3.85)	(3.45)	-	-	-
27	(5.77)	(5.26)	(4.76)	(4.35)	(3.85)	(3.49)	-	-	-	

The figures in the round brackets show the COP under non-inverter control.

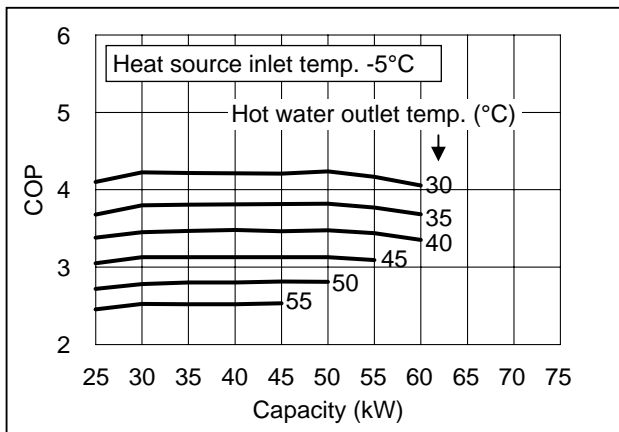
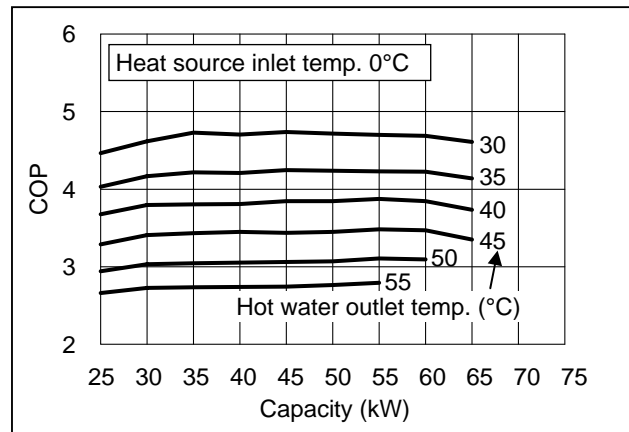
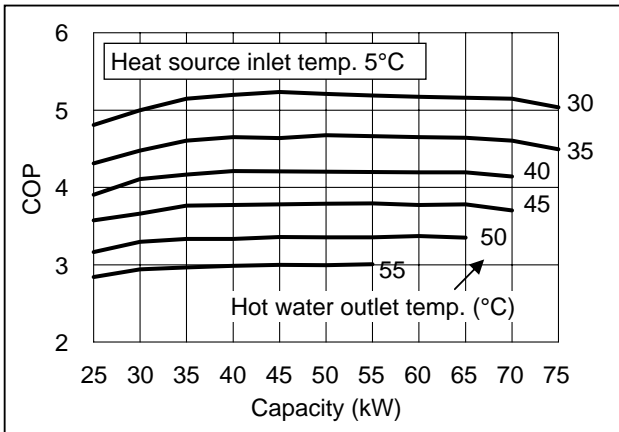
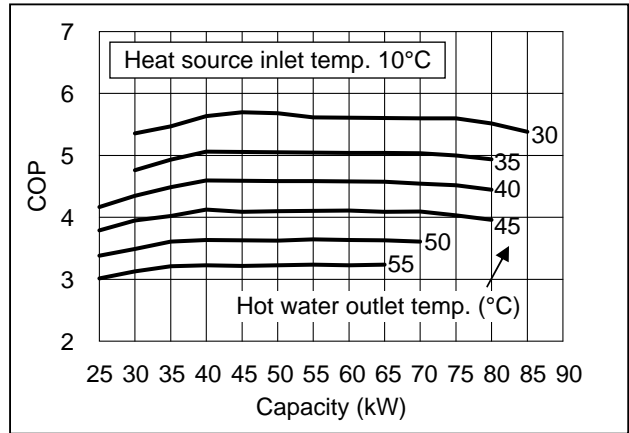
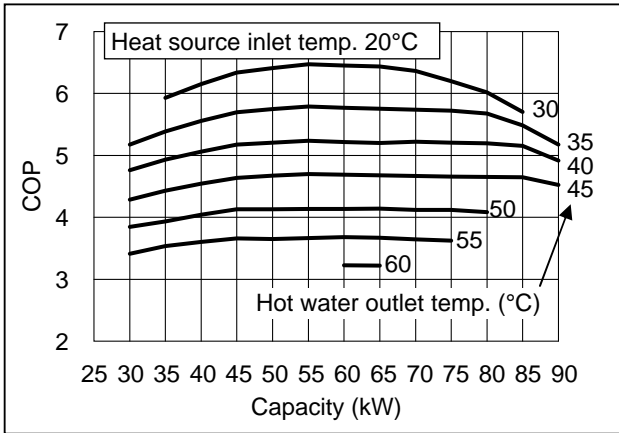

(1)-2 counter flow, BRINE: ethylene glycol 35WT%

hot water flow rate	3.9 m ³ /h
heat source flow rate	14.7 m ³ /h

Capacity	inlet heat source temp (°C)	COP for heating								
		outlet hot water temp (°C)								
		30	35	40	45	50	55	60	65	
150% <90kW>	-5	-	-	-	-	-	-	-	-	-
	-2	-	-	-	-	-	-	-	-	-
	0	-	-	-	-	-	-	-	-	-
	2	-	-	-	-	-	-	-	-	-
	5	-	-	-	-	-	-	-	-	-
	10	-	-	-	-	-	-	-	-	-
	15	6.00	5.81	5.36	4.81	-	-	-	-	-
	20	6.21	6.00	5.73	5.26	4.66	-	-	-	-
	25	6.34	6.16	5.92	5.52	5.03	-	-	-	-
27	6.38	6.25	5.96	5.63	5.06	-	-	-	-	
125% <75kW>	-5	-	-	-	-	-	-	-	-	-
	-2	-	-	-	-	-	-	-	-	-
	0	-	-	-	-	-	-	-	-	-
	2	5.21	4.63	-	-	-	-	-	-	-
	5	5.60	5.03	4.55	4.10	-	-	-	-	-
	10	6.15	5.51	5.03	4.55	4.08	-	-	-	-
	15	6.52	5.91	5.36	4.87	4.36	3.93	-	-	-
	20	6.82	6.30	5.73	5.17	4.63	4.14	-	-	-
	25	6.94	6.58	5.95	5.43	4.87	4.36	3.93	-	-
27	7.01	6.58	6.00	5.47	4.90	4.39	3.95	-	-	
100% <60kW>	-5	4.48	4.00	3.64	3.31	-	-	-	-	-
	-2	4.88	4.35	3.97	3.61	3.26	-	-	-	-
	0	5.13	4.58	4.17	3.80	3.41	-	-	-	-
	2	5.31	4.76	4.35	3.95	3.55	3.19	-	-	-
	5	5.61	5.04	4.58	4.14	3.73	3.35	-	-	-
	10	6.06	5.45	4.96	4.51	4.03	3.61	3.24	-	-
	15	6.52	5.88	5.36	4.84	4.32	3.85	3.47	3.09	-
	20	6.90	6.25	5.66	5.13	4.58	4.11	3.68	3.30	-
	25	7.06	6.38	5.77	5.26	4.72	4.23	3.77	3.41	-
27	7.14	6.38	5.83	5.26	4.72	4.23	3.80	3.43	-	
75% <45kW>	-5	4.50	4.05	3.69	3.36	3.02	2.73	2.47	2.25	-
	-2	4.84	4.33	3.95	3.60	3.24	2.90	2.63	2.38	-
	0	5.06	4.50	4.09	3.72	3.33	3.02	2.74	2.49	-
	2	5.23	4.69	4.25	3.85	3.46	3.15	2.85	2.57	-
	5	5.56	5.00	4.50	4.05	3.63	3.26	2.94	2.65	-
	10	6.00	5.42	4.89	4.41	3.95	3.52	3.17	2.83	-
	15	6.43	5.77	5.23	4.74	4.25	3.78	3.38	3.02	-
	20	6.72	6.00	5.49	5.00	4.46	3.98	3.57	3.19	-
	25	6.72	6.08	5.56	5.06	4.50	4.05	3.63	3.26	-
27	6.72	6.08	5.56	5.06	4.55	4.05	3.66	3.28	-	
50% <30kW>	-5	4.41	3.95	3.57	3.26	2.94	2.65	2.40	-	-
	-2	4.69	4.17	3.85	3.45	3.09	2.80	2.52	-	-
	0	4.84	4.35	3.95	3.57	3.19	2.91	2.63	-	-
	2	5.00	4.48	4.11	3.70	3.33	3.00	2.70	-	-
	5	5.17	4.69	4.29	3.85	3.45	3.09	2.80	-	-
	10	5.56	5.00	4.55	4.11	3.70	3.30	2.97	-	-
	15	5.88	5.26	4.84	4.35	3.90	3.49	3.16	-	-
	20	(6.25)	(5.65)	(5.15)	4.62	4.05	3.61	3.26	-	-
	25	(6.00)	(5.45)	(5.00)	4.55	4.05	3.66	3.30	-	-
27	(6.00)	(5.45)	(5.00)	4.55	4.05	3.66	3.33	-	-	
42% <25kW>	-5	4.24	3.79	3.47	3.16	2.84	2.55	2.31	-	-
	-2	4.46	4.03	3.68	3.33	3.01	2.69	2.43	-	-
	0	4.63	4.17	3.79	3.42	3.09	2.81	2.55	-	-
	2	4.81	4.31	3.91	3.57	3.21	2.87	2.60	-	-
	5	5.00	4.46	4.10	3.68	3.33	2.98	2.69	-	-
	10	(5.56)	(5.00)	(4.55)	3.97	3.52	3.16	2.87	-	-
	15	(5.88)	(5.26)	(4.84)	(4.35)	(3.90)	(3.49)	3.01	-	-
	20	(6.25)	(5.65)	(5.15)	(4.62)	(4.05)	(3.61)	(3.26)	-	-
	25	(6.00)	(5.45)	(5.00)	(4.55)	(4.05)	(3.66)	(3.30)	-	-
27	(6.00)	(5.45)	(5.00)	(4.55)	(4.05)	(3.66)	(3.33)	-	-	

The figures in the round brackets show the COP under non-inverter control.

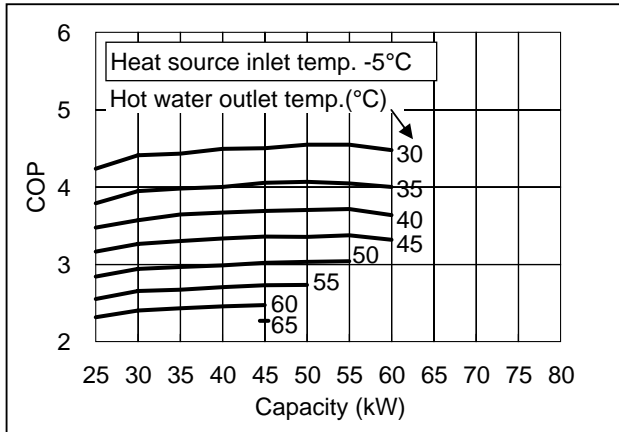
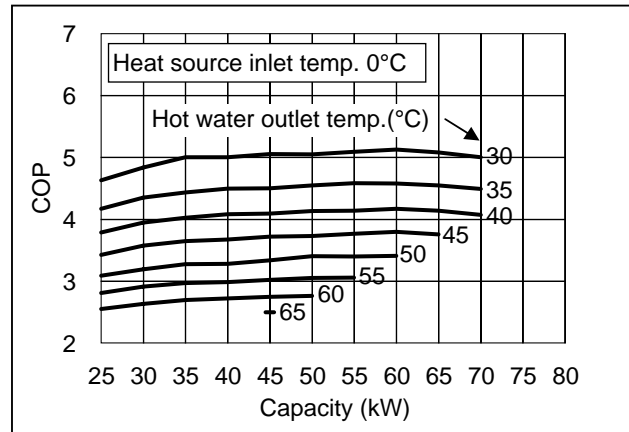
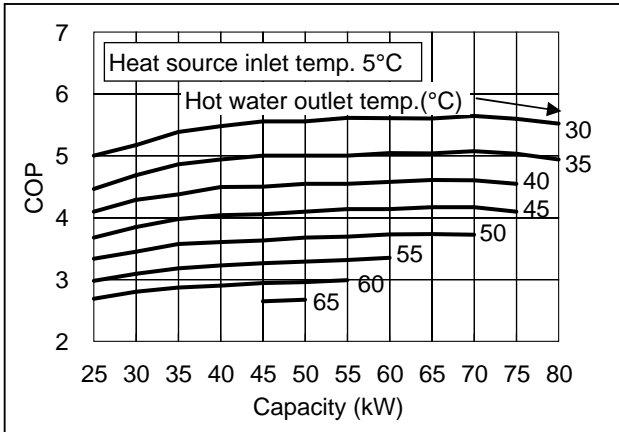
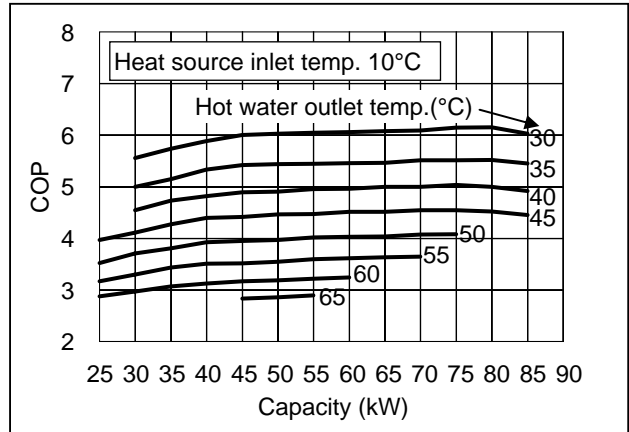
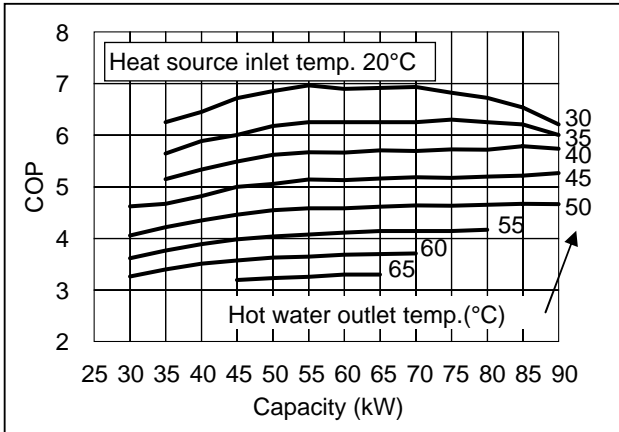

inlet heat source	hot water flow rate	10.3 m ³ /h
-5~35°C	heat source flow rate	4.5 m ³ /h
inlet heat source	hot water flow rate	10.3 m ³ /h
40~45°C	heat source flow rate	2.3 m ³ /h

(2)-1 parallel flow, BRINE: ethylene glycol 35WT%

Capacity	inlet heat source temp (°C)	COP for heating							
		outlet hot water temp (°C)							
		30	35	40	45	50	55	60	65
150% <90kW>	-5	-	-	-	-	-	-	-	-
	-2	-	-	-	-	-	-	-	-
	0	-	-	-	-	-	-	-	-
	2	-	-	-	-	-	-	-	-
	5	-	-	-	-	-	-	-	-
	10	-	-	-	-	-	-	-	-
	15	-	-	-	-	-	-	-	-
	20	-	-	-	-	-	-	-	-
	25	-	-	-	-	-	-	-	-
	27	-	-	4.69	-	-	-	-	-
	30	-	5.08	4.79	4.43	-	-	-	-
	32	-	5.17	4.86	4.52	-	-	-	-
	35	-	5.26	4.97	4.55	-	-	-	-
	40	-	-	-	-	-	-	-	-
42	-	-	4.71	-	-	-	-	-	
45	-	-	4.81	4.48	-	-	-	-	
125% <75kW>	-5	-	-	-	-	-	-	-	-
	-2	-	-	-	-	-	-	-	-
	0	-	-	-	-	-	-	-	-
	2	-	-	-	-	-	-	-	-
	5	-	-	-	-	-	-	-	-
	10	-	-	-	-	-	-	-	-
	15	4.90	4.44	-	-	-	-	-	-
	20	5.47	4.93	4.46	4.01	-	-	-	-
	25	5.91	5.36	4.84	4.36	3.89	-	-	-
	27	6.05	5.47	5.00	4.49	4.01	-	-	-
	30	6.15	5.60	5.07	4.57	4.08	3.64	-	-
	32	6.20	5.60	5.10	4.60	4.10	3.68	-	-
	35	6.25	5.64	5.14	4.63	4.14	3.73	-	-
	40	6.05	5.51	5.03	4.55	4.08	3.66	-	-
42	6.10	5.51	5.03	4.57	4.08	3.68	-	-	
45	6.10	5.56	5.07	4.57	4.12	3.69	-	-	
100% <60kW>	-5	-	-	-	-	-	-	-	-
	-2	-	-	-	-	-	-	-	-
	0	-	-	-	-	-	-	-	-
	2	-	-	-	-	-	-	-	-
	5	4.17	3.80	3.49	3.16	-	-	-	-
	10	4.76	4.32	3.95	3.57	3.21	-	-	-
	15	5.22	4.69	4.29	3.85	3.47	3.14	-	-
	20	5.66	5.08	4.62	4.17	3.70	3.31	2.97	-
	25	6.06	5.50	4.96	4.48	3.97	3.55	3.16	-
	27	6.19	5.56	5.04	4.55	4.03	3.59	3.21	-
	30	6.19	5.56	5.04	4.55	4.05	3.64	3.24	-
	32	6.19	5.61	5.08	4.58	4.08	3.66	3.26	-
	35	(6.25)	(5.60)	(5.11)	(4.61)	(4.11)	(3.69)	3.30	-
	40	(6.09)	(5.51)	(5.04)	(4.55)	(4.06)	3.66	3.28	-
42	(6.09)	(5.51)	(5.04)	(4.55)	(4.09)	3.66	3.30	-	
45	(6.14)	(5.56)	(5.08)	(4.58)	(4.11)	3.68	3.33	-	

Capacity	inlet heat source temp (°C)	COP for heating							
		outlet hot water temp (°C)							
		30	35	40	45	50	55	60	65
75% <45kW>	-5	3.60	3.26	2.98	2.73	2.47	2.25	-	-
	-2	3.88	3.49	3.19	2.90	2.62	2.38	-	-
	0	4.05	3.63	3.33	3.02	2.73	2.47	-	-
	2	4.21	3.81	3.49	3.15	2.85	2.59	-	-
	5	4.50	4.05	3.72	3.36	3.02	2.73	-	-
	10	4.95	4.46	4.05	3.66	3.26	2.92	-	-
	15	5.42	4.89	4.41	3.98	3.54	3.17	-	-
	20	5.84	5.29	4.79	4.29	3.81	3.41	-	-
	25	6.08	5.49	5.00	4.50	4.02	3.57	-	-
	27	6.16	5.56	5.00	4.55	4.02	3.60	-	-
	30	(6.18)	(5.56)	(5.05)	(4.55)	(4.07)	(3.62)	-	-
	32	(6.19)	(5.61)	(5.08)	(4.58)	(4.07)	(3.64)	-	-
	35	(6.25)	(5.60)	(5.11)	(4.61)	(4.11)	(3.69)	-	-
	40	(6.09)	(5.51)	(5.04)	(4.55)	(4.06)	(3.66)	-	-
	42	(6.09)	(5.51)	(5.04)	(4.55)	(4.09)	(3.66)	-	-
45	(6.14)	(5.56)	(5.08)	(4.58)	(4.11)	(3.68)	-	-	
50% <30kW>	-5	3.75	3.41	3.13	2.83	2.56	2.33	-	-
	-2	4.00	3.66	3.33	3.03	2.73	2.46	-	-
	0	4.17	3.80	3.49	3.16	2.83	2.56	-	-
	2	4.35	3.95	3.61	3.26	2.94	2.65	-	-
	5	4.62	4.17	3.80	3.45	3.09	2.78	-	-
	10	5.00	4.48	4.11	3.70	3.33	3.00	-	-
	15	5.26	4.76	4.35	3.95	3.53	3.19	-	-
	20	5.56	5.08	4.62	4.17	3.70	3.33	-	-
	25	5.66	5.08	4.69	4.23	3.80	3.41	-	-
	27	5.66	5.08	4.69	4.23	3.80	3.41	-	-
	30	(6.18)	(5.56)	(5.05)	(4.55)	(4.07)	(3.62)	-	-
	32	(6.19)	(5.61)	(5.08)	(4.58)	(4.07)	(3.64)	-	-
	35	(6.25)	(5.60)	(5.11)	(4.61)	(4.11)	(3.69)	-	-
	40	(6.09)	(5.51)	(5.04)	(4.55)	(4.06)	(3.66)	-	-
	42	(6.09)	(5.51)	(5.04)	(4.55)	(4.09)	(3.66)	-	-
45	(6.14)	(5.56)	(5.08)	(4.58)	(4.11)	(3.68)	-	-	
42% <25kW>	-5	3.79	3.42	3.13	2.84	2.55	2.31	-	-
	-2	4.03	3.62	3.33	3.01	2.69	2.45	-	-
	0	4.17	3.73	3.42	3.13	2.81	2.53	-	-
	2	4.31	3.91	3.57	3.21	2.91	2.60	-	-
	5	4.55	4.10	3.73	3.38	3.01	2.72	-	-
	10	4.81	4.39	4.03	3.62	3.25	2.91	-	-
	15	(5.26)	(4.76)	(4.35)	3.85	3.42	3.13	-	-
	20	(5.56)	(5.08)	(4.62)	(4.17)	(3.70)	(3.33)	-	-
	25	(5.66)	(5.08)	(4.69)	(4.23)	(3.80)	(3.41)	-	-
	27	(5.66)	(5.08)	(4.69)	(4.23)	(3.80)	(3.41)	-	-
	30	(6.18)	(5.56)	(5.05)	(4.55)	(4.07)	(3.62)	-	-
	32	(6.19)	(5.61)	(5.08)	(4.58)	(4.07)	(3.64)	-	-
	35	(6.25)	(5.60)	(5.11)	(4.61)	(4.11)	(3.69)	-	-
	40	(6.09)	(5.51)	(5.04)	(4.55)	(4.06)	(3.66)	-	-
	42	(6.09)	(5.51)	(5.04)	(4.55)	(4.09)	(3.66)	-	-
45	(6.14)	(5.56)	(5.08)	(4.58)	(4.11)	(3.68)	-	-	

The figures in the round brackets show the COP under non-inverter control.

Heat source flow rate: 2.3m³/h

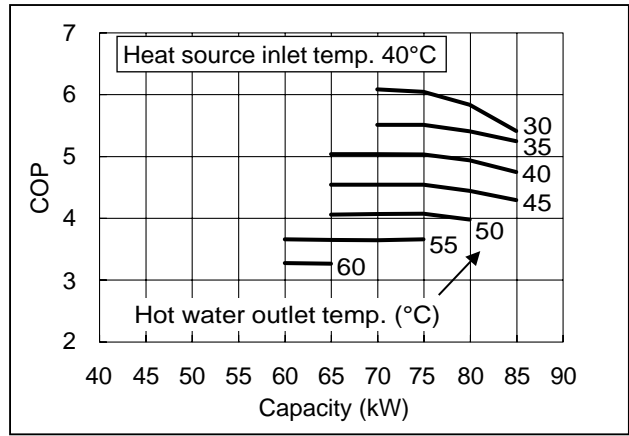
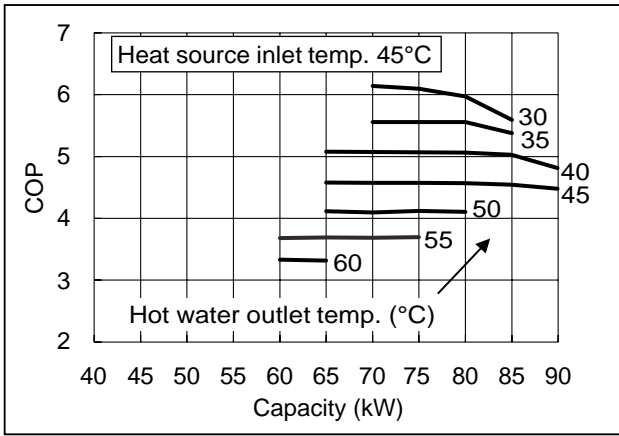

Heat source flow rate: 4.5m³/h

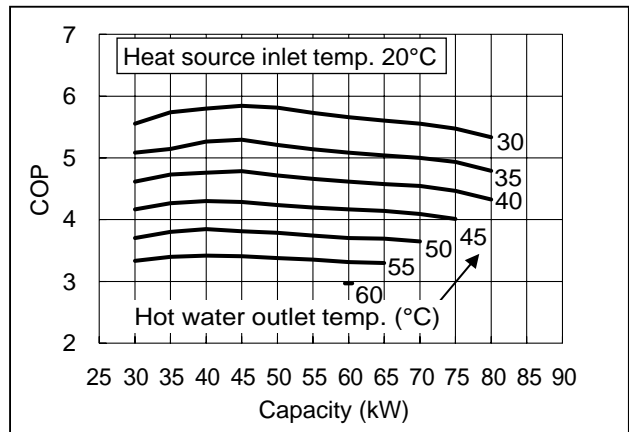
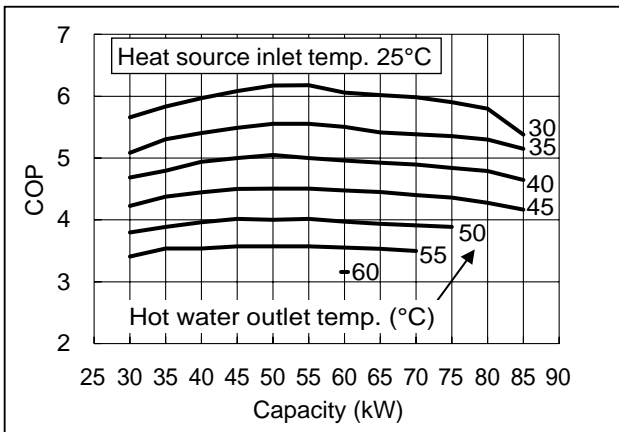
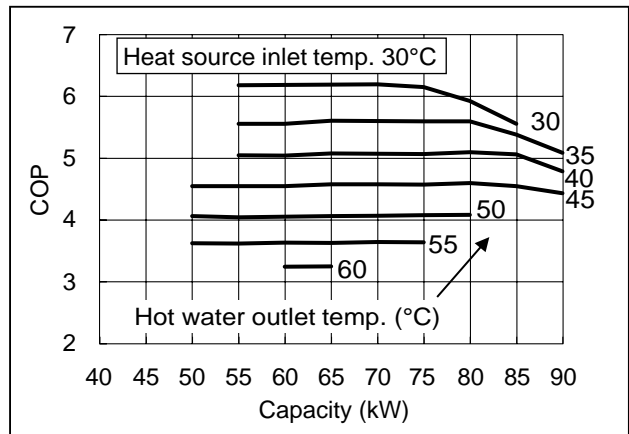
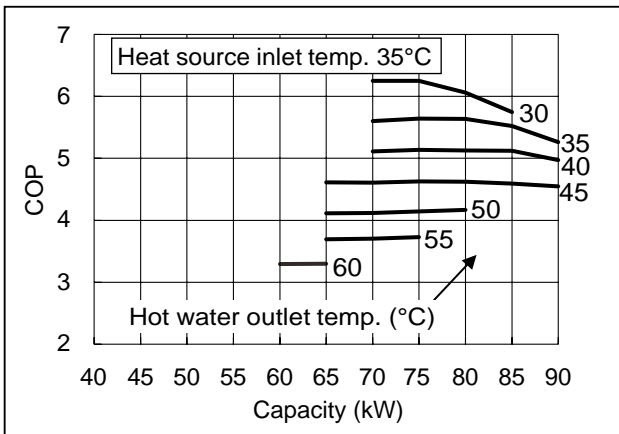

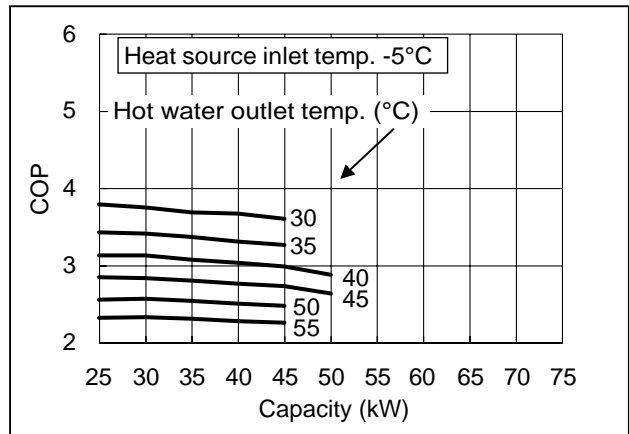
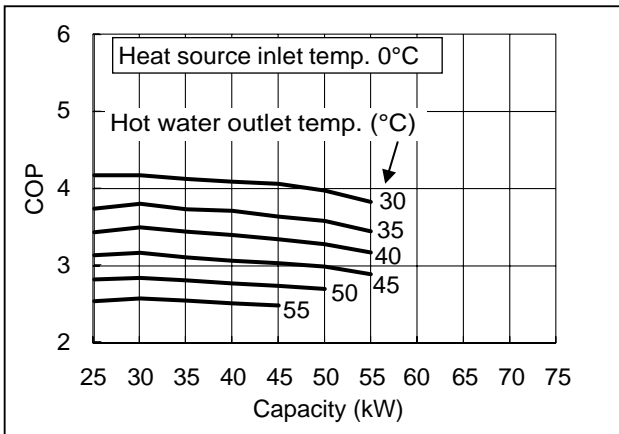
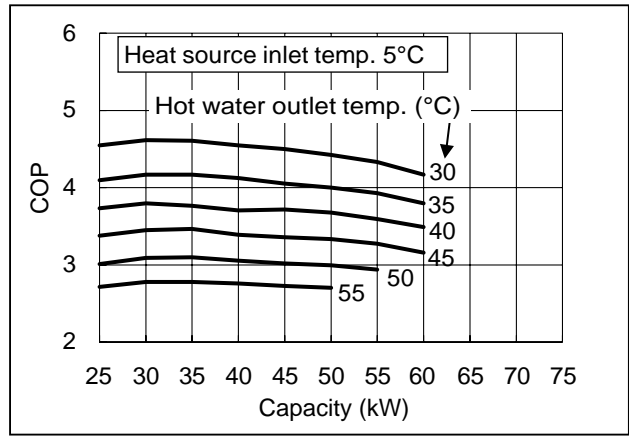
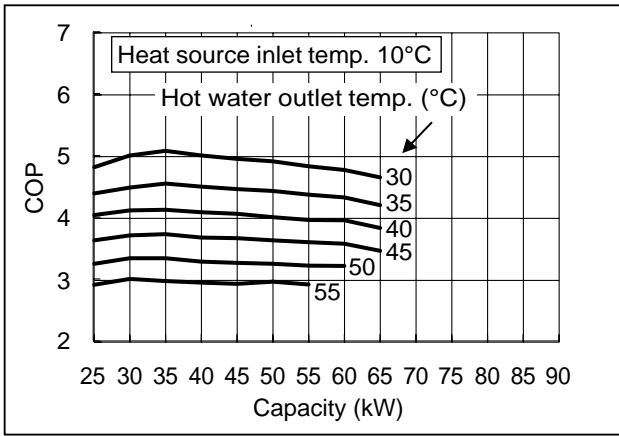

inlet heat source	hot water flow rate	3.9 m ³ /h
-5~35°C	heat source flow rate	4.5 m ³ /h
inlet heat source	hot water flow rate	3.9 m ³ /h
40~45°C	heat source flow rate	2.3 m ³ /h

(2)-2 parallel flow, BRINE: ethylene glycol 35WT%

Capacity	inlet heat source temp (°C)	COP for heating								
		outlet hot water temp (°C)								
		30	35	40	45	50	55	60	65	
150% <90kW>	-5	-	-	-	-	-	-	-	-	-
	-2	-	-	-	-	-	-	-	-	-
	0	-	-	-	-	-	-	-	-	-
	2	-	-	-	-	-	-	-	-	-
	5	-	-	-	-	-	-	-	-	-
	10	-	-	-	-	-	-	-	-	-
	15	-	-	-	-	-	-	-	-	-
	20	-	-	-	-	-	-	-	-	-
	25	-	5.66	5.14	4.66	-	-	-	-	-
	27	-	5.77	5.36	4.86	-	-	-	-	-
	30	6.00	5.88	5.63	5.11	4.59	-	-	-	-
	32	6.08	5.92	5.70	5.20	4.66	-	-	-	-
	35	6.16	6.04	5.73	5.23	4.71	-	-	-	-
	40	-	5.63	5.14	4.71	-	-	-	-	-
	42	-	5.77	5.36	4.89	-	-	-	-	-
45	6.00	5.88	5.59	5.11	4.62	-	-	-	-	
125% <75kW>	-5	-	-	-	-	-	-	-	-	-
	-2	-	-	-	-	-	-	-	-	-
	0	-	-	-	-	-	-	-	-	-
	2	-	-	-	-	-	-	-	-	-
	5	-	-	-	-	-	-	-	-	-
	10	-	-	-	-	-	-	-	-	-
	15	5.47	4.90	4.46	4.05	-	-	-	-	-
	20	6.05	5.43	4.97	4.52	4.05	-	-	-	-
	25	6.47	5.86	5.36	4.87	4.39	3.95	-	-	-
	27	6.70	6.00	5.47	5.00	4.49	4.05	-	-	-
	30	6.82	6.15	5.60	5.10	4.60	4.12	-	-	-
	32	6.82	6.15	5.64	5.10	4.60	4.14	-	-	-
	35	6.88	6.20	5.64	5.14	4.63	4.19	-	-	-
	40	6.70	6.05	5.51	5.03	4.55	4.12	-	-	-
	42	6.70	6.05	5.56	5.07	4.57	4.12	-	-	-
45	6.70	6.10	5.56	5.10	4.60	4.17	-	-	-	
100% <60kW>	-5	-	-	-	-	-	-	-	-	-
	-2	-	-	-	-	-	-	-	-	-
	0	-	-	-	-	-	-	-	-	-
	2	-	-	-	-	-	-	-	-	-
	5	4.58	4.14	3.77	3.45	-	-	-	-	-
	10	5.17	4.65	4.26	3.87	3.51	3.17	-	-	-
	15	5.66	5.08	4.65	4.23	3.80	3.43	3.08	-	-
	20	6.12	5.50	5.04	4.58	4.11	3.68	3.33	3.02	-
	25	6.59	5.94	5.41	4.92	4.41	3.95	3.55	3.21	-
	27	6.67	6.00	5.45	4.96	4.44	4.00	3.61	3.24	-
	30	6.67	6.06	5.50	5.00	4.48	4.03	3.64	-	-
	32	(6.77)	(6.07)	5.50	5.00	4.51	4.05	3.66	-	-
	35	(6.88)	(6.20)	(5.60)	(5.11)	(4.61)	(4.11)	(3.71)	-	-
	40	(6.70)	(6.03)	(5.51)	(5.00)	(4.52)	(4.06)	(3.67)	-	-
	42	(6.70)	(6.03)	(5.51)	(5.04)	(4.55)	(4.09)	(3.69)	-	-
45	(6.70)	(6.03)	(5.56)	(5.07)	(4.58)	(4.11)	(3.74)	-	-	

Capacity	inlet heat source temp (°C)	COP for heating							
		outlet hot water temp (°C)							
		30	35	40	45	50	55	60	65
75% <45kW>	-5	3.85	3.44	3.17	2.90	2.63	2.41	-	-
	-2	4.09	3.66	3.38	3.08	2.80	2.54	2.33	-
	0	4.29	3.85	3.54	3.21	2.90	2.65	2.43	2.23
	2	4.46	4.02	3.69	3.36	3.04	2.76	2.54	2.32
	5	4.79	4.29	3.91	3.60	3.24	2.94	2.68	2.45
	10	5.29	4.74	4.33	3.91	3.52	3.21	2.90	2.66
	15	5.77	5.17	4.74	4.29	3.81	3.44	3.10	2.80
	20	6.16	5.63	5.11	4.59	4.13	3.69	3.33	2.98
	25	6.43	5.84	5.36	4.84	4.33	3.88	3.49	3.13
	27	6.52	5.84	5.36	4.84	4.37	3.91	3.52	3.17
	30	(6.67)	(5.98)	(5.50)	(4.95)	(4.44)	(3.97)	(3.57)	-
	32	(6.77)	(6.07)	(5.50)	(5.00)	(4.51)	(4.01)	(3.62)	-
	35	(6.88)	(6.20)	(5.60)	(5.11)	(4.61)	(4.11)	(3.71)	-
	40	(6.70)	(6.03)	(5.51)	(5.00)	(4.52)	(4.06)	(3.67)	-
	42	(6.70)	(6.03)	(5.51)	(5.04)	(4.55)	(4.09)	(3.69)	-
45	(6.70)	(6.03)	(5.56)	(5.07)	(4.58)	(4.11)	(3.74)	-	
50% <30kW>	-5	3.90	3.53	3.23	2.94	2.68	2.44	2.24	-
	-2	4.17	3.80	3.45	3.16	2.86	2.59	2.36	-
	0	4.35	3.95	3.61	3.30	2.97	2.68	2.46	-
	2	4.55	4.11	3.75	3.41	3.06	2.78	2.54	-
	5	4.84	4.35	3.95	3.61	3.23	2.91	2.65	-
	10	5.17	4.69	4.29	3.90	3.49	3.13	2.86	-
	15	5.45	4.92	4.55	4.11	3.70	3.33	3.00	-
	20	5.77	5.26	4.76	4.35	3.90	3.53	3.16	-
	25	5.88	5.36	4.84	4.41	4.00	3.61	3.23	-
	27	5.88	5.36	4.92	4.41	4.00	3.61	3.26	-
	30	(6.67)	(5.98)	(5.50)	(4.95)	(4.44)	(3.97)	(3.57)	-
	32	(6.77)	(6.07)	(5.50)	(5.00)	(4.51)	(4.01)	(3.62)	-
	35	(6.88)	(6.20)	(5.60)	(5.11)	(4.61)	(4.11)	(3.71)	-
	40	(6.70)	(6.03)	(5.51)	(5.00)	(4.52)	(4.06)	(3.67)	-
	42	(6.70)	(6.03)	(5.51)	(5.04)	(4.55)	(4.09)	(3.69)	-
45	(6.70)	(6.03)	(5.56)	(5.07)	(4.58)	(4.11)	(3.74)	-	
42% <25kW>	-5	3.97	3.52	3.25	2.94	2.66	2.40	2.19	-
	-2	4.17	3.73	3.42	3.13	2.81	2.55	2.31	-
	0	4.31	3.85	3.57	3.21	2.91	2.63	2.40	-
	2	4.46	4.03	3.68	3.33	3.01	2.72	2.48	-
	5	4.72	4.17	3.85	3.52	3.16	2.84	2.58	-
	10	5.00	4.55	4.10	3.73	3.38	3.05	2.75	-
	15	(5.45)	(4.92)	(4.55)	(4.11)	3.57	3.25	2.91	-
	20	(5.77)	(5.26)	(4.76)	(4.35)	(3.90)	3.33	3.01	-
	25	(5.88)	(5.36)	(4.84)	(4.41)	(4.00)	(3.61)	(3.23)	-
	27	(5.88)	(5.36)	(4.92)	(4.41)	(4.00)	(3.61)	(3.26)	-
	30	(6.67)	(5.98)	(5.50)	(4.95)	(4.44)	(3.97)	(3.57)	-
	32	(6.77)	(6.07)	(5.50)	(5.00)	(4.51)	(4.01)	(3.62)	-
	35	(6.88)	(6.20)	(5.60)	(5.11)	(4.61)	(4.11)	(3.71)	-
	40	(6.70)	(6.03)	(5.51)	(5.00)	(4.52)	(4.06)	(3.67)	-
	42	(6.70)	(6.03)	(5.51)	(5.04)	(4.55)	(4.09)	(3.69)	-
45	(6.70)	(6.03)	(5.56)	(5.07)	(4.58)	(4.11)	(3.74)	-	

The figures in the round brackets show the COP under non-inverter control.

Heat source flow rate: 2.3m³/h

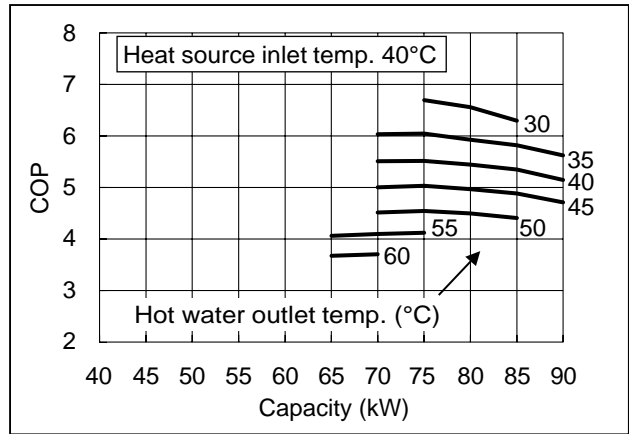
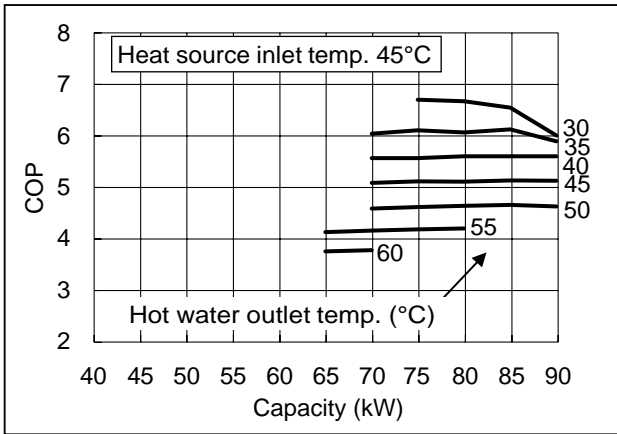

Heat source flow rate: 4.5m³/h

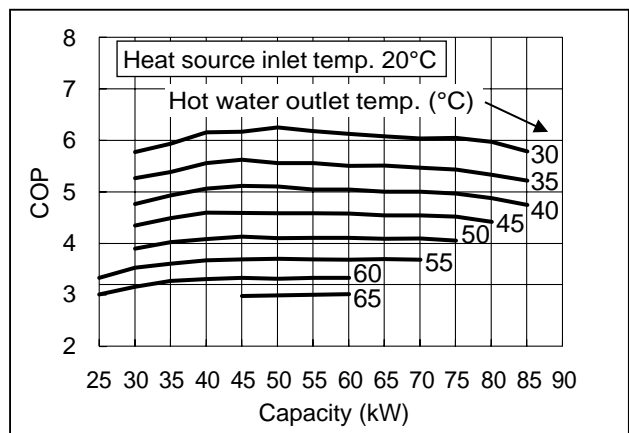
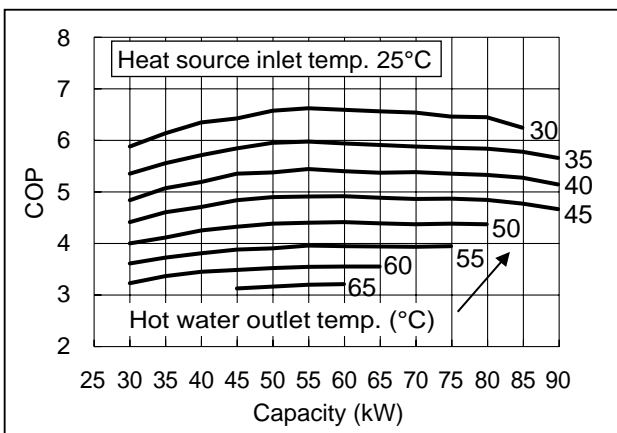
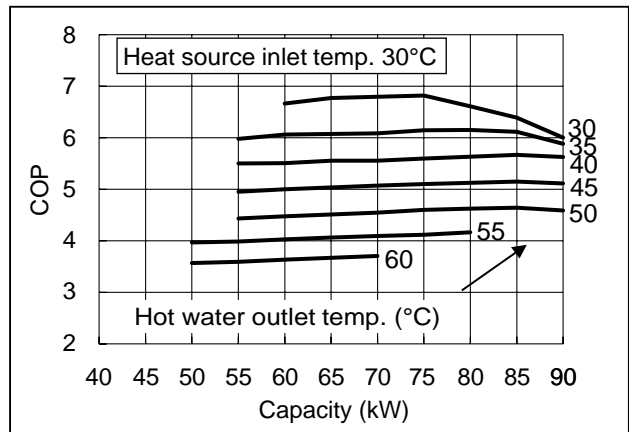
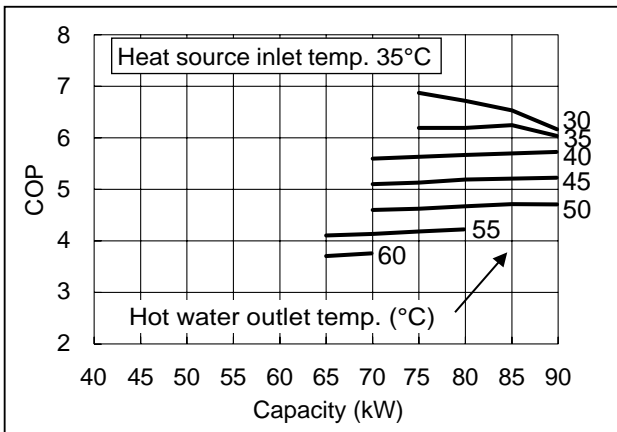

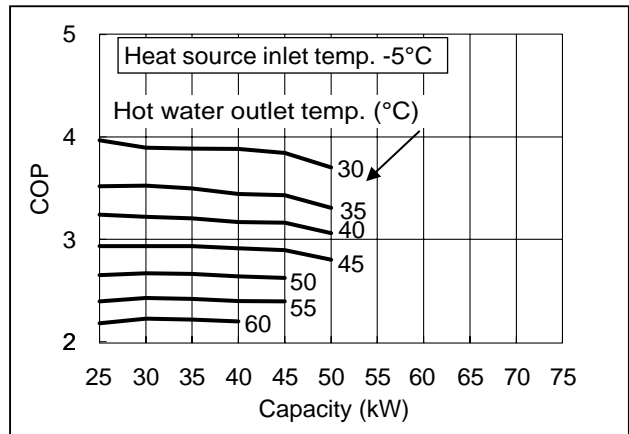
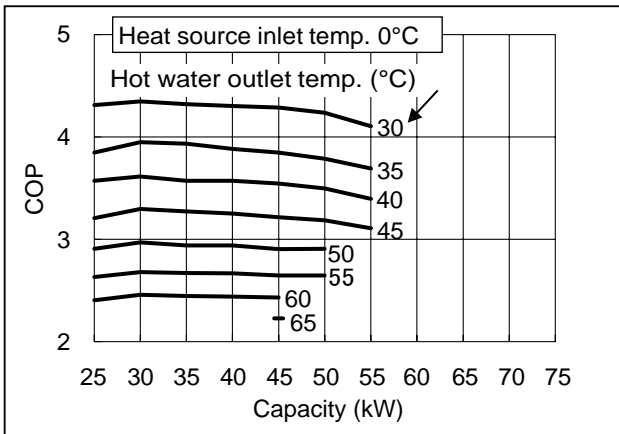
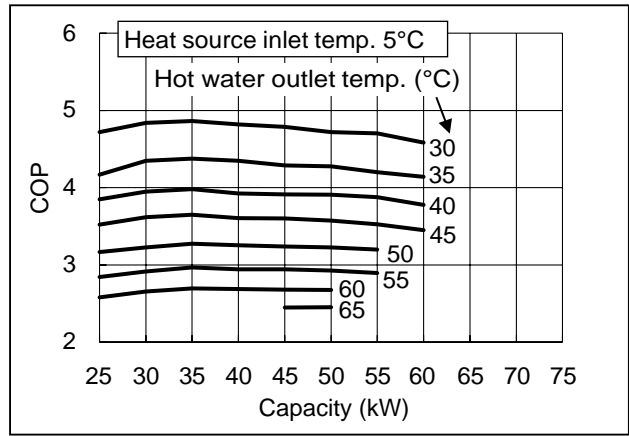
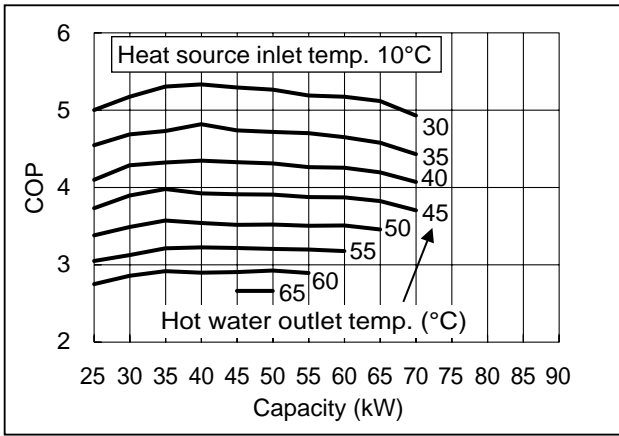

hot water flow rate 10.3 m³/h
 heat source flow rate 13.8 m³/h

(3)-1 counter flow, WATER

Capacity	inlet heat source temp (°C)	COP for heating							
		outlet hot water temp (°C)							
		30	35	40	45	50	55	60	65
150% <90kW>	8	-	-	-	-	-	-	-	-
	10	-	-	-	-	-	-	-	-
	15	-	-	-	-	-	-	-	-
	20	-	-	-	-	-	-	-	-
	25	-	5.42	5.11	4.76	-	-	-	-
	27	5.63	5.49	5.17	4.84	4.35	-	-	-
125% <75kW>	8	-	-	-	-	-	-	-	-
	10	-	-	-	-	-	-	-	-
	15	6.00	5.43	4.90	4.41	-	-	-	-
	20	6.20	5.77	5.21	4.69	4.14	3.64	-	-
	25	6.30	5.95	5.40	4.87	4.31	3.85	-	-
	27	6.36	6.00	5.43	4.87	4.36	3.89	-	-
100% <60kW>	8	-	-	-	-	-	-	-	-
	10	5.66	5.08	4.58	4.11	3.64	3.24	2.93	-
	15	6.06	5.45	4.92	4.41	3.92	3.47	3.05	-
	20	6.45	5.77	5.26	4.69	4.14	3.68	3.24	-
	25	6.52	5.88	5.31	4.76	4.23	3.80	3.35	-
	27	6.52	5.88	5.31	4.80	4.29	3.82	3.39	-
75% <45kW>	8	-	-	-	-	-	-	-	-
	10	5.70	5.11	4.59	4.13	3.63	3.24	-	-
	15	6.08	5.49	4.95	4.46	3.91	3.46	-	-
	20	6.34	5.70	5.17	4.64	4.13	3.66	-	-
	25	6.34	5.77	5.23	4.69	4.21	3.72	-	-
	27	6.34	5.77	5.23	4.74	4.21	3.75	-	-
50% <30kW>	8	-	-	-	-	-	-	-	-
	10	5.36	4.76	4.35	3.95	3.49	3.13	-	-
	15	5.66	5.08	4.62	4.17	3.70	3.30	-	-
	20	5.77	5.17	4.76	4.29	3.85	3.45	-	-
	25	5.77	5.26	4.76	4.35	3.90	3.49	-	-
	27	5.77	5.26	4.76	4.35	3.90	3.49	-	-
42% <25kW>	8	-	-	-	-	-	-	-	-
	10	(5.36)	(4.76)	4.17	3.79	3.38	3.05	-	-
	15	(5.66)	(5.08)	(4.62)	(4.17)	(3.70)	(3.30)	-	-
	20	(5.77)	(5.17)	(4.76)	(4.29)	(3.85)	(3.45)	-	-
	25	(5.77)	(5.26)	(4.76)	(4.35)	(3.90)	(3.49)	-	-
	27	(5.77)	(5.26)	(4.76)	(4.35)	(3.90)	(3.49)	-	-

The figures in the round brackets show the COP under non-inverter control.

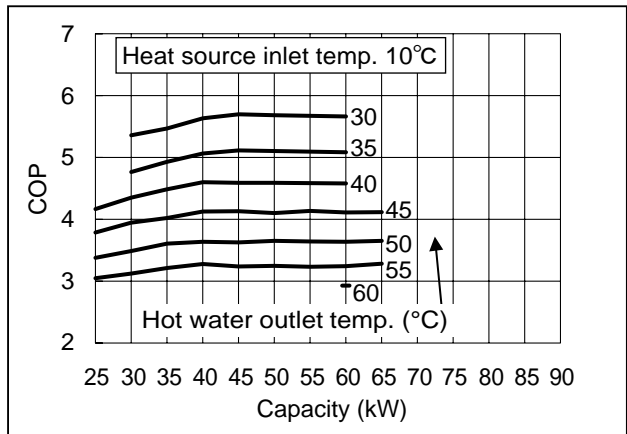
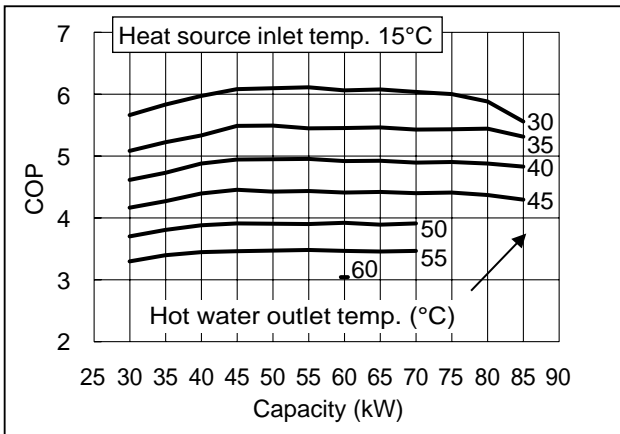
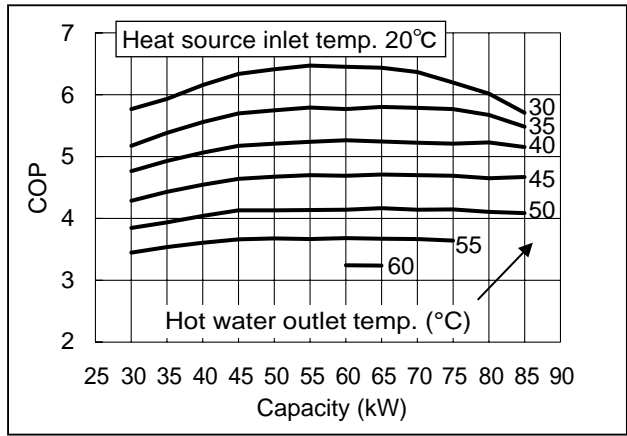
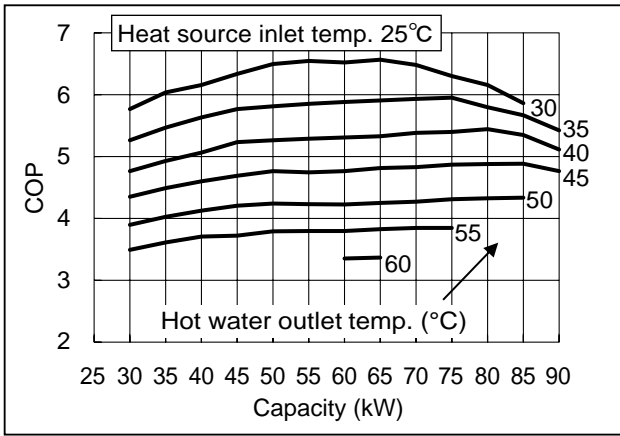

hot water flow rate	3.9 m ³ /h
heat source flow rate	13.8 m ³ /h

(3)-2 counter flow, WATER

Capacity	inlet heat source temp (°C)	COP for heating							
		outlet hot water temp (°C)							
		30	35	40	45	50	55	60	65
150% <90kW>	8	-	-	-	-	-	-	-	-
	10	-	-	-	-	-	-	-	-
	15	-	5.81	5.39	4.84	-	-	-	-
	20	-	6.00	5.73	5.29	4.69	-	-	-
	25	6.21	6.16	5.92	5.56	5.03	-	-	-
	27	6.38	6.21	5.96	5.63	5.06	-	-	-
125% <75kW>	8	-	-	-	-	-	-	-	-
	10	-	-	-	-	-	-	-	-
	15	6.58	5.91	5.40	4.90	4.39	3.93	-	-
	20	6.82	6.30	5.73	5.21	4.66	4.17	-	-
	25	6.94	6.58	5.95	5.43	4.87	4.36	3.93	-
	27	7.01	6.58	6.00	5.47	4.90	4.39	3.95	-
100% <60kW>	8	-	-	-	-	-	-	-	-
	10	6.12	5.50	5.00	4.51	4.05	3.61	3.24	-
	15	6.52	5.88	5.36	4.84	4.32	3.87	3.47	3.11
	20	6.98	6.25	5.71	5.17	4.62	4.11	3.68	3.30
	25	7.06	6.38	5.77	5.26	4.69	4.20	3.77	3.41
	27	7.14	6.38	5.83	5.26	4.72	4.23	3.80	3.45
75% <45kW>	8	-	-	-	-	-	-	-	-
	10	6.00	5.42	4.89	4.46	3.95	3.52	3.17	2.83
	15	6.43	5.77	5.23	4.74	4.25	3.78	3.38	3.02
	20	6.72	6.00	5.49	5.00	4.46	3.98	3.57	3.19
	25	6.72	6.08	5.56	5.06	4.50	4.05	3.63	3.26
	27	6.72	6.08	5.56	5.06	4.55	4.05	3.69	3.28
50% <30kW>	8	-	-	-	-	-	-	-	-
	10	5.56	5.00	4.55	4.11	3.70	3.33	3.00	-
	15	5.88	5.26	4.76	4.35	3.90	3.49	3.16	-
	20	(6.25)	(5.65)	4.92	4.48	4.00	3.61	3.26	-
	25	(6.25)	5.45	5.00	4.55	4.05	3.66	3.33	-
	27	(6.25)	5.45	5.00	4.55	4.05	3.66	3.33	-
42% <25kW>	8	-	-	-	-	-	-	-	-
	10	(5.56)	(5.00)	(4.55)	(4.11)	3.57	3.21	2.87	-
	15	(5.88)	(5.26)	(4.76)	(4.35)	(3.90)	(3.49)	3.01	-
	20	(6.25)	(5.65)	(4.92)	(4.48)	(4.00)	(3.61)	(3.26)	-
	25	(6.25)	(5.45)	(5.00)	(4.55)	(4.05)	(3.66)	(3.33)	-
	27	(6.25)	(5.45)	(5.00)	(4.55)	(4.05)	(3.66)	(3.33)	-

The figures in the round brackets show the COP under non-inverter control.

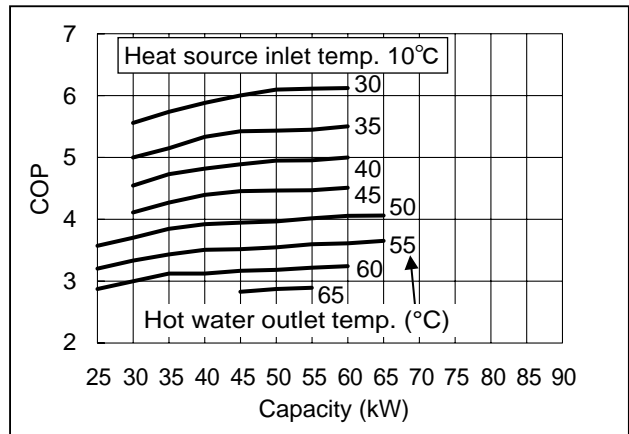
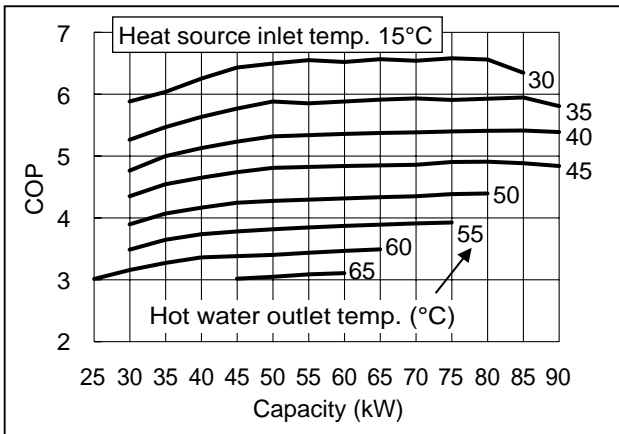
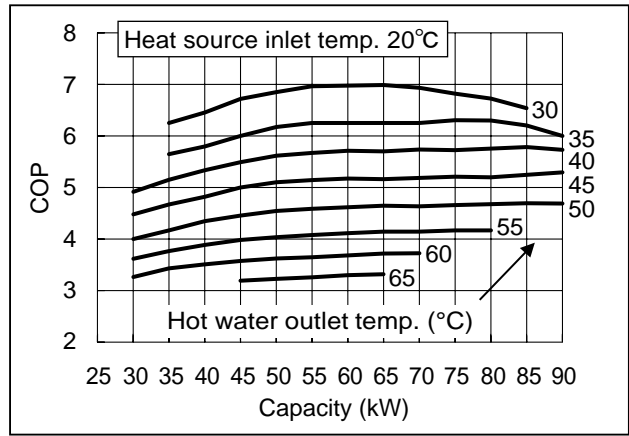
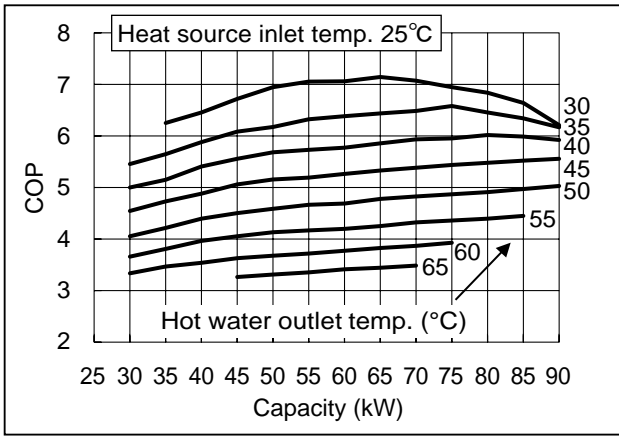

inlet heat source 15~25°C	hot water flow rate heat source flow rate	10.3 m ³ /h 9.0 m ³ /h
inlet heat source 30~35°C	hot water flow rate heat source flow rate	10.3 m ³ /h 5.0 m ³ /h
inlet heat source 40~45°C	hot water flow rate heat source flow rate	10.3 m ³ /h 2.3 m ³ /h

(4)-1 parallel flow, WATER

Capacity	inlet heat source temp (°C)	COP for heating								
		outlet hot water temp (°C)								
		30	35	40	45	50	55	60	65	
150% <90kW>	8	-	-	-	-	-	-	-	-	-
	10	-	-	-	-	-	-	-	-	-
	15	-	-	-	-	-	-	-	-	-
	20	-	-	4.74	4.31	-	-	-	-	-
	25	-	5.20	4.92	4.57	-	-	-	-	-
	27	-	5.26	4.97	4.59	-	-	-	-	-
	30	-	5.20	4.89	4.55	-	-	-	-	-
	32	-	5.28	4.98	4.57	-	-	-	-	-
	35	-	5.36	5.06	4.59	-	-	-	-	-
	40	-	-	4.74	4.33	-	-	-	-	-
42	-	-	4.83	4.45	-	-	-	-	-	
45	-	5.11	4.92	4.57	-	-	-	-	-	
125% <75kW>	8	-	-	-	-	-	-	-	-	-
	10	-	-	-	-	-	-	-	-	-
	15	5.68	5.14	4.63	4.14	-	-	-	-	-
	20	6.05	5.51	5.00	4.49	3.99	-	-	-	-
	25	6.20	5.64	5.14	4.63	4.12	3.66	-	-	-
	27	6.25	5.68	5.14	4.63	4.12	3.73	-	-	-
	30	6.20	5.64	5.14	4.63	4.12	3.68	-	-	-
	32	6.25	5.66	5.15	4.66	4.16	3.71	-	-	-
	35	6.30	5.68	5.17	4.69	4.19	3.75	-	-	-
	40	6.15	5.60	5.10	4.60	4.12	3.69	-	-	-
42	6.17	5.62	5.12	4.63	4.14	3.72	-	-	-	
45	6.20	5.64	5.14	4.66	4.17	3.75	-	-	-	
100% <60kW>	8	-	-	-	-	-	-	-	-	-
	10	-	-	-	-	-	-	-	-	-
	15	5.77	5.17	4.69	4.20	3.73	3.33	-	-	-
	20	6.19	5.56	5.04	4.51	4.00	3.55	3.16	-	-
	25	6.25	5.61	5.08	4.58	4.08	3.64	3.24	-	-
	27	6.25	5.66	5.13	4.62	4.08	3.66	3.26	-	-
	30	6.25	5.61	5.08	4.58	4.08	3.66	3.26	-	-
	32	(6.27)	(5.64)	(5.11)	(4.61)	(4.11)	(3.69)	3.29	-	-
	35	(6.31)	(5.69)	(5.15)	(4.64)	(4.14)	(3.74)	3.31	-	-
	40	(6.19)	(5.60)	(5.07)	(4.61)	(4.11)	(3.69)	3.31	-	-
42	(6.19)	(5.60)	(5.09)	(4.62)	(4.12)	(3.71)	3.33	-	-	
45	(6.19)	(5.60)	(5.11)	(4.64)	(4.14)	(3.74)	3.35	-	-	
75% <45kW>	8	-	-	-	-	-	-	-	-	-
	10	-	-	-	-	-	-	-	-	-
	15	5.84	5.23	4.74	4.25	3.75	3.33	-	-	-
	20	6.16	5.56	5.00	4.50	4.02	3.57	-	-	-
	25	6.16	5.56	5.06	4.55	4.05	3.60	-	-	-
	27	6.16	5.56	5.06	4.59	4.05	3.63	-	-	-
	30	(6.25)	(5.61)	(5.09)	(4.59)	(4.07)	(3.65)	-	-	-
	32	(6.27)	(5.64)	(5.11)	(4.61)	(4.11)	(3.69)	-	-	-
	35	(6.31)	(5.69)	(5.15)	(4.64)	(4.14)	(3.74)	-	-	-
	40	(6.19)	(5.60)	(5.07)	(4.61)	(4.11)	(3.69)	-	-	-
42	(6.19)	(5.60)	(5.09)	(4.62)	(4.12)	(3.71)	-	-	-	
45	(6.19)	(5.60)	(5.11)	(4.64)	(4.14)	(3.74)	-	-	-	

Capacity	inlet heat source temp (°C)	COP for heating								
		outlet hot water temp (°C)								
		30	35	40	45	50	55	60	65	
50% <30kW>	8	-	-	-	-	-	-	-	-	-
	10	-	-	-	-	-	-	-	-	-
	15	5.45	4.92	4.48	4.05	3.61	3.26	-	-	-
	20	5.66	5.08	4.69	4.23	3.75	3.37	-	-	-
	25	5.66	5.17	4.69	4.23	3.80	3.41	-	-	-
	27	5.66	5.17	4.69	4.29	3.80	3.41	-	-	-
	30	(6.25)	(5.61)	(5.09)	(4.59)	(4.07)	(3.65)	-	-	-
	32	(6.27)	(5.64)	(5.11)	(4.61)	(4.11)	(3.69)	-	-	-
	35	(6.31)	(5.69)	(5.15)	(4.64)	(4.14)	(3.74)	-	-	-
	40	(6.19)	(5.60)	(5.07)	(4.61)	(4.11)	(3.69)	-	-	-
	42	(6.19)	(5.60)	(5.09)	(4.62)	(4.12)	(3.71)	-	-	-
45	(6.19)	(5.60)	(5.11)	(4.64)	(4.14)	(3.74)	-	-	-	
42% <25kW>	8	-	-	-	-	-	-	-	-	-
	10	-	-	-	-	-	-	-	-	-
	15	(5.45)	(4.92)	(4.48)	(4.05)	3.52	3.16	-	-	-
	20	(5.66)	(5.08)	(4.69)	(4.23)	(3.75)	(3.37)	-	-	-
	25	(5.66)	(5.17)	(4.69)	(4.23)	(3.80)	(3.41)	-	-	-
	27	(5.66)	(5.17)	(4.69)	(4.29)	(3.80)	(3.41)	-	-	-
	30	(6.25)	(5.61)	(5.09)	(4.59)	(4.07)	(3.65)	-	-	-
	32	(6.27)	(5.64)	(5.11)	(4.61)	(4.11)	(3.69)	-	-	-
	35	(6.31)	(5.69)	(5.15)	(4.64)	(4.14)	(3.74)	-	-	-
	40	(6.19)	(5.60)	(5.07)	(4.61)	(4.11)	(3.69)	-	-	-
	42	(6.19)	(5.60)	(5.09)	(4.62)	(4.12)	(3.71)	-	-	-
45	(6.19)	(5.60)	(5.11)	(4.64)	(4.14)	(3.74)	-	-	-	

The figures in the round brackets show the COP under non-inverter control.

Heat source flow rate: 2.3m³/h

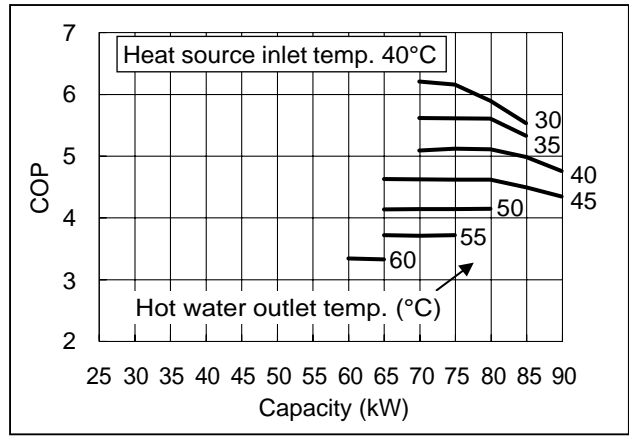
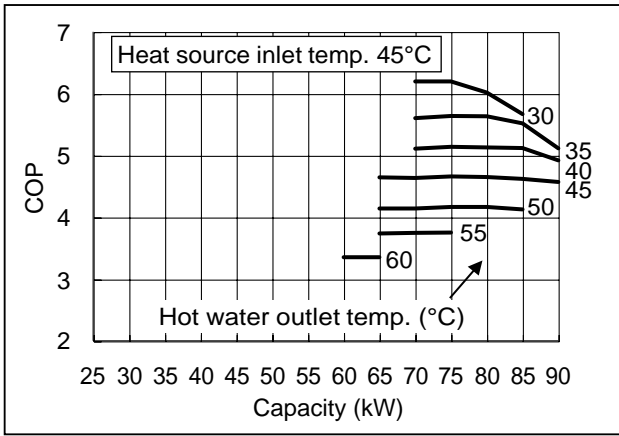

Heat source flow rate: 5.0m³/h

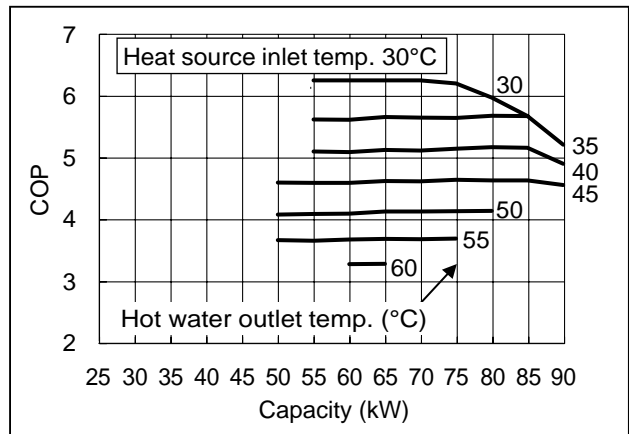
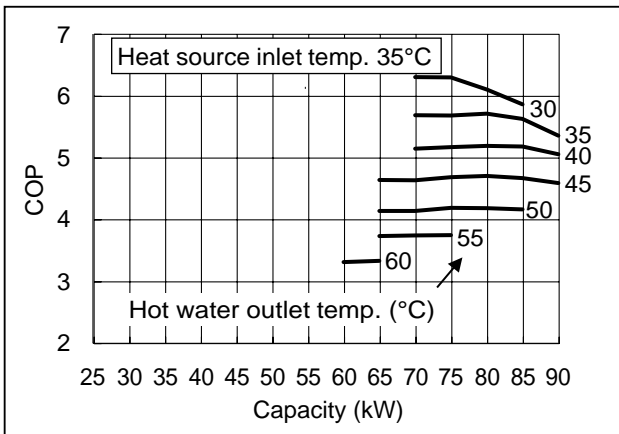

Heat source flow rate: 9.0m³/h

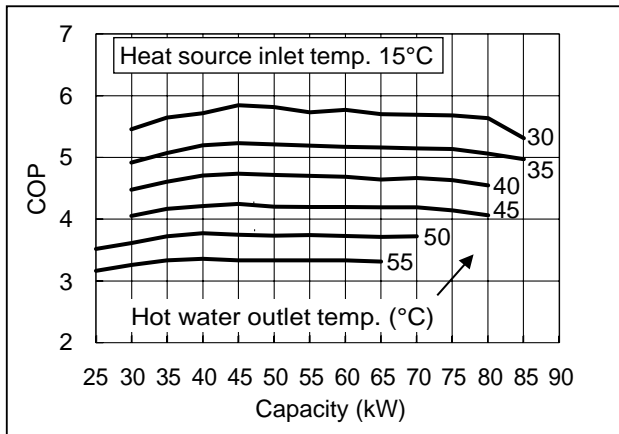
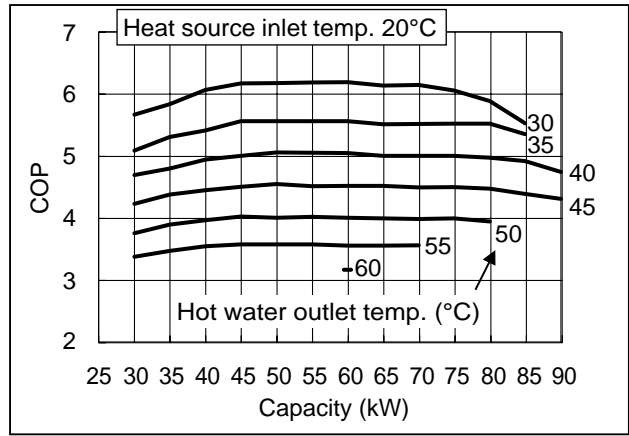
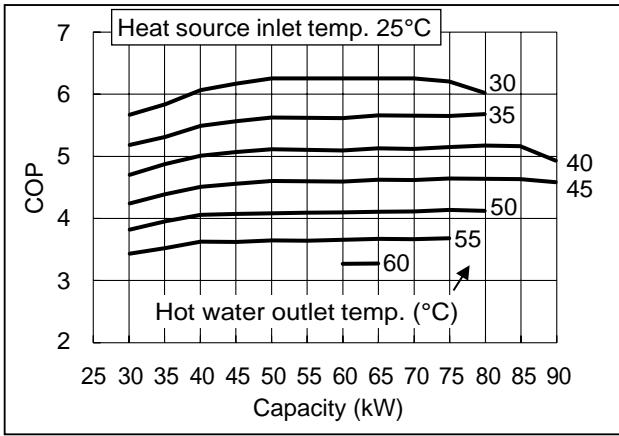

inlet heat source	hot water flow rate	3.9 m ³ /h
15~25°C	heat source flow rate	9.0 m ³ /h
inlet heat source	hot water flow rate	3.9 m ³ /h
30~35°C	heat source flow rate	5.0 m ³ /h
inlet heat source	hot water flow rate	3.9 m ³ /h
40~45°C	heat source flow rate	2.3 m ³ /h

(4)-2 parallel flow, WATER

Capacity	inlet heat source temp (°C)	COP for heating							
		outlet hot water temp (°C)							
		30	35	40	45	50	55	60	65
150% <90kW>	8	-	-	-	-	-	-	-	-
	10	-	-	-	-	-	-	-	-
	15	-	5.49	5.00	-	-	-	-	-
	20	-	5.84	5.52	5.00	-	-	-	-
	25	-	6.00	5.73	5.26	4.74	-	-	-
	27	-	6.04	5.81	5.29	4.76	-	-	-
	30	6.12	5.96	5.73	5.23	4.71	-	-	-
	32	6.21	6.04	5.77	5.26	4.74	-	-	-
	35	6.29	6.12	5.81	5.29	4.76	-	-	-
	40	5.96	5.81	5.45	4.95	-	-	-	-
	42	6.02	5.88	5.58	5.07	-	-	-	-
45	6.08	5.96	5.70	5.20	4.71	-	-	-	
125% <75kW>	8	-	-	-	-	-	-	-	-
	10	-	-	-	-	-	-	-	-
	15	6.25	5.64	5.14	4.66	4.19	-	-	-
	20	6.70	6.05	5.51	5.00	4.49	4.03	-	-
	25	6.88	6.25	5.68	5.14	4.63	4.17	-	-
	27	6.88	6.25	5.68	5.17	4.66	4.19	-	-
	30	6.88	6.20	5.68	5.14	4.63	4.17	-	-
	32	6.91	6.22	5.70	5.17	4.66	4.19	-	-
	35	6.94	6.25	5.73	5.21	4.69	4.21	-	-
	40	6.76	6.15	5.60	5.10	4.60	4.17	-	-
	42	6.79	6.15	5.62	5.14	4.63	4.19	-	-
45	6.82	6.15	5.64	5.17	4.66	4.21	-	-	
100% <60kW>	8	-	-	-	-	-	-	-	-
	10	-	-	-	-	-	-	-	-
	15	6.25	5.61	5.08	4.62	4.14	3.70	3.33	3.00
	20	6.67	6.00	5.45	4.96	4.44	3.97	3.57	3.19
	25	6.82	6.12	5.56	5.04	4.51	4.05	3.64	3.28
	27	6.82	6.12	5.56	5.04	4.55	4.05	3.66	3.31
	30	6.74	6.06	5.56	5.04	4.51	4.05	3.66	-
	32	(6.82)	(6.14)	(5.61)	(5.10)	(4.57)	(4.11)	(3.70)	-
	35	(6.94)	(6.25)	(5.69)	(5.19)	(4.67)	(4.19)	(3.76)	-
	40	(6.76)	(6.15)	(5.60)	(5.07)	(4.58)	(4.11)	(3.71)	-
	42	(6.78)	(6.15)	(5.60)	(5.10)	(4.60)	(4.14)	(3.74)	-
45	(6.82)	(6.15)	(5.60)	(5.15)	(4.64)	(4.17)	(3.78)	-	
75% <45kW>	8	-	-	-	-	-	-	-	-
	10	-	-	-	-	-	-	-	-
	15	6.16	5.56	5.06	4.55	4.09	3.66	3.26	2.94
	20	6.52	5.84	5.36	4.84	4.33	3.88	3.49	3.10
	25	6.52	5.92	5.36	4.89	4.37	3.91	3.54	3.17
	27	6.52	5.92	5.42	4.89	4.41	3.95	3.54	3.54
	30	(6.74)	(6.06)	(5.50)	(5.00)	(4.47)	(4.00)	(3.60)	-
	32	(6.82)	(6.14)	(5.58)	(5.07)	(4.55)	(4.08)	(3.66)	-
	35	(6.94)	(6.25)	(5.69)	(5.19)	(4.67)	(4.19)	(3.76)	-
	40	(6.76)	(6.15)	(5.60)	(5.07)	(4.58)	(4.11)	(3.71)	-
	42	(6.78)	(6.15)	(5.60)	(5.10)	(4.60)	(4.14)	(3.74)	-
45	(6.82)	(6.15)	(5.60)	(5.15)	(4.64)	(4.17)	(3.78)	-	

Capacity	inlet heat source temp (°C)	COP for heating							
		outlet hot water temp (°C)							
		30	35	40	45	50	55	60	65
50% <30kW>	8	-	-	-	-	-	-	-	-
	10	-	-	-	-	-	-	-	-
	15	5.66	5.08	4.69	4.23	3.80	3.41	3.09	-
	20	5.88	5.36	4.84	4.41	3.95	3.57	3.23	-
	25	5.88	5.36	4.92	4.48	4.00	3.61	3.26	-
	27	5.88	5.36	4.92	4.48	4.00	3.61	3.30	-
	30	(6.74)	(6.06)	(5.50)	(5.00)	(4.47)	(4.00)	(3.60)	-
	32	(6.82)	(6.14)	(5.58)	(5.07)	(4.55)	(4.08)	(3.66)	-
	35	(6.94)	(6.25)	(5.69)	(5.19)	(4.67)	(4.19)	(3.76)	-
	40	(6.76)	(6.15)	(5.60)	(5.07)	(4.58)	(4.11)	(3.71)	-
	42	(6.78)	(6.15)	(5.60)	(5.10)	(4.60)	(4.14)	(3.74)	-
45	(6.82)	(6.15)	(5.60)	(5.15)	(4.64)	(4.17)	(3.78)	-	
42% <25kW>	8	-	-	-	-	-	-	-	-
	10	-	-	-	-	-	-	-	-
	15	(5.66)	(5.08)	(4.69)	(4.23)	(3.80)	(3.41)	2.98	-
	20	(5.88)	(5.36)	(4.84)	(4.41)	(3.95)	(3.57)	(3.23)	-
	25	(5.88)	(5.36)	(4.92)	(4.48)	(4.00)	(3.61)	(3.26)	-
	27	(5.88)	(5.36)	(4.92)	(4.48)	(4.00)	(3.61)	(3.30)	-
	30	(6.74)	(6.06)	(5.50)	(5.00)	(4.47)	(4.00)	(3.60)	-
	32	(6.82)	(6.14)	(5.58)	(5.07)	(4.55)	(4.08)	(3.66)	-
	35	(6.94)	(6.25)	(5.69)	(5.19)	(4.67)	(4.19)	(3.76)	-
	40	(6.76)	(6.15)	(5.60)	(5.07)	(4.58)	(4.11)	(3.71)	-
	42	(6.78)	(6.15)	(5.60)	(5.10)	(4.60)	(4.14)	(3.74)	-
45	(6.82)	(6.15)	(5.60)	(5.15)	(4.64)	(4.17)	(3.78)	-	

The figures in the round brackets show the COP under non-inverter control.

Heat source flow rate: 2.3m³/h

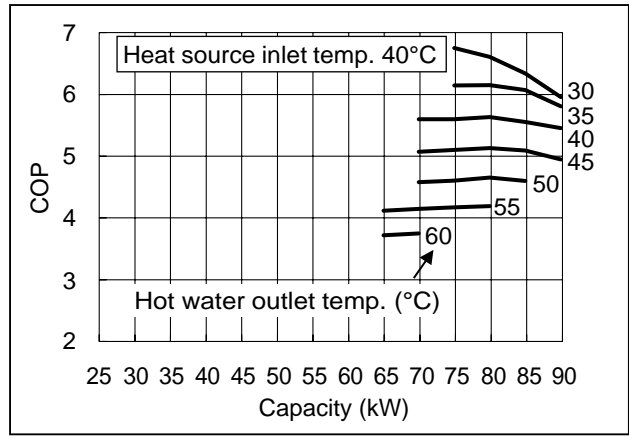
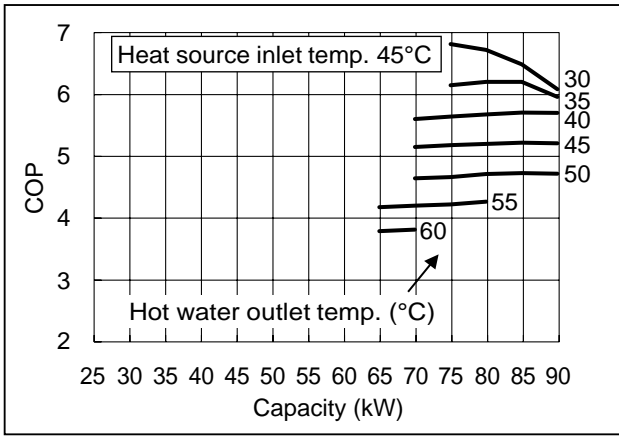

Heat source flow rate: 5.0m³/h

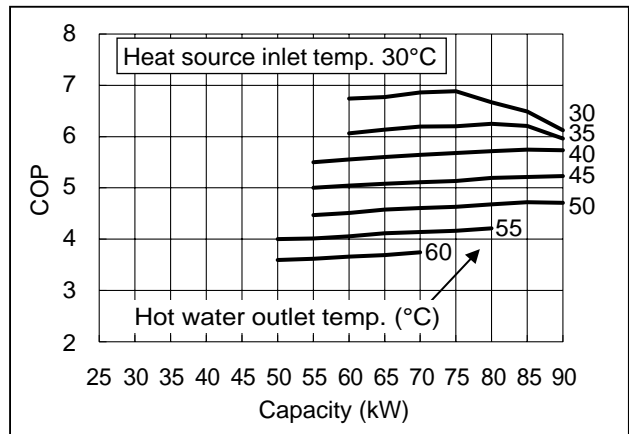
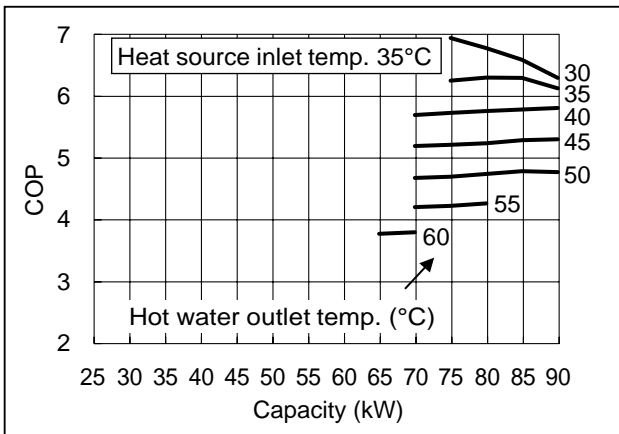

Heat source flow rate: 9.0m³/h

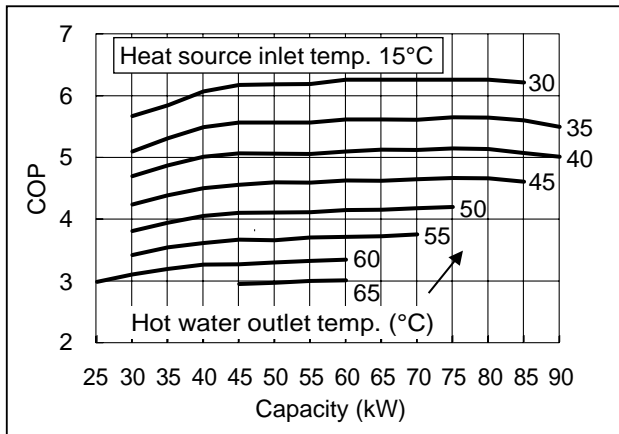
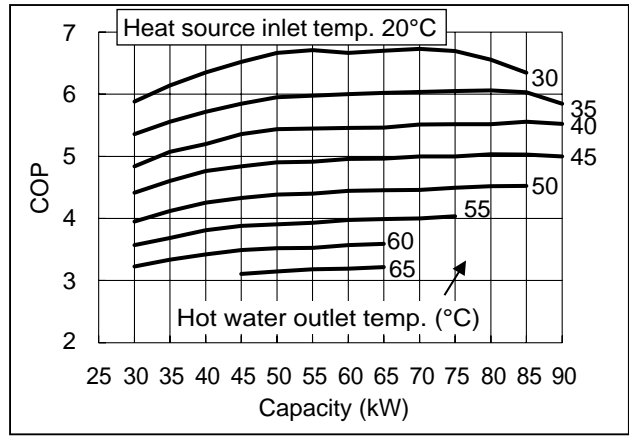
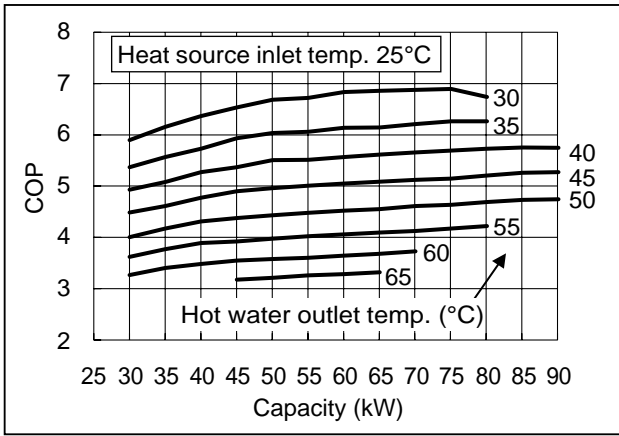

3. Correction by water flow rate

(1)-1 Hot water side

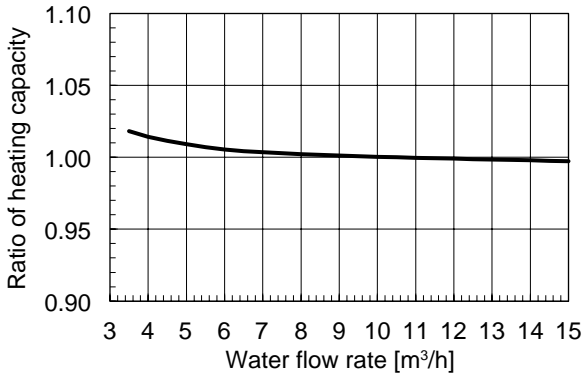

*Conditions Inlet heat source temp. 0°C
Inlet hot water temp. 30°C

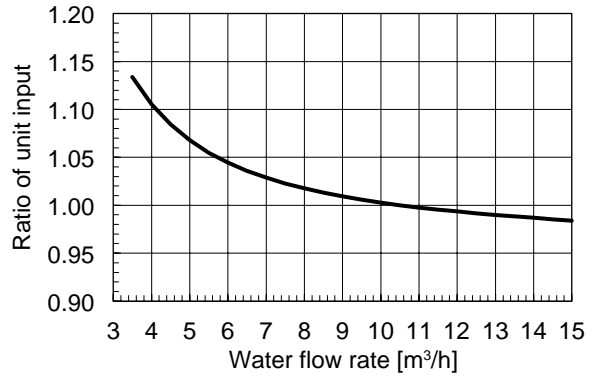

*Conditions Inlet heat source temp. 0°C
Inlet hot water temp. 30°C

(1)-2 Heat source side

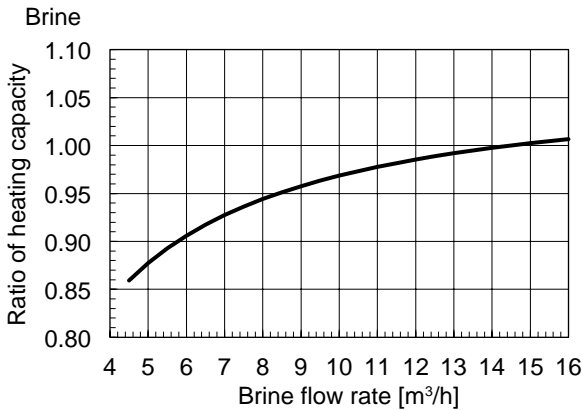

*Conditions Inlet heat source temp. 10°C
Inlet hot water temp. 30°C

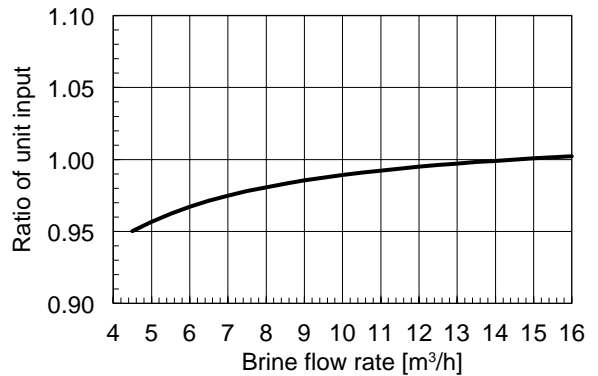

*Conditions Inlet heat source temp. 10°C
Inlet hot water temp. 30°C

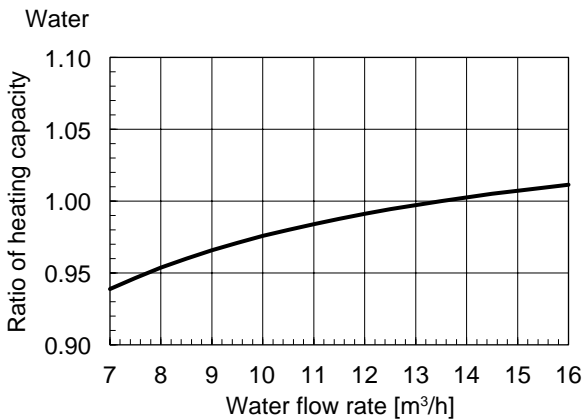

*Conditions Inlet heat source temp. 20°C
Inlet hot water temp. 30°C

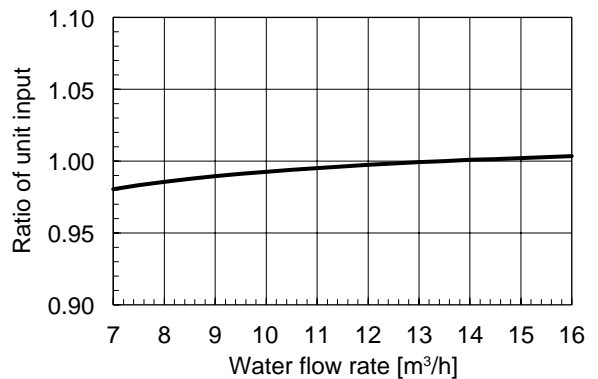

*Conditions Inlet heat source temp. 20°C
Inlet hot water temp. 30°C

4. Water pressure drop

- CRHV-P600YA-HPB

Hot water side (without field side water pipe)

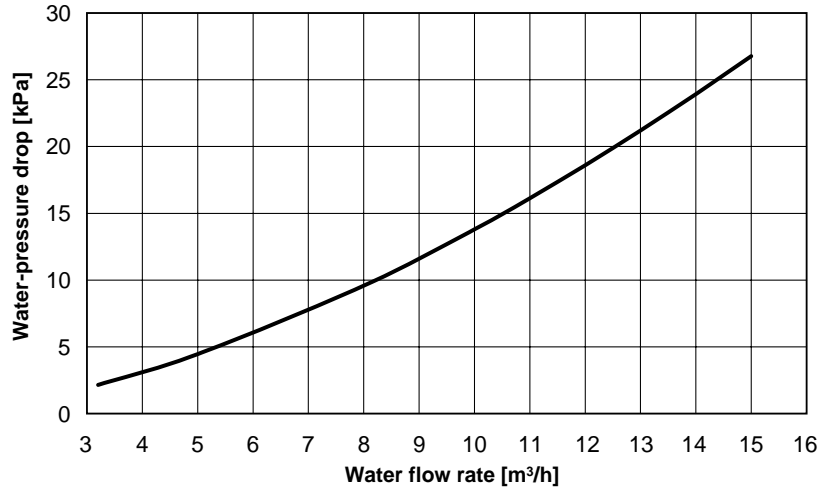

Heat source side (without field side water pipe)

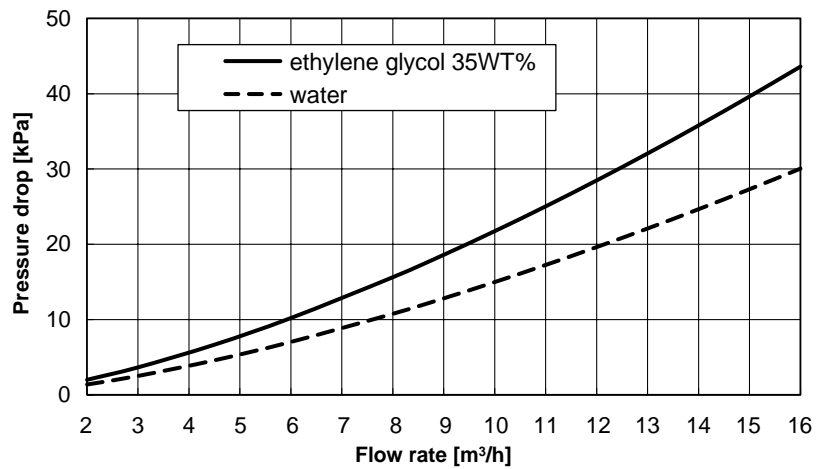

5. Operation temperature range

- CRHV-P600YA-HPB

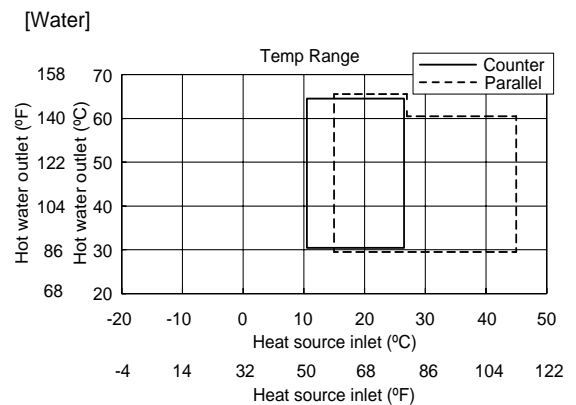
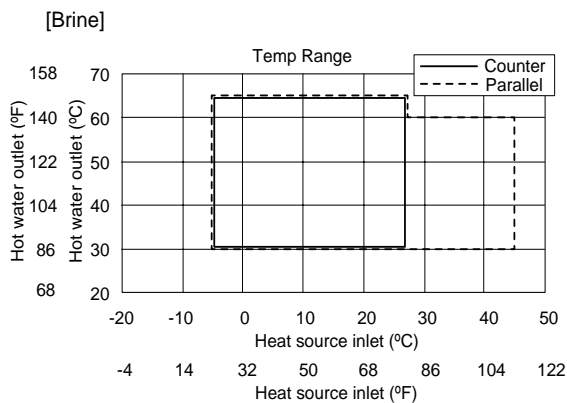

6. Characteristics of the brine

Brine concentration is decided by the freezing temperature. First, it is necessary to decide the freezing temperature and find out brine concentration which will correspond to the freezing temperature.

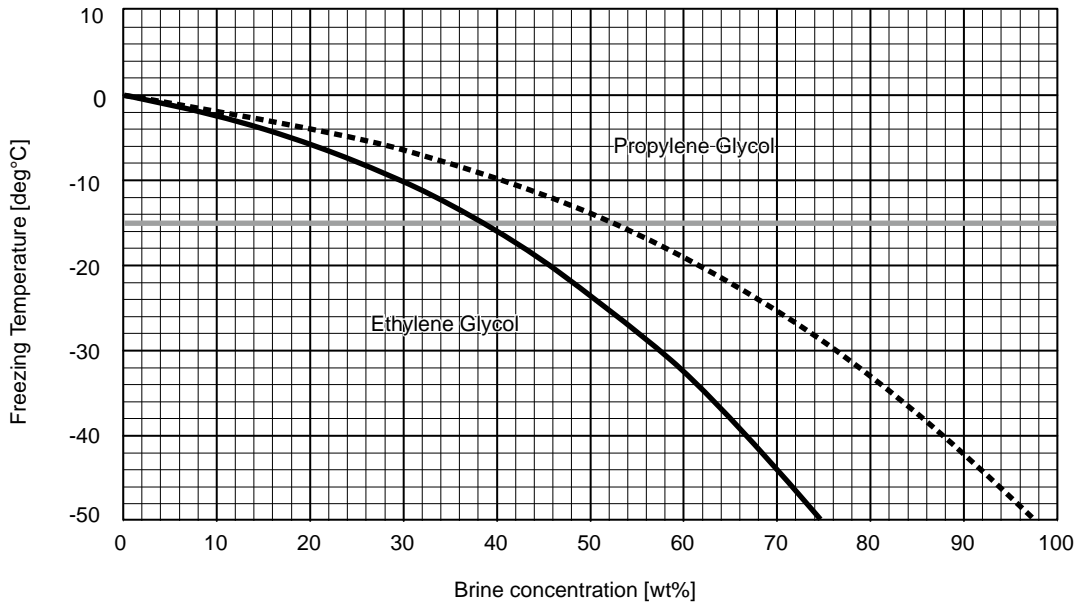

Note;

The graph was referred from chemical company data.

But Freezing Temperature condition will be slightly different based on each company.

Please confirm detail data to the chemical company directly.

It is recommended to set the brine concentration to a percentage that will keep the freezing temperature at -15deg°C or less.

7. Sound pressure levels

Measurement condition

- CRHV-P600YA-HPB

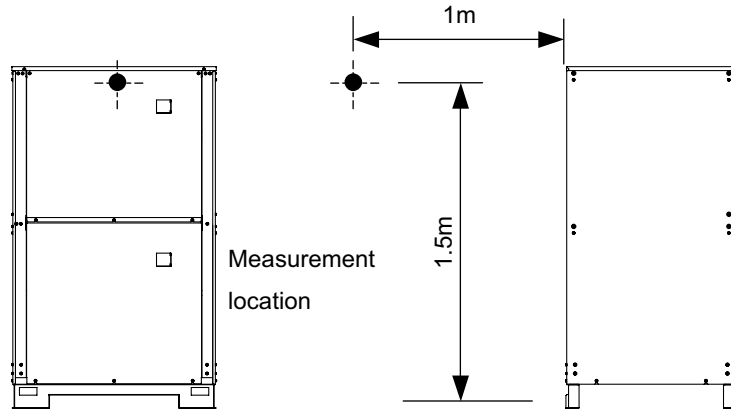

Sound Pressure Level: 50.0 dB (COP Priority Mode / Capacity Priority Mode)

Operation condition... Capacity 60kW: Inlet heat source temp.: 0°C, Outlet heat source temp.: -3°C,
Inlet hot water temp.: 30°C, Outlet hot water temp.: 35°C

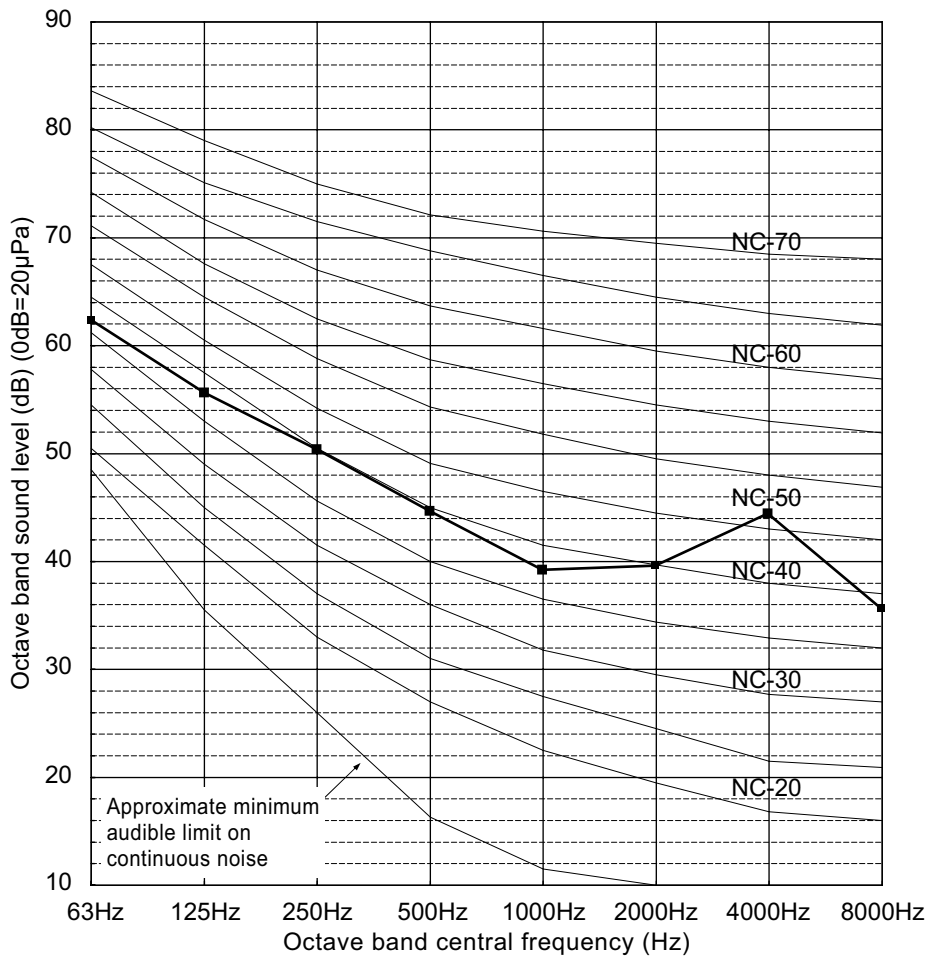

8. Vibration levels

- CRHV-P600YA-HPB

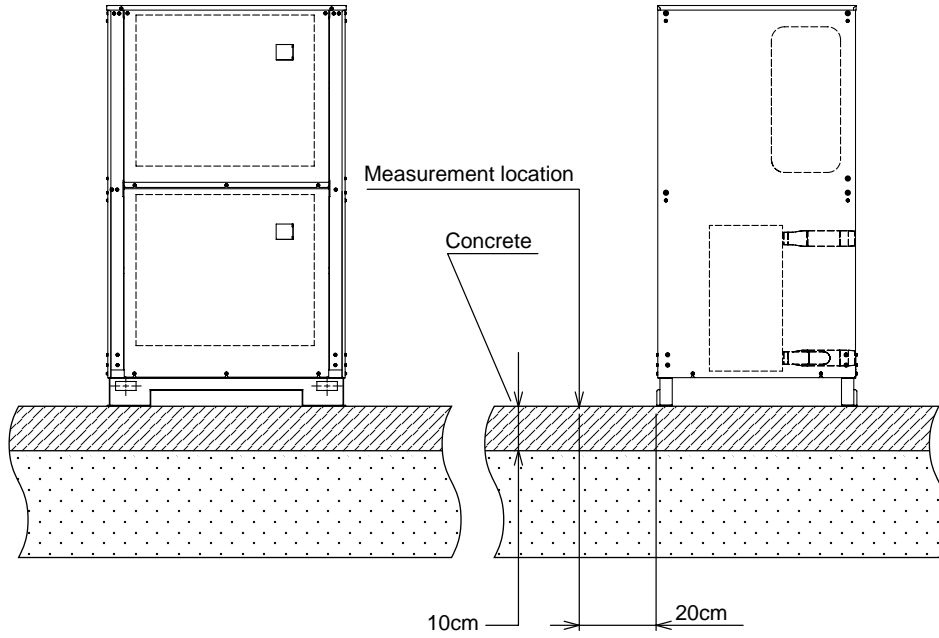

Model	Vibration Levels [dB]
CRHV-P600YA-HPB	47 or less

III | Installation

1. Selecting the Installation Site

(1) Installation conditions

Select the installation site in consultation with the client.

This product is for indoor use only. Do not install it outdoors.

Select a site to install the unit that meets the following conditions:

- The unit will not be subject to heat from other heat sources.
- The noise from the unit will not be a problem.

<PLAN>
SERVICE SPACE

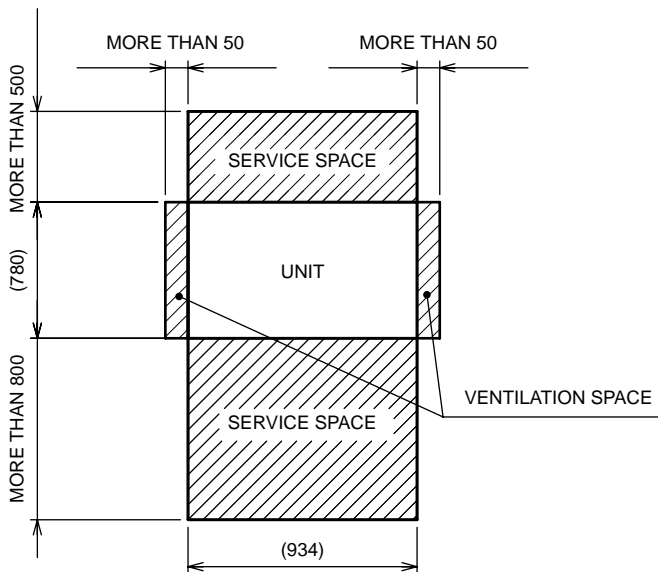

2. Installation of unit

Units should be installed only by personnel certified by Mitsubishi Electric.

(1) Product suspension method

- If transporting the product suspended, feed rope under the unit and use the two suspension sections at the front and rear.
- Always feed rope through the four suspension sections so that the unit is not subjected to shocks.
- Keep the rope angle at 40° or less as shown in the image below.
- Use two ropes that are 8 m or longer.
- Use suspension equipment that is capable of supporting the weight of the product.
- Always suspend the product in four sections. (do not suspend the product two sections as this is dangerous)
- Use the appropriate protective pads to ensure that the rope does not rub against the outer panel.

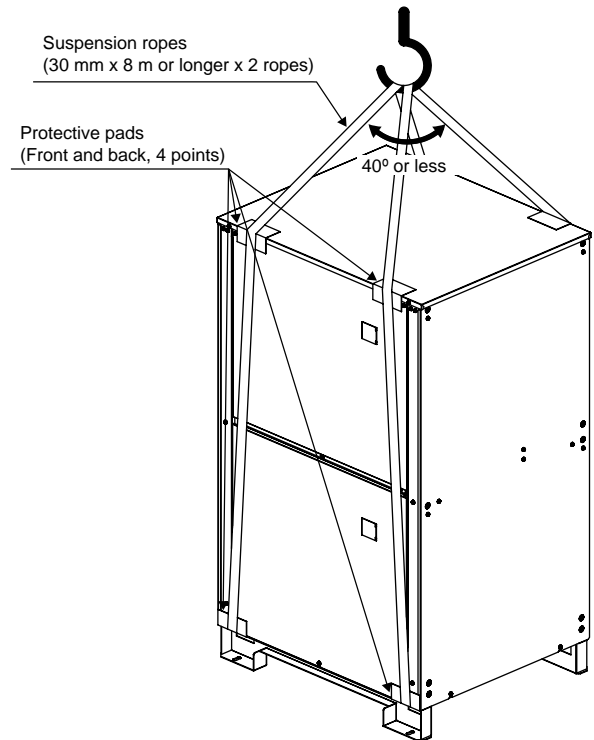

⚠ Warning:

- **To reduce the risk of injury, do not carry the product by the PP bands that are used on some packages.**
- **Do not carry products that exceed the specified weight by yourself. Doing so may cause injury.**
- **Lift the unit by placing the slings at designated locations. Support the Hot water Heat pump unit securely at four points to keep it from slipping and sliding. If the unit is not properly supported, it may fall and cause personal injury.**
- **Properly dispose of the packing materials. Tear up the packing materials that potentially pose suffocation hazards.**

(2) Installation on foundation

- Securely fix the unit with bolts to keep the unit from falling down during earthquakes.
- Install the unit on a foundation made of concrete or iron.
- Noise and vibrations from the unit may be transmitted through the floor and walls. Provide adequate protection against noise and vibration.
- Build the foundation in such way that the corners of the installation legs are securely supported as shown in the figure below. When using rubber vibration isolators, make sure they are large enough to cover the entire width of the unit's legs. If the corners of the legs are not firmly seated, the legs may bend.
- The projecting length of the anchor bolt should be less than 30 mm.
- This unit is not designed to be installed using hole-in anchor bolts unless brackets are used to support the four corners of the unit.

⚠ Warning:

- **Be sure to install the unit on a surface strong enough to withstand its weight to keep the unit from falling down and causing injury.**
- **Provide adequate protection against earthquakes. Improper installation may cause the unit to fall down, resulting in personal injury.**

When building the foundation, take the floor strength, and piping and wiring routes into consideration.

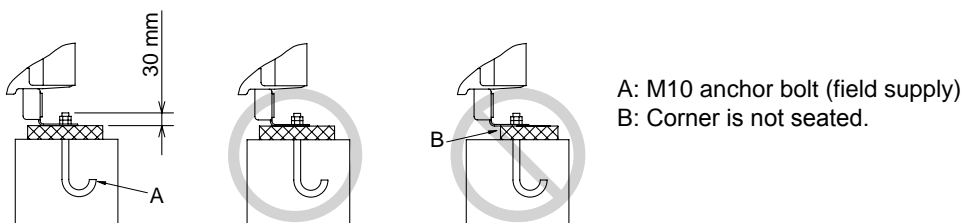

IV System Design

1. Water pipe installation

(1) Schematic Piping Diagram and Piping System Components

Please build the hot water and heat source fluid circuit so that it is a closed system.

Do not use hot water directly for showers or other applications.
Do not allow other heat source liquids to mix with the hot water and heat source fluid circuit.

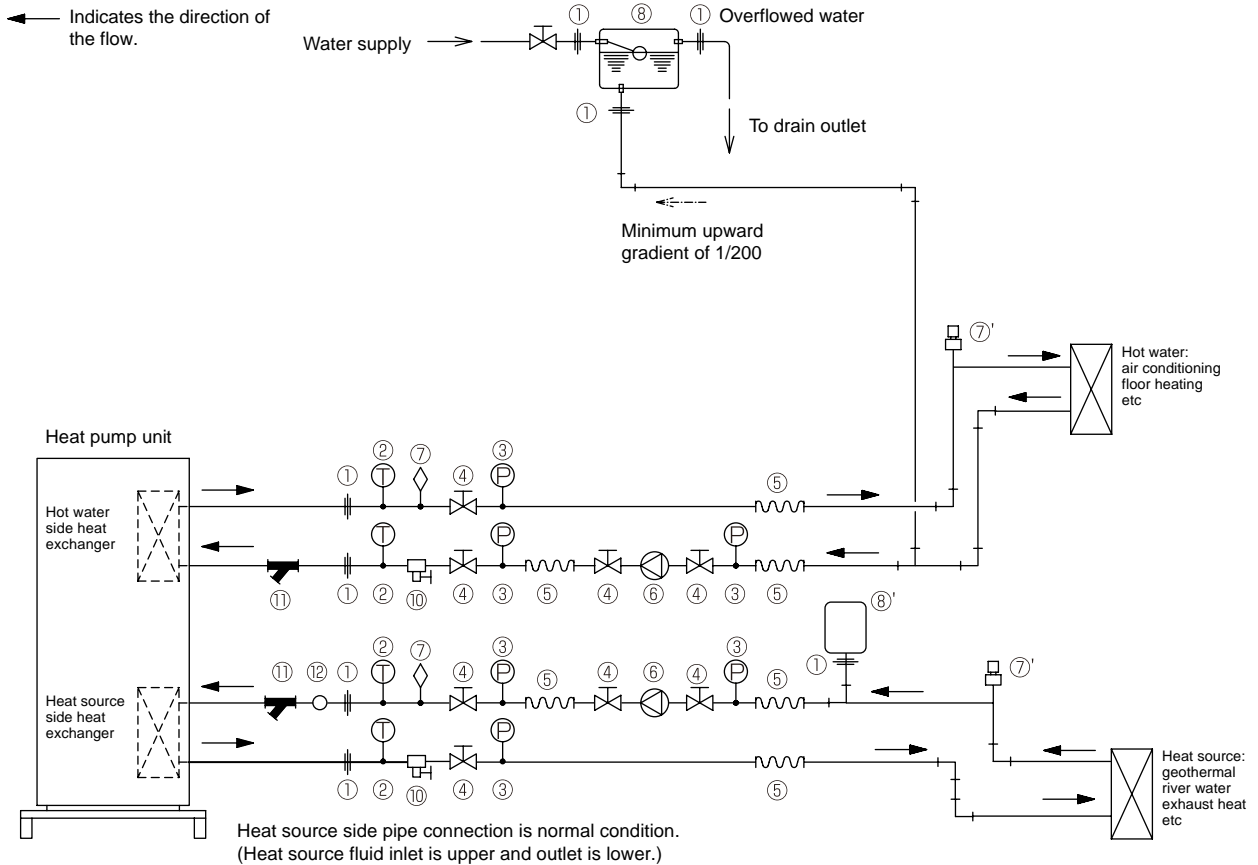

① Union joints/flange joints	Required to allow for a replacement of equipment.
② Thermometer	Required to check the performance and monitor the operation of the units.
③ Water pressure gauge	Recommended for checking the operation status.
④ Valve	Required to allow for a replacement or cleaning of the flow adjuster.
⑤ Flexible joint	Recommended to prevent the noise and vibration from the pump from being transmitted.
⑥ Pump	Use a pump that is large enough to compensate for the total water pressure loss and supply sufficient water to the unit.
⑦ Air vent valve	Install air venting valves to the places where air can accumulate. Automatic air vent valves (such as ⑦') are effective.
⑧ Expansion tank	Install an expansion tank to accommodate expanded water and to supply water.
⑧' Closed expansion tank	Use a closed expansion tank to help manage the concentration of brine.
⑨ Water pipe	Use pipes that allow for easy air purging, and provide adequate insulation.
⑩ Drain valve	Install drain valves so that water can be drained for servicing.
⑪ Strainer	Install a strainer near the unit to keep foreign materials from entering the water-side heat exchanger (supplied).
⑫ Flow switch	Required to protect the unit.

(2) Water piping attachment method

Applying sealant

Apply some sealant to the coupling screws.

When applying liquid sealant, use a brush.

Do not let the liquid sealant peel off and reach into the water circuit during installation or operation.

When using sealing tape, wrap the sealing tape around the coupling screws by following the procedures below.

- 1) Wrap sealing tape around the tip of a screwdriver approximately 23 times*, then cut the tape.
(*equivalent to the length sufficient to wrap around the coupling screws three times)
- 2) Attach the end of the sealing tape to the coupling screws, hold it with a finger, and wrap the sealing tape around the coupling screws, gradually turning the screwdriver to unwrap the tape from the screwdriver.

To reduce the risk of injury from metal sheet edges, wear protective gloves.

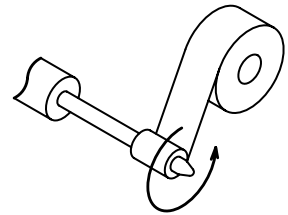

 Wear protective gloves

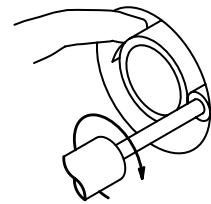

- The unit and water piping can be connected using a single spanner. Fastening torque $200 \text{ N}\cdot\text{m} \pm 10 \text{ N}\cdot\text{m}$.
- The noise level will increase if there is a gap between the water piping hole and the piping, so fill in the gap.

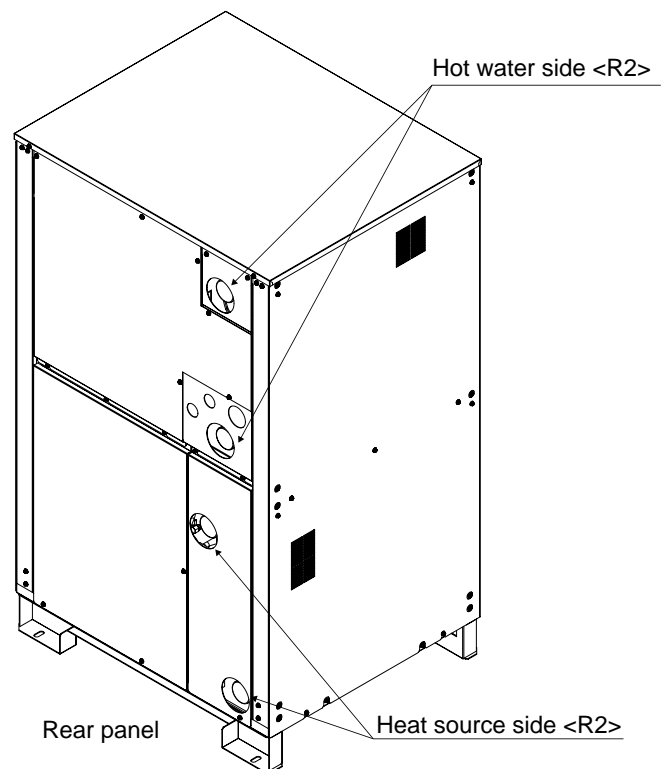

* Connect the heat source piping in reverse if the inlet temperature of heat source fluid is 27 °C or more.
 (heat source fluid inlet is lower side, outlet is upper side) Install the attached label as shown below if the heat source fluid is connected in reverse.

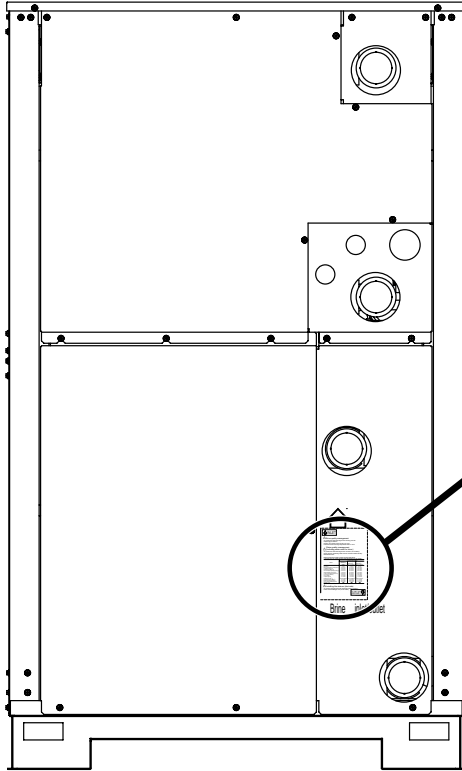

Accessory label (OUTLET)

OUTLET

⚠ Brine quality management
 To protect the heat exchanger from freezing, use the ethylene glycol 35wt%. Always use organic brine for this unit, and maintain brine's freezing temperature below -18°C.

⚠ Water quality management (including water used for brine.)
 To protect the heat exchanger from corrosion, the makeup water and the circulating water need to meet the Water Quality Standards below.

Makeup Water/Circulating Water Quality Standards
 <Quoted from the Water Quality Standards JRA GL-02-1994>

Item	Makeup water	Standard value	
		Circulating water (above 20°C, 80°C or below)	Circulating water (above 60°C, 80°C or below)
pH (25 °C)	7.0-8.0	7.0-8.0	7.0-8.0
Chloride ion (mg/L)	30 or less	30 or less	30 or less
Sulfate ion (mg/L)	30 or less	50 or less	30 or less
Acid consumption (pH, 10mg/L CaCO ₃)	50 or less	50 or less	50 or less
Total hardness (mg/L CaCO ₃)	70 or less	70 or less	70 or less
Calcium hardness (mg/L CaCO ₃)	50 or less	50 or less	50 or less
Iron (mg/L)	30 or less	30 or less	30 or less
Iron (mg/L)	0.3 or less	1.0 or less	1.0 or less
Copper (mg/L)	0.1 or less	1.0 or less	1.0 or less
Sulfide ion (mg/L)	Not to exceed	Not to exceed	Not to exceed
Ammonium ion (mg/L)	0.1 or less	0.3 or less	0.1 or less
Residual chlorine (mg/L)	0.3 or less	0.25 or less	0.1 or less
Free carbon dioxide (mg/L)	4.0 or less	0.4 or less	0.4 or less
Stability index	---	---	---

⚠ Installing the strainer (inlet side)
 To prevent clogging the heat exchanger, install a strainer at the heat exchanger inlet (15-20 mesh).

INLET

KC79M182H01

Accessory label (INLET)

(3) Notes on Pipe Corrosion

Water treatment and water quality control

Poor-quality circulating water can cause the water-side heat exchanger to scale up or corrode, reducing heat-exchange performance. Properly control the quality of the circulating water.

- Removing foreign objects and impurities in the pipes
During installation, keep foreign objects, such as welding and sealant fragments and rust, out of the pipes.

- Water Quality Control

(3)-1 Poor-quality water can corrode or scale up the heat exchanger. Regular water treatment is recommended.

Water circulation systems using open heat storage tanks are particularly prone to corrosion.

When using an open heat storage tank, install a water-to-water heat exchanger, and use a closed-loop circuit.

If a water supply tank is installed, keep contact with air to a minimum, and keep the level of dissolved oxygen in the water no higher than 1 mg/ℓ.

(3)-2 Water quality standard

Items		Lower mid-range temperature water system Water Temp. ≤ 60°C		Higher mid-range temperature water system Water Temp. > 60°C		Tendency	
		Recirculating water	Make-up water	Recirculating water	Make-up water	Corrosive	Scale-forming
Standard items	pH (25°C)	7.0 ~ 8.0	7.0 ~ 8.0	7.0 ~ 8.0	7.0 ~ 8.0	○	○
	Electric conductivity (mS/m) (25°C) (μs/cm) (25°C)	30 or less [300 or less]	30 or less [300 or less]	30 or less [300 or less]	30 or less [300 or less]	○	○
	Chloride ion (mg Cl ⁻ /ℓ)	50 or less	50 or less	30 or less	30 or less	○	
	Sulfate ion (mg SO ₄ ²⁻ /ℓ)	50 or less	50 or less	30 or less	30 or less	○	
	Acid consumption (pH4.8) (mg CaCO ₃ /ℓ)	50 or less	50 or less	50 or less	50 or less		○
	Total hardness (mg CaCO ₃ /ℓ)	70 or less	70 or less	70 or less	70 or less		○
	Calcium hardness (mg CaCO ₃ /ℓ)	50 or less	50 or less	50 or less	50 or less		○
Ionic silica (mg SiO ₂ /ℓ)	30 or less	30 or less	30 or less	30 or less		○	
Reference items	Iron (mg Fe/ℓ)	1.0 or less	0.3 or less	1.0 or less	0.3 or less	○	○
	Copper (mg Cu/ℓ)	1.0 or less	1.0 or less	1.0 or less	1.0 or less	○	
	Sulfide ion (mg S ²⁻ /ℓ)	Not to be detected	Not to be detected	Not to be detected	Not to be detected	○	
	Ammonium ion (mg NH ₄ ⁺ /ℓ)	0.3 or less	0.1 or less	0.1 or less	0.1 or less	○	
	Residual chlorine (mg Cl/ℓ)	0.25 or less	0.3 or less	0.1 or less	0.3 or less	○	
	Free carbon dioxide (mg CO ₂ /ℓ)	0.4 or less	4.0 or less	0.4 or less	4.0 or less	○	
Ryzner stability index	—	—	—	—	○	○	

Reference: Guideline of Water Quality for Refrigeration and Air Conditioning Equipment. (JRA GL02E-1994)

(3)-3 Please consult with a water quality control specialist about water quality control methods and water quality calculations before using anti-corrosive solutions for water quality management.

(3)-4 When replacing an air conditioner (including when only the heat exchanger is replaced), first analyze the water quality and check for possible corrosion.

Corrosion can occur in water systems in which there has been no signs of corrosion. If the water quality level has dropped, adjust the water quality before replacing the unit.

- Brine Quality Control

To protect the heat exchanger from freezing, use the ethylene glycol 35 wt%.

Always use organic brine for this unit, and maintain brine's freezing temperature below -18°C.

(3)-5 Suspended solids in the water

Sand, pebbles, suspended solids, and corrosion products in water can damage the heating surface of the heat exchanger and cause corrosion. Install a good quality strainer (20 mesh or better) at the inlet of the unit to filter out suspended solids.

Removing foreign substances from the water system

Consider installing a settlement tank or a bypass strainer to remove foreign substances from the water system. Select a strainer capable of handling two to three percent of the circulating water. The figure below shows a sample system with a bypass strainer.

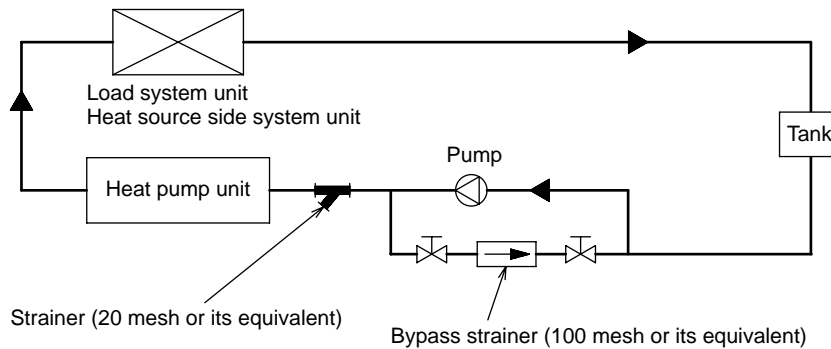

(3)-6 Connecting pipes made from different materials

If different types of metals are placed in direct contact with each other, the contact surface will corrode. Install an insulating material between pipes that are made of different materials to keep them out of direct contact with each other.

(3)-7 Piping material

Use hot water output piping material that can withstand heat of 70°C or more. Use hot water input piping material that can withstand the maximum input water temperature. Use heat source piping material that can withstand the minimum temperature. All piping must be made of SUS or similar material to withstand corrosion.

(4) Installing the water pipes

(4)-1 Installing the strainer

Install a strainer on the inlet pipe near the unit to filter out suspended solids and prevent clogging or corrosion of the heat exchanger.

Install a strainer in a way that allows for easy access for cleaning, and instruct the user to clean it regularly.

Operating the units with a clogged strainer may cause the units to make an abnormal stop.

Select a location to install a strainer, taking into consideration the installation angle, insulation thickness, and maintenance space.

* The dimensions given below indicate the amount of space necessary when screwing in a Y-shaped strainer.

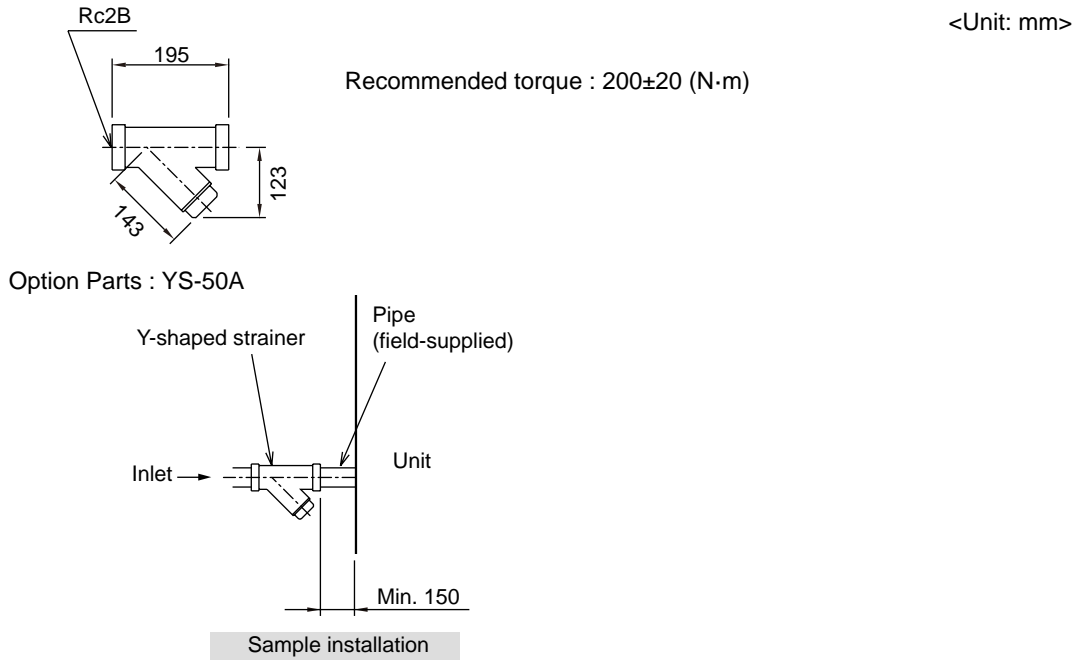

(4)-2 Installing a flow switch

Install a flow switch that meets the following specifications on the heat source fluid pipe.
Connect the flow switch to the flow switch contact on the unit.

Minimum flow rate= 4.5 m³/h (75 L/min)

Unit usage range (water flow rate): 4.5 - 16.0 m³/h

(4)-3 Water pipe hole size and location

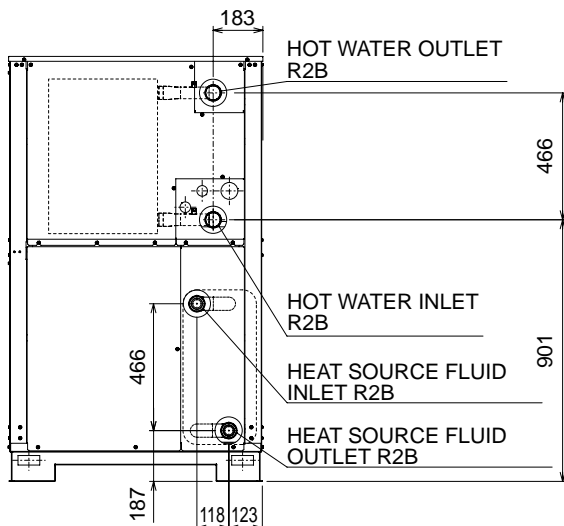

Heat source side pipe connection is normal condition.
(Heat source fluid inlet is upper and outlet is lower.)

2. Ensuring enough water in the water circuit

(1) Required amount of water

If the amount of water in the water circuit (circulating water circuit) is insufficient, the unit operation hours may become shorter or the amount of water temperature change to be controlled may become extremely large. Refer to the table below for the minimum amount of water required in the circuit. If the water pipe is too short to keep enough amount of water, install a cushion tank in the water pipe to ensure enough amount of water.

Model	Minimum amount of hot water (ℓ)	Minimum amount of heat source (ℓ)
CRHV-P600YA-HPB	550	390

(2) Calculating the required amount of water in the water circuit

The required amount of water in the water circuit can be obtained from the following formula.

(Required amount of water in the water circuit) = (Amount of water that can be held in the water pipe) + (Amount of water that can be held in the unit) + (Amount of water that can be held in the load-side or heat source unit)

The amount of water that can be held per meter of the water pipe (ℓ/m)

Pipe size					
3/4B (20A)	1B (25A)	1 1/4B (32A)	1 1/2B (40A)	2B (50A)	1 1/2B (65A)
0.37	0.60	0.99	1.36	2.20	3.62

The amount of water that can be held in the unit

Model	Hot water side (ℓ)	Heat source side (ℓ)
CRHV-P600YA-HPB	15	10

3. Pipe connection size and material

The table below shows the pipe connection size.

Pipe connection size

Model	Hot water side	Heat source side
CRHV-P600YA-HPB	R2 Male screw <SUS304>	R2 Male screw<SUS304>

V | Wiring Design

1. Electrical wiring installation

(1) Main Power Supply Wiring and Switch Capacity

Schematic Drawing of Wiring (Example)

- Ⓐ: Switch (with current breaking capability)
- Ⓑ: Current leakage breaker
- Ⓒ: Unit

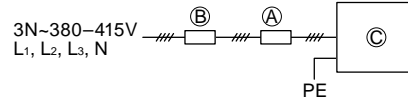

Main power supply wire size, switch capacities, and system impedance

Model	Minimum wire thickness (mm ²)			Current leakage of braker	Local switch (A)		No-fuse breaker (A)	Max. Permissive System Impedance
	Main cable	Branch	Ground		Capacity	Fuse		
CRHV-P600YA-HPB	25	-	25	75A 100mA 0.1sec. or less	75	75	75	0.18 Ω

- Use a dedicated power supply for each unit. Ensure that each unit is wired individually.
- When installing wiring, consider ambient conditions (e.g., temperature).
- The wire size is the minimum value for metal conduit wiring. If voltage drop is a problem, use a wire that is one size thicker.
Make sure the power-supply voltage does not drop more than 10%.
- Specific wiring requirements should adhere to the wiring regulations of the region.
- Power supply cords of appliances shall not be lighter than polychloroprene sheathed flexible cord (design 60245 IEC57).
- A switch with at least 3 mm contact separation in each pole shall be provided by the Air Conditioner installer.
- Do not install a phase advancing capacitor on the motor. Doing so may damage the capacitor and result in fire.

⚠ Warning:

- Be sure to use specified wires and ensure no external force is imparted to terminal connections. Loose connections may cause overheating and fire.
- Be sure to use the appropriate type of overcurrent protection switch. Note that overcurrent may include direct current.

⚠ Caution:

- Some installation sites may require an installation of an earth leakage breaker for the inverter. If no earth leakage breaker is installed, there is a danger of electric shock.
- Only use properly rated breakers and fuses. Using a fuse or wire of the wrong capacity may cause malfunction or fire.

Note:

- This device is intended for the connection to a power supply system with a maximum permissible system impedance shown in the above table at the interface point (power service box) of the user's supply.
- Ensure that this device is connected only to a power supply system that fulfills the requirements above. If necessary, consult the public power supply company for the system impedance at the interface point.
- This equipment complies with IEC 61000-3-12 provided that the short-circuit power S_{sc} is greater than or equal to $S_{sc} (*2)$ at the interface point between the user's supply and the public system. It is the responsibility of the installer or user of the equipment to ensure, in consultation with the distribution network operator if necessary, that the equipment is connected only to a supply with a short-circuit power S_{sc} greater than or equal to $S_{sc} (*2)$.

$S_{sc} (*2)$

S_{sc} (MVA)
3.42

Control cable specifications

Remote controller cable	Size	0.3 - 1.25 mm ² (Max. 200 m total)
	Recommended cable types	CVV
M-NET cable between units *1	Size	Min. 1.25 mm ² (Max. 120 m total)
	Recommended cable types	Shielded cable CVVS, CPEVS or MVVS
External input wire size		Min. 0.3 mm ²
External output wire size		1.25 mm ²

*1 Use a CVVS or CPEVS cable (Max. total length of 200 m) if there is a source of electrical interference near by (e.g., factory) or the total length of control wiring exceeds 120 m.

(2) Cable connections

(2)-1 Schematic Diagram of a Unit and Terminal Block Arrangement

To remove the front panel of the control box, unscrew the four screws and pull the panel forward and then down.

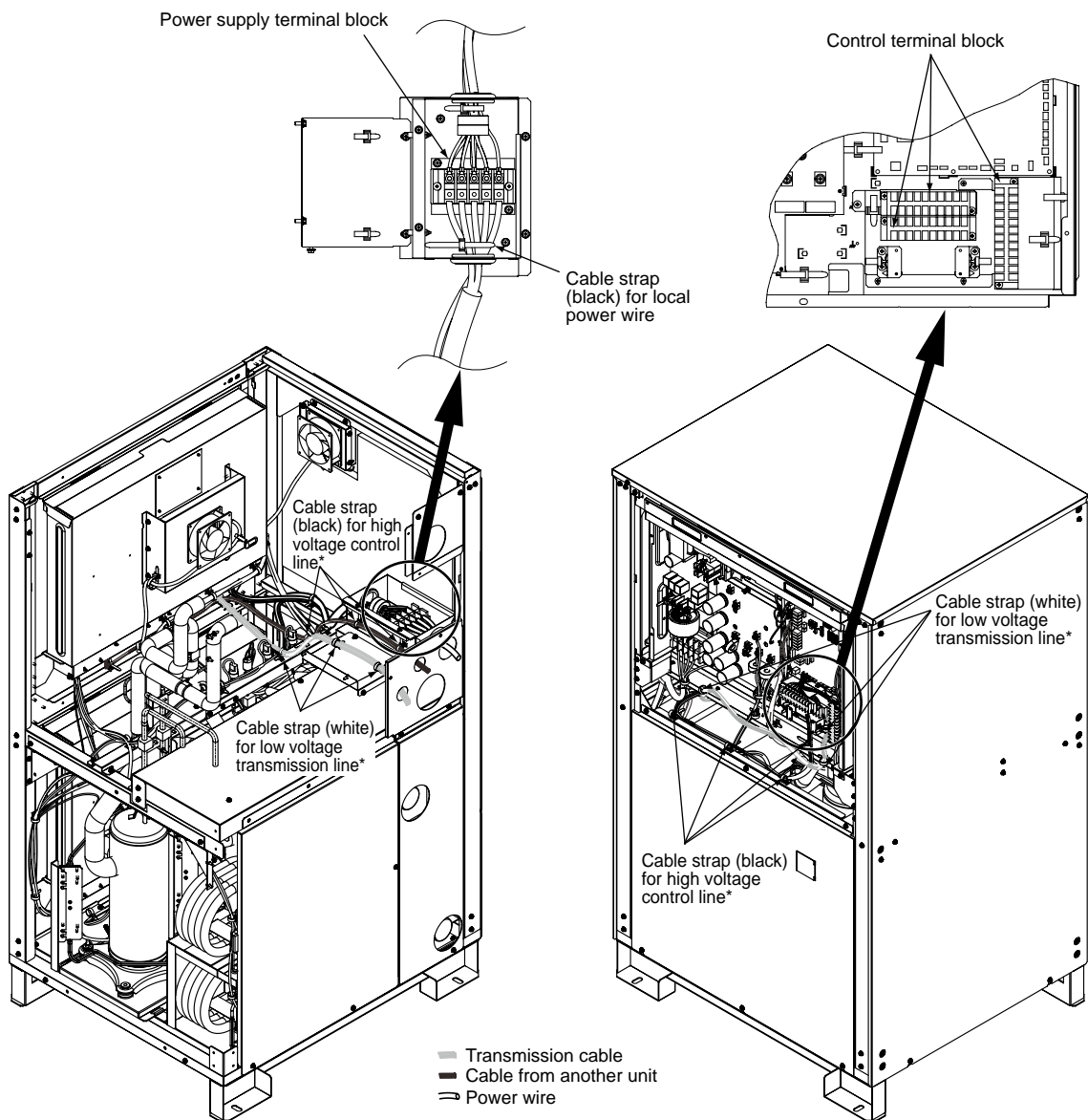

* When connecting the cables, first temporarily fasten the cables, and then fasten them properly after the cables have been connected to the terminal blocks within the control box.

(2)-2 Precautions when fastening screws

- * Faulty contacts due to loose screws may cause overheating and fire.
- * Using the circuit board while it is damaged may cause overheating and fire.

1) Screw fastening torque

Power supply terminal block (TB2)...M8 screw: 10 to 13.5 N·m

Use the following methods to check that the screws have been fastened.

1 Check that the spring washer is in a parallel position.

* If the screw is biting into the washer, simply fastening the screw to the specified torque cannot determine whether it has been installed properly.

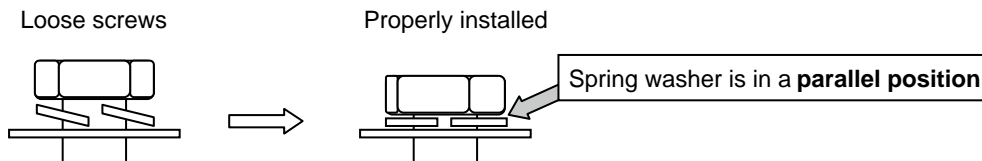

2 Check that the wiring does not move at the screw terminal.

2) Take extra care not to ruin the screw thread due to fastening the screw at an angle.

* To prevent fastening the screw at an angle, install the round terminals so they are back to back.

3) After fastening the screw, use a permanent marker to tick off the screw head, washer and terminal.

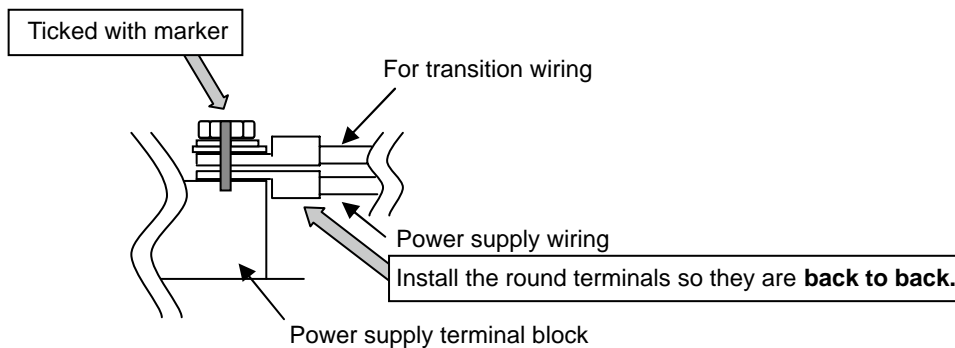

Important: Power supply cables larger than 25 mm² in diameter are not connectable to the power supply terminal block (TB2). Use a pull box to connect them.

(3) Installing the conduit tube

- Punch out the knockout hole for wire routing at the bottom of the front panel with a hammer.
- When putting wires through knockout holes without protecting them with a conduit tube, deburr the holes and protect the wires with protective tape.
- If damage from animals is a concern, use a conduit tube to narrow the opening.
- Always use a conduit to run the power supply wiring.
- Select the conduit size based on the knockout hole.

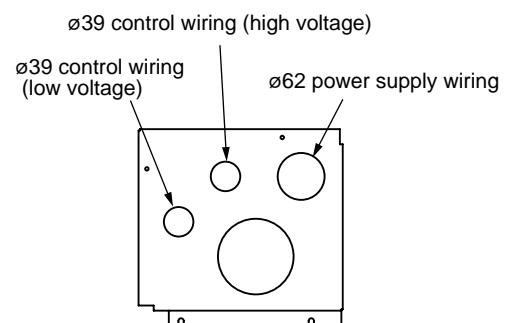
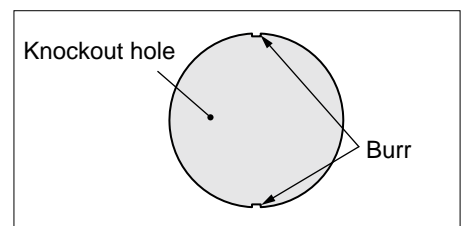

2. System configurations

(1) Types of control cables

Control cable wiring	Remote controller cable	Size	0.3 - 1.25 mm ² (Max. 200 m total)
		Recommended cable types	CVV
	M-NET cable between units *1	Size	More than 1.25 mm ² (Max. 120 m total)
		Recommended cable types	Shielding wire CVVS, CPEVS or MVVS
	External input wire size		Min. 0.3 mm ²
External output wire size		1.25 mm ²	

*1. Use a CVVS or CPEVS cable (Max. total length of 200 m) if there is a source of electrical interference near by (e.g., factory) or the total length of control wiring exceeds 120 m.

(2) System Configuration

(2)-1 Individual system

- Each unit is operated individually by connecting a dry contact switch/relay to each unit.

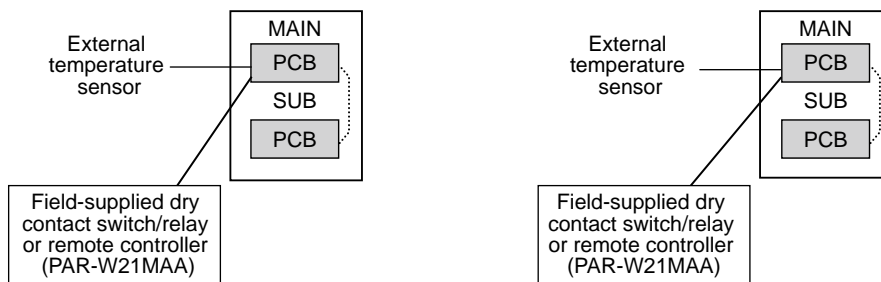

(2)-2 Multiple system (2-16 units)

- A group of unit that consists of one main unit and up to 15 sub units is operated collectively by connecting a representative water temperature sensor and a dry contact switch/relay to the main unit.

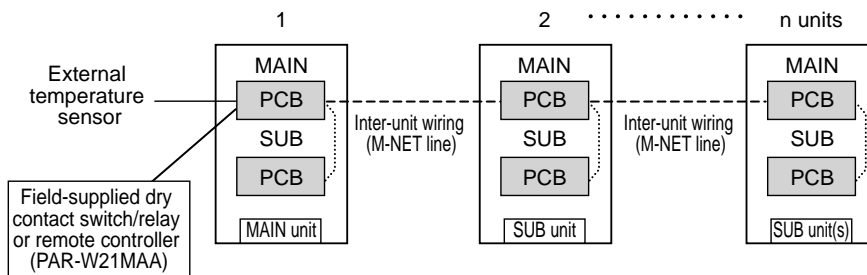

VI | Controller

1. PAR-W21MAA specifications

Item	Description	Operations	Display
ON/OFF	Runs and stops the operation of a group of units	○	○
Operation mode switching	Switches between Hot Water / Heating / Heating ECO / Anti-freeze * Available operation modes vary depending on the unit to be connected. * Switching limit setting can be made via a remote controller.	○	○
Water temperature setting	Temperature can be set within the ranges below. (in increments of 1°C or 1°F) Hot Water 30°C ~ 65°C Heating 30°C ~ 45°C Heating ECO 30°C ~ 45°C Anti-freeze 30°C ~ 45°C * The settable range varies depending on the unit to be connected.	○	○
Water temperature display	10°C ~ 90°C (in increments of 1°C or 1°F) * The settable range varies depending on the unit to be connected.	×	○
Permit / Prohibit local operation	Individually prohibits operations of each local remote control function :ON/OFF, Operation modes, water temperature setting, Circulating water replacement warning reset. * Upper level controller may not be connected depending on the unit to be connected.	×	○
Weekly scheduler	ON / OFF / Water temperature setting can be done up to 6 times one day in the week. (in increments of a minute)	○	○
Error	When an error is currently occurring on a unit, the afflicted unit and the error code are displayed.	×	○
Self check (Error history)	Searches the latest error history by pressing the CHECK button twice.	○	○
Test run	Enables the Test run mode by pressing the TEST button twice. * Test run mode is not available depending on the unit to be connected.	○	○
LANGUAGE setting	The language on the dot matrix LCD can be changed. (Seven languages) English/German/Spanish/Russian/Italian/French/Swedish	○	○
Operation locking function	Remote controller operation can be locked or unlocked. • All-switch locking • Locking except ON/OFF switch	○	○

DATA BOOK CRHV-P600YA-HPB



for a greener tomorrow

Eco Changes is the Mitsubishi Electric Group's environmental statement, and expresses the Group's stance on environmental management. Through a wide range of businesses, we are helping contribute to the realization of a sustainable society.

⚠ Warning

- Do not use refrigerant other than the type indicated in the manuals provided with the unit and on the nameplate.
 - Doing so may cause the unit or pipes to burst, or result in explosion or fire during use, during repair, or at the time of disposal of the unit.
 - It may also be in violation of applicable laws.
 - MITSUBISHI ELECTRIC CORPORATION cannot be held responsible for malfunctions or accidents resulting from the use of the wrong type of refrigerant.

MITSUBISHI ELECTRIC CORPORATION

HEAD OFFICE: TOKYO BLDG., 2-7-3, MARUNOUCHI, CHIYODA-KU, TOKYO 100-8310, JAPAN