

SERVICE MANUAL

R410A

[Model name]

[Service Ref.]

PUHZ-W85VHA2

PUHZ-W85VHA2.UK

PUHZ-W85VHA2-BS

PUHZ-W85VHA2-BS.UK

Note:

- This manual describes only service data of outdoor unit.
- RoHS compliant products have <G> mark on the spec name plate.

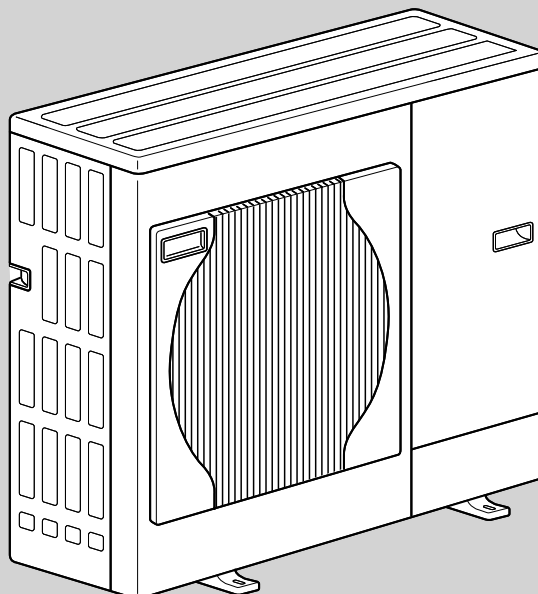

**PUHZ-W85VHA2.UK
PUHZ-W85VHA2-BS.UK**

CONTENTS

1. SAFETY PRECAUTION.....	2
2. SPECIFICATIONS.....	5
3. DATA	7
4. OUTLINES AND DIMENSIONS	9
5. WIRING DIAGRAM.....	10
6. WIRING SPECIFICATIONS	11
7. REFRIGERANT SYSTEM DIAGRAM.....	12
8. TROUBLESHOOTING.....	13
9. DISASSEMBLY PROCEDURE.....	42

PARTS CATALOG (OCB465)

1**SAFETY PRECAUTION****1-1. ALWAYS OBSERVE FOR SAFETY**

Before obtaining access to terminal, all supply circuits must be disconnected.

1-2. CAUTIONS RELATED TO NEW REFRIGERANT

Cautions for units utilizing refrigerant R410A

Do not use refrigerant other than R410A.

If other refrigerant (R22 etc.) is used, chlorine in refrigerant can cause deterioration of refrigerant oil etc.

Use a vacuum pump with a reverse flow check valve.

Vacuum pump oil may flow back into refrigerant cycle and that can cause deterioration of refrigerant oil etc.

Use the following tools specifically designed for use with R410A refrigerant.

The following tools are necessary to use R410A refrigerant.

Tools for R410A	
Gauge manifold	Vacuum pump adaptor
Charge hose	Electronic refrigerant charging scale
Gas leak detector	
Torque wrench	

Handle tools with care.

If dirt, dust or moisture enters into refrigerant cycle, that can cause deterioration of refrigerant oil or malfunction of compressor.

Do not use a charging cylinder.

If a charging cylinder is used, the composition of refrigerant will change and the efficiency will be lowered.

Ventilate the room if refrigerant leaks during operation. If refrigerant comes into contact with a flame, poisonous gases will be released.

Charge refrigerant from liquid phase of gas cylinder.

If the refrigerant is charged from gas phase, composition change may occur in refrigerant and the efficiency will be lowered.

[1] Cautions for service

- (1) Perform service after recovering the refrigerant left in unit completely.
- (2) Do not release refrigerant in the air.
- (3) After completing service, charge the cycle with specified amount of refrigerant.

[2] Additional refrigerant charge

When charging directly from cylinder

- Check that cylinder for R410A on the market is syphon type.
- Charging should be performed with the cylinder of syphon stood vertically. (Refrigerant is charged from liquid phase.)

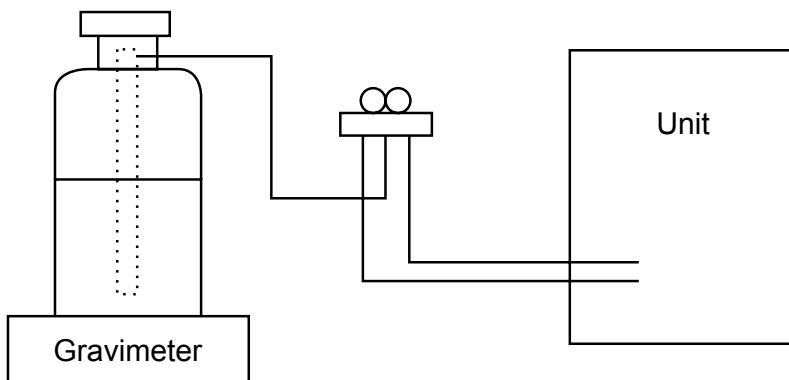

[3] Service tools

Use the below service tools as exclusive tools for R410A refrigerant.

No.	Tool name	Specifications
①	Gauge manifold	· Only for R410A · Use the existing fitting specifications. (UNF1/2) · Use high-tension side pressure of 5.3 MPa-G or over.
②	Charge hose	· Only for R410A · Use pressure performance of 5.09 MPa-G or over.
③	Electronic scale	—
④	Gas leak detector	· Use the detector for R134a, R407C or R410A.
⑤	Adaptor for reverse flow check	· Attach on vacuum pump.
⑥	Refrigerant charge base	—
⑦	Refrigerant cylinder	· Only for R410A Top of cylinder (Pink) Cylinder with syphon
⑧	Refrigerant recovery equipment	—

1-3. CAUTIONS FOR REFRIGERANT PIPING WORK

Tools for R410A (The following table shows whether conventional tools can be used or not.)

Tools and materials	Use	R410A tools	Can R22 tools be used?	Can R407C tools be used?
Gauge manifold	Air purge, refrigerant charge	Tool exclusive for R410A	×	×
Charge hose	and operation check	Tool exclusive for R410A	×	×
Gas leak detector	Gas leak check	Tool for HFC refrigerant	×	○
Refrigerant recovery equipment	Refrigerant recovery	Tool exclusive for R410A	×	×
Refrigerant cylinder	Refrigerant charge	Tool exclusive for R410A	×	×
Safety charger	Prevent compressor malfunction when charging refrigerant by spraying liquid refrigerant	Tool exclusive for R410A	×	×
Charge valve	Prevent gas from blowing out when detaching charge hose	Tool exclusive for R410A	×	×
Vacuum pump	Vacuum drying and air purge	Tools for other refrigerants can be used if equipped with adapter for reverse flow check	△ (Usable if equipped with adapter for reverse flow)	△ (Usable if equipped with adapter for reverse flow)
Bender	Bend the pipes	Tools for other refrigerants can be used	○	○
Pipe cutter	Cut the pipes	Tools for other refrigerants can be used	○	○
Welder and nitrogen gas cylinder	Weld the pipes	Tools for other refrigerants can be used	○	○
Refrigerant charging scale	Charge refrigerant	Tools for other refrigerants can be used	○	○
Vacuum gauge or thermistor vacuum gauge and vacuum valve	Check the degree of vacuum. (Vacuum valve prevents back flow of oil and refrigerant to thermistor vacuum gauge)	Tools for other refrigerants can be used	○	○
Charging cylinder	Refrigerant charge	Tool exclusive for R410A	×	—

× : Prepare a new tool. (Use the new tool as the tool exclusive for R410A.)

△ : Tools for other refrigerants can be used under certain conditions.

○ : Tools for other refrigerants can be used.

1-4. PRECAUTIONS FOR SALT PROOF TYPE "-BS" MODEL

Although "-BS" model has been designed to be resistant to salt damage, observe the following precautions to maintain the performance of the unit.

1. Avoid installing the unit in a location where it will be exposed directly to seawater or sea breeze.
2. If the cover panel may become covered with salt, be sure to install the unit in a location where the salt will be washed away by rainwater. (If a sunshade is installed, rainwater may not clean the panel.)
3. To ensure that water does not collect in the base of the outdoor unit, make sure that the base is level, not at angle. Water collecting in the base of the outdoor unit could cause rust.
4. If the unit is installed in a coastal area, clean the unit with water regularly to remove any salt build-up.
5. If the unit is damaged during installation or maintenance, be sure to repair it.
6. Be sure to check the condition of the unit regularly.
7. Be sure to install the unit in a location with good drainage.

2

SPECIFICATIONS

2-1. SPECIFICATIONS

PUHZ-W85VHA2.UK PUHZ-W85VHA2-BS.UK

Power supply (Phase, Voltage, Frequency)		1 φ, 230V, 50Hz	
Nominal water flow rate (Heating mode)		L/min	25.8
Heating (A7/W35)	Capacity	kW	(Min.2.70 ~) 9.00
	COP		4.18
	Power input	kW	2.15
Heating (A2/W35)	Capacity	kW	(Min.2.60 ~) 8.50
	COP		3.17
	Power input	kW	2.68
Pressure difference (water circuit)		kPa	13.5
Heating pump input (based on EN14511)		kW	0.02
Nominal water flow rate (Cooling mode)		L/min	21.5
Cooling (A35/W7)	Capacity	kW	7.50
	EER (COP)		2.47
	Power input	kW	3.04
Cooling (A35/W18)	Capacity	kW	7.50
	EER (COP)		3.93
	Power input	kW	1.91
Pressure difference (water circuit)		kPa	10
Cooling pump input (based on EN14511)		kW	0.012

Note: "Capacity", "COP" and "Power input" in the above table are values that contains the "pump input (based on EN 14511)".

Outdoor unit specifications			
Model name		PUHZ-W85VHA2(-BS)	
Running current	Heating(A7/W35)	A	9.38
	Cooling(A35/W7)	A	13.15
Power factor	Heating(A7/W35)	%	98
	Cooling(A35/W7)	%	98
Max. current	A		23.0
Breaker size	A		25
Outer casing		Galvanized plate	
External finish		Munsell 3Y 7.8/1.1	
Refrigerant control		Linear expansion valve	
Compressor		Hermetic twin rotary	
	Model	TNB220FLHM1T	
	Motor output	kW	1.3
	Start type	Inverter	
	Protection devices	HP switch Discharge thermo Shell thermo	
	Oil (Model)	L	0.67 (FV50S)
Crankcase heater		W	-
Heat exchanger	Air	Plate fin coil	
	Water	Plate heat exchanger	
Fan	Fan(drive)×No.	Propeller fan × 1	
	Fan motor output	kW	0.060
	Air flow	m ³ /min	49
(CFM)		(1,730)	
Defrost method		Reverse cycle *1	
Noise level (SPL)	Heating	dB	48 *2
	Cooling	dB	48 *2
Dimensions	Width	mm (in.)	950 (37-3/8)
	Depth	mm (in.)	330 +30 ⁻³ (13+1-3/16)
	Height	mm (in.)	943 (37-1/8)
Weight	kg (lbs)	79 (174)	
Refrigerant		R410A	
	Quantity	kg (lbs)	2.4 (5.3)
Guaranteed operating range (Outdoor)	Heating	°C	-20 ~ +35
	Cooling	°C	-5 ⁻⁴ ~ +46
Outlet water temp. (Max in heating, Min in cooling)	Heating	°C	+60
	Cooling	°C	+5
Nominal return water temperature range	Heating	°C	+5 ~ +59
	Cooling	°C	+8 ~ +28
Water flow rate range	L/min	10.0 ~ 25.8 ⁻⁵	

Nominal operating condition	
Heating(A7/W35)	
Outside air temperature (Dry-bulb)	+ 7°C
Outside air temperature (Wet-bulb)	+ 6°C
Water temperature (inlet/outlet)	+30/+35°C
Heating(A2/W35)	
Outside air temperature (Dry-bulb)	+ 2°C
Outside air temperature (Wet-bulb)	+ 1°C
Water temperature (inlet/outlet)	-/+35°C
Cooling(A35/W7)	
Outside air temperature (Dry-bulb)	+35°C
Outside air temperature (Wet-bulb)	+ 24°C
Water temperature (inlet/outlet)	+12/+7°C
Cooling(A35/W18)	
Outside air temperature (Dry-bulb)	+35°C
Outside air temperature (Wet-bulb)	+ 24°C
Water temperature (inlet/outlet)	+23/+18°C

Note: We confirm that our units are tested based on EN14511.

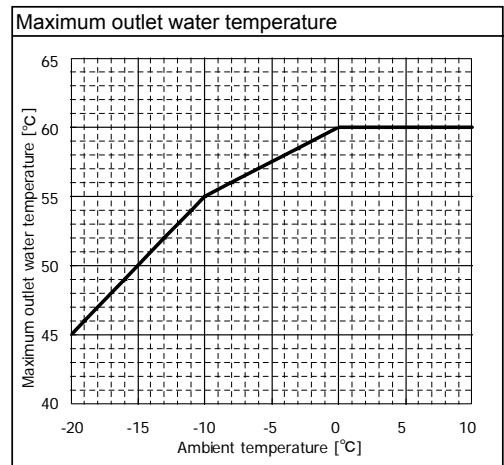
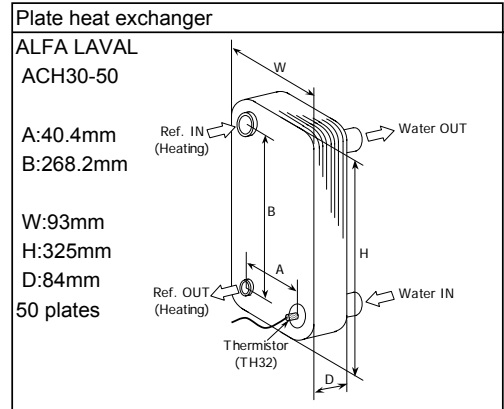

*1 Hot gas with 4-way valve

*2 at distance of 1m from outdoor unit

*3 grill

*4 With the optional air outlet guide, the operation at -15°C outdoor temperature is possible.

*5 For details of the min. return water temperature at each water flow rate, refer to the chapter 2-2.

2-2. AVAILABLE RANGE (WATER FLOW RATE, RETURN WATER TEMP.)

Note: If the value of water flow rate and return water temp. become lower than the available range, it could cause damage to the parts of unit.

<Heating>

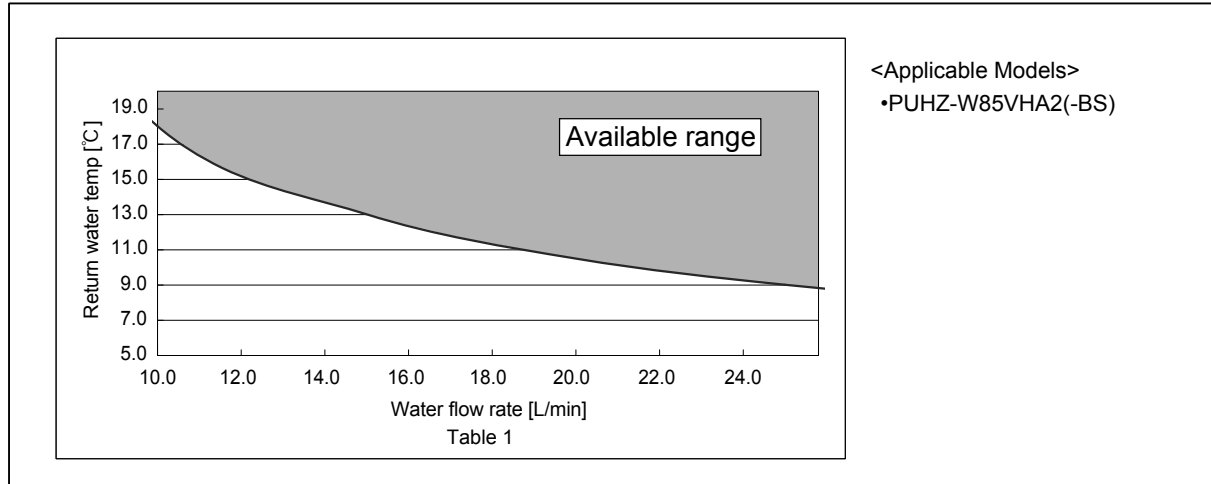

<Cooling>

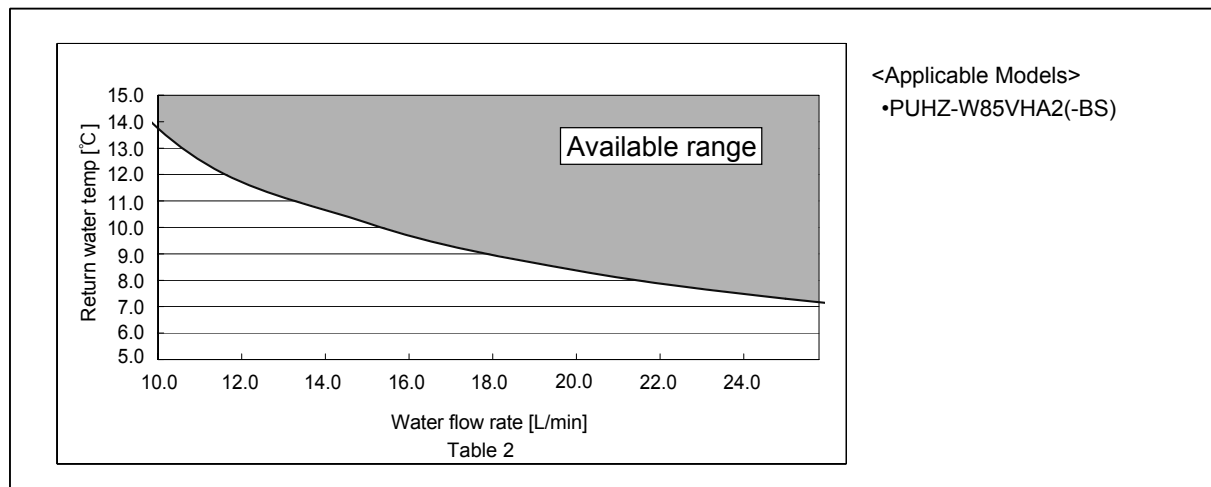

3-1. NOISE CRITERION CURVES

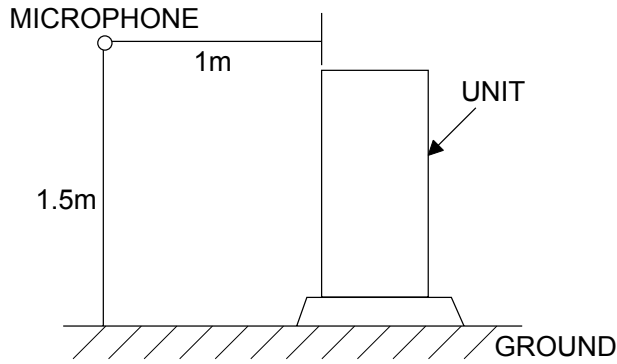

PUHZ-W85VHA2(-BS).UK

MODE	SPL(dB)	LINE
COOLING	48	○—○
HEATING	48	●—●

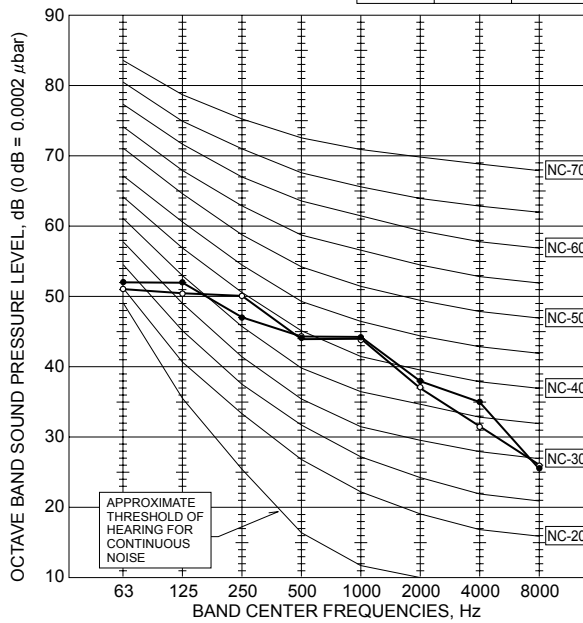

3-2. STANDARD OPERATION DATA

Mode			Cooling (A35/W7)	Heating (A7/W35)
Total	Capacity	W	7,500	9,000
	Input	kW	3.04	2.15
Electrical circuit	Outdoor unit		PUHZ-W85VHA2	
	Phase, Hz		1, 50	
	Voltage	V	230	
	Current	A	13.15	9.38
Refrigerant circuit	Discharge pressure	MPa	2.81	2.16
	Suction pressure	MPa	0.73	0.64
	Discharge temperature	°C	80	65
	Condensing temperature	°C	46	37
	Suction temperature	°C	3	-1
Water conditions	Flow volume	L/min	21.5	25.8
	Outlet water temperature	°C	7	35
Outdoor conditions	Intake air temperature	D.B. °C	35	7
		W.B. °C	24	6

The unit of pressure has been changed to MPa based on international SI system.

The conversion factor is: 1 (MPa) = 10.2 (kgf/cm²)

We confirm that our units are tested based on EN 14511.

PUHZ-W85VHA2(-BS).UK

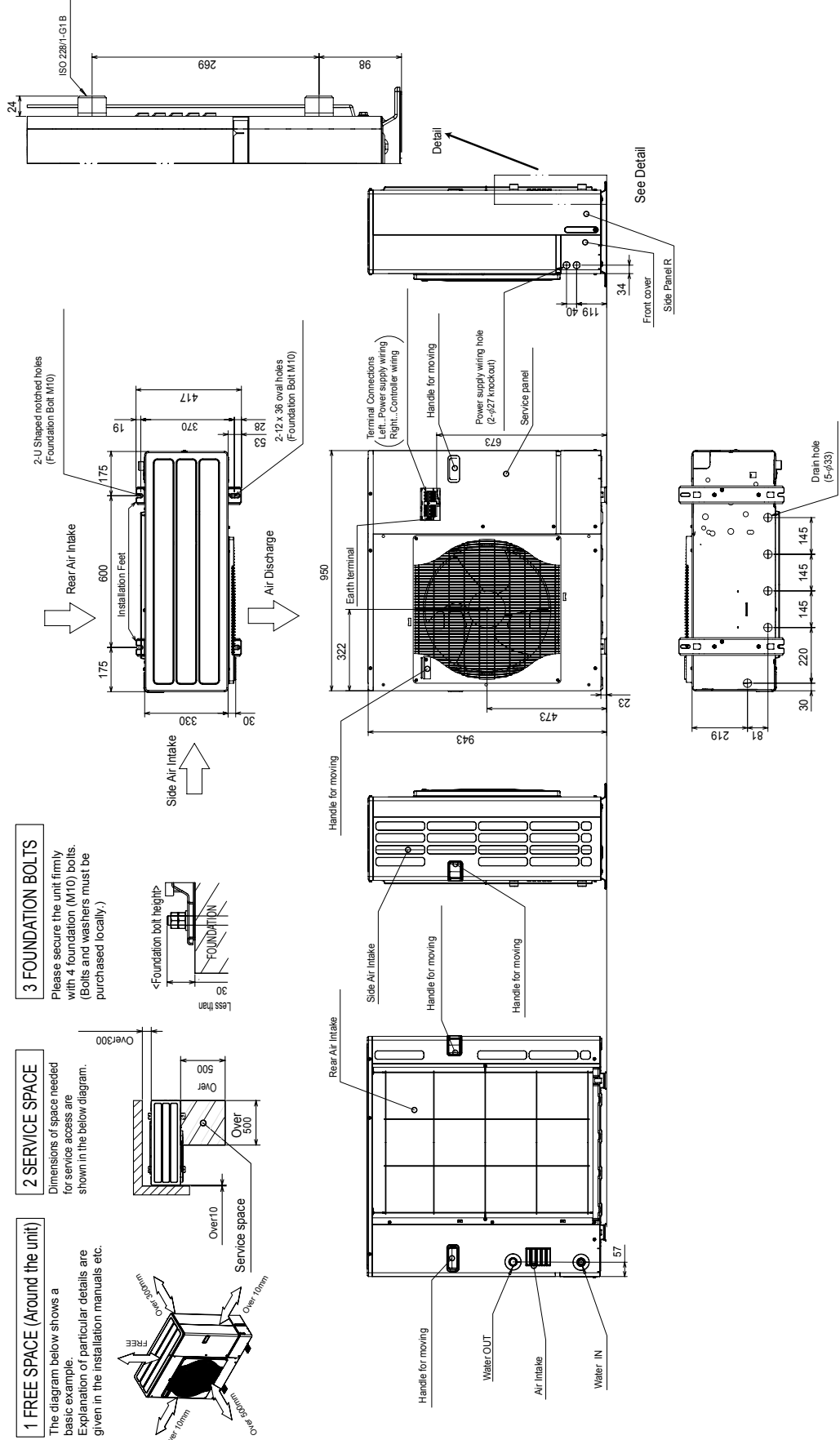

3 FOUNDATION BOLTS

Please secure the unit firmly with 4 foundation (M10) bolts. (Bolts and washers must be purchased locally.)

2 SERVICE SPACE

Dimensions of space needed for service access are shown in the below diagram.

1 FREE SPACE (Around the unit)

The diagram below shows a basic example. Explanation of particular details are given in the installation manuals etc.

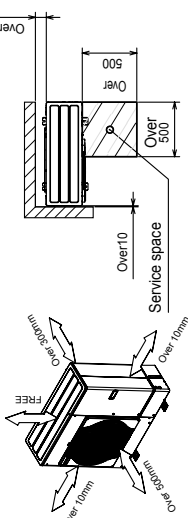

PUHZ-W85VHA2.UK PUHZ-W85VHA2-BS.UK

SYMBOL	NAME	SYMBOL	NAME
TB1	Terminal Block <Power Supply,Interface unit / Flow temp. controller>	TABP1/P2	Connection Terminal <DC Voltage>
MC	Motor for Compressor	TABN1/N2	Connection Terminal <DC Voltage>
MF1	Fan Motor	DS2, DS3	Diode bridge
21S4	Solenoid Valve <Four-Way Valve>	IPM	Power Module
SV	Solenoid Valve <Bypass Valve>	N.F.	Noise Filter Circuit Board
63H	High Pressure Switch	LI,LO	Connection Terminal <L-Phase>
63HS	High Pressure Sensor	NI,NO	Connection Terminal <N-Phase>
TH3	Thermistor <Liquid>	E1,E2	Connection Terminal <Ground>
TH4	Thermistor <Discharge>	S2C	S2C Relay
TH6	Thermistor <Plate HEX liquid>	C.B.	Controller Circuit Board
TH7	Thermistor <Ambient>	SW1	Switch <Function Switch>
TH8	Thermistor <Heat sink>	SW2	Switch <Function Switch>
TH32	Thermistor <Inlet water>	SW5	Switch <Function Switch>
TH33	Thermistor <Comp Surface>	SW6	Switch <Model Select>
LEV-A, LEV-B	Electronic Expansion Valve	SW7	Switch <Function Switch>
DCL	Reactor	SW8	Switch <Function Switch>
ACTM	Active Filter Module	SW10	Switch <Model Select>
CY1,CY2	Capacitor	SV1	Connector <Connection for Option>
P.B.	Power Circuit Board	CNDM	Connector <Connection for Option(Contact Input)>
TABU/V/W	Connection Terminal <U/V/W-Phase>	LED3	LED <Operation/Inspection Indicators>
TABS/T	Connection Terminal <L/N-Phase>	F1~F4	Fuse <T6.3AL250V>
		X52,X54, X55	Relay

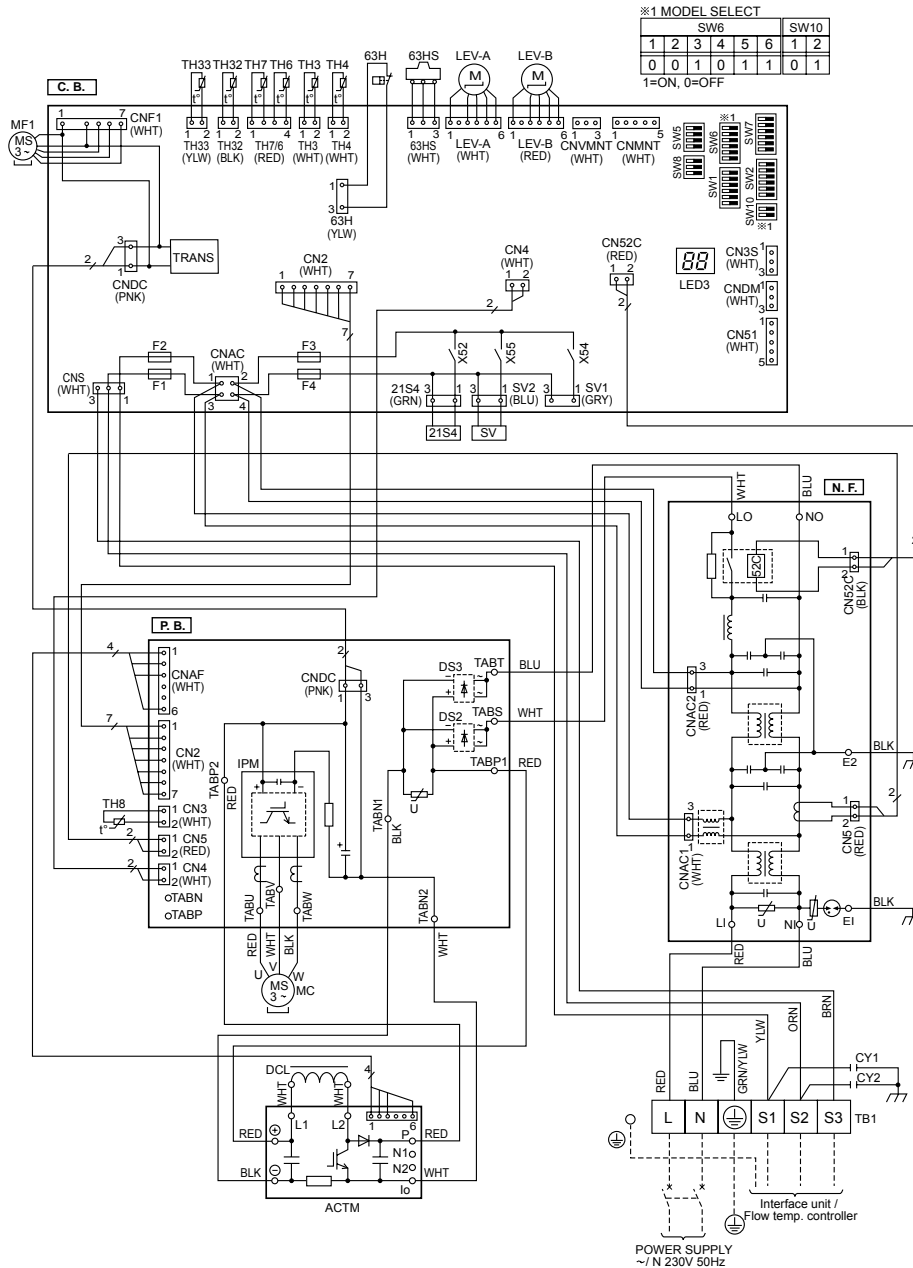

FIELD ELECTRICAL WIRING (power wiring specifications)

Outdoor unit model		85V
Outdoor unit power supply		~N (single), 50 Hz, 230 V
Outdoor unit Circuit Breaker capacity		25A
Wiring × Wire No. × size (mm ²)	Outdoor unit power supply, earth	3 × Min. 4
	Interface unit/Flow temp. controller-Outdoor unit	3 × 1.5 (polar)
	Interface unit/Flow temp. controller-Outdoor unit earth	1 × Min. 1.5
	Remote controller-Interface unit/Flow temp. controller	2 × 0.3 (Non-polar)
Circuit rating	Outdoor unit L-N (single)	AC 230V
	Interface unit/Flow temp. controller-Outdoor unit S1-S2	AC 230V
	Interface unit/Flow temp. controller-Outdoor unit S2-S3	DC 24V
	Remote controller-Interface unit/Flow temp. controller	DC 12V

*1. A breaker with at least 3.0 mm contact separation in each poles shall be provided. Use earth leakage breaker (NV).

*2. Max. 80 m

*3. The figures are NOT always against the ground.

S3 terminal has DC 24 V against S2 terminal. However between S3 and S1, these terminals are NOT electrically insulated by the transformer or other device.

⚠ Caution: Be sure to install N-line. Without N-line, it could damage the unit.

Notes: 1. Wiring size must comply with the applicable local and national codes.

2. Power supply cables and the cables between Controller and Outdoor unit shall not be lighter than polychloroprene sheathed flexible cables. (Design 60245 IEC 57)

3. Be sure to connect the cables between Controller and Outdoor unit directly to the units (no intermediate connections are allowed).

Intermediate connections may result in communication errors. If water enters at the intermediate connection point, it may cause insufficient insulation to ground or a poor electrical contact .

4. Install an earth longer than other cables.

5. Do not construct a system with a power supply that is turned ON and OFF frequently.

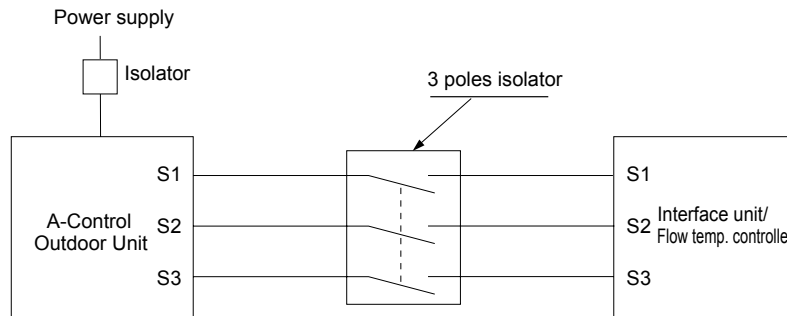

⚠ Warning:

In case of A-control wiring, there is high voltage potential on the S3 terminal caused by electrical circuit design that has no electrical insulation between power line and communication signal line. Therefore, please turn off the main power supply when servicing. And do not touch the S1, S2, S3 terminals when the power is energized. If isolator should be used between Interface unit/Flow temp. controller and outdoor unit, please use 3-pole type.

7

REFRIGERANT SYSTEM DIAGRAM

PUHZ-W85VHA2.UK PUHZ-W85VHA2-BS.UK

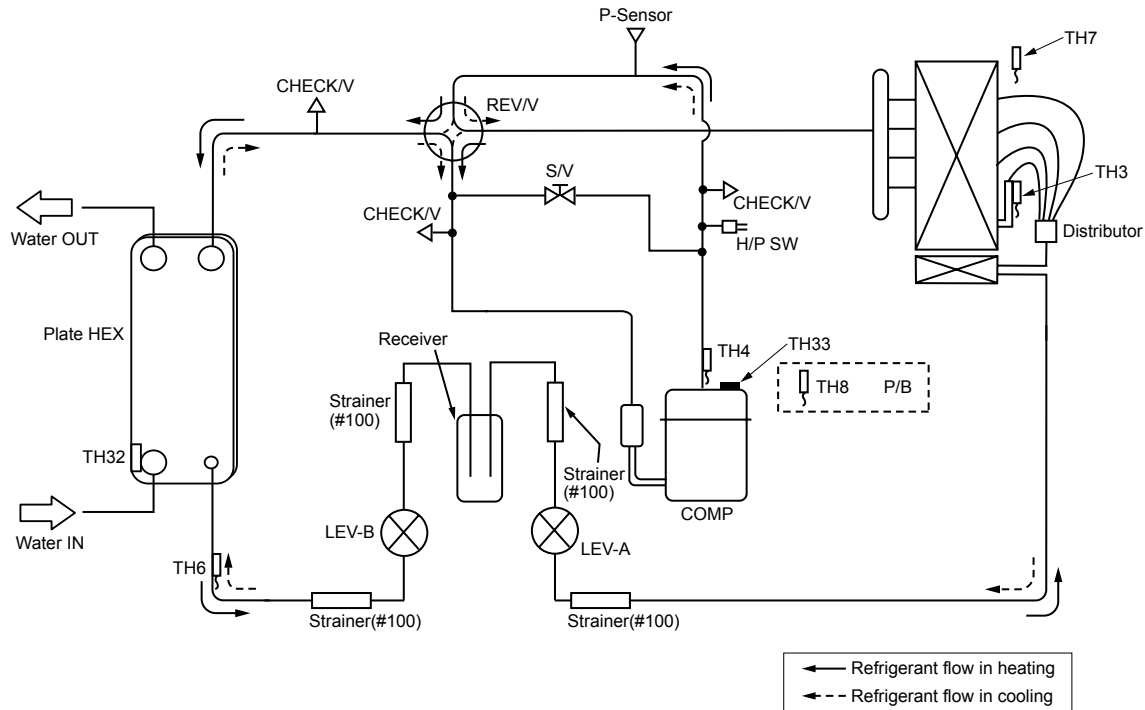

Symbol	Part name	Detail
COMP	Compressor	DC inverter twin rotary compressor (Mitsubishi Electric Corporation)
H/P SW	High pressure switch (63H)	For protection (OFF:4.15MPa)
Plate HEX	Plate Heat Exchanger	ACH30 - 50 Plates (Alfa Laval)
REV/V	Reversing (4-way) valve (21S4)	Change the refrigerant circuit (Heating / Cooling) and for Defrosting
S/V	Solenoid valve	For production test use
CHECK/V	Check valve	High pressure / Low pressure / For production test use
P-Sensor	Pressure sensor (63HS)	For calculation of the condensing temperature from high pressure
P/B	Power board	Inverter power board
LEV-A	Linear expansion valve -A	Heating:Secondary LEV Cooling:Primary LEV
LEV-B	Linear expansion valve -B	Heating:Primary LEV Cooling:Secondary LEV
TH32	Inlet water temperature thermistor	For freeze protection and for compressor frequency control
TH3	Liquid temperature thermistor	Heating:Evaporating temperature Cooling:Sub cool liquid temperature
TH4	Discharge temperature thermistor	For LEV control and for compressor protection
TH6	Plate HEX liquid temperature thermistor	Heating:Sub cool liquid temperature Cooling:Evaporating temperature
TH7	Ambient temperature thermistor	For fan control and for compressor frequency control
TH8	Heatsink temperature thermistor	For power board protection
TH33	Comp.shell temperature thermistor	For compressor protection
Receiver	Receiver	For accumulation of refrigerant

8-1. TROUBLESHOOTING

<Error code display by self-diagnosis and actions to be taken for service (summary)>

Present and past error codes are logged and displayed on the control board of outdoor unit. Actions to be taken for service, which depends on whether or not the trouble is reoccurring at service, are summarized in the table below. Check the contents below before investigating details.

Unit conditions at service	Error code	Actions to be taken for service (summary)
The trouble is reoccurring.	Displayed	Judge what is wrong and take a corrective action according to "8-3. Self-diagnosis action table".
	Not displayed	Conduct troubleshooting and ascertain the cause of the trouble.
The trouble is not reoccurring.	Logged	① Consider the temporary defects such as the work of protection devices in the refrigerant circuit including compressor, poor connection of wiring, noise and etc. Re-check the symptom, and check the installation environment, refrigerant amount, weather when the trouble occurred, matters related to wiring and etc. ② Reset error code logs and restart the unit after finishing service. ③ There is no abnormality in electrical component, controller board, and etc.
	Not logged	① Re-check the abnormal symptom. ② Conduct troubleshooting and ascertain the cause of the trouble. ③ Continue to operate unit for the time being if the cause is not ascertained. ④ There is no abnormality concerning of parts such as electrical component, controller board, and etc.

8-2. CHECK POINT UNDER TEST RUN

Before test run

- After installation of outdoor units, piping work and electric wiring work, re-check that there is no water leakage, loosened connections and incorrect polarity.
- Measure impedance between the ground and the power supply terminal block (L, N) on the outdoor unit by 500 V Megger and check that it is 1.0 MΩ or over.
- Turn on power supply 12 hours before test run in order to protect compressor.
- Make sure to read operation manual before test run. (Especially items to secure safety.)

8-3. SELF-DIAGNOSIS ACTION TABLE

<Abnormalities detected when the power is turned on>

Error Code	Abnormal point and detection method	Case	Judgment and action
None	—	<p>① No voltage is supplied to terminal block (TB1) of outdoor unit. a) Power supply breaker is turned off. b) Contact failure or disconnection of power supply terminal c) Open phase (L or N phase)</p> <p>② Electric power is not charged to power supply terminal of outdoor power circuit board. a) Contact failure of power supply terminal b) Open phase on the outdoor power circuit board Disconnection of connector TABT or TABS</p> <p>③ Electric power is not supplied to outdoor controller circuit board. a) Disconnection of connector (CNDC)</p> <p>④ Disconnection of reactor (DCL)</p> <p>⑤ Disconnection of outdoor noise filter circuit board or parts failure in outdoor noise filter circuit board</p> <p>⑥ Defective outdoor power circuit board</p> <p>⑦ Defective outdoor controller circuit board</p>	<p>① Check following items. a) Power supply breaker b) Connection of power supply terminal block. (TB1) c) Connection of power supply terminal block. (TB1)</p> <p>② Check following items. a) Connection of power supply terminal block. (TB1) b) Connection of terminal on outdoor power circuit board. Check connection of the connector TABT or TABS. Refer to 8-6.</p> <p>③ Check connection of the connector (CNDC) on the outdoor controller circuit board. Check connection of the connector CNDC on the outdoor power circuit board. Refer to 8-6.</p> <p>④ Check connection of reactor. (DCL) Check connection of "L1" and "L2" on the active filter module. (ACTM) Refer to 8-6.</p> <p>⑤ a) Check connection of outdoor noise filter circuit board. Refer to 8-6. b) Replace outdoor noise filter circuit board. Refer to 8-6.</p> <p>⑥ Replace outdoor power circuit board.</p> <p>⑦ Replace controller board (When items above are checked but the units can not be repaired.)</p>
F5	<p>63H connector open Abnormal if 63H connector circuit is open for 3 minutes continuously from being switched on. 63H: High-pressure switch</p>	<p>① Disconnection or contact failure of 63H connector on outdoor controller circuit board</p> <p>② Disconnection or contact failure of 63H</p> <p>③ 63H is working due to defective parts.</p> <p>④ Defective outdoor controller circuit board</p>	<p>① Check connection of 63H connector on outdoor controller circuit board. Refer to 8-6.</p> <p>② Check the 63H side of connecting wire.</p> <p>③ Check for continuity of 63H. Replace high pressure switch if it is defective.</p> <p>④ Replace outdoor controller circuit board.</p>



Error Code	Abnormal point and detection method	Case	Judgment and action
EA	<p>Miswiring of Interface unit/Flow temp. controller-outdoor unit connecting wire</p> <p>1. Outdoor controller circuit board can automatically check the number of connected Interface unit/Flow temp. controller. Abnormal if the number cannot be checked automatically due to miswiring of Interface unit/Flow temp. controller-outdoor unit connecting wire and etc. after power is turned on for 4 minutes.</p> <p>2. Abnormal if outdoor controller circuit board recognizes excessive number of Interface unit/Flow temp. controller.</p>	<p>① Contact failure or miswiring of Interface unit/Flow temp. controller-outdoor unit connecting wire</p> <p>② Diameter or length of Interface unit/Flow temp. controller-outdoor unit connecting wire is out of specified capacity.</p> <p>③ Excessive number of Interface unit/Flow temp. controller is connected to 1 outdoor unit. (2 units or more)</p> <p>④ Defective transmitting receiving circuit of outdoor controller circuit board</p> <p>⑤ Defective transmitting receiving circuit of Interface/Flow temp. controller board</p> <p>⑥ Noise has entered into power supply or Interface/Flow temp. controller-outdoor unit connecting wire.</p>	<p>① Check disconnection or looseness or polarity of Interface unit/Flow temp. controller-outdoor unit connecting wire of Interface unit/Flow temp. controller and outdoor units.</p> <p>② Check diameter and length of Interface unit/Flow temp. controller-outdoor unit connecting wire. Total wiring length: 80 m (Including wiring connecting each Interface unit/Flow temp. controller unit and between Interface unit/Flow temp. controller and outdoor unit) Also check if the connection order of flat cable is S1, S2, S3.</p> <p>③ Check the number of Interface unit/Flow temp. controller that is connected to 1 outdoor unit. (If EA is detected.)</p> <p>④~⑤ Turn the power off once, and on again to check. Replace outdoor controller circuit board or Interface/Flow temp. controller board if abnormality occurs again.</p>
Eb	<p>Miswiring of Interface unit/Flow temp. controller-outdoor unit connecting wire (converse wiring or disconnection)</p> <p>Outdoor controller circuit board can automatically set the unit number of Interface unit/Flow temp. controller.</p> <p>Abnormal if the Interface unit/Flow temp. controller number cannot be set within 4 minutes after power on because of miswiring (converse wiring or disconnection) of Interface unit/Flow temp. controller-outdoor unit connecting wire.</p>	<p>① Contact failure or miswiring of Interface unit/Flow temp. controller-outdoor unit connecting wire</p> <p>② Diameter or length of Interface unit/Flow temp. controller-outdoor unit connecting wire is out of specified capacity.</p> <p>④ Defective transmitting receiving circuit of outdoor controller circuit board</p> <p>⑤ Defective transmitting receiving circuit of Interface/Flow temp. controller board</p> <p>⑥ Noise has entered into power supply or Interface unit/Flow temp. controller-outdoor unit connecting wire.</p>	<p>⑥ Check transmission path, and remove the cause.</p> <p>* The descriptions above, ①-⑥, are for EA, Eb and EC.</p>
EC	<p>Start-up time over</p> <p>The unit cannot finish start-up process within 4 minutes after power on.</p>	<p>① Contact failure of Interface unit /Flow temp. controller-outdoor unit connecting wire</p> <p>② Diameter or length of Interface unit/Flow temp. controller-outdoor unit connecting wire is out of specified capacity.</p> <p>⑥ Noise has entered into power supply or Interface unit/Flow temp. controller-outdoor unit connecting wire.</p>	

<Abnormalities detected while unit is operating>

Error Code	Abnormal point and detection method	Case	Judgment and action
U1	<p>High pressure (High-pressure switch 63H activated) Abnormal if high-pressure switch 63H is activated (*) during compressor operation. * 4.15 MPa</p> <p>63H: High-pressure switch</p>	<p>① Decreased water flow ② Clogged filter of water pipe ③ Dirt of plate heat exchanger ④ Locked water pump ⑤ Malfunction of water pump ⑥ Clogged or broken pipe ⑦ Locked outdoor fan motor ⑧ Malfunction of outdoor fan motor ⑨ Short cycle of outdoor unit ⑩ Dirt of outdoor heat exchanger ⑪ Decreased airflow caused by defective inspection of outside temperature thermistor (It detects lower temperature than actual temperature.) ⑫ Disconnection or contact failure of connector (63H) on outdoor controller board ⑬ Disconnection or contact failure of 63H connection ⑭ Defective outdoor controller board ⑮ Defective operation of linear expansion valve ⑯ Malfunction of fan driving circuit</p>	<p>①~⑤ Check water circuit and repair the defect.</p> <p>⑥ Check piping and repair the defect. ⑦~⑩ Check outdoor unit and repair the defect.</p> <p>⑪ Check the detected temperature of outside temperature thermistor on LED display. (SW2: Refer to 8-7.)</p> <p>⑫~⑭ Turn the power off and check F5 is displayed when the power is turned on again. When F5 is displayed, refer to "Judgment and action" for F5.</p> <p>⑮ Check linear expansion valve. Refer to 8-5. ⑯ Replace outdoor controller board.</p>
U2	<p>High discharging temperature Abnormal if discharge temperature thermistor (TH4) exceeds 125°C or 110°C continuously for 5 minutes. Abnormal if during defrosting discharge temperature thermistor (TH4) exceeds 110°C continuously for 30 minutes.</p> <p>High comp. surface temperature Abnormal if comp. surface temperature (TH33) exceeds 125°C. In the case of high comp. surface temperature error, compressor does not restart unless the thermistor (TH33) becomes less than 95°C.</p>	<p>① Overheated compressor operation caused by insufficient refrigerant ② Defective thermistor ③ Defective outdoor controller board ④ Defective operation of linear expansion valve ⑤ In the case of the unit does not restart : Detection temp. of thermistor (TH33) \geq 95°C</p>	<p>① Check intake super heat. Check leakage of refrigerant. Charge additional refrigerant. ②③ Turn the power off and check if U3 is displayed when the power is turned ON again. When U3 is displayed, refer to "Judgement and action" for U3. ④ Check linear expansion valve. Refer to 8-5.</p>
U3	<p>Open/short circuit of discharge temperature thermistor (TH4)/comp. surface thermistor (TH33) Abnormal if open (3°C or less) or short (217°C or more) is detected during compressor operation. (Open (3°C or less) detection is inoperative for 10 minutes of compressor starting process and for 10 minutes after or during defrosting.)</p>	<p>① Disconnection or contact failure of connector (TH4/TH33) on the outdoor controller circuit board. ② Defective thermistor ③ Defective outdoor controller circuit board</p>	<p>① Check connection of connector (TH4/TH33) on the outdoor controller circuit board. Check the lead wire for thermistor (TH4/TH33). Refer to 8-6. ② Check resistance value of thermistor (TH4/TH33) or temperature on LED display. (Thermistor/TH4/TH33: Refer to 8-5.) (SW2: Refer to 8-7.) ③ Replace outdoor controller board.</p>



Error Code	Abnormal point and detection method	Case	Judgment and action																										
U4	<p>Open/short of outdoor unit thermistors (TH3, TH32, TH6, TH7, and TH8) Abnormal if open or short is detected during compressor operation. Open detection of thermistors TH3, TH32 and TH6 is not detected for 10 seconds to 10 minutes after compressor starting and 10 minutes after and during defrosting. * Check which unit has abnormality in its thermistor by switching the mode of SW2. (Refer to 8-7.)</p>	<p>① Disconnection or contact failure of connectors (Outdoor controller circuit board: TH3, TH32, TH6/TH7 Outdoor power circuit board: CN3) ② Defective thermistor ③ Defective outdoor controller circuit board</p>	<p>① Check connection of connector (TH3, TH32, TH6/TH7) on the outdoor controller circuit board. Check connection of connector (CN3) on the outdoor power circuit board. Check the lead wire for thermistor (TH3, TH32, TH6, TH7, TH8). Refer to 8-6. ② Check resistance value of thermistor (TH3, TH32, TH6, TH7, TH8) or check temperature on LED display. (Thermistor/TH3, TH32, TH6, TH7, TH8: Refer to 8-5.) (SW2: Refer to 8-7.) ③ Replace outdoor controller circuit board.</p>																										
	<table border="1"> <thead> <tr> <th colspan="2">Thermistors</th> <th rowspan="2">Open detection</th> <th rowspan="2">Short detection</th> </tr> <tr> <th>Symbol</th> <th>Name</th> </tr> </thead> <tbody> <tr> <td>TH3</td> <td>Thermistor <Liquid temperature></td> <td>- 40°C or below</td> <td>90°C or above</td> </tr> <tr> <td>TH32</td> <td>Thermistor <Inlet water temperature></td> <td>- 40°C or below</td> <td>102°C or above</td> </tr> <tr> <td>TH6</td> <td>Thermistor <Plate HEX liquid temperature></td> <td>- 40°C or below</td> <td>90°C or above</td> </tr> <tr> <td>TH7</td> <td>Thermistor <Ambient temperature></td> <td>- 40°C or below</td> <td>90°C or above</td> </tr> <tr> <td>TH8</td> <td>Thermistor <Heatsink temperature></td> <td>- 35°C or below</td> <td>102°C or above</td> </tr> </tbody> </table>				Thermistors		Open detection	Short detection	Symbol	Name	TH3	Thermistor <Liquid temperature>	- 40°C or below	90°C or above	TH32	Thermistor <Inlet water temperature>	- 40°C or below	102°C or above	TH6	Thermistor <Plate HEX liquid temperature>	- 40°C or below	90°C or above	TH7	Thermistor <Ambient temperature>	- 40°C or below	90°C or above	TH8	Thermistor <Heatsink temperature>	- 35°C or below
Thermistors		Open detection	Short detection																										
Symbol	Name																												
TH3	Thermistor <Liquid temperature>	- 40°C or below	90°C or above																										
TH32	Thermistor <Inlet water temperature>	- 40°C or below	102°C or above																										
TH6	Thermistor <Plate HEX liquid temperature>	- 40°C or below	90°C or above																										
TH7	Thermistor <Ambient temperature>	- 40°C or below	90°C or above																										
TH8	Thermistor <Heatsink temperature>	- 35°C or below	102°C or above																										
U5	<p>Temperature of heatsink Abnormal if heatsink thermistor (TH8) detects temperature indicated below. W85V..... 77°C</p>	<p>① The outdoor fan motor is locked. ② Failure of outdoor fan motor ③ Air flow path is clogged. ④ Ambient temperature is high. ⑤ Defective thermistor ⑥ Defective input circuit of outdoor power circuit board ⑦ Failure of outdoor fan drive circuit</p>	<p>①② Check outdoor fan. ③ Check air flow path for cooling. ④ Check if there is something which causes temperature rise around outdoor unit. (Upper limit of ambient temperature is 46°C.) Turn off power, and on again to check if U5 is displayed within 30 minutes. If U4 is displayed instead of U5, refer to error code U4. ⑤ Check resistance value of thermistor (TH8) or temperature by microcomputer. (Thermistor/TH8: Refer to 8-5.) (SW2: Refer to 8-7.) ⑥ Replace outdoor power circuit board. ⑦ Replace outdoor controller circuit board.</p>																										
U6	<p>Power module Check abnormality by driving power module in case overcurrent is detected. (UF or UP error condition)</p>	<p>① Defective outdoor power circuit board ② Decrease of power supply voltage ③ Loosens, disconnection or reverse of compressor wiring connection ④ Defective compressor</p>	<p>① Replace outdoor power circuit board. ② Check facility of power supply. ③ Correct the wiring (U·V·W phase) to compressor. Refer to 8-6 (Outdoor power circuit board). ④ Check compressor referring to 8-4.</p>																										
U7	<p>Too low superheat due to low discharge temperature Abnormal if discharge superheat is continuously detected -15°C or less for 3 minutes even though linear expansion valve has minimum open pulse after compressor starts operating for 10 minutes.</p>	<p>① Disconnection or loose connection of discharge temperature thermistor (TH4) ② Defective holder of discharge temperature thermistor ③ Disconnection or loose connection of linear expansion valve's coil ④ Disconnection or loose connection of linear expansion valve's connector ⑤ Defective linear expansion valve</p>	<p>①② Check the installation conditions of discharge temperature thermistor (TH4). ③ Check the coil of linear expansion valve. Refer to 8-5. ④ Check the connection or contact of LEV-A and LEV-B on outdoor controller circuit board. ⑤ Check linear expansion valve. Refer to 8-4.</p>																										



Error Code	Abnormal point and detection method	Case	Judgment and action
U8	<p>Outdoor fan motor Abnormal if rotational frequency of the fan motor is not detected during DC fan motor operation. Fan motor rotational frequency is abnormal if;</p> <ul style="list-style-type: none"> • 100 rpm or below detected continuously for 15 seconds at 20°C or more outside air temperature • 50 rpm or below or 1500 rpm or more detected continuously for 1 minute. 	<ul style="list-style-type: none"> ① Failure in the operation of the DC fan motor ② Failure in the outdoor circuit controller board 	<ul style="list-style-type: none"> ① Check or replace the DC fan motor. ② Check the voltage of the outdoor circuit controller board during operation. ③ Replace the outdoor circuit controller board. (when the failure is still indicated even after performing the remedy ① above.)
U9	<p>Overvoltage or voltage shortage and synchronous signal to main circuit Abnormal if any of followings are detected during compressor operation;</p> <ul style="list-style-type: none"> • Decrease of DC bus voltage to 310V • Instantaneous decrease of DC bus voltage to 200V • Increase of DC bus voltage to 400V • Decrease of input current of outdoor unit to 0.1A only if operation frequency is more than or equal to 40Hz or compressor current is more than or equal to 6A. <p>* Check U9 error detail (SW2 all ON) Refer to 8-7.</p>	<ul style="list-style-type: none"> ① Decrease of power supply voltage ② Disconnection of compressor wiring ③ Defective power circuit board ④ Disconnection or loose connection of CN52C ⑤ Defective ACT module ⑥ Defective ACT module drive circuit of outdoor power circuit board ⑦ Disconnection or loose connection of CNAF ⑧ Defective 52C drive circuit of outdoor controller circuit board ⑨ Disconnection or loose connection of CN5 on the outdoor power circuit board ⑩ Disconnection or loose connection of CN2 on the outdoor power circuit board 	<ul style="list-style-type: none"> ① Check the facility of power supply. ② Correct the wiring (U-V-W phase) to compressor. Refer to 8-6 (Outdoor power circuit board). ③ Replace power circuit board. ④ Check CN52C wiring. ⑤ Replace ACT module. ⑥ Replace outdoor power circuit board. ⑦ Check CNAF wiring. ⑧ Replace outdoor controller circuit board. ⑨ Check CN5 wiring on the outdoor power circuit board. Refer to 8-6. ⑩ Check CN2 wiring on the outdoor power circuit board. Refer to 8-6.
Ud	<p>Overheat protection Abnormal if outdoor pipe thermistor (TH3) detects 70°C or more or condensing temperature of pressure sensor (63HS) detects 70°C or more during compressor operation.</p>	<ul style="list-style-type: none"> ① Defective outdoor fan (fan motor) or short cycle of outdoor unit during cooling operation ② Defective outdoor pipe thermistor (TH3) ③ Defective outdoor controller board ④ Defective pressure sensor 	<ul style="list-style-type: none"> ① Check outdoor unit air passage. ②③ Turn the power off and on again to check the error code. If U4 is displayed, follow the U4 processing direction. ④ Check pressure by microcomputer. (Pressure sensor/ 63HS) (SW2: Refer to 8-7.)
UF	<p>Compressor overcurrent interruption (When compressor locked) Abnormal if overcurrent of DC bus or compressor is detected within 30 seconds after compressor starts operating.</p>	<ul style="list-style-type: none"> ① Decrease of power supply voltage ② Looseness, disconnection or converse of compressor wiring connection ③ Defective compressor ④ Defective outdoor power board ⑤ Decreased water flow ⑥ Clogged filter of water pipe ⑦ Clogged plate heat exchanger ⑧ Locked water pump ⑨ Malfunction of water pump 	<ul style="list-style-type: none"> ① Check facility of power supply. ② Correct the wiring (U-V-W phase) to compressor. Refer to 8-6 (Outdoor power circuit board). ③ Check compressor. Refer to 8-4. ④ Replace outdoor power circuit board. ⑤~⑨ Check water circuit and repair the defect.



Error Code	Abnormal point and detection method	Case	Judgment and action
UH	Current sensor error or input current error -Abnormal if current sensor detects -1.0 A to 1.0 A during compressor operation. (This error is ignored during test run.)	① Disconnection of compressor wiring ② Defective circuit of current sensor on outdoor power circuit board ③ Decrease of power supply voltage	① Correct the wiring (U·V·W phase) to compressor. Refer to 8-6 (Outdoor power circuit board). ② Replace outdoor power circuit board. ③ Check the facility of power supply.
UP	Compressor overcurrent interruption Abnormal if overcurrent DC bus or compressor is detected after compressor starts operating for 30 seconds.	① Decrease of power supply voltage ② Looseness, disconnection or converse of compressor wiring connection ③ Defective fan of outdoor units ④ Short cycle of indoor/outdoor units ⑤ Defective input circuit of outdoor controller board ⑥ Defective compressor ⑦ Decreased water flow ⑧ Clogged filter of water pipe ⑨ Clogged plate heat exchanger ⑩ Locked water pump ⑪ Malfunction of water pump	① Check facility of power supply. ② Correct the wiring (U·V·W phase) to compressor. Refer to 8-6 (Outdoor power circuit board). ③ Check outdoor fan. ④ Solve short cycle. ⑤ Replace outdoor controller circuit board. ⑥ Check compressor. Refer to 8-4. * Before the replacement of the outdoor controller circuit board, disconnect the wiring to compressor from the outdoor power circuit board and check the output voltage among phases, U, V, W, during test run. No defect on board if voltage among phases (U-V, V-W and W-U) is same. Make sure to perform the voltage check with same performing frequency. ⑦-⑩ Check water circuit and repair the defect.
E0 or E4	Remote controller transmission error (E0)/signal receiving error (E4) ① Abnormal if main or sub remote controller cannot receive any transmission normally from Interface unit/Flow temp. controller of refrigerant address "0" for 3 minutes. (Error code: E0) ② Abnormal if sub-remote controller could not receive any signal for 2 minutes. (Error code: E0) ① Abnormal if Interface/Flow temp. controller board can not receive any data normally from remote controller board or from other Interface/Flow temp. controller board for 3 minutes. (Error code: E4) ② Interface/Flow temp. controller board cannot receive any signal from remote controller for 2 minutes. (Error code: E4)	① Contact failure at transmission wire of remote controller ② All remote controllers are set as "sub" remote controller. In this case, E0 is displayed on remote controller, and E4 is displayed at LED (LED1, LED2) on the outdoor controller circuit board. ③ Miswiring of remote controller ④ Defective transmitting receiving circuit of remote controller ⑤ Noise has entered into the transmission wire of remote controller.	① Check disconnection or looseness of Interface unit/Flow temp. controller unit or transmission wire of remote controller. ② Set one of the remote controllers "main", If there is no problem with the action above. ③ Check wiring of remote controller. <ul style="list-style-type: none"> • Total wiring length: max. 500 m (Do not use cablex 3 or more.) • The number of connecting remote controller: max. 2 units When it is not the above-mentioned problem of ①-③ ④ Diagnose remote controllers. <ul style="list-style-type: none"> a) When "RC OK" is displayed, remote controllers have no problem. Turn the power off, and on again to check. If abnormality generates again, replace Interface/Flow temp. controller board. b) When "RC NG" is displayed, replace remote controller. c) When "RC E3" or "ERC 00-66" is displayed, noise may be causing abnormality.
E1 or E2	Remote controller control board ① Abnormal if data cannot be read normally from the nonvolatile memory of the remote controller control board. (Error code: E1) ② Abnormal if the clock function of remote controller cannot be operated normally. (Error code: E2)	① Defective remote controller	① Replace remote controller.



Error Code	Abnormal point and detection method	Case	Judgment and action
E3 or E5	<p>Remote controller transmission error (E3)/signal receiving error (E5)</p> <p>① Abnormal if remote controller could not find blank of transmission path for 6 seconds and could not transmit. (Error code: E3)</p> <p>② When remote controller receives the transmitted data same time and compares these data. Abnormal if the data is judged to be different for 30 continuous times. (Error code: E3)</p> <p>① Abnormal if Interface/Flow temp. controller board could not find blank of transmission path. (Error code: E5)</p> <p>② When Interface/Flow temp. controller receives the transmitted data same time and compares these data. Abnormal if the data is judged to be different for 30 continuous times. (Error code: E5)</p>	<p>① 2 remote controllers are set as "main." (In case of 2 remote controllers)</p> <p>② Defective transmitting receiving circuit of remote controller</p> <p>③ Defective transmitting receiving circuit of Interface/Flow temp. controller board</p> <p>④ Noise has entered into transmission wire of remote controller.</p>	<p>① Set a remote controller to main, and the other to sub.</p> <p>②~④ Diagnose remote controller.</p> <p>a) When "RC OK" is displayed, remote controllers have no problem. Turn the power off, and on again to check. When becoming abnormal again, replace indoor controller board.</p> <p>b) When "RC NG" is displayed, replace remote controller.</p> <p>c) When "RC E3" or "ERC 00-66" is displayed, noise may be causing abnormality.</p>
E6	<p>Interface unit/Flow temp. controller-outdoor unit communication error (Signal receiving error)</p> <p>① Abnormal if Interface/Flow temp. controller board cannot receive any signal normally for 6 minutes after turning the power on.</p> <p>② Abnormal if Interface/Flow temp. controller board cannot receive any signal normally for 3 minutes.</p>	<p>① Contact failure, short circuit or miswiring (converse wiring) of Interface unit/Flow temp. controller-outdoor unit connecting wire</p> <p>② Defective transmitting receiving circuit of Interface/Flow temp. controller board</p> <p>③ Defective transmitting receiving circuit of Interface/Flow temp. controller board</p> <p>④ Noise has entered into Interface unit/Flow temp. controller-outdoor unit connecting wire.</p>	<p>* Check LED display on the outdoor control circuit board. (Connect A-control service tool, PAC-SK52ST.)</p> <p>① Check disconnection or looseness of Interface unit/Flow temp. controller-outdoor unit connecting wire of Interface unit/Flow temp. controller or outdoor unit.</p> <p>②~④ Turn the power off, and on again to check. If abnormality generates again, replace Interface/Flow temp. controller board or outdoor controller circuit board.</p>
E8	<p>Interface unit/Flow temp. controller-outdoor unit communication error (Signal receiving error) (Outdoor unit)</p> <p>(1) Abnormal if outdoor controller circuit board could not receive anything normally for 3 minutes.</p>	<p>① Contact failure of Interface unit/Flow temp. controller-outdoor unit connecting wire</p> <p>② Defective communication circuit of outdoor controller circuit board</p> <p>③ Defective communication circuit of Interface/Flow temp. controller board</p> <p>④ Noise has entered into Interface unit/Flow temp. controller-outdoor unit connecting wire.</p>	<p>① Check disconnection or looseness of Interface unit/Flow temp. controller-outdoor unit connecting wire of Interface unit/Flow temp. controller or outdoor unit.</p> <p>②~④ Turn the power off, and on again to check. Replace Interface/Flow temp. controller board or outdoor controller circuit board if abnormality is displayed again.</p>
E9	<p>Interface unit/Flow temp. controller-outdoor unit communication error (Transmitting error) (Outdoor unit)</p> <p>(1) Abnormal if "0" receiving is detected 30 times continuously though outdoor controller circuit board has transmitted "1".</p> <p>(2) Abnormal if outdoor controller circuit board could not find blank of transmission path for 3 minutes.</p>	<p>① Interface unit/Flow temp. controller-outdoor unit connecting wire has contact failure.</p> <p>② Defective communication circuit of outdoor controller circuit board</p> <p>③ Noise has entered power supply.</p> <p>④ Noise has entered Interface unit/Flow temp. controller-outdoor unit connecting wire.</p>	<p>① Check disconnection or looseness of Interface unit/Flow temp. controller-outdoor unit connecting wire.</p> <p>②~④ Turn the power off, and on again to check. Replace outdoor controller circuit board if abnormality is displayed again.</p>
EF	<p>Non defined error code</p> <p>This code is displayed when non defined error code is received.</p>	<p>① Noise has entered transmission wire of remote controller.</p> <p>② Noise has entered Interface unit/Flow temp. controller-outdoor unit connecting wire.</p>	<p>①② Turn the power off, and on again to check. Replace Interface/Flow temp. controller board or outdoor controller circuit board if abnormality is displayed again.</p>
Ed	<p>Serial communication error</p> <p>Abnormal if serial communication between outdoor controller circuit board and outdoor power circuit board is defective.</p>	<p>① Wire disconnection or contact failure of connector CN2 between the outdoor controller circuit board and the outdoor power circuit board</p> <p>② Wire disconnection or contact failure of connector CN4 between the outdoor controller circuit board and the outdoor power circuit board</p> <p>③ Defective communication circuit of outdoor power circuit board</p> <p>④ Defective communication circuit of outdoor controller circuit board for outdoor power circuit board</p>	<p>①② Check connection of each connector CN2 and CN4 between the outdoor controller circuit board and the outdoor power circuit board.</p> <p>③ Replace outdoor power circuit board.</p> <p>④ Replace outdoor controller circuit board.</p>



Error Code	Abnormal point and detection method	Case	Judgment and action																
P6	<p>Freezing/overheating protection is working</p> <p>(1) Freezing protection <Cooling mode> Abnormal if plate heat exchanger pipe temperature thermistor (TH6) stays at -5°C or lower for 10 seconds or abnormal if plate heat exchanger pipe thermistor (TH6) stays at -2°C or lower and compressor operation frequency is minimum for 5 minutes after compressor starts operating for 6 minutes.</p> <p><Heating mode> Abnormal if inlet water temperature thermistor (TH32) is 15°C or lower, and the following condition (1 or 2) are detected.</p> <p>1. 1 minute has passed since defrosting operation started and plate heat exchanger pipe temperature thermistor (TH6) stays at -6°C or lower for continuously 30 seconds.</p> <p>2. During defrosting operation and plate heat exchanger pipe temperature thermistor (TH6) stays at -16°C or lower for continuously 10 seconds.</p> <p>(2) Overheating protection <Heating mode> Abnormal if condensing temperature of pressure sensor (63HS) detects Tcond. °C or more and compressor operation frequency is less than or equal to 30 Hz. Detection is inoperative during defrosting.</p>	<p>(1) Freezing protection <Cooling mode></p> <p>① Reduced water flow · Clogged filter · Leakage of water</p> <p>② Low temperature · Low-load · Inlet water is too cold.</p> <p>③ Defective water pump</p> <p>④ Defective outdoor fan control</p> <p>⑤ Overcharge of refrigerant</p> <p>⑥ Defective refrigerant circuit (clogs)</p> <p>⑦ Malfunction of linear expansion valve</p> <p><Heating mode></p> <p>① Reduced water flow · Clogged filter · Leakage of water</p> <p>② Low temperature · Low-load · Inlet water is cold.</p> <p>③ Defective water pump</p> <p>④ Leakage or shortage of refrigerant</p> <p>⑤ Malfunction of liner expansion valve</p> <p>(2) Over heating protection <Heating mode></p> <p>① Reduced water flow · Clogged filter · Leakage of water</p> <p>② High temperature · Over-load · Inlet water is too warm.</p> <p>③ Defective water pump</p> <p>④ Overcharge of refrigerant</p> <p>⑤ Defective refrigerant circuit (clogs)</p> <p>⑥ Malfunction of liner expansion valve</p>	<p>(1) Freezing protection <Cooling mode></p> <p>①② Check water piping.</p> <p>③ Check water pump.</p> <p>④ Check outdoor fan motor.</p> <p>⑤~⑦ Check operating condition of refrigerant circuit.</p> <p>⑦ Check linear expansion valve.</p> <p><Heating mode></p> <p>①② Check water piping.</p> <p>③ Check water pump.</p> <p>④ Correct to proper amount of refrigerant.</p> <p>⑤ Check linear expansion valve. Refer to 8-5.</p> <p>(2) Over heating protection <Heating mode></p> <p>①② Check water piping.</p> <p>③ Check water pump.</p> <p>④⑤ Check operating condition of refrigerant circuit.</p> <p>⑥ Check linear expansion valve.</p>																
		<p>Tcond</p> <table border="1"> <thead> <tr> <th></th> <th>stage-a</th> <th>stage-b</th> <th>stage-c</th> <th>stage-d</th> <th>stage-e</th> <th>stage-f</th> <th>stage-g</th> </tr> </thead> <tbody> <tr> <td>Tcond</td> <td>63</td> <td>61</td> <td>59</td> <td>57</td> <td>54</td> <td>51</td> <td>48</td> </tr> </tbody> </table>		stage-a	stage-b	stage-c	stage-d	stage-e	stage-f	stage-g	Tcond	63	61	59	57	54	51	48	
	stage-a	stage-b	stage-c	stage-d	stage-e	stage-f	stage-g												
Tcond	63	61	59	57	54	51	48												
P8	<p>Pipe temperature</p> <p>Abnormal if the following conditions are detected for continuously 3 minutes after compressor starts operating for 10 minutes.</p> <p>1. Cooling mode T_{63HS}-TH7 ≤ 2°C and TH3-TH7 ≤ 4°C or T_{63HS}-TH3 < 0°C and TH32-TH6 ≤ 0°C and Compressor operation frequency is 61Hz or more.</p> <p>2. Heating mode T_{63HS}-TH32 ≤ 2°C and TH6-TH32 ≤ 1°C and TH7-TH3 ≤ 1°C and Compressor operation frequency is 61Hz or more.</p> <p>T_{63HS}: Condensing temperature of pressure sensor (63HS) Thermistor TH3: Liquid temperature TH32: Inlet water temperature TH6: Plate HEX Liquid temperature TH7: Ambient temperature</p>	<p>① Leakage or shortage of refrigerant</p> <p>② Malfunction of linear expansion valve</p> <p>③ Refrigerant circuit is clogged with foreign objects.</p> <p>* Clogging occurs in the parts which become below freezing point when water enters in refrigerant circuit.</p> <p>④ Disconnection of thermistor holder.</p>	<p>① Check intake superheat. Check leakage of refrigerant.</p> <p>② Check linear expansion valve.</p> <p>③ After recovering refrigerant, remove water from entire refrigerant circuit under vacuum more than 1 hour.</p> <p>④ Check temperature display on outdoor controller circuit board. Temperature display is indicated by setting SW2 of outdoor controller circuit board. Check the holder of thermistor.</p>																



Error Code	Abnormal point and detection method	Case	Judgment and action
UE	Abnormal pressure of pressure sensor (63HS) Abnormal if pressure sensor (63HS) detects 0.1 MPa or less. Detection is inoperative for 3 minutes after compressor starting and 3 minutes after and during defrosting.	① Disconnection or contact failure of connector (63HS) on the outdoor controller circuit board ② Defective pressure sensor ③ Defective outdoor controller circuit board	① Check connection of connector (63HS) on the outdoor controller circuit board. Check breaking of the lead wire for thermistor (63HS) ② Check pressure by microcomputer. (Pressure sensor/ 63HS) (SW2: Refer to 8-7.) ③ Replace outdoor controller board.
PE	Inlet water temperature Abnormal if the following conditions are detected for continuously 10 seconds. 1. Cooling mode During compressor operation TH32 < 3°C 2. Heating mode (exclude defrosting) During compressor operation TH32 < -10°C 3. Defrosting mode During compressor operation TH32 < 0°C Thermistor TH32: Inlet water temperature	① Reduced water flow · Clogged filter · Leak of water ② Low temperature · Low-load · Low temperature inlet water ③ Defective water pump ④ Leakage or shortage of refrigerant	①② Check water piping. ③ Check water pump. ④ Check intake superheat. Check leakage of refrigerant.

8-4. HOW TO CHECK THE PARTS

PUHZ-W85VHA2.UK

PUHZ-W85VHA2-BS.UK

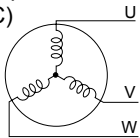
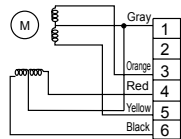
Parts name	Check points														
TH3: Liquid pipe temperature TH4: Discharge temperature TH6: Plate Hex liquid pipe temperature TH7: Ambient temperature TH8: Heatsink temperature TH32: Inlet water temperature TH33: Comp. surface thermistor	Disconnect the connector then measure the resistance with a tester. (At the ambient temperature of 10°C~30°C) <table border="1" style="margin-left: 20px;"> <thead> <tr> <th></th> <th>Normal</th> <th>Abnormal</th> </tr> </thead> <tbody> <tr> <td>TH4/TH33</td> <td>160kΩ~410kΩ</td> <td rowspan="4">Open or short</td> </tr> <tr> <td>TH3 TH6 TH7</td> <td>4.3kΩ~9.6kΩ</td> </tr> <tr> <td>TH32</td> <td>4.4kΩ~9.8kΩ</td> </tr> <tr> <td>TH8</td> <td>39kΩ~105kΩ</td> </tr> </tbody> </table>		Normal	Abnormal	TH4/TH33	160kΩ~410kΩ	Open or short	TH3 TH6 TH7	4.3kΩ~9.6kΩ	TH32	4.4kΩ~9.8kΩ	TH8	39kΩ~105kΩ		
	Normal	Abnormal													
TH4/TH33	160kΩ~410kΩ	Open or short													
TH3 TH6 TH7	4.3kΩ~9.6kΩ														
TH32	4.4kΩ~9.8kΩ														
TH8	39kΩ~105kΩ														
Fan motor (MF1)	Refer to the next page.														
Solenoid valve coil <Four-way valve> (21S4)	Measure the resistance between the terminals with a tester. (At the ambient temperature of 20°C) <table border="1" style="margin-left: 20px;"> <thead> <tr> <th>Normal</th> <th>Abnormal</th> </tr> </thead> <tbody> <tr> <td>2350±170Ω</td> <td>Open or short</td> </tr> </tbody> </table>	Normal	Abnormal	2350±170Ω	Open or short										
Normal	Abnormal														
2350±170Ω	Open or short														
Compressor (MC) 	Measure the resistance between the terminals with a tester. (Winding temperature 20°C) <table border="1" style="margin-left: 20px;"> <thead> <tr> <th>Normal</th> <th>Abnormal</th> </tr> </thead> <tbody> <tr> <td>0.88Ω</td> <td>Open or short</td> </tr> </tbody> </table>	Normal	Abnormal	0.88Ω	Open or short										
Normal	Abnormal														
0.88Ω	Open or short														
Linear expansion valve (LEV-A) (LEV-B) 	Disconnect the connector then measure the resistance with a tester. (Winding temperature 20°C) <table border="1" style="margin-left: 20px;"> <thead> <tr> <th colspan="4">Normal</th> <th>Abnormal</th> </tr> </thead> <tbody> <tr> <td>Gray - Black</td> <td>Gray - Red</td> <td>Gray - Yellow</td> <td>Gray - Orange</td> <td rowspan="2">Open or short</td> </tr> <tr> <td colspan="4">46±3Ω</td> </tr> </tbody> </table>	Normal				Abnormal	Gray - Black	Gray - Red	Gray - Yellow	Gray - Orange	Open or short	46±3Ω			
Normal				Abnormal											
Gray - Black	Gray - Red	Gray - Yellow	Gray - Orange	Open or short											
46±3Ω															
Solenoid valve coil <Bypass valve> (SV)	Measure the resistance between the terminals with a tester. (At the ambient temperature of 20°C) <table border="1" style="margin-left: 20px;"> <thead> <tr> <th>Normal</th> <th>Abnormal</th> </tr> </thead> <tbody> <tr> <td>1450±150Ω</td> <td>Open or short</td> </tr> </tbody> </table>	Normal	Abnormal	1450±150Ω	Open or short										
Normal	Abnormal														
1450±150Ω	Open or short														

Check method of DC fan motor (fan motor / outdoor controller circuit board)

① Notes

- High voltage is applied to the connector (CNF1) for the fan motor. Pay attention to the service.
- Do not pull out the connector (CNF1) of the motor with the power supply on.
(It may damage the outdoor controller circuit board and fan motor.)

② Self check

Symptom: The outdoor fan does not run.

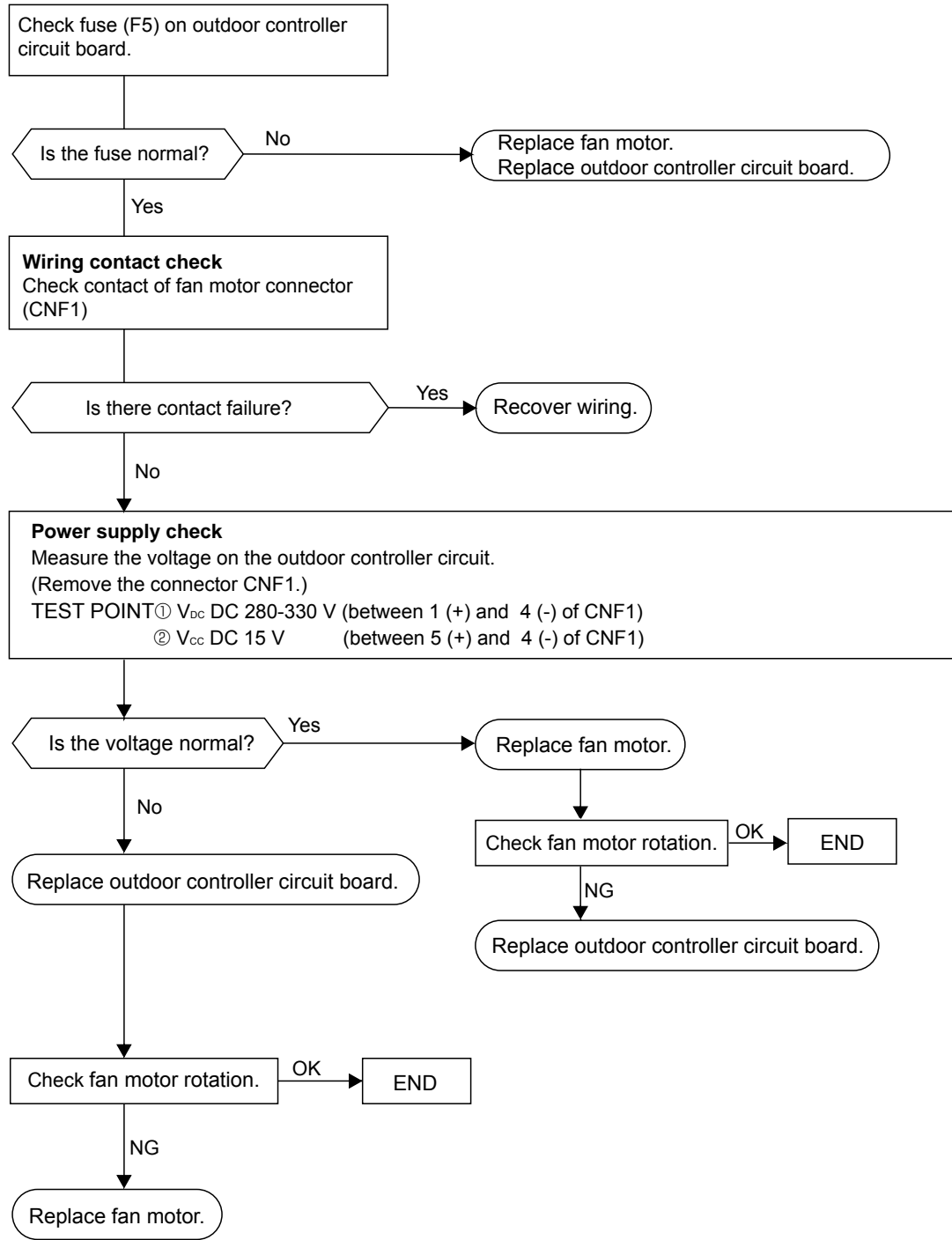

8-5. HOW TO CHECK THE COMPONENTS

<Thermistor feature chart>

Low temperature thermistors

- Thermistor <Liquid pipe> (TH3)
- Thermistor <Plate Hex liquid pipe> (TH6)
- Thermistor <Ambient> (TH7)

Thermistor R0 = 15kΩ ± 3%

B constant = 3480 ± 2%

$$R_t = 15 \exp\left\{3480 \left(\frac{1}{273+t} - \frac{1}{273} \right)\right\}$$

0°C	15kΩ	30°C	4.3kΩ
10°C	9.6kΩ	40°C	3.0kΩ
20°C	6.3kΩ		
25°C	5.2kΩ		

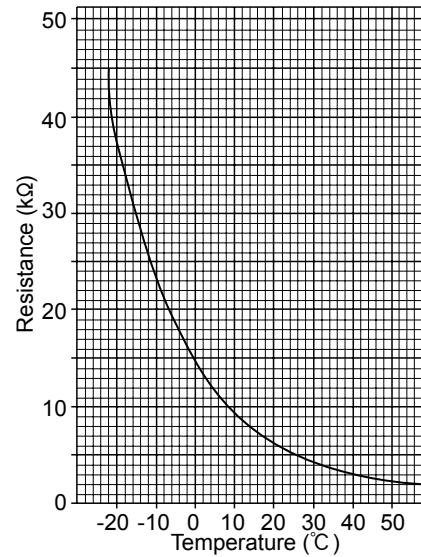

Medium temperature thermistor

- Thermistor <Heatsink> (TH8)

Thermistor R50 = 17kΩ ± 2%

B constant = 4150 ± 3%

$$R_t = 17 \exp\left\{4150 \left(\frac{1}{273+t} - \frac{1}{323} \right)\right\}$$

0°C	180kΩ
25°C	50kΩ
50°C	17kΩ
70°C	8kΩ
90°C	4kΩ

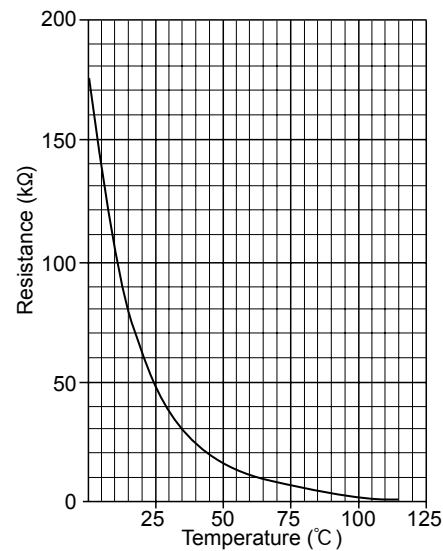

High temperature thermistor

- Thermistor <Discharge pipe> (TH4)
- Thermistor <Comp. surface> (TH33)

Thermistor R120 = 7.465kΩ ± 2%

B constant = 4057 ± 2%

$$R_t = 7.465 \exp\left\{4057 \left(\frac{1}{273+t} - \frac{1}{393} \right)\right\}$$

20°C	250kΩ	70°C	34kΩ
30°C	160kΩ	80°C	24kΩ
40°C	104kΩ	90°C	17.5kΩ
50°C	70kΩ	100°C	13.0kΩ
60°C	48kΩ	110°C	9.8kΩ

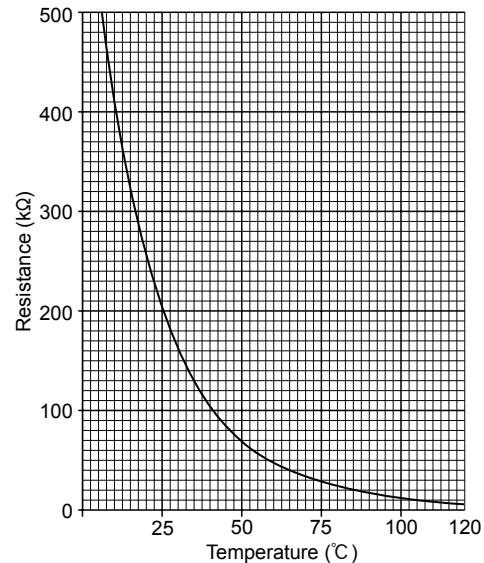

Low temperature thermistor

• Thermistor <Inlet water> (TH32)

Thermistor R0 = 15kΩ ± 2.5%

B constant = 3450 ± 2%

$$R_t = 15 \exp\left\{3450 \left(\frac{1}{273+t} - \frac{1}{273}\right)\right\}$$

0°C	15kΩ	30°C	4.3kΩ
10°C	9.6kΩ	40°C	3.0kΩ
20°C	6.3kΩ		
25°C	5.2kΩ		

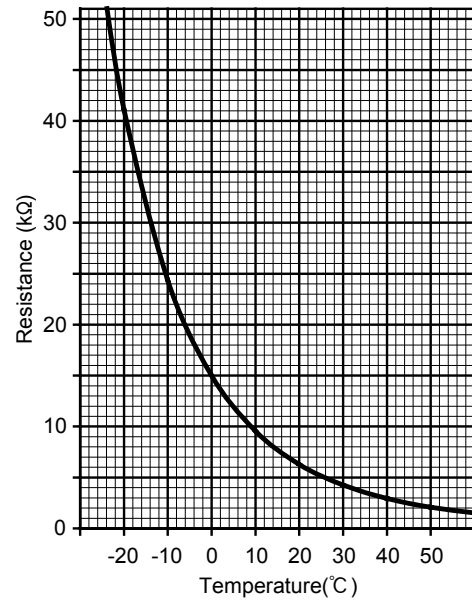

<HIGH PRESSURE SENSOR>

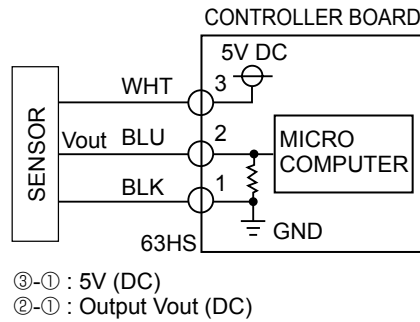
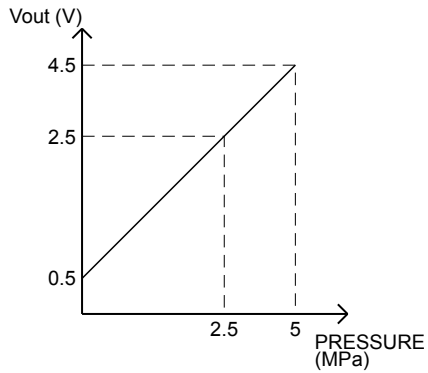

Linear expansion valve

(1) Operation summary of the linear expansion valve

- Linear expansion valve opens/closes through stepping motor after receiving the pulse signal from the outdoor controller board.
 - Valve position can be changed in proportion to the number of pulse signal.
- <Connection between the outdoor controller board and the linear expansion valve>

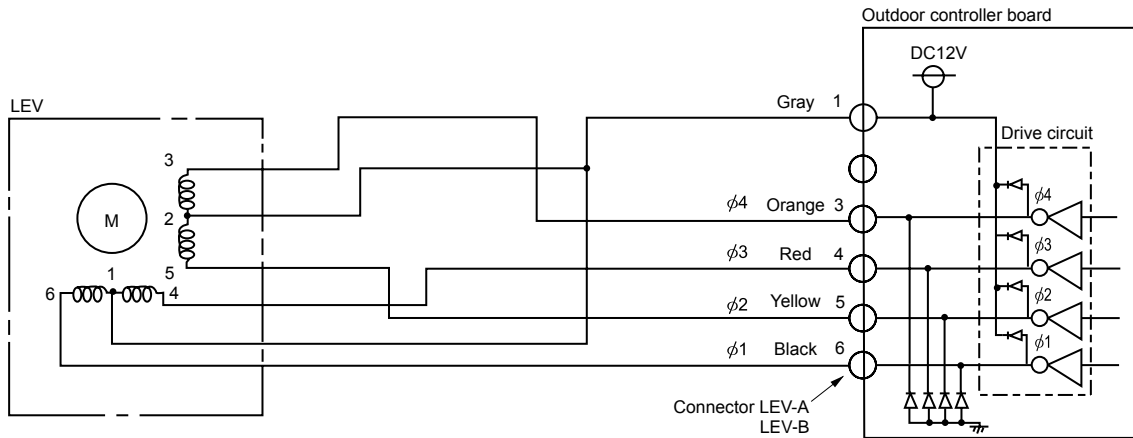

<Output pulse signal and the valve operation>

Output (Phase)	Output							
	1	2	3	4	5	6	7	8
$\phi 1$	ON	ON	OFF	OFF	OFF	OFF	OFF	ON
$\phi 2$	OFF	ON	ON	ON	OFF	OFF	OFF	OFF
$\phi 3$	OFF	OFF	OFF	ON	ON	ON	OFF	OFF
$\phi 4$	OFF	OFF	OFF	OFF	OFF	ON	ON	ON

Opening a valve : 8 → 7 → 6 → 5 → 4 → 3 → 2 → 1 → 8
 Closing a valve : 1 → 2 → 3 → 4 → 5 → 6 → 7 → 8 → 1
 The output pulse shifts in above order.

- When linear expansion valve operation stops, all output phase become OFF.

(2) Linear expansion valve operation

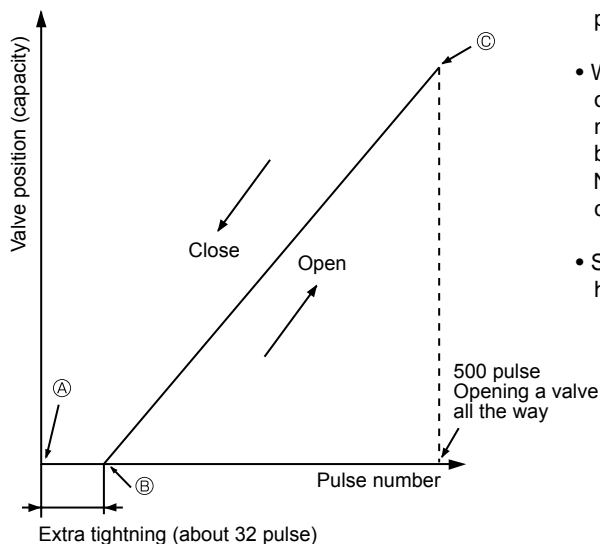

- When the switch is turned on, 700 pulse closing valve signal will be sent till it goes to ① point in order to define the valve position. (The pulse signal is being sent for about 20 seconds.)
- When the valve moves smoothly, there is no sound or vibration occurring from the linear expansion valve; however, when the pulse number moves from ② to ① or when the valve is locked, sound can be heard. No sound is heard when the pulse number moves from ② to ① in case coil is burnt out or motor is locked by open-phase.
- Sound can be detected by placing the ear against the screw driver handle while putting the screw driver to the linear expansion valve.

(3) How to attach and detach the coil of linear expansion valve

<Composition>

Linear expansion valve is separable into the main body and the coil as shown in the diagram below.

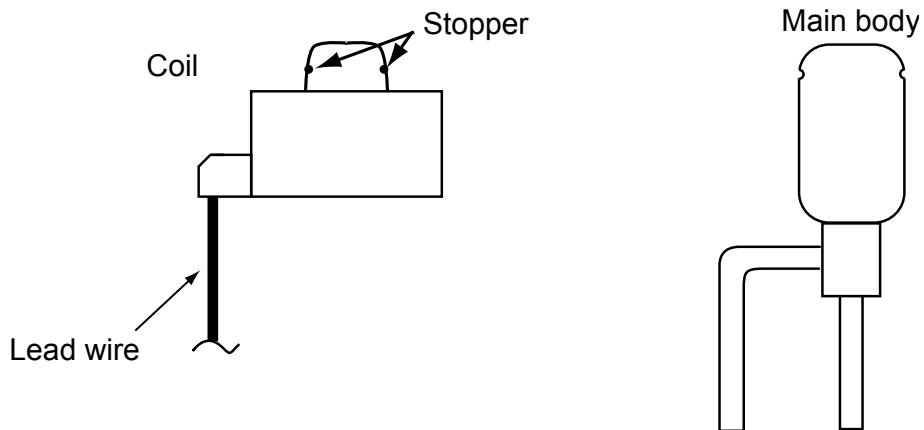

<How to detach the coil>

Hold the lower part of the main body (shown as A) firmly so that the main body does not move and detach the coil by pulling it upward.

Be sure to detach the coil holding main body firmly. Otherwise pipes can bend due to pressure.

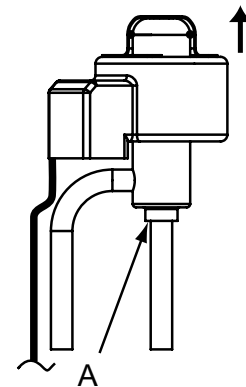

<How to attach the coil>

Hold the lower part of the main body (shown as A) firmly so that the main body does not move and attach the coil by inserting it downward into the main body. Then securely attach the coil stopper to main body. (At this time, be careful that stress is not added to lead wire and main body is not wound by lead wire.) If the stopper is not firmly attached to main body, coil may be detached from the main body and that can cause defective operation of linear expansion valve.

To prevent piping stress, be sure to attach the coil holding the main body of linear expansion valve firmly. Otherwise pipe may break.

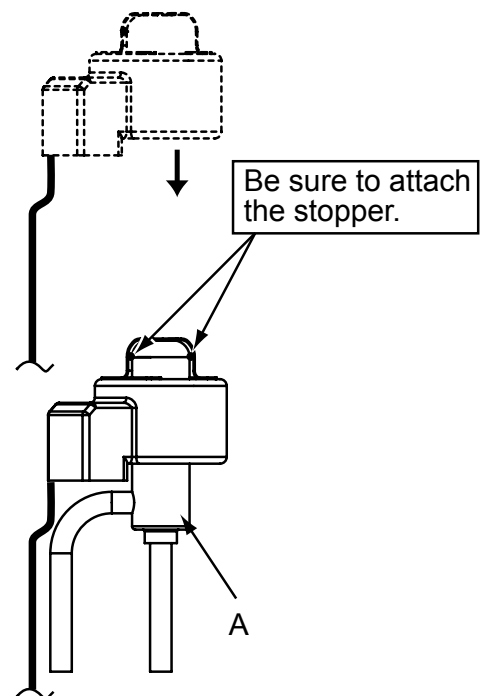

8-6. TEST POINT DIAGRAM

Outdoor controller circuit board

PUHZ-W85VHA2.UK PUHZ-W85VHA2-BS.UK

<CAUTION> TEST POINT ① is high voltage.

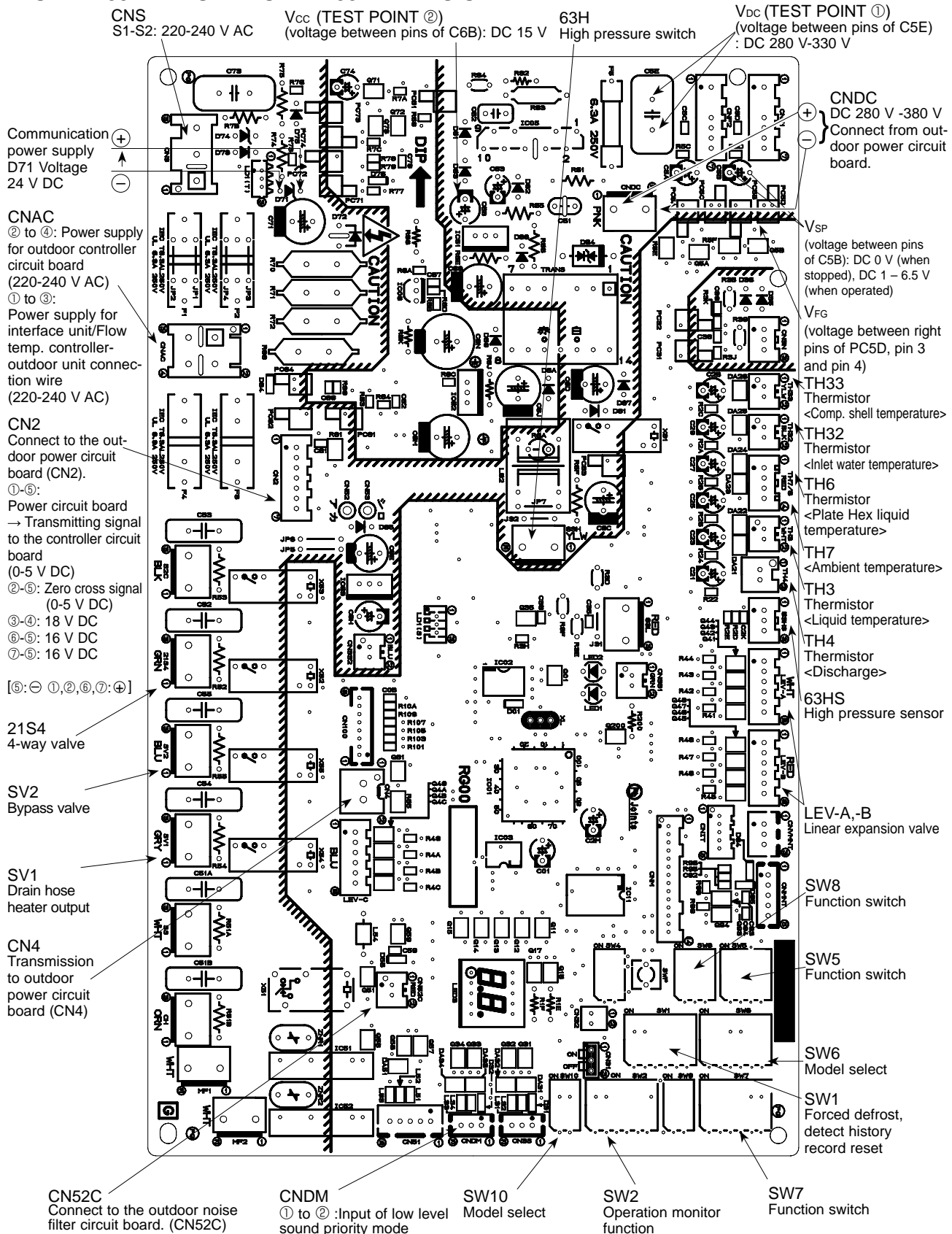

Outdoor noise filter circuit board
PUHZ-W85VHA2.UK
PUHZ-W85VHA2-BS.UK

LO, NO
 Voltage of 220-240 V AC is output.
 Connect to the outdoor power
 circuit board (TABS, TABT).

CNAC1, CNAC2
 220-240 V AC
 Connect to the out-
 door controller cir-
 cuit board (CNAC).

E2
 Connect to the
 earth.

CN5
 Input current
 Connect to the
 outdoor power
 circuit board
 (CN5).

E1
 Connect to
 the earth.

LI, NI
 Voltage of 220-240 V AC is input.
 Connect to the terminal block (TB1).

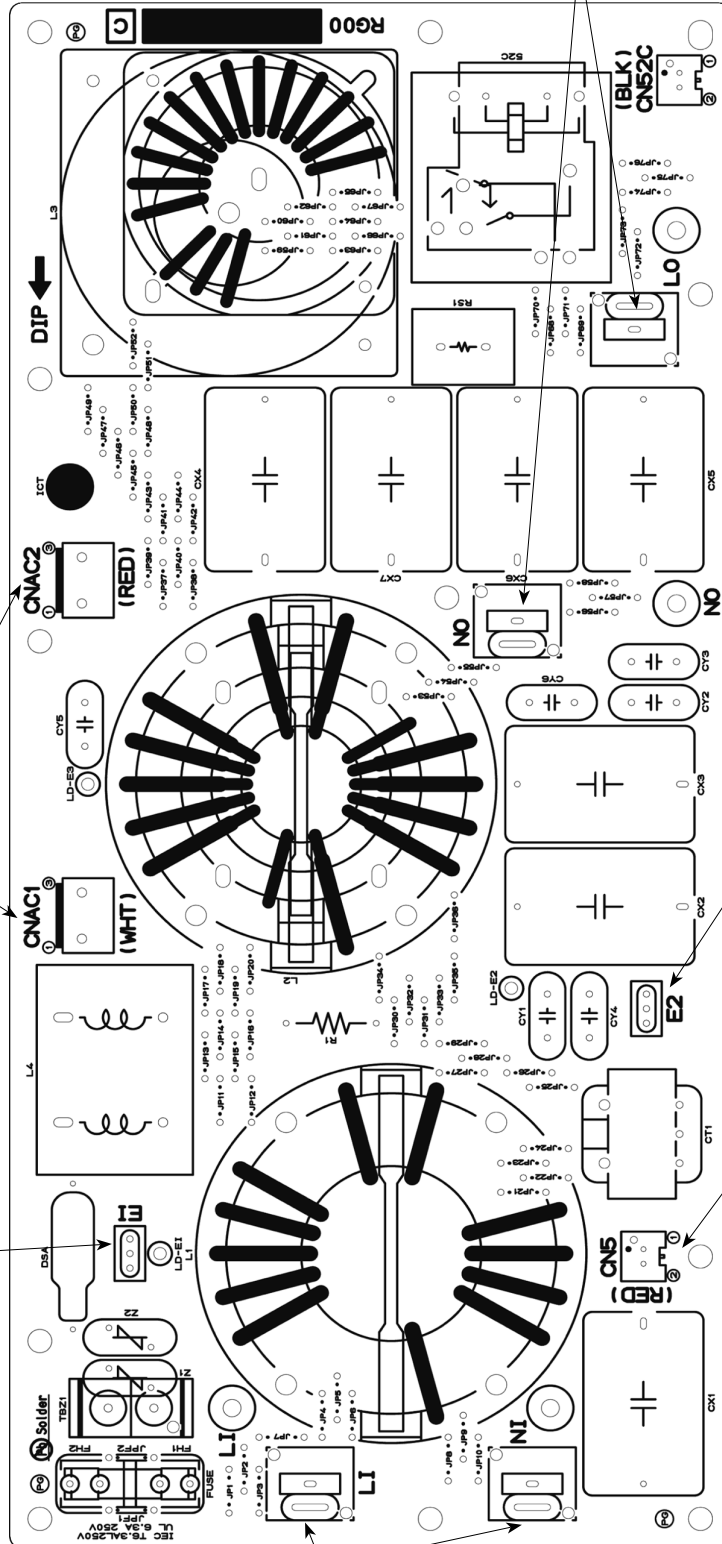

Outdoor power circuit board
PUHZ-W85VHA2.UK
PUHZ-W85VHA2-BS.UK

Brief Check of POWER MODULE

※ Usually, they are in a state of being short-circuited if they are broken.
 Measure the resistance in the following points (connectors, etc.).
 If they are short-circuited, it means that they are broken.

1. Check of diode bridge
 TABP1-TABS, TABN1-TABS, TABP1-TABT, TABN1-TABT
2. Check of DIP-IPM
 P-U, P-V, P-W, N-U, N-V, N-W

CN2
 Connect to the outdoor controller circuit board (CN2)
 1-5: Transmitting signal to the outdoor controller circuit board (0~5 V DC)
 2-5: Zero cross signal (0~5 V DC)
 3,4: 18 V DC
 6-5: 16 V DC
 7-5: 16 V DC

CNAF
 Connect to ACTM

CNDC
 280-380 V DC (①+, ③-)
 Connect to the outdoor controller circuit board

DIP-IPM

CN3
 Thermistor (TH8)
 <Heatsink>

CN5
 Detection of input current
 Connect to the outdoor noise filter circuit board (CN5)

CN4
 Connect to the outdoor controller circuit board (CN4)

TABP2
 Connect to the ACTM

TABS/TABT
 Connect to the outdoor noise filter circuit board
 Voltage among phases:
 220-240 V AC

TABP1
 Connect to ACTM ⊕

TABN1
 Connect to ACTM ⊖

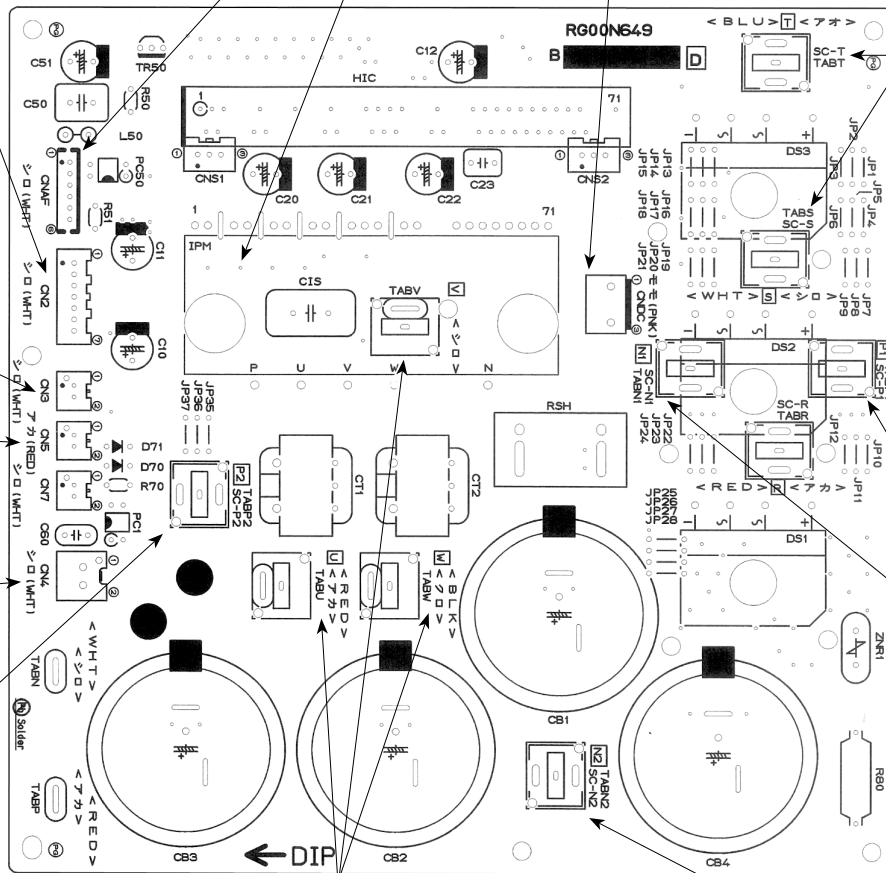

TABU/V/W
 Connect to the compressor (MC)
 Voltage among phases: 10 V ~180 V AC

TABN2
 Connect to ACTM

Active filter module
PUHZ-W85VHA2.UK
PUHZ-W85VHA2-BS.UK

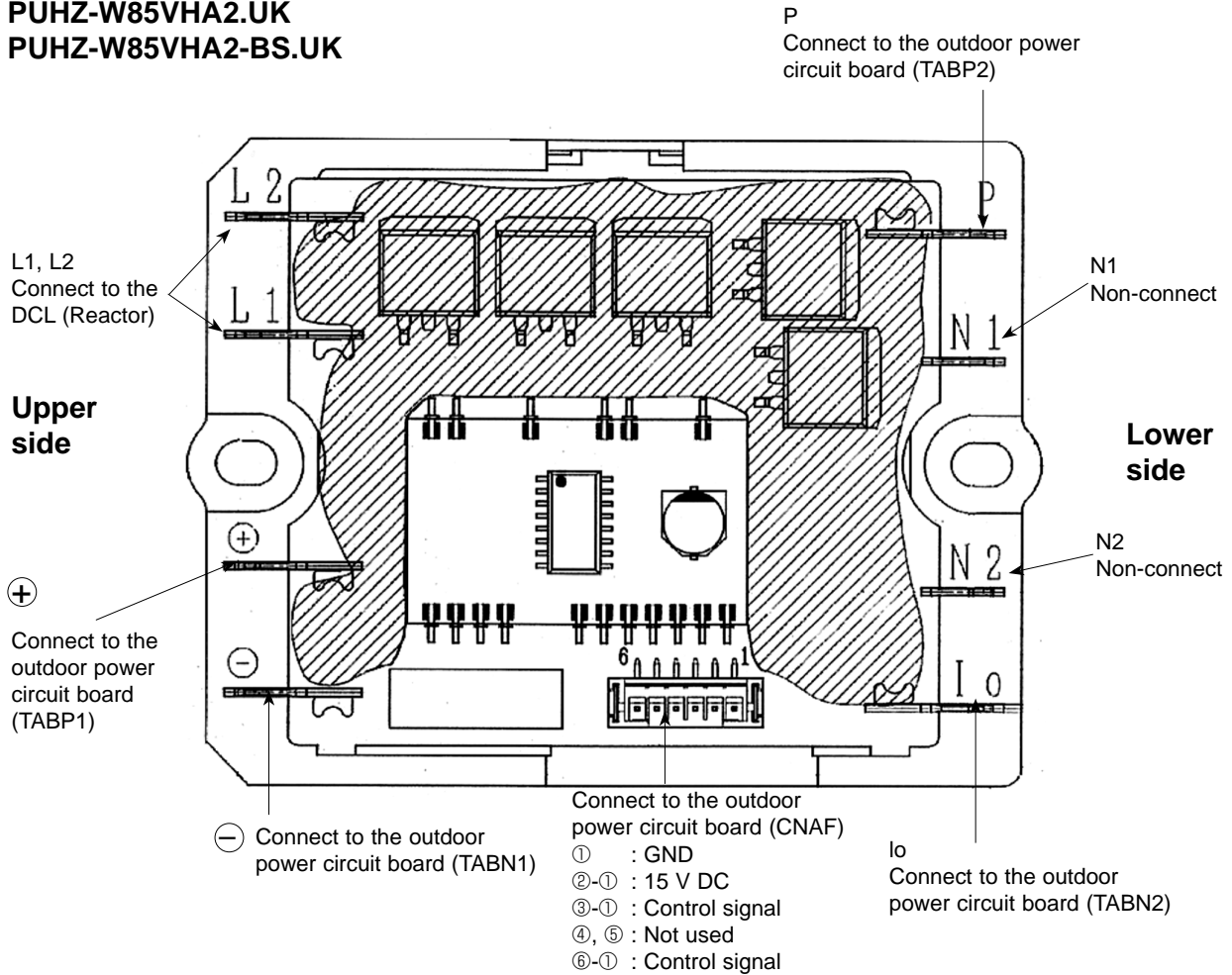

Connection and internal circuit diagram

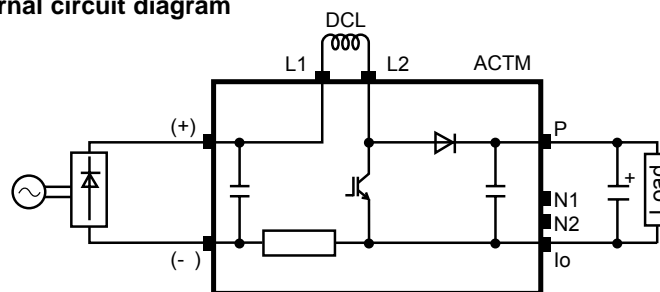

Tester check points of Active filter module

	Error condition	Normal value (reference)	Symptom when the unit is in trouble
(-) and I o	open	less than 1Ω	① The unit does not operate (can not be switched ON)
(-) and L2	short	100kΩ ~ 1MΩ	① The breaker operates
	open	*1	① The unit does not operate (can not be switched ON) ②U9 Abnormal stop (*2)
P and L2	short	100kΩ ~ 1MΩ	① The breaker operates
	open	*1	① The unit does not operate (can not be switched ON) ②U9 Abnormal stop (*2)
P and I o	short	100kΩ ~ 1MΩ	① The breaker operates
	open	*1	① The unit does not operate (can not be switched ON) ②U9 Abnormal stop (*2)
L2 and I o	short	100kΩ ~ 1MΩ	① The breaker operates
	open	*1	① The unit does not operate (can not be switched ON) ②U9 Abnormal stop (*2)

*1.The symptom when the unit is in open error condition is described to determine open error by tester check.

*2.SW2 setting ON OFF : Code "20" display



8-7. OUTDOOR UNIT OPERATION MONITOR FUNCTION

Operation indicator SW2: Indicator change of self diagnosis

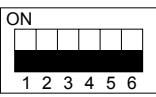
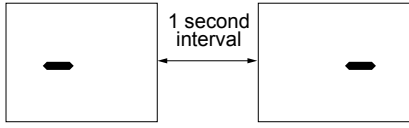
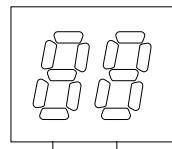
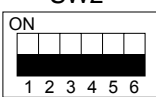
SW2 setting	Display detail	Explanation for display	Unit																																																																	
	<p><Digital indicator LED3 working details> (Be sure that the 1 to 6 in the SW2 are set to OFF.)</p> <p>(1) Display when the power supply is ON. When the power supply is ON, blinking displays by turns. Wait for 10 seconds at the longest.</p> <p>(2) When the display lights (Normal operation)</p> <p>① Operation mode display</p>																																																																			
	<p>(Lighting)</p>  <p>LED3</p>	<p>SW2 (Initial setting)</p> 																																																																		
	<p>The tens digit : Operation mode</p> <table border="1"> <thead> <tr> <th>Display</th> <th>Operation Model</th> </tr> </thead> <tbody> <tr> <td>O</td> <td>OFF</td> </tr> <tr> <td>C</td> <td>COOLING</td> </tr> <tr> <td>H</td> <td>HEATING</td> </tr> <tr> <td>d</td> <td>DEFROSTING</td> </tr> </tbody> </table>	Display	Operation Model	O	OFF	C	COOLING	H	HEATING	d	DEFROSTING	<p>The ones digit : Relay output</p> <table border="1"> <thead> <tr> <th>Display</th> <th>Warming-up Compressor</th> <th>Compressor</th> <th>4-way valve</th> <th>Solenoid valve</th> </tr> </thead> <tbody> <tr> <td>0</td> <td>—</td> <td>—</td> <td>—</td> <td>—</td> </tr> <tr> <td>1</td> <td>—</td> <td>—</td> <td>—</td> <td>ON</td> </tr> <tr> <td>2</td> <td>—</td> <td>—</td> <td>ON</td> <td>—</td> </tr> <tr> <td>3</td> <td>—</td> <td>—</td> <td>ON</td> <td>ON</td> </tr> <tr> <td>4</td> <td>—</td> <td>ON</td> <td>—</td> <td>—</td> </tr> <tr> <td>5</td> <td>—</td> <td>ON</td> <td>—</td> <td>ON</td> </tr> <tr> <td>6</td> <td>—</td> <td>ON</td> <td>ON</td> <td>—</td> </tr> <tr> <td>7</td> <td>—</td> <td>ON</td> <td>ON</td> <td>ON</td> </tr> <tr> <td>8</td> <td>ON</td> <td>—</td> <td>—</td> <td>—</td> </tr> <tr> <td>A</td> <td>ON</td> <td>—</td> <td>ON</td> <td>—</td> </tr> </tbody> </table>	Display	Warming-up Compressor	Compressor	4-way valve	Solenoid valve	0	—	—	—	—	1	—	—	—	ON	2	—	—	ON	—	3	—	—	ON	ON	4	—	ON	—	—	5	—	ON	—	ON	6	—	ON	ON	—	7	—	ON	ON	ON	8	ON	—	—	—	A	ON	—	ON	—	
Display	Operation Model																																																																			
O	OFF																																																																			
C	COOLING																																																																			
H	HEATING																																																																			
d	DEFROSTING																																																																			
Display	Warming-up Compressor	Compressor	4-way valve	Solenoid valve																																																																
0	—	—	—	—																																																																
1	—	—	—	ON																																																																
2	—	—	ON	—																																																																
3	—	—	ON	ON																																																																
4	—	ON	—	—																																																																
5	—	ON	—	ON																																																																
6	—	ON	ON	—																																																																
7	—	ON	ON	ON																																																																
8	ON	—	—	—																																																																
A	ON	—	ON	—																																																																
	<p>② Display during error postponement Postponement code is displayed when compressor stops due to the work of protection device. Postponement code is displayed while error is being postponed.</p>																																																																			
	<p>(3) When the display blinks Inspection code is displayed when compressor stops due to the work of protection devices.</p> <table border="1"> <thead> <tr> <th>Display</th> <th>Contents to be inspected (During operation)</th> </tr> </thead> <tbody> <tr> <td>U1</td> <td>Abnormal high pressure (63H worked)</td> </tr> <tr> <td>U2</td> <td>Abnormal high discharging temperature, shortage of refrigerant</td> </tr> <tr> <td>U3</td> <td>Open/short circuit of discharging thermistor (TH4, TH33)</td> </tr> <tr> <td>U4</td> <td>Open/short of outdoor unit thermistors (TH3, TH32, TH6, TH7 and TH8)</td> </tr> <tr> <td>U5</td> <td>Abnormal temperature of heatsink</td> </tr> <tr> <td>U6</td> <td>Abnormality of power module</td> </tr> <tr> <td>U7</td> <td>Abnormality of superheat due to low discharge temperature</td> </tr> <tr> <td>U8</td> <td>Abnormality in outdoor fan motor</td> </tr> <tr> <td>U9</td> <td>Voltage fault, Input current sensor error</td> </tr> <tr> <td>Ud</td> <td>Overheat protection</td> </tr> <tr> <td>UF</td> <td>Compressor overcurrent interruption (When Comp. locked)</td> </tr> <tr> <td>UH</td> <td>Current sensor error, Input overcurrent interruption</td> </tr> <tr> <td>UP</td> <td>Compressor overcurrent interruption</td> </tr> <tr> <td>P6</td> <td>Freezing/overheating protection is working.</td> </tr> <tr> <td>P8</td> <td>Abnormality of pipe temperature</td> </tr> <tr> <td>UE</td> <td>Abnormal pressure of pressure sensor</td> </tr> <tr> <td>PE</td> <td>Abnormality of inlet water temperature</td> </tr> <tr> <td>Ed</td> <td>Serial communication error</td> </tr> </tbody> </table>	Display	Contents to be inspected (During operation)	U1	Abnormal high pressure (63H worked)	U2	Abnormal high discharging temperature, shortage of refrigerant	U3	Open/short circuit of discharging thermistor (TH4, TH33)	U4	Open/short of outdoor unit thermistors (TH3, TH32, TH6, TH7 and TH8)	U5	Abnormal temperature of heatsink	U6	Abnormality of power module	U7	Abnormality of superheat due to low discharge temperature	U8	Abnormality in outdoor fan motor	U9	Voltage fault, Input current sensor error	Ud	Overheat protection	UF	Compressor overcurrent interruption (When Comp. locked)	UH	Current sensor error, Input overcurrent interruption	UP	Compressor overcurrent interruption	P6	Freezing/overheating protection is working.	P8	Abnormality of pipe temperature	UE	Abnormal pressure of pressure sensor	PE	Abnormality of inlet water temperature	Ed	Serial communication error																													
Display	Contents to be inspected (During operation)																																																																			
U1	Abnormal high pressure (63H worked)																																																																			
U2	Abnormal high discharging temperature, shortage of refrigerant																																																																			
U3	Open/short circuit of discharging thermistor (TH4, TH33)																																																																			
U4	Open/short of outdoor unit thermistors (TH3, TH32, TH6, TH7 and TH8)																																																																			
U5	Abnormal temperature of heatsink																																																																			
U6	Abnormality of power module																																																																			
U7	Abnormality of superheat due to low discharge temperature																																																																			
U8	Abnormality in outdoor fan motor																																																																			
U9	Voltage fault, Input current sensor error																																																																			
Ud	Overheat protection																																																																			
UF	Compressor overcurrent interruption (When Comp. locked)																																																																			
UH	Current sensor error, Input overcurrent interruption																																																																			
UP	Compressor overcurrent interruption																																																																			
P6	Freezing/overheating protection is working.																																																																			
P8	Abnormality of pipe temperature																																																																			
UE	Abnormal pressure of pressure sensor																																																																			
PE	Abnormality of inlet water temperature																																																																			
Ed	Serial communication error																																																																			
	<table border="1"> <thead> <tr> <th>Display</th> <th>Inspection unit</th> </tr> </thead> <tbody> <tr> <td>0</td> <td>Outdoor unit</td> </tr> </tbody> </table>	Display	Inspection unit	0	Outdoor unit																																																															
Display	Inspection unit																																																																			
0	Outdoor unit																																																																			
	<table border="1"> <thead> <tr> <th>Display</th> <th>Contents to be inspected (When power is turned on)</th> </tr> </thead> <tbody> <tr> <td>F5</td> <td>63H connector (yellow) is open.</td> </tr> <tr> <td>E8</td> <td>Interface unit/Flow temp. controller-outdoor communication error (Signal receiving error) (Outdoor unit)</td> </tr> <tr> <td>E9</td> <td>Interface unit/Flow temp. controller-outdoor communication error (Transmitting error) (Outdoor unit)</td> </tr> <tr> <td>EA</td> <td>Miswiring of Interface unit/Flow temp. controller-outdoor unit connecting wire, excessive number of indoor units (2 units or more)</td> </tr> <tr> <td>Eb</td> <td>Miswiring of Interface unit/Flow temp. controller-outdoor unit connecting wire (converse wiring or disconnection)</td> </tr> <tr> <td>EC</td> <td>Startup time over</td> </tr> <tr> <td>E0~E7</td> <td>Communication error except for outdoor unit</td> </tr> </tbody> </table>	Display	Contents to be inspected (When power is turned on)	F5	63H connector (yellow) is open.	E8	Interface unit/Flow temp. controller-outdoor communication error (Signal receiving error) (Outdoor unit)	E9	Interface unit/Flow temp. controller-outdoor communication error (Transmitting error) (Outdoor unit)	EA	Miswiring of Interface unit/Flow temp. controller-outdoor unit connecting wire, excessive number of indoor units (2 units or more)	Eb	Miswiring of Interface unit/Flow temp. controller-outdoor unit connecting wire (converse wiring or disconnection)	EC	Startup time over	E0~E7	Communication error except for outdoor unit																																																			
Display	Contents to be inspected (When power is turned on)																																																																			
F5	63H connector (yellow) is open.																																																																			
E8	Interface unit/Flow temp. controller-outdoor communication error (Signal receiving error) (Outdoor unit)																																																																			
E9	Interface unit/Flow temp. controller-outdoor communication error (Transmitting error) (Outdoor unit)																																																																			
EA	Miswiring of Interface unit/Flow temp. controller-outdoor unit connecting wire, excessive number of indoor units (2 units or more)																																																																			
Eb	Miswiring of Interface unit/Flow temp. controller-outdoor unit connecting wire (converse wiring or disconnection)																																																																			
EC	Startup time over																																																																			
E0~E7	Communication error except for outdoor unit																																																																			



SW2 setting	Display detail	Explanation for display	Unit
	Pipe temperature / Liquid (TH3) - 40~90	- 40~90 (When the coil thermistor detects 0°C or below, “-” and temperature are displayed by turns.) (Example) When -10°C; 0.5 secs. 0.5 secs. 2 secs. -□ → 10 → □□	°C
	Discharge temperature (TH4) 3~217	3~217 (When the discharge thermistor detects 100°C or more, hundreds digit, tens digit and ones digit are displayed by turns.) (Example) When 105°C; 0.5 secs. 0.5 secs. 2 secs. □1 → 05 → □□	°C
	Fan steps 0~10	0~10	Step
	Compressor ON/OFF 0~9999	0~9999 (When the number of times is 100 or more, hundreds digit, tens digit and ones digit are displayed by turns.) (Example) When 42500 times (425 × 100 times); 0.5 secs. 0.5 secs. 2 secs. □4 → 25 → □□	100 times
	Compressor accumulated operation hours 0~9999	0~9999 (When it is 100 hours or more, hundreds digit, tens digit and ones digit are displayed by turns.) (Example) When 2450 hours (245 × 10 hours); 0.5 secs. 0.5 secs. 2 secs. □2 → 45 → □□	10 hours
	Compressor running current 0~50	0~50 ※Value after the decimal point will be truncated.	A
	Compressor running frequency 0~255	0~255 (When it is 100 Hz or more, hundreds digit, tens digit and ones digit are displayed by turns.) (Example) When 105 Hz; 0.5 secs. 0.5 secs. 2 secs. □1 → 05 → □□	Hz
	LEV-A opening pulse 0~500	0~500 (When it is 100 pulse or more, hundreds digit, tens digit and ones digit are displayed by turns.) (Example) When 150 pulse; 0.5 secs. 0.5 secs. 2 secs. □1 → 50 → □□	Pulse
	Deferred error history (1)	Deferred error Blinking: being deferred Lighting: deferment is cancelled “00” is displayed in case of no deferment	Code display
	Operation mode when the error occurred.	Operation mode when the unit is stopped due to an error is displayed. The displayed code is when the SW2 is set as below. (SW2)	Code display



SW2 setting	Display detail	Explanation for display	Unit				
	Pipe temperature/Liquid (TH3) when error occurred. – 40~90	– 40~90 (When the coil thermistor detects 0°C or below, “–” and temperature are displayed by turns.) (Example) When –15°C; 0.5 secs. 0.5 secs. 2 secs. –□ → 15 → □□	°C				
	Discharge temperature (TH4) when error occurred. 3~217	3~217 (When the temperature is 100°C or more, the hundreds digit, tens digit and ones digit are displayed by turns.) (Example) When 130°C; 0.5 secs. 0.5 secs. 2 secs. □1 → 30 → □□	°C				
	Compressor current when error occurred. 0~50	0~50	A				
	Error code history (1) (latest) Alternate display of faulty unit number and error code	When no error history, “0” and “–” are displayed by turns.	Code display				
	Error code history (2) Alternate display of faulty unit number and error code	When no error history, “0” and “–” are displayed by turns.	Code display				
	Compressor operation duration 0~999	0~999 (When it is 100 minutes or more, the hundreds digit, tens digit and ones digit are displayed by turns.) (Example) When 245 minutes; 0.5 secs. 0.5 secs. 2 secs. □2 → 45 → □□	Minute				
	LEV-B opening when error occurred	0~500 (When it is 100 pulse or more, hundreds digit, tens digit and ones digit are displayed by turns.) (Example) When 150 pulse; 0.5 secs. 0.5 secs. 2 secs. □1 → 50 → □□	Pulse				
	Capacity settings	The outdoor capacity code is shown as below <table border="1" style="margin-left: auto; margin-right: auto;"> <thead> <tr> <th>Model</th> <th>Code</th> </tr> </thead> <tbody> <tr> <td>PUHZ-W85</td> <td>14</td> </tr> </tbody> </table>	Model	Code	PUHZ-W85	14	Code display
Model	Code						
PUHZ-W85	14						



SW2 setting	Display detail	Explanation for display	Unit										
	Outdoor unit setting information	<ul style="list-style-type: none"> The tens digit (Total display for applied setting) <table border="1"> <thead> <tr> <th>Setting details</th> <th>Display details</th> </tr> </thead> <tbody> <tr> <td>H·P / Cooling only</td> <td>0 : H·P 1 : Cooling only</td> </tr> <tr> <td>Single phase / 3 phase</td> <td>0 : Single phase 2 : 3 phase</td> </tr> </tbody> </table> <ul style="list-style-type: none"> The ones digit <table border="1"> <thead> <tr> <th>Setting details</th> <th>Display details</th> </tr> </thead> <tbody> <tr> <td>Defrosting switch</td> <td>0 : Normal 1 : For high humidity</td> </tr> </tbody> </table> <p>(Example) When heat pump, 3 phase and defrosting (normal) are set up, "20" is displayed.</p>	Setting details	Display details	H·P / Cooling only	0 : H·P 1 : Cooling only	Single phase / 3 phase	0 : Single phase 2 : 3 phase	Setting details	Display details	Defrosting switch	0 : Normal 1 : For high humidity	Code display
Setting details	Display details												
H·P / Cooling only	0 : H·P 1 : Cooling only												
Single phase / 3 phase	0 : Single phase 2 : 3 phase												
Setting details	Display details												
Defrosting switch	0 : Normal 1 : For high humidity												
	Plate HEX liquid pipe temperature (TH6) - 39~88	- 39~88 (When the temperature is 0°C or less, "-" and temperature are displayed by turns.)	°C										
	Condensing temperature (T _{63HS}) - 39~88	- 39~88 (When the temperature is 0°C or less, "-" and temperature are displayed by turns.)	°C										
	Calculated maximum frequency 0~150	0~150 (When it is 100 Hz or more, hundreds digit, tens digit and ones digit are displayed by turns. (Example) When 105 Hz; 0.5 secs. 0.5 secs. 2 secs. □1 →05 →□□ ↑	Hz										
	Water inlet temperature (TH32) 0~100	0~100	°C										
	Ambient temperature (TH7) -39~88	-39~88 (When the temperature is 0°C or less, "-" and temperature are displayed by turns.)	°C										
	Outdoor heatsink temperature (TH8) -40~200	-40~200 (When the temperature is 0°C or less, "-" and temperature are displayed by turns.) (When the thermistor detects 100°C or more, hundreds digit, tens digit and ones digit are displayed by turns.)	°C										
	Discharge superheat (SHd) 0~255 [Cooling and Heating: SHd = TH4-T _{63HS}]	0~255 (When the SHd is 100°C or more, hundreds digit, tens digit and ones digit are displayed by turns.)	°C										







SW2 setting	Display detail	Explanation for display	Unit																		
	Sub cool (SC) 0~130 [Cooling: SC = T _{63HS} -TH3 Heating: SC = T _{63HS} -TH6]	0~130 (When the SC is 100°C or more, hundreds digit, tens digit and ones digit are displayed by turns.)	°C																		
	Input current of outdoor unit 0~500	0~500 (When it is 100 or more, hundreds digit, tens digit and ones digit are displayed by turns.)	0.1 A																		
	LEV-B opening pulse 0~500	0~500 (When it is 100 pulse or more, hundreds digit, tens digit and ones digit are displayed by turns.)	Pulse																		
	U9 error detail history (latest)	<table border="1"> <thead> <tr> <th>Error details</th> <th>Cause</th> <th>Code</th> </tr> </thead> <tbody> <tr> <td>(No error)</td> <td>–</td> <td>00</td> </tr> <tr> <td>Over voltage</td> <td>Power PCB</td> <td>01</td> </tr> <tr> <td>Insufficient voltage</td> <td>Power PCB</td> <td>02</td> </tr> <tr> <td>Input current sensor error</td> <td>Control PCB</td> <td>04</td> </tr> <tr> <td>ACTM error</td> <td>Control PCB</td> <td>20</td> </tr> </tbody> </table>	Error details	Cause	Code	(No error)	–	00	Over voltage	Power PCB	01	Insufficient voltage	Power PCB	02	Input current sensor error	Control PCB	04	ACTM error	Control PCB	20	Code display
Error details	Cause	Code																			
(No error)	–	00																			
Over voltage	Power PCB	01																			
Insufficient voltage	Power PCB	02																			
Input current sensor error	Control PCB	04																			
ACTM error	Control PCB	20																			
	Direct current bus voltage 150~400	150~400 (When it is 100V or more, hundreds digit, tens digit and ones digit are displayed by turns.)	V																		
	Capacity save 0 ~ 100 [When there is no setting of capacity save, "100" is displayed.]	0~100 (When the capacity is 100% hundreds digit, tens digit and ones digit are displayed by turns.) (Example) When 100%; 0.5 secs. 0.5 secs. 2 secs. □ 1 → 00 → □ □	%																		
	Deferred error history (2) of outdoor unit	Deferred error code display Blinking: being deferred Lighting: deferment is cancelled "00" is displayed in case of no deferment.	Code display																		
	Deferred error history (3) of outdoor unit	Deferred error code display Blinking: being deferred Lighting: deferment is cancelled "00" is displayed in case of no deferment.	Code display																		



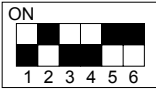
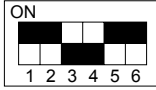
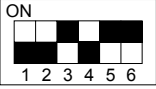

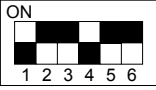
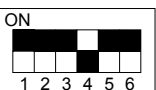
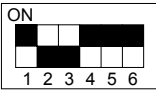
SW2 setting	Display detail	Explanation for display	Unit
	Error code history (3) (Oldest) Faulty unit number and error code are displayed alternately.	When no error history, "0" and "--" are displayed by turns.	Code display
	Error thermistor display [When there is no error thermistor, "-" is displayed.]	3: Liquid pipe thermistor (TH3) 3: Water inlet temp. thermistor (TH32) 6: Plate HEX liquid pipe thermistor (TH6) 7: Ambient temp. thermistor (TH7) 8: Heatsink thermistor (TH8) 4: Discharge thermistor (TH4) 33: Comp. shell thermistor (TH33)	Code display
	Operation frequency when error occurred. 0~225	0~225 (When it is 100 Hz or more, hundreds digit, tens digit and ones digit are displayed by turns.) (Example) When 105 Hz; 0.5 secs. 0.5 secs. 2 secs. □1 → 05 → □□	Hz
	Fan step when error occurred. 0~10	0~10	Step
	LEV-A opening pulse when error occurred. 0~500	0~500 (When it is 100 pulse or more, hundreds digit, tens digit and ones digit are displayed by turns.) (Example) When 130 pulse; 0.5 secs. 0.5 secs. 2 secs. □1 → 30 → □□	Pulse
	Plate HEX liquid pipe temperature (TH6) when error occurred. -39~88	-39~88 (When the temperature is 0°C or less, "-" and temperature are displayed by turns.) (Example) When -15°C; 0.5 secs. 0.5 secs. 2 secs. -□ → 15 → □□	°C
	Condensing temperature when error occurred. -39~88	-39~88 (When the temperature is 0°C or less, "-" and temperature are displayed by turns.) (Example) When -15°C; 0.5 secs. 0.5 secs. 2 secs. -□ → 15 → □□	°C
	Water inlet temperature (TH32) when error occurred. 0~100	0~100	°C
	Ambient temperature (TH7) when error occurred. -39~88	-39~88 (When the temperature is 0°C or less, "-" and temperature are displayed by turns.) (Example) When -15°C; 0.5 secs. 0.5 secs. 2 secs. -□ → 15 → □□	°C

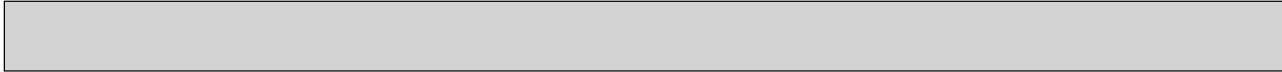

SW2 setting	Display detail	Explanation for display	Unit																
	Outdoor heatsink temperature (TH8) when error occurred. -40~200	-40~200 (When the temperature is 0°C or less, “-” and temperature are displayed by turns.) (When the temperature is 100°C or more, hundreds digit, tens digit and ones digit are displayed by turns.)	°C																
	Discharge superheat (SHd) when error occurred. 0~255 [Cooling and Heating: SHd=TH4-T _{63HS}]	0~255 (When the temperature is 100°C or more, hundreds digit, tens digit and ones digit are displayed by turns.) (Example) When 150°C; 0.5 secs. 0.5 secs. 2 secs. $\square 1 \rightarrow 50 \rightarrow \square \square$	°C																
	Sub cool (SC) when error occurred. 0~130 [Cooling: SC = T _{63HS} -TH3] [Heating: SC = T _{63HS} -TH6]	0~130 (When the temperature is 100°C or more, hundreds digit, tens digit and ones digit are displayed by turns.) (Example) When 115°C; 0.5 secs. 0.5 secs. 2 secs. $\square 1 \rightarrow 15 \rightarrow \square \square$	°C																
	Compressor operation duration before the unit stops with error 0~999	0~999 (When it is 100 minutes or more, hundreds digit, tens digit and ones digit are displayed by turns.) (Example) When 415 minutes; 0.5 secs. 0.5 secs. 2 secs. $\square 4 \rightarrow 15 \rightarrow \square \square$	Minute																
	Maximum frequency when error occurred 0~150	0~150 (When it is 100 Hz or more, hundreds digit, tens digit and ones digit are displayed by turns.) (Example) When 105 Hz; 0.5 secs. 0.5 secs. 2 secs. $\square 1 \rightarrow 05 \rightarrow \square \square$	Hz																
	Requested capacity step when error occurred 0~7	0~7	Step																
	Compressor frequency control status	The following code will be a help to know the operating status of unit. •Ten place (left side): <table border="1" data-bbox="808 1579 1237 1663"> <tr> <th>Display</th> <th>Compressor frequency control</th> </tr> <tr> <td>1</td> <td>Input current restriction control</td> </tr> <tr> <td>2</td> <td>Compressor current restriction control</td> </tr> </table> •First digit (Total figure of the corresponding relays are displayed.) <table border="1" data-bbox="808 1730 1282 1869"> <tr> <th>Display</th> <th>Compressor frequency control</th> </tr> <tr> <td>1</td> <td>Discharge temp.control(not to over rise).</td> </tr> <tr> <td>2</td> <td>Condensing temp.control(not to over rise).</td> </tr> <tr> <td>4</td> <td>Freezing protection control</td> </tr> <tr> <td>8</td> <td>Heatsink temp.control(not to over rise).</td> </tr> </table> When the following 3 points are under control;  (1) Input current restriction control. (2) Condensing temp. control (not to over rise). (3) Heatsink temp. control (not to over rise).	Display	Compressor frequency control	1	Input current restriction control	2	Compressor current restriction control	Display	Compressor frequency control	1	Discharge temp.control(not to over rise).	2	Condensing temp.control(not to over rise).	4	Freezing protection control	8	Heatsink temp.control(not to over rise).	Code display
Display	Compressor frequency control																		
1	Input current restriction control																		
2	Compressor current restriction control																		
Display	Compressor frequency control																		
1	Discharge temp.control(not to over rise).																		
2	Condensing temp.control(not to over rise).																		
4	Freezing protection control																		
8	Heatsink temp.control(not to over rise).																		

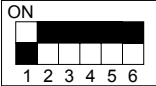

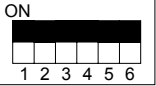
SW2 setting	Display detail	Explanation for display	Unit																		
	Comp. shell temperature (TH33) 3~217	3~217 (When the temperature is 100°C or more, the hundreds digit, tens digit and ones digit are displayed by turns.) (Example) When 130°C; 0.5 secs. 0.5 secs. 2 secs. □1 → 30 → □□ ↑ ↓	°C																		
	Requested capacity step (Q STEP) 0~7	0~7	Step																		
	U9 Error details (To be shown while error call is deferred.)	<table border="1" data-bbox="850 657 1352 942"> <thead> <tr> <th>Error details</th> <th>Cause</th> <th>Code</th> </tr> </thead> <tbody> <tr> <td>(No error)</td> <td>-</td> <td>00</td> </tr> <tr> <td>Over voltage</td> <td>Power PCB</td> <td>01</td> </tr> <tr> <td>Insufficient voltage</td> <td>Power PCB</td> <td>02</td> </tr> <tr> <td>Input current sensor error</td> <td>Control PCB</td> <td>04</td> </tr> <tr> <td>ACTM error</td> <td>Control PCB</td> <td>20</td> </tr> </tbody> </table>	Error details	Cause	Code	(No error)	-	00	Over voltage	Power PCB	01	Insufficient voltage	Power PCB	02	Input current sensor error	Control PCB	04	ACTM error	Control PCB	20	Code display
Error details	Cause	Code																			
(No error)	-	00																			
Over voltage	Power PCB	01																			
Insufficient voltage	Power PCB	02																			
Input current sensor error	Control PCB	04																			
ACTM error	Control PCB	20																			

Data Sheet for Air to Water Compact type

Applicable model

PUHZ-W85VHA2.UK
PUHZ-W85VHA2-BS.UK

Model name: [Serial No.:] Date: _____

Operation Data	SW2 setting						1:ON / 0:OFF
	1	2	3	4	5	6	
Inlet/Outlet water temperature	/	/	/	/	/	/	/
Outdoor Inlet/Outlet Air temperature	/	/	/	/	/	/	/
Discharge/Suction temperature	/	/	/	/	/	/	/
Discharge/Suction pressure	/	/	/	/	/	/	/
Power supply Voltage/Frequency (V / Hz)	/	/	/	/	/	/	/
Water flow Volume (L/min)	/	/	/	/	/	/	/
Water inlet temp. [TH32]	0	0	1	1	1	0	
Plate HEX liquid pipe temp. [TH6]	0	0	1	0	1	0	
Condensing temp. [T _{63HS}]	1	0	1	0	1	0	
Ambient temp. [TH7]	1	0	1	1	1	0	
Compressor running frequency (Hz)	1	1	0	0	0		
Fan steps (Step)	1	1	0	0	0		
Liquid pipe temp. [TH3]	1	0	0	0	0		
Discharge temp. [TH4]	0	1	0	0	0		
LEV-A opening pulse [LEV-A]	0	0	1	0	0		
LEV-B opening pulse [LEV-B]	0	1	0	0	1		
Requested capacity step [Q _{STEP}]	1	0	1	1	1		
Comp. surface temp. [TH33]	0	1	1	1	1		
Heatsink temp. [TH8]	0	1	1	1	0		
Discharge Super Heat [SHd]	1	1	1	1	0		
Calculated max. frequency (Hz)	1	1	0	1	0		
Compressor operation duration (Min)	0	0	0	1	0		
Sub Cool [SC]	0	0	0	0	1		
Demand capacity (%)	1	0	1	0	0		
Direct current bus line voltage (V)	0	0	1	0	0		
Compressor running current (A)	0	1	0	0	0		
Input current (0.1A)	1	0	0	0	0		
Compressor frequency control status *	1	0	0	1	1		
Temperature differential code [ΔTj]	0	0	0	1	1		

Recorded operation status	SW2 setting						1:ON / 0:OFF
	1	2	3	4	5	6	
Operation mode when the error occurred (Mode)	0	1	0	1	0	0	
Error code history (1) [Latest] (Code)	0	1	1	1	0	0	
Error code history (2) (Code)	1	1	1	1	0	0	
Error code history (3) [Oldest] (Code)	0	0	0	1	0	1	
Deferred error history (1) (Code)	1	0	1	0	0	0	
Deferred error history (2) (Code)	0	1	1	0	0	1	
Deferred error history (3) (Code)	1	1	1	0	0	1	
Condensing temp. [T _{63HS}]	1	1	1	0	1		
Plate HEX liquid pipe temp. [TH6]	0	1	1	0	1		
Compressor running frequency (Hz)	0	1	0	1	0		
Fan steps (Step)	1	1	0	1	0		
Liquid pipe temp. [TH3]	1	1	0	1	0		
Discharge temp. [TH4]	0	0	1	1	0		
LEV-A opening pulse [LEV-A]	0	0	1	1	0		
LEV-B opening pulse [LEV-B]	1	0	0	0	1		
Ambient temp. [TH7]	1	0	0	0	1		
Water inlet temp. [TH32]	0	0	0	0	1		
Water inlet temp. [TH32]	0	0	0	0	1		
Heat sink temp. [TH8]	0	1	0	0	1		
Calculated max. frequency (Hz)	0	1	0	0	1		
Sub Cool [SC]	0	0	1	0	1		
Compressor operation duration (Min)	1	0	1	0	1		
Requested capacity step [Q _{STEP}]	1	1	0	1	1		
Discharge Super Heat [SHd]	1	1	0	0	1		
Compressor running current (A)	1	0	1	0	1		
Capacity setting (Code)	0	1	0	0	1		
Compressor ON/OFF (*100)	0	0	1	0	0		
Compressor accumulated operation hours (*10hours)	1	0	1	0	0		
* U9 error detail history (latest) (Code)	1	1	0	0	1		
Check sum (Code)	1	1	0	1	1		

10ths digit 1: Input current restriction control 1st digit 1: Discharge temp. control 4: Freeze protection control
 2: Compressor current restriction control 2: Condensing temp. control 8: Heat sink temp. control

8-8. FUNCTION OF SWITCHES

PUHZ-W85VHA2.UK PUHZ-W85VHA2-BS.UK

Switch		Function	Selection		Initial setting*	Function details	Effective timing (SW1, 8) / Note (SW6)																		
Mark	No.		ON (with)	OFF (without)																					
SW1	1	Forced defrosting	ON to start	Usual setting	OFF	Switch ON to force defrosting	When compressor is working in heating mode. *1																		
	2	To clear error history	ON to clear	Usual setting	OFF	Switch ON to clear (erase) the followings: (1) Error codes and Suspension flags in RAM (2) Error codes and Suspension flags in EEPROM	Off or operating																		
	3	No function	Do NOT use	PUHZ-W85VHA2	OFF	-	-																		
	4	No function	Do NOT use	PUHZ-W85VHA2	OFF																				
	5	No function	Do NOT use	PUHZ-W85VHA2	OFF																				
	6	No function	Do NOT use	PUHZ-W85VHA2	OFF																				
SW5	1	Max. fan step selection	STEP 9	STEP 8	OFF	Selection of max. fan step at the silent mode	Always																		
	2	Max. frequency selection	Middle level	Low level	OFF	Selection of max. compressor frequency at the silent mode	Always																		
	3	No function	Do NOT use	PUHZ-W85VHA2	OFF	-	-																		
	4	No function	Do NOT use	PUHZ-W85VHA2	OFF																				
SW6	1	Model Setting 1	Do NOT use	PUHZ-W85VHA2	OFF	PCB may be damaged, if switch is ON.	ON for other models																		
	2	Defrost control selection	For high humidity	Standard	OFF	Switch ON to change conditions (standard / high humidity) to start defrosting	-																		
	3-6	Model Setting 2	<table border="1"> <thead> <tr> <th rowspan="2">Model</th> <th colspan="4">SW6</th> <th colspan="2">SW10</th> </tr> <tr> <th>3</th> <th>4</th> <th>5</th> <th>6</th> <th>1</th> <th>2</th> </tr> </thead> <tbody> <tr> <td>W85VHA2</td> <td>1</td> <td>0</td> <td>1</td> <td>1</td> <td>0</td> <td>1</td> </tr> </tbody> </table> 1=ON, 0=OFF		Model	SW6				SW10		3	4	5	6	1	2	W85VHA2	1	0	1	1	0	1	As shown in the left table
Model	SW6					SW10																			
	3	4	5	6	1	2																			
W85VHA2	1	0	1	1	0	1																			
SW10	1,2																								
SW7	1-6	No function	Do NOT use	PUHZ-W85VHA2	OFF	-	-																		
SW8	1	Mode selection	Energy saving mode	Powerful mode	OFF	-	Always																		
	2	No function	Do NOT use	PUHZ-W85VHA2	OFF	-	-																		
	3	Separate Interface/Flow temp. controller-outdoor unit power supplies	Separate power supply	Outdoor unit power supply	OFF	Power supply connection method selection	When power supply ON																		

<Important Note>

All these dip switches on PUHZ-W85VHA2 are set as shown above.

Spare PCBs, however, will be supplied without any settings, which means that all dip switches are switched OFF.

When servicing, please make sure to set all switches correctly, referring to the previous PCB which is removed from the unit.

*1. Forced defrosting should be done as follows.

- ① Change the DIP SW1-1 on the outdoor controller board from OFF to ON.
- ② Forced defrosting will start by the above operation ① if these conditions written below are satisfied.
 - Heat mode setting
 - 10 minutes have passed since compressor starts operating or previous forced defrosting is finished.
 - Pipe temperature is less than or equal to 8°C.

Forced defrosting will finish if certain conditions are satisfied.

Forced defrosting can be done if above conditions are satisfied when DIP SW1-1 is changed from OFF to ON.

After DIP SW1-1 is changed from OFF to ON, there is no problem if DIP SW1-1 is left ON or changed to OFF again.

This depends on the service conditions.

PUHZ-W85VHA2.UK PUHZ-W85VHA2-BS.UK

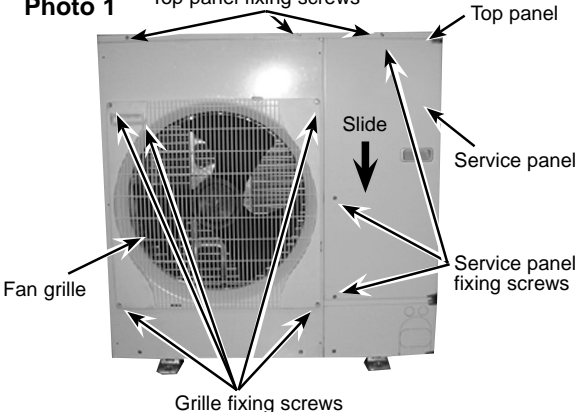
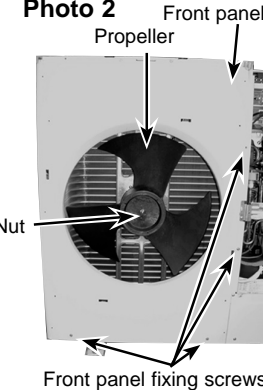
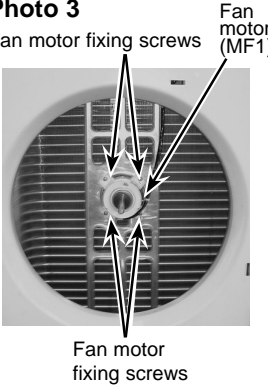
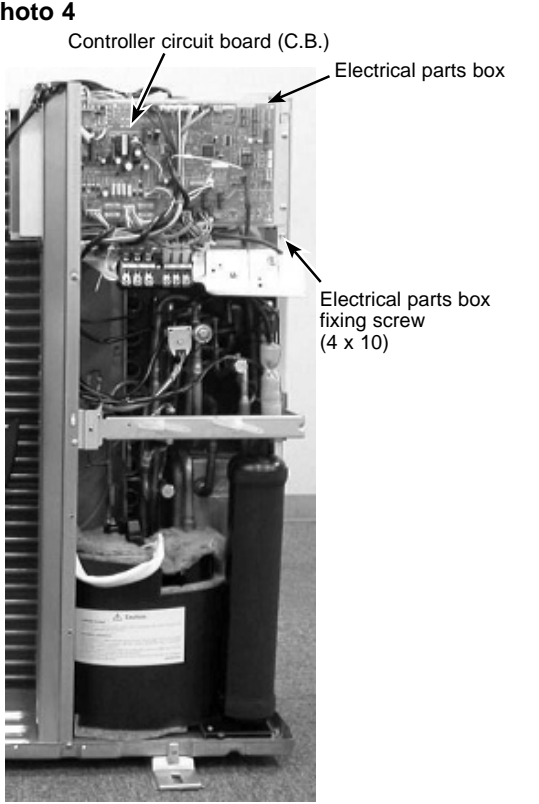
OPERATING PROCEDURE	PHOTOS & ILLUSTRATION
<p>1. Removing the service panel and top panel</p> <p>(1) Remove 3 screws (5 × 10) and slide the hook on the right downward to remove the service panel.</p> <p>(2) Remove screws (3 for front, 3 for rear/5 × 10) of the top panel and remove it.</p>	<p>Photo 1</p> 
<p>2. Removing the fan motor (MF1)</p> <p>(1) Remove the service panel. (See Photo 1.)</p> <p>(2) Remove the top panel. (See Photo 1.)</p> <p>(3) Remove 5 screws (5 × 10) to detach the fan grille. (See Photo 1.)</p> <p>(4) Remove a nut (for right handed screw of M6) to detach the propeller. (See Photo 2.)</p> <p>(5) Disconnect the connector CNF1 on controller circuit board in electrical parts box.</p> <p>(6) Remove 4 screws (5 × 25) to detach the fan motor. (See Photo 3.)</p>	<p>Photo 2</p>  <p>Photo 3</p> 
<p>3. Removing the electrical box</p> <p>(1) Remove the service panel. (See Photo 1.)</p> <p>(2) Remove the top panel. (See Photo 1.)</p> <p>(3) Disconnect the connecting wires from terminal block.</p> <p>(4) Remove all the following connectors from controller circuit board; fan motor, linear expansion valve (×2), thermistor <Liquid pipe>, thermistor <Discharge>, thermistor <Plate HEX Liquid>, thermistor <Outdoor ambient>, high pressure sensor, high pressure switch, 4-way valve and bypass valve. Then remove a screw (4 × 8) from the valve bed to remove the lead wire. Pull out the disconnected wire from the electrical parts box. <Diagram symbol in the connector housing></p> <ul style="list-style-type: none"> • Fan motor (CNF1) • Linear expansion valve (LEV-A and LEV-B) • Thermistor <Liquid pipe> (TH3) • Thermistor <Discharge> (TH4) • Thermistor <Plate HEX Liquid, Outdoor Ambient> (TH7/6) • Thermistor <Inlet water> (TH32) • Thermistor <Comp. shell> (TH33) • High pressure sensor (63HS) • High pressure switch (63H) • Solenoid valve coil <4-way valve> (21S4) • Solenoid valve coil <Bypass valve> (SV2) <p>(5) Remove the terminal cover and disconnect the compressor lead wires.</p> <p>(6) Remove a screw (4 × 10) and detach the electrical parts box by pulling it upward. The electrical parts box is fixed with 2 hooks on the left and 1 hook on the right.</p>	<p>Photo 4</p> 

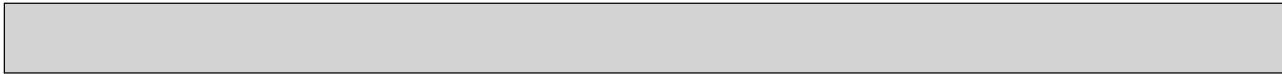

OPERATING PROCEDURE

4. Removing the thermistor <Plate HEX Liquid> (TH6)

- (1) Remove the service panel. (See Photo 1.)
- (2) Remove the top panel. (See Photo 1.)
- (3) Disconnect the connector TH7/6 (red) on the controller circuit board.
- (4) Loosen the clamps for the lead wire.
- (5) Pull out the thermistor <Plate HEX Liquid> (TH6) from the sensor holder.

Note: In case of replacing thermistor <Plate HEX Liquid> (TH6), replace it together with thermistor <Outdoor ambient> (TH7), since they are combined together. Refer to No.5 below to remove thermistor <Outdoor ambient>.

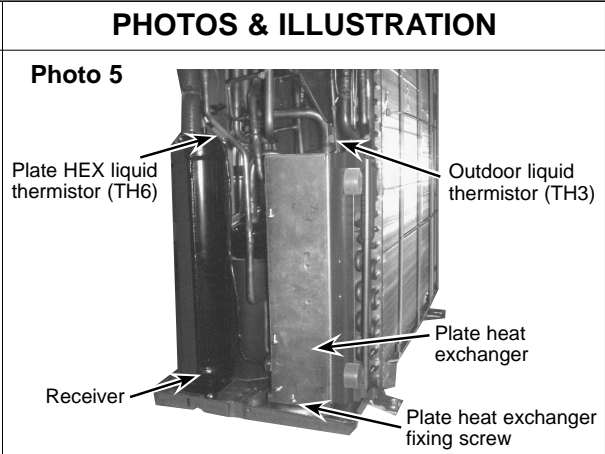

5. Removing the thermistor <Outdoor ambient> (TH7)

- (1) Remove the service panel. (See Photo 1.)
- (2) Remove the top panel. (See Photo 1.)
- (3) Disconnect the connector TH7/6 (red) on the controller circuit board.
- (4) Loosen the clamps for the lead wire.
- (5) Pull out the thermistor <Outdoor ambient> (TH7) from the sensor holder.

Note: In case of replacing thermistor <Outdoor ambient> (TH7), replace it together with thermistor <Plate HEX Liquid> (TH6), since they are combined together. Refer to No.4 above to remove thermistor <Plate HEX Liquid>.

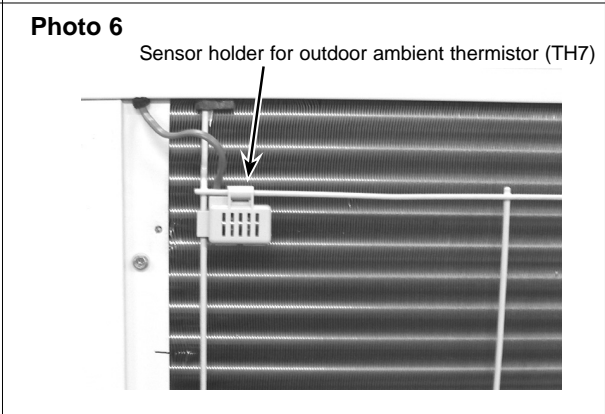

6. Removing the thermistor <Liquid pipe> (TH3) and thermistor <Discharge> (TH4), thermistor <Comp. shell> (TH33)

- (1) Remove the service panel. (See Photo 1.)
- (2) Disconnect the connectors, TH3 (white), TH4 (white), and TH33 (yellow) on the controller circuit board.
- (3) Loosen the clamps for the lead wire.
- (4) Pull out the thermistor <Liquid pipe> (TH3) (See Photo 5.) and thermistor <Discharge> (TH4) from the sensor holder.

[Removing the thermistor <Comp. shell> (TH33)]

- (5) Pull out the thermistor <Comp. shell> (TH33) from the holder of the compressor shell.

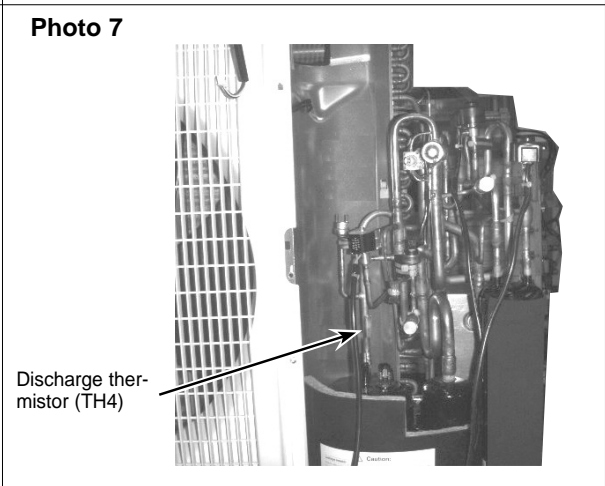

7. Removing the thermistor <Inlet Water> (TH32)

- (1) Remove the service panel. (See Photo 1.)
- (2) Remove 2 screws (5 x 10) and remove the front cover panel.
- (3) Remove 3 stay fixing screws (4 x 10) and remove the stay. Remove 4 right side panel fixing screws (5 x 10) and remove the right side panel.
- (4) Disconnect the connector, TH32 (black) on the controller circuit board.
- (5) Loosen the clamp for the lead wire.
- (6) Remove the thermistor <Inlet water> (TH32) from the plate heat exchanger.

Note: Before removing the thermistor <Inlet water> (TH32), recover water in the plate heat exchanger.

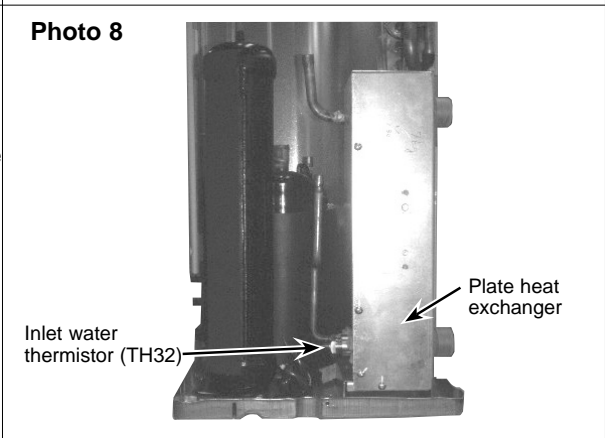

OPERATING PROCEDURE

8. Removing the solenoid valve coil <4-way valve> (21S4) linear expansion valve coil (LEV (A), LEV (B)) and solenoid valve coil <Bypass valve> (SV)

- (1) Remove the service panel. (See Photo 1.)
- (2) Remove the top panel. (See Photo 1.)
- (3) Remove the electrical parts box. (See Photo 4.)
- [Removing the solenoid valve coil <4-way valve>]
- (4) Remove solenoid valve coil <4-way valve> fixing screw (M4 × 6).
- (5) Remove the solenoid valve coil <4-way valve>.
- (6) Disconnect the connector 21S4 (green) on the controller circuit board.
- [Removing the linear expansion valve coil]
- (4) Remove the linear expansion valve coil by sliding the coil upward.
- (5) Disconnect the connectors, LEV A (white) and LEV B (red), on the controller circuit board.
- [Removing the solenoid valve coil <Bypass valve>]
- (4) Remove the solenoid valve coil <Bypass valve> fixing screw (M4 × 6).
- (5) Remove the solenoid valve coil <Bypass valve> by sliding the coil upward.
- (6) Disconnect the connector SV2 (blue) on the controller circuit board.

9. Removing the 4-way valve

- (1) Remove the service panel. (See Photo 1.)
- (2) Remove the top panel. (See Photo 1.)
- (3) Remove the electrical parts box. (See Photo 4.)
- (4) Remove 3 stay fixing screws (4 × 10) and remove the stay.
- (5) Remove 3 right side panel fixing screw (5 × 10) in the rear of the unit and remove the right side panel.
- (6) Remove the solenoid valve coil <4-way valve>. (See Photo 9.)
- (7) Recover refrigerant.
- (8) Remove the welded part of 4-way valve.

Note 1: Recover refrigerant without letting it out in the air.

Note 2: The welded part can be removed easily by removing the right side panel.

Note 3: When installing the 4-way valve, make sure to cover it with a wet cloth to prevent it from heating (120°C or more), then braze the pipes so that the inside of pipes are not oxidized.

10. Removing linear expansion valve

- (1) Remove the service panel. (See Photo 1.)
- (2) Remove the top panel. (See Photo 1.)
- (3) Remove the electrical parts box. (See Photo 4.)
- (4) Remove 3 stay fixing screws (4 × 10) and remove the stay.
- (5) Remove 3 right side panel fixing screw (5 × 10) in the rear of the unit and then remove the right side panel.
- (6) Remove the linear expansion valve.
- (7) Recover refrigerant.
- (8) Remove the welded part of linear expansion valve.

Note 1: Recover refrigerant without spreading it in the air.

Note 2: The welded part can be removed easily by removing the back panel.

Note 3: When installing the linear expansion valve, cover it with a wet cloth to prevent it from heating (120 °C or more), then braze the pipes so that the inside of pipes are not oxidized.

PHOTOS & ILLUSTRATION

Photo 9

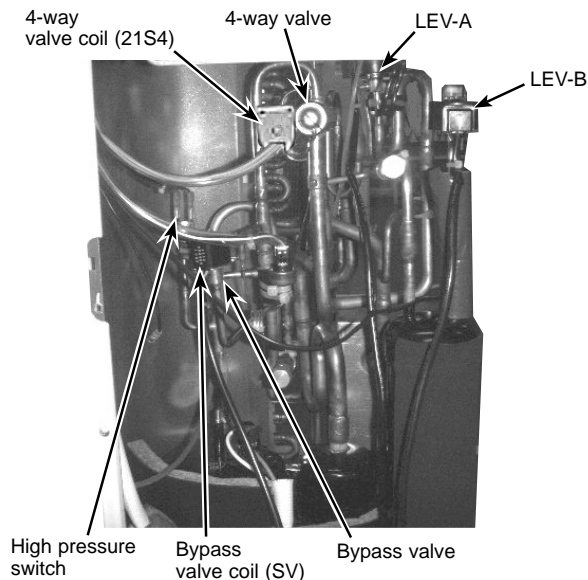
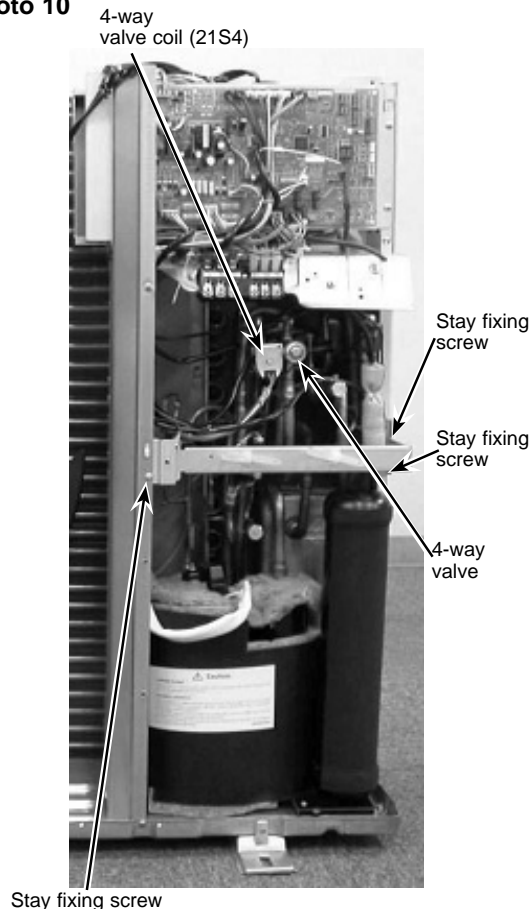
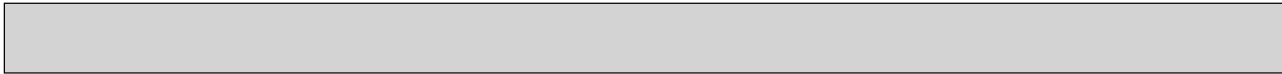

Photo 10





OPERATING PROCEDURE

11. Removing the bypass valve

- (1) Remove the service panel. (See Photo 1.)
- (2) Remove the top panel. (See Photo 1.)
- (3) Remove the electrical parts box. (See Photo 4.)
- (4) Remove 3 right side panel fixing screws (5 × 10) in the rear of the unit and remove the right side panel.
- (5) Remove the bypass valve solenoid coil.
- (6) Recover refrigerant.
- (7) Remove the welded part of bypass valve.

Note 1: Recover refrigerant without letting it out in the air.
Note 2: The welded part can be removed easily by removing the right side panel.
Note 3: When installing the bypass valve, make sure to cover it with a wet cloth to prevent it from heating (120°C or more), then braze the pipes so that the inside of pipes are not oxidized.

12. Removing the high pressure switch (63H)

- (1) Remove the service panel. (See Photo 1.)
- (2) Remove the top panel. (See Photo 1.)
- (3) Remove the electrical parts box. (See Photo 4.)
- (4) Remove 3 right side panel fixing screws (5 × 10) in the rear of the unit and remove the right side panel.
- (5) Pull out the lead wire of high pressure switch.
- (6) Recover refrigerant.
- (7) Remove the welded part of high pressure switch.

Note 1: Recover refrigerant without letting it out in the air.
Note 2: The welded part can be removed easily by removing the right side panel.
Note 3: When installing the high pressure switch, make sure to cover it with a wet cloth to prevent it from heating (100°C or more), then braze the pipes so that the inside of pipes are not oxidized.

13. Removing the high pressure sensor (63HS)

- (1) Remove the service panel. (See Photo 1.)
- (2) Remove the top panel. (See Photo 1.)
- (3) Remove the electrical parts box. (See Photo 4.)
- (4) Remove 3 right side panel fixing screws (5 × 10) in the rear of the unit and remove the right side panel.
- (5) Pull out the lead wire of high pressure sensor.
- (6) Recover refrigerant.
- (7) Remove the welded part of high pressure sensor.

Note 1: Recover refrigerant without letting it out in the air.
Note 2: The welded part can be removed easily by removing the right side panel.
Note 3: When installing the high pressure sensor, make sure to cover it with a wet cloth to prevent it from heating (100°C or more), then braze the pipes so that the inside of pipes are not oxidized.

PHOTOS & ILLUSTRATION

Photo 11

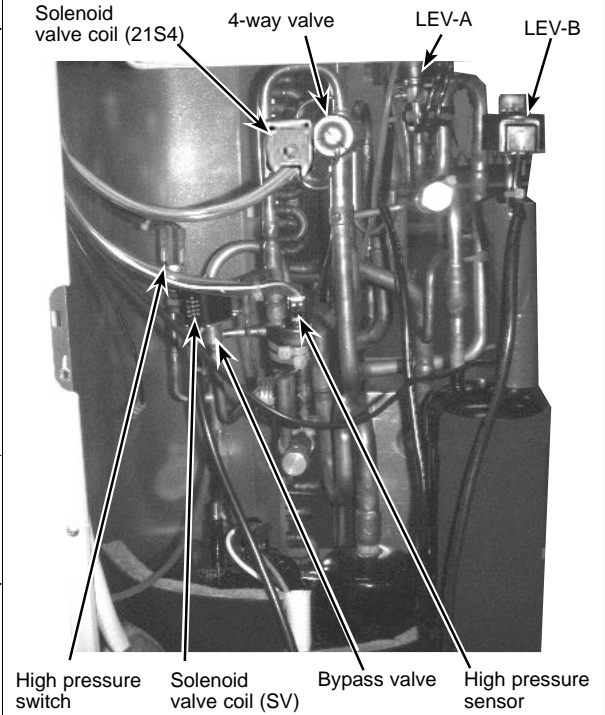

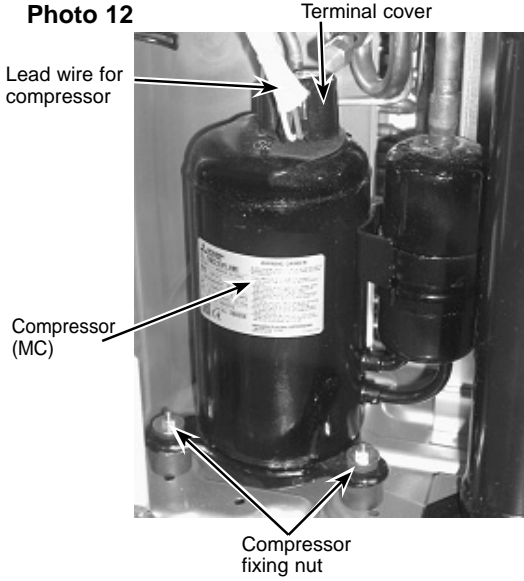
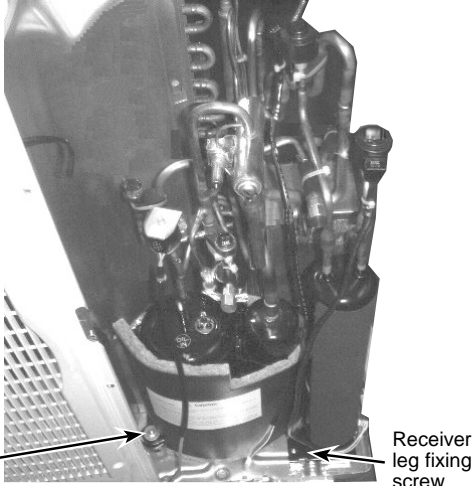
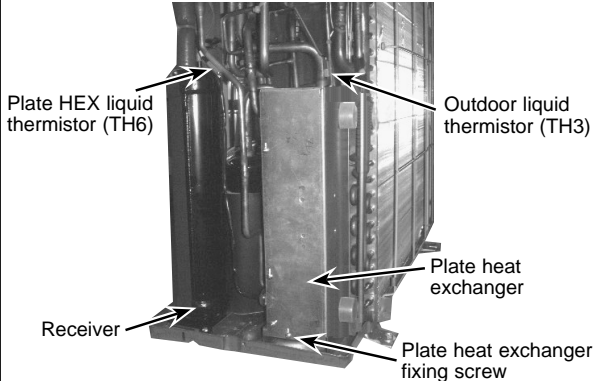

OPERATING PROCEDURE	PHOTOS & ILLUSTRATION
<p>14. Removing the compressor (MC)</p> <ol style="list-style-type: none"> (1) Remove the service panel. (See Photo 1.) (2) Remove the top panel. (See Photo 1.) (3) Remove 2 screws (5 × 10) and remove the front cover panel. (4) Remove 2 screws (5 × 10) and remove the back cover panel. (5) Remove the electrical parts box. (See Photo 4.) (6) Remove 3 screws (4 × 10) and remove the stay. (See Photo 10.) (7) Remove 3 screws (5 × 10) in the rear of the unit and remove the right side panel. (8) Remove 5 screws (1:4 × 10 4:5 × 10) and remove the front panel. (9) Remove 3 screws (4 × 10) and remove the separator. (10) Remove the terminal cover and remove the lead wire for compressor. (11) Remove the soundproof cover for compressor. (12) Recover refrigerant. (13) Remove the 3 points of the compressor fixing nut using a spanner or a adjustable wrench. (14) Remove the welded pipe of the compressor, then remove the compressor. <p>Note 1: Recover refrigerant without letting it out in the air.</p>	<p>Photo 12</p> 
<p>15. Removing the receiver</p> <ol style="list-style-type: none"> (1) Remove the service panel. (See Photo 1.) (2) Remove the top panel. (See Photo 1.) (3) Remove 2 screws (5 × 10) and remove the front cover panel. (4) Remove 2 screws (5 × 10) and remove the back cover panel. (5) Remove the electrical parts box. (See Photo 4.) (6) Remove 3 screws (4 × 10) and remove the stay. (See Photo 10.) (7) Remove 3 screw (5 × 10) in the rear of the unit and remove the right side panel. (8) Recover the refrigerant. (9) Remove 2 welded pipes of receiver. (10) Remove 2 receiver leg fixing screws (4 × 10), then remove the receiver. <p>Note 1: Recover refrigerant without letting it out in the air.</p>	<p>Photo 13</p> 
<p>16. Removing the plate heat exchanger</p> <ol style="list-style-type: none"> (1) Remove the service panel. (See Photo 1.) (2) Remove the top panel. (See Photo 1.) (3) Remove 2 screws (5 × 10) and remove the front cover panel. (4) Remove 2 screws (5 × 10) and remove the back cover panel. (5) Remove the electrical parts box. (See Photo 4.) (6) Remove 3 screws (4 × 10) and remove the stay. (See Photo 10.) (7) Remove 3 screw (5 × 10) in the rear of the unit and remove the right side panel. (8) Recover the refrigerant (9) Remove 2 welded pipes of plate heat exchanger inlet and outlet. (10) Remove 2 plate heat exchanger fixing screws (4 × 10), then remove the plate heat exchanger. <p>Note 1: Recover refrigerant without letting it out in the air.</p> <p>Note 2: Before removing the thermistor <Inlet water> (TH32), recover water in the plate heat exchanger.</p>	<p>Photo 14</p> 

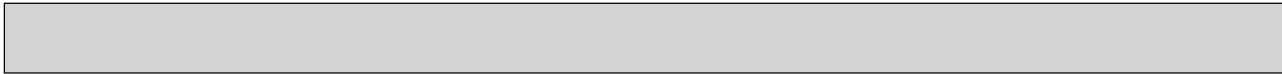

OPERATING PROCEDURE

17. Removing the controller circuit board (C.B.): Figure 1
 (1) Remove all lead wire connectors on controller circuit board (C.B.). CNF1, CNDC, CNAC, CN2, CN4, CN52C, 21S4, SV2, 63H, 63HS, LEV-A, LEV-B, TH32, TH7/6, TH3, TH4
 (2) Remove controller circuit board from the C.B. base. (5 supports)

18. Removing the noise filter circuit board (N.F.): Figure 1, Photo 15
 (1) Remove E2, CN5, LO, NO lead wire connectors from noise filter circuit board (N.F.).
 (2) Remove E1 lead wire connector from electrical parts box.
 (3) Remove L, N lead wire connectors from terminal block (TB1).
 (4) Remove 4 screws (4 x 10) for fixing the C.B. base and detach the C.B. base from the electrical parts box.
 (5) Remove CNAC1, CNAC2, E1, LI, NI lead wire connectors from noise filter circuit board (N.F.).
 (6) Remove noise filter circuit board from the C.B. base. (11 supports)

19. Removing the power circuit board (P.B.) : Figure 1, Photo 16
 (1) Remove CN2, CN4, CNDC lead wire connectors from controller circuit board (C.B.).
 (2) Remove LO, NO, CN5 lead wire connectors from noise filter circuit board (N.F.).
 (3) Remove 4 screws (4 x 10) for fixing the C.B. base and detach the C.B. base from the electrical parts box.
 (4) Remove all lead wire connectors on power circuit board (P.B.). CNAF, CN2, CN3, CN5, CN4, CNDC TABU, TABV, TAVW, TABT, TABS, TABP1, TABN1, TABN2
 (5) Remove power circuit board from the electrical parts box. (3 supports and 4 screws (2 screws (3 x 12) + 2 screws (4 x 18))

20. Removing the active filter module (ACTM): Figure 1, Photo 16
 (1) Remove CN2, CN4, CNDC lead wire connectors from controller circuit board (C.B.).
 (2) Remove LO, NO, CN5 lead wire connectors from noise filter board (N.F.).
 (3) Remove 4 screws (4 x 10) for fixing the C.B. base and detach the C.B. base from the electrical parts box.
 (4) Remove all lead wires on active filter module (ACTM). L1, L2, P, Io, +, -, CNAF (4 wires)
 (5) Remove the active filter module (ACTM) from the electrical parts box. (2 screws (4 x 14))

21. Removing the reactor (DCL): Figure 1, Figure 2
 (1) Remove 4 reactor fixing screws (4 x 10) to detach the reactor (DCL).
 (2) Disconnect L1, L2 lead wire from active filter module (ACTM). Remove reactor wire from wire support.

22. Removing the thermistor <HEATSINK> (TH8): Photo 16
 (1) Remove CN2, CN4, CNDC lead wire connectors from controller circuit board (C.B.).
 (2) Remove LO, NO, CN5 lead wire connectors from noise filter circuit board (N.F.).
 (3) Remove 4 screws (4 x 10) for fixing the C.B. base and detach the C.B. base from the electrical parts box.
 (4) Remove all lead wire connectors on power circuit board (P.B.). CNAF, CN2, CN3, CN5, CN4, CNDC TABU, TABV, TAVW, TABT, TABS, TABP1, TABN1, TABN2
 (5) Remove power circuit board from the electrical parts box. (3 supports and 4 screws (2 screws (3 x 12) + 2 screws (4 x 18))
 (6) Remove the thermistor <HEATSINK> from the electrical parts box. (1 screw (3 x 12))

PHOTOS & ILLUSTRATION

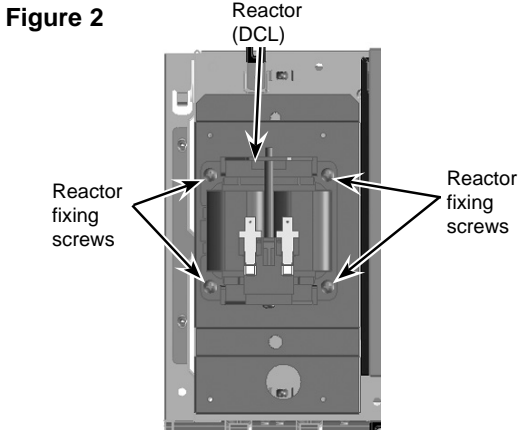
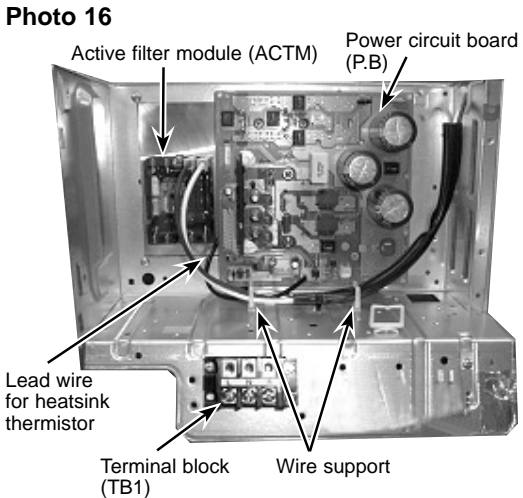
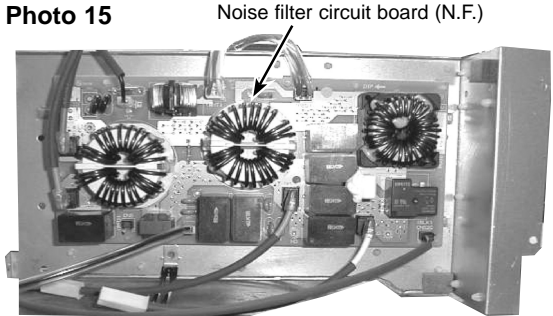
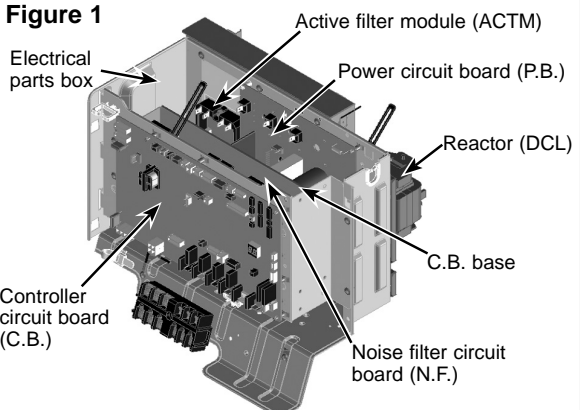



HEAD OFFICE : TOKYO BLDG., 2-7-3, MARUNOUCHI, CHIYODA-KU, TOKYO 100-8310, JAPAN

©Copyright 2009 MITSUBISHI ELECTRIC ENGINEERING CO., LTD.
Distributed in Aug. 2009 No. OCH465 PDF 6
Made in Japan

New publication, effective Aug. 2009
Specifications subject to change without notice