

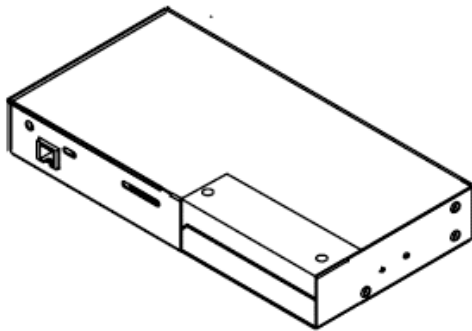

# Mitsubishi Electric Air-conditioner Network System

**Central Controller**  
**Model: GB-50A**

*Instruction Book*



## Contents

1. Safety .....	1
2. Introduction .....	3
3. Function .....	4
4. External input/output function .....	8

Before using the controller, please read this Instruction Book carefully to ensure correct operation. Store this Instruction Book in a location that is easy to find.



# 1 Safety

Please take a moment to review these safety precautions. They are provided for your protection and to prevent damage to the controller.

This safety information applies to all operators and service personnel.

After you have read this manual, always observe the procedures described in the explanations and store it with the installation manual in a location that is easy to find. If the controller is going to be operated by another person, make sure that this manual is given to them.

## Symbols and Terms

 <b>WARNING</b>	Incorrect handling can result in death, serious injury, etc.
 <b>CAUTION</b>	Incorrect handling can result in injury or damage to the building or its contents.

## Specific Precautions

 <b>WARNING</b>	
<p><b>Ask your dealer or technical representative to install.</b> If incorrect installation is done by a customer, it may cause an electric shock, fire, etc.</p>	<p><b>Do not move and re-install the controller by yourself.</b> If installation is incorrect, it may cause an electric shock, fire, etc. Ask your dealer or technical representative.</p>
<p><b>Securely install in a place which can withstand the weight of the controller.</b> If it is not enough, the unit may fall and cause an injury.</p>	<p><b>Contact your dealer if the controller will not be used any more or will be scrapped.</b></p>
<p><b>Make sure that the controller is connected to a rated power supply.</b> If the controller is not connected to a rated power supply, it may cause a fire or damage to the controller.</p>	<p><b>Do not remodel or repair by yourself.</b> If the controller is redesigned or repair is not correct, it may cause an electric shock, fire, etc. Consult your dealer if repair is necessary.</p>
<p><b>Never remove the cover during operation.</b> Touching the charged parts of the controller may cause severe burns or other personal injury.</p>	<p><b>Stop the operation immediately and notify your dealer if an error code is displayed or malfunction occurs.</b> Fire or damage may be caused if the controller is operated in this condition</p>
<p><b>Stop the operation if any malfunction occurs.</b> If malfunction occurs (burning smell, etc.) stop the operation and turn off the power supply. Contact your dealer or technical representative immediately. If the controller continues to operate after a malfunction occurs, this may cause damage, electric shock or fire.</p>	

**⚠ CAUTION**

**Do not install the controller in a place where flammable gas could leak.**

If gas leaks and collects around the unit, it may cause a fire or explosion.

**Do not wash this controller with water.**

It may cause an electric shock or malfunction.

**Do not touch the switch with wet hands.**

It may cause an electric shock.

**Operate the controller within the specified temperature range.**

Observe the specified temperature range when operating the controller. If the controller is used outside the specified temperature range, it may cause serious damage. Be sure to check the operation temperature range in the operation manual.

**Do not apply insecticide or flammable sprays to the controller.**

Do not place flammable spray near the controller and make sure it does not blow directly on the controller as this may cause a fire.

**Do not use the controller in special environments.**

The performance may be reduce or parts may be damaged if the controller is used in locations subject to large quantities of oil (including machine oil), steam, sulfide gas.

**Do not touch the switches with sharp objects.**

It may cause an electric shock or malfunction.

**Do not use the controller for special applications.**

This product is designed for use with the MITSUBISHI ELECTRIC BUILDING AIR CONDITIONING CONTROL SYSTEM. Do not use the system for other air condition management operation or applications. It may cause malfunctions.

## 2-1. About this manual

This manual covers the settings that can be made or functions that can be displayed only on the GB-50A body.

## 2-2. Monitor and operation of the air conditioners

To monitor and operate the air conditioners, license for “GB-50A License Pack” or “Web Monitor” must be purchased and registered. Purchase the license from the dealer, and register on the Initial Setting Web or on the Web for Monitor and Operation.

Refer to Web Browser Operation Manual for monitor and operation of air conditioners.

The format in which the Web page address for each GB-50A is expressed on the Web browser, as well as the default user name and password are shown below.

**http://[IP address of the GB-50A]/administrator.html**

Note: For example, type `http://192.168.1.1/administrator.html` if the GB-50A IP address is [192.168.1.1].

User	Default user name	Default password
Managers	administrator	admin

### Notes

- With the registration of “GB-50A License Pack,” Web Monitor,” “Annual Schedule,” “Weekly Schedule,” “Sending Error Mail,” and “Maintenance Tool Advanced” functions will be available.
- Consult the dealer for information on other functions that require a license (i.e. “Charge” “Saving Energy Control”).
- Ask the dealer for the Web Browser Operation manual, which covers monitor and operation of air conditioners.
- Initial settings such as making group changes are covered in the Initial Setting Web manual. The format in which the Web page address for each GB-50A is expressed on the Web browser, as well as the default user name and password are shown below.

**http://[IP address of the GB-50A]/g-50/administrator.html**

Note: For example, type “`http://192.168.1.1/g-50/administrator.html`” if the GB-50A IP address is [192.168.1.1].

User	Default user name	Default password
Maintenance user	initial	init

## 3 Function

### Notes

- Refer to the WEB Browser Operation Manual for the operation of GB-50A.
- There are two ways to make the initial settings via LAN: one is to use the initial setting web and the other is to use the initial setting tool. Either can be used to make the settings, although initial setting web has more functions than the initial setting tool.

### 3-1. Specification

Table 3-1 Specification list

Item	Specification
Interface	M-NET : DC30V/24V;0.13/0.15A LAN : Ethernet 10Base-T Input/output :DC12V or 24V (External power supply)
Environmental condition	Temperature      Operating range    0 to 40°C / 32 to 104°F Storage range    -20 to 60°C / -4 to 140°F
	Humidity            30~90%RH (No condensation)
Dimensions	130(H) ×250(W) ×38 (D) mm / 5 <sup>1</sup> / <sub>8</sub> (H) ×9 <sup>7</sup> / <sub>8</sub> (W) × 1 <sup>1</sup> / <sub>2</sub> (D)in
Weight	1.1kg / 2 <sup>1</sup> / <sub>2</sub> lb
Installation Environment	In the control panel box (indoor) *This unit is installed and used in a business office or equivalent environment.
Number of control unit	Indoor unit or independent OA processing unit or LOSSNAY : 50 units maximum (50 groups maximum) Number of units (indoor or independent OA processing unit or LOSSNAY) in one group : 1-16 units *Note Indoor unit, independent OA processing unit and LOSSNAY can not register to the same group. Number of remote controllers in one group : 1-2 Number of system controllers in one group : 0-4 (including the number of remote controller in one group) : 0-3 for groups which have one remote controller. Number of indoor units interlocked with one OA processing unit or LOSSNAY : 0-16 (some types of OA processing unit can only be operated when interlocked to a maximum of 9 units)

### 3-2.Function list

The use of GB-50A requires a license registration. By registering the license, group or block operation of the units on the Web browser will become available. Registration for the license that is required to use various functions can be completed on the license registration page.

Table 3-2 List of Web monitoring function

Item	Content
Start/stop	Switching start/stop collectively or for each group
Operation mode	Switching cool/dry/fan/auto/heat collectively or for each group
Temperature setting	Setting room temperature collectively or for each group Set temperature range   Cool/dry: 19°C-30°C /67°F-87°F Heat:     17°C-28°C /63°F-83°F Auto:     19°C-28°C /67°F-83°F *Note: Preset temperature range varies on different models.
Air velocity	Switching air velocity in 4 steps collectively or for each group.
Air direction	Switching in 4 steps vertically and for swing collectively or for each group (Selectable air direction differs depending on the model)
Start/stop of interlocked equipment (Lossnay)	Switching start (Hi/Lo)/stop collectively or for each group when connecting with interlocked equipment (Lossnay). (However, ventilation mode can not be selected for the interlocked equipment.)
Prohibition of local control	Selecting the items for which local control is prohibited collectively or for each group. (Items include start/stop, operation mode, temperature setting and filter sign.)
Error display	Identifies the unit in trouble and displays the nature of trouble
Filter sign display and reset	Filter sign display can be reset in each group or collectively.
Malfunction history	Malfunction history can be check up to 64 contents in both unit and communication error.
Annual/weekly schedule	Using the annual/weekly schedule function by license registration.
Malfunction e-mail history	E-mail history can be check up to 64 contents.

\* The above specification may be changed depending on the equipment connected or combined.

\* The block setting and the registration of block/group names require the initial setting tool or initial setting web.

\*Without prior notice, the content may be changed.

### 3-3 Setting Functions

Make initial settings with either the Initial Setting Web or Initial Setting Tool.

Table 3-3 List of initial-setting functions

Item	This Unit	Initial Setting Tool	Initial Setting Web	Remarks
M-NET address setting		√	√	The default value is 0.
IP address setting	√ (simple setting)	√	√	The settings of the simple setting have the priority over other settings.
Function selection		√	√	Presence/absence of K transmission converter connection, local operation prohibition setting, and external input mode
Group registration		√	√	
Registration of interlocked operation with the Lossnay unit		√	√	
Switch for start-up mode	√			
Other settings		√	√	Available functions vary depending on the tools.

#### 1) How to set the IP address with dipswitches

IP addresses between 192.168.1.1 and 15 can be set using the 4-pin dip switch on SW2. Set this switch before turning the power on.

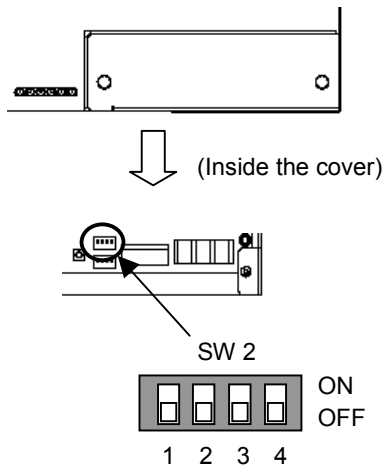

1	2	3	4	Contents (IP address)
OFF	OFF	OFF	OFF	Address that is set with Initial Setting Web or Initial Setting Tool. (Initial IP address setting is 192.168.1.1)
OFF	OFF	OFF	ON	Starts from 192.168.1.1
OFF	OFF	ON	OFF	Starts from 192.168.1.2
OFF	OFF	ON	ON	Starts from 192.168.1.3
OFF	ON	OFF	OFF	Starts from 192.168.1.4
OFF	ON	OFF	ON	Starts from 192.168.1.5
OFF	ON	ON	OFF	Starts from 192.168.1.6
OFF	ON	ON	ON	Starts from 192.168.1.7
ON	OFF	OFF	OFF	Starts from 192.168.1.8
ON	OFF	OFF	ON	Starts from 192.168.1.9
ON	OFF	ON	OFF	Starts from 192.168.1.10
ON	OFF	ON	ON	Starts from 192.168.1.11
ON	ON	OFF	OFF	Starts from 192.168.1.12
ON	ON	OFF	ON	Starts from 192.168.1.13
ON	ON	ON	OFF	Starts from 192.168.1.14
ON	ON	ON	ON	Starts from 192.168.1.15

#### Note

- When setting IP addresses with the Initial Setting Web or the Initial Setting Tool, set all four dipswitches on SW2 to OFF.

## Notes

- When 15 or fewer GB-50A units are used in the designated network for air-conditioning, it is recommended that the IP address be set using SW2 on the unit.
- If the set IP address of GB-50A is forgotten, check the IP address that is registered on the monitoring PC (WEB or TG-2000A). GB-50A can be started by changing the setting of SW2 on GB-50A and using an arbitrary fixed IP address as a temporary IP address. It is recommended to paste a sticker with the IP address on the unit, so that the IP address of GB-50A is available at all times. Once GB-50A is started up with a temporary IP address, a new IP address can be assigned to it on the Initial Setting Web.

## 2) Setting of the service switch

The switches must be OFF for normal use. The switch setting change works when the power is turned on next time.

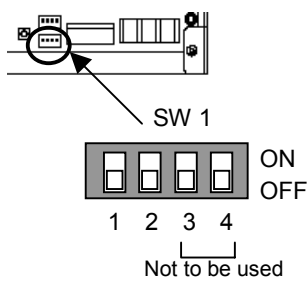

1	2	Contents	Remarks
OFF	OFF	Start up with the normal mode	*This setting is for normal use.
ON	OFF	-	Setting is prohibited.
OFF	ON	-	Setting is prohibited.
ON	ON	Start up with the update mode	*The software can be updated with the normal mode. If the update fails, or the software does not work properly use this setting to update the software again.

\*SW1-3 and SW1-4 are always OFF.

## 3-4 Service LED display

This unit comes with an LED that displays operation status.

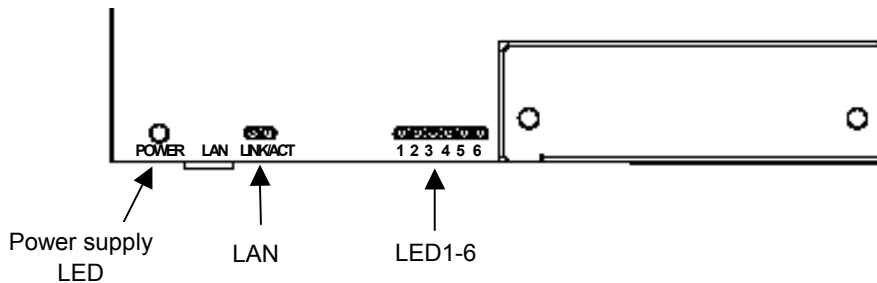

Table 3-4 List of services LED

LED No.	Items	Contents	
Power supply LED	Powering status	ON : Power is supplied	/ OFF: Power is cut off
LAN	LAN LINK	ON : During LINK	/ OFF: No LINK
LAN	LAN ACT	Flicker: During communication	/ OFF: No communication
LED1	Start-up	ON : Start-up not completed	/ OFF: Start-up completed
LED2	Operation ON/OFF	ON : 1 or more units are ON	/ OFF: All OFF
LED3	Error	Flicker: Error occurred on 1 or more units	/ OFF: Normal state
LED4	(not defined)	-	
LED5	(not defined)	-	
LED6	M-NET communication (transmission)	Flicker: During communication	/ OFF: No communication



## 4 External input/output function

\*External signal input requires the external I/O adapter (Model: PAC-YG10HA) sold separately.

### 4-1 External input function

#### (1) The function of external input

- Emergency stop/normal operation, ON/OFF, local remote control prohibit/permit can be controlled for conditioners being controlled with a non-voltage contact signal input from an external input source. (the dip switches)
- The condition of external input signal is displayed on the operation setting screen for each group.

Table 4-1. Function settings of external input

No.	Function of external input signal	Remarks
1	External input signal not used	-----
2	Perform emergency stop with level signal	During emergency stop, only ON/OFF of the central controller and local remote controller's operation will be prohibit.
3	Perform ON/OFF operation with level signal	Only the ON/OFF operation of the central controller and the local remote controller will be prohibit.
4	Perform ON/OFF operation, prohibit/permit operation with pulse signal	Set the pulse width while the contact is ON to 0.5 to 1.0 second.

\*Settings for these functions can be set with the Initial Setting Web or Initial Setting Tool.

#### (2) Level signal and pulse signal

##### ① Level signal



##### ② Pulse signal

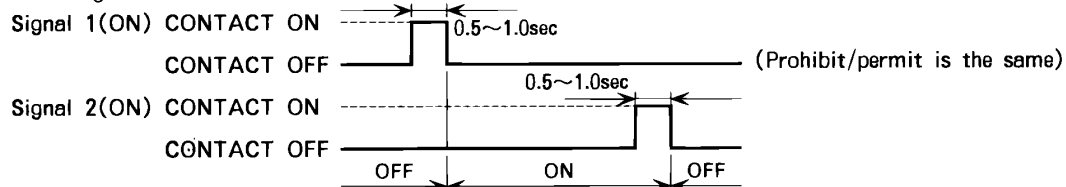

#### (3) Specification of external input interface

CN2	Lead Wire	Emergency stop/normal level signal	ON/OFF level signal	ON/OFF, prohibit/permit pulse signal
No.5	Orange	Emergency stop/normal input	ON/OFF input	ON input
No.6	Yellow	Not used	Not used	OFF input
No.7	Blue	Not used	Not used	Local remote controller prohibit input
No.8	Gray	Not used	Not used	Local remote controller permit input
No.9	Red	Common (DC12V or DC24V)		

**(A) Level signal**

- ① When the level signal is selected, the operation (only ON/OFF operation) for the central controller and the local remote controller are prohibited (except during normal operation).
- ② When the emergency stop/normal operation signal is selected, the status will be changed from normal operation to emergency stop when the external input signal contact turns OFF to ON, and will be changed from emergency stop to normal operation when external input signal contact turns ON to OFF. Emergency stop signal will bring the air conditioners to stop, and canceling the emergency stop will not automatically restart these units. To go back to the previous operation status, they must be manually turned back on.
- ③ When ON/OFF input signal is selected, the status will be changed from OFF to ON when the external input signal contact turns OFF to ON.

**(B) Pulse signal**

- ① Even if the ON signal is input during ON, the status will remain at the ON status.
- ② When the local remote controller is prohibited, the ON/OFF operation, operation mode selection and temperature setting from the local remote controller is prohibited.
- ③ Set the pulse width (contact ON time) to 0.5 to 1.0 second.

**4-2 External output function**

**(1) The function of external output**

- The "ON" signal is output when one or more air conditioner are in the ON operation.
- The "Malfunction" signal is output when one or more air conditioner malfunctions.

**(2) Specification of external output interface**

CN2	Lead wire	Description of each terminal
No. 1	Green	Common (0V)
No. 2	Black	ON/OFF
No. 3	Brown	Malfunction/Normal



This product is designed and intended for use in the residential,  
commercial and light -industrial environment.

The product at hand is  
based on the following  
EU regulations:

- Low Voltage Directive 73/23/EEC
- Electromagnetic Compatibility Directive 89/  
336/EEC

**NOTE:**

This equipment has been tested and found to comply with the limits for a Class B digital device, pursuant to Part 15 of the FCC Rules. These limits are designed to provide reasonable protection against harmful interference in a residential installation. This equipment generates, uses and can radiate radio frequency energy and, if not installed and used in accordance with the instructions, may cause harmful interference to radio communications.

However, there is no guarantee that interference will not occur in a particular installation.

If this equipment does cause harmful interference to radio or television reception, which can be determined by turning the equipment off and on, the user is encouraged to try to correct the interference by one or more of the following measures:

- Reorient or relocate the receiving antenna.
- Increase the separation between the equipment and receiver.
- Connect the equipment into an outlet on a circuit different from that to which the receiver is connected.
- Consult the dealer or an experienced radio / TV technician for help.