

TECHNICAL & SERVICE MANUAL

<Outdoor unit>

[Model Name]	[Service Ref.]
PUMY-SP112VKM	PUMY-SP112VKM.TH
PUMY-SP125VKM	PUMY-SP125VKM.TH
PUMY-SP140VKM	PUMY-SP140VKM.TH
PUMY-SP112YKM	PUMY-SP112YKM.TH
PUMY-SP125YKM	PUMY-SP125YKM.TH
PUMY-SP140YKM	PUMY-SP140YKM.TH

Revision:

- Modified 3. SPECIFICATION in page 9 in REVISED EDITION A.
- Some other descriptions have been also modified.

OCH668 is void

Note:

- This service manual describes technical data of the outdoor units only.

Salt proof model

PUMY-SP112VKM-BS	PUMY-SP112VKM.TH-BS
PUMY-SP125VKM-BS	PUMY-SP125VKM.TH-BS
PUMY-SP140VKM-BS	PUMY-SP140VKM.TH-BS
PUMY-SP112YKM-BS	PUMY-SP112YKM.TH-BS
PUMY-SP125YKM-BS	PUMY-SP125YKM.TH-BS
PUMY-SP140YKM-BS	PUMY-SP140YKM.TH-BS

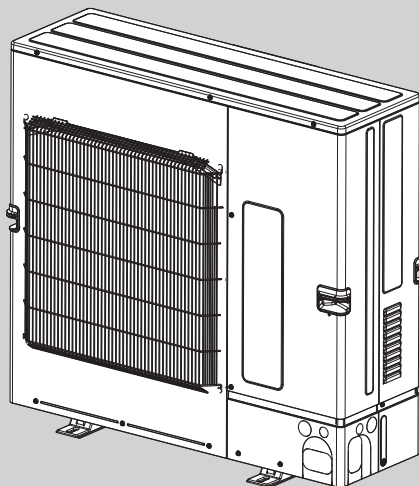

OUTDOOR UNIT

CONTENTS

1. SAFETY PRECAUTION.....	2
2. OVERVIEW OF UNITS.....	5
3. SPECIFICATIONS.....	9
4. DATA.....	11
5. OUTLINES AND DIMENSIONS.....	26
6. WIRING DIAGRAM.....	27
7. NECESSARY CONDITIONS FOR SYSTEM CONSTRUCTION.....	29
8. TROUBLESHOOTING.....	47
9. ELECTRICAL WIRING.....	124
10. REFRIGERANT PIPING TASKS.....	130
11. DISASSEMBLY PROCEDURE.....	137

PARTS CATALOG (OCB668)

1-1. CAUTIONS RELATED TO NEW REFRIGERANT**Caution for units utilizing refrigerant R410A****Use new refrigerant pipes.**

Avoid using thin pipes.

Make sure that the inside and outside of refrigerant piping is clean and it has no contaminants such as sulfur, oxides, dirt, shaving particles, etc, which are hazard to refrigerant cycle. In addition, use pipes with specified thickness.

Contamination inside refrigerant piping can cause deterioration of refrigerant oil, etc.

Store the piping indoors, and both ends of the piping sealed until just before brazing. (Leave elbow joints, etc. in their packaging.)

If dirt, dust or moisture enters into refrigerant cycle, that can cause deterioration of refrigerant oil or malfunction of compressor.

The refrigerant oil applied to flare and flange connections must be ester oil, ether oil or alkylbenzene oil in a small amount.

If large amount of mineral oil enters, that can cause deterioration of refrigerant oil, etc.

Charge refrigerant from liquid phase of gas cylinder.

If the refrigerant is charged from gas phase, composition change may occur in refrigerant and the efficiency will be lowered.

Do not use refrigerant other than R410A.

If other refrigerant (R22, etc.) is used, chlorine in refrigerant can cause deterioration of refrigerant oil, etc.

Use a vacuum pump with a reverse flow check valve.

Vacuum pump oil may flow back into refrigerant cycle and that can cause deterioration of refrigerant oil, etc.

Use the following tools specifically designed for use with R410A refrigerant.

The following tools are necessary to use R410A refrigerant.

Tools for R410A	
Gauge manifold	Flare tool
Charge hose	Size adjustment gauge
Gas leak detector	Vacuum pump adaptor
Torque wrench	Electronic refrigerant charging scale

Handle tools with care.

If dirt, dust or moisture enters into refrigerant cycle, that can cause deterioration of refrigerant oil or malfunction of compressor.

Do not use a charging cylinder.

If a charging cylinder is used, the composition of refrigerant will change and the efficiency will be lowered.

Ventilate the room if refrigerant leaks during operation. If refrigerant comes into contact with a flame, poisonous gases will be released.

Use the specified refrigerant only.

Never use any refrigerant other than that specified.

Doing so may cause a burst, an explosion, or fire when the unit is being used, serviced, or disposed of.

Correct refrigerant is specified in the manuals and on the spec labels provided with our products.

We will not be held responsible for mechanical failure, system malfunction, unit breakdown or accidents caused by failure to follow the instructions.

[1] Cautions for service

- (1) Perform service after recovering the refrigerant left in unit completely.
- (2) Do not release refrigerant in the air.
- (3) After completing service, charge the cycle with specified amount of refrigerant.
- (4) If moisture or foreign matter might have entered the refrigerant piping during service, ensure to remove them.

[2] Additional refrigerant charge

When charging directly from cylinder

- (1) Check that cylinder for R410A on the market is a syphon type.
- (2) Charging should be performed with the cylinder of syphon stood vertically. (Refrigerant is charged from liquid phase.)

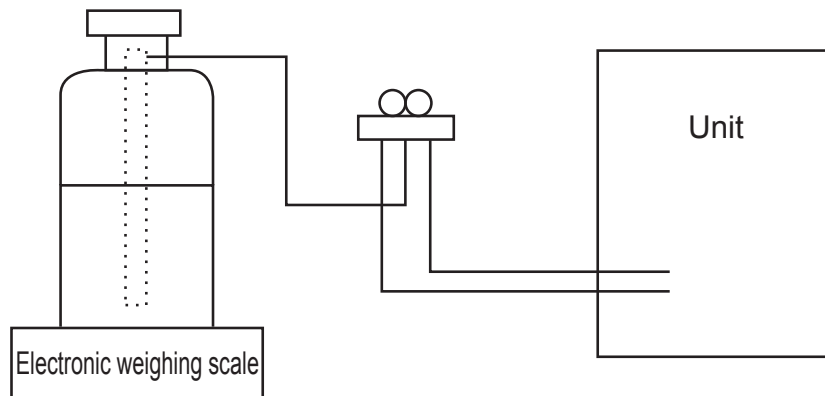

[3] Service tools

Use the below service tools as exclusive tools for R410A refrigerant.

No.	Tool name	Specifications
①	Gauge manifold	· Only for R410A
		· Use the existing fitting specifications. (UNF1/2)
		· Use high-tension side pressure of 5.3MPa·G or over.
②	Charge hose	· Only for R410A
		· Use pressure performance of 5.09MPa·G or over.
③	Electronic weighing scale	—
④	Gas leak detector	· Use the detector for R134a, R407C or R410A.
⑤	Adaptor for reverse flow check	· Attach on vacuum pump.
⑥	Refrigerant charge base	—
⑦	Refrigerant cylinder	· Only for R410A · Top of cylinder (Pink)
		· Cylinder with syphon
⑧	Refrigerant recovery equipment	—

1-2. PRECAUTIONS FOR SALT PROOF TYPE "-BS" MODEL

Although "-BS" model has been designed to be resistant to salt damage, observe the following precautions to maintain the performance of the unit.

- (1) Avoid installing the unit in a location where it will be exposed directly to seawater or sea breeze.
- (2) If the cover panel may become covered with salt, be sure to install the unit in a location where the salt will be washed away by rainwater. (If a sunshade is installed, rainwater may not clean the panel.)
- (3) To ensure that water does not collect in the base of the outdoor unit, make sure that the base is level, not at angle. Water collecting in the base of the outdoor unit could cause rust.
- (4) If the unit is installed in a coastal area, clean the unit with water regularly to remove any salt build-up.
- (5) If the unit is damaged during installation or maintenance, be sure to repair it.
- (6) Be sure to check the condition of the unit regularly.
- (7) Be sure to install the unit in a location with good drainage.

Cautions for refrigerant piping work

New refrigerant R410A is adopted for replacement inverter series. Although the refrigerant piping work for R410A is same as for R22, exclusive tools are necessary so as not to mix with different kind of refrigerant. Furthermore as the working pressure of R410A is 1.6 times higher than that of R22, their sizes of flared sections and flare nuts are different.

① Thickness of pipes

Because the working pressure of R410A is higher compared to R22, be sure to use refrigerant piping with thickness shown below. (Never use pipes of 0.7 mm or below.)

Diagram below: Piping diameter and thickness

Nominal dimensions (in)	Outside diameter (mm)	Thickness (mm)	
		R410A	R22
1/4	6.35	0.8	0.8
3/8	9.52	0.8	0.8
1/2	12.70	0.8	0.8
5/8	15.88	1.0	1.0
3/4	19.05	—	1.0

② Dimensions of flare cutting and flare nut

The component molecules in HFC refrigerant are smaller compared to conventional refrigerants. In addition to that, R410A is a refrigerant, which has higher risk of leakage because its working pressure is higher than that of other refrigerants. Therefore, to enhance airtightness and strength, flare cutting dimension of copper pipe for R410A has been specified separately from the dimensions for other refrigerants as shown below. The dimension B of flare nut for R410A also has partly been changed to increase strength as shown below. Set copper pipe correctly referring to copper pipe flaring dimensions for R410A below. For 1/2 and 5/8 inch pipes, the dimension B changes.

Use torque wrench corresponding to each dimension.

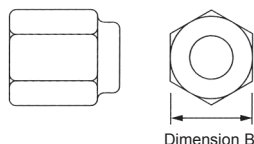
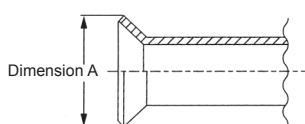

Flare cutting dimensions

Nominal dimensions (in)	Outside diameter (mm)	Dimension A ($^{+0.4}_{-0.4}$) (mm)	
		R410A	R22
1/4	6.35	9.1	9.0
3/8	9.52	13.2	13.0
1/2	12.70	16.6	16.2
5/8	15.88	19.7	19.4
3/4	19.05	—	23.3

Flare nut dimensions

Nominal dimensions (in)	Outside diameter (mm)	Dimension B (mm)	
		R410A	R22
1/4	6.35	17.0	17.0
3/8	9.52	22.0	22.0
1/2	12.70	26.0	24.0
5/8	15.88	29.0	27.0
3/4	19.05	—	36.0

③ Tools for R410A (The following table shows whether conventional tools can be used or not.)

Tools and materials	Use	R410A tools	Can R22 tools be used?	Can R407C tools be used?
Gauge manifold	Air purge, refrigerant charge and operation check	Tool exclusive for R410A	×	×
Charge hose	Gas leak check	Tool exclusive for R410A	×	×
Gas leak detector	Refrigerant recovery	Tool for HFC refrigerant	×	○
Refrigerant recovery equipment	Refrigerant charge	Tool exclusive for R410A	×	×
Refrigerant cylinder	Apply to flared section	Tool exclusive for R410A	×	×
Applied oil	Prevent compressor malfunction when charging refrigerant by spraying liquid refrigerant	Ester oil, ether oil and alkylbenzene oil (minimum amount)	×	Ester oil, ether oil: ○ Alkylbenzene oil: minimum amount
Safety charger	Prevent gas from blowing out when detaching charge hose	Tool exclusive for R410A	×	×
Charge valve	Vacuum drying and air purge	Tools for other refrigerants can be used if equipped with adopter for reverse flow check	△ (Usable if equipped with adopter for reverse flow)	△ (Usable if equipped with adopter for reverse flow)
Vacuum pump	Flaring work of piping	Tools for other refrigerants can be used by adjusting flaring dimension	△ (Usable by adjusting flaring dimension)	△ (Usable by adjusting flaring dimension)
Flare tool	Bend the pipes	Tools for other refrigerants can be used	○	○
Bender	Cut the pipes	Tools for other refrigerants can be used	○	○
Pipe cutter	Weld the pipes	Tools for other refrigerants can be used	○	○
Welder and nitrogen gas cylinder	Refrigerant charging	Tools for other refrigerants can be used	○	○
Refrigerant charging scale	Check the degree of vacuum. (Vacuum valve prevents back flow of oil and refrigerant to thermistor vacuum gauge)	Tools for other refrigerants can be used	○	○
Vacuum gauge or thermistor vacuum gauge and vacuum valve	Refrigerant charge	Tool exclusive for R410A	×	—
Charging cylinder				

× : Prepare a new tool. (Use the new tool as the tool exclusive for R410A.)

△ : Tools for other refrigerants can be used under certain conditions.

○ : Tools for other refrigerants can be used.

2-1. UNIT CONSTRUCTION

Outdoor unit		4.5HP		5HP		6HP		
		PUMY-SP112VKM.TH(-BS) PUMY-SP112YKM.TH(-BS)		PUMY-SP125VKM.TH(-BS) PUMY-SP125YKM.TH(-BS)		PUMY-SP140VKM.TH(-BS) PUMY-SP140YKM.TH(-BS)		
Applicable indoor unit	Capacity	Type 15 to Type 140						
	Number of units	1 to 9 units		1 to 10 units		1 to 12 units		
	Total system wide capacity	50 to 130% of outdoor unit capacity *1						

	CMY-Y62-G-E	CMY-Y64-G-E	CMY-Y68-G-E
Branching pipe components	Branch header (2 branches)	Branch header (4 branches)	Branch header (8 branches)

Model Capacity	Cassette Ceiling					Ceiling concealed	Wall Mounted	Ceiling Suspended	Floor standing		Ceiling concealed		Lossnay	CONNECTION KIT PAC-LV11M-J
	2 by 2	4-way flow	2-way flow	1-way flow					Exposed	Concealed	Fresh air*2	Built-in		
	PLFY-P	PLFY-P	PLFY-EP*6	PLFY-P	PMFY-P	PEFY-P	PKFY-P	PCFY-P	PFFY-P	PFFY-P	PEFY-P	PDFY-P	GU*4	
15	15VFM-E1	-	-	-	-	15VMS1(L)-E	15VBM-E	-	-	-	-	-	-	
20	20VFM-E1	20VEM-E	-	20VLMD-E	20VBM-E	20VMS1(L)-E 20VMA(L)-E 20VMR-E-L/R	20VBM-E	-	20VLEM-E 20VKM-E(2)	20VLRM-E 20VLRMM-E	-	20VM-E	-	
25	25VFM-E1	25VEM-E	-	25VLMD-E	25VBM-E	25VMS1(L)-E 25VMA(L)-E 25VMR-E-L/R 25VMA3-E*5	25VBM-E	-	25VLEM-E 25VKM-E(2)	25VLRM-E 25VLRMM-E	-	25VM-E	-	
32	32VFM-E1	32VEM-E	-	32VLMD-E	32VBM-E	32VMS1(L)-E 32VMA(L)-E 32VMR-E-L/R 32VMA3-E*5	32VHM-E	-	32VLEM-E 32VKM-E(2)	32VLRM-E 32VLRMM-E	-	32VM-E	-	
40	40VFM-E1	40VEM-E	-	40VLMD-E	40VBM-E	40VMS1(L)-E 40VMA(L)-E 40VMH(S)-E 40VMA3-E*5	40VHM-E	40VKM-E	40VLEM-E 40VKM-E(2)	40VLRM-E 40VLRMM-E	-	40VM-E	-	M series indoor unit *3 MSZ-GE Series MSZ-SF Series MSZ-EF Series MSZ-FH Series MSZ-LN Series
50	50VFM-E1	50VEM-E	50VEM-E	50VLMD-E	-	50VMS1(L)-E 50VMA(L)-E 50VMH(S)-E	50VHM-E	-	50VLEM-E	50VLRM-E 50VLRMM-E	-	50VM-E	50RD(H)4	
63	-	63VEM-E	63VEM-E	63VLMD-E	-	63VMS1(L)-E 63VMA(L)-E 63VMH(S)-E	63VKM-E	63VKM-E	63VLEM-E	63VLRM-E 63VLRMM-E	-	63VM-E	-	
71	-	-	-	-	-	71VMA(L)-E 71VMH(S)-E	-	-	-	-	-	71VM-E	-	
80	-	80VEM-E	80VEM-E	80VLMD-E	-	80VMA(L)-E 80VMH(S)-E	-	-	-	-	80VMH-E-F	80VM-E	-	
100	-	100VEM-E	-	100VLMD-E	-	100VMA(L)-E 100VMH(S)-E	100VKM-E	100VKM-E	-	-	-	100VM-E	100RD(H)4	
125	-	125VEM-E	-	125VLMD-E	-	125VMA(L)-E 125VMH(S)-E	-	125VKM-E	-	-	-	125VM-E	-	
140	-	-	-	-	-	140VMA(L)-E 140VMH(S)-E	-	-	-	-	140VMH-E-F	-	-	

Decorative panel

M series remote controller

Remote controller	Name	M-NET remote controller	MA remote controller
	Model number	PAR-F27MEA-E, PAR-U02MEDA	PAR-21MAA, PAR-31/32MAA
	Functions	<ul style="list-style-type: none"> A handy remote controller for use in conjunction with the Melans centralized management system. Addresses must be set. 	<ul style="list-style-type: none"> Addresses setting is not necessary.

*1 When the indoor unit of Fresh Air type is connected with the outdoor unit, the maximum connectable total indoor unit capacity is 110%.

*2 PUMY is connectable to Fresh Air type indoor unit.

It is possible to connect 1 Fresh Air type indoor unit to 1 outdoor unit. (1:1 system)

Operating temperature range (outdoor temperature) for fresh air type indoor units differ from other indoor units.

Refer to "2-4-(3). Operating temperature range".

*3 When connecting the CONNECTION KIT (PAC-LV11M-J) and an M-series indoor unit, refer to the installation manual for the CONNECTION KIT.

*4 Do not connect Lossnay remote controller(s). (PZ-61DR-E, PZ-60DR-E, PZ-52SF-E, PZ-43SMF-E)

*5 Authorized connectable indoor units are as follows;

PUMY-SP112:PEFY-P25VMA3-E×2 + PEFY-P32VMA3-E×2

PUMY-SP125: PEFY-P25VMA3-E×1 + PEFY-P32VMA3-E×3

PUMY-SP140: PEFY-P32VMA3-E×2 + PEFY-P40VMA3-E×2

*6 For the PLFY-EP/VE-M-E, up to 2 units can be connected. Other indoor units (Excluding the PEFY-P/ VMA3-E and PEFY-P/ VMH-EF) can be connected within the total rated capacity and maximum number of connected units.

2-2. UNIT CONSTRUCTION (BRANCH BOX SYSTEM)

Outdoor unit		4.5HP	5HP	6HP
		PUMY-SP112VKM.TH(-BS) PUMY-SP112YKM.TH(-BS)	PUMY-SP125VKM.TH(-BS) PUMY-SP125YKM.TH(-BS)	PUMY-SP140VKM.TH(-BS) PUMY-SP140YKM.TH(-BS)
Applicable indoor unit	Capacity	kW unit: Type 15 to Type 100		
	Number of units	2 to 8 units		
	Total system wide capacity	50 to 130% of outdoor unit capacity (6.3 to 16.2 kW)	50 to 130% of outdoor unit capacity (7.1 to 18.2 kW)	50 to 130% of outdoor unit capacity (8.0 to 20.2 kW)
Branch box that can be connected	Number of units	1 to 2 units		



Model capacity [kW type]	Wall Mounted						1-way ceiling cassette	4-way ceiling cassette		Ceiling concealed			Ceiling suspended	
	MSZ-FH	MSZ-LN	MSZ-GF	MSZ-SF	MSZ-EF	MSZ-SF		2 by 2 type	Standard	Low static pressure	Middle static pressure		PCA-RP	PCA-M
	MLZ-KA	SLZ-KF	PLA-RP	SEZ-KD	PEAD-RP	PEAD-M	PCA-RP	PCA-M						
15	-	-	-	-	-	15VA	-	-	-	-	-	-	-	-
18	-	-	-	-	18VE3	-	-	-	-	-	-	-	-	-
20	-	-	-	-	-	20VA	-	-	-	-	-	-	-	-
22	-	-	-	-	22VE3	-	-	-	-	-	-	-	-	-
25	25VE2	25VG	-	25VE3	25VE3	-	25VA	25VA2	-	25VAQ(L)	-	-	-	-
35	35VE2	35VG	-	35VE3	35VE3	-	35VA	35VA2	35EA	35VAQ(L)	-	-	35KAQ	35KA
42	-	-	-	42VE3	42VE3	-	-	-	-	-	-	-	-	-
50	50VE2	-	-	50VE3	50VE3	-	50VA	50VA2	50EA	50VAQ(L)	50JAQ(L)	50JA(L)	50KAQ	50KA
60	-	-	60VE	-	-	-	-	-	60EA	60VAQ(L)	60JAQ(L)	60JA(L)	60KAQ	60KA
71	-	-	71VE	-	-	-	-	-	71EA	71VAQ(L)	71JAQ(L)	71JA(L)	71KAQ	71KA
80	-	-	-	-	-	-	-	-	-	-	-	-	-	-
100	-	-	-	-	-	-	-	-	100EA	-	100JAQ(L)	100JA(L)	100KAQ	100KA

Note: The lineup of a connectable indoor unit depends on a district/areas/country.

Branch box	PAC-MK5*BC	PAC-MK3*BC	Note: A maximum of 2 branch boxes can be connected to 1 outdoor unit. 52/ 32 series cannot be connected.
Number of branches (Indoor unit that can be connected)	5-branches (MAX. 5 units)	3-branches (MAX. 3 units)	



2-branch pipe (joint): Optional parts	
In case of using 1- branch box	No need
In case of using 2- branch boxes	Model name
	MSDD-50AR-E
	MSDD-50BR-E
Select a model according to the connection method.	



Option	Optional accessories of indoor units and outdoor units are available.
--------	---

2-3. UNIT CONSTRUCTION (MIXED SYSTEM)

Outdoor unit		4.5HP		5HP		6HP			
		PUMY-SP112VKM.TH(-BS) PUMY-SP112YKM.TH(-BS)		PUMY-SP125VKM.TH(-BS) PUMY-SP125YKM.TH(-BS)		PUMY-SP140VKM.TH(-BS) PUMY-SP140YKM.TH(-BS)			
Applicable indoor unit	Capacity	City multi indoor unit						Type 15 to Type 140	
		Via branch box						kW unit: Type 15 to Type 100	
	Number of units		Via branch box	City multi indoor	Via branch box	City multi indoor	Via branch box	City multi indoor	
		1 branch box	5	5	5	5	5	5	
	2 branch boxes	7 or 8* ¹	3 or 2* ¹	8	3	8	3		
Total system wide capacity	6.3 to 16.2 kW			7.1 to 18.2 kW		8.0 to 20.2 kW			

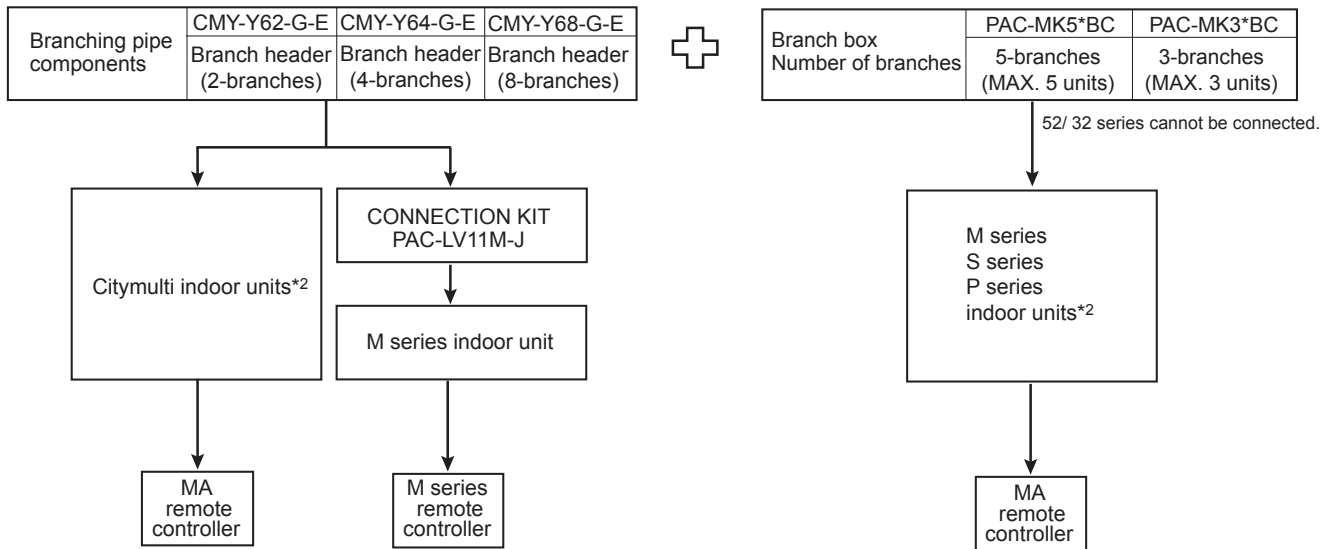

*¹ When connecting 7 indoor units via branch box, connectable citymulti indoor units are 3; connecting 8 indoor units via branch box, connectable citymulti indoor units are 2.

*² Refer to "2-1. UNIT CONSTRUCTION" or "2-2. UNIT CONSTRUCTION (BRANCH BOX SYSTEM)", for more detail.

2-4. UNIT SPECIFICATIONS

(1) Outdoor Unit

Outdoor unit		PUMY-SP112VKM.TH(-BS) PUMY-SP112YKM.TH(-BS)	PUMY-SP125VKM.TH(-BS) PUMY-SP125YKM.TH(-BS)	PUMY-SP140VKM.TH(-BS) PUMY-SP140YKM.TH(-BS)
Capacity	Cooling (kW)	12.5	14.0	15.5
	Heating (kW)	14.0	16.0	16.5
Compressor (kW)		3.1	3.5	3.7

Cooling capacity indicates the maximum value at operation under the following condition.

*Cooling Indoor : D.B. 27°C/W.B. 19.0°C
 Outdoor : D.B. 35°C
 *Heating Indoor : D.B. 20°C
 Outdoor : D.B. 7°C/W.B. 6°C

(2) Method for identifying MULTI-S model

■ Outdoor unit <When using model 125 >

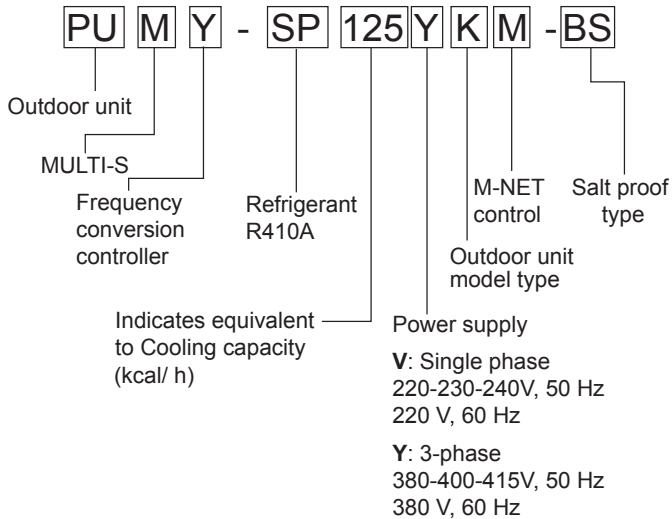

(3) Operating temperature range

	Cooling	Heating
Indoor-side intake air temperature	W.B. 15 to 24°C	D.B. 15 to 27°C
Outdoor-side intake air temperature	D.B. -5 to 52°C *1	W.B. -20 to 15°C

Note: D.B. : Dry Bulb Temperature
 W.B. : Wet Bulb Temperature

*1 10 to 52°C D.B. °C : When connecting PKFY-P15/20/25VBM, PFFY-P20/25/32VKM, PFFY-P20/25/32VLE(R)M, PEFY-P25/32/40VMA3-E, M series, S series, and P series type indoor unit with branch box, M series type indoor unit with connection kit.

■ When connecting fresh air type indoor unit

	Capacity of Fresh air type indoor	Cooling	Heating
Indoor-side and Outdoor-side intake air temperature	P80	D.B. 21 to 43°C *2 W.B. 15.5 to 35°C	D.B. -10 to 20°C *3
	P140	D.B. 21 to 43°C *2 W.B. 15.5 to 35°C	D.B. -5 to 20°C *3

*1 Thermo-OFF (FAN-mode) automatically starts if the outdoor temp. is lower than 21°C D.B..

*2 Thermo-OFF (FAN-mode) automatically starts if the outdoor temp. is lower than 21:D.B.

*3 Thermo-OFF (FAN-mode) automatically starts if the outdoor temp. is lower than 20:D.B.

3

SPECIFICATIONS

Model		PUMY-SP112VKM.TH(-BS)	PUMY-SP125VKM.TH(-BS)	PUMY-SP140VKM.TH(-BS)								
Power source		1-phase 220-230-240 V, 50 Hz; 1-phase 220 V, 60 Hz										
		220	230	240	220	230	240	220	230	240		
		50/60	50	50	50/60	50	50	50/60	50	50		
Cooling capacity (Nominal)		kW ^{*1}		12.5		14.0		15.5				
		kcal/h ^{*1}		10,750		12,040		13,330				
		BTU/h ^{*1}		42,650		47,768		52,886				
	Power input	kW		3.10		3.84		4.70				
	Current input	A		14.38	13.75	13.18	17.81	17.04	16.33	21.80	20.85	19.98
COP	kW/kW		4.03		3.65		3.30					
Temp. range of cooling	Indoor temp.	W.B.		15 to 24°C								
	Outdoor temp.	D.B.		-5 to 52°C ^{*3,*4}								
Heating capacity (Nominal)		kW ^{*2}		14.0		16.0		16.5				
		kcal/h ^{*2}		12,040		13,760		14,190				
		BTU/h ^{*2}		47,768		54,592		56,298				
	Power input	kW		3.17		3.90		4.02				
	Current input	A		14.70	14.06	13.48	18.09	17.30	16.58	18.65	17.83	17.09
COP	kW/kW		4.42		4.10		4.10					
Temp. range of heating	Indoor temp.	D.B.		15 to 27°C								
	Outdoor temp.	W.B.		-20 to 15°C								
Indoor unit connectable	Total capacity	50 to 130% of outdoor unit capacity										
	Model/Quantity	City multi	15-140/9			15-140/10			15-140/12			
		Branch box	15-100/8			15-100/8			15-100/8			
		"Mixed system"	Branch box 1 unit	15-140/5			15-140/5			15-140/5		
			Branch box	15-100/5			15-100/5			15-100/5		
Branch box 2 units			15-140/3 or 2 ^{*7}			15-140/3			15-140/3			
	Branch box	15-100/7 or 8 ^{*7}			15-100/8			15-100/8				
Sound pressure level (measured in anechoic room)	dB <A>		52/54		53/56		54/56					
Power pressure level (measured in anechoic room)	dB <A>		72/74		73/76		74/76					
Refrigerant piping diameter	Liquid pipe	mm (inch)		9.52 (3/8)								
	Gas pipe	mm (inch)		15.88 (5/8)								
FAN ^{*2}	Type × Quantity	Propeller Fan × 1										
	Air flow rate	m ³ /min		77		83		83				
		L/s		1283		1383		1383				
		cfm		2719		2931		2931				
	Control, Driving mechanism	DC control										
Motor output	kW		0.20 × 1									
External static press.	0											
Compressor	Type × Quantity	Twin rotary hermetic compressor × 1										
	Manufacturer	Mitsubishi Electric Corporation										
	Starting method	Inverter										
	Capacity control %	Cooling 26 to 100 Heating 20 to 100			Cooling 24 to 100 Heating 18 to 100			Cooling 21 to 100 Heating 17 to 100				
	Motor output	kW		3.1		3.5		3.7				
	Case heater	kW		0								
Lubricant	FV50S (1.4liter)											
External finish	Galvanized Steel Sheet Munsell No. 3Y 7.8/1.1											
External dimension H × W × D	mm		981 × 1,050 × 330(+40)									
	inch		38-5/8 × 41-3/8 × 13 (+1-37/64)									
Protection devices	High pressure protection		High pressure Switch									
	Inverter circuit (COMP./FAN)		Overcurrent detection, Overheat detection(Heat sink thermistor)									
	Compressor		Compressor thermistor, Overcurrent detection									
	Fan motor		Overheating, Voltage protection									
Refrigerant	Type × original charge		R410A 3.5 kg									
	Control		Electronic expansion valve									
Net weight	kg (lb)		93 (205) ^{*8}									
Heat exchanger	Cross Fin and Copper tube											
HIC circuit (HIC: Heat Inter-Changer)	HIC circuit											
Defrosting method	Reversed refrigerant circuit											
Drawing	External		RK01B171									
	Wiring		BH79J995									
Standard attachment	Document		Installation Manual									
	Accessory		Grounded lead wire × 2									
Optional parts	Joint: CMY-Y62-G-E Header: CMY-Y64/68-G-E											
Remarks	*1 Nominal cooling conditions		*2 Nominal heating conditions						Unit converter			
	Indoor: 27°C D.B./19°C W.B. [81°F D.B./66°F W.B.]		20°C D.B. [68°F D.B.]						kcal/h = kW × 860			
	Outdoor: 35°C D.B. [95°F D.B.]		7°C DB/6°C W.B. [45°F D.B./43°F W.B.]						BTU/h = kW × 3,412			
	Pipe length: 7.5 m [24-9/16 ft]		7.5 m [24-9/16 ft]						cfm = m ³ /min × 35.31			
Level difference: 0 m [0 ft]		0 m [0 ft]						lb = kg/0.4536				
*3 10 to 52.; when connecting following models: PKFY-P15/20/25VBM, PFFY-P20/25/32VLE(R)M, PFFY-P20/25/32VKM, and M series, S series, and P series type indoor unit with branch box, M series type indoor unit with connection kit.												
*4 -15 to 52.; when using an optional air protect guide [PAC-SH95AG-E]. However, this condition does not apply to the indoor unit listed in *3.												
*5 Up to P100 when connecting via branch box.												
*6 Up to 11 units when connecting via 2 branch boxes.												
*7 When connecting 7 indoor units via branch box, connectable citymulti indoor units are 3; connecting 8 indoor units via branch box, connectable citymulti indoor units are 2.												
*8 94 (207), for PUMY-SP112/125/140VKM.TH-BS.												
Notes :1. Nominal conditions *1, *2 are subject to ISO 15042.												
2. Due to continuing improvement, above specifications may be subject to change without notice.												

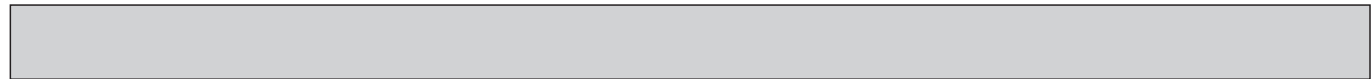

Model			PUMY-SP112YKM.TH(-BS)			PUMY-SP125YKM.TH(-BS)			PUMY-SP140YKM.TH(-BS)				
Power source			3-phase 380-400-415V, 50 Hz; 3-phase 380 V, 60 Hz										
			380	400	415	380	400	415	380	400	415		
			50/60	50	50	50/60	50	50	50/60	50	50		
Cooling capacity (Nominal)		kW ^{*1}	12.5			14.0			15.5				
		kcal/h ^{*1}	10,750			12,040			13,330				
		BTU/h ^{*1}	42,650			47,768			52,886				
	Power input	kW	3.10			3.84			4.70				
	Current input	A	4.96	4.71	4.54	6.14	5.83	5.62	7.52	7.14	6.88		
	COP	kW/kW	4.03			3.65			3.30				
Temp. range of cooling	Indoor temp.	W.B.	15 to 24°C										
	Outdoor temp.	D.B.	-5 to 52°C ^{*3,*4}										
Heating capacity (Nominal)		kW ^{*2}	14.0			16.0			16.5				
		kcal/h ^{*2}	12,040			13,760			14,190				
		BTU/h ^{*2}	47,768			54,592			56,298				
	Power input	kW	3.17			3.90			4.02				
	Current input	A	5.07	4.82	4.64	6.24	5.93	5.71	6.43	6.11	5.89		
	COP	kW/kW	4.42			4.10			4.10				
Temp. range of heating	Indoor temp.	D.B.	15 to 27°C										
	Outdoor temp.	W.B.	-20 to 15°C										
Indoor unit connectable	Total capacity		50 to 130% of outdoor unit capacity										
	Model/Quantity	City multi	15-140/9			15-140/10			15-140/12				
		Branch box	15-100/8			15-100/8			15-100/8				
		Mixed system	1 unit	15-140/5			15-140/5			15-140/5			
			Branch box	City multi	15-100/5			15-100/5			15-100/5		
				City multi	15-140/3 or 2 ^{*7}			15-140/3			15-140/3		
Branch box				15-100/7 or 8 ^{*7}			15-100/8			15-100/8			
Sound pressure level (measured in anechoic room)	dB <A>	52/54			53/56			54/56					
Power pressure level (measured in anechoic room)	dB <A>	72/74			73/76			74/76					
Refrigerant piping diameter	Liquid pipe	mm (inch)	9.52 (3/8)										
	Gas pipe	mm (inch)	15.88 (5/8)										
FAN ^{*2}	Type × Quantity		Propeller Fan × 1										
	Air flow rate	m ³ /min	77			83			83				
		L/s	1283			1383			1383				
		cfm	2719			2931			2931				
	Control, Driving mechanism		DC control										
	Motor output	kW	0.20 × 1										
External static press.		0											
Compressor	Type × Quantity		Twin rotary hermetic compressor × 1										
	Manufacturer		Mitsubishi Electric Corporation										
	Starting method		Inverter										
	Capacity control	%	Cooling 26 to 100 Heating 20 to 100			Cooling 24 to 100 Heating 18 to 100			Cooling 21 to 100 Heating 17 to 100				
	Motor output	kW	3.1			3.5			3.7				
	Case heater	kW	0										
	Lubricant		FV50S (1.4liter)										
External finish		Galvanized Steel Sheet Munsell No. 3Y 7.8/1.1											
External dimension H × W × D	mm		981 × 1,050 × 330(+40)										
	inch		38-5/8 × 41-3/8 × 13 (+1-37/64)										
Protection devices	High pressure protection		High pressure Switch										
	Inverter circuit (COMP./FAN)		Overcurrent detection, Overheat detection(Heat sink thermistor)										
	Compressor		Compressor thermistor, Overcurrent detection										
	Fan motor		Overheating, Voltage protection										
Refrigerant	Type × original charge		R410A 3.5 kg										
	Control		Electronic expansion valve										
Net weight	kg (lb)		94 (207) *8										
Heat exchanger		Cross Fin and Copper tube											
HIC circuit (HIC: Heat Inter-Changer)		HIC circuit											
Defrosting method		Reversed refrigerant circuit											
Drawing	External		RK01B171										
	Wiring		BH79J996										
Standard attachment	Document		Installation Manual										
	Accessory		Grounded lead wire × 2										
Optional parts		Joint: CMY-Y62-G-E Header: CMY-Y64/68-G-E											
Remarks	*1 Nominal cooling conditions		*2 Nominal heating conditions						Unit converter				
	Indoor : 27°C D.B./19°C W.B. [81°F D.B./66°F W.B.]		20°C D.B. [68°F D.B.]						kcal/h = kW × 860				
	Outdoor : 35°C D.B. [95°F D.B.]		7°C DB/6°C W.B. [45°F D.B./43°F W.B.]						BTU/h = kW × 3,412				
	Pipe length : 7.5 m [24-9/16 ft]		7.5 m [24-9/16 ft]						cfm = m ³ /min × 35.31				
Level difference : 0 m [0 ft]		0 m [0 ft]						lb = kg/0.4536					
*3 10 to 52., when connecting following models: PKFY-P15/20/25VBM, PFFY-P20/25/32VLE(R)M, PFFY-P20/25/32VKM, and M series, S series, and P series type indoor unit with branch box, M series type indoor unit with connection kit.													
*4 -15 to 52., when using an optional air protect guide [PAC-SH95AG-E]. However, this condition does not apply to the indoor unit listed in *3.													
*5 Up to P100 when connecting via branch box.													
*6 Up to 11 units when connecting via 2 branch boxes.													
*7 When connecting 7 indoor units via branch box, connectable citymulti indoor units are 3; connecting 8 indoor units via branch box, connectable citymulti indoor units are 2.													
*8 95 (209), for PUMY-SP112/125/140YKM.TH-BS.													
Notes : 1. Nominal conditions *1, *2 are subject to ISO 15042.													
2. Due to continuing improvement, above specifications may be subject to change without notice.													

4-1. SELECTION OF COOLING/HEATING UNITS

<Cooling>

Design Condition	
Outdoor Design Dry Bulb Temperature	44.7°C
Total Cooling Load	9.0 kW
Room1	
Indoor Design Dry Bulb Temperature	27°C
Indoor Design Wet Bulb Temperature	20°C
Cooling Load	4.0 kW
Room2	
Indoor Design Dry Bulb Temperature	24°C
Indoor Design Wet Bulb Temperature	18°C
Cooling Load	4.5 kW
<Other>	
Indoor/Outdoor Equivalent Piping Length	60 m

Capacity of indoor unit

P+FY Series	Model Number for indoor unit	Model 15	Model 20	Model 25	Model 32	Model 40	Model 50	Model 63	Model 71	Model 80	Model 100	Model 125	Model 140
	Model Capacity	1.7	2.2	2.8	3.6	4.5	5.6	7.1	8.0	9.0	11.2	14.0	16.0
M Series S Series P Series	Model Number for indoor unit [kW type]	Model 15	Model 18	Model 20	Model 22	Model 25	Model 35	Model 42	Model 50	Model 60	Model 71	Model 80	Model 100
	Model Capacity	1.5	1.8	2.0	2.2	2.5	3.5	4.2	5.0	6.0	7.1	8.0	10.0

1. Cooling Calculation

(1) Temporary Selection of Indoor Units

Room1

PEFY-P40

4.5 kW (Rated)

Room2

PEFY-P50

5.6 kW (Rated)

(2) Total Indoor Units Capacity

P40 + P50 = P90

(3) Selection of Outdoor Unit

The SP112 outdoor unit is selected as total indoor units capacity is P90

PUMY-SP112

12.5 kW

(4) Total Indoor Units Capacity Correction Calculation

Room1

Indoor Design Wet Bulb Temperature Correction (20°C) 1.03 (Refer to Figure 1)

Room2

Indoor Design Wet Bulb Temperature Correction (18°C) 0.94 (Refer to Figure 1)

Total Indoor Units Capacity (CTi)

$$CTi = \sum (\text{Indoor Unit Rating} \times \text{Indoor Design Temperature Correction})$$

$$= 4.5 \times 1.03 + 5.6 \times 0.94$$

$$= 9.9 \text{ kW}$$

(5) Outdoor Unit Correction Calculation

Outdoor Design Dry Bulb Temperature Correction (44.7°C) 0.88 (Refer to Figure 2)

Piping Length Correction (60 m) 0.88 (Refer to Figure 3)

Total Outdoor Unit Capacity (CTo)

$$CTo = \text{Outdoor Rating} \times \text{Outdoor Design Temperature Correction} \times \text{Piping Length Correction}$$

$$= 12.5 \times 0.88 \times 0.88$$

$$= 9.7 \text{ kW}$$

(6) Determination of Maximum System Capacity

Comparison of Capacity between Total Indoor Units Capacity (CTi) and Total Outdoor Unit Capacity (CTo)

CTi = 9.9 > CTo = 9.7, thus, select CTo.

CTx = CTo = 9.7 kW

(7) Comparison with Essential Load

Against the essential load 9.0kW, the maximum system capacity is 9.7 kW: Proper outdoor units have been selected.

(8) Calculation of Maximum Indoor Unit Capacity of Each Room

CTx = CTo, thus, calculate by the calculation below

Room1

$$\text{Maximum Capacity} \times \text{Room1 Capacity after the Temperature Correction} / (\text{Room1,2 Total Capacity after the Temperature Correction})$$

$$= 9.7 \times (4.5 \times 1.03) / (4.5 \times 1.03 + 5.6 \times 0.94)$$

$$= 4.5 \text{ kW} \quad \text{OK: fulfills the load 4.0 kW}$$

Room2

$$\text{Maximum Capacity} \times \text{Room2 Capacity after the Temperature Correction} / (\text{Room1,2 Total Capacity after the Temperature Correction})$$

$$= 9.7 \times (5.6 \times 0.94) / (4.5 \times 1.03 + 5.6 \times 0.94)$$

$$= 5.1 \text{ kW} \quad \text{OK: fulfills the load 4.5 kW}$$

Note: If CTx = CTi, please refer to the <Heating> section to calculate the Maximum Indoor Unit Capacity of Each Room.

Go on to the heating trial calculation since the selected units fulfill the cooling loads of Room 1, 2.

Figure 1 Indoor unit temperature correction
To be used to correct indoor unit onlyFigure 2 Outdoor unit temperature correction
To be used to correct outdoor unit only

Figure 3 Correction of refrigerant piping length

<Heating>

Design Condition	
Outdoor Design Wet Bulb Temperature	2°C
Total Heating Load	10.3 kW
Room1	
Indoor Design Dry Bulb Temperature	21°C
Heating Load	4.8 kW
Room2	
Indoor Design Dry Bulb Temperature	23°C
Heating Load	5.5 kW
<Other>	
Indoor/Outdoor Equivalent Piping Length	100 m

Capacity of indoor unit

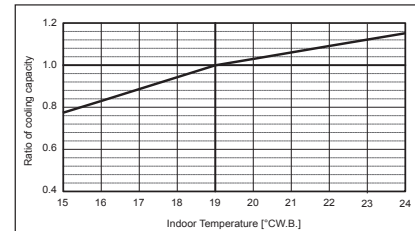
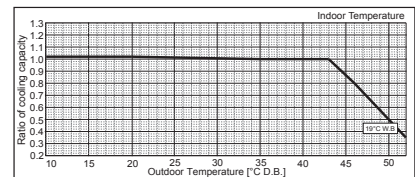
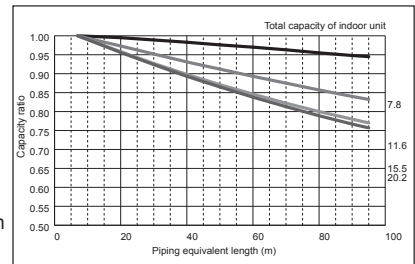
P•FY Series	Model Number for indoor unit	Model 15	Model 20	Model 25	Model 32	Model 40	Model 50	Model 63	Model 71	Model 80	Model 100	Model 125	Model 140
	Model Capacity	1.9	2.5	3.2	4.0	5.0	6.3	8.0	9.0	10.0	12.5	16.0	18.0
M Series	Model Number for indoor unit	Model 15	Model 18	Model 20	Model 22	Model 25	Model 35	Model 42	Model 50	Model 60	Model 71	Model 80	Model 100
S Series	Model Capacity [kW type]												
P Series	Model Capacity	1.7	2.1	2.3	2.5	2.9	4.0	4.8	5.7	6.9	8.1	9.3	11.2

2. Heating Calculation

(1) Temporary Selection of Indoor Units

Room1

PEFY-P40

5.0 kW (Rated)

Room2

PEFY-P50

6.3 kW (Rated)

(2) Total Indoor Units Capacity

P40 + P50 = P90

(3) Selection of Outdoor Unit

The SP112 outdoor unit is selected as total indoor units capacity is P90

PUMY-SP112

14.0 kW

(4) Total Indoor Units Capacity Correction Calculation

Room1

Indoor Design Dry Bulb Temperature Correction (21°C)

0.96 (Refer to Figure 4)

Room2

Indoor Design Dry Bulb Temperature Correction (23°C)

0.88 (Refer to Figure 4)

Total Indoor Units Capacity (CTi)

$$CTi = \sum (\text{Indoor Unit Rating} \times \text{Indoor Design Temperature Correction})$$

$$= 5.0 \times 0.96 + 6.3 \times 0.88$$

$$= 10.3 \text{ kW}$$

(5) Outdoor Unit Correction Calculation

Outdoor Design Wet Bulb Temperature Correction (2°C)

1.0 (Refer to Figure 5)

Piping Length Correction (100 m)

0.94 (Refer to Figure 6)

Defrost Correction

0.89 (Refer to Table 1)

Total Outdoor Unit Capacity (CTo)

$$CTo = \text{Outdoor Unit Rating} \times \text{Outdoor Design Temperature Correction} \times \text{Piping Length Correction} \times \text{Defrost Correction}$$

$$= 14.0 \times 1.0 \times 0.94 \times 0.89$$

$$= 11.7 \text{ kW}$$

(6) Determination of Maximum System Capacity

Comparison of Capacity between Total Indoor Units Capacity (CTi) and Total Outdoor Unit Capacity (CTo)

CTi = 10.3 < CTo = 11.7, thus, select CTi.

CTx = CTi = 10.3 kW

(7) Comparison with Essential Load

Against the essential load 10.3kW, the maximum system capacity is 10.3 kW: Proper indoor units have been selected.

(8) Calculation of Maximum Indoor Unit Capacity of Each Room

CTx = CTo, thus, calculate by the calculation below

Room1

$$\text{Indoor Unit Rating} \times \text{Indoor Design Temperature Correction}$$

$$= 5.0 \times 0.96$$

$$= 4.8 \text{ kW} \quad \text{OK: fulfills the load 4.8 kW}$$

Room2

$$\text{Indoor Unit Rating} \times \text{Indoor Design Temperature Correction}$$

$$= 6.3 \times 0.88$$

$$= 5.5 \text{ kW} \quad \text{OK: fulfills the load 5.5 kW}$$

Note: If CTx = CTo, please refer to the <Cooling> section to calculate the Maximum Indoor Unit Capacity of Each Room. Completed selecting units since the selected units fulfill the heating loads of Room 1, 2.

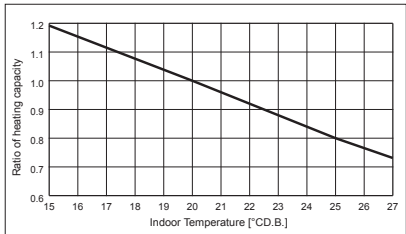

Figure 4 Indoor unit temperature correction
To be used to correct indoor unit only

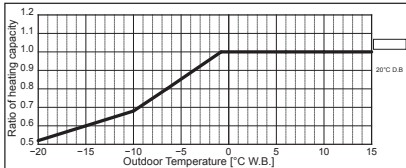

Figure 5 Outdoor unit temperature correction
To be used to correct outdoor unit only

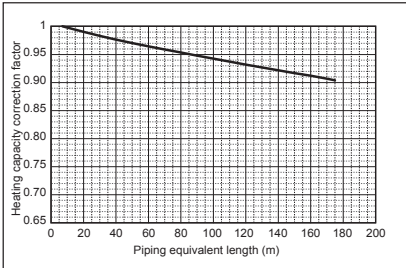

Figure 6 Correction of refrigerant piping length

Table 1 Table of correction factor at frost and defrost

Outdoor inlet air temp. °C	6	4	2	0	-2	-4	-6	-8	-10	-15	-20
PUMY-SP112,125,140VKM	1.0	0.98	0.89	0.88	0.89	0.90	0.95	0.95	0.95	0.95	0.95
PUMY-SP112,125,140YKM	1.0	0.98	0.89	0.88	0.89	0.90	0.95	0.95	0.95	0.95	0.95

4-2. CORRECTION BY TEMPERATURE

CITY MULTI could have varied capacity at different designing temperature. Using the nominal cooling capacity value and the ratio below, the capacity can be observed at various temperature.

<Cooling>

		PUMY-SP•V(Y)KM.TH(-BS)		
		112	125	140
Nominal cooling capacity	kW	12.5	14.0	15.5
	BTU/h	42,700	47,800	52,900
Input	kW	3.10	3.84	4.70

Figure7 Indoor unit temperature correction
To be used to correct indoor unit capacity only

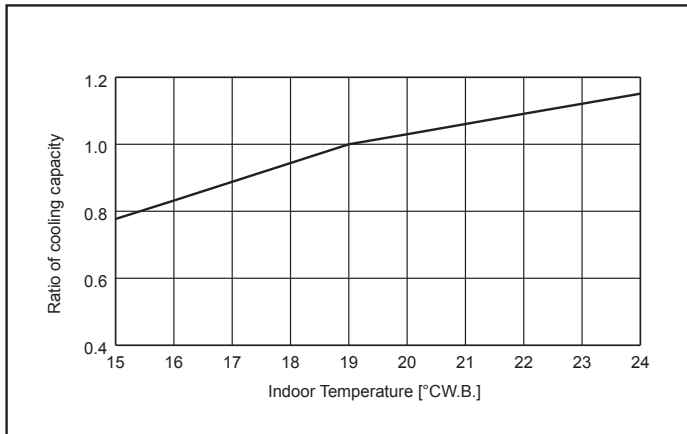

Figure8 Outdoor unit temperature correction
To be used to correct outdoor unit capacity only

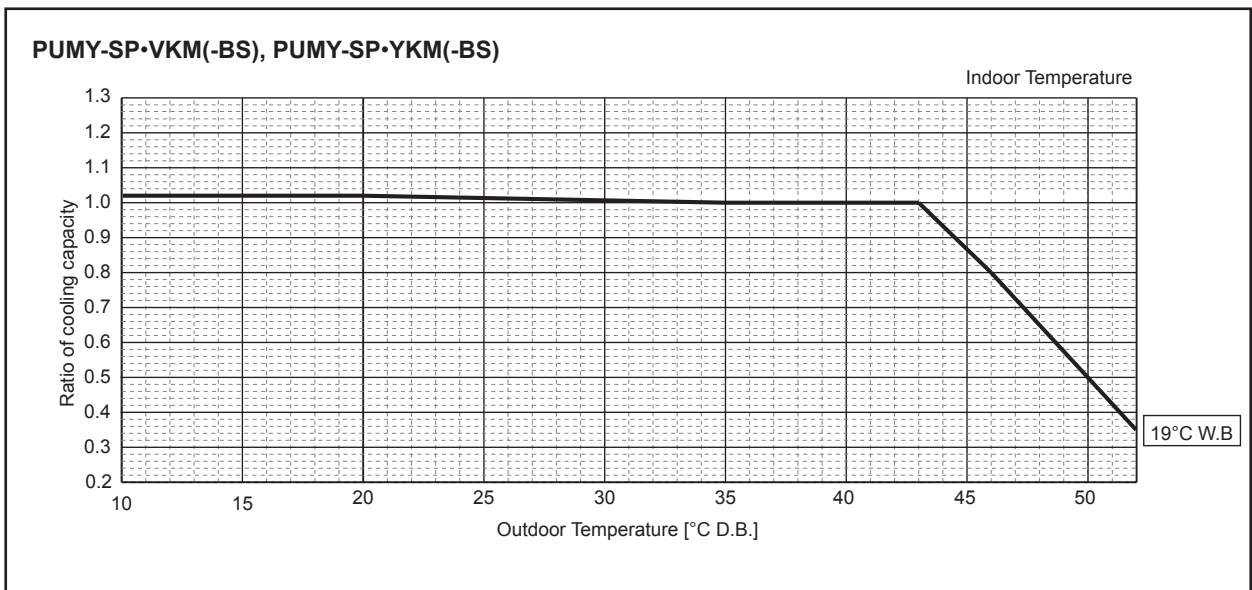
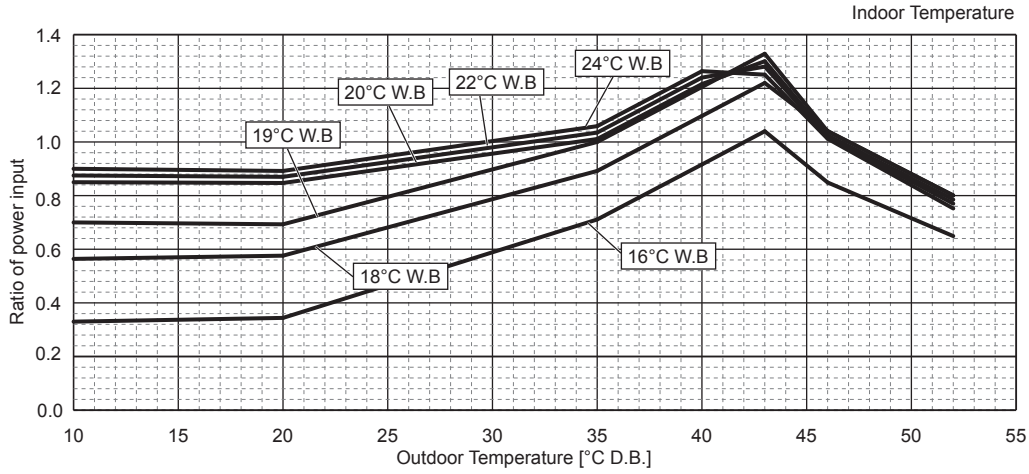
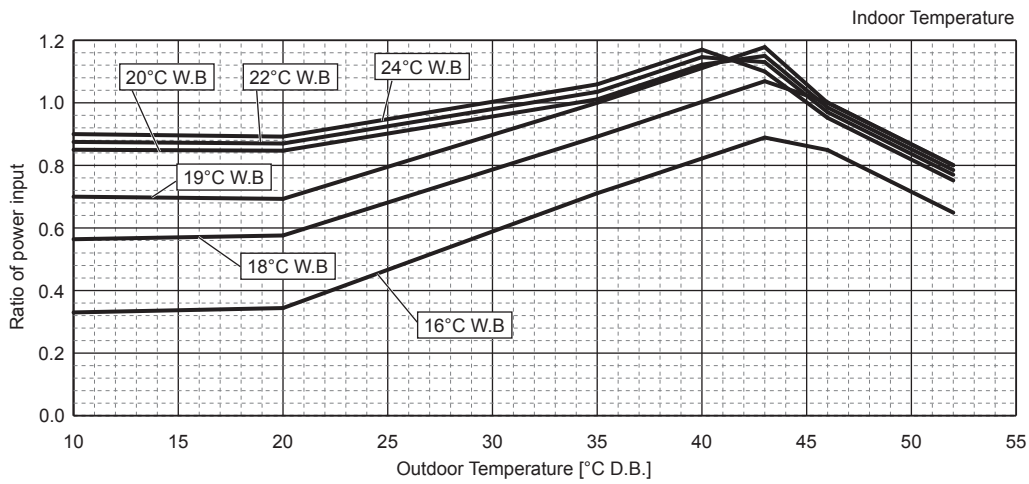

Figure 9 Outdoor unit temperature correction
 To be used to correct outdoor unit capacity only

PUMY-SP112VKM.TH(-BS), PUMY-SP112YKM.TH(-BS)
PUMY-SP125VKM.TH(-BS), PUMY-SP125YKM.TH(-BS)



PUMY-SP140VKM.TH(-BS), PUMY-SP140YKM.TH(-BS)



<Heating>

		PUMY-SP • V(Y)KM.TH(-BS)		
		112	125	140
Nominal heating capacity	kW	14.0	16.0	16.5
	BTU/h	47,768	54,592	56,298
Input	kW	3.17	3.90	4.02

Figure 10 Indoor unit temperature correction
To be used to correct indoor unit capacity only

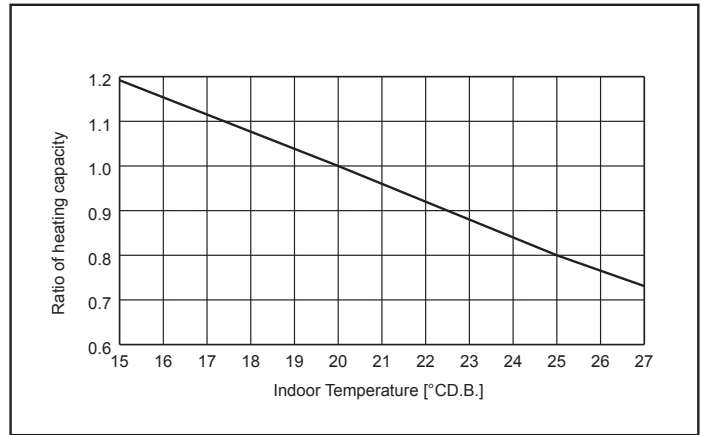
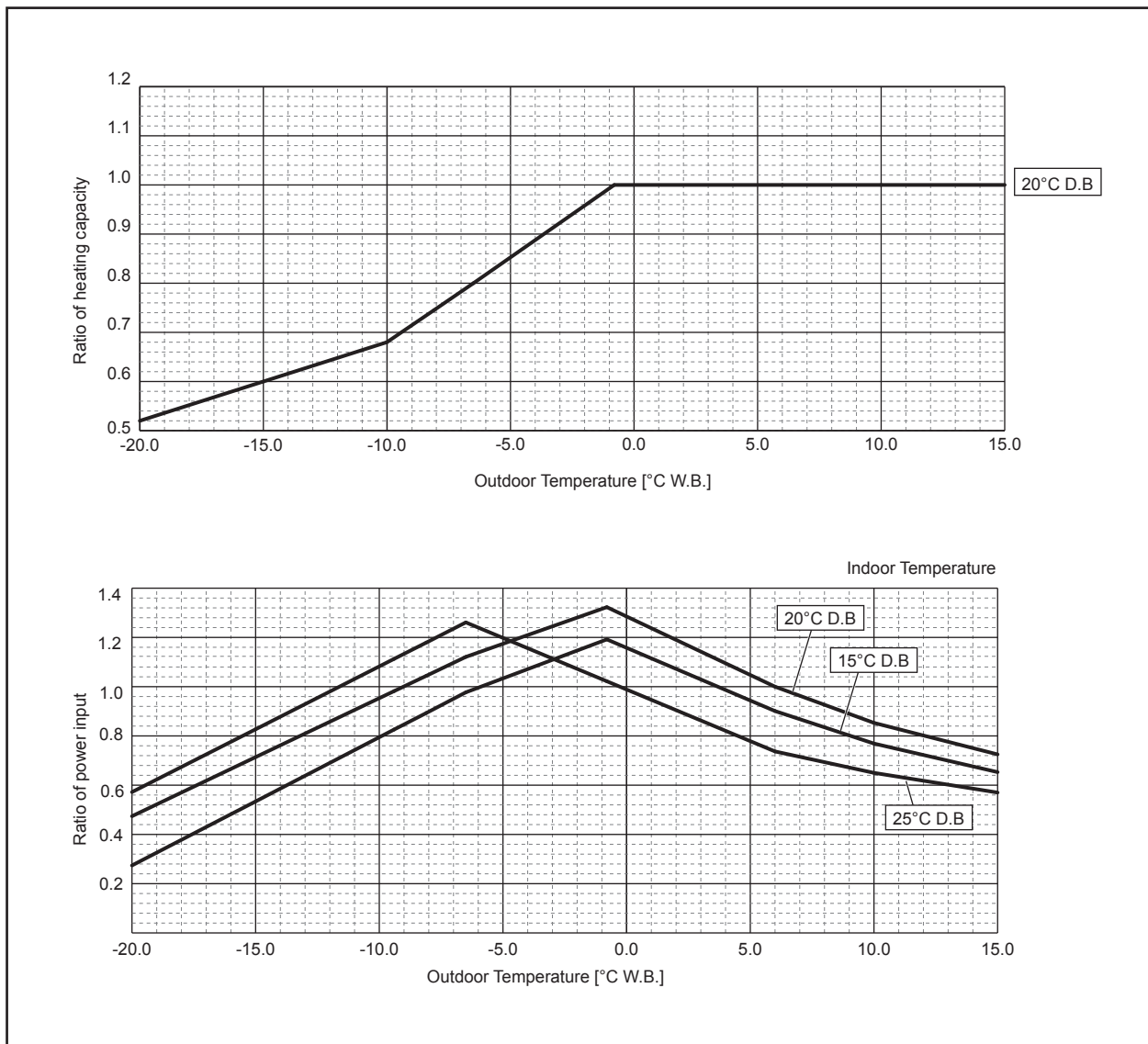

Figure 11 Outdoor unit temperature correction
To be used to correct outdoor unit capacity only



4-3. STANDARD OPERATION DATA (REFERENCE DATA)

Operation				PUMY-SP112VKM.TH(-BS) PUMY-SP112YKM.TH(-BS)		PUMY-SP125VKM.TH(-BS) PUMY-SP125YKM.TH(-BS)		PUMY-SP140VKM.TH(-BS) PUMY-SP140YKM.TH(-BS)	
Operating conditions	Ambient temperature	Indoor	DB/WB	27/19°C	20°C	27/19°C	20°C	27/19°C	20°C
		Outdoor		35°C	7/6°C	35°C	7/6°C	35°C	7/6°C
	Indoor unit	No. of connected units	Unit	4		4		4	
		No. of units in operation		4		4		4	
		Model	—	25×2 + 32×2		25×1 + 32×3		32×2 + 40×2	
	Piping	Main pipe	m	5		5		5	
		Branch pipe		2.5		2.5		2.5	
		Total pipe length		15		15		15	
		Fan speed	—	Hi		Hi		Hi	
		Amount of refrigerant	kg	6.5		6.5		6.5	
Outdoor unit	Electric current	A	15.69	14.88	18.78	18.38	22.27	19.62	
	Voltage	V	230	230	230	230	230	230	
	Compressor frequency	Hz	57	74	65	84	73	88	
LEV opening	Indoor unit	Pulse	226	396	264	335	262	358	
Pressure	High pressure/Low pressure	MPaG	2.96/1.08	1.93/0.63	3.12/1.02	2.06/0.60	3.25/0.99	2.08/0.60	
Temp. of each section	Outdoor unit	Discharge	°C	67.6	43.1	81.6	46.4	83.9	47.6
		Heat exchanger outlet		48.5	2.0	49.9	1.3	51.2	-0.3
		Accumulator inlet		14.8	-1.2	17.6	-2.0	15.4	-2.4
		Compressor inlet		15.7	-1.6	19.6	-2.7	17.5	-2.8
	Indoor unit	LEV inlet		30.6	25.2	32.7	44.6	33.7	45.0
		Heat exchanger inlet		16.6	39.2	14.5	24.4	14.3	26.5

4-4. STANDARD CAPACITY DIAGRAM

4-4-1. PUMY-SP112VKM.TH(-BS) PUMY-SP112YKM.TH(-BS) <cooling>

Before calculating the sum of total capacity of indoor units, please convert the value into the kW model capacity following the formula on "4-1-1. Method for obtaining system cooling capacity".

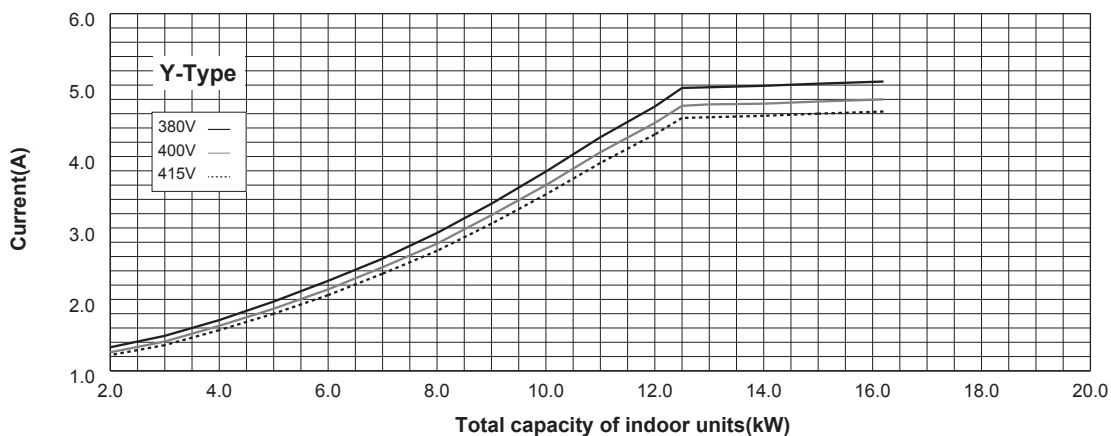
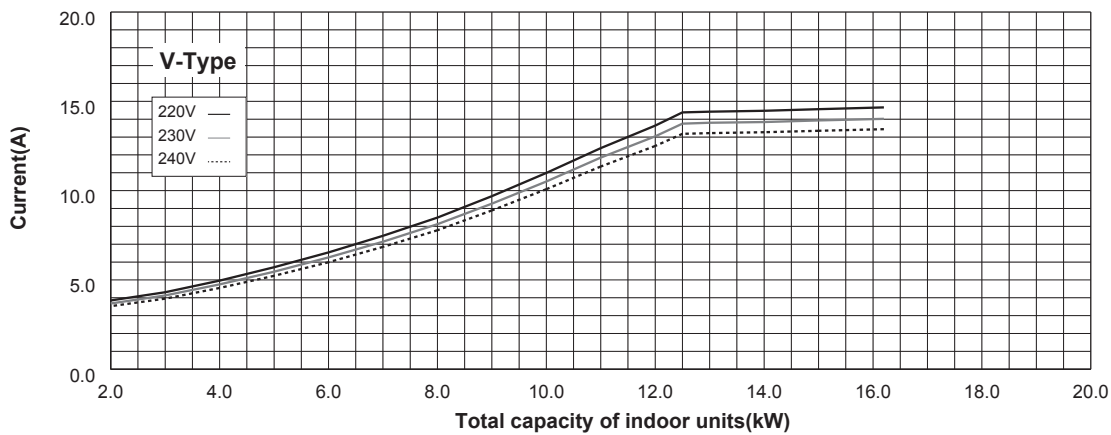
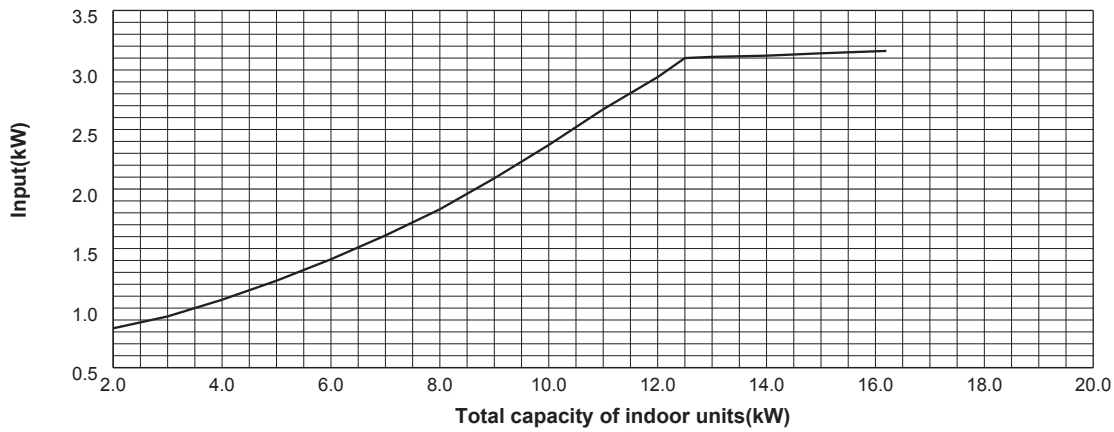
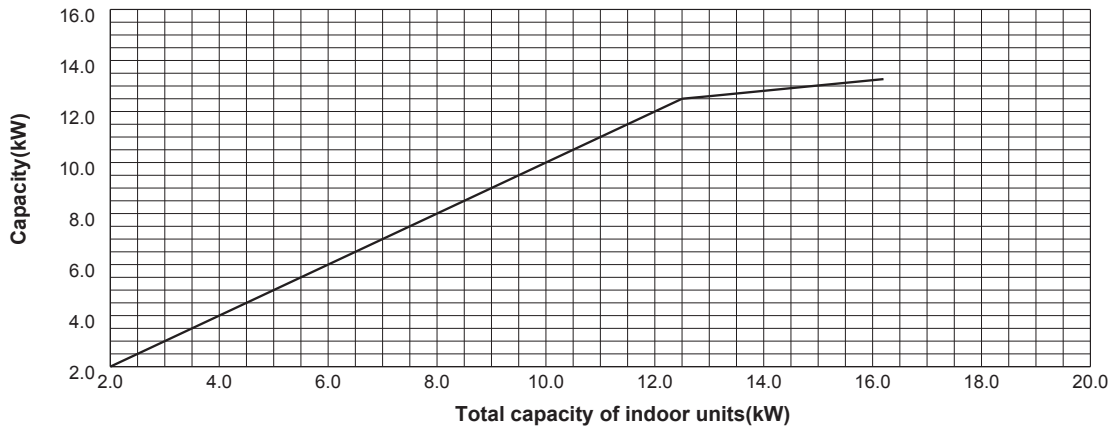

4-4-2. PUMY-SP112VKM.TH(-BS) PUMY-P112YKM.TH(-BS) <heating>

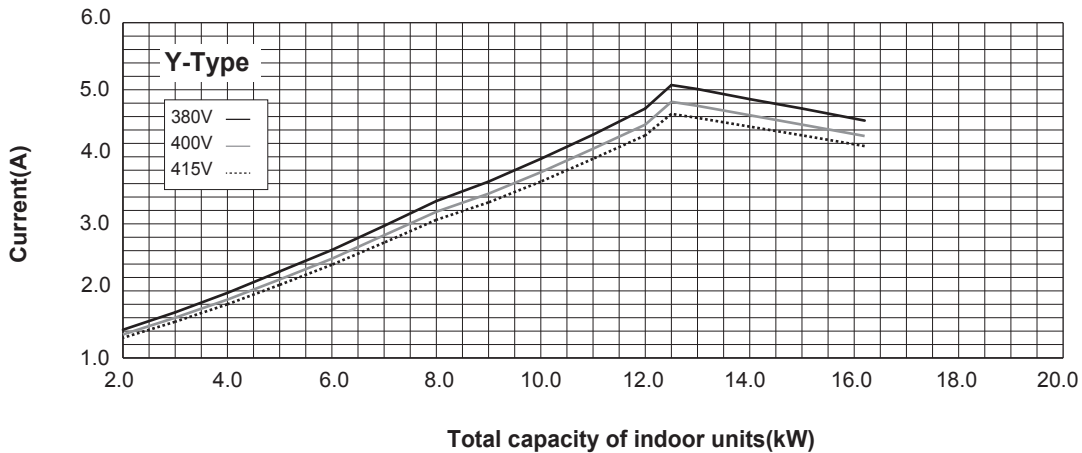
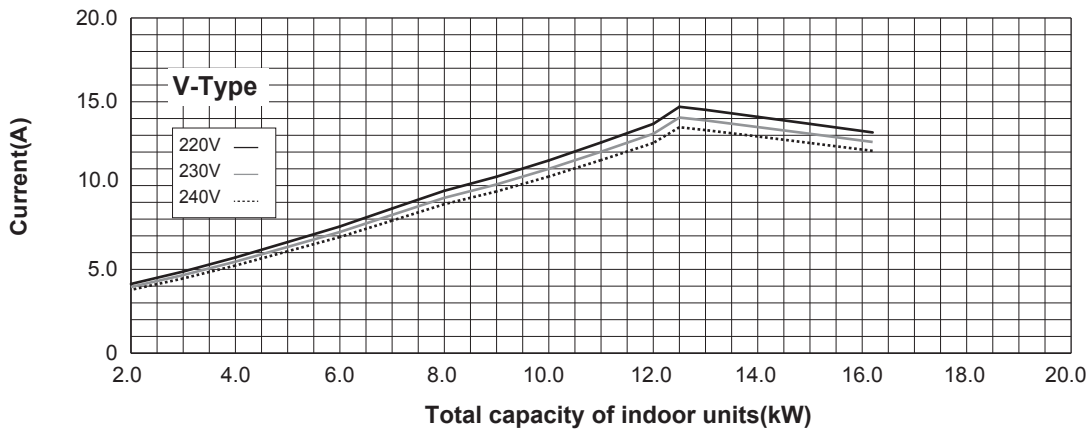
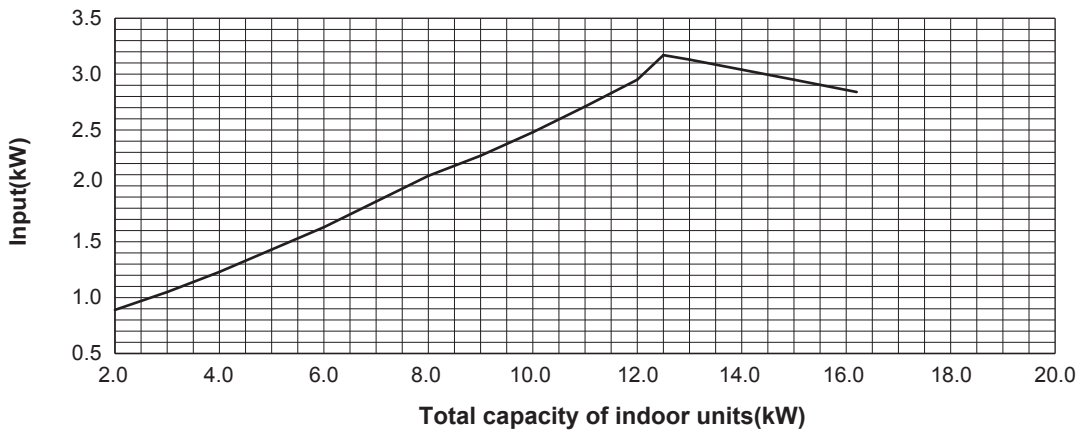
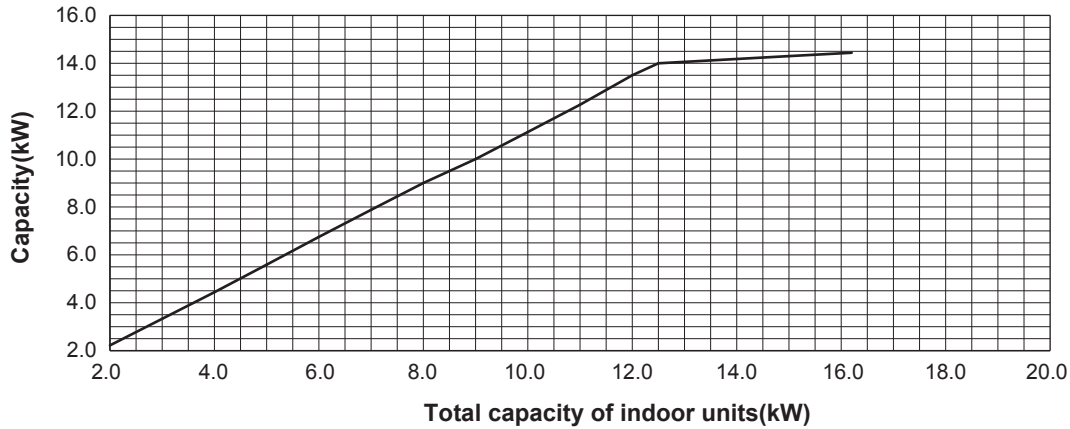

4-4-3. PUMY-SP125VKM.TH(-BS) PUMY-SP125YKM.TH(-BS) <cooling>

Before calculating the sum of total capacity of indoor units, please convert the value into the kW model capacity following the formula on "4-1-1. Method for obtaining system cooling capacity".

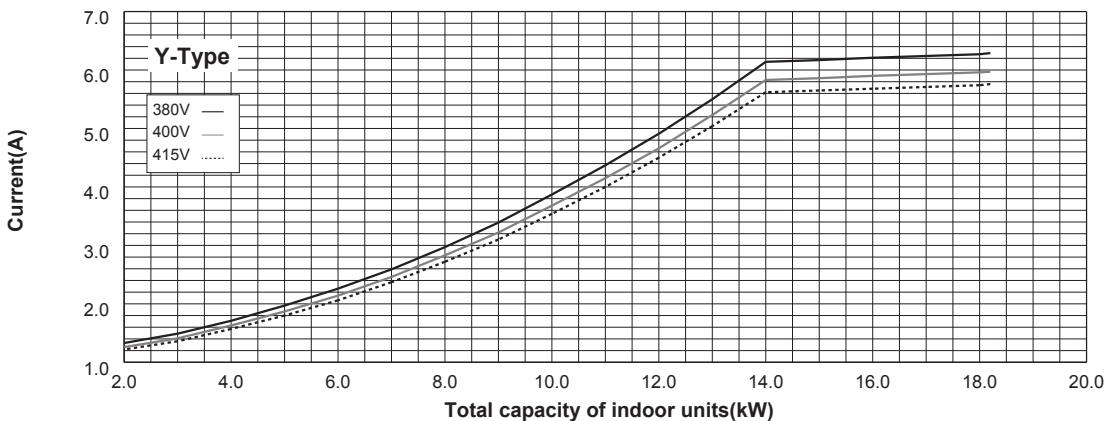
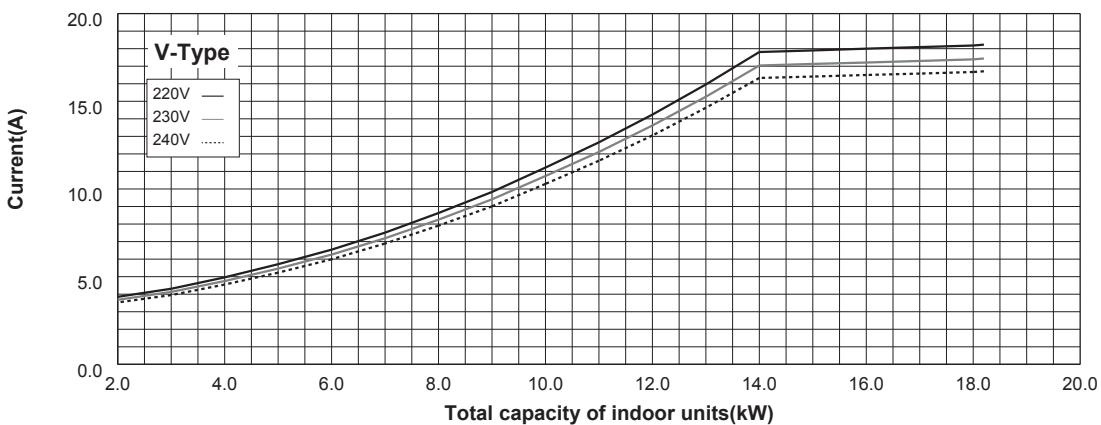
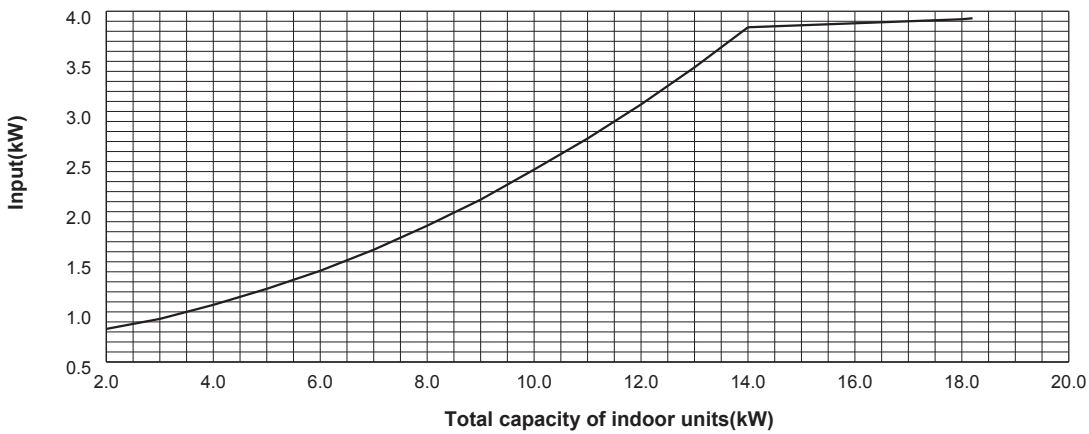
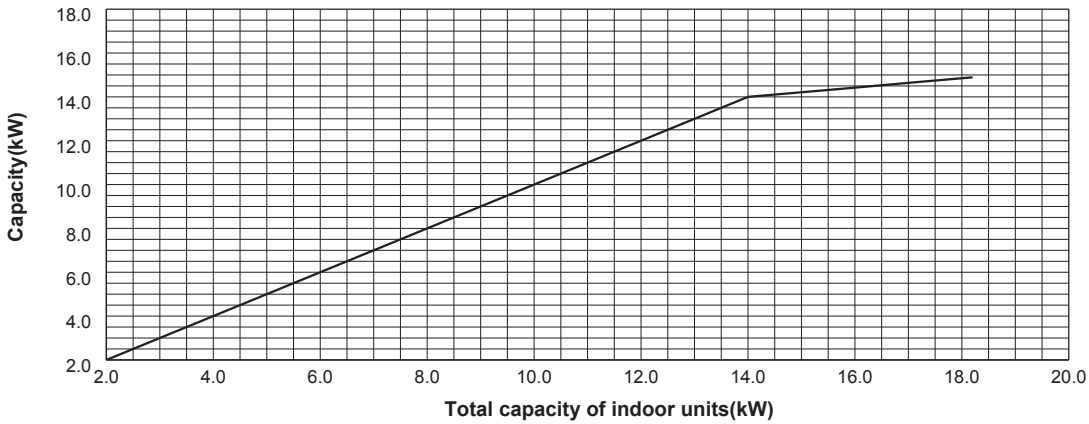

4-4-4. PUMY-SP125VKM.TH(-BS) PUMY-SP125YKM.TH(-BS) <heating>

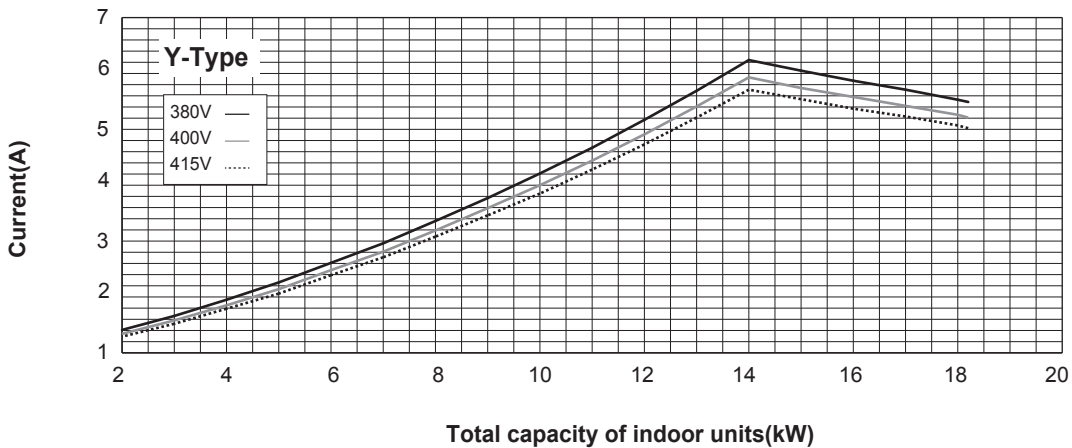
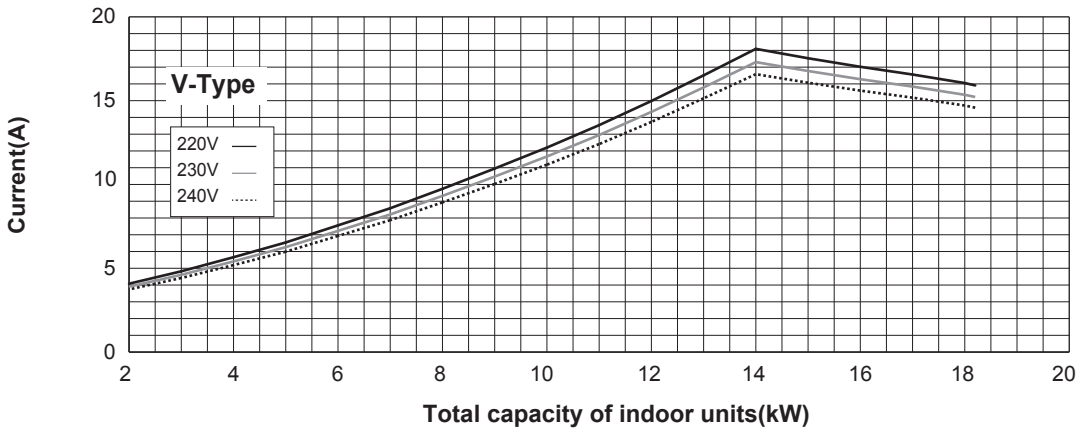
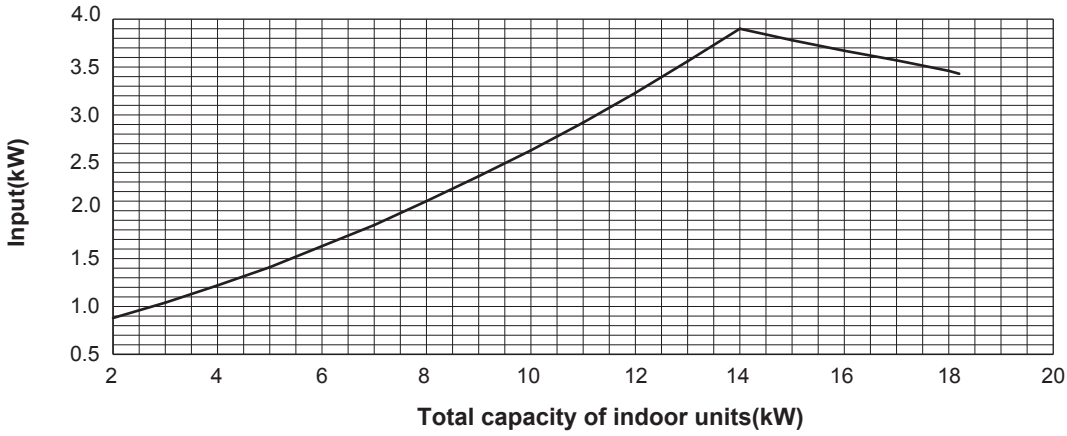
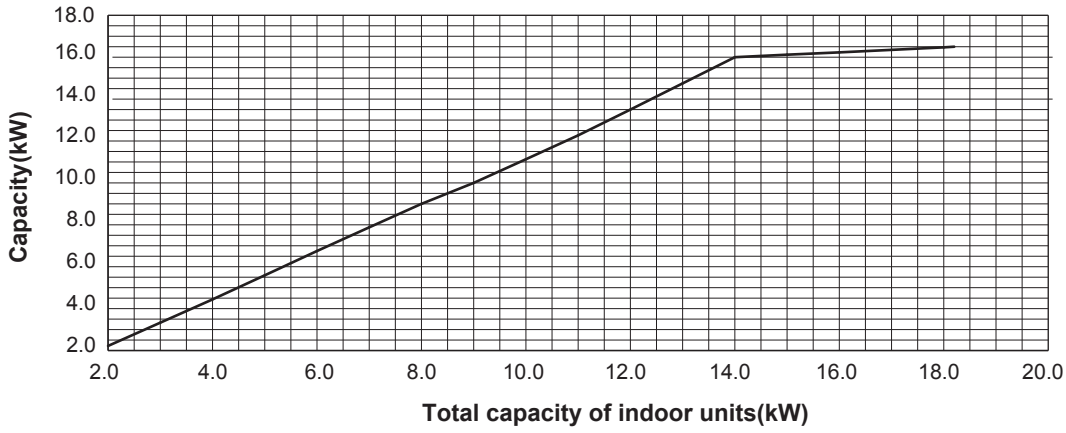

4-4-5. PUMY-SP140VKM.TH(-BS) PUMY-SP140YKM.TH(-BS) <cooling>

Before calculating the sum of total capacity of indoor units, please convert the value into the kW model capacity following the formula on "4-1-1. Method for obtaining system cooling and heating capacity".

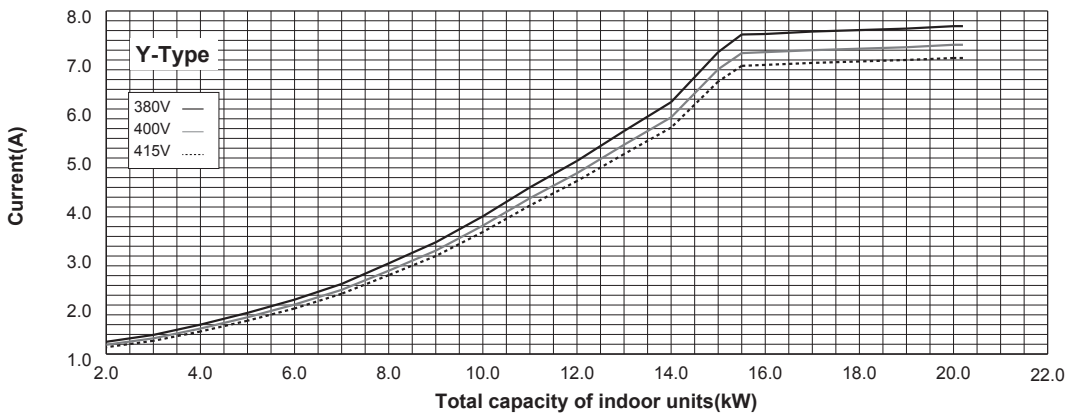
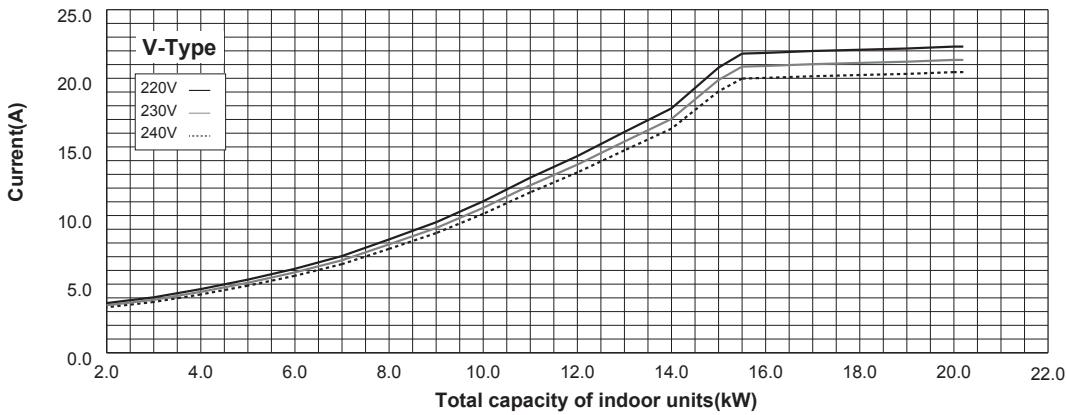
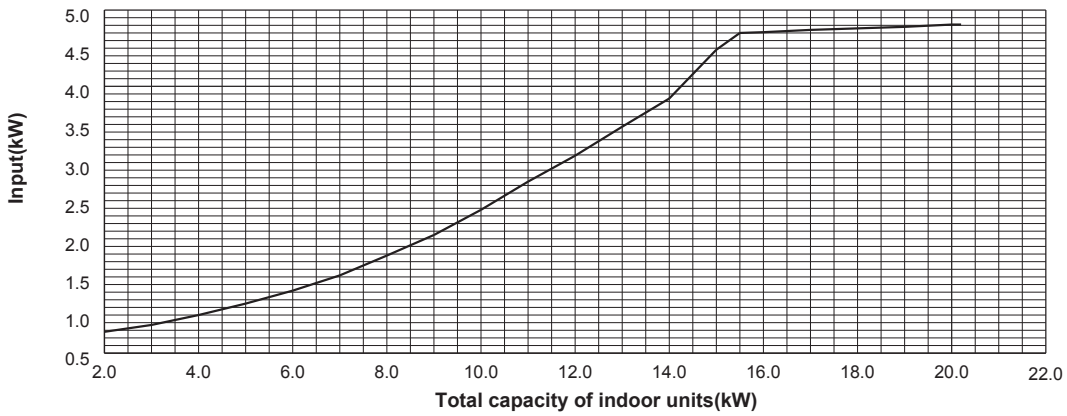
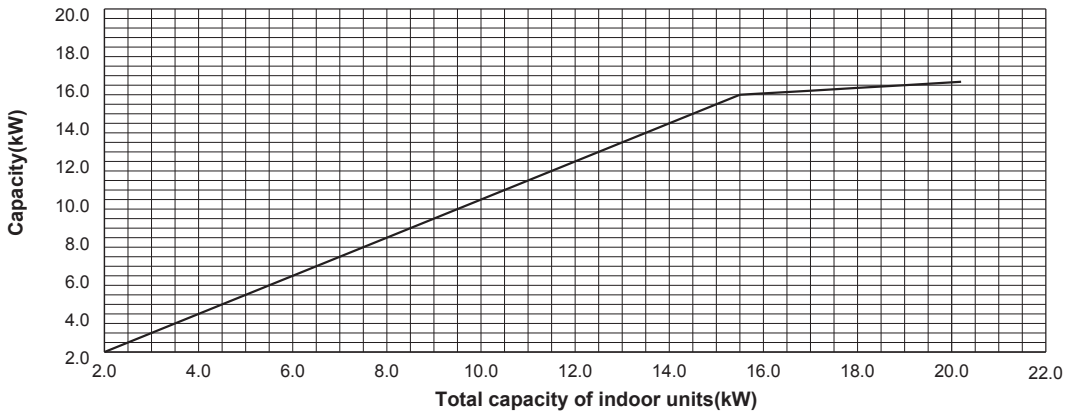

4-4-6. PUMY-SP140VKM.TH(-BS) PUMY-SP140YKM.TH(-BS) <heating>

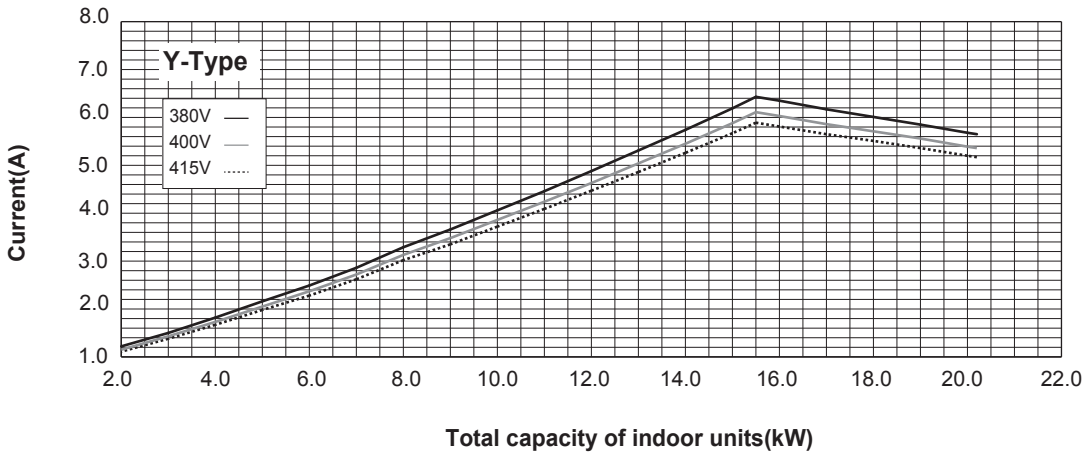
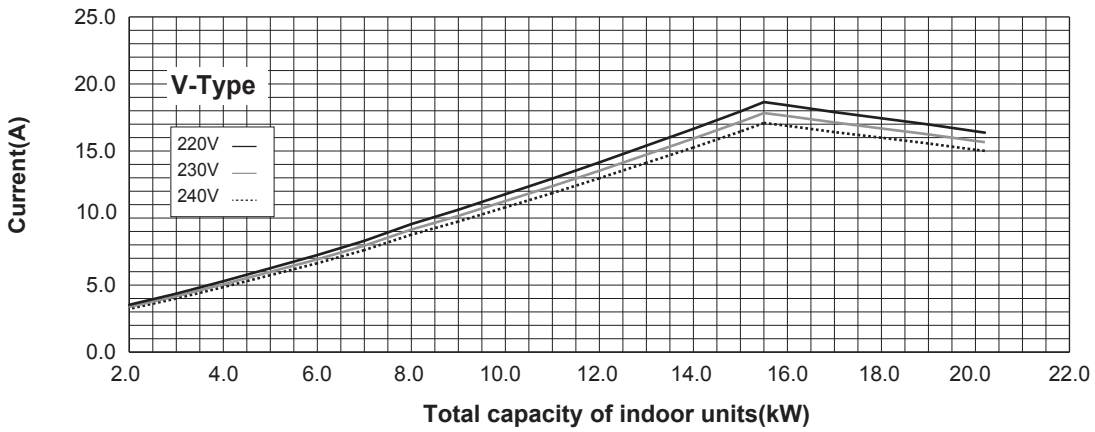
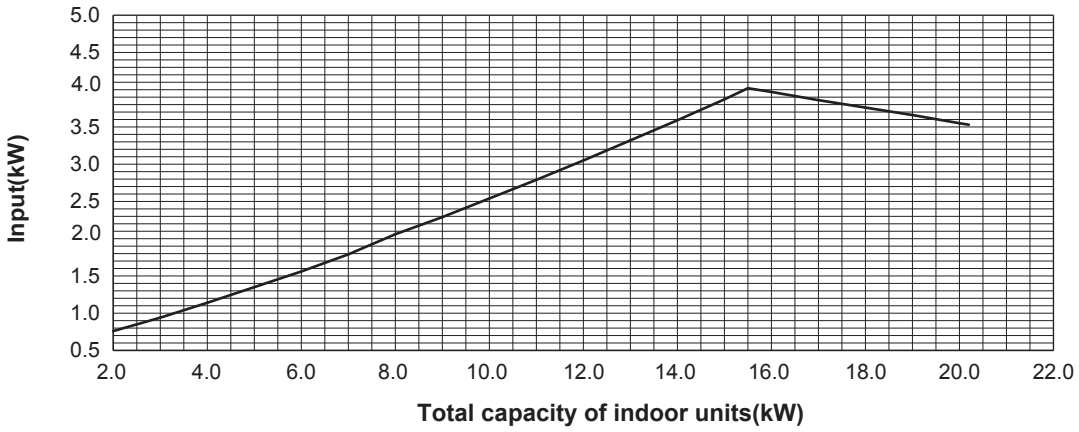
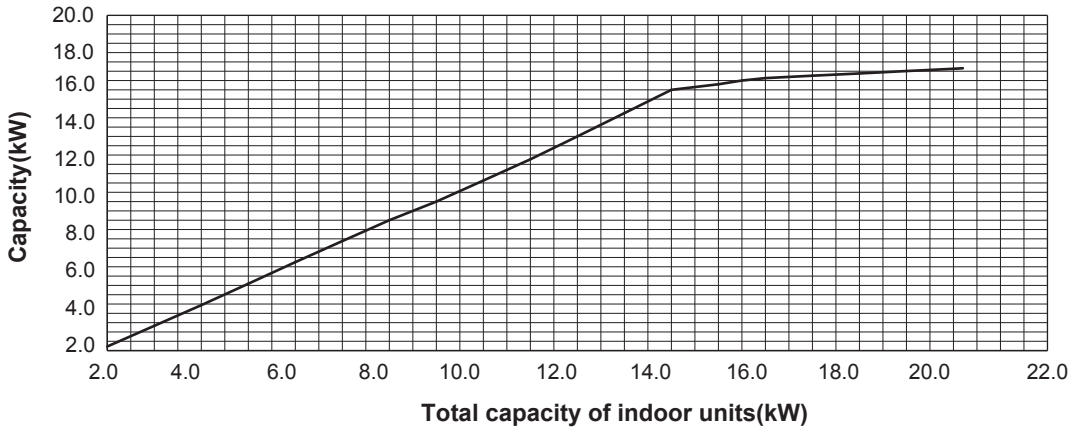

4-5. CORRECTING CAPACITY FOR CHANGES IN THE LENGTH OF REFRIGERANT PIPING

(1) During cooling, obtain the ratio (and the equivalent piping length) of the outdoor units rated capacity and the total in-use indoor capacity, and find the capacity ratio corresponding to the standard piping length from Figure 6 to 8. Then multiply by the cooling capacity from Figure 4 and 5 in "4-2. CORRECTION BY TEMPERATURE" to obtain the actual capacity.

(1) Capacity Correction Curve

Figure 12 PUMY-SP112VKM.TH(-BS) PUMY-SP112YKM.TH(-BS) <Cooling>

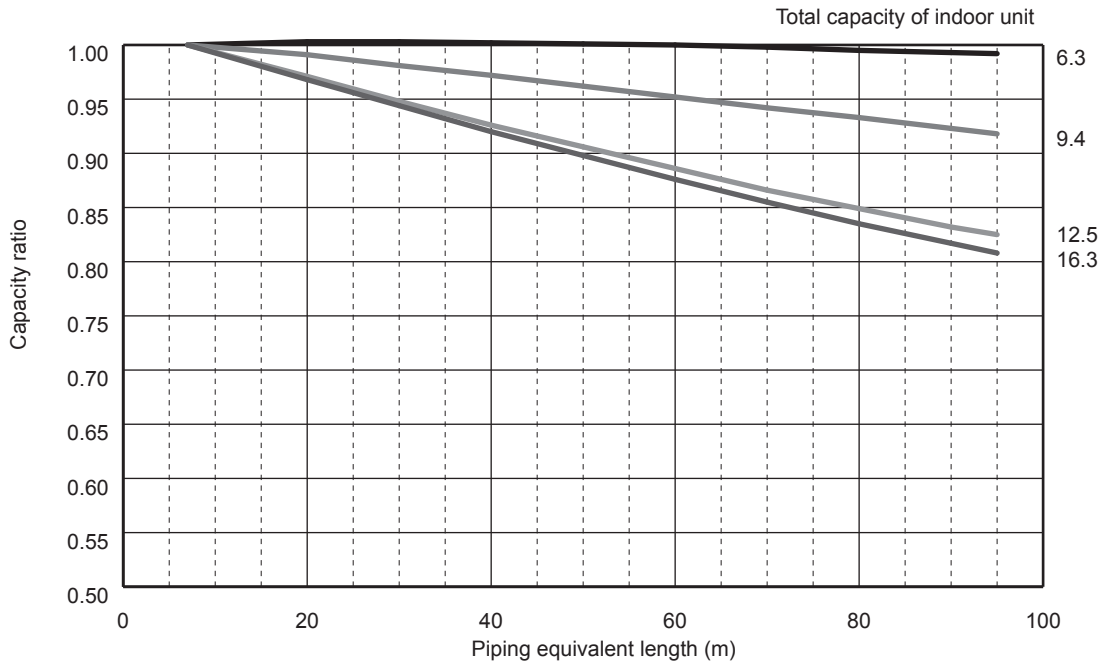

Figure 13 PUMY-SP125VKM.TH(-BS) PUMY-SP125YKM.TH(-BS) <Cooling>

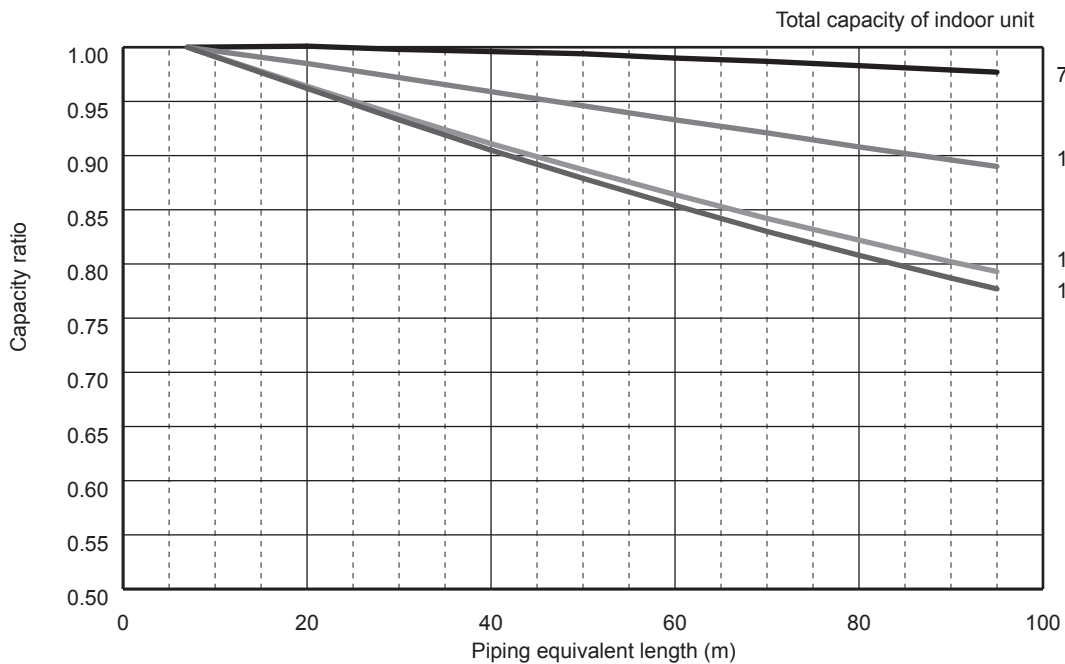

Figure 14 PUMY-SP140VKM.TH(-BS) PUMY-SP140YKM.TH(-BS) <Cooling>

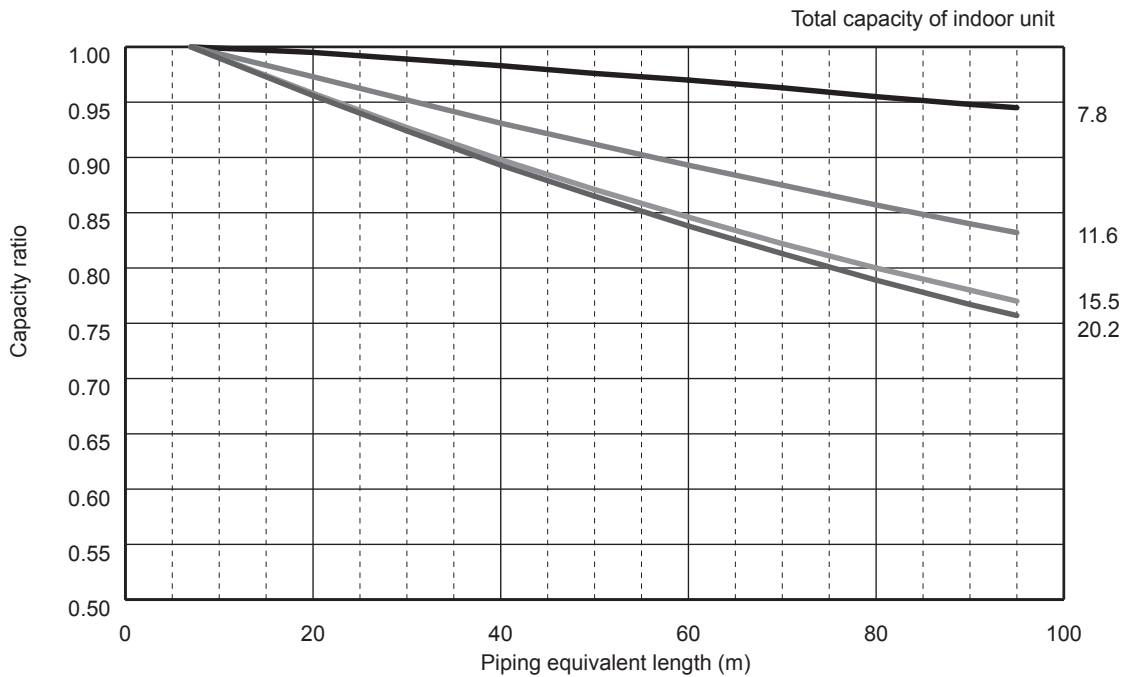
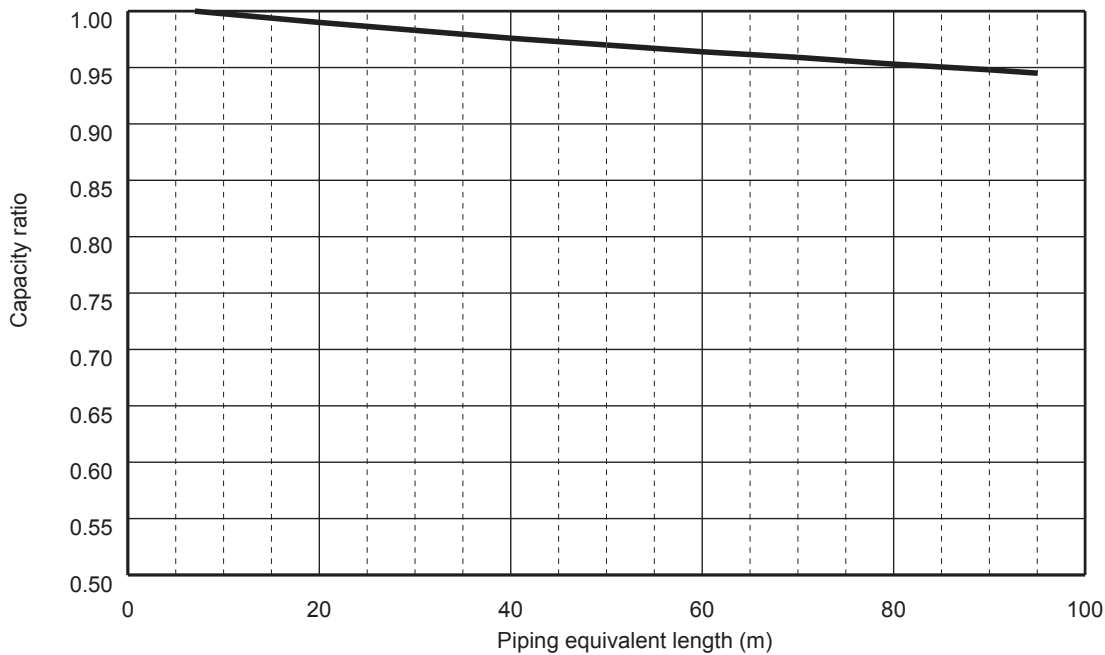

Figure 15 PUMY-SP112/125/140VKM(-BS) <Heating> PUMY-SP112/125/140YKM(-BS) <Heating>



(2) Method for Obtaining the Equivalent Piping Length

Equivalent length for type SP112-125-140 = (length of piping to farthest indoor unit) + (0.3 × number of bends in the piping) (m)

Length of piping to farthest indoor unit: type SP112-SP140.....70 m

4-5-1. Correction of Heating Capacity for Frost and Defrosting

If heating capacity has been reduced due to frost formation or defrosting, multiply the capacity by the appropriate correction factor from the following table to obtain the actual heating capacity.

Correction factor diagram

Outdoor Intake temperature (W.B. °C)	6	4	2	0	-2	-4	-6	-8	-10	-15	-20
Correction factor	1.0	0.98	0.89	0.88	0.89	0.9	0.95	0.95	0.95	0.95	0.95

4-6. NOISE CRITERION CURVES

PUMY-SP112VKM.TH(-BS)
PUMY-SP112YKM.TH(-BS)

MODE	SPL(dB)	LINE
HEATING	54	■—■
COOLING	52	○—○
SILENT(Cooling)	49	●—●
SUPER SILENT 1(Cooling)	46	△—△
SUPER SILENT 2(Cooling)	42	▲—▲

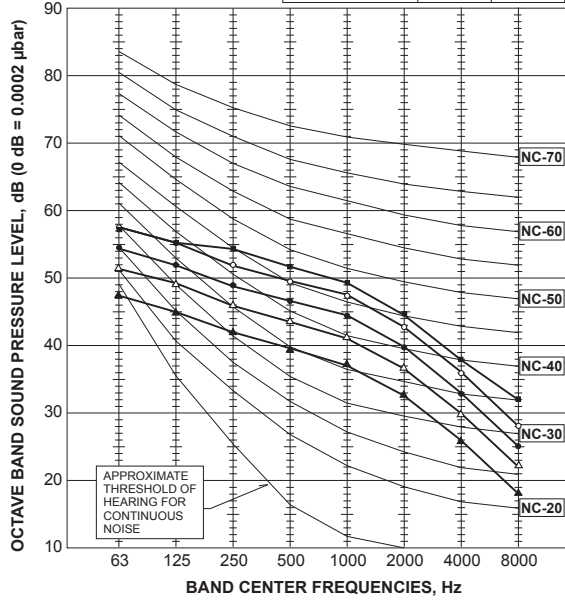

PUMY-SP125VKM.TH(-BS)
PUMY-SP125YKM.TH(-BS)

MODE	SPL(dB)	LINE
HEATING	56	■—■
COOLING	53	○—○
SILENT(Cooling)	50	●—●
SUPER SILENT 1(Cooling)	47	△—△
SUPER SILENT 2(Cooling)	43	▲—▲

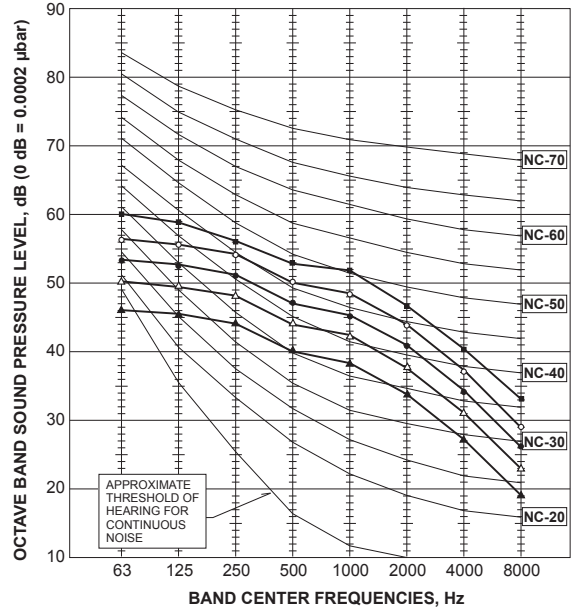

PUMY-SP140VKM.TH(-BS)
PUMY-SP140YKM.TH(-BS)

MODE	SPL(dB)	LINE
HEATING	56	■—■
COOLING	54	○—○
SILENT(Cooling)	51	●—●
SUPER SILENT 1(Cooling)	48	△—△
SUPER SILENT 2(Cooling)	44	▲—▲

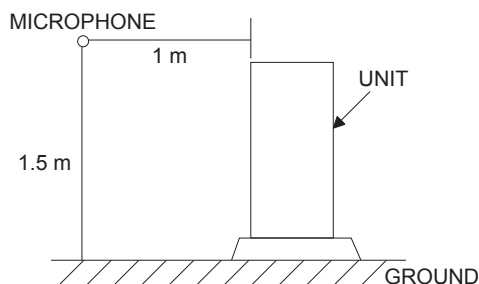
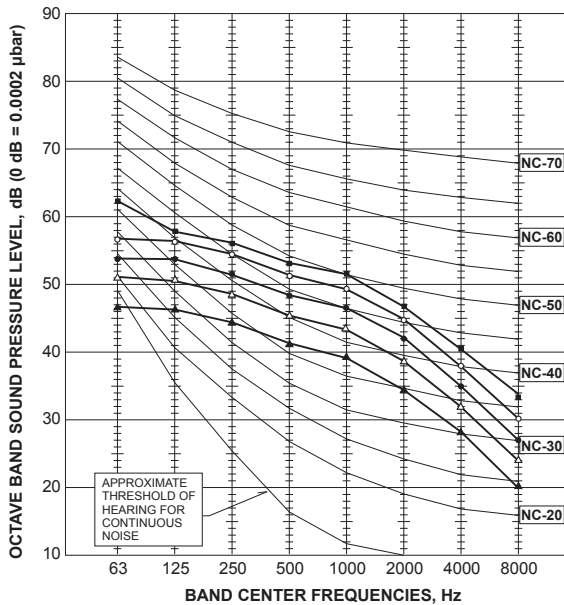

PUMY-SP112VKM.TH
 PUMY-SP112YKM.TH
 PUMY-SP112VKM.TH-BS
 PUMY-SP112YKM.TH-BS

PUMY-SP125VKM.TH
 PUMY-SP125YKM.TH
 PUMY-SP125VKM.TH-BS
 PUMY-SP125YKM.TH-BS

PUMY-SP140VKM.TH
 PUMY-SP140YKM.TH
 PUMY-SP140VKM.TH-BS
 PUMY-SP140YKM.TH-BS

Unit: mm

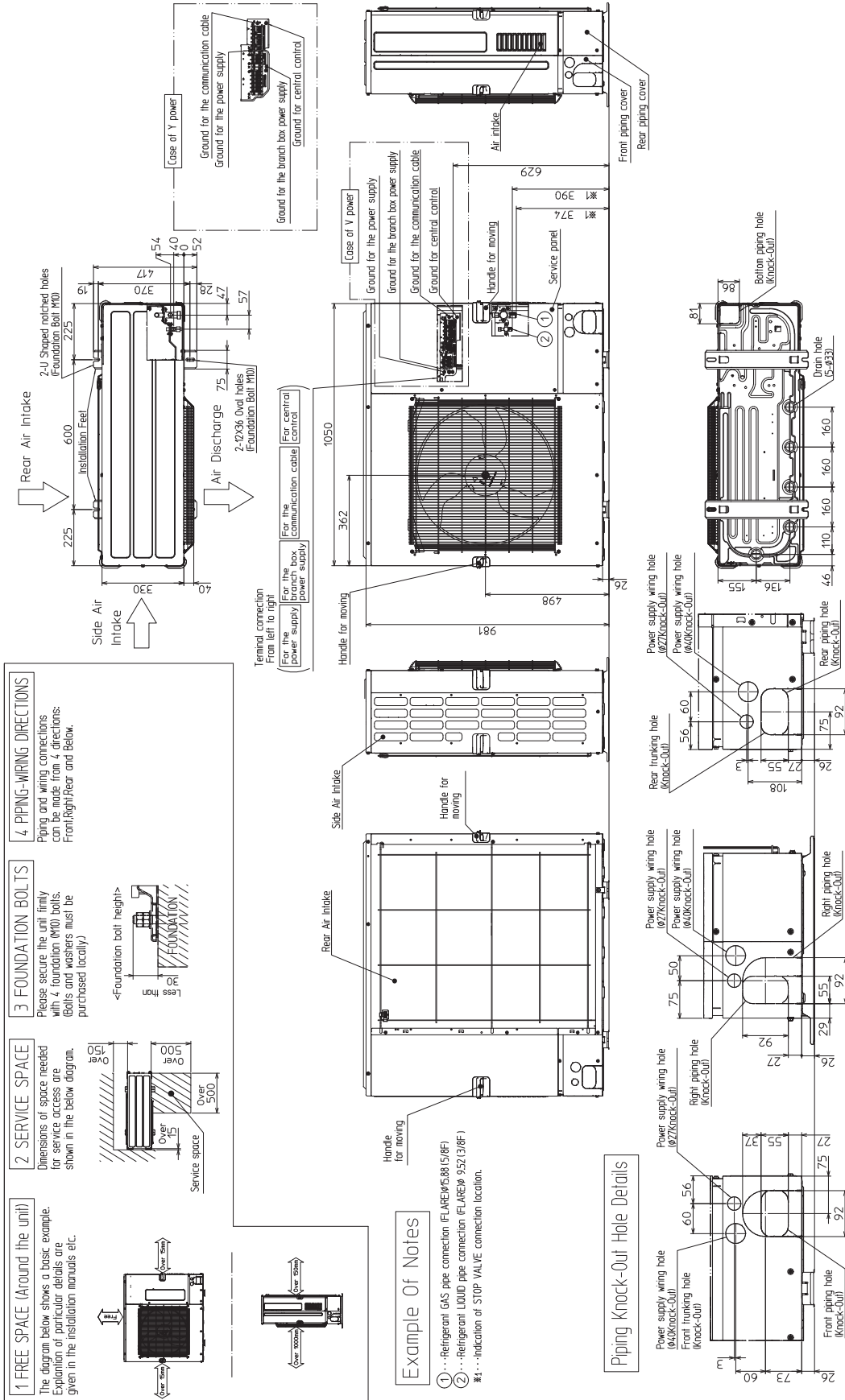

PUMY-SP112VKM.TH
PUMY-SP112VKM.TH-BS

PUMY-SP125VKM.TH
PUMY-SP125VKM.TH-BS

PUMY-SP140VKM.TH
PUMY-SP140VKM.TH-BS

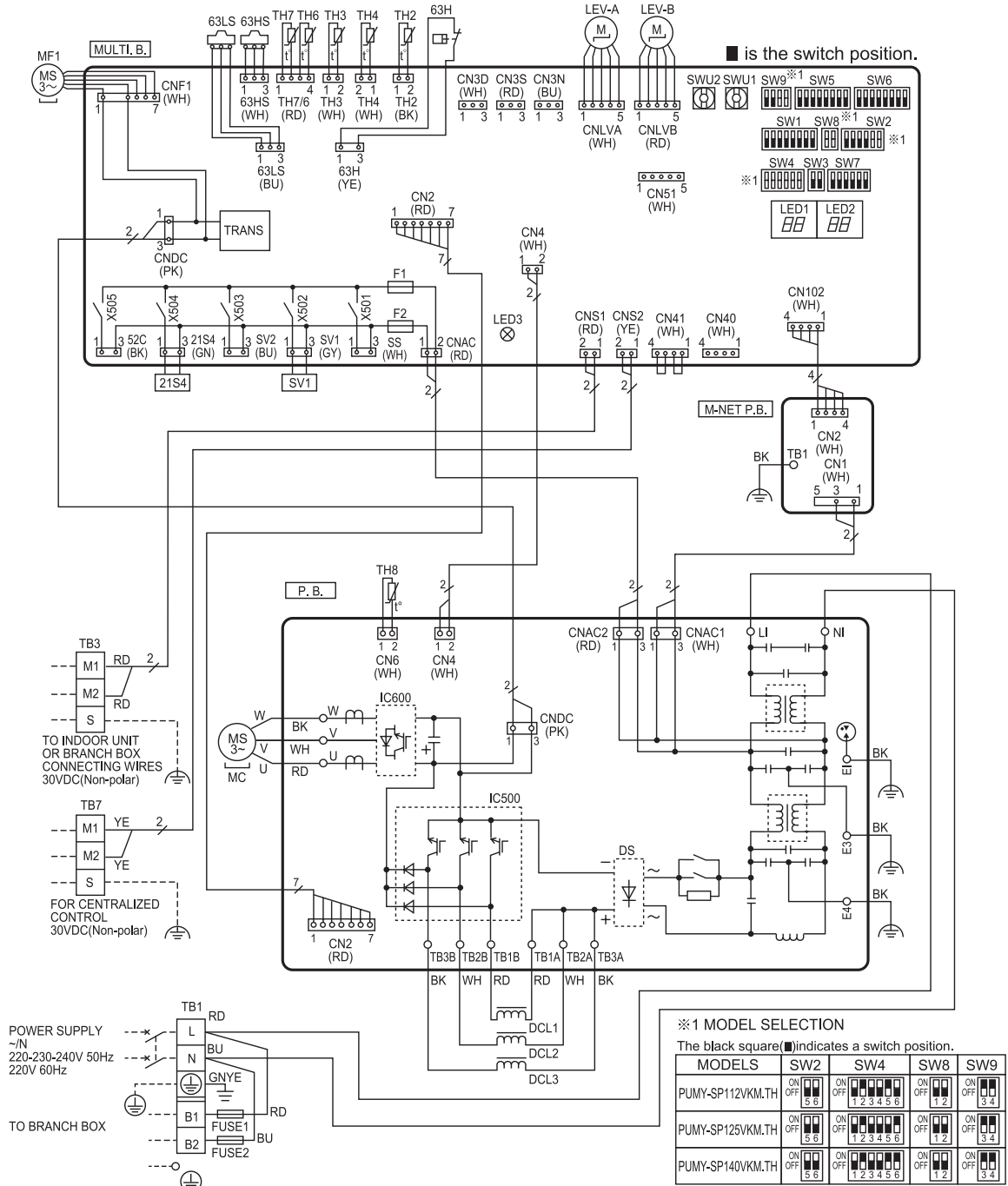

SYMBOL	NAME	SYMBOL	NAME	SYMBOL	NAME
TB1	Terminal Block <Power Supply/Branch Box>	TH8	Thermistor<Heat Sink>	SW8	Switch<Model Selection>
TB3	Terminal Block <Indoor/Outdoor, Branch Box/Outdoor Transmission Line>	LEV-A, LEV-B	Linear Expansion Valve	SW9	Switch<Function Selection>
TB7	Terminal Block <Centralized Control Transmission Line>	DCL1, DCL2, DCL3	Reactor	SWU1	Switch<Unit Address Selection, ones digit>
FUSE1, FUSE2	Fuse <T20AL250V>	P.B.	Power Circuit Board	SWU2	Switch<Unit Address Selection, tens digit>
MC	Motor for Compressor	U/V/W	Connection Terminal<U/V/W-Phase>	CNS1	Connector<Indoor/Outdoor, Branch Box/Outdoor Transmission Line>
MF1	Fan Motor	LI	Connection Terminal<L-Phase>	CNS2	Connector<Centralized Control Transmission Line>
63H	High Pressure Switch	NI	Connection Terminal<N-Phase>	SS	Connector<Connection for Option>
63HS	High Pressure Sensor	TB1A, TB2A, TB3A, TB1B, TB2B, TB3B	Connection Terminal<Reactor>	CN3D	Connector<Connection for Option>
63LS	Low Pressure Sensor	E1, E3, E4	Connection Terminal<Electrical Parts Box>	CN3S	Connector<Connection for Option>
SV1	Solenoid Valve Coil<Bypass Valve>	MULTI.B.	Multi Controller Circuit Board	CN3N	Connector<Connection for Option>
21S4	Solenoid Valve Coil<4-Way Valve>	SW1	Switch<Display Selection>	CN51	Connector<Connection for Option>
TH2	Thermistor<Hic Pipe>	SW2	Switch<Function Selection>	LED1, LED2	LED<Operation Inspection Display>
TH3	Thermistor<Outdoor Liquid Pipe>	SW3	Switch<Test Run>	LED3	LED<Power Supply to Main Microcomputer>
TH4	Thermistor<Compressor>	SW4	Switch<Model Selection>	F1, F2	Fuse<T6.3AL250V>
TH6	Thermistor<Suction Pipe>	SW5	Switch<Function Selection>	X501~505	Relay
		SW6	Switch<Function Selection>	M-NET P.B.	M-NET Power Circuit Board

PUMY-SP112YKM.TH
PUMY-SP112YKM.TH-BS

PUMY-SP125YKM.TH
PUMY-SP125YKM.TH-BS

PUMY-SP140YKM.TH
PUMY-SP140YKM.TH-BS

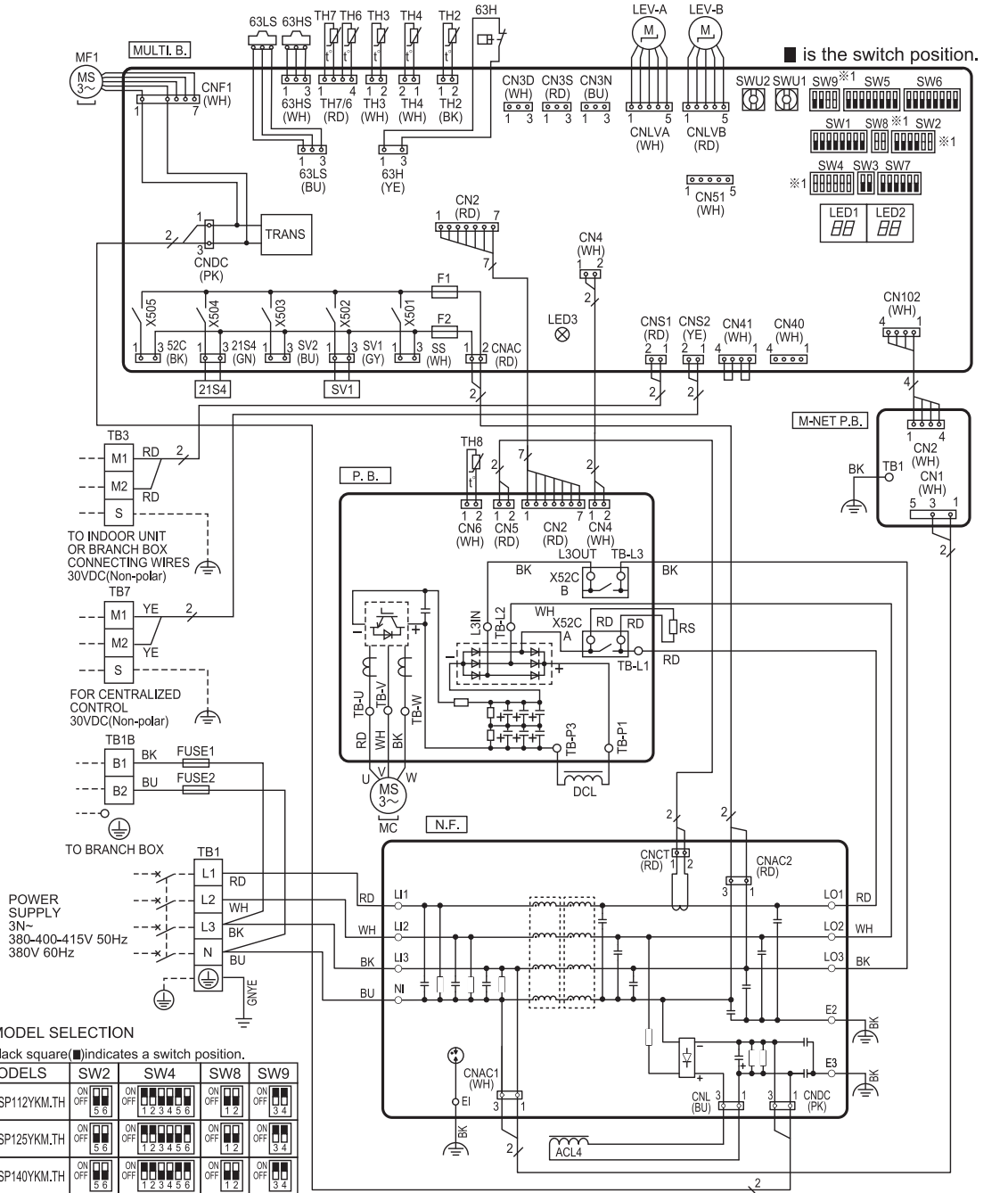

※1 MODEL SELECTION
 The black square (■) indicates a switch position.

MODELS	SW2	SW4	SW8	SW9
PUMY-SP112YKM.TH	ON OFF 1 2 3 4 5 6	ON OFF 1 2 3 4 5 6	ON OFF 1 2	ON OFF 3 4
PUMY-SP125YKM.TH	ON OFF 5 6	ON OFF 1 2 3 4 5 6	ON OFF 1 2	ON OFF 3 4
PUMY-SP140YKM.TH	ON OFF 5 6	ON OFF 1 2 3 4 5 6	ON OFF 1 2	ON OFF 3 4

SYMBOL	NAME	SYMBOL	NAME	SYMBOL	NAME
TB1	Terminal Block<Power Supply>	RS	Rush Current Protect Resistor	SW7	Switch<Function Selection>
TB1B	Terminal Block<Branch Box>	LEV-A, LEV-B	Linear Expansion Valve	SW8	Switch<Model Selection>
TB3	Terminal Block<Indoor/Outdoor, Branch Box/Outdoor Transmission Line>	ACL4	Reactor	SW9	Switch<Function Selection>
TB7	Terminal Block <Centralized Control Transmission Line>	DCL	Reactor	SWU1	Switch<Unit Address Selection, ones digit>
FUSE1,FUSE2	Fuse<T20AL250V>	P.B.	Power Circuit Board	SWU2	Switch<Unit Address Selection, tens digit>
MC	Motor for Compressor	TB-U/V/W	Connection Terminal<U/V/W-Phase>	CNS1	Connector<Indoor/Outdoor, Branch Box/ Outdoor Transmission Line>
MF1	Fan Motor	TB-L1/L2/L3	Connection Terminal<L1/L2/L3-Power Supply>	CNS2	Connector<Centralized Control Transmission Line>
63H	High Pressure Switch	TB-P1/P3	Connection Terminal	CNS3D	Connector<Connection for Option>
63HS	High Pressure Sensor	X52CA/B	52C Relay	CNS3S	Connector<Connection for Option>
63LS	Low Pressure Sensor	N.F.	Noise Filter Circuit Board	CN3N	Connector<Connection for Option>
SV1	Solenoid Valve Coil<Bypass Valve>	L01/L02/L03	Connection Terminal<L1/L2/L3-Power Supply>	CN51	Connector<Connection for Option>
21S4	Solenoid Valve Coil<4-Way Valve>	L1/L2/L3/NI	Connection Terminal<L1/L2/L3-Power Supply>	LED1,LED2	LED<Operation Inspection Display>
TH2	Thermistor<Hic Pipe>	E1, E2, E3	Connection Terminal<Electrical Parts Box>	LED3	LED<Power Supply to Main Microcomputer>
TH3	Thermistor<Outdoor Liquid Pipe>	MULTI.B.	Multi Controller Circuit Board	F1,F2	Fuse<T6.3AL250V>
TH4	Thermistor<Compressor>	SW1	Switch<Display Selection>	X501~505	Relay
TH6	Thermistor<Suction Pipe>	SW2	Switch<Function Selection>	M-NET P.B.	M-NET Power Circuit Board
TH7	Thermistor<Ambient>	SW3	Switch<Test Run>	TB1	Connection Terminal<Electrical Parts Box>
TH8	Thermistor<Heat Sink>	SW4	Switch<Model Selection>		
		SW5	Switch<Function Selection>		
		SW6	Switch<Function Selection>		

7-2. Special Function Operation and Settings for M-NET Remote Controller

(M-NET remote controller cannot be connected with a refrigerant system which includes branch box.)

- It is necessary to perform "group settings" and "paired settings" at making group settings of different refrigerant systems (multiple outdoor unit).

(A) Group settings: Enter the indoor unit controlled by the remote controller, check the content of entries, and clear entries, etc.

(B) Paired settings: Used to set the linked operation of a Lossnay unit.

(1) Entering address: Follow the steps below to enter the addresses of the indoor unit using the remote controller.

a) Group settings



- Turning off the remote controller: Press the ON/OFF button to stop operation (the indicator light will go off).
- Changing to indoor unit address display mode: If the FILTER and  buttons on the remote controller are pressed simultaneously and held for 2 seconds, the display shown in Figure 1 will appear.
- Changing address: Press the temperature adjustment  buttons to change the displayed address to the address to be entered.
- Entering the displayed address: Press the TEST RUN button to enter the indoor unit with the displayed address. The type of the unit will be displayed as shown in Figure 2 if entry is completed normally. If a selected indoor unit does not exist, an error signal will be displayed as shown in Figure 3. When this happens, check whether the indoor unit actually exists and perform entry again.
- Returning to the normal mode after completing entry: Press the FILTER and  buttons simultaneously and hold for 2 seconds to return to the normal mode.

Figure 1. (A) Group setting display

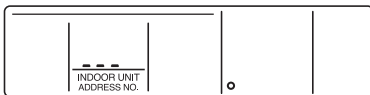

Figure 2. Normal completion of entry





Type of unit is displayed.

Figure 3. Entry error signal





Flashing "88" indicates entry error.

b) Paired Settings

- Turn off the remote controller: Press the remote controller's ON/OFF button to turn it off (the indicator light will go off).
- Put in indoor unit address display mode: Press the FILTER and  buttons on the remote controller simultaneously and hold for 2 seconds. Note: The above steps are the same as when making group settings (A).
- Changing to the linked operation unit address display state: The display shown in Figure 4 will appear when the  button on the remote control is pressed.
- Displaying the address of the Lossnay unit and linked indoor unit: In this situation, the indoor unit number will be the lowest address of the group. The Lossnay unit will not operate if this setting is incorrect.

Notes:

- If the temperature adjustment  buttons are pressed, the address may be changed to the indoor unit that is to be linked.
- If the time setting  buttons are pressed, the address of the linked units may be changed to the address where it is desired to enter the Lossnay.

- Linking the Lossnay and the indoor unit: The display shown in Figure 5 will appear when the TEST RUN button is pressed. The indoor unit whose address is displayed and the Lossnay unit with a linked address will operate in a linked manner.

Notes:

- If it is desired to display the address of the Lossnay in the indoor unit address, display the indoor unit address in the linked unit address, and the above content will also be recorded.
- Apart from the indoor unit with the lowest address in the group, display and enter the addresses of the other indoor unit that are to be linked with the Lossnay unit.

- Returning to the normal mode after completing entry: Press the FILTER and  buttons on the remote controller simultaneously and hold for 2 seconds to return to the normal mode.

Figure 4. (B) Making paired settings



The addresses of indoor unit and linked units are displayed simultaneously.

Figure 5. Completing normal entry

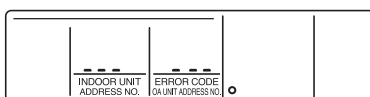
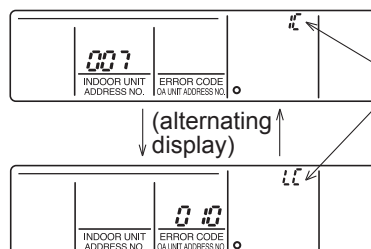



These alternating IC or LC displays will appear when entry is completed normally.







A flashing "88" will appear if there is a problem with the entry (indicating that the unit does not exist).

(2) Address check: Refer to section (1) regarding address entry.

a) In making group settings:

- Turn off the remote controller: Press the remote controller's ON/OFF button to stop operation (the indicator light will go off).
- Locate the indoor unit address display mode: Press the FILTER and  buttons on the remote controller simultaneously and hold for 2 seconds.
- Display indoor unit address: The entered indoor units address and type will be displayed each time the button is pressed.
* When 1 entry is made, only 1 address will be displayed no matter how many times the button is pressed.
- Returning to the normal mode after completing check: Simultaneously press the FILTER and  buttons on the remote controller and hold for 2 seconds to return to the normal mode.

b) In making paired settings:

- Turn off the remote controller: Press the remote controller's ON/OFF button to stop operation (the indicator light will go off).
- Put in indoor unit address display mode: Press the FILTER and  buttons on the remote controller simultaneously and hold for 2 seconds.
- Changing to the linked operation unit address display state: Press the  button on the remote control.
- Displaying the address of the indoor unit to be checked: Change the address to that of the indoor unit to be checked by pressing the temperature adjustment buttons  .
- Displaying the address of the linked Lossnay unit: Press the  button to display the addresses of the linked Lossnay and indoor unit in alternation.
- Displaying the addresses of other entered units: The addresses of the other entered units will be displayed in alternating fashion after resting the  button again.
- Returning to the normal mode after completing the check: Simultaneously press the FILTER and  buttons on the remote controller and hold for 2 seconds to return to the normal mode.

(3) Clearing an address: Refer to section (1) regarding the address entry and section (2) regarding checking addresses.

a) In making group settings:

- Turn off the remote controller: The procedure is the same as described in **a)** under (2) Address check.
- Put in the indoor unit address display mode: The procedure is the same as described in **a)** under (2) Address check.
- Displaying the indoor unit address to be cleared: The procedure is the same as described in **a)** under (2) Address check.
- Clearing indoor unit address : Pressing the  button on the remote controller twice will clear the address entry of the displayed indoor unit, resulting in the display shown in Figure 6.
The display shown in Figure 7 will appear if an abnormality occurs and the entry is not cleared.
Please repeat the clearing procedure.
- Returning to the normal mode after clearing an address: The procedure is the same as described in **a)** under (2) Address check.

Figure 6. Display after address has been cleared normally



"--" will appear in the room temperature display location.

Figure 7. Display when an abnormality has occurred during clearing

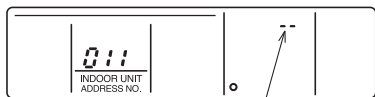
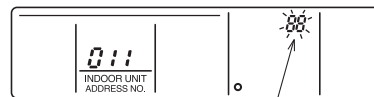

"88" will appear in the room temperature display location.

b) In making paired settings:

- Turn off the remote controller: The procedure is the same as described in **b)** under (2) Address check.
- Put into the indoor unit address display mode: The procedure is the same as described in **b)** under (2) Address check.
- Put into the linked unit address display mode: The procedure is the same as described in **b)** under (2) Address check.
- Display the address of the Lossnay unit or the indoor unit to be cleared.
- Deleting the address of a linked indoor unit: Pressing the  button on the remote controller twice will clear the address entry of the displayed indoor unit, resulting in the display shown in Figure 8.
- Returning to the normal mode after clearing an address: The procedure is same as **b)** in (2) Address check.

Figure 8. Display after address has been cleared normally



"--" will appear in the unit type display location when an address has been cleared normally.

"88" will appear in the unit type display location when an abnormality has occurred during clearing.

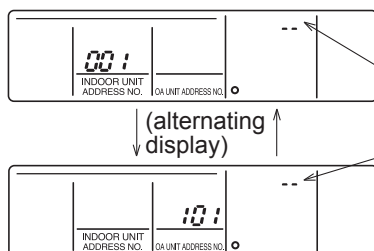
7-3. REFRIGERANT SYSTEM DIAGRAM

- | | | |
|----------------------------|----------------------------|----------------------------|
| PUMY-SP112VKM.TH | PUMY-SP125VKM.TH | PUMY-SP140VKM.TH |
| PUMY-SP112YKM.TH | PUMY-SP125YKM.TH | PUMY-SP140YKM.TH |
| PUMY-SP112VKM.TH-BS | PUMY-SP125VKM.TH-BS | PUMY-SP140VKM.TH-BS |
| PUMY-SP112YKM.TH-BS | PUMY-SP125YKM.TH-BS | PUMY-SP140YKM.TH-BS |

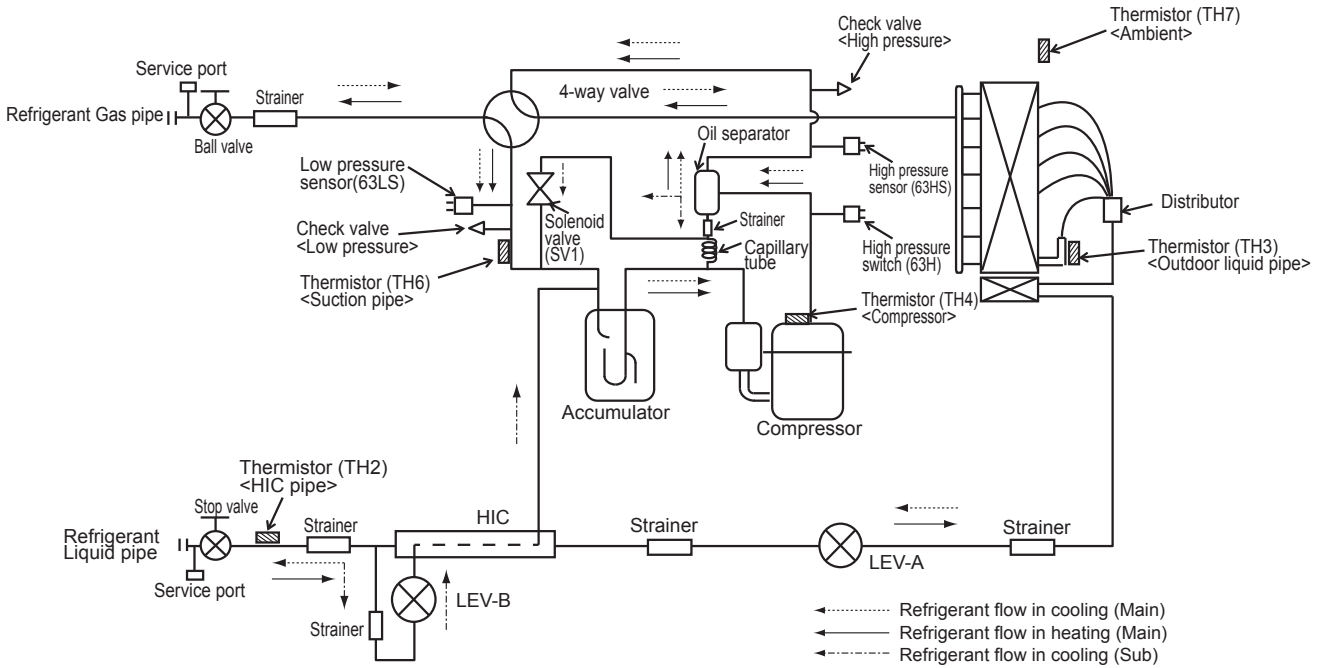

Capillary tube for oil separator : $\phi 2.5 \times \phi 0.6 \times L1000$

Refrigerant piping specifications <dimensions of flared connector>

Unit: mm <inch>

Capacity		Item	Liquid piping	Gas piping
City multi indoor unit	P15, P20, P25, P32, P40, P50	The farthest piping length from the first joint ≤ 30 m	$\phi 6.35$ <1/4>	$\phi 12.7$ <1/2>
		The farthest piping length from the first joint > 30 m	$\phi 9.52$ <3/8>	
	P63, P80, P100, P125, P140	$\phi 9.52$ <3/8>	$\phi 15.88$ <5/8>	
Outdoor unit	P112, P125, P140	$\phi 9.52$ <3/8>	$\phi 15.88$ <5/8>	

Note:
When connecting the CONNECTION KIT (PAC-LV11M-J) and an M-series indoor unit, refer to the installation manual for the CONNECTION KIT.

7-4. REFRIGERANT SYSTEM DIAGRAM (WHEN USING BRANCH BOX)

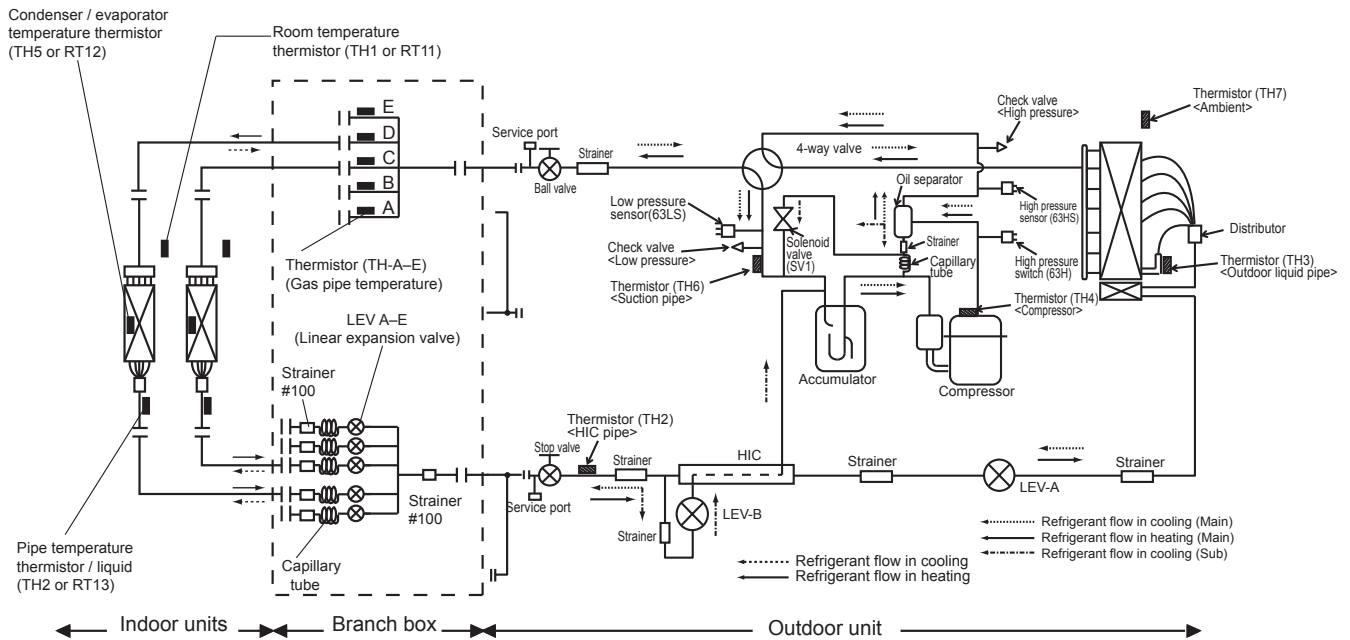

Unit: mm

		Capillary tube behind LEV (in cooling mode)
Branch box	PAC-MK31BC	($\phi 4.0 \times \phi 3.0 \times L130$) $\times 3$
	PAC-MK51BC	($\phi 4.0 \times \phi 3.0 \times L130$) $\times 5$

Piping connection size

	A	B
Liquid (mm)	$\phi 9.52$	The pipe connection size differs according to the type and capacity of indoor units. Match the piping connection size of branch box with indoor unit. If the piping connection size of branch box does not match the piping connection size of indoor unit, use optional different-diameter (deformed) joints to the branch box side. (Connect deformed joint directly to the branch box side.)
Gas (mm)	$\phi 15.88$	

- In case of using 1-branch box
Flare connection employed (No brazing)

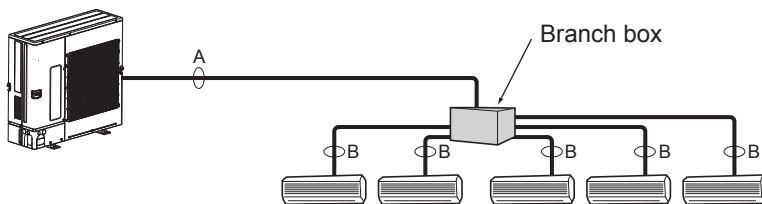

- In case of using 2-branch boxes

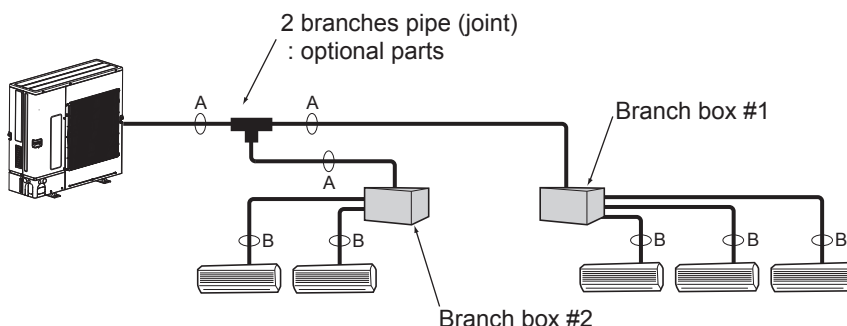

- Installation procedure (2 branch pipe (joint))
Refer to the installation manuals of MSDD-50AR-E.

■ Pipe size (Branch box-indoor unit)

Indoor unit series	Model number	Liquid pipe	Gas pipe
M series or S series	15-42	φ6.35	φ9.52
	50	φ6.35	φ12.7
	60	φ6.35	φ15.88
	71	φ9.52	φ15.88
P series	35-50	φ6.35	φ12.7
	60-100	φ9.52	φ15.88

When using 35, 50 type indoor unit of P series, use the flare nut (for R410A) attached to the indoor unit.
Do not use the flare nut (for R407C) in the indoor unit accessory. If it is used, a gas leakage or even a pipe extraction may occur.

(1) Valve size for outdoor unit

For liquid	φ9.52 mm
For gas	φ15.88 mm

(2) Valve size for branch unit

* A UNIT	Liquid pipe	φ6.35 mm
	Gas pipe	φ9.52 mm
* B UNIT	Liquid pipe	φ6.35 mm
	Gas pipe	φ9.52 mm
* C UNIT	Liquid pipe	φ6.35 mm
	Gas pipe	φ9.52 mm
D UNIT	Liquid pipe	φ6.35 mm
	Gas pipe	φ9.52 mm
E UNIT	Liquid pipe	φ6.35 mm
	Gas pipe	φ12.7 mm

* 3-branch type is only for **A**, **B**, and **C** unit.

Different-diameter joint (optional parts)

Type	Model name	Connected pipes diameter	Diameter A	Diameter B
		mm	mm	mm
Flare (Fig.7-1)	MAC-A454JP	φ9.52 → φ12.7	φ9.52	φ12.7
	MAC-A455JP	φ12.7 → φ9.52	φ12.7	φ9.52
	MAC-A456JP	φ12.7 → φ15.88	φ12.7	φ15.88
	PAC-493PI	φ6.35 → φ9.52	φ6.35	φ9.52
	PAC-SG76RJ-E	φ9.52 → φ15.88	φ9.52	φ15.88

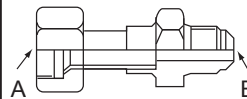

Fig.7-1

Conversion formula

1/4 inch	φ6.35 mm
3/8 inch	φ9.52 mm
1/2 inch	φ12.7 mm
5/8 inch	φ15.88 mm
3/4 inch	φ19.05 mm

7-5. SYSTEM CONTROL

7-5-1. Example for the System

- Example for wiring control cables, wiring method and address setting, permissible lengths, and the prohibited items are listed in the standard system with detailed explanation.

A. Example of a M-NET remote controller system (address setting is necessary.)

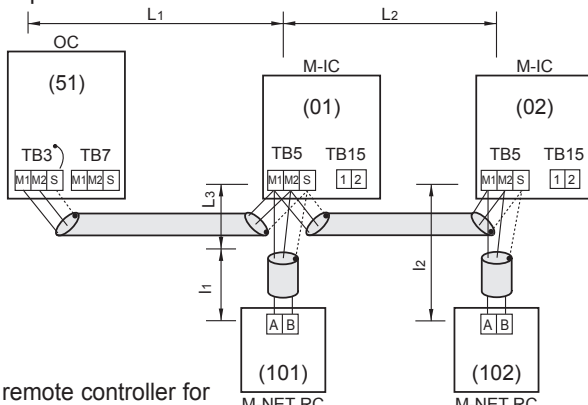
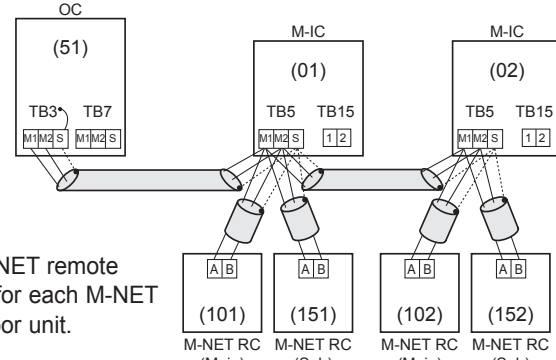
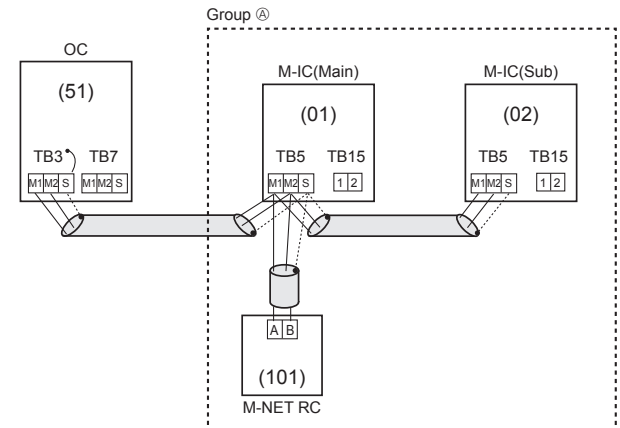
Example of wiring control cables	Wiring Method and Address Setting															
<p>1. Standard operation</p>  <ul style="list-style-type: none"> • 1 M-NET remote controller for each M-NET control indoor unit. • There is no need for setting the 100 position on the M-NET remote controller. 	<p>a. Use feed wiring to connect terminals M1 and M2 on transmission cable block (TB3) for the outdoor unit (OC) to terminals M1 and M2 on the transmission cable block (TB5) of each M-NET control indoor unit (M-IC). Use non-polarized 2-core wire.</p> <p>b. Connect terminals M1 and M2 on transmission cable terminal block (TB5) for each indoor unit with the terminal block (TB6) for M-NET the remote controller (M-NET RC).</p> <p>c. Set the address setting switch (on outdoor unit P.C.B) as shown below.</p> <table border="1" data-bbox="911 772 1527 987"> <thead> <tr> <th>Unit</th> <th>Range</th> <th>Setting Method</th> </tr> </thead> <tbody> <tr> <td>M-NET control indoor unit (M-IC)</td> <td>001 to 050</td> <td>—</td> </tr> <tr> <td>Outdoor unit (OC)</td> <td>051 to 100</td> <td>Use the smallest address of all the indoor unit plus 50.</td> </tr> <tr> <td>M-NET Remote controller (M-NET RC)</td> <td>101 to 150</td> <td>Indoor unit address plus 100</td> </tr> </tbody> </table>	Unit	Range	Setting Method	M-NET control indoor unit (M-IC)	001 to 050	—	Outdoor unit (OC)	051 to 100	Use the smallest address of all the indoor unit plus 50.	M-NET Remote controller (M-NET RC)	101 to 150	Indoor unit address plus 100			
Unit	Range	Setting Method														
M-NET control indoor unit (M-IC)	001 to 050	—														
Outdoor unit (OC)	051 to 100	Use the smallest address of all the indoor unit plus 50.														
M-NET Remote controller (M-NET RC)	101 to 150	Indoor unit address plus 100														
<p>2. Operation using 2 M-NET remote controllers</p>  <ul style="list-style-type: none"> • Using 2 M-NET remote controllers for each M-NET control indoor unit. 	<p>a. Same as above a</p> <p>b. Same as above b</p> <p>c. Set address switch (on outdoor unit P.C.B) as shown below.</p> <table border="1" data-bbox="911 1108 1527 1417"> <thead> <tr> <th>Unit</th> <th>Range</th> <th>Setting Method</th> </tr> </thead> <tbody> <tr> <td>M-NET control indoor unit (M-IC)</td> <td>001 to 050</td> <td>—</td> </tr> <tr> <td>Outdoor unit (OC)</td> <td>051 to 100</td> <td>Use the smallest address of all the indoor units plus 50.</td> </tr> <tr> <td>Main M-NET Remote Controller (M-NET RC)</td> <td>101 to 150</td> <td>Indoor unit address plus 100</td> </tr> <tr> <td>Sub M-NET Remote Controller (M-NET RC)</td> <td>151 to 200</td> <td>Indoor unit address plus 150</td> </tr> </tbody> </table>	Unit	Range	Setting Method	M-NET control indoor unit (M-IC)	001 to 050	—	Outdoor unit (OC)	051 to 100	Use the smallest address of all the indoor units plus 50.	Main M-NET Remote Controller (M-NET RC)	101 to 150	Indoor unit address plus 100	Sub M-NET Remote Controller (M-NET RC)	151 to 200	Indoor unit address plus 150
Unit	Range	Setting Method														
M-NET control indoor unit (M-IC)	001 to 050	—														
Outdoor unit (OC)	051 to 100	Use the smallest address of all the indoor units plus 50.														
Main M-NET Remote Controller (M-NET RC)	101 to 150	Indoor unit address plus 100														
Sub M-NET Remote Controller (M-NET RC)	151 to 200	Indoor unit address plus 150														
<p>3. Group operation</p>  <ul style="list-style-type: none"> • Multiple M-NET control indoor units operated together by 1 M-NET remote controller 	<p>a. Same as above a</p> <p>b. Connect terminals M1 and M2 on transmission cable terminal block (TB5) of the M-IC main unit with the most recent address within the same M-NET control indoor unit (M-IC) group to terminal block (TB6) on the M-NET remote controller.</p> <p>c. Set the address setting switch (on outdoor unit P.C.B) as shown below.</p> <table border="1" data-bbox="911 1612 1527 1960"> <thead> <tr> <th>Unit</th> <th>Range</th> <th>Setting Method</th> </tr> </thead> <tbody> <tr> <td>M-IC (Main)</td> <td>001 to 050</td> <td>Use the smallest address within the same group of M-NET control indoor units.</td> </tr> <tr> <td>M-IC (Sub)</td> <td>001 to 050</td> <td>Use an address, other than that of the M-IC (Main) from among the units within the same group of indoor units. This must be in sequence with the M-IC (Main).</td> </tr> <tr> <td>Outdoor unit</td> <td>051 to 100</td> <td>Use the smallest address of all the M-NET control indoor units plus 50.</td> </tr> <tr> <td>Main M-NET Remote Controller (M-NET RC)</td> <td>101 to 150</td> <td>Set at an M-IC (Main) address within the same group plus 100.</td> </tr> </tbody> </table> <p>d. Use the M-NET control indoor unit (M-IC) within the group with the most functions as the M-IC (Main) unit.</p>	Unit	Range	Setting Method	M-IC (Main)	001 to 050	Use the smallest address within the same group of M-NET control indoor units.	M-IC (Sub)	001 to 050	Use an address, other than that of the M-IC (Main) from among the units within the same group of indoor units. This must be in sequence with the M-IC (Main).	Outdoor unit	051 to 100	Use the smallest address of all the M-NET control indoor units plus 50.	Main M-NET Remote Controller (M-NET RC)	101 to 150	Set at an M-IC (Main) address within the same group plus 100.
Unit	Range	Setting Method														
M-IC (Main)	001 to 050	Use the smallest address within the same group of M-NET control indoor units.														
M-IC (Sub)	001 to 050	Use an address, other than that of the M-IC (Main) from among the units within the same group of indoor units. This must be in sequence with the M-IC (Main).														
Outdoor unit	051 to 100	Use the smallest address of all the M-NET control indoor units plus 50.														
Main M-NET Remote Controller (M-NET RC)	101 to 150	Set at an M-IC (Main) address within the same group plus 100.														

Combinations of 1 through 3 above are possible.

• Name, Symbol and the Maximum Remote controller Units for Connection

Name	Symbol	Maximum units for connection
Outdoor unit	OC	—
M-NET control Indoor unit	M-IC	1 OC unit can be connected to 1 to 9 (SP112)/1 to 10 (SP125)/1 to 12 (SP140) M-IC units
M-NET remote controller	M-NET RC	Maximum 2 M-NET RC for 1 indoor unit, Maximum 12 M-NET RC for 1 OC

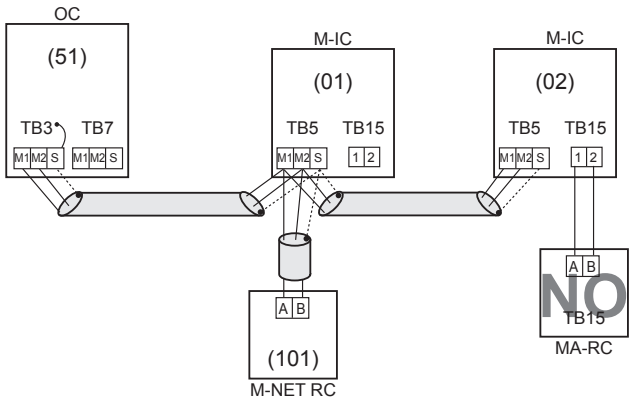
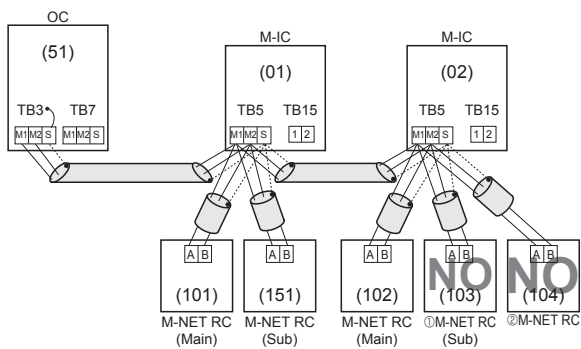
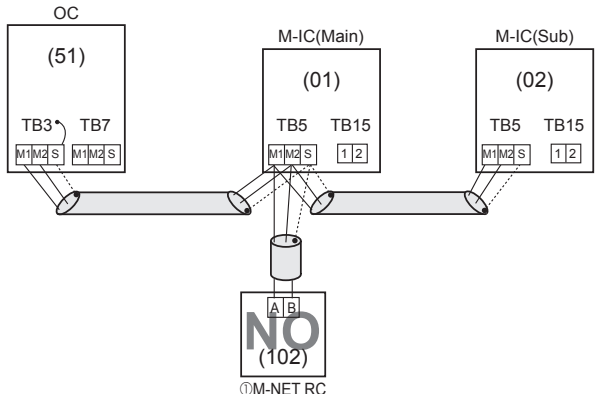
Permissible Lengths	Prohibited items
<p>Longest transmission cable length (1.25 mm²) $L_1 + L_2, L_3 + L_1 \leq 200$ m M-NET Remote controller cable length 1. If 0.5 to 1.25 mm² $l_1, l_2 \leq 10$ m 2. If the length exceeds 10 m, the exceeding section should be 1.25 mm² and that section should be a value within the total extension length of the transmission cable and maximum transmission cable length. (L3)</p>	<ul style="list-style-type: none"> M-NET remote controller (M-NET RC) and MA remote controller (MA RC) cannot be used together. Do not connect anything with TB15 of M-NET control indoor unit (M-IC). 
Same as above	 <ul style="list-style-type: none"> ① Use the M-NET control indoor unit (M-IC) address plus 150 as the sub M-NET remote controller address. In this case, it should be 152. ② 3 or more M-NET remote controllers (M-NET RC) cannot be connected to 1 M-NET control indoor unit.
Same as above	 <ul style="list-style-type: none"> ① The M-NET remote controller address is the M-NET control indoor unit main address plus 100. In this case, it should be 101.

B. Example of a group operation system with 2 or more outdoor units and a M-NET remote controller.
(Address settings are necessary.)

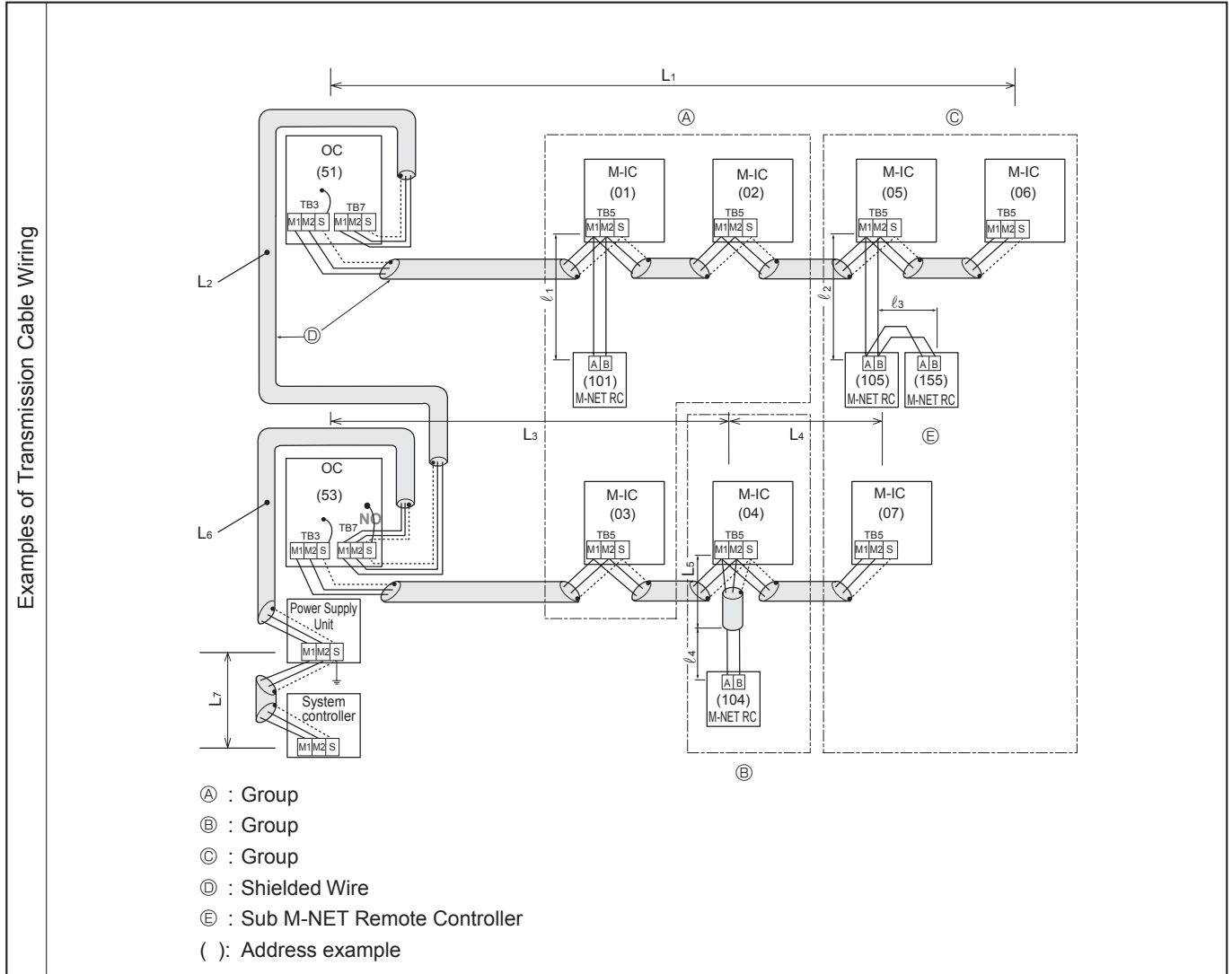

- Wiring Method Address Settings
- Always use shielded wire when making connections between the outdoor unit (OC) and the M-NET control indoor unit (M-IC), as well for all OC-OC, and IC-IC wiring intervals.
 - Use feed wiring to connect terminals M1 and M2 and the ground terminal on the transmission cable terminal block (TB3) of each outdoor unit (OC) to terminals M1 and M2 on the terminal S on the transmission cable terminal block of the M-NET control indoor unit (M-IC).
 - Connect terminals M1 and M2 on the transmission cable terminal block of the M-NET control indoor unit (M-IC) that has the most recent address within the same group to the terminal block on the M-NET remote controller (M-NET RC).
 - Connect together terminals M1, M2 and terminal S on the terminal block for centralized control (TB7) for the outdoor unit (OC).
 - DO NOT change the jumper connector CN41 on outdoor multi controller circuit board.
 - The earth processing of S terminal for the centralized control terminal block (TB7) is unnecessary. Connect the terminal S on the power supply unit with the earth.
 - Set the address setting switch as follows.

Unit	Range	Setting Method
M-IC (Main)	01 to 50	Use the smallest address within the same group of M-NET control indoor units.
M-IC (Sub)	01 to 50	Use an address, other than the M-IC (Main) in the same group of M-NET control indoor units. This must be in sequence with the M-IC (Main).
Outdoor Unit	51 to 100	Use the smallest address of all the M-NET control indoor units plus 50. The address automatically becomes "100" if it is set as "01-50".
Main M-NET Remote Controller	101 to 150	Set at an M-IC (Main) address within the same group plus 100.
Sub M-NET Remote Controller	151 to 200	Set at an M-IC (Main) address within the same group plus 150.
MA Remote Controller	—	Address setting is not necessary. (Main/sub setting is necessary.)

h. The group setting operations among the multiple M-NET control indoor units is done by the M-NET remote controller (M-NET RC) after the electrical power has been turned on.

• Name, Symbol, and the Maximum Units for Connection

- Permissible Length
- Longest length via outdoor units : $L_1+L_2+L_3+L_4, L_1+L_2+L_3+L_5, L_1+L_2+L_6+L_7 \leq 500 \text{ m}$ (1.25 mm^2)
 - Longest transmission cable length : $L_1, L_3+L_4, L_3+L_5, L_2+L_6, L_7 \leq 200 \text{ m}$ (1.25 mm^2)
 - M-NET Remote controller cable length : $l_1, l_2, l_2+l_3, l_4 \leq 10 \text{ m}$ ($0.5 \text{ to } 1.25 \text{ mm}^2$)
- If the length exceeds 10 m, use a 1.25 mm^2 shielded wire. The length of this section (L_8) should be included in the calculation of the maximum length and overall length.

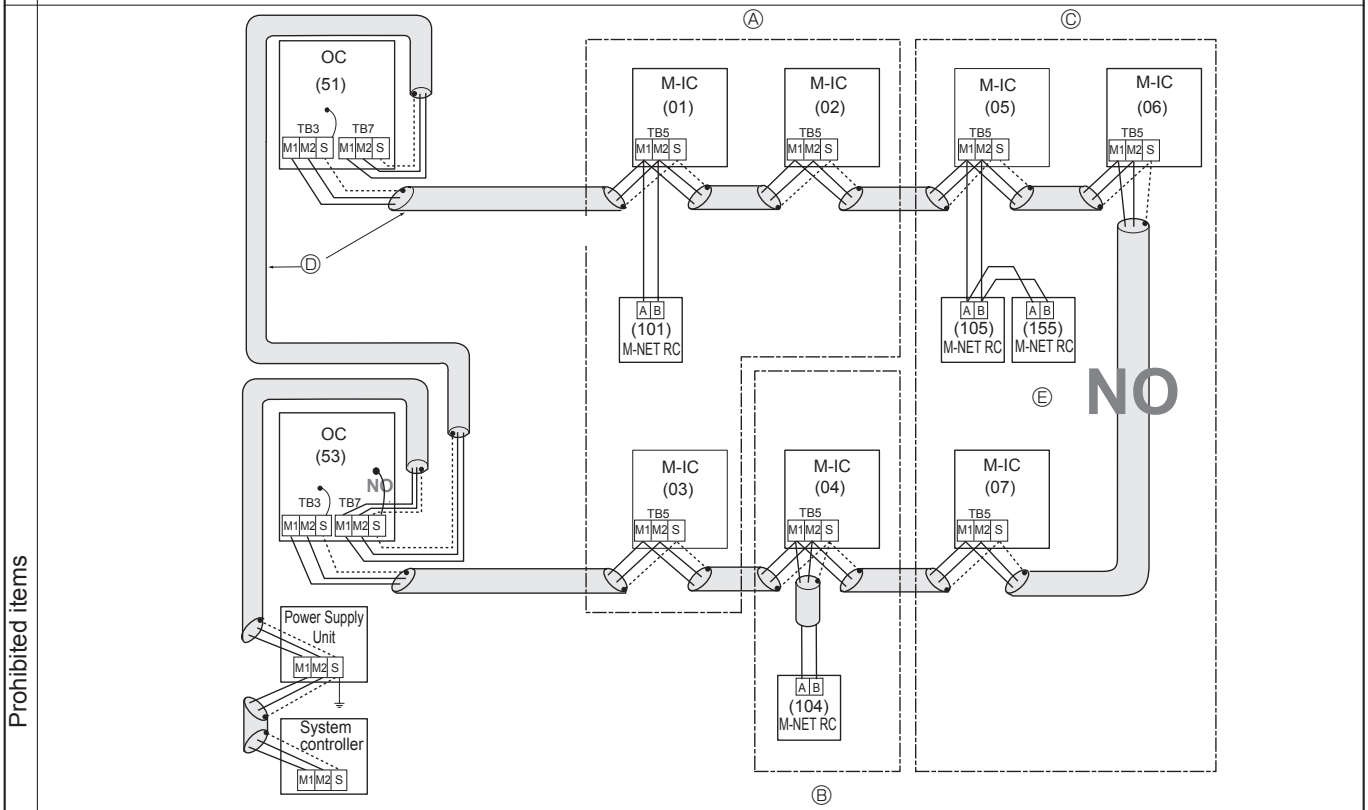

- Ⓐ : Group
- Ⓑ : Group
- Ⓒ : Group
- Ⓓ : Shielded Wire
- Ⓔ : Sub M-NET Remote Controller
- () : Address example

- Never connect together the terminal blocks (TB5) for transmission wires for M-NET control indoor units (M-IC) that have been connected to different outdoor units (OC).
- Set all addresses to ensure that they are not overlapped.
- M-NET remote controller and MA remote controller cannot be connected with the M-NET control indoor unit of the same group wiring together.

C. Example of a MA remote controller system (address setting is not necessary.)

NOTE : In the case of same group operation, need to set the address that is only main M-NET control indoor unit.

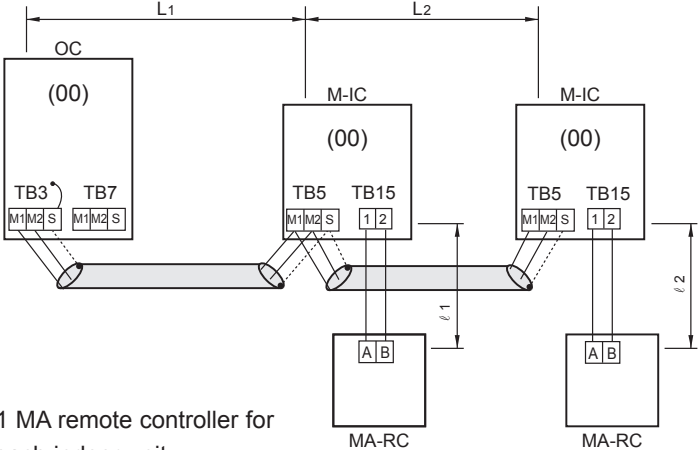
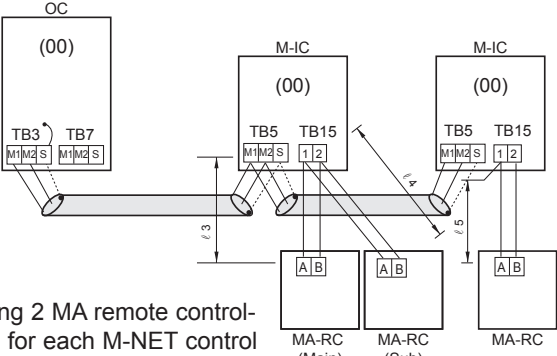
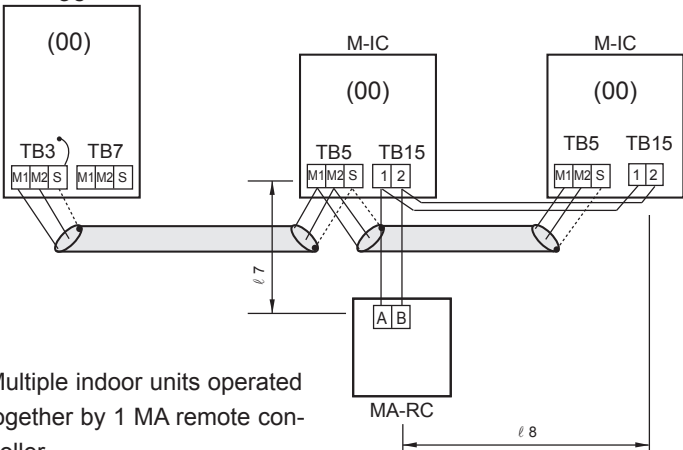
Example of wiring control cables	Wiring Method and Address Setting
<p>1. Standard operation</p>  <p>• 1 MA remote controller for each indoor unit.</p>	<p>a. Use feed wiring to connect terminals M1 and M2 on transmission cable block (TB3) for the outdoor unit (OC) to terminals M1 and M2 on the transmission cable block (TB5) of each M-NET control indoor unit (M-IC). Use non-polarized 2-core wire.</p> <p>b. Connect terminals 1 and 2 on transmission cable terminal block (TB15) for each M-NET control indoor unit with the terminal block for the MA remote controller (MA-RC).</p>
<p>2. Operation using 2 remote controllers</p>  <p>• Using 2 MA remote controllers for each M-NET control indoor unit.</p>	<p>a. The same as above a</p> <p>b. The same as above b</p> <p>c. In the case of using 2 remote controllers, connect terminals 1 and 2 on transmission cable terminal block (TB15) for each indoor unit with the terminal block for 2 MA remote controllers.</p> <p>· Set either one of the MA remote controllers to "sub remote controller".</p> <p>Refer to the installation manual of MA remote controller.</p>
<p>3. Group operation</p>  <p>• Multiple indoor units operated together by 1 MA remote controller.</p>	<p>a. The same as above a</p> <p>b. The same as above b</p> <p>c. Connect terminals 1 and 2 on transmission cable terminal block (TB15) of each M-NET control indoor unit, which is doing group operation with the terminal block the MA remote controller. Use non-polarized 2-core wire.</p> <p>d. In the case of same group operation, need to set the address that is only main M-NET control indoor unit. Please set the smallest address within number 01–50 of the M-NET control indoor unit with the most functions in the same group.</p>
<p>Combinations of 1 through 3 above are possible.</p>	

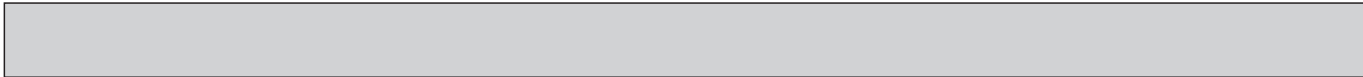

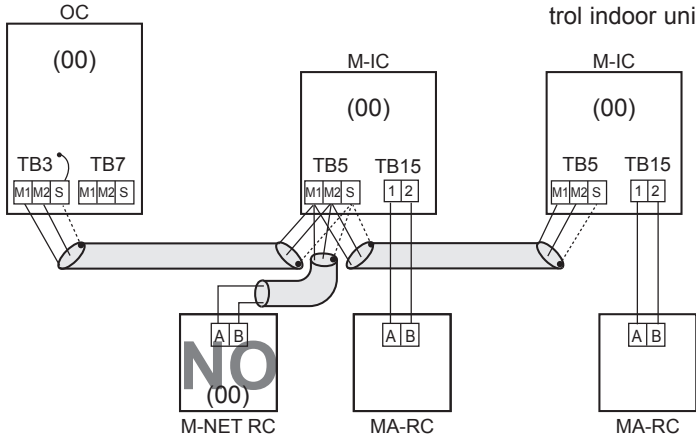
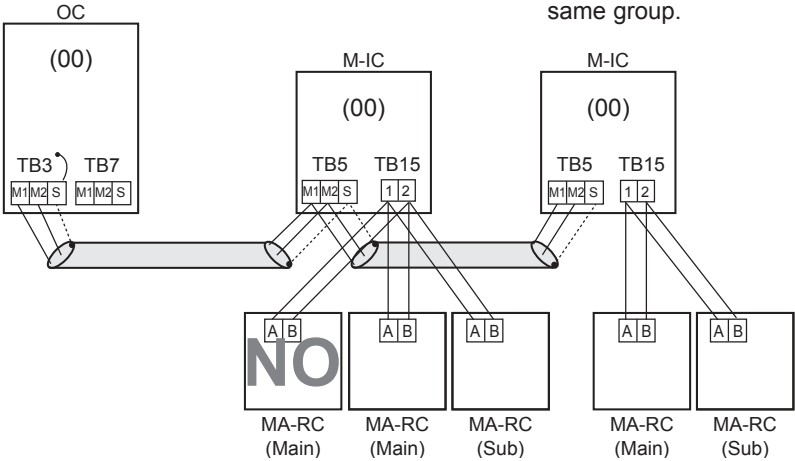
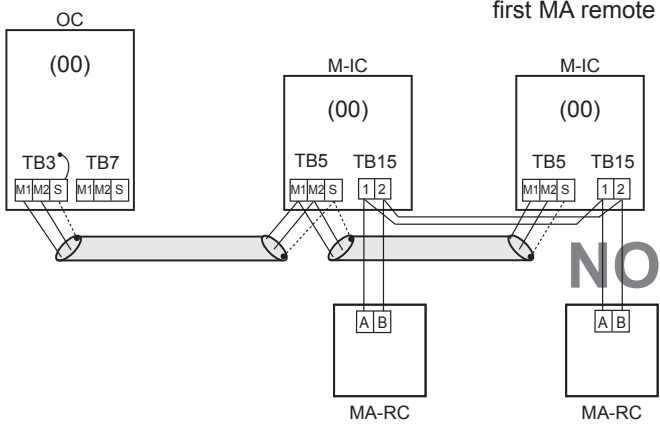
Permissible Lengths	Prohibited items
<p>Longest transmission cable length: $L_1 + L_2 \leq 200 \text{ m}$ (1.25 mm²) MA remote controller cable length: $l_1, l_2 \leq 200 \text{ m}$ (0.3 to 1.25 mm²)</p>	<p>The MA remote controller and the M-NET remote controller cannot be used together with the M-NET control indoor unit of the same group.</p>  <p>The diagram shows an Outdoor Controller (OC) connected to a common bus. The bus is connected to two M-IC indoor units. The first M-IC is connected to an M-NET RC and an MA-RC. The second M-IC is connected to an MA-RC. A large 'NO' is overlaid on the M-NET RC, indicating this configuration is prohibited.</p>
<p>Longest transmission cable length: $L_1 + L_2 \leq 200 \text{ m}$ (1.25 mm²) MA remote controller cable length: $l_3 + l_4, l_5 \leq 200 \text{ m}$ (0.3 to 1.25 mm²)</p>	<p>3 MA remote controllers or more cannot be connected with the M-NET control indoor unit of the same group.</p>  <p>The diagram shows an OC connected to a common bus. The bus is connected to two M-IC indoor units. The first M-IC is connected to three MA-RC units (two labeled 'Main' and one 'Sub'). The second M-IC is connected to two MA-RC units (one 'Main' and one 'Sub'). A large 'NO' is overlaid on the first M-IC, indicating this configuration is prohibited.</p>
<p>Longest transmission cable length: $L_1 + L_2 \leq 200 \text{ m}$ (1.25 mm²) MA remote controller cable length: $l_7 + l_8 \leq 200 \text{ m}$ (0.3 to 1.25 mm²)</p>	<p>The second MA remote controller is connected with the terminal block (TB15) for the MA remote controller of the same M-NET control indoor unit (M-IC) as the first MA remote control.</p>  <p>The diagram shows an OC connected to a common bus. The bus is connected to two M-IC indoor units. The first M-IC is connected to one MA-RC. The second M-IC is connected to two MA-RC units, both connected to the same TB15 terminal block. A large 'NO' is overlaid on the second M-IC, indicating this configuration is prohibited.</p>

D. Example of a group operation with 2 or more outdoor units and a MA remote controller.
(Address settings are necessary.)

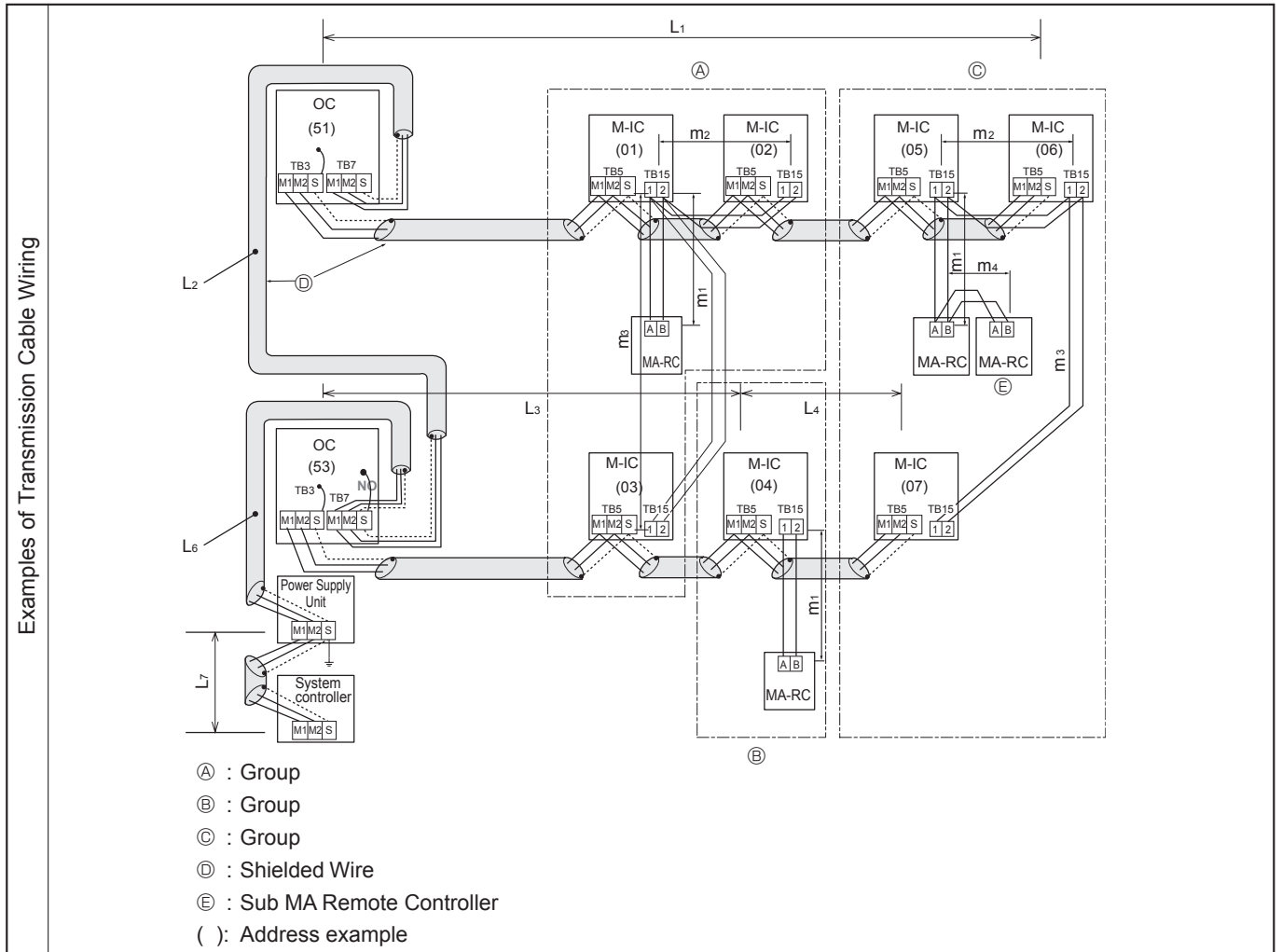

- Wiring Method Address Settings
- Always use shielded wire when making connections between the outdoor unit (OC) and the M-NET control indoor unit (M-IC), as well for all OC-OC, and IC-IC wiring intervals.
 - Use feed wiring to connect terminals M1 and M2 and the ground terminal on the transmission cable terminal block (TB3) of each outdoor unit (OC) to terminals M1 and M2 on the terminal S on the transmission cable terminal block of the M-NET control indoor unit (M-IC).
 - Connect terminals M1 and M2 on the transmission cable terminal block of the M-NET control indoor unit (M-IC) that has the most recent address within the same group to the terminal block on the M-NET remote controller (M-NET RC).
 - Connect together terminals M1, M2 and terminal S on the terminal block for centralized control (TB7) for the outdoor unit (OC).
 - DO NOT change the jumper connector CN41 on outdoor multi controller circuit board.
 - The earth processing of S terminal for the centralized control terminal block (TB7) is unnecessary. Connect the terminal S on the power supply unit with the earth.
 - Set the address setting switch as follows.

Unit	Range	Setting Method
M-IC (Main)	01 to 50	Use the smallest address within the same group of indoor units.
M-IC (Sub)	01 to 50	Use an address, other than the M-IC (Main) in the same group of M-NET indoor units. This must be in sequence with the M-IC (Main).
Outdoor Unit	51 to 100	Use the smallest address of all the indoor units plus 50. The address automatically becomes "100" if it is set as "01-50".
Main M-NET Remote Controller	101 to 150	Set at an M-IC (Main) address within the same group plus 100.
Sub M-NET Remote Controller	151 to 200	Set at an M-IC (Main) address within the same group plus 150.
MA Remote Controller	—	Address setting is not necessary. (Main/sub setting is necessary.)

h. The group setting operations among the multiple M-NET control indoor units is done by the M-NET remote controller (M-NET RC) after the electrical power has been turned on.

• Name, Symbol, and the Maximum Units for Connection

Permissible Length

Longest length via outdoor unit (M-NET cable): $L_1+L_2+L_3+L_4$ and $L_1+L_2+L_6+L_7 \leq 500$ m (1.25 mm² more)
 Longest transmission cable length (M-NET cable): L_1 and L_3+L_4 and L_2+L_6 and $L_7 \leq 200$ m (1.25 mm² or more)
 MA Remote controller cable length: m_1 and $m_1+m_2+m_3$ and $m_1+m_2+m_3+m_4 \leq 200$ m (0.3 to 1.25 mm²)

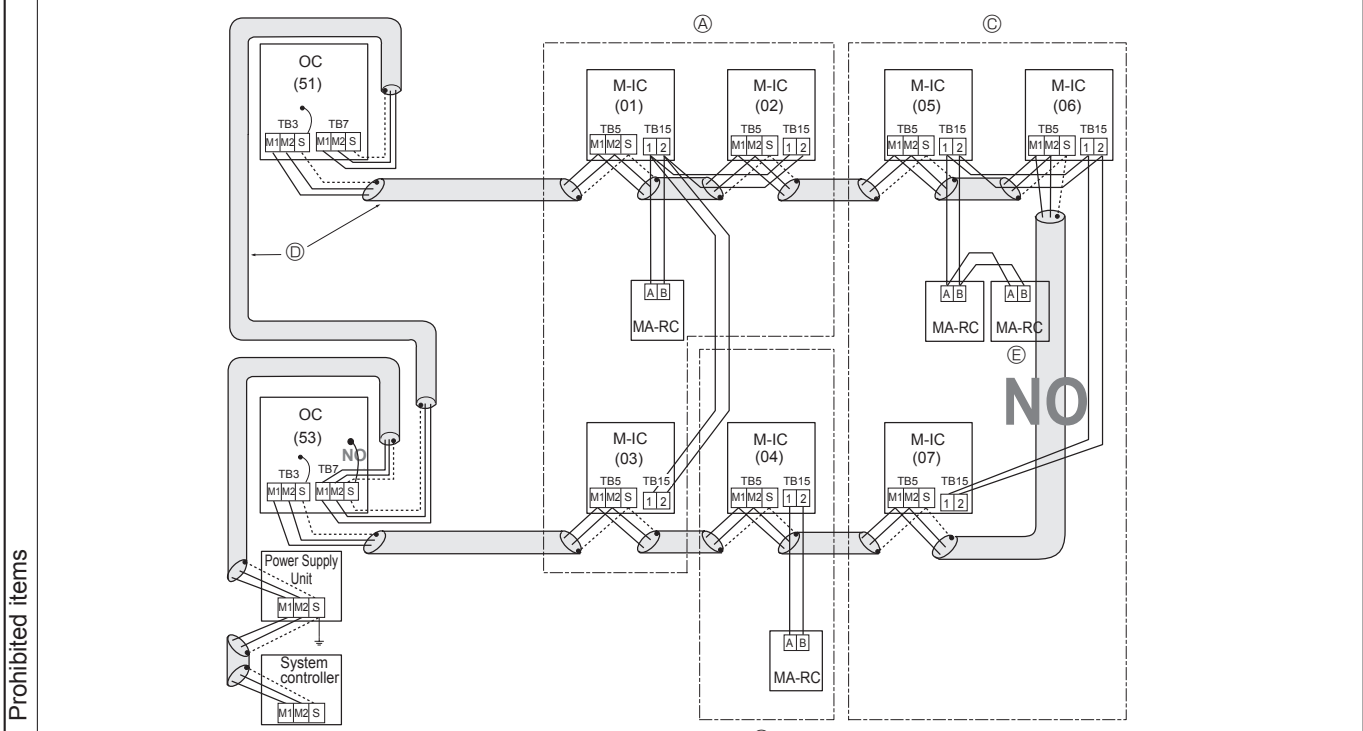

- Ⓐ : Group
- Ⓑ : Group
- Ⓒ : Group
- Ⓓ : Shielded Wire
- Ⓔ : Sub MA Remote Controller
- () : Address example

- Never connect together the terminal blocks (TB5) for transmission wires for M-NET control indoor units (M-IC) that have been connected to different outdoor units (OC).
- M-NET remote controller and MA remote controller cannot be connected with the M-NET control indoor unit of the same group wiring together.

E. Example of a system using Branch Box and A-Control indoor unit

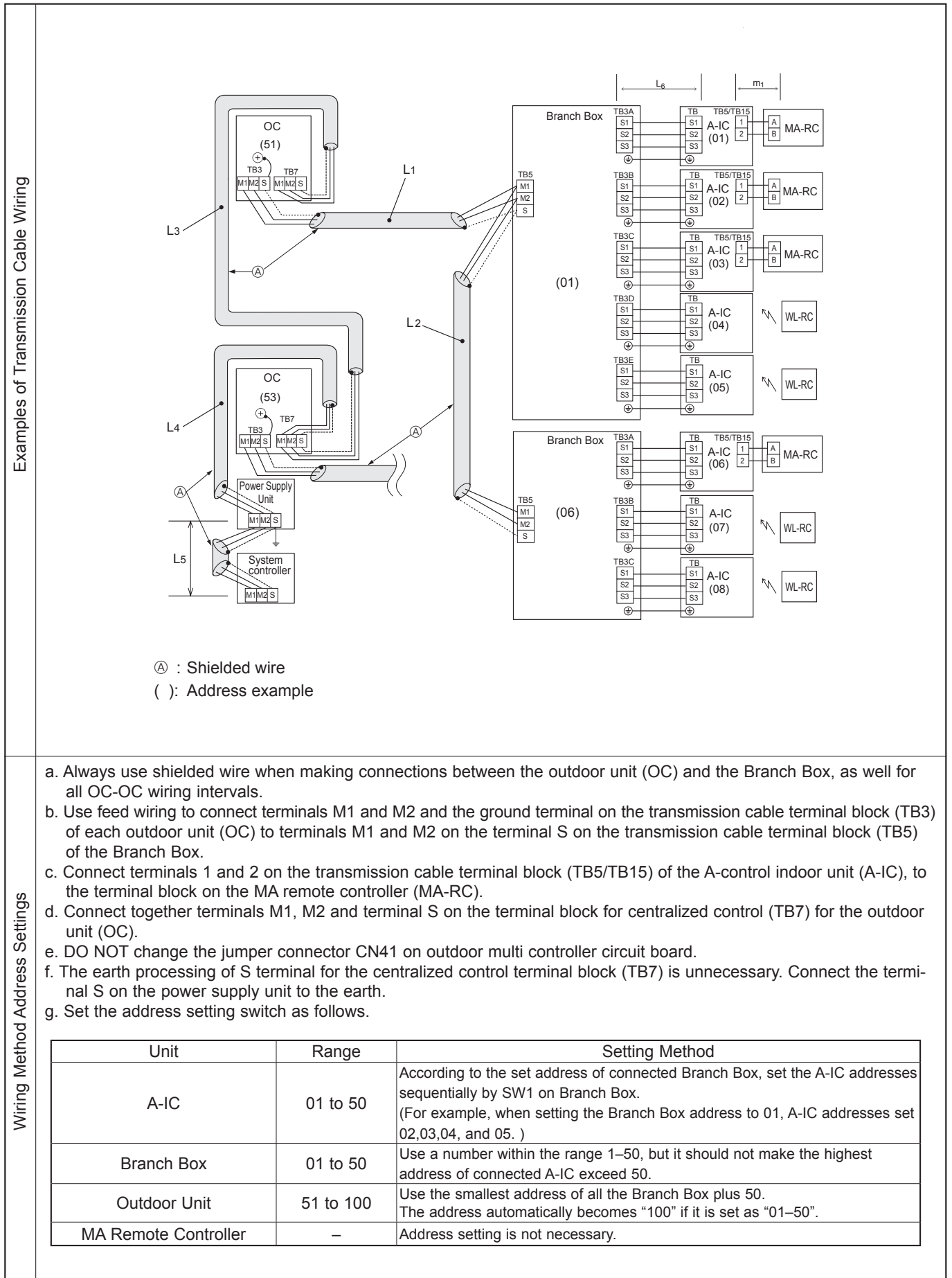

• Name, Symbol, and the Maximum Units for Connection

Permissible Length

Longest length via outdoor unit (M-NET cable): $L_1+L_2+L_3+L_4+L_5 \leq 500$ m (1.25 mm² or more)
 Longest transmission cable length (M-NET cable): $L_1+L_2, L_3+L_4, L_5 \leq 200$ m (1.25 mm² or more)
 Longest transmission cable length (A-Control cable): $L_6 \leq 25$ m (1.5 mm²)
 Remote controller cable length: $m_1 \leq 200$ m (0.3 to 1.25 mm²)

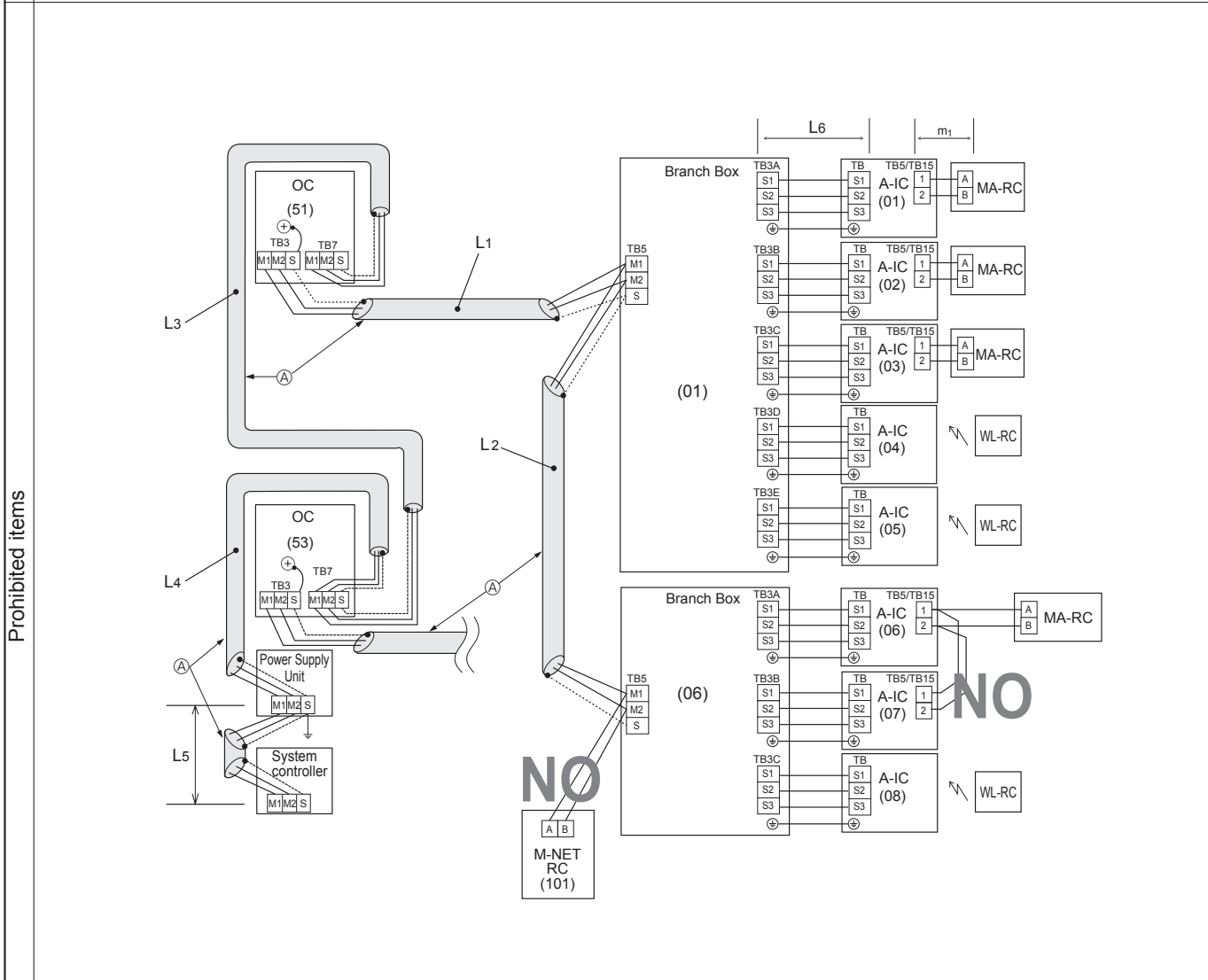

- Plural indoor units cannot be operated by a single remote controller
- Different refrigerant systems cannot be connected together.
- M-NET remote controller cannot be connected.

F. Example of a system using Branch Box, A-Control indoor unit, and M-NET Control indoor unit.

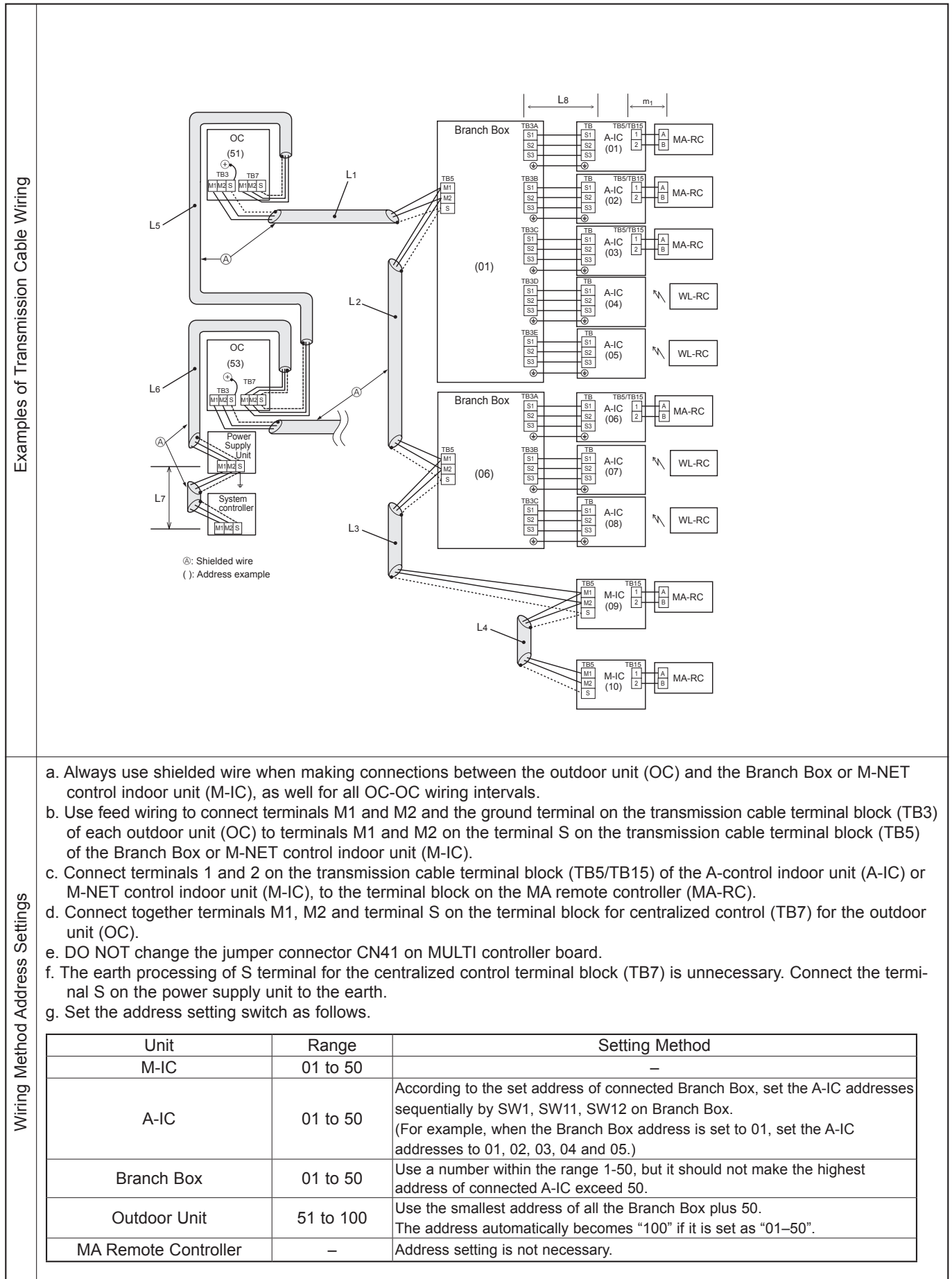

• Name, Symbol, and the Maximum Units for Connection

Permissible Length

Longest length via outdoor unit (M-NET cable): $L_1+L_2+L_3+L_4+L_5+L_6+L_7 \leq 500$ m (1.25 mm² or more)
 Longest transmission cable length (M-NET cable): $L_1+L_2+L_3+L_4, L_5+L_6$ and $L_7 \leq 200$ m (1.25 mm² or more)
 Longest transmission cable length (A-Control cable): $L_8 \leq 25$ m (1.5 mm²)
 Remote controller cable length: $m_1 \leq 200$ m (0.3 to 1.25 mm²)

Prohibited items

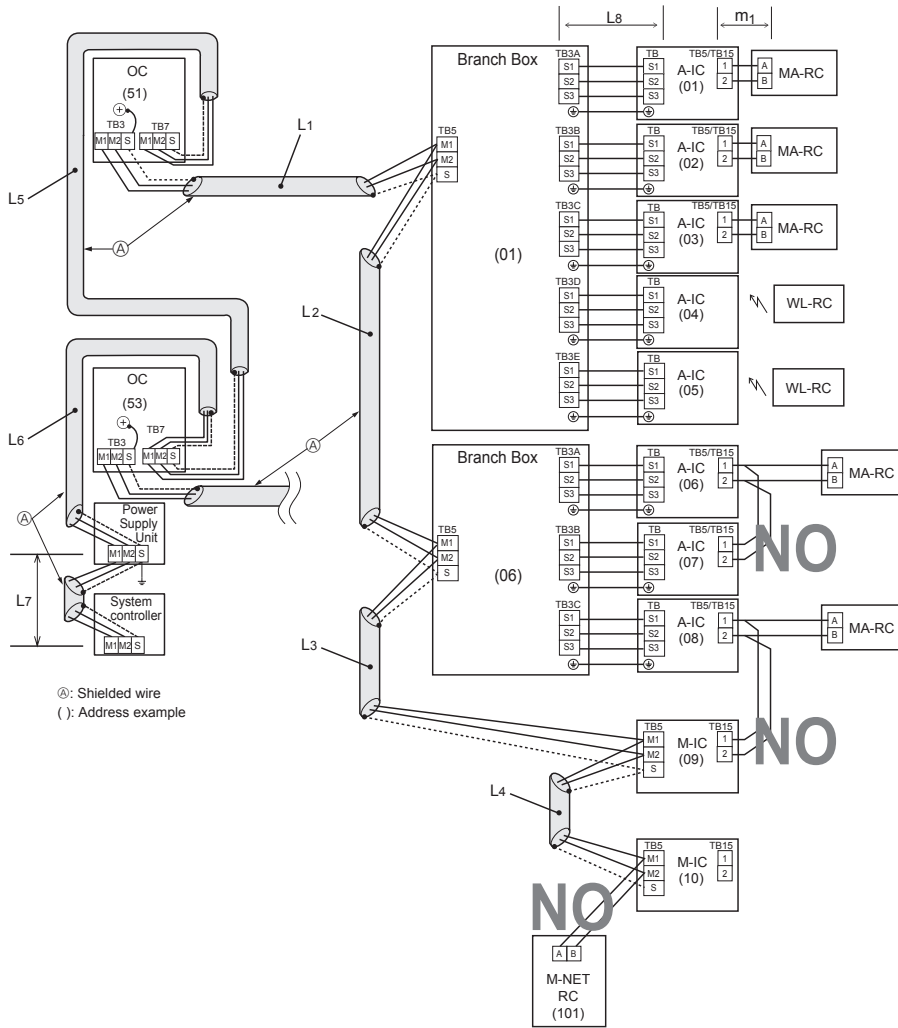

- Plural indoor units cannot be operated by a single remote controller
- Different refrigerant systems cannot be connected together.
- M-NET remote controller cannot be connected.

8-1. CHECK POINTS FOR TEST RUN

8-1-1. Procedures before test run

- (1) Before a test run, make sure that the following work is completed.
 - Installation related :
 - Make sure that the panel of cassette type and electrical wiring are done.
 - Otherwise electrical functions like auto vane will not operate normally.
 - Piping related :
 - Perform leakage test of refrigerant and drain piping.
 - Make sure that all joints are perfectly insulated.
 - Check stop valves on both liquid and gas side for full open.
 - Electrical wiring related :
 - Check ground wire, transmission cable, remote controller cable, and power supply cable for secure connection.
 - Make sure that all switch settings of address or adjustments for special specification systems are correctly settled.
- (2) Safety check :
 - With the insulation tester of 500 V, inspect the insulation resistance.
 - Do not touch the transmission cable and remote controller cable with the tester.
 - The resistance should be over 1.0 MΩ. Do not proceed inspection if the resistance is under 1.0 MΩ.
 - Inspect between the outdoor unit power supply terminal block and ground first, metallic parts like refrigerant pipes or the electrical box next, then inspect all electrical wiring of outdoor unit, indoor unit, and all linked equipment .
- (3) Before operation :
 - a) Turn the power supply switch of the outdoor unit to on for compressor protection. For a test run, wait at least 12 hours from this point.
 - b) Register control systems into remote controller(s). Never touch the ON/OFF switch of the remote controller(s). Refer to “7-2. Special Function Operation and Settings for M-NET Remote Controller” as for settings. In MA remote controller(s), this registration is unnecessary.
- (4) More than 12 hours later from power supply to the outdoor unit, turn all power switch to on for the test run. Perform test run according to the “Operation procedure” table of the bottom of this page. While test running, make test run reports .

8-1-1-1. Test run for M-NET Remote controller

(M-NET remote controller cannot be connected with a refrigerant system which includes branch box.)

When you deliver the unit after the test run, instruct the end user for proper usage of the system using owners' manual and the test run report you made to certificate normal operation. If abnormalities are detected during test run, refer to “8-1-2. Countermeasures for Error During Test Run”. As for DIP switch setting of outdoor unit, refer to “8-5. INTERNAL SWITCH FUNCTION TABLE”.

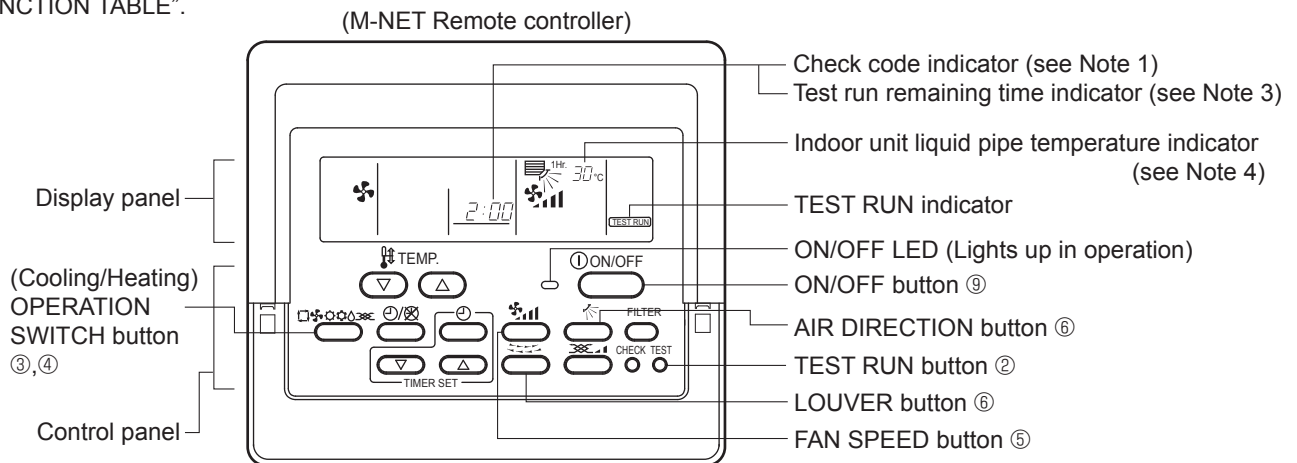

Operation procedure

①	Turn on the main power supply of all units at least 12 hours before test run. "HO" appears on display panel for 3 minutes.
②	12 hours later, press TEST RUN button twice to perform test run. "TEST RUN " appears on display panel.
③	Press OPERATION SWITCH button to make sure that air blows out.
④	Select Cooling (or Heating) by OPERATION SWITCH button to make sure that cool (or warm) air blows out.
⑤	Press Fan speed button to make sure that fan speed is changed by the button.
⑥	Press AIR DIRECTION button or LOUVER button to make sure that air direction is adjustable (horizontal, downward, upward, and each angle).
⑦	Check outdoor fans for normal operation.
⑧	Check interlocked devices (like ventilator) for normal operation, if any. This is the end of test run operation.
⑨	Press ON/OFF button to stop and cancel test run.

Notes:

1. If check code appears on remote controller or remote controller malfunctions, refer to “8-1-2. Countermeasures for Error During Run”.
2. During test run operation, 2-hour off timer activates automatically and remaining time is on remote controller and test run stops 2 hours later.
3. During test run, the indoor liquid pipe temperature is displayed on remote controller instead of room temperature.
4. Depending on a model, “This function is not available” appears when air direction button is pressed. However, this is not malfunction.

8-1-1-2. Test run for wired remote controller <PAR-31MAA> <PAR-32MAA>

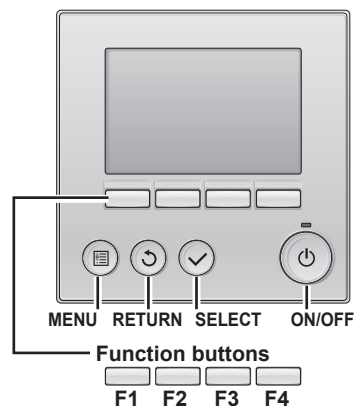

① Select "Service" from the Main menu, and press the button.



Select "Test run" with the **F1** or **F2** button, and press the button.

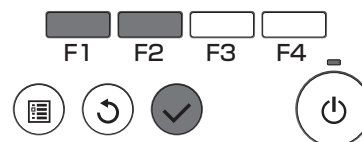
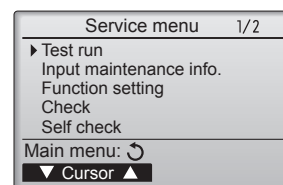

② Select "Test run" with the **F1** or **F2** button, and press the button.

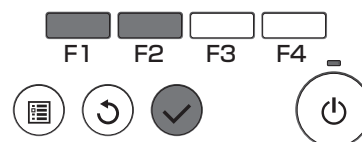
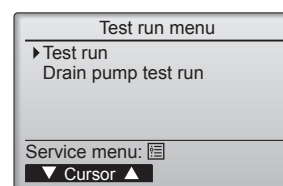

Test run operation

Press the **F1** button to go through the operation modes in the order of "Cool and Heat".

Cool mode: Check the cold air blows out.
Heat mode: Check the heat blows out.



Press the button and open the Vane setting screen.

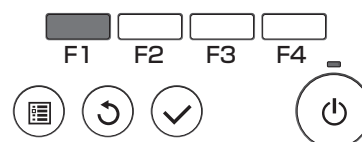
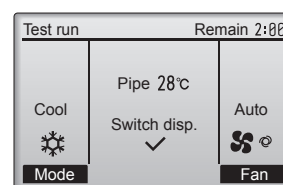

Auto vane check*

Check the auto vane with the **F1** **F2** buttons.
 Check the operation of the outdoor unit fan, also.



Press the button to return to "Test run operation".



Press the button.

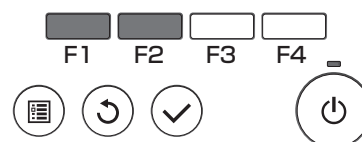
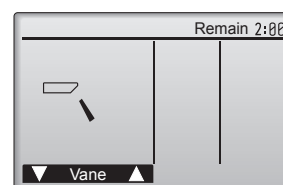

When the test run is completed, the "Test run menu" screen will appear.
 The test run will automatically stop after 2 hours.

*The function is available only for the model with vanes.

8-1-2. Countermeasures for Error During Test Run

- If a problem occurs during test run, a code number will appear on the remote controller (or LED on the outdoor unit), and the air conditioning system will automatically cease operating.

Determine the nature of the abnormality and apply corrective measures.

Check code (2 digits)	Check code (4 digits)	Trouble	Detected Unit			Remarks
			Indoor	Outdoor	Remote Controller	
Ed	0403	Serial communication error		○		Outdoor unit outdoor multi controller circuit board – Power circuit board communication trouble
U2	1102	Compressor temperature trouble		○		Check delay code 1202
UE	1302	High pressure trouble		○		Check delay code 1402
U7	1500	Superheat due to low discharge temperature trouble		○		Check delay code 1600
U2	1501	Refrigerant shortage trouble		○		Check delay code 1601
		Closed valve in cooling mode		○		Check delay code 1501
P6	1503	Freeze protection of branch box or indoor unit	○			
EF	1508	4-way valve trouble in heating mode		○		Check delay code 1608
L6	2135	Circulation water freeze protection	○			
PA	2500	Water leakage	○			
P5	2502	Drain over flow protection	○			
P4	2503	Drain sensor abnormality	○			
UF	4100	Compressor current interruption (locked compressor)		○		Check delay code 4350
Pb	4114	Fan trouble (Indoor unit)	○			
UP	4210	Compressor overcurrent interruption		○		
U9	4220	Voltage shortage/overvoltage/PAM error/L1open phase/primary current sensor error/power synchronization signal error		○		Check delay code 4320
U5	4230	Heat sink temperature trouble		○		Check delay code 4330
U6	4250	Power module trouble or Overcurrent trouble		○		Check delay code 4350
U8	4400	Fan trouble (Outdoor unit)		○		Check delay code 4500
U3	5101	Air inlet thermistor (TH21) open/short	○			
		Compressor temperature thermistor (TH4) open/short		○		Check delay code 1202
U4	5102	Liquid pipe temperature thermistor (TH22) open/short	○			
		Suction pipe temperature thermistor (TH6) open/short		○		Check delay code 1211
U4	5103	Gas pipe temperature thermistor (TH23) open/short	○			
U4	5105	Outdoor liquid pipe temperature thermistor (TH3) open/short		○		Check delay code 1205
U4	5106	Ambient temperature thermistor (TH7) open/short		○		Check delay code 1221
U4	5109	HIC pipe temperature thermistor (TH2) open/short		○		Check delay code 1222
U4	5110	Heat sink temperature thermistor (TH8) open/short		○		Check delay code 1214
F5	5201	High pressure sensor (63HS) trouble		○		Check delay code 1402
F3	5202	Low pressure sensor (63LS) trouble		○		Check delay code 1400
UH	5300	Primary current error		○		Check delay code 4310
P4	5701	Contact failure of drain float switch	○			
A0	6600	Duplex address error	○	○	○	Only M-NET Remote controller is detected.
A2	6602	Transmission processor hardware error	○	○	○	Only M-NET Remote controller is detected.
A3	6603	Transmission bus BUSY error	○	○	○	Only M-NET Remote controller is detected.
A6	6606	Signal communication error with transmission processor	○	○	○	Only M-NET Remote controller is detected.
A7	6607	No ACK error	○		○	Only M-NET Remote controller is detected.
A8	6608	No response frame error	○		○	Only M-NET Remote controller is detected.
E0/E4	6831	MA communication receive error	○		○	Only MA Remote controller is detected.
E3/E5	6832	MA communication send error	○		○	Only MA Remote controller is detected.
E3/E5	6833	MA communication send error	○		○	Only MA Remote controller is detected.
E0/E4	6834	MA communication receive error	○		○	Only MA Remote controller is detected.
EF	7100	Total capacity error		○		
EF	7101	Capacity code error	○	○		
EF	7102	Connecting excessive number of units and branch boxes		○		
EF	7105	Address setting error		○		
EF	7130	Incompatible unit combination		○		

Notes:

- When the outdoor unit detects No ACK error/No response error, an object indoor unit is treated as a stop, and not assumed to be abnormal.
- The check codes displayed on the units may be different between the error source and others. In that case, please refer to the check code of error source by displayed attribute and address.
- Refer to the service manual of indoor unit or remote controller for the detail of error detected in indoor unit or remote controller.

• Self-diagnosis function

The indoor and outdoor units can be diagnosed automatically using the self-diagnosis switch (SW1) and LED1, LED2 (LED indication) found on the multi-controller of the outdoor unit.
LED indication : Set all contacts of SW1 to OFF.

• During normal operation

The LED indicates the drive state of the controller in the outdoor unit.

Bit	1	2	3	4	5	6	7	8
Indication	Compressor operated	52C	21S4	SV1	(SV2)	—	—	Always lit

[Example]

When the compressor and SV1 are turned during cooling operation.

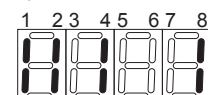

Check code

0403
(Ed)

Serial communication error

Abnormal points and detection methods	Causes and check points
Abnormal if serial communication between the outdoor multi controller circuit board and outdoor power circuit board is defective.	<ul style="list-style-type: none"> ① Wire breakage or contact failure of connector CN2 or CN4 ② Malfunction of communication circuit to power circuit board on outdoor multi controller circuit board ③ Malfunction of communication circuit on outdoor power circuit board

●Diagnosis of defectives

Make sure to turn the power OFF before connecting/disconnecting any connectors, or replacing boards.

Diagnosis	Remedy
<p>Check the connection of the communication line (CN2 and CN4) between the outdoor multi controller circuit board and power circuit board.</p> <p>Are they connected normally?</p> <p>Yes</p> <p>No</p>	<p>Connect the CN2 and CN4 properly. Replace them in case of a breakage.</p> <p>The communication circuit of either the outdoor multi controller circuit board or power circuit board is defective. If unable to identify the defective circuit;</p> <ul style="list-style-type: none"> ① Replace the outdoor multi controller circuit board if it does not recover. ② Replace the outdoor power circuit board.

Compressor temperature trouble

Abnormal points and detection methods	Causes and check points
<p>(1) Abnormal if TH4 falls into following temperature conditions;</p> <ul style="list-style-type: none"> ●exceeds 105°C [221°F] continuously for 5 minutes ●exceeds 115°C [239°F] <p>TH4: Thermistor <Compressor> LEV: Linear expansion valve</p>	<ul style="list-style-type: none"> ① Malfunction of stop valve ② Over-heated compressor operation caused by shortage of refrigerant ③ Defective thermistor ④ Defective outdoor multi controller circuit board ⑤ LEV performance failure ⑥ Defective indoor controller board ⑦ Clogged refrigerant system caused by foreign object ⑧ Refrigerant shortage (Refrigerant liquid accumulation in compressor while indoor unit is OFF/thermo-OFF.)

●Diagnosis of defectives

Make sure to turn the power OFF before connecting/disconnecting any connectors, or replacing boards.

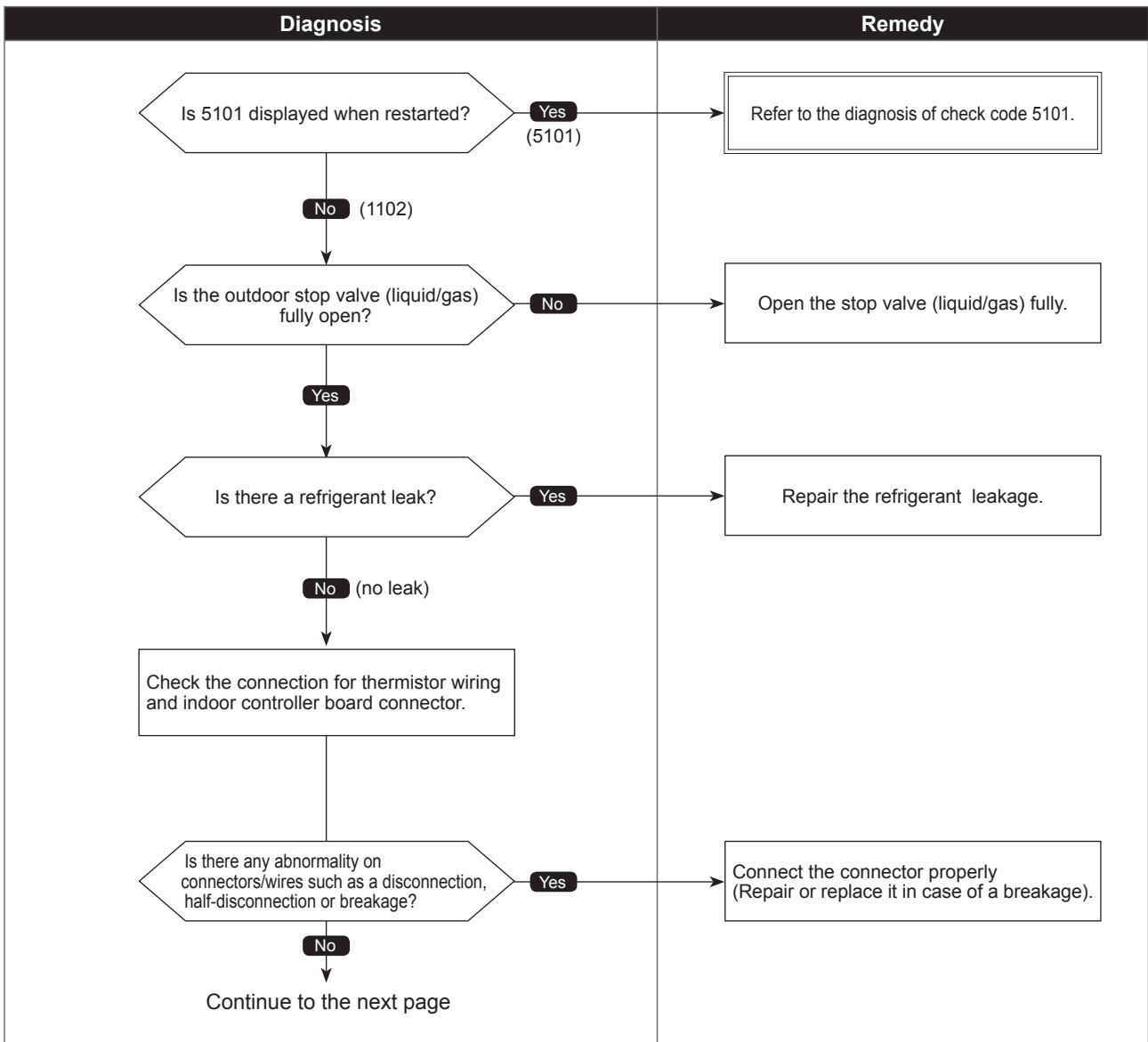

●Diagnosis of defectives

Make sure to turn the power OFF before connecting/disconnecting any connectors, or replacing boards.

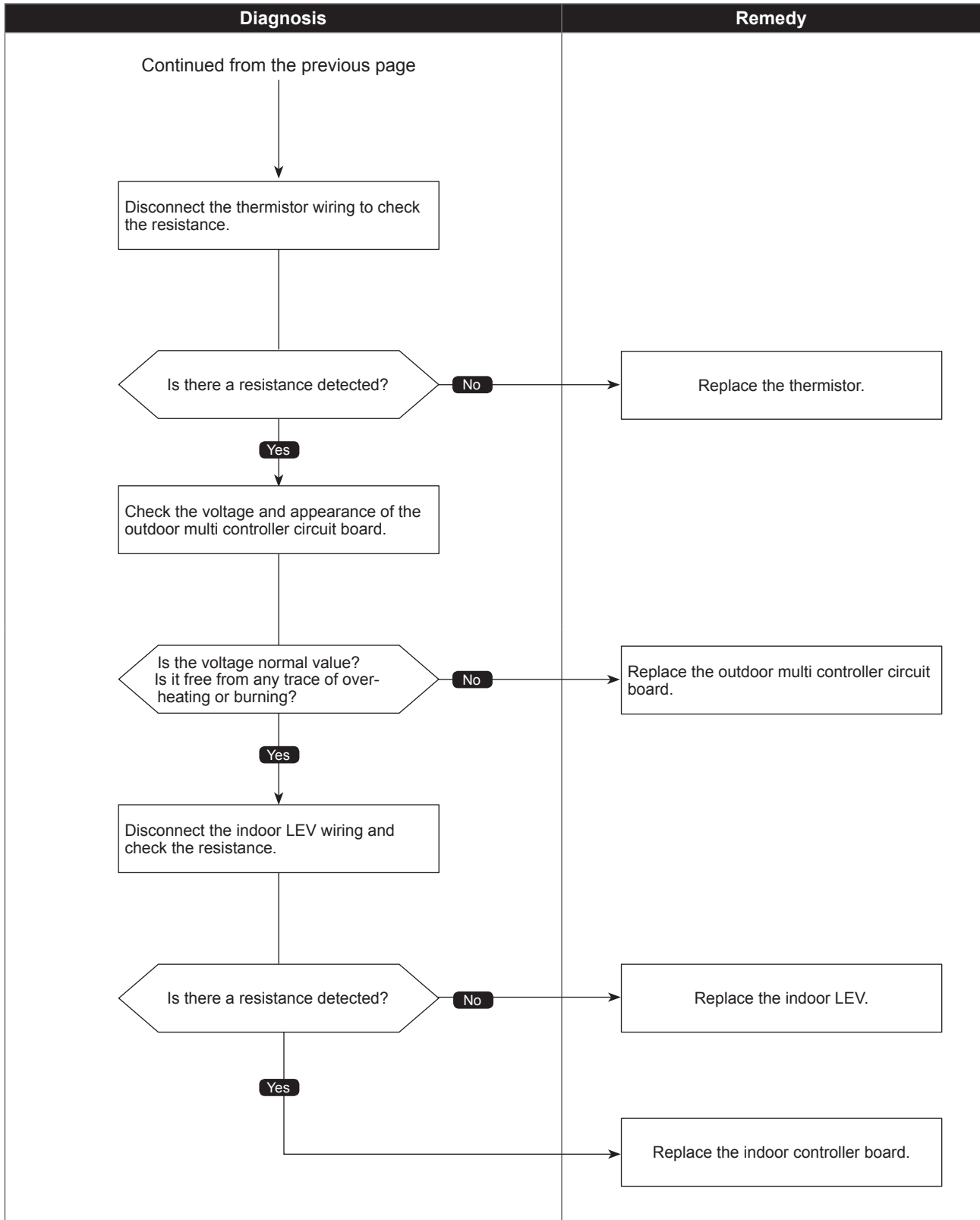

High pressure trouble

Abnormal points and detection methods	Causes and check points
<p>(1) High pressure abnormality (63H operation) Abnormal if 63H operates(*) during compressor operation. (* 4.15 MPaG [602 PSIG])</p> <p>2) High pressure abnormality (63HS detected) 1. Abnormal if a pressure detected by 63HS is 4.31 MPaG [625 PSIG] or more during compressor operation. 2. Abnormal if a pressure detected by 63HS is 4.14 MPaG [600 PSIG] or more for 3 minutes during compressor operation.</p> <p>63H : High pressure switch 63HS: High pressure sensor LEV : Linear expansion valve SV1 : Solenoid valve TH7 : Thermistor <Ambient></p>	<p>① Defective operation of stop valve (not fully open) ② Clogged or broken pipe ③ Malfunction or locked outdoor fan motor ④ Short-cycle of outdoor unit ⑤ Dirt of outdoor heat exchanger ⑥ Remote controller transmitting error caused by noise interference ⑦ Contact failure of the outdoor multi controller circuit board connector ⑧ Defective outdoor multi controller circuit board ⑨ Short-cycle of indoor unit ⑩ Decreased airflow, clogged filter, or dirt on indoor unit. ⑪ Malfunction or locked indoor fan motor ⑫ Decreased airflow caused by defective inspection of outdoor temperature thermistor (It detects lower temperature than actual temperature.) ⑬ Indoor LEV performance failure ⑭ Malfunction of fan driving circuit ⑮ SV1 performance failure ⑯ Defective High pressure sensor ⑰ Defective High pressure sensor input circuit on outdoor multi controller circuit board</p>

●Diagnosis of defectives

Make sure to turn the power OFF before connecting/disconnecting any connectors, or replacing boards.

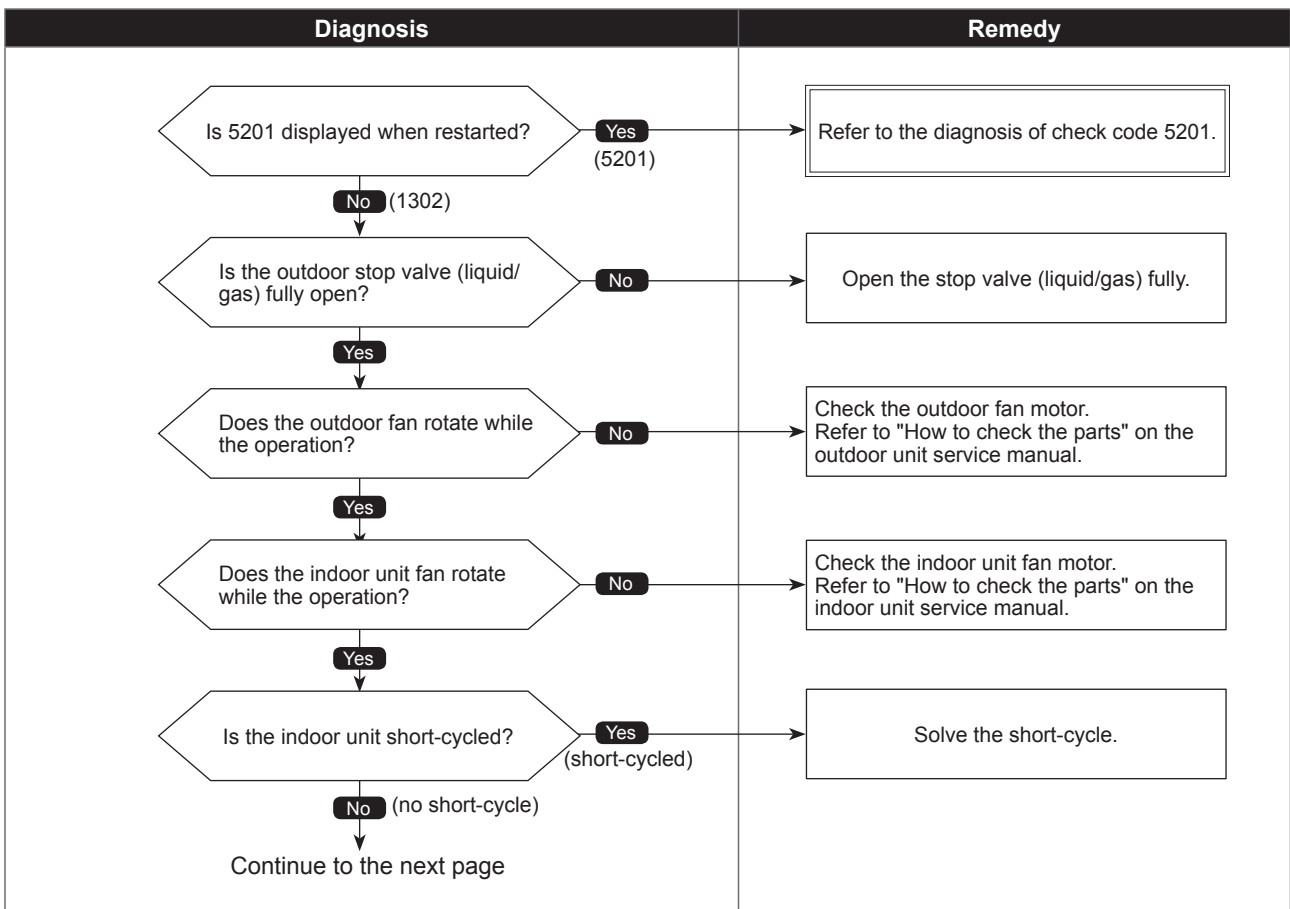

High pressure trouble

●Diagnosis of defectives

Make sure to turn the power OFF before connecting/disconnecting any connectors, or replacing boards.

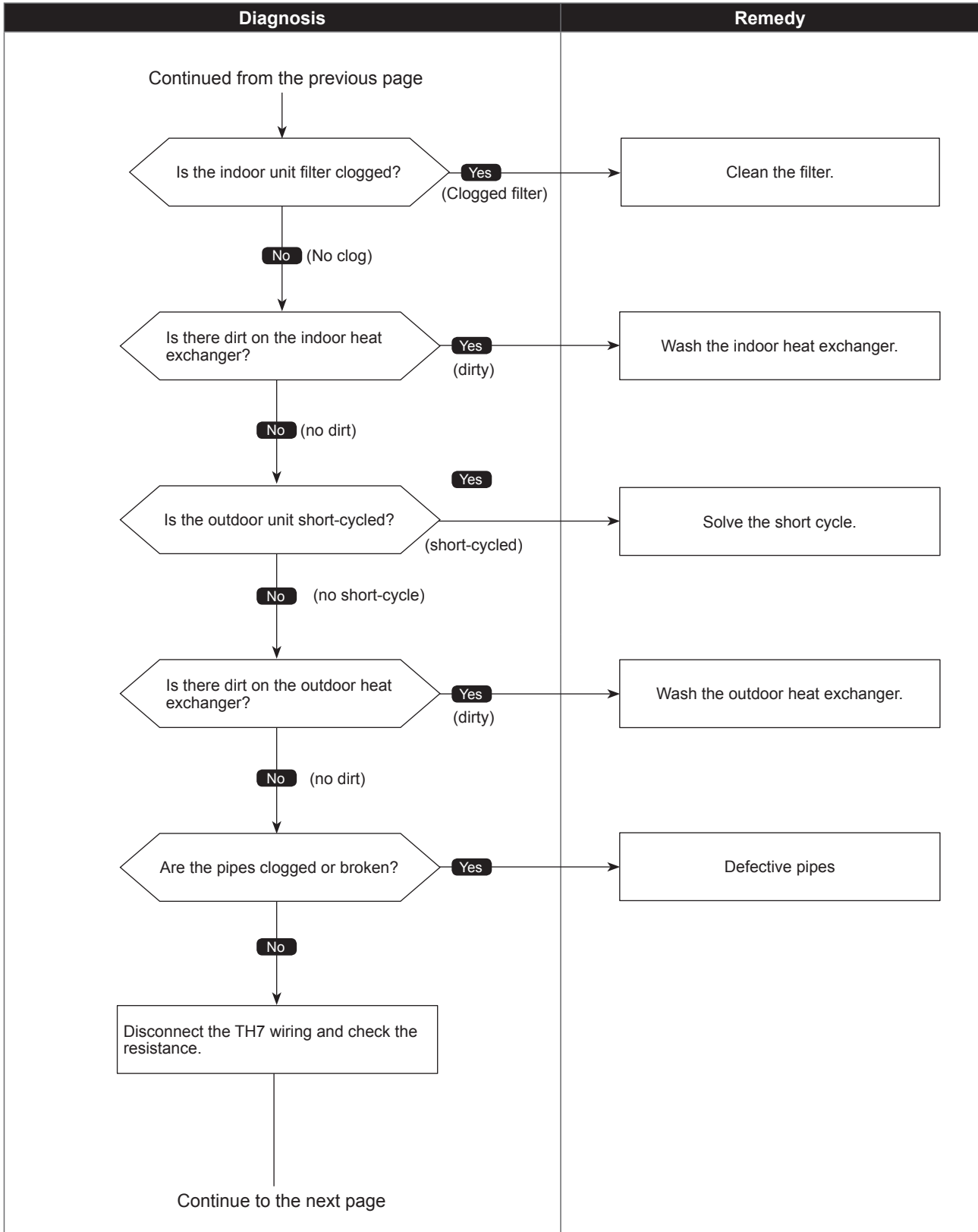

●Diagnosis of defectives

Make sure to turn the power OFF before connecting/disconnecting any connectors, or replacing boards.

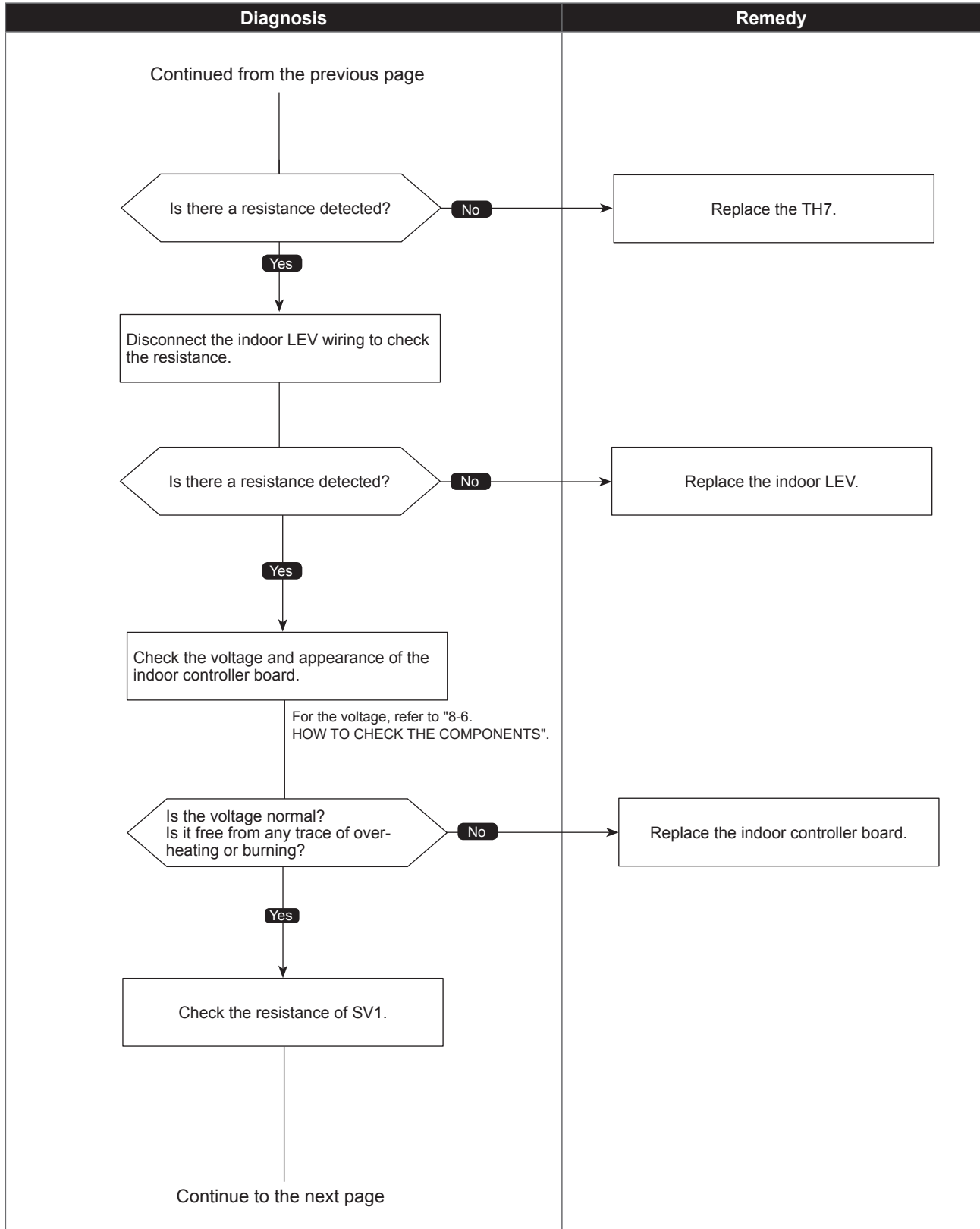

●Diagnosis of defectives

Make sure to turn the power OFF before connecting/disconnecting any connectors, or replacing boards.

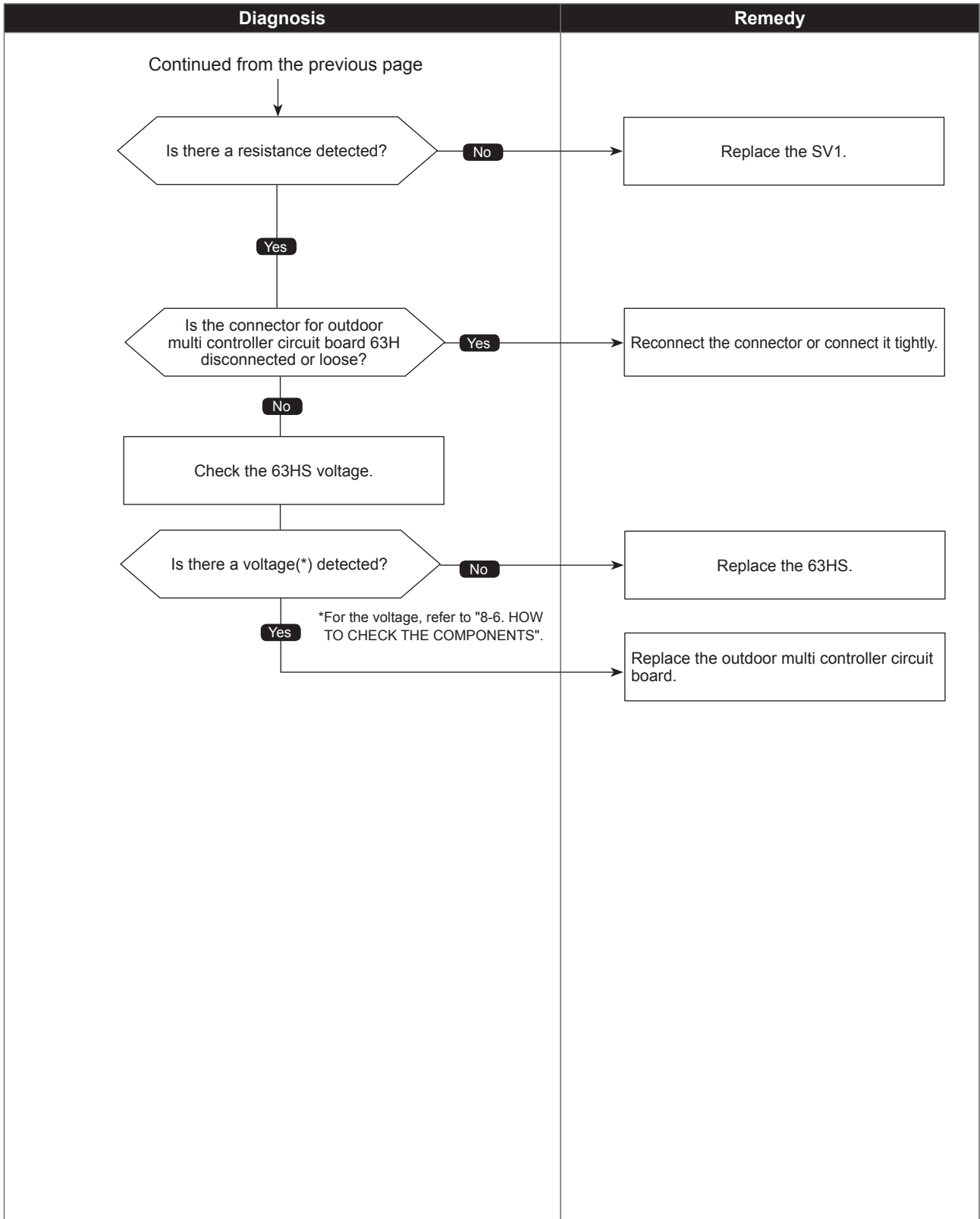

Superheat due to low discharge temperature trouble

Abnormal points and detection methods	Causes and check points
<p>Abnormal if the discharge superheat is continuously detected -15°C [-27°F](*) or less for 5 minutes even though the indoor LEV has minimum open pulse after the compressor starts operating for 10 minutes.</p> <p>LEV : Linear expansion valve TH4 : Thermistor <Compressor> 63HS: High pressure sensor</p> <p>*At this temperature, conditions for the abnormality detection will not be satisfied if no abnormality is detected on either TH4 or 63HS.</p>	<p>① Disconnection or loose connection of TH4 ② Defective holder of TH4 ③ Disconnection of LEV coil ④ Disconnection of LEV connector ⑤ LEV performance failure</p>

●Diagnosis of defectives

Make sure to turn the power OFF before connecting/disconnecting any connectors, or replacing boards.

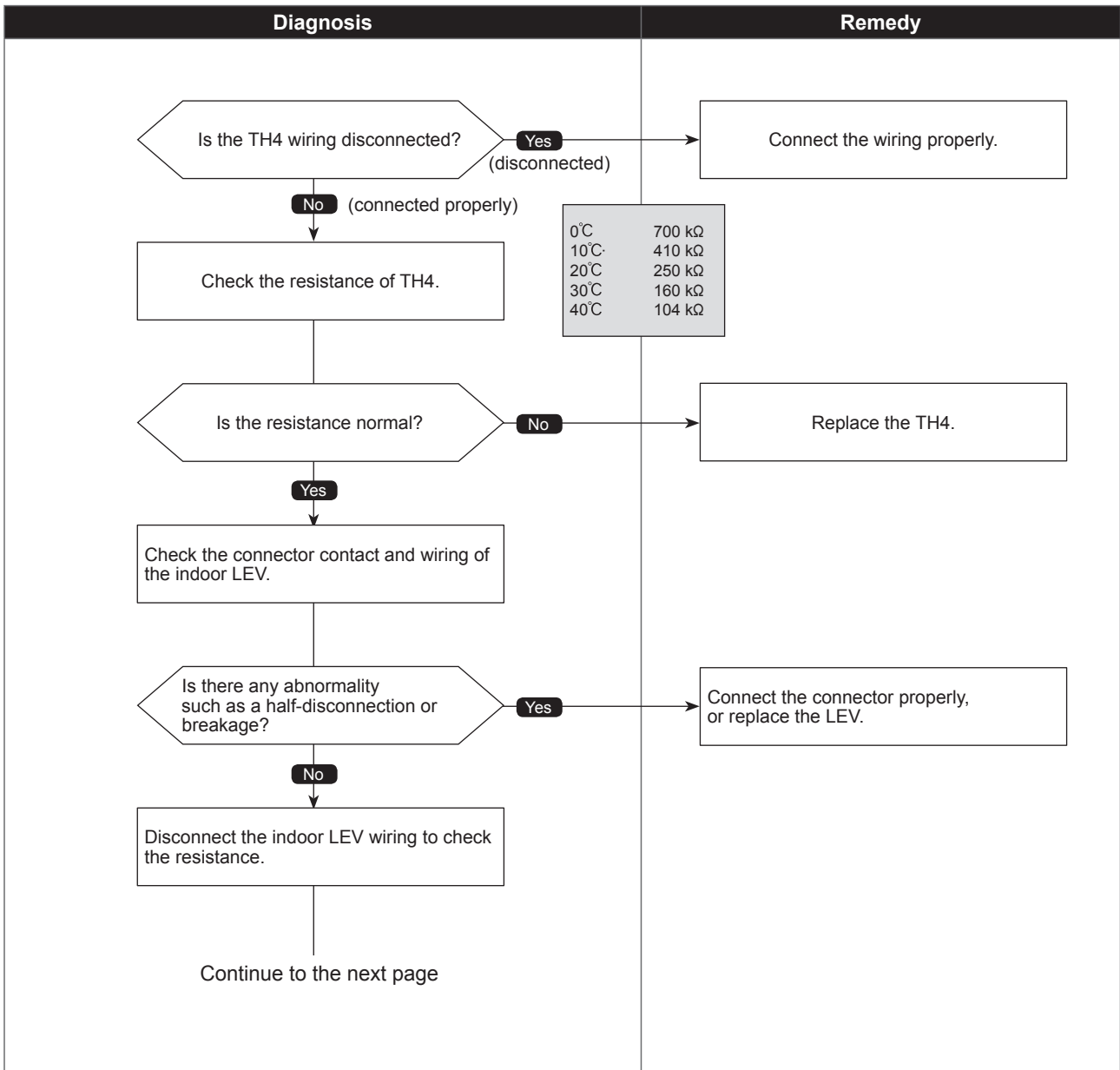

●Diagnosis of defectives

Make sure to turn the power OFF before connecting/disconnecting any connectors, or replacing boards.

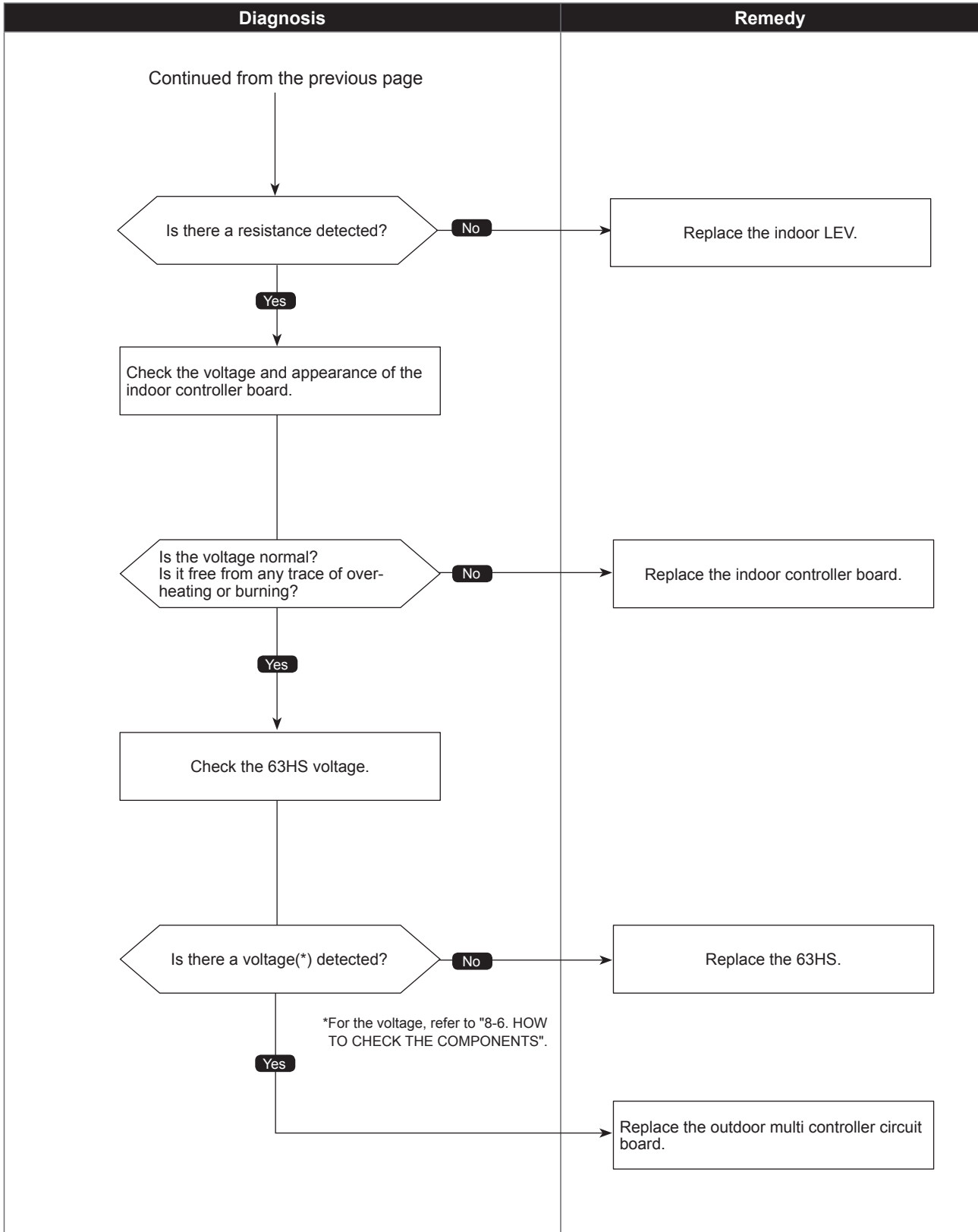

Refrigerant shortage trouble

Abnormal points and detection methods	Causes and check points
<p>(1) Abnormal when all of the following conditions have been satisfied for 15 consecutive minutes:</p> <ol style="list-style-type: none"> 1. The compressor is operating in HEAT mode. 2. Discharge superheat is 80°C [144°F] or more. 3. Difference between TH7 and TH3 applies to the formula of (TH7-TH3 < 5°C [9°F]) 4. The saturation temperature converted from a high pressure sensor detects below 35°C [95°F]. <p>(2) Abnormal when all of the following conditions have been satisfied:</p> <ol style="list-style-type: none"> 1. The compressor is in operation. 2. When cooling, discharge superheat is 80°C [144°F] or more, and the saturation temperature converted from a high pressure sensor is over -40°C [-40°F]. 3. When heating, discharge superheat is 90°C [162°F] or more. 	<ol style="list-style-type: none"> ① Defective operation of stop valve (not fully open) ② Defective thermistor ③ Defective outdoor multi controller circuit board ④ Indoor LEV performance failure ⑤ Gas leakage or shortage ⑥ Defective 63HS <p>TH3 : Thermistor <Outdoor liquid pipe> TH7 : Thermistor <Ambient> LEV : Linear expansion valve 63HS: High pressure sensor</p>

●Diagnosis of defectives

Make sure to turn the power OFF before connecting/disconnecting any connectors, or replacing boards.

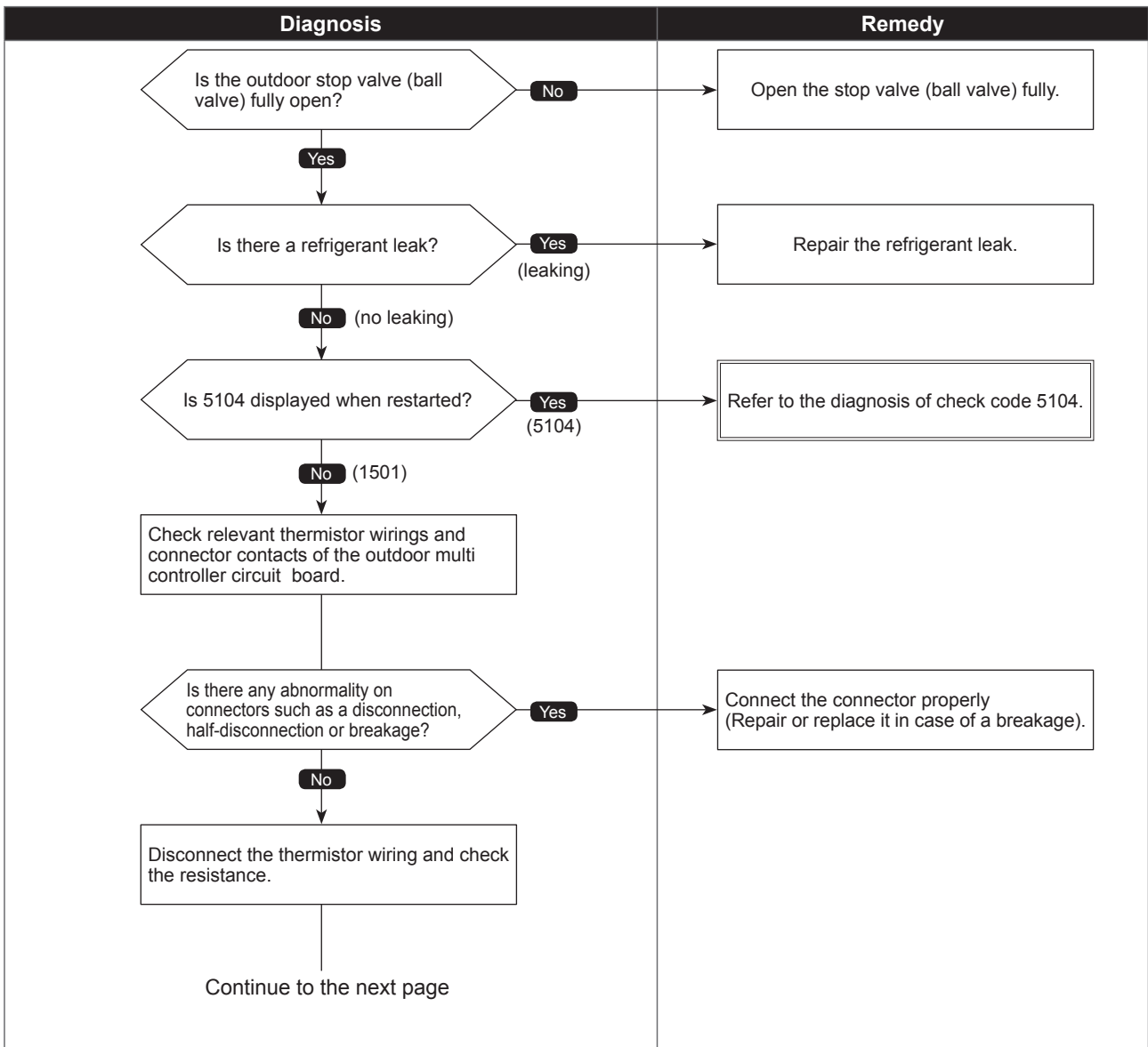

Refrigerant shortage trouble

●Diagnosis of defectives

Make sure to turn the power OFF before connecting/disconnecting any connectors, or replacing boards.

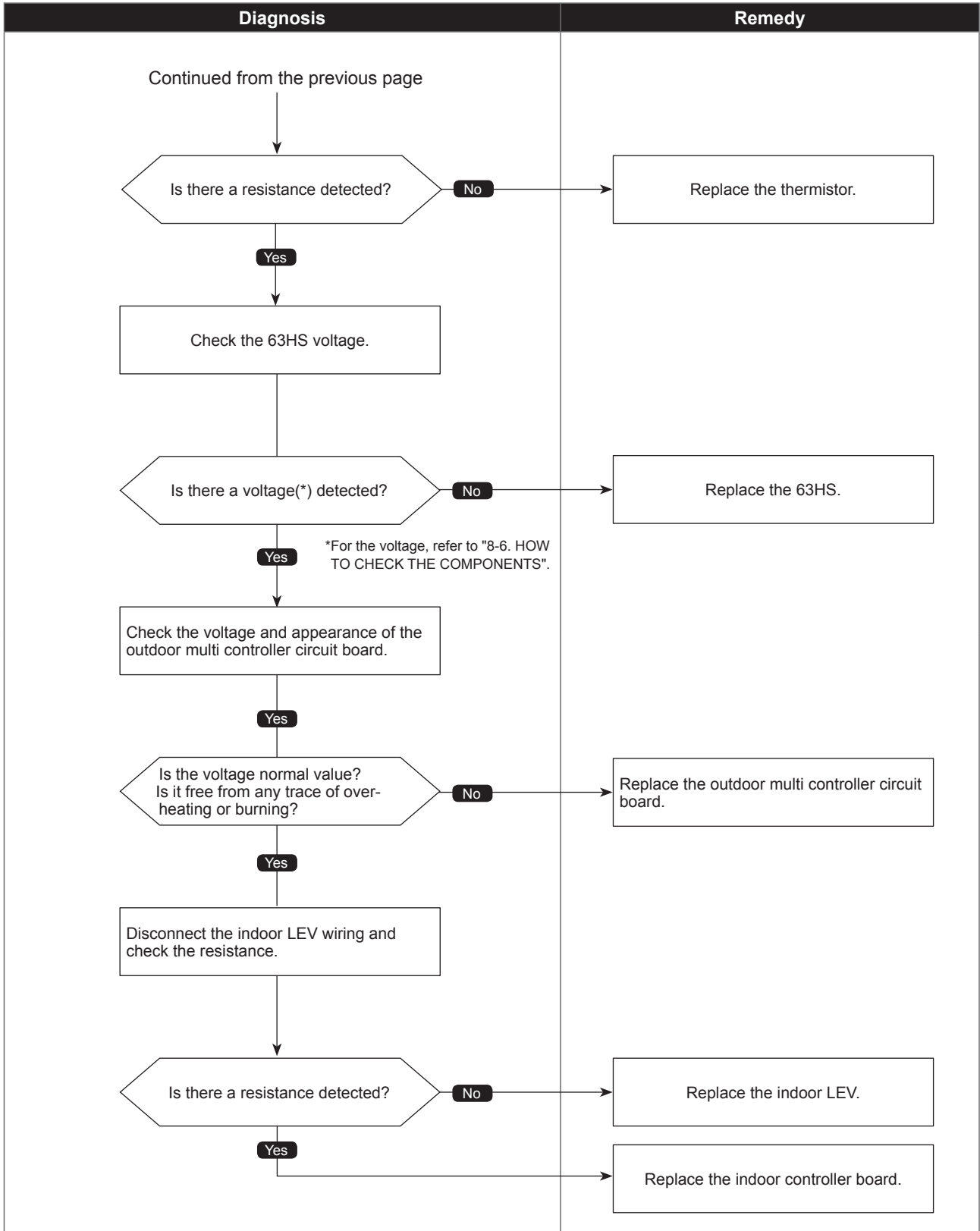

Check code

1501
(U2)

Closed valve in cooling mode

Abnormal points and detection methods	Causes and check points
<p>Abnormal if stop valve is closed during cooling operation.</p> <p>Abnormal when both of the following temperature conditions have been satisfied for 20 minutes or more during cooling operation.</p> <ol style="list-style-type: none"> 1. TH22j-TH21j $\geq -2^{\circ}\text{C}$ [-3.6°F] 2. TH23j-TH21j $\geq -2^{\circ}\text{C}$ [-3.6°F] <p>Note: For indoor unit, the abnormality is detected if an operating unit satisfies the condition.</p>	<p>① Outdoor liquid/gas valve is closed.</p> <p>② Malfunction of outdoor LEV (LEV1)(blockage)</p> <p>TH21: Indoor intake temperature thermistor (RT11 or TH1) TH22: Indoor liquid pipe temperature thermistor (RT13 or TH2) TH23: Indoor gas pipe temperature thermistor (TH-A to E) LEV: Linear expansion valve</p>

●Diagnosis of defectives

Make sure to turn the power OFF before connecting/disconnecting any connectors, or replacing boards.

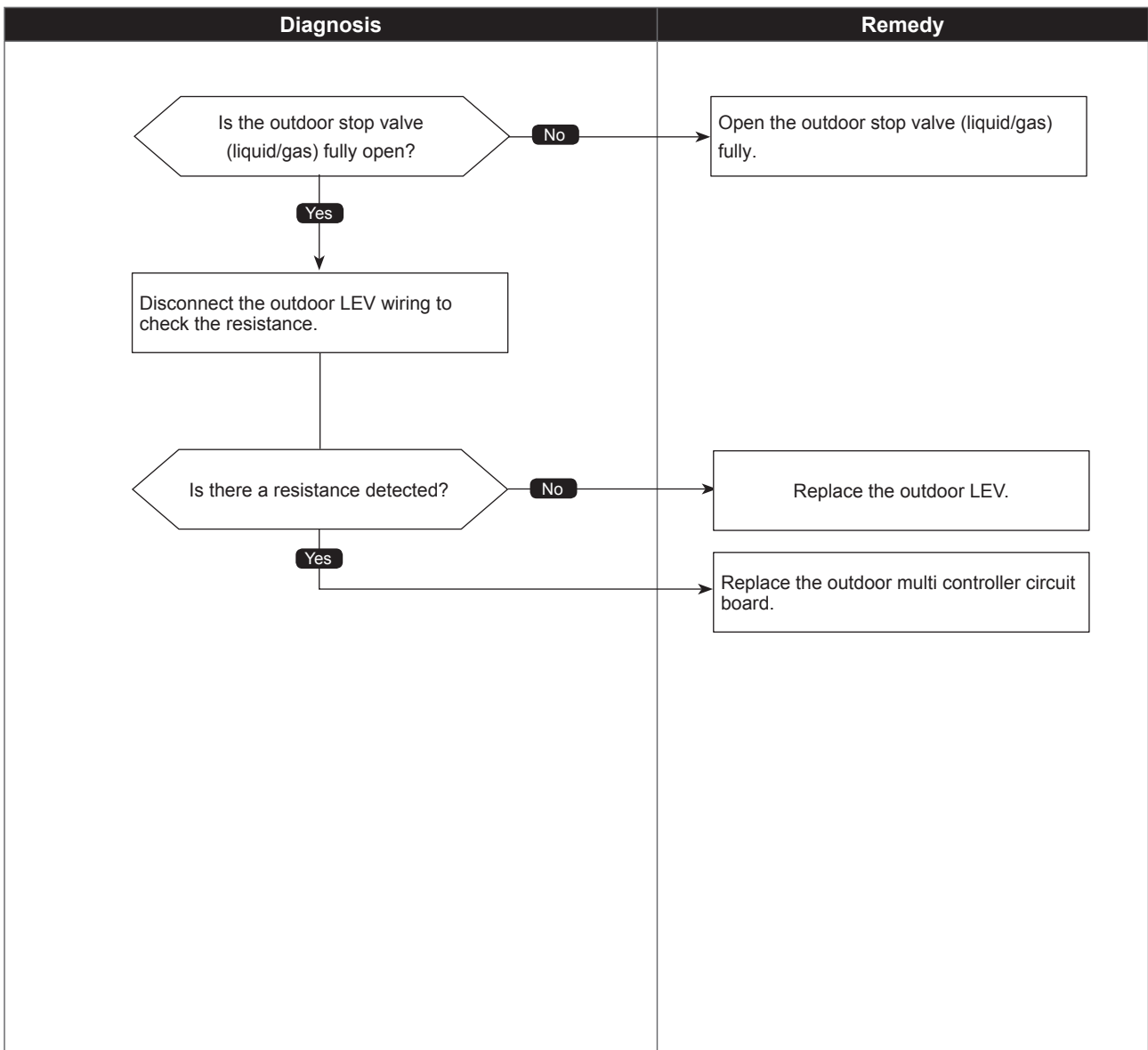

Check code

1503
(P6)

Freeze protection of branch box or indoor unit

Abnormal points and detection methods	Causes and check points
<p>The purpose of the check code is to prevent indoor unit from freezing or dew condensation which is caused when a refrigerant keeps flowing into the unit in STOP.</p> <p>Abnormal when all of the following conditions are satisfied:</p> <ol style="list-style-type: none"> 1. The compressor is operating in COOL mode. 2. 15 minutes have passed after the startup of the compressor, or the change in the number of operating indoor units is made (including a change by turning thermo-ON/OFF). 3. After the condition 2 above is satisfied, the thermistor of indoor unit in STOP detects TH22] $\leq -5^{\circ}\text{C}$ [23°F] for 5 consecutive minutes. 	<ol style="list-style-type: none"> ① Wrong piping connection between indoor unit and branch box ② Miswiring between indoor unit and branch box ③ Miswiring of LEV in branch box or indoor unit ④ Malfunction of LEV in branch box or indoor unit

●Diagnosis of defectives

Make sure to turn the power OFF before connecting/disconnecting any connectors, or replacing boards.

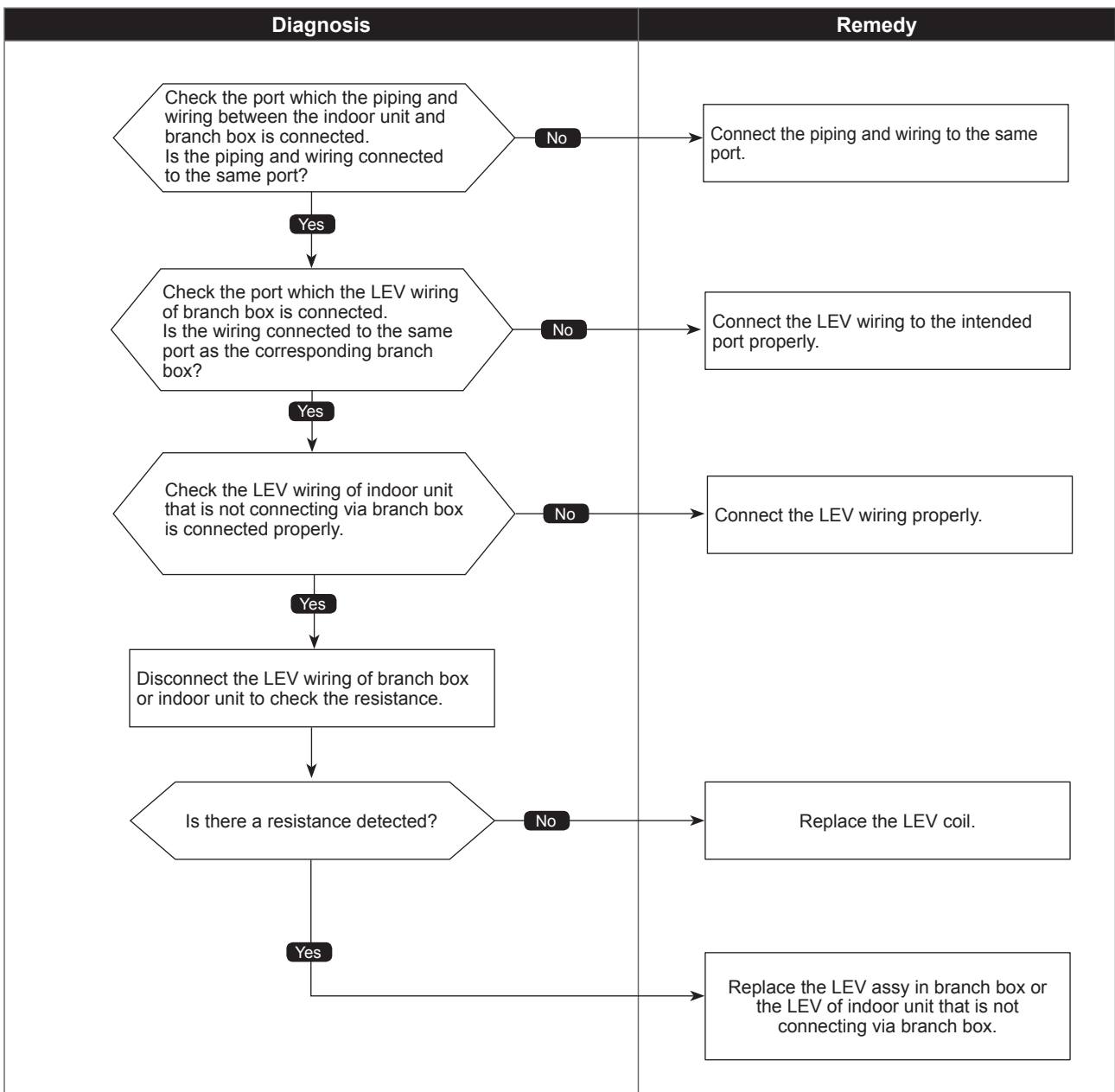

4-way valve trouble in heating mode

Abnormal points and detection methods	Causes and check points
<p>Abnormal if 4-way valve does not operate during heating operation.</p> <p>Abnormal when any of the following temperature conditions is satisfied for 3 min. or more during heating operation</p> <ol style="list-style-type: none"> 1. TH22j-TH21j $\leq -10^{\circ}\text{C}$ [-18°F] 2. TH23j-TH21j $\leq -10^{\circ}\text{C}$ [-18°F] 3. TH22j $\leq 3^{\circ}\text{C}$ [37.4°F] 4. TH23j $\leq 3^{\circ}\text{C}$ [37.4°F] <p>Note: For indoor unit, the abnormality is detected if an operating unit satisfies the condition.</p>	<ol style="list-style-type: none"> ① 4-way valve failure ② Disconnection or failure of 4-way valve coil ③ Clogged drain pipe ④ Disconnection or loose connection of connectors ⑤ Malfunction of input circuit on outdoor multi controller circuit board ⑥ Defective outdoor power circuit board <p>TH21: Indoor intake temperature thermistor (RT11 or TH1) TH22: Indoor liquid pipe temperature thermistor (RT13 or TH2) TH23: Indoor gas pipe temperature thermistor (TH-A to E)</p>

●Diagnosis of defectives

Make sure to turn the power OFF before connecting/disconnecting any connectors, or replacing boards.

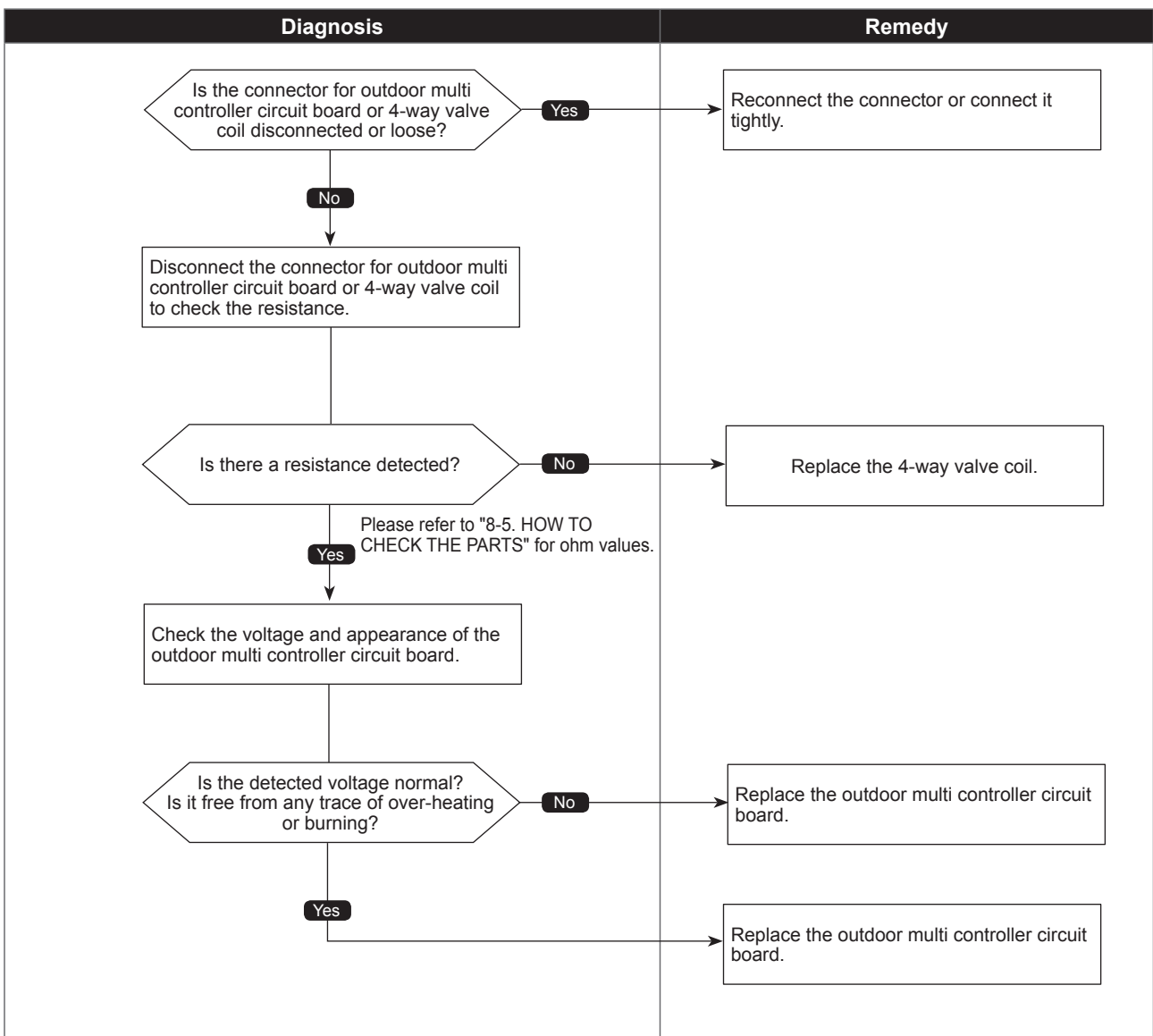

Abnormal points and detection methods	Causes and check points
Abnormal if overcurrent of DC bus or compressor is detected before 30 seconds after the compressor starts operating.	① Closed stop valve ② Decrease of power supply voltage ③ Looseness, disconnection, or wrong phase of compressor wiring connection ④ Model selection error on indoor controller board or outdoor multi controller circuit board ⑤ Defective compressor ⑥ Defective outdoor power circuit board

●Diagnosis of defectives

Make sure to turn the power OFF before connecting/disconnecting any connectors, or replacing boards.

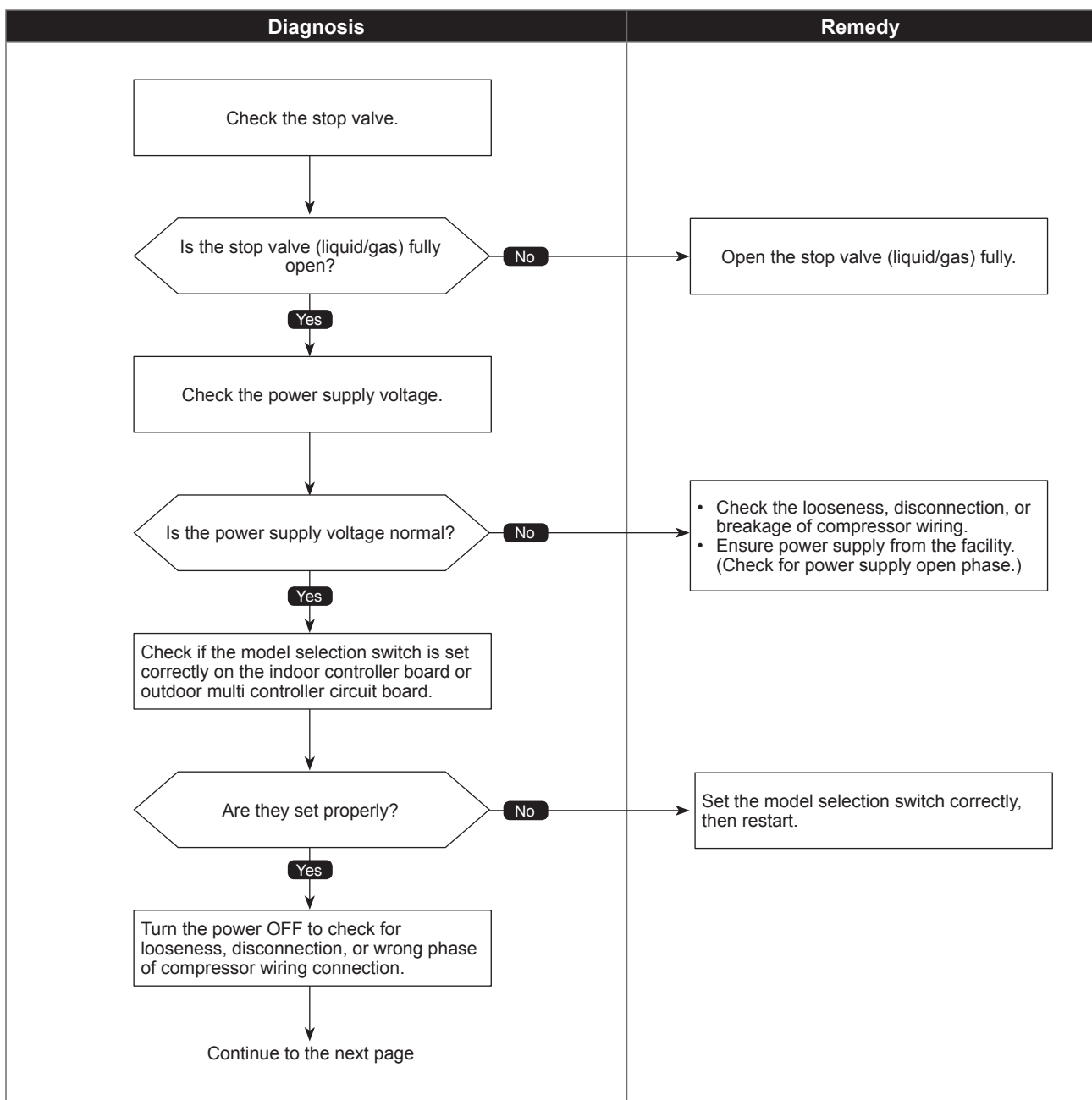

- Diagnosis of defectives

Make sure to turn the power OFF before connecting/disconnecting any connectors, or replacing boards.

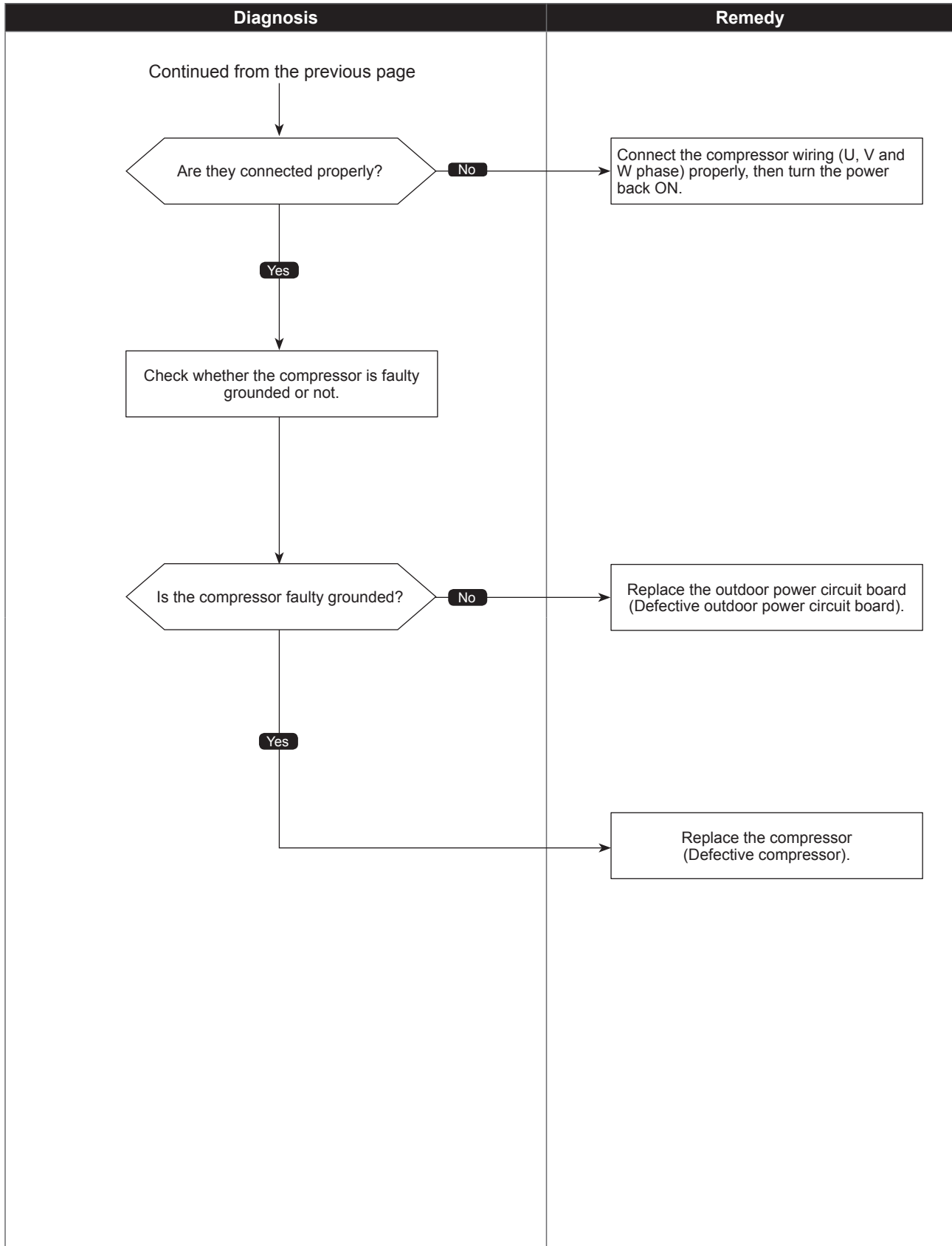

Compressor overcurrent interruption

Abnormal points and detection methods	Causes and check points
Abnormal if overcurrent of DC bus or compressor is detected after 30 seconds since the compressor starts operating.	<ul style="list-style-type: none"> ① Closed outdoor stop valve ② Decrease of power supply voltage ③ Looseness, disconnection, or wrong phase of compressor wiring connection ④ Model selection error on indoor controller board or outdoor multi controller circuit board ⑤ Defective compressor ⑥ Defective outdoor power circuit board ⑦ Defective outdoor multi controller circuit board ⑧ Malfunction of indoor/outdoor unit fan ⑨ Short-cycle of indoor/outdoor unit

●Diagnosis of defectives

Make sure to turn the power OFF before connecting/disconnecting any connectors, or replacing boards.

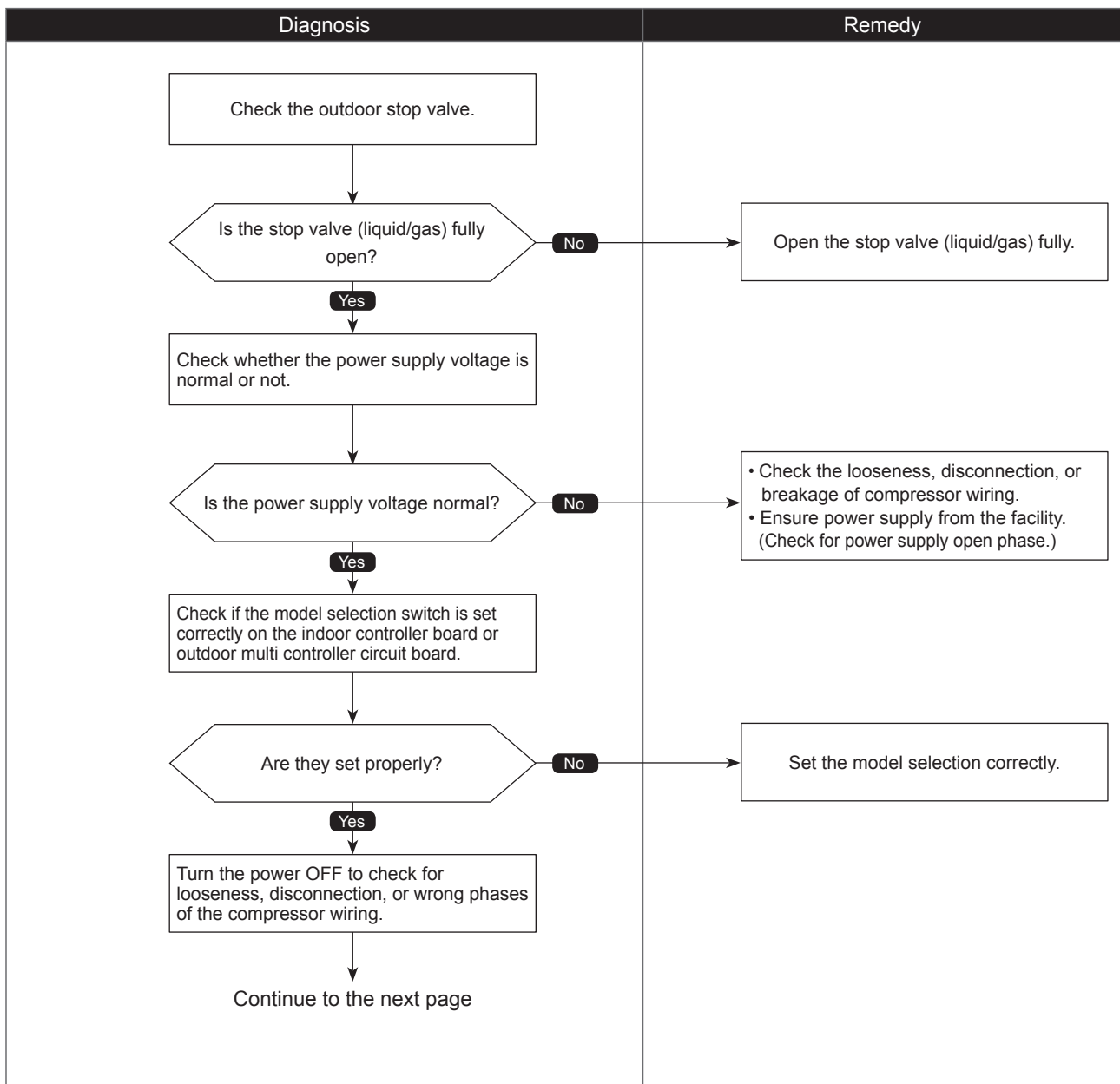

Compressor overcurrent interruption

●Diagnosis of defectives

Make sure to turn the power OFF before connecting/disconnecting any connectors, or replacing boards.

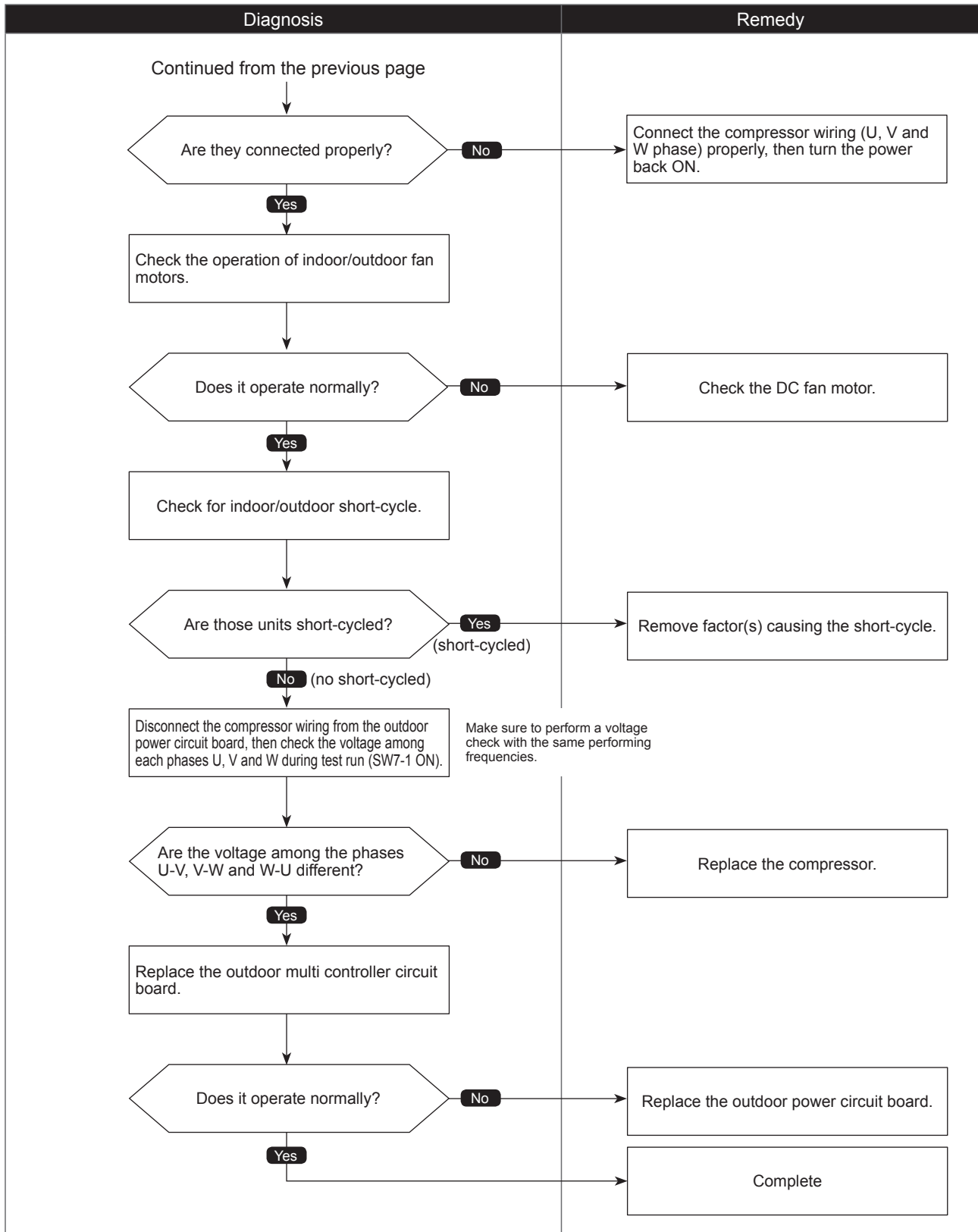

Voltage shortage/overvoltage/PAM error/L1 open phase/primary current sensor error/power synchronization signal error

Abnormal points and detection methods	Causes and check points
<p>Abnormal if any of following symptoms are detected;</p> <ul style="list-style-type: none"> ● Decrease of DC bus voltage to 200 V (V model), 350 V (Y model) ● Increase of DC bus voltage to 430 V (V model), 760 V (Y model) ● DC bus voltage stays at 310 V or less for consecutive 30 seconds when the operational frequency is over 20 Hz. ● When any one of the following conditions has been satisfied while the detection value of primary current is 0.1 A or less. <ol style="list-style-type: none"> 1. The operational frequency is 40 Hz or more. 2. The compressor current is 6 A or more. 	<ol style="list-style-type: none"> ① Decrease/increase of power supply voltage ② LI open-phase (Y model only) ③ Primary current sensor failure ④ Disconnection of compressor wiring ⑤ Malfunction of 52C ⑥ Defective outdoor power circuit board ⑦ Disconnection of CN5 (Y model only) ⑧ Disconnection of CN2 ⑨ Malfunction of primary current detecting circuit on outdoor power circuit board

● Diagnosis of defectives

Make sure to turn the power OFF before connecting/disconnecting any connectors, or replacing boards.

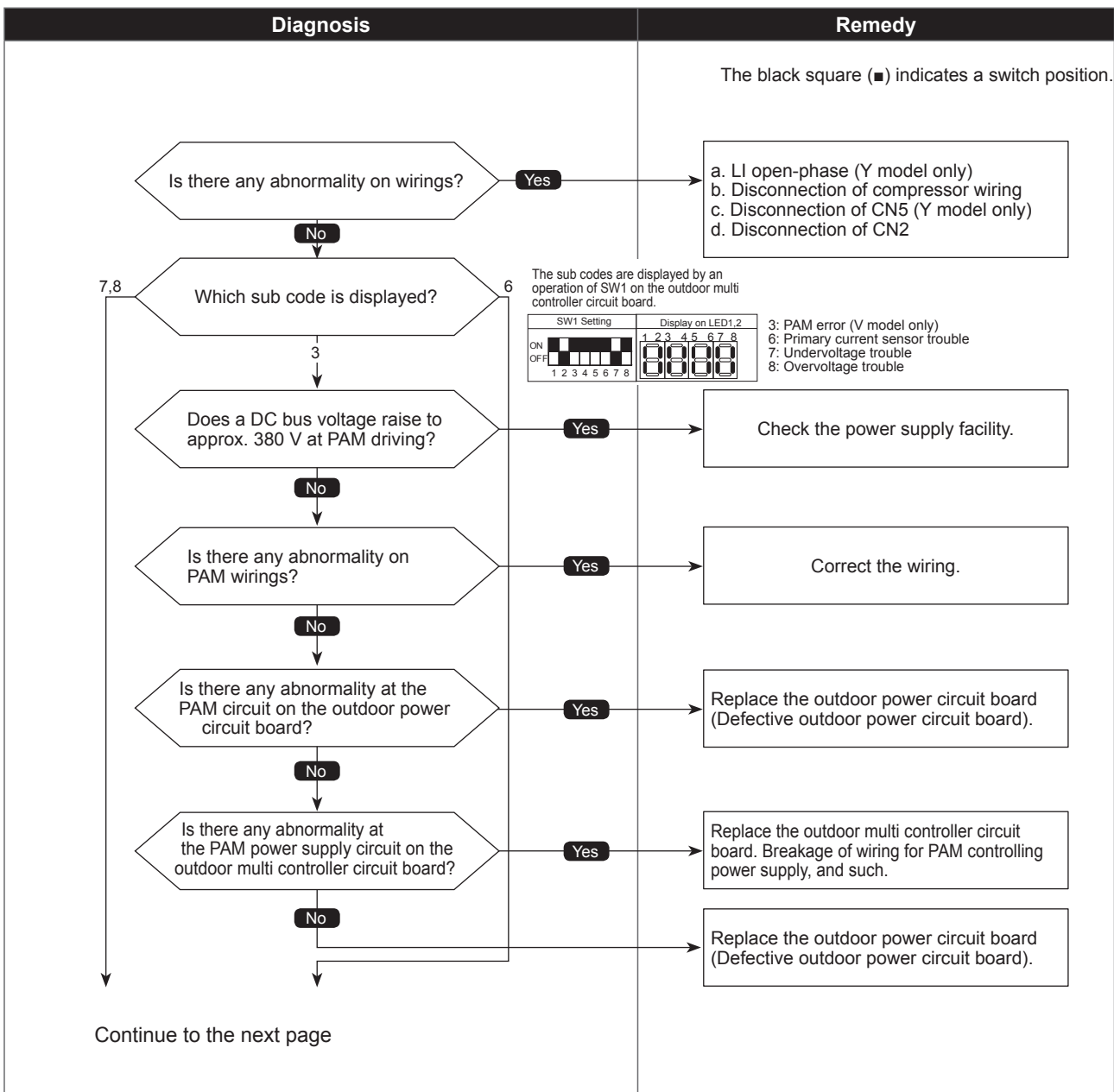

●Diagnosis of defectives

Make sure to turn the power OFF before connecting/disconnecting any connectors, or replacing boards.

The black square (■) indicates a switch position.

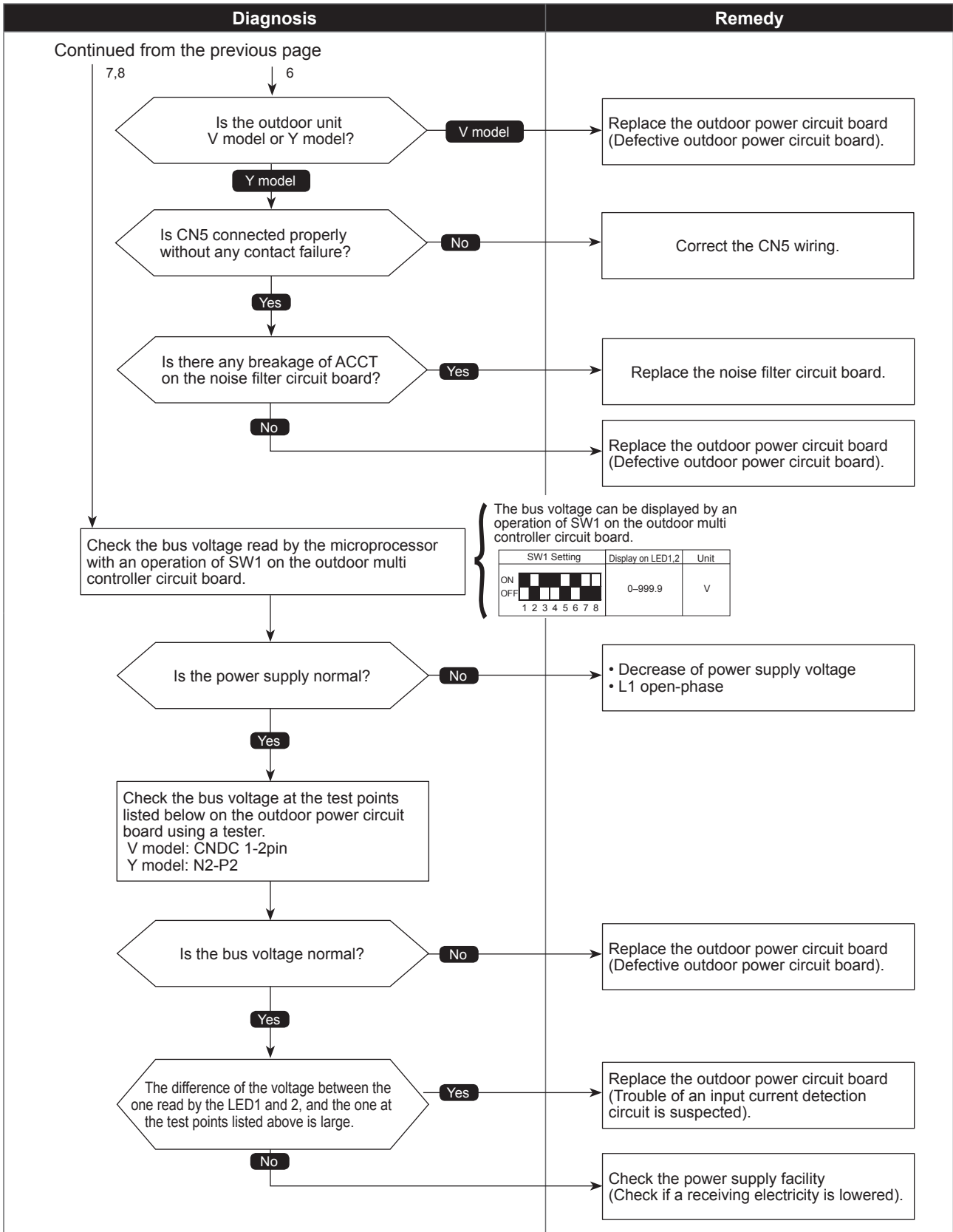

Check code

4230
(U5)

Heat sink temperature trouble

Abnormal points and detection methods	Causes and check points
<p>Abnormal if TH8 detects a temperature outside the specified range during compressor operation.</p> <p>TH8: Thermistor <Heat sink></p>	<ul style="list-style-type: none"> ① Blocked outdoor fan ② Malfunction of outdoor fan motor ③ Blocked airflow path ④ Rise of ambient temperature ⑤ Characteristic defect of thermistor ⑥ Malfunction of input circuit on outdoor power circuit board ⑦ Malfunction of outdoor fan driving circuit

●Diagnosis of defectives

Make sure to turn the power OFF before connecting/disconnecting any connectors, or replacing boards.

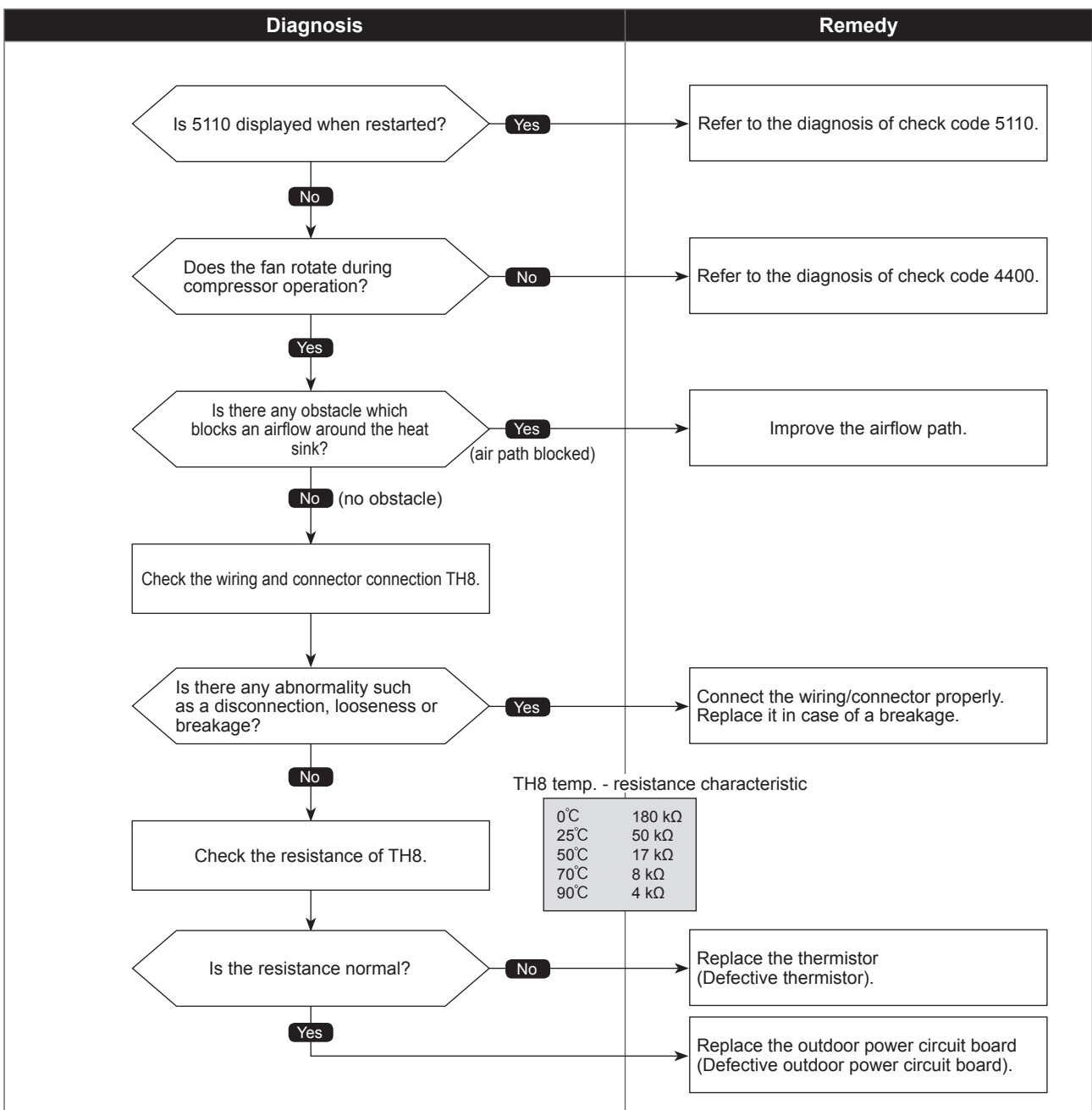

Check code

4250
(U6)

Power module trouble or Overcurrent trouble

Abnormal points and detection methods	Causes and check points
<p>Abnormal if both of the following conditions have been satisfied:</p> <ol style="list-style-type: none"> Overcurrent of DC bus or compressor is detected during compressor operation. Inverter power module is determined to be defected. 	<ol style="list-style-type: none"> Short-circuit caused by looseness or disconnection of compressor wiring Defective compressor Defective outdoor power circuit board

●Diagnosis of defectives

Make sure to turn the power OFF before connecting/disconnecting any connectors, or replacing boards.

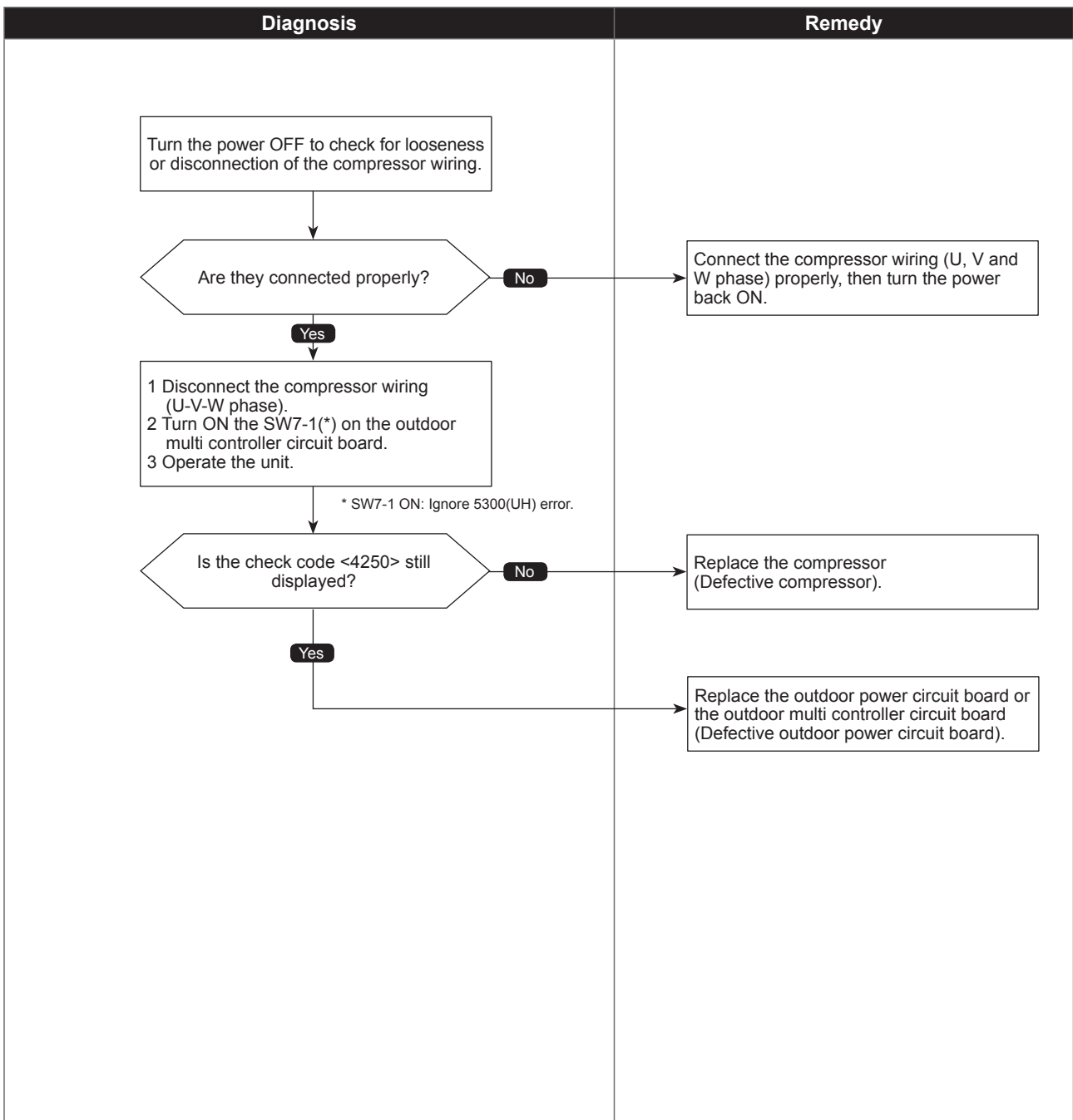

Check code

4400
(U8)

Fan trouble (Outdoor unit)

Abnormal points and detection methods	Causes and check points
Abnormal if no rotational frequency is detected, or detected a value outside the specified range during fan motor operation.	① Malfunction of fan motor ② Disconnection of CNF connector ③ Defective outdoor multi controller circuit board

●Diagnosis of defectives

Make sure to turn the power OFF before connecting/disconnecting any connectors, or replacing boards.

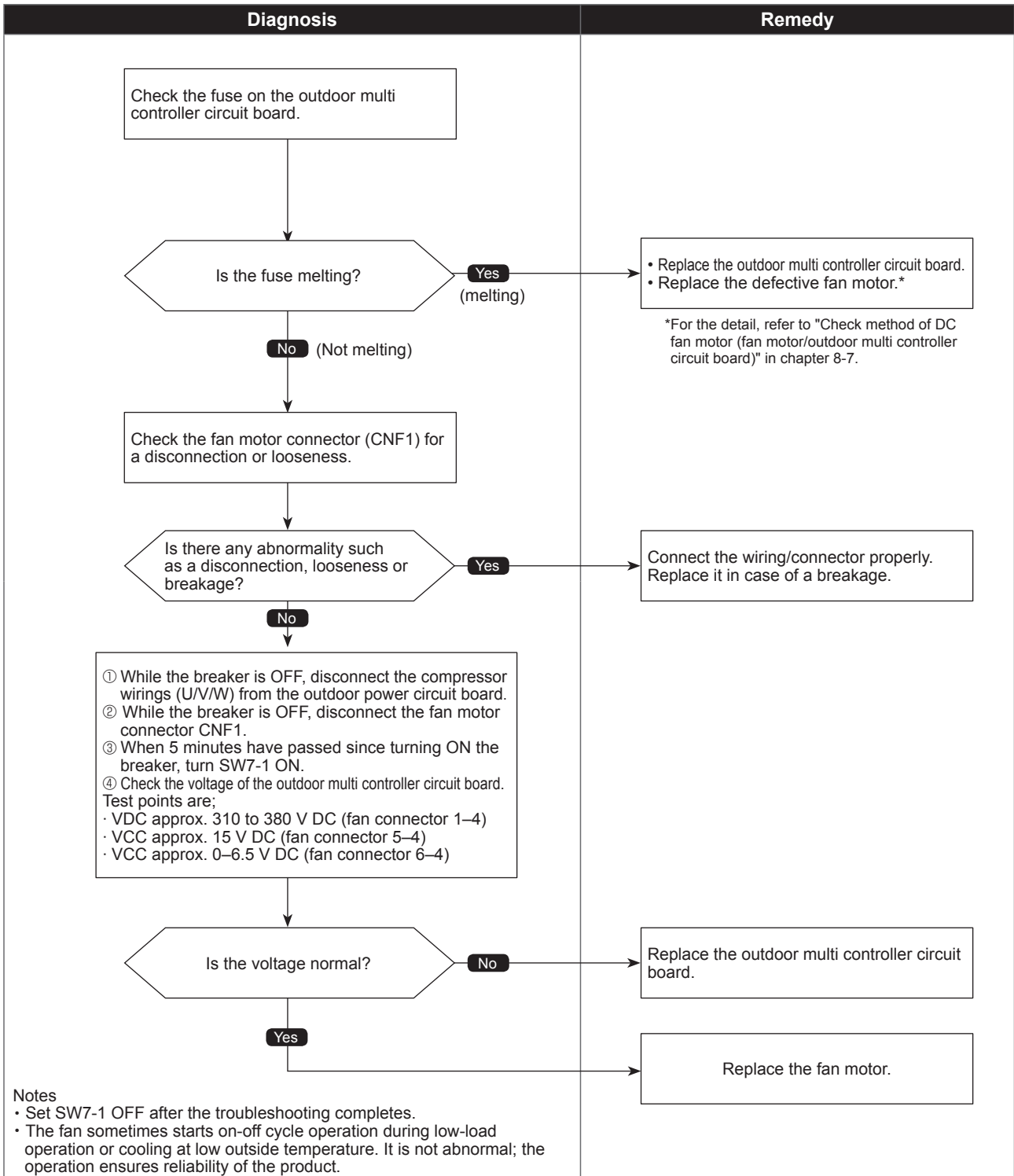

Check code

5101
(U3)

Compressor temperature thermistor (TH4) open/short

<Detected in outdoor unit>

Abnormal points and detection methods	Causes and check points
Abnormal if TH4 detects to be open/short. (The open/short detection is disabled for 10 minutes after compressor starts, during defrosting operation, or for 10 minutes after returning from the defrosting operation.) Open: 3°C [37°F] or less Short: 217°C [423°F] or more TH4: Thermistor <Compressor>	① Disconnection or contact failure of connectors ② Characteristic defect of thermistor ③ Defective outdoor multi controller circuit board

●Diagnosis of defectives

Make sure to turn the power OFF before connecting/disconnecting any connectors, or replacing boards.

The black square (■) indicates a switch position.

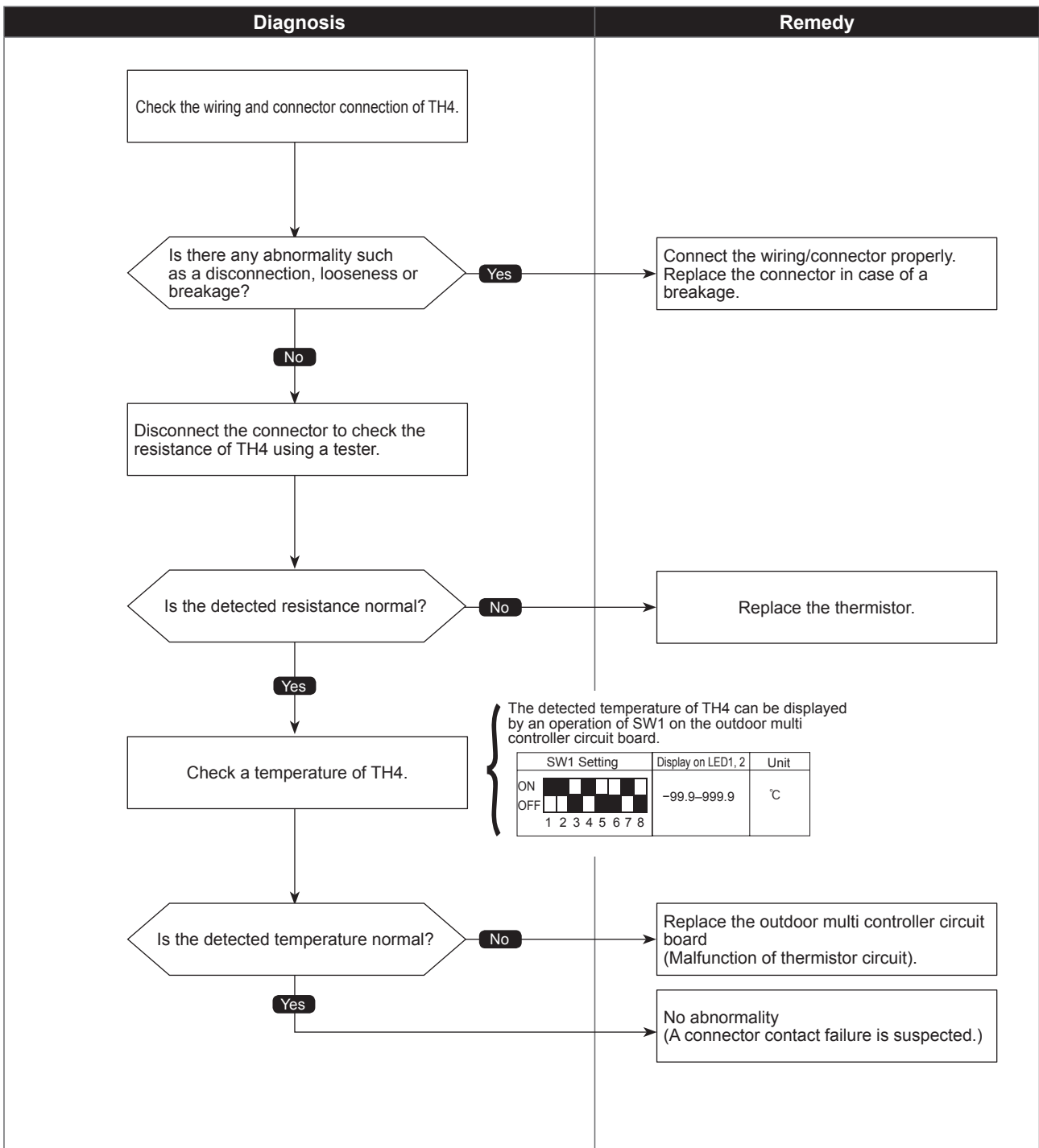

Check code

5102
(U4)

Suction pipe temperature thermistor (TH6) open/short

<Detected in outdoor unit>

Abnormal points and detection methods	Causes and check points
Abnormal if TH6 detects to be open/short. (The open/short detection is disabled during 10 seconds to 10 minutes after compressor starts, during defrosting operation, or for 10 minutes after returning from the defrosting operation.) Open: -40°C [-40°F] or less Short: 90°C [162°F] or more TH6: Thermistor <Suction pipe>	① Disconnection or contact failure of connectors ② Characteristic defect of thermistor ③ Defective outdoor multi controller circuit board

●Diagnosis of defectives

Make sure to turn the power OFF before connecting/disconnecting any connectors, or replacing boards.

The black square (■) indicates a switch position.

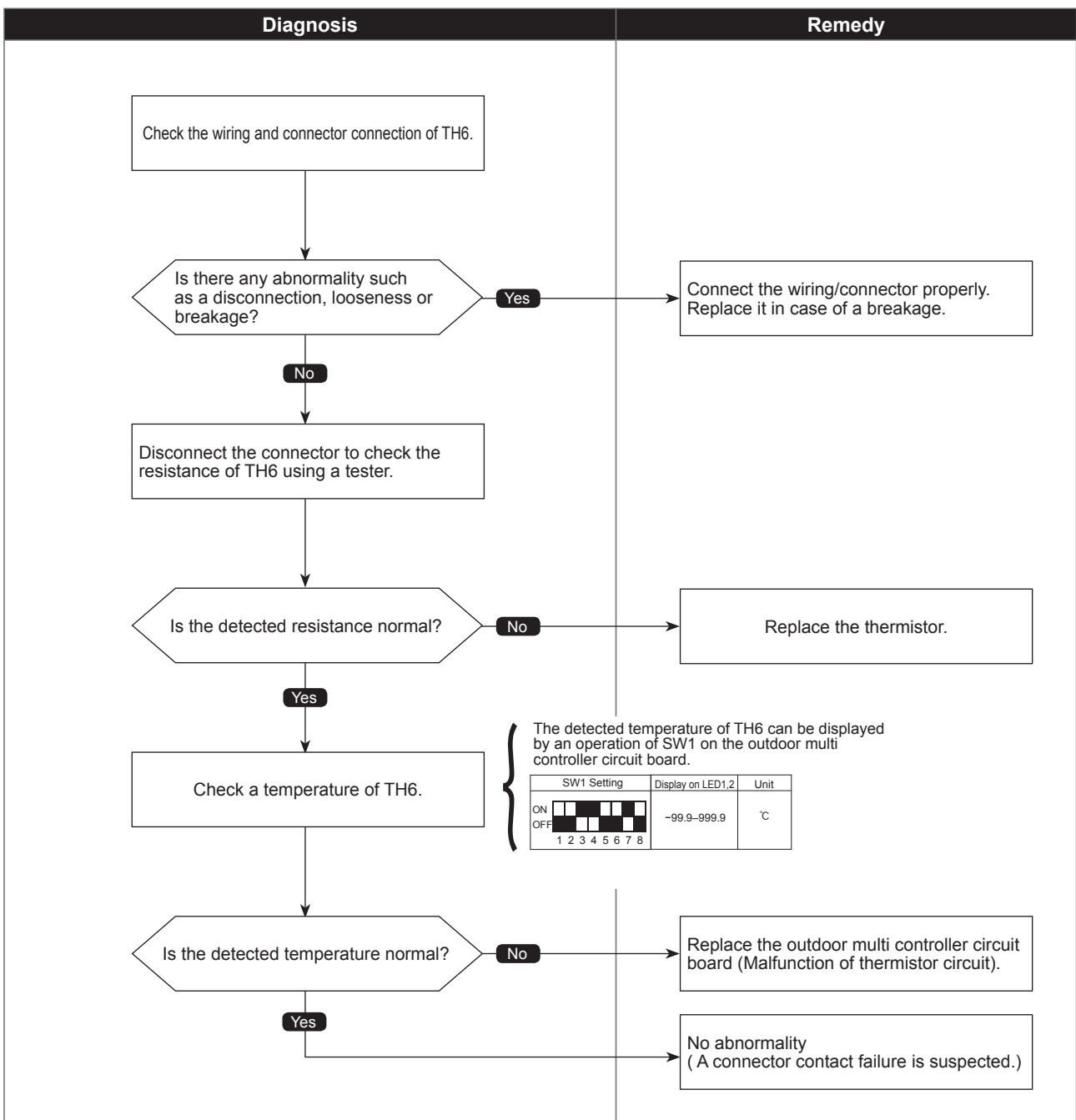

Check code

5105
(U4)

Outdoor liquid pipe temperature thermistor (TH3) open/short

Abnormal points and detection methods	Causes and check points
<p>Abnormal if TH3 detects to be open/short. (The open/short detection is disabled during 10 seconds to 10 minutes after compressor starts, during defrosting operation, or for 10 minutes after returning from the defrosting operation.) Open: -40°C [-40°F] or less Short: 90°C [162°F] or more TH3: Thermistor <Outdoor liquid pipe></p>	<p>① Disconnection or contact failure of connectors ② Characteristic defect of thermistor ③ Defective outdoor multi controller circuit board</p>

●Diagnosis of defectives

Make sure to turn the power OFF before connecting/disconnecting any connectors, or replacing boards.

The black square (■) indicates a switch position.

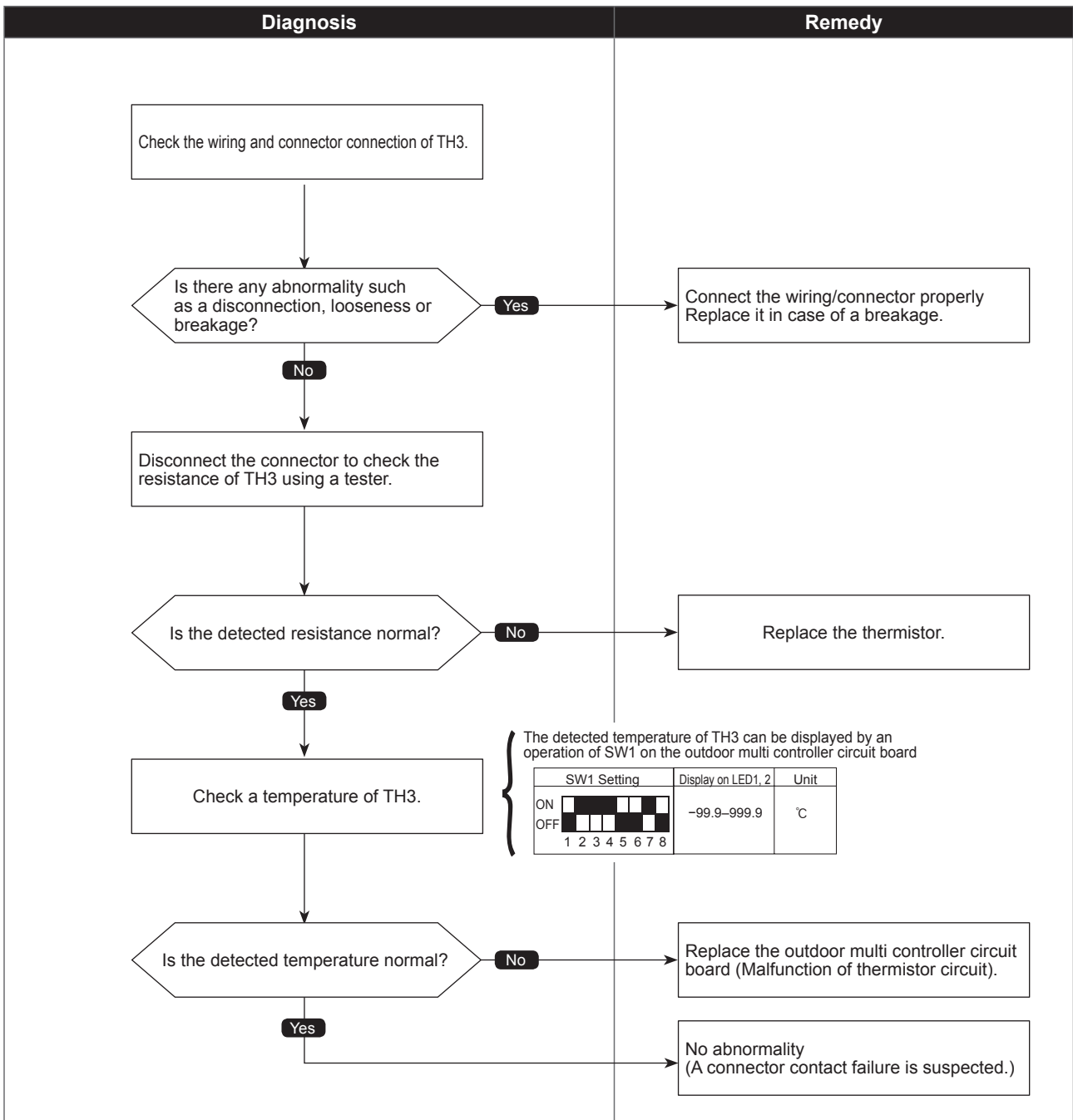

Ambient temperature thermistor (TH7) open/short

Abnormal points and detection methods	Causes and check points
Abnormal if TH7 detects to be open/short Open: -40°C [-40°F] or less Short: 90°C [162°F] or more TH7: Thermistor <Ambient>	① Disconnection or contact failure of connectors ② Characteristic defect of thermistor ③ Defective outdoor multi controller circuit board

- Diagnosis of defectives
 Make sure to turn the power OFF before connecting/disconnecting any connectors, or replacing boards.

The black square (■) indicates a switch position.

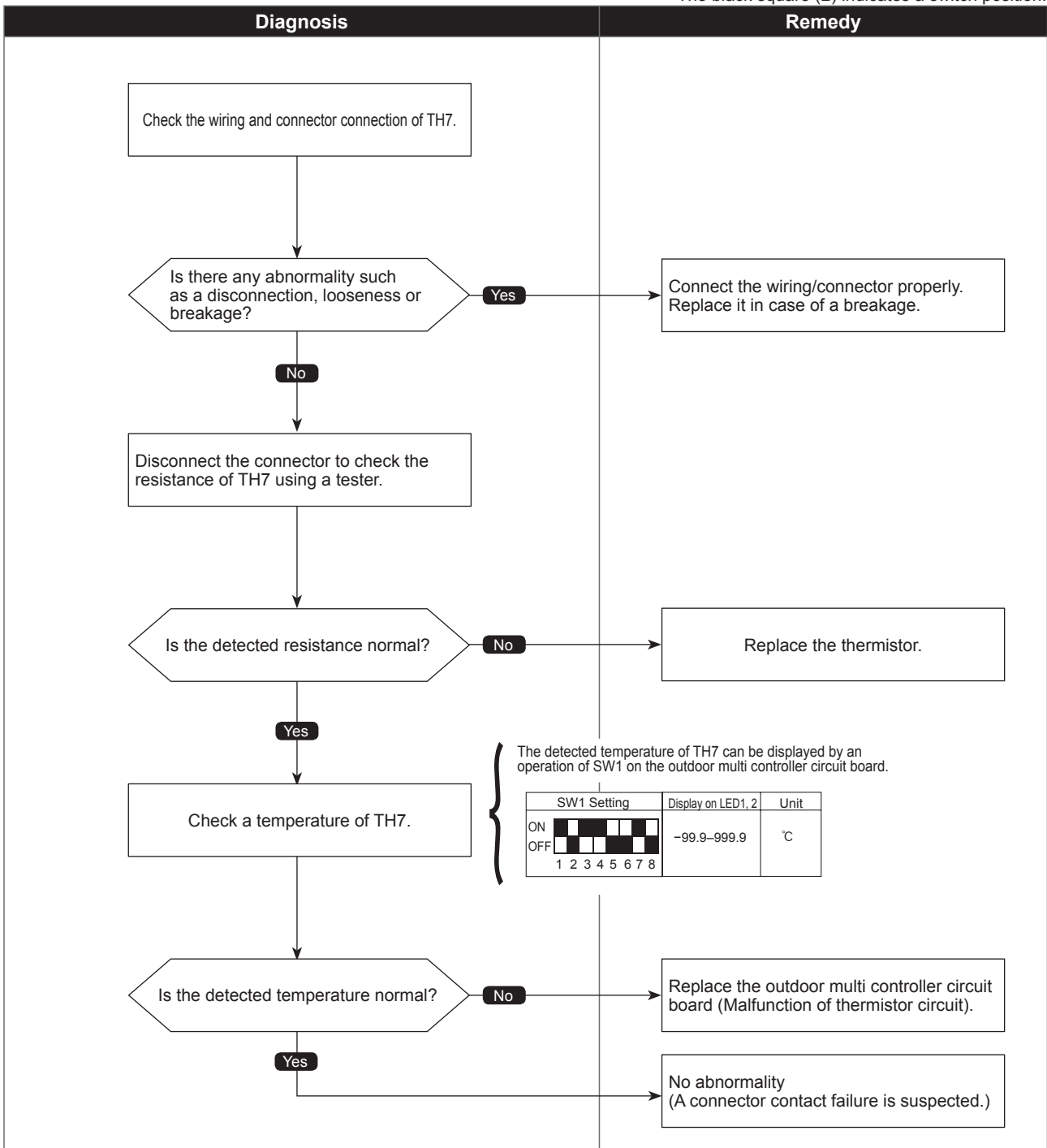

HIC pipe temperature thermistor (TH2) open/short

Abnormal points and detection methods	Causes and check points
Abnormal if TH2 detects to be open/short. Open: -40°C [-40°F] or less Short: 90°C [162°F] or more TH2: Thermistor <HIC pipe>	① Disconnection or contact failure of connectors ② Characteristic defect of thermistor ③ Defective outdoor multi controller circuit board

●Diagnosis of defectives

Make sure to turn the power OFF before connecting/disconnecting any connectors, or replacing boards.

The black square (■) indicates a switch position.

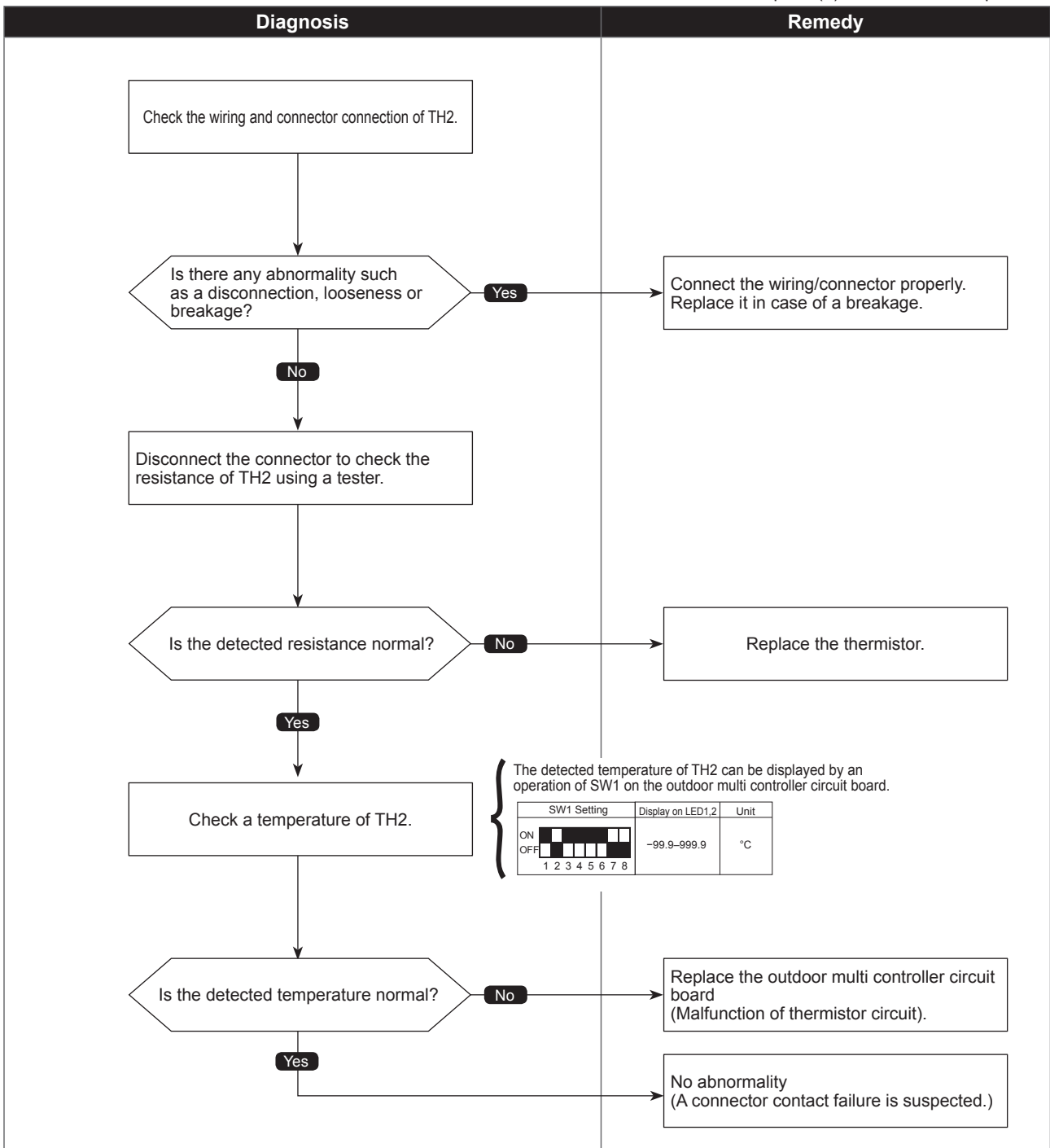

Check code

5110
(U4)

Heat sink temperature thermistor(TH8) open/short

Abnormal points and detection methods	Causes and check points
Abnormal if TH8 (Internal thermistor) detects to be open/short. Open: -34.8°C [-30.6°F] or less Short: 102°C [215.6°F] or more TH8: Thermistor <Heat sink>	① Disconnection or contact failure of connectors ② Characteristic defect of thermistor ③ Defective outdoor multi controller circuit board

●Diagnosis of defectives

Make sure to turn the power OFF before connecting/disconnecting any connectors, or replacing boards.

The black square (■) indicates a switch position.

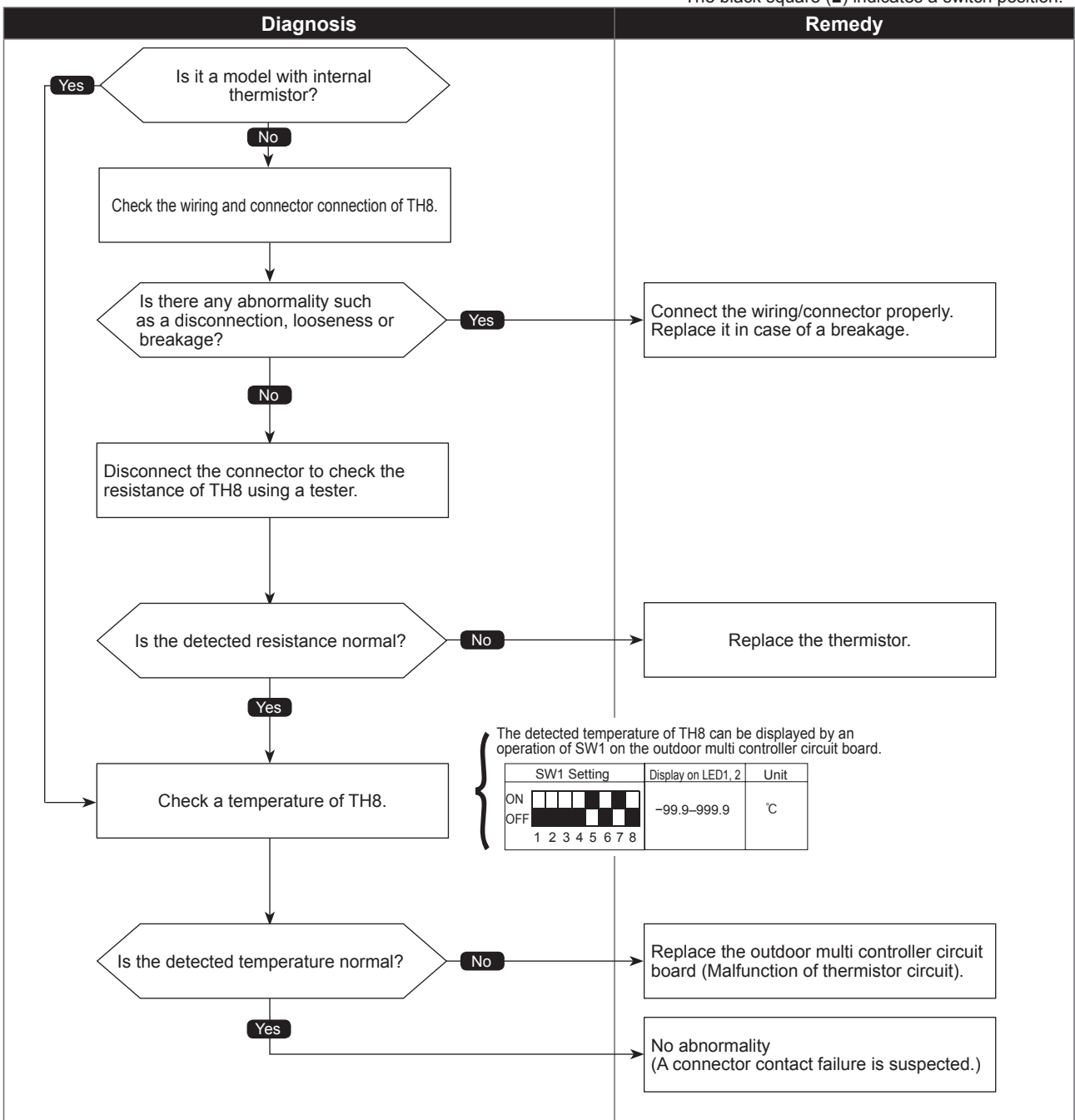

High pressure sensor (63HS) trouble

Abnormal points and detection methods	Causes and check points
<p>① When the detected pressure in the High pressure sensor is 1kgf/cm² or less during operation, the compressor stops operation and enters into an anti-restart mode for 3 minutes.</p> <p>② When the detected pressure is 1kgf/cm² or less immediately before restarting, the compressor falls into an abnormal stop with a check code <5201>.</p> <p>③ For 3 minutes after compressor restarting, during defrosting operation, and for 3 minutes after returning from defrosting operation, above mentioned symptoms are not determined as abnormal.</p>	<p>① Defective High pressure sensor</p> <p>② Decrease of internal pressure caused by gas leakage</p> <p>③ Disconnection or contact failure of connector</p> <p>④ Malfunction of input circuit on outdoor multi controller circuit board</p>

●Diagnosis of defectives

Make sure to turn the power OFF before connecting/disconnecting any connectors, or replacing boards.

The black square (■) indicates a switch position.

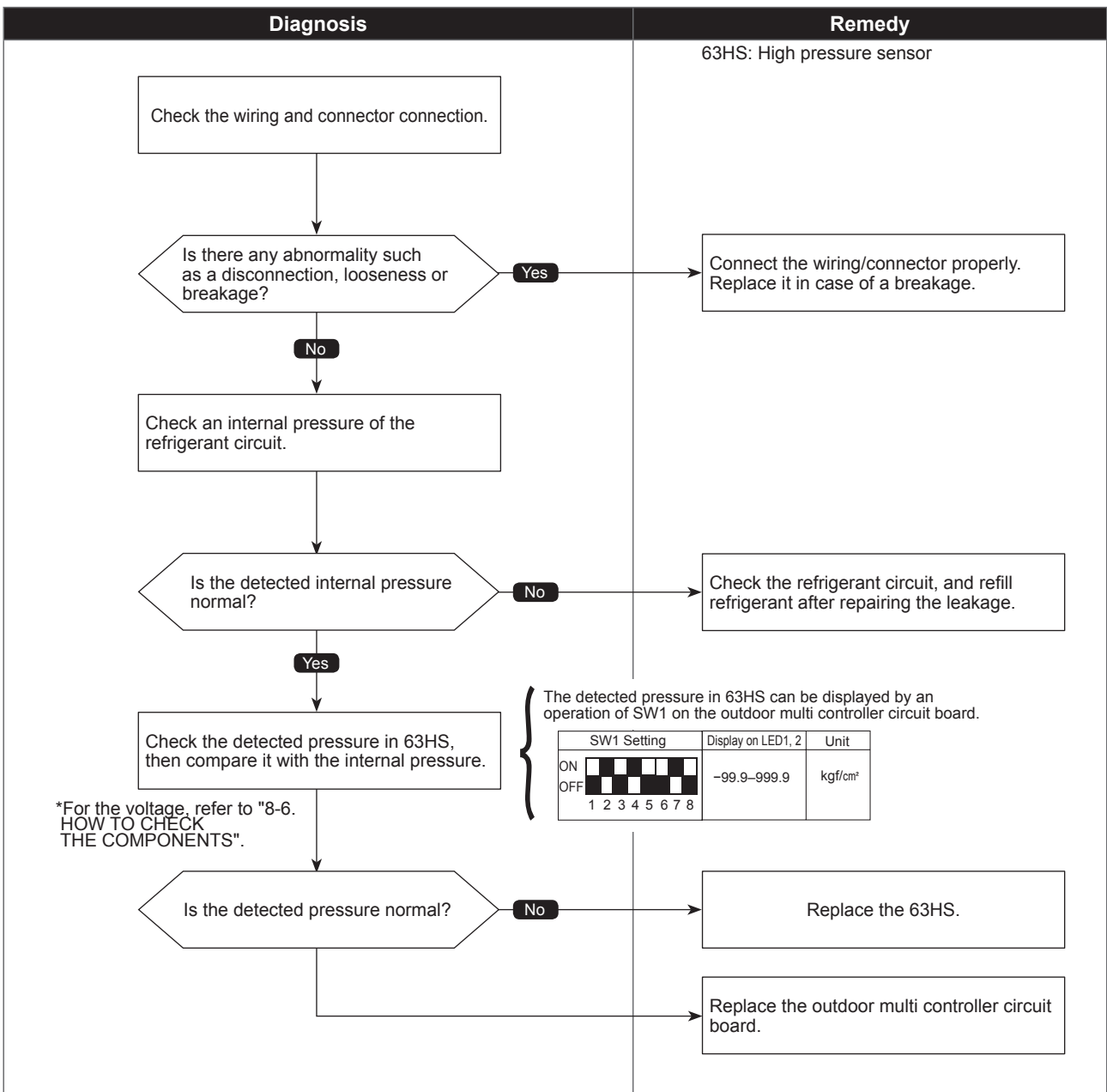

Check code

5202
(F3)

Low pressure sensor (63LS) trouble

Abnormal points and detection methods	Causes and check points
<p>① When the detected pressure in the Low pressure sensor is -2.3kgf/cm^2 or less, or 23.1kgf/cm^2 or more during operation, the compressor stops operation with a check code <5202>.</p> <p>② For 3 minutes after compressor restarting, during defrosting operation, and for 3 minutes after returning from defrosting operation, above mentioned symptoms are not determined as abnormal.</p>	<p>① Defective Low pressure sensor</p> <p>② Decrease of internal pressure caused by gas leakage</p> <p>③ Disconnection or contact failure of connector</p> <p>④ Malfunction of input circuit on outdoor multi controller circuit board</p>

●Diagnosis of defectives

Make sure to turn the power OFF before connecting/disconnecting any connectors, or replacing boards.

The black square (■) indicates a switch position.

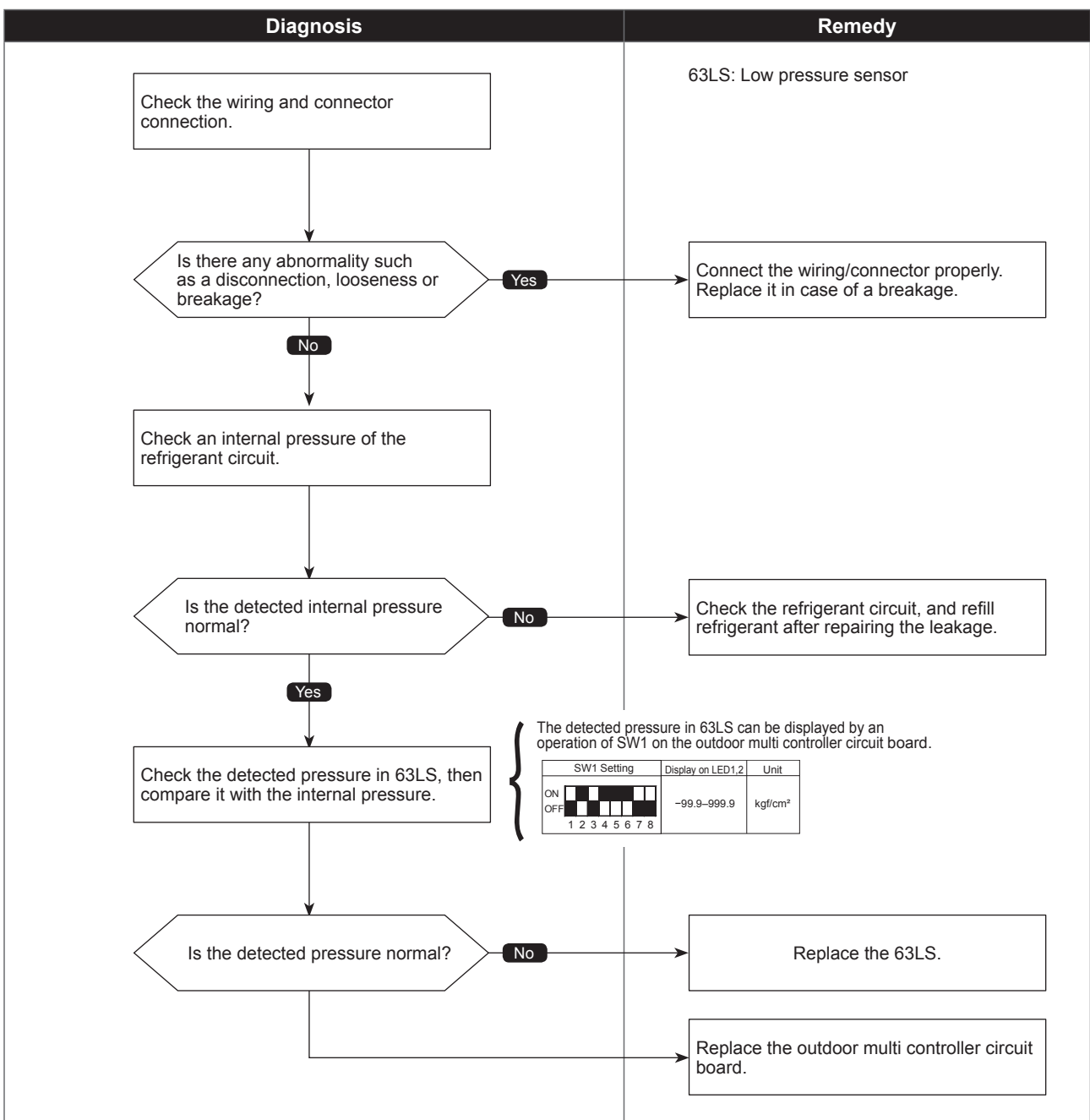

Primary current error

Abnormal points and detection methods	Causes and check points									
<p>Abnormal if any of the following conditions is detected:</p> <p>1 Primary current sensor detects any of the following conditions (single phase unit only):</p> <table border="1"> <thead> <tr> <th>Ambient temperature</th> <th>10 consecutive-second detection</th> <th>One-time detection</th> </tr> </thead> <tbody> <tr> <td>TH7 > 3°C</td> <td>37 A</td> <td>40 A</td> </tr> <tr> <td>TH7 ≤ 3°C</td> <td>40 A</td> <td>43A</td> </tr> </tbody> </table> <p>2 Secondary current sensor detects 25 A or more. 3 Secondary current sensor detects 1.0 A or less.</p>	Ambient temperature	10 consecutive-second detection	One-time detection	TH7 > 3°C	37 A	40 A	TH7 ≤ 3°C	40 A	43A	<p>① Decrease/trouble of power supply voltage ② Disconnection of compressor wiring ③ Current sensor trouble on outdoor power circuit board ④ Wiring through current sensor (penetration type) is not done.</p>
Ambient temperature	10 consecutive-second detection	One-time detection								
TH7 > 3°C	37 A	40 A								
TH7 ≤ 3°C	40 A	43A								

●Diagnosis of defectives

Make sure to turn the power OFF before connecting/disconnecting any connectors, or replacing boards.

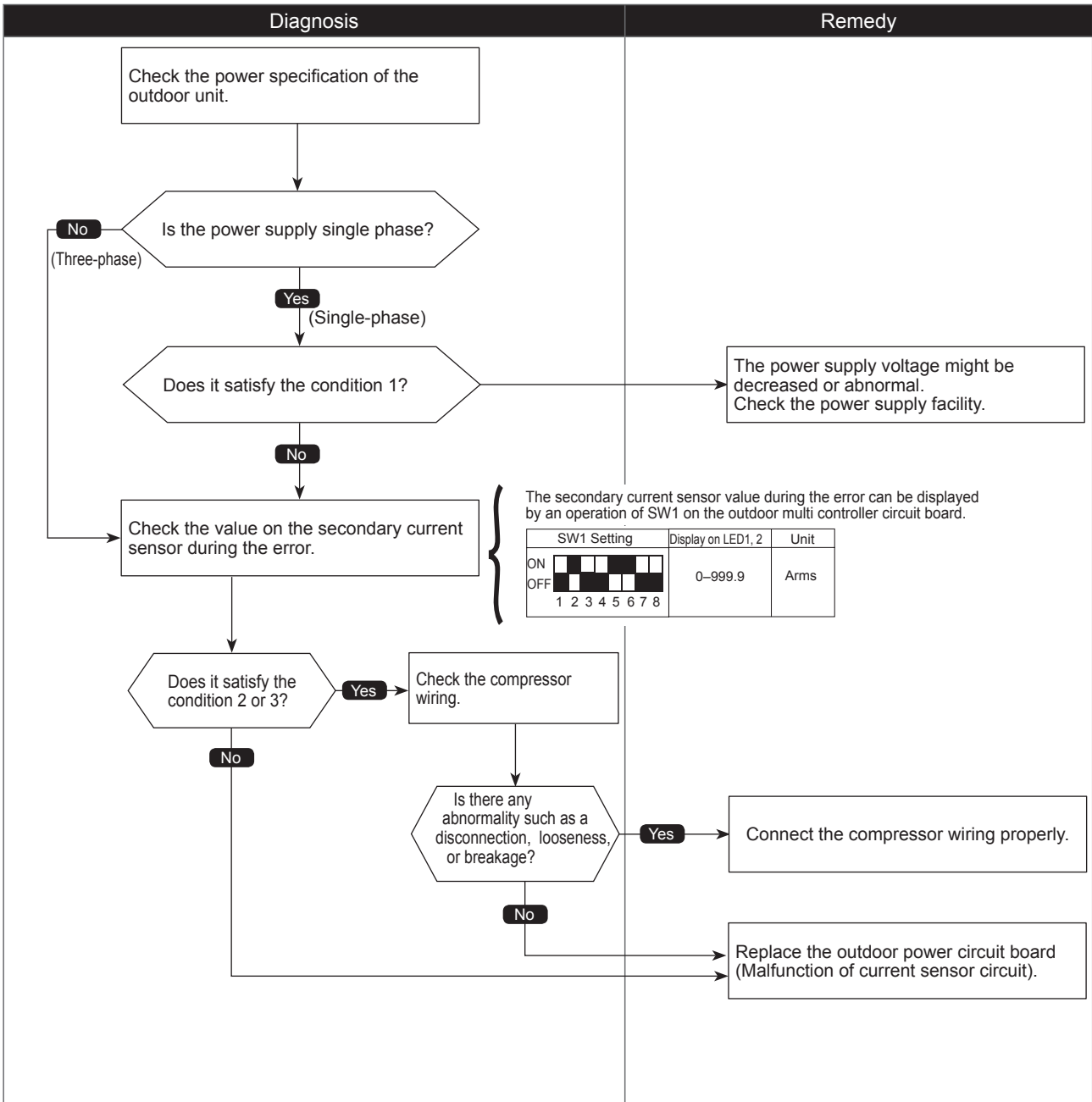

Check code

6600
(A0)

Duplex address error

Abnormal points and detection methods	Causes and check points
Abnormal if 2 or more units with the same address are existing.	① There are 2 units or more with the same address in their controller among outdoor unit, indoor unit, Fresh Master, Lossnay or remote controller ② Noise interference on indoor/outdoor connectors

●Diagnosis of defectives

Make sure to turn the power OFF before connecting/disconnecting any connectors, or replacing boards.

Diagnosis	Remedy
<pre>graph TD; A[Search for a unit with the same address as the source of abnormality.] --> B{Is there any unit with the same address?}; B -- Yes --> C[Correct the address, and turn the power OFF of indoor/outdoor unit, Fresh Master or Lossnay simultaneously for 2 minutes or more, then turn the power back ON.]; B -- No --> D[Turn the power back ON.]; D --> E{Does it operate normally?}; E -- No --> F[Malfunction of sending/receiving circuit on indoor/outdoor unit is suspected.]; E -- Yes --> G[There is no abnormality on the AC unit. It might be caused by an external noise, so check the transmission line to remove the factor(s).];</pre>	

Check code

6602
(A2)

Transmission processor hardware error

Abnormal points and detection methods	Causes and check points
<p>Abnormal if the transmission line shows "1" although the transmission processor transmitted "0".</p>	<ul style="list-style-type: none"> ① A transmitting data collision occurred because of a wiring work or polarity change has performed while the power is ON on either of the indoor/outdoor unit, Fresh Master or Lossnay ② Malfunction of transmitting circuit on transmission processor ③ Noise interference on indoor/outdoor connectors

●Diagnosis of defectives

Make sure to turn the power OFF before connecting/disconnecting any connectors, or replacing boards.

Diagnosis	Remedy
<pre> graph TD Q1{{A wiring work was performed while the power OFF.}} Q1 -- No --> R1[If the wiring work was performed while the power ON, turn the power OFF of indoor/outdoor unit, Fresh Master or Lossnay simultaneously for 2 minutes or more, then turn the power back ON.] Q1 -- Yes --> P1[Turn the power back ON.] P1 --> Q2{{Does it operate normally?}} Q2 -- No --> R2[Replace the indoor/outdoor controller board.] Q2 -- Yes --> R3[There is no abnormality on the AC unit. It might be caused by an external noise, so check the transmission line to remove the factor(s).] </pre>	<div data-bbox="967 786 1393 920" style="border: 1px solid black; padding: 5px; margin-bottom: 10px;"> <p>If the wiring work was performed while the power ON, turn the power OFF of indoor/outdoor unit, Fresh Master or Lossnay simultaneously for 2 minutes or more, then turn the power back ON.</p> </div> <div data-bbox="967 1252 1393 1346" style="border: 1px solid black; padding: 5px; margin-bottom: 10px;"> <p>Replace the indoor/outdoor controller board.</p> </div> <div data-bbox="967 1391 1393 1525" style="border: 1px solid black; padding: 5px;"> <p>There is no abnormality on the AC unit. It might be caused by an external noise, so check the transmission line to remove the factor(s).</p> </div>

Transmission bus BUSY error

Abnormal points and detection methods	Causes and check points
<p>① Over error by collision Abnormal if no-transmission status caused by a transmitting data collision is consecutive for 8 to 10 minutes.</p> <p>② Abnormal if a status, that data is not allowed on the transmission line because of noise and such, is consecutive for 8 to 10 minutes.</p>	<p>① The transmission processor is unable to transmit due to a short-cycle voltage such as noise is mixed on the transmission line.</p> <p>② The transmission processor is unable to transmit due to an increase of transmission data amount caused by a miswiring of the terminal block (transmission line) (TB3) and the terminal block (centralized control line) (TB7) on the outdoor unit.</p> <p>③ The share on transmission line becomes high due to a mixed transmission caused by a malfunction of repeater on the outdoor unit, which is a function to connect/disconnect transmission from/to control system and centralized control system.</p>

● Diagnosis of defectives

Make sure to turn the power OFF before connecting/disconnecting any connectors, or replacing boards.

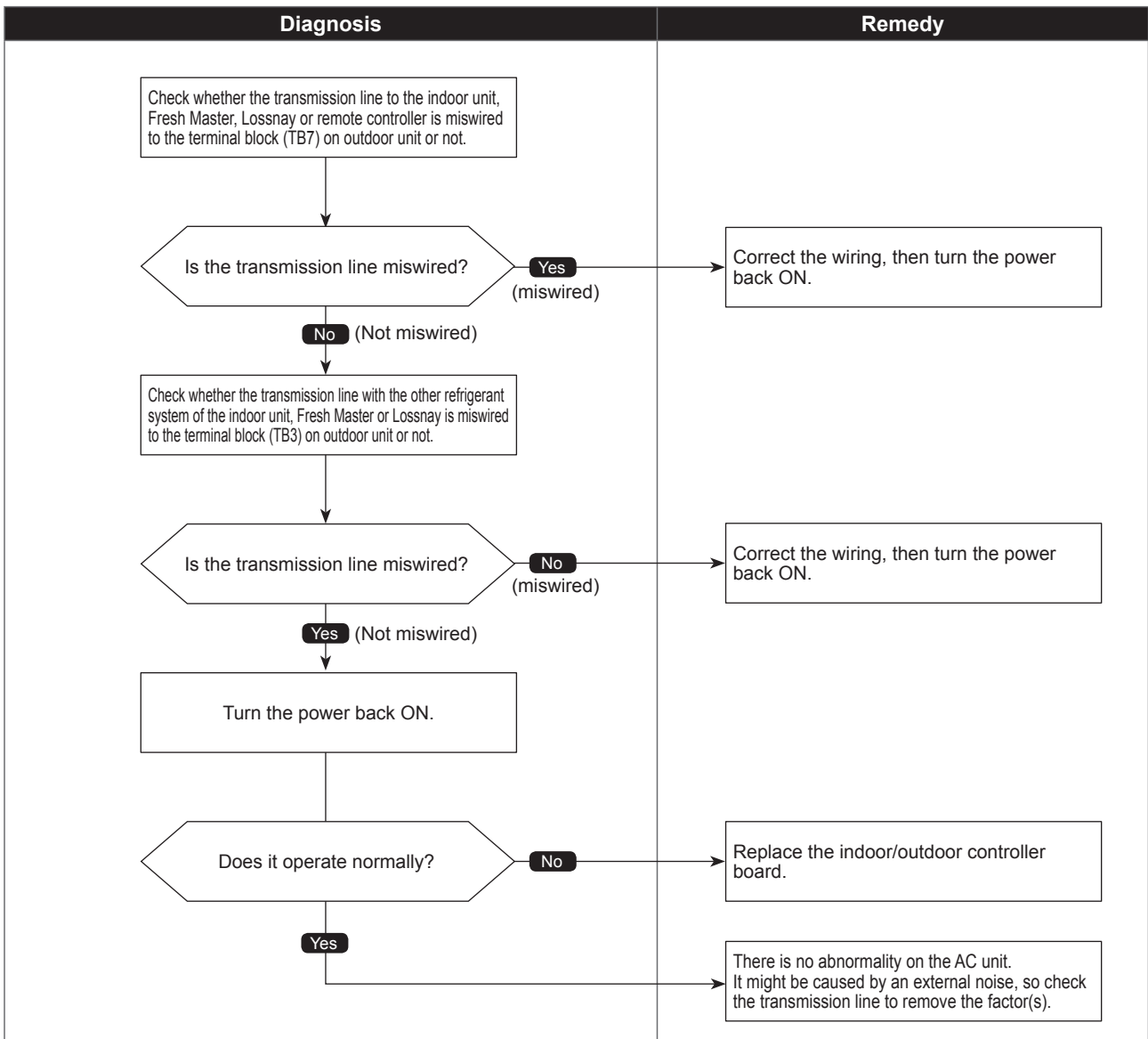

Check code

6606
(A6)

Signal communication error with transmission processor

Abnormal points and detection methods	Causes and check points
<p>① Abnormal if the data of unit/transmission processor were not normally transmitted.</p> <p>② Abnormal if the address transmission from the unit processor was not normally transmitted.</p>	<p>① Accidental disturbance such as noise or lightning surge</p> <p>② Hardware malfunction of transmission processor</p>

●Diagnosis of defectives

Make sure to turn the power OFF before connecting/disconnecting any connectors, or replacing boards.

Diagnosis	Remedy
<p>Turn the power OFF of indoor/outdoor unit, Fresh Master, Lossnay and remote controller simultaneously for 2 minutes or more, then turn the power back ON.</p> <p>Does it operate normally?</p> <p>Yes</p> <p>No</p>	<p>Replace the controller. (Defect of error source controller).</p> <p>There is no abnormality on the AC unit. It might be caused by an external noise, so check the transmission line to remove the factor(s).</p>

Abnormal points and detection methods	Causes and check points
<p>① Represents a common error detection An abnormality detected by the sending side controller when receiving no ACK from the receiving side, though signal was once sent. The sending side searches the error in 30 seconds interval for 6 times continuously.</p>	<p>① The previous address unit does not exist since the address switch was changed while in electric continuity status. ② Decline of transmission voltage/signal caused by tolerance over on transmission line ·At the furthest end: 200 m ·On remote controller line: (12 m) ③ Decline of transmission voltage/signal due to unmatched transmission line types ·Types for shield line: CVVS, CPEVS, or MVVS ·Line diameter: 1.25 mm² or more ④ Decline of transmission voltage/signal due to excessive number of connected units ⑤ Malfunction due to accidental disturbance such as noise or lightning surge ⑥ Defect of error source controller</p>
<p>② The cause of displayed address and attribute is on the outdoor unit side An abnormality detected by the indoor unit if receiving no ACK when transmitting signal from the indoor unit to the outdoor unit.</p>	<p>① Contact failure of indoor/outdoor unit transmission line. ② Disconnection of transmission connector (CN2M) on indoor unit. ③ Malfunction of sending/receiving circuit on indoor/outdoor unit.</p>
<p>③ The cause of displayed address and attribute is on the indoor unit side An abnormality detected by the remote controller if receiving no ACK when sending data from the remote controller to the indoor unit.</p>	<p>① While operating with multi refrigerant system indoor units, an abnormality is detected when the indoor unit transmit signal to the remote controller during the other refrigerant-system outdoor unit is turned OFF, or within 2 minutes after it turned back ON. ② Contact failure of indoor unit or remote controller transmission line ③ Disconnection of transmission connector (CN2M) on indoor unit ④ Malfunction of sending/receiving circuit on indoor unit or remote controller</p>
<p>④ The cause of the displayed address and attribute is on the remote controller side An abnormality detected by the indoor unit if receiving no ACK when transmitting signal from the indoor unit to the remote controller.</p>	<p>① While operating with multi refrigerant system indoor units, an abnormality is detected when the indoor unit transmit signal to the remote controller during the other refrigerant-system outdoor unit is turned OFF, or within 2 minutes after it turned back ON. ② Contact failure of indoor unit or remote controller transmission line ③ Disconnection of transmission connector (CN2M) on indoor unit ④ Malfunction of sending/receiving circuit on indoor unit or remote controller</p>

No ACK error

Abnormal points and detection methods	Causes and check points
<p>⑤ The cause of displayed address and attribute is on the Fresh Master side An abnormality detected by the indoor unit if receiving no ACK when transmitting signal from the indoor unit to the Fresh Master.</p>	<p>① While the indoor unit is operating with multi refrigerant system Fresh Master, an abnormality is detected when the indoor unit transmits signal to the remote controller while the outdoor unit with the same refrigerant system as the Fresh Master is turned OFF, or within 2 minutes after it turned back ON.</p> <p>② Contact failure of indoor unit or Fresh Master transmission line</p> <p>③ Disconnection of transmission connector (CN2M) on indoor unit or Fresh Master</p> <p>④ Malfunction of sending/receiving circuit on indoor unit or Fresh Master</p>
<p>⑥ The cause of displayed address and attribute is on Lossnay side An abnormality detected by the indoor unit if receiving no ACK when the indoor unit transmit signal to the Lossnay.</p>	<p>① An abnormality is detected when the indoor unit transmits signal to Lossnay while the Lossnay is turned OFF.</p> <p>② While the indoor unit is operating with the other refrigerant Lossnay, an abnormality is detected when the indoor unit transmits signal to the Lossnay while the outdoor unit with the same refrigerant system as the Lossnay is turned OFF, or within 2 minutes after it turned back ON.</p> <p>③ Contact failure of indoor unit or Lossnay transmission line</p> <p>④ Disconnection of transmission connector (CN2M) on indoor unit</p> <p>⑤ Malfunction of sending/receiving circuit on indoor unit or Lossnay</p>
<p>⑦ The controller of displayed address and attribute is not recognized</p>	<p>① The previous address unit does not exist since the address switch was changed while in electric continuity status.</p> <p>② An abnormality detected at transmitting from the indoor unit since the Fresh Master/Lossnay address are changed after synchronized setting of Fresh Master/Lossnay by the remote controller.</p>

●Diagnosis of defectives

Make sure to turn the power OFF before connecting/disconnecting any connectors, or replacing boards.

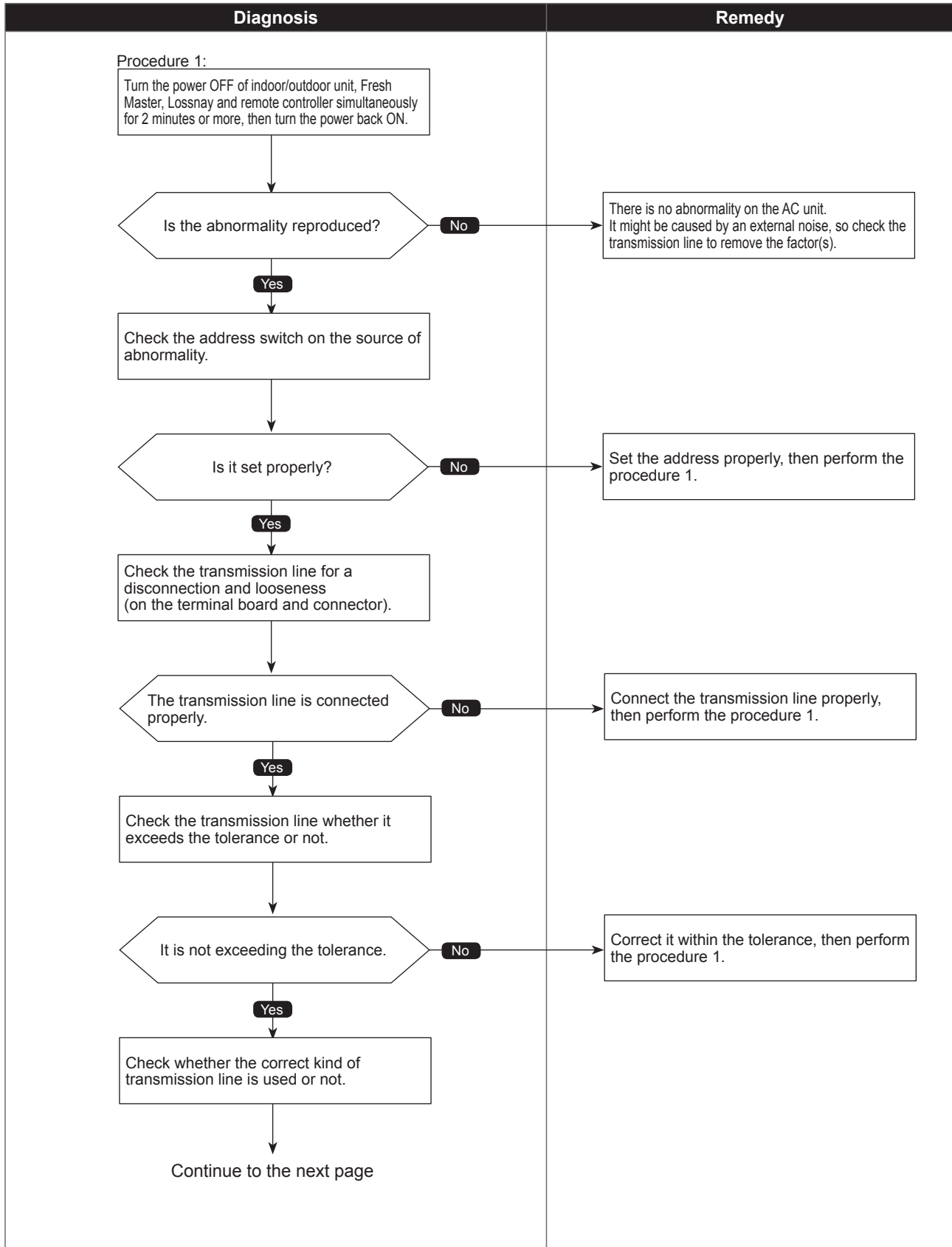

●Diagnosis of defectives

Make sure to turn the power OFF before connecting/disconnecting any connectors, or replacing boards.

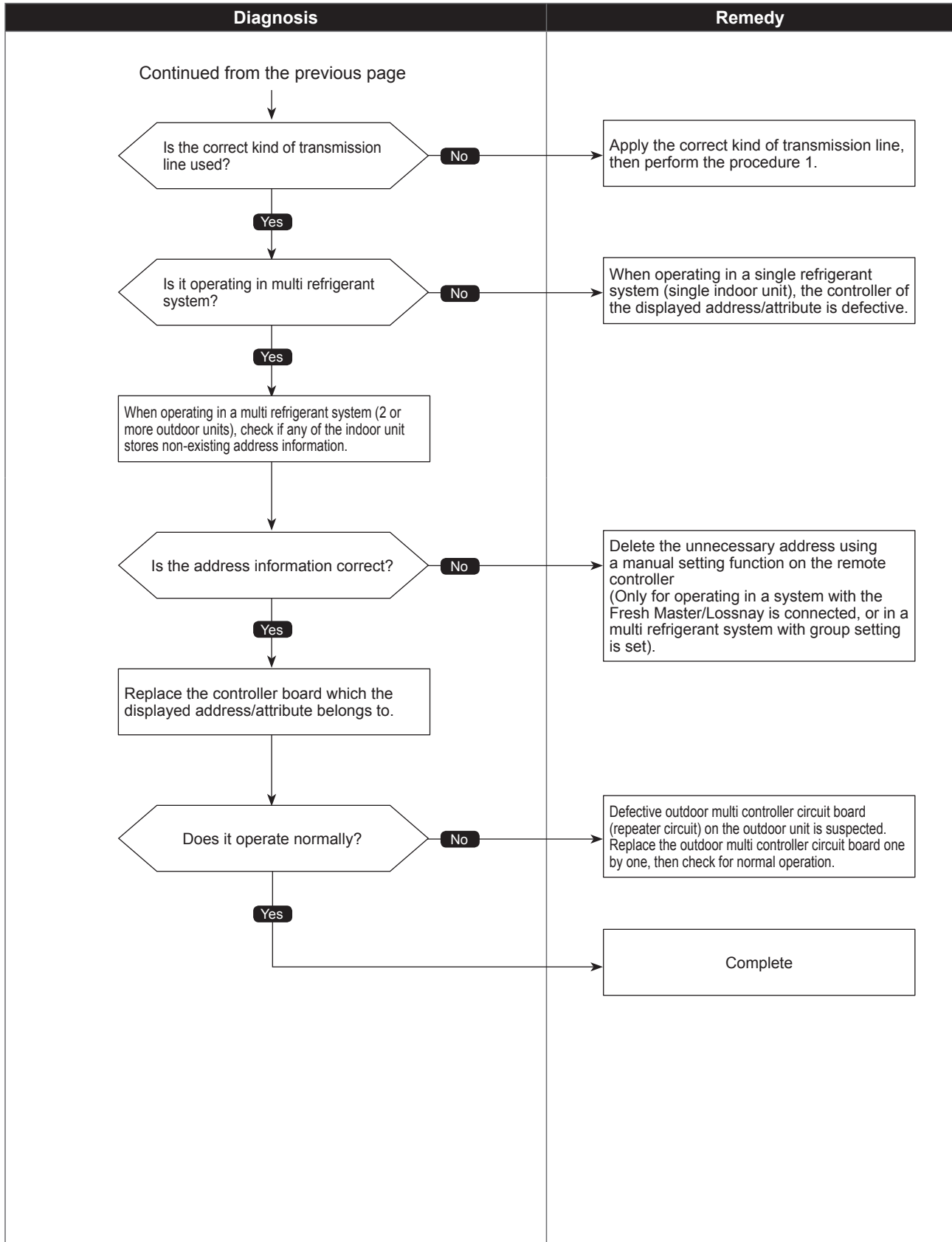

Check code

6608
(A8)

No response frame error

Abnormal points and detection methods	Causes and check points
Abnormal if receiving no response command while already received ACK. The sending side searches the error in 30 seconds interval for 6 times continuously.	<ul style="list-style-type: none"> ① Continuous failure of transmission due to noise, etc ② Decline of transmission voltage/signal caused by tolerance over on transmission line <ul style="list-style-type: none"> ·At the furthest end: 200 m ·On remote controller line: (12 m) ③ Decline of transmission voltage/signal due to unmatched transmission line types <ul style="list-style-type: none"> ·Types for shield line: CVVS, CPEVS, or MVVS ·Line diameter: 1.25 mm² or more ④ Accidental malfunction of error source controller

●Diagnosis of defectives

Make sure to turn the power OFF before connecting/disconnecting any connectors, or replacing boards.

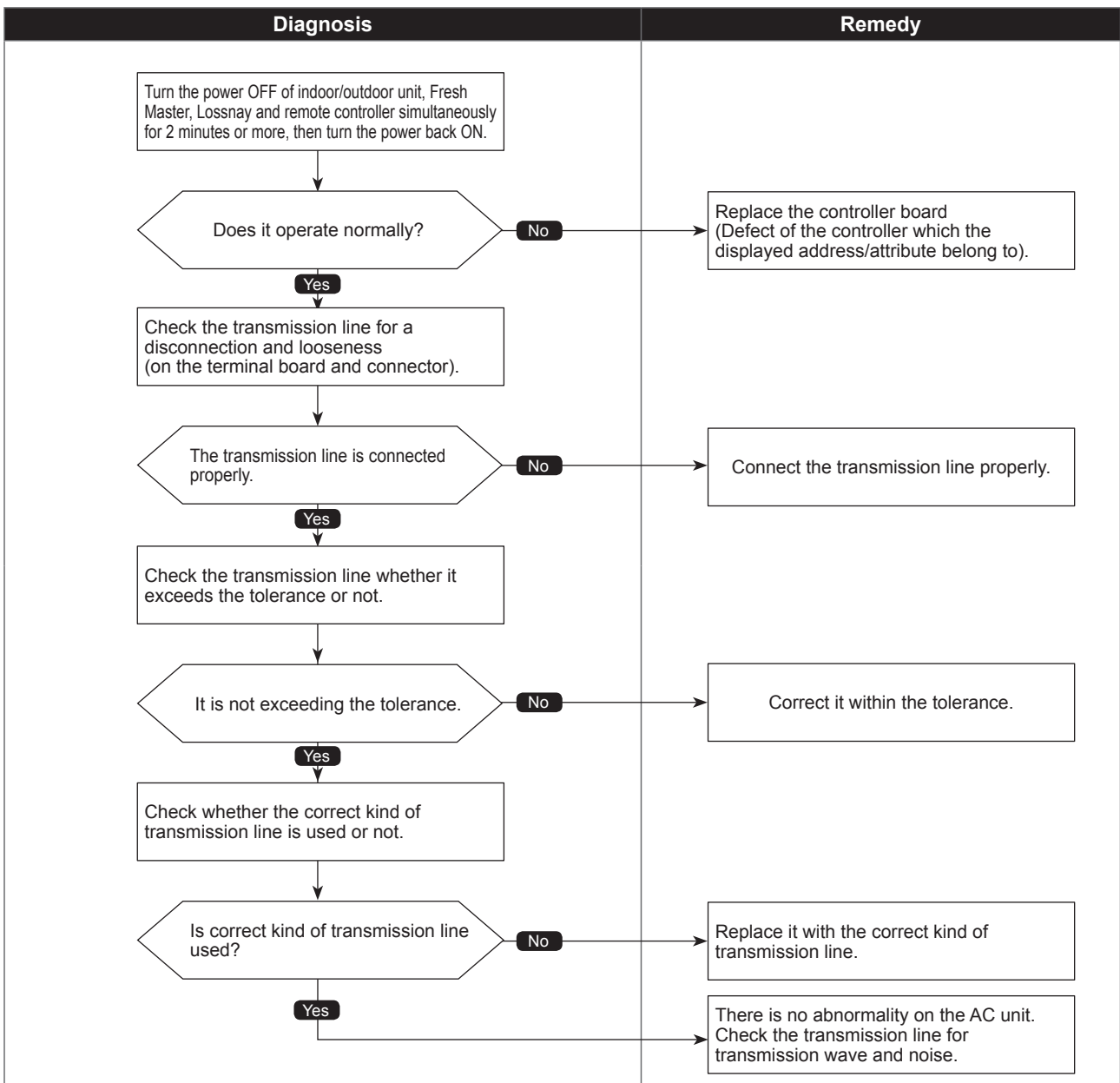

MA communication receive error

Abnormal points and detection methods	Causes and check points
<p>Detected in remote controller or indoor unit:</p> <ul style="list-style-type: none"> ① When the main or sub remote controller cannot receive signal from indoor unit which has the "0" address. ② When the sub remote controller cannot receive signal. ③ When the indoor controller board cannot receive signal from remote controller or another indoor unit. ④ When the indoor controller board cannot receive signal. 	<ul style="list-style-type: none"> ① Contact failure of remote controller wirings ② Irregular Wiring (A wiring length, number of connecting remote controllers or indoor units, or a wiring thickness does not meet the conditions specified in the chapter "Electrical Work" in the indoor unit Installation Manual.) ③ Malfunction of the remote controller sending/receiving circuit on indoor unit with the LED2 is blinking. ④ Malfunction of the remote controller sending/receiving circuit ⑤ Remote controller transmitting error caused by noise interference

●Diagnosis of defectives

Make sure to turn the power OFF before connecting/disconnecting any connectors, or replacing boards

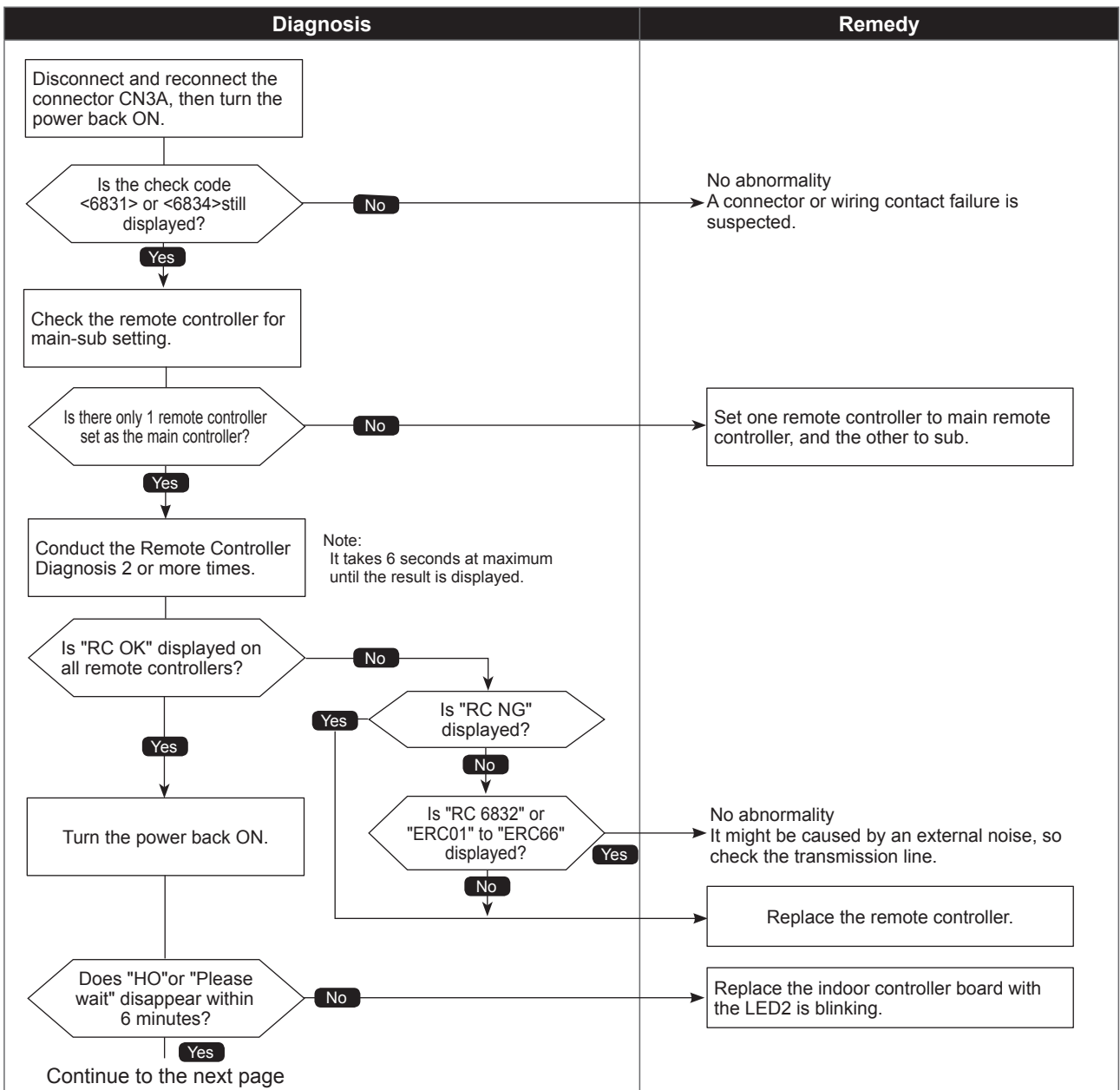

●Diagnosis of defectives

Make sure to turn the power OFF before connecting/disconnecting any connectors, or replacing boards

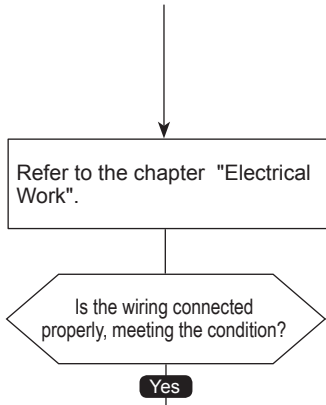
Diagnosis	Remedy
<p>Continued from the previous page</p>  <pre> graph TD Start[Continued from the previous page] --> Step1[Refer to the chapter "Electrical Work".] Step1 --> Decision{Is the wiring connected properly, meeting the condition?} Decision -- No --> Remedy1[Connect the wiring properly as specified in the chapter "Electrical Work" in the indoor unit Installation Manual.] Decision -- Yes --> Remedy2[No abnormality. It might be caused by an external noise, so check the transmission line to remove the factor(s).] </pre>	<div data-bbox="965 795 1396 884" style="border: 1px solid black; padding: 5px;"> <p>Connect the wiring properly as specified in the chapter "Electrical Work" in the indoor unit Installation Manual.</p> </div> <p>No abnormality It might be caused by an external noise, so check the transmission line to remove the factor(s).</p>

MA communication send error

Abnormal points and detection methods	Causes and check points
Detected in remote controller or indoor unit.	<ul style="list-style-type: none"> ① There are 2 remote controllers set as main. ② Malfunction of remote controller sending/receiving circuit ③ Malfunction of sending/receiving circuit on indoor controller board ④ Remote controller transmitting error caused by noise interference

●Diagnosis of defectives

Make sure to turn the power OFF before connecting/disconnecting any connectors, or replacing boards

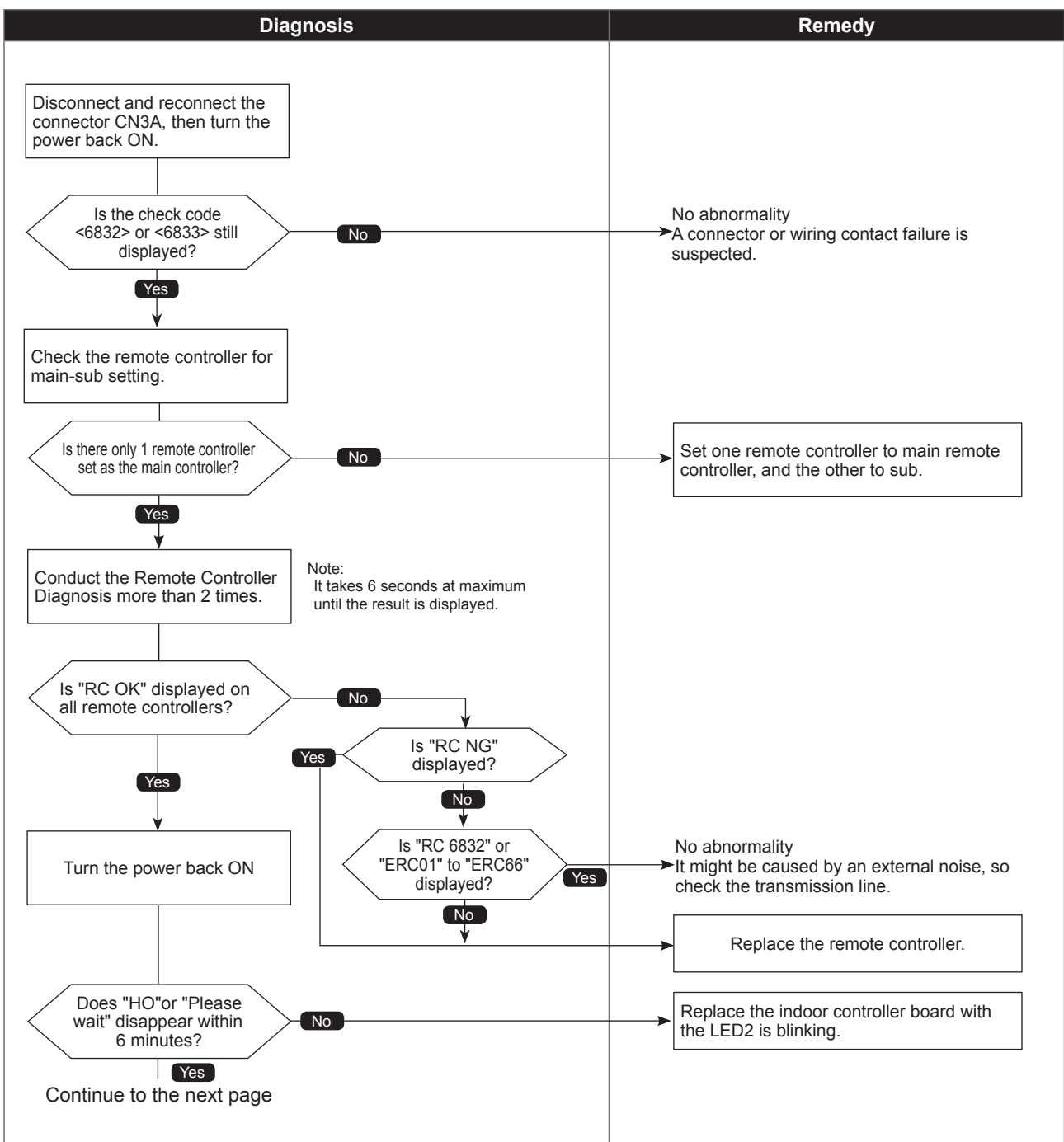

●Diagnosis of defectives

Make sure to turn the power OFF before connecting/disconnecting any connectors, or replacing boards

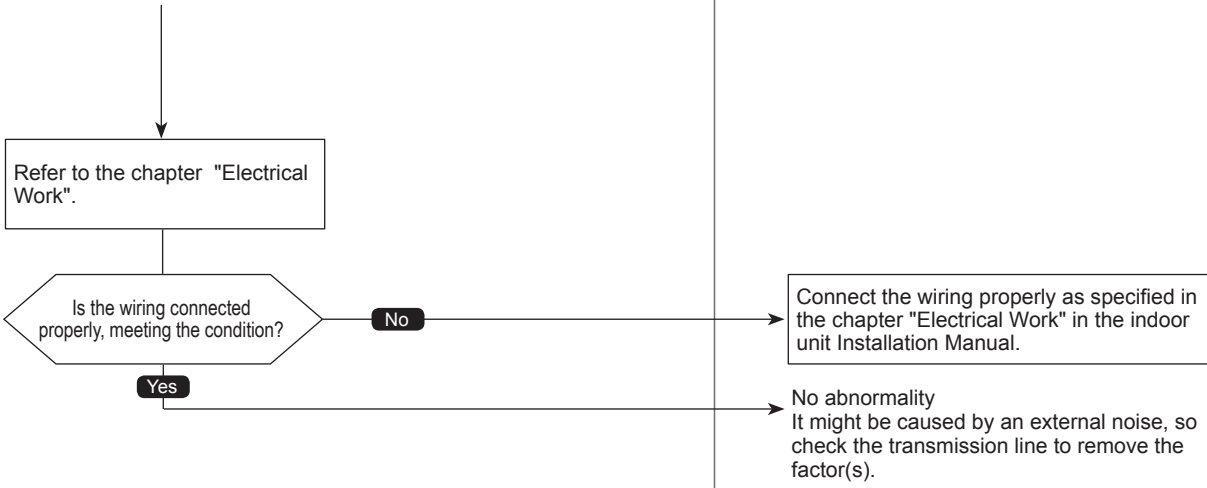
Diagnosis	Remedy
<p>Continued from the previous page</p>  <pre> graph TD Start[Continued from the previous page] --> Step1[Refer to the chapter "Electrical Work".] Step1 --> Decision{Is the wiring connected properly, meeting the condition?} Decision -- No --> Remedy1[Connect the wiring properly as specified in the chapter "Electrical Work" in the indoor unit Installation Manual.] Decision -- Yes --> Remedy2[No abnormality. It might be caused by an external noise, so check the transmission line to remove the factor(s).] </pre>	<p>Connect the wiring properly as specified in the chapter "Electrical Work" in the indoor unit Installation Manual.</p> <p>No abnormality It might be caused by an external noise, so check the transmission line to remove the factor(s).</p>

Check code

7101
(EF)

Capacity code error

Abnormal points and detection methods	Causes and check points
When a connected indoor unit is incompatible, a check code <7101> is displayed.	The model name of connected indoor unit (model code) is read as incompatible. The connectable indoor units are: · SP112 to SP140 model: P15 to P140 model (code 3 to 28) · When connecting via branch box: P15 to P100 model (code 3 to 20)

●Diagnosis of defectives

Make sure to turn the power OFF before connecting/disconnecting any connectors, or replacing boards.

Diagnosis	Remedy
	<p>Set the switch properly.</p> <p>The model code of the connected indoor unit can be displayed by an operation of SW1 on the outdoor unit.</p>

Check code

7102
(EF)

Connecting excessive number of units and branch boxes

Abnormal points and detection methods	Causes and check points
When the connected indoor unit exceeds the limit, a check code <7102> is displayed.	Connecting more indoor units and branch boxes than the limit. Abnormal if connecting status does not comply with the following limit; ① Connectable up to 12 indoor units ② Connect at least 1 indoor unit (Abnormal if connected none). ③ Connectable up to 2 branch boxes

●Diagnosis of defectives

Make sure to turn the power OFF before connecting/disconnecting any connectors, or replacing boards.

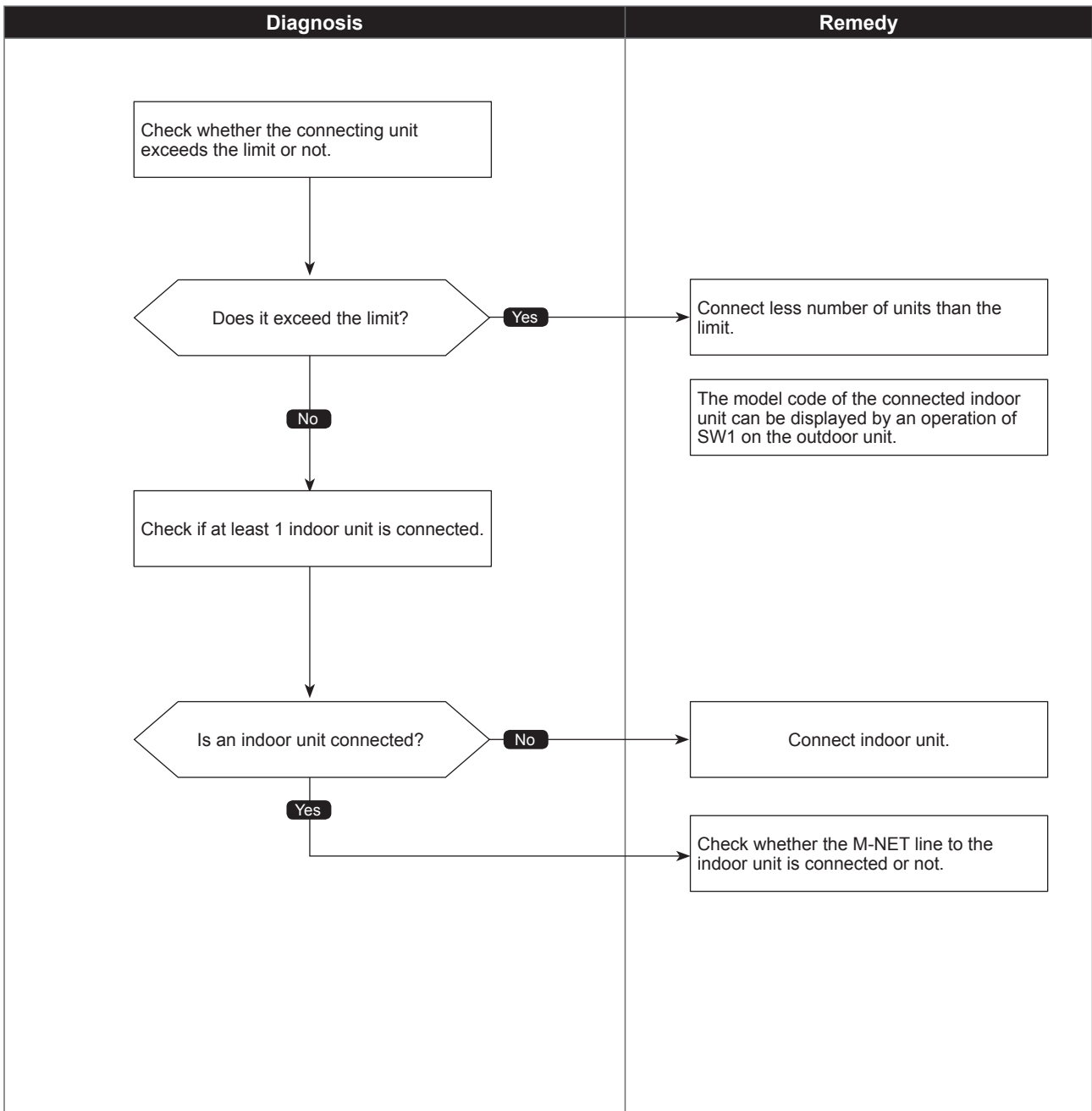

Address setting error

Abnormal points and detection methods	Causes and check points
The address setting of connected unit is wrong.	There is a unit without correct address setting in the range specified in "7-5. SYSTEM CONTROL".

●Diagnosis of defectives

Make sure to turn the power OFF before connecting/disconnecting any connectors, or replacing boards.

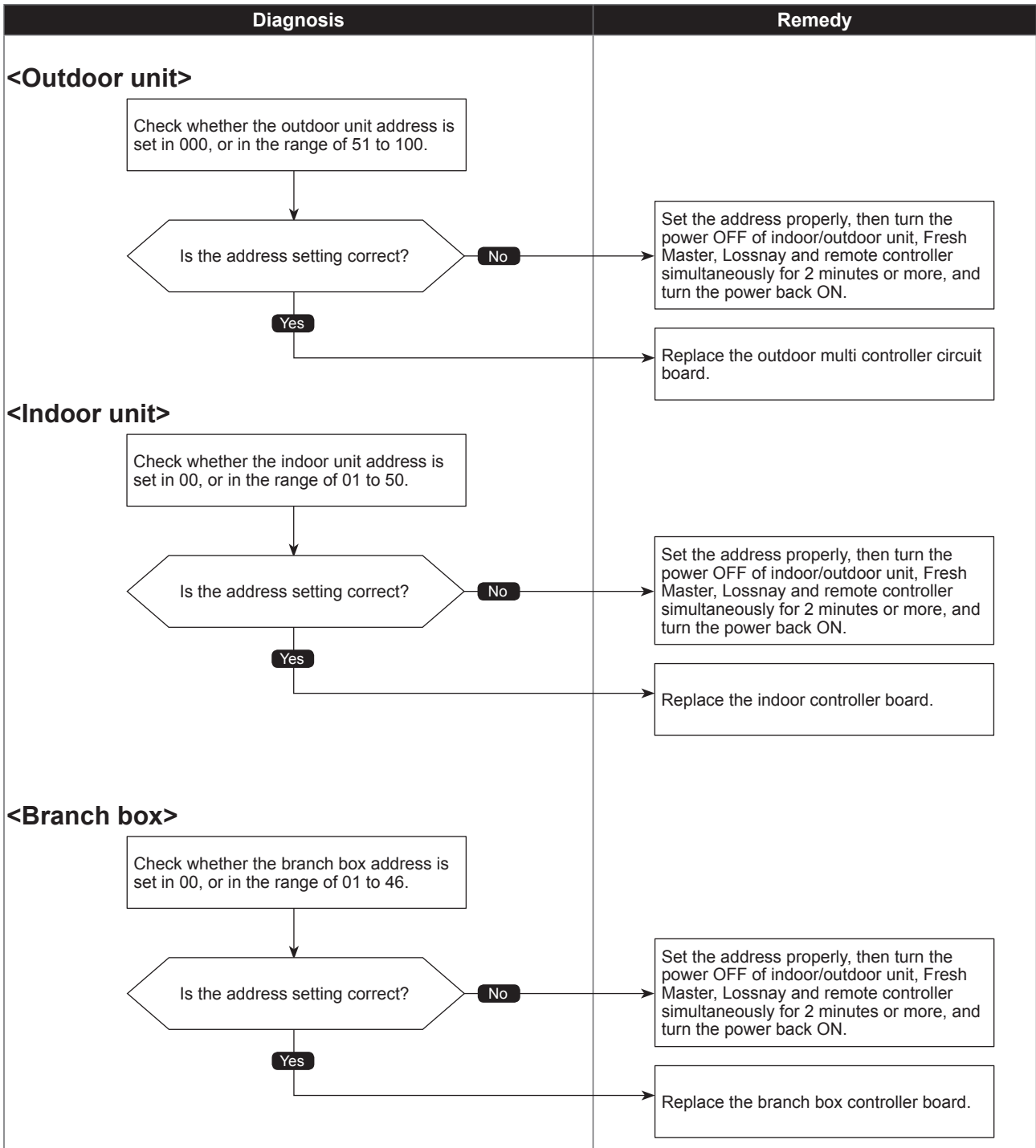

●Diagnosis of defectives

Make sure to turn the power OFF before connecting/disconnecting any connectors, or replacing boards.

Diagnosis	Remedy
<p><M-NET RC (main)></p> <p>Check whether the M-NET RC (main) address is set in 000, or in the range of 101 to 150.</p> <p>Is the address setting correct?</p> <p>Yes</p> <p>No</p>	<p>Set the address properly, then turn the power OFF of indoor/outdoor unit, Fresh Master, Lossnay and remote controller simultaneously for 2 minutes or more, and turn the power back ON.</p> <p>Replace the M-NET RC (main).</p>
<p><M-NET RC (sub)></p> <p>Check whether the M-NET RC (sub) address is set in 000, or in the range of 151 to 200.</p> <p>Is the address setting correct?</p> <p>Yes</p> <p>No</p>	<p>Set the address properly, then turn the power OFF of indoor/outdoor unit, Fresh Master, Lossnay and remote controller simultaneously for 2 minutes or more, and turn the power back ON.</p> <p>Replace the M-NET RC (sub).</p>

Check code

7130
(EF)

Incompatible unit combination error

Abnormal points and detection methods

When the connected indoor unit is not connectable with the outdoor unit, the outdoor unit detects the error at startup.

Causes and check points

Connecting indoor unit(s) which is not authorized to connect to the outdoor unit.

•Diagnosis of defectives

Make sure to turn the power OFF before connecting/disconnecting any connectors, or replacing boards.

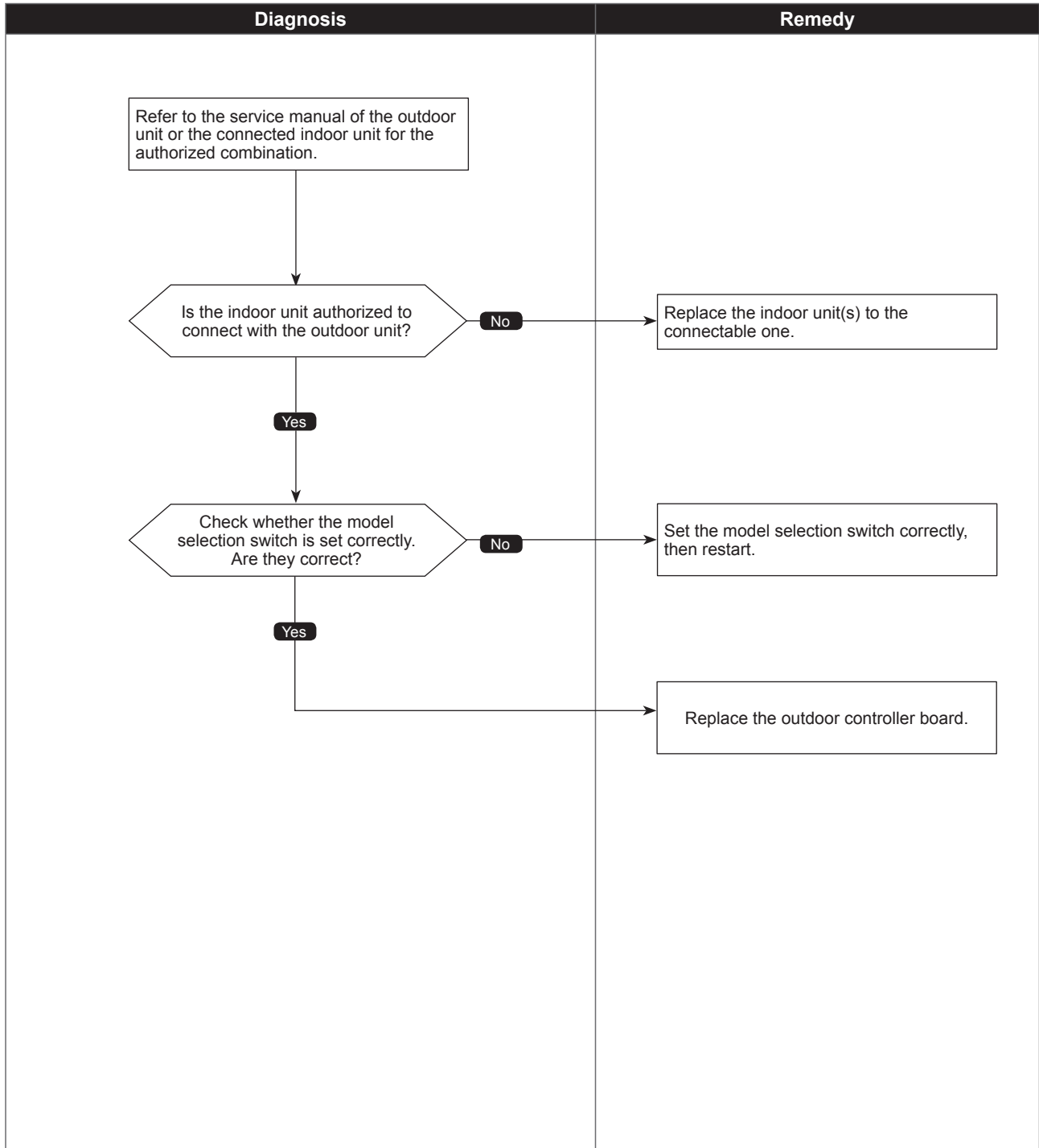

8-2. THE FOLLOWING SYMPTOM DO NOT REPRESENT TROUBLE (EMERGENCY)

Symptom	Display of remote controller	CAUSE
Even the cooling (heating) operation selection button is pressed, the indoor unit cannot be operated.	"Cooling (Heating)" blinks	The indoor unit cannot cool (heat) if other indoor units are heating (Cooling).
The auto vane runs freely.	Normal display	Because of the control operation of auto vane, it may change over to horizontal blow automatically from the downward blow in cooling in cause the downward blow operation has been continued for 1 hour. At defrosting in heating, hot adjusting and thermostat OFF, it automatically changes over to horizontal blow.
Fan setting changes during heating.	Normal display	Ultra-low speed operation is commenced at thermostat OFF. Light air automatically change over to set value by time or piping temperature at thermostat ON.
Fan stops during heating operation.	"Defrost ☆"	The fan is to stop during defrosting.
Fan does not stop while operation has been stopped.	Light out	Fan is to run for 1 minute after stopping to exhaust residual heat (only in heating).
No setting of fan while start SW has been turned on.	STAND BY ☆	Ultra-low speed operation for 5 minutes after SW ON or until piping temperature reach 35°C. There low speed operate for 2 minutes, and then set notch is commenced. (Hot adjust control)
Indoor unit remote controller shows "HO" or "PLEASE WAIT" indicator for about 2 minutes when turning ON power supply.	"HO" blinks "PLEASE WAIT" blinks	System is being driven. Operate remote controller again after "HO" or "PLEASE WAIT" disappears.
Drain pump does not stop while unit has been stopped.	Light out	After a stop of cooling operation, unit continues to operate drain pump for 3 minutes and then stops it.
Drain pump continues to operate while unit has been stopped.	—	Unit continues to operate drain pump if drainage is generated, even during a stop.











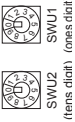
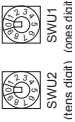









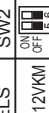

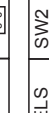





8-3. INTERNAL SWITCH FUNCTION TABLE

PUMY-SP112VKM.TH
 PUMY-SP112YKM.TH
 PUMY-SP112VKM.TH-BS
 PUMY-SP112YKM.TH-BS

PUMY-SP125VKM.TH
 PUMY-SP125YKM.TH
 PUMY-SP125VKM.TH-BS
 PUMY-SP125YKM.TH-BS

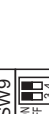
PUMY-SP140VKM.TH
 PUMY-SP140YKM.TH
 PUMY-SP140VKM.TH-BS
 PUMY-SP140YKM.TH-BS

The black square (■) indicates a switch position.

Switch	Step	Function	Operation in Each Switch Setting		Remarks	Purpose	Additional Information
			ON	OFF			
SWU1 ones digit SWU2 tens digit	Rotary switch			Before turning the power ON	<Initial settings> 		
	1-8			Can be set either during operation or not.	<Initial settings> 	To display outdoor unit's information to the LED on outdoor multi controller circuit board. Refer to "8-8. OUTDOOR UNIT INFORMATION DISPLAY".	
SW2 Function Switch	1	Selects operating system startup	With centralized controller	Without centralized controller	<Initial settings> 	Turn ON when the centralized controller is connected to the outdoor unit.	<ul style="list-style-type: none"> SW2-1 must be turned ON if a central controller is connected to the system. An example of this would be a TC-24, EB50A, AG150, AE50 or AE200. If SW2-1 is not turned on, while using a central controller, in rare circumstances problems may be encountered such as indoor units not responding to group commands. Therefore, turning SW2-1 ON is recommended if a central controller is used. Group setting of 2 or more A-IC units which is connected to branch box via centralized controller is not allowed.
		Connection Information Clear Switch	Clear	Do not clear		When relocating units or connecting additional units.	—
	3	Abnormal data clear switch input	Clear abnormal data	Normal	OFF to ON any time after the power is turned on.	To delete an error history.	
	4	Pump down	Run adjustment mode	Normal	During compressor running	To facilitate outdoor unit the pumping down operation. Frequency = Fixed to 65 Hz Indoor-Electronic expansion valve = Fully open Outdoor fan step = Fixed to 10	Please refer to a section referring to the pumping down on outdoor units Installation Manuals. It might not be possible to collect all the refrigerant if the amount is excessive.
	5	—	—	—	—	—	—
	6	—	—	—	—	—	—
SW3 Trial operation	1	ON/OFF from outdoor unit	ON	OFF	<Initial settings> 		
	2	Mode setting	Heating	Cooling			
SW4/ SW8 Model Switch	1-6	MODELS	SW2	SW4	SW8	SW9	
		PUMY-SP112VKM					
		PUMY-SP125VKM					
		PUMY-SP140VKM					
MODELS	SW2	SW4	SW8	SW9			
PUMY-SP112YKM							
PUMY-SP125YKM							
PUMY-SP140YKM							
				Before the power is turned ON.	<Initial settings> Set for each capacity.		

Continue to the next page

The black square (■) indicates a switch position.

Switch	Step	Function	Operation in Each Switch Setting		Remarks	Purpose	Additional Information
			ON	OFF			
SW5 Function switch	1	Demand control setting for Australia	Australia setting	Normal*1	When to Set Can be set when off or during operation	Turn ON to activate the demand control for Australia.	(Do not turn this ON if the unit is in outside Australia)
	2	Change the indoor unit's LEV opening at startup	Enable	Normal	Can be set when OFF or during operation	To set the LEV opening at startup higher than usual. (+150 pulses) To improve the operation with the LEV almost clogged.	The refrigerant flow noise at startup become louder.
	3	—	—	—	—	—	—
	4	—	—	—	—	—	—
	5	Change the indoor unit's LEV opening at defrost	Enable	Normal	Can be set when OFF or during operation	To set the LEV opening higher than usual during defrosting operation. (Only $Q_1 \leq 10$ is valid. + 300 pulses) To avoid the discharge temperature increase and provide efficient defrosting operation.	The refrigerant flow noise during the defrosting operation become louder.
	6	Switching the target sub cool (Heating mode)	Enable	Normal	Can be set when OFF or during operation	To decrease the target sub cool value. To reduce the discharge temperature decrease due to refrigerant liquid accumulation in the units.	A refrigerant flow noise might be generated if the sub cool value is too small.
	7	During the outdoor unit is in HEAT operation, additionally increase about 50 to 70 pulses of the LEV opening on the indoor unit which is in FAN, STOP, COOL or thermo-OFF*2.	Active	Inactive	Can be set when OFF or during operation	To additionally increase about 50 to 70 pulses of the LEV opening for units other than in HEAT operation. To avoid a refrigerant shortage (less capacity) due to refrigerant liquid accumulation in the units which is not in operation.	A refrigerant flow noise might be generated in units other than the one in operation.
	8	During the outdoor unit is in operation, fully closes the electronic expansion valve on the indoor unit which is in FAN, COOL, STOP, or thermo-OFF*3.	Enable	Normal	Before turning the power ON.	To reduce the room temperature increase by setting the LEV opening lower for the units in thermo-OFF operation.	The refrigerant is more likely to collect in the units with thermo-OFF operation, and causing the units refrigerant shortage. (Results in less capacity and increase of discharge temperature.)
SW6 function switch	1	—	—	—	—	—	—
	2	—	—	—	—	—	—
	3	—	—	—	—	—	—
	4	Change of defrosting control	Enable (For high humidity)	Normal	—	To shorten the defrosting prohibition time in high humidity (or heavy snow) region, in order to reduce malfunctions caused by frost.	The performance of the HEAT operation is somewhat reduced since the defrosting operation is frequently performed.
	5	External static pressure mode	Enable	Normal	—	To raise the fan rotation to raise the performance when an external static pressure is applied.	It can support the external static pressure up to 30 Pa. The power input and the sound level become larger due to increasing the outdoor unit's fan rotation.
	6	Switching the target discharge pressure (PdM)	Enable	Normal	Can be set when OFF or during operation	To raise the performance by setting the PdM higher during HEAT operation.	Power consumption is raised due to a higher frequency. (The performance would not be raised at the maximum operating frequency.) SW6-6 <input type="checkbox"/> OFF <input type="checkbox"/> ON Target PdM (kg/cm ²) 29.5 31.5
	7	Switching (1) the target evaporation temperature (ETm)	Enable	Normal	—	To raise/reduce the performance by changing the target ETm during COOL operation. Switch to raise the performance: raises the performance Switch to reduce the performance: prevents dew condensation	Switching it to raise the performance, it raises the power consumption, and produces more dew condensation. Switching it to reduce the performance, it makes the performance insufficient. SW6-7 <input type="checkbox"/> OFF <input type="checkbox"/> ON <input type="checkbox"/> ON <input type="checkbox"/> ON SW6-8 <input type="checkbox"/> OFF <input type="checkbox"/> ON <input type="checkbox"/> OFF <input type="checkbox"/> ON Target ETm (°C) 9 11 6 5 Note: The target ETm varies according to an intake temperature.
	8	Switching (2) the target evaporation temperature (ETm)	Enable	Normal	—	—	—

*1 Refer to "8-4. OUTDOOR UNIT INPUT/OUTPUT CONNECTOR".





*2 SW5-7 Opens the indoor-electronic expansion valve as a countermeasure against the indoor unit in FAN, COOL, STOP, or thermo-OFF operation with refrigerant-shortage status due to an accumulation of liquid refrigerant in the indoor unit.

*3 SW5-8 Countermeasure against room temperature rise for indoor unit in FAN, COOL, and thermo-OFF (heating) mode.

*4 During heating operation and the ambient temperature is 4°C (39°F) or below, the freeze prevention heater is energized.

*5 During heating mode is OFF (include thermo-OFF in cooling mode), and the ambient temperature is 4°C (39°F) or below, the freeze prevention heater is energized.

Continue to the next page

Switch	Step	Function	Operation in Each Switch Setting			Remarks	Purpose	Additional Information	
			ON	OFF	When to Set				
SW7 function switch	1	Ignore current sensor abnormality and rotational frequency abnormality of outdoor fan motor	Enable	Normal	After turning the power ON*6	<Initial settings> 	To perform a test run for electrical parts alone without running the compressor. Also, to perform the troubleshooting of electrical parts without operating the outdoor unit's fan.	Make sure to connect the connectors to the compressor after checking the electrical parts. Be careful not to get electrical shock while working on electrical parts.	
	2	Setting to energize the freeze stat heater (optional part)	During heating operation only*4	Include when the heating operation is OFF.*5	Can be set when OFF or during operation.	ON OFF 	It reduces snow on the base, even it blows inside the unit, by setting the base heater ON while the HEAT operation is stopped.	Power consumption raises while the operation is stopped.	
	3	—	—	—	—	—	—	—	—
	4	Maximum frequency down at 1 hour after COOL operation	Enable	Normal	Can be set when OFF or during operation.	—	To reduce dew condensation on the indoor unit by lowering the frequency.	The performance might be insufficient.	—
	5	—	—	—	—	—	—	—	—
	6	Manual defrost	Manual defrost	Normal	During compressor running in HEAT mode.	—	Turn ON when it is necessary to perform the defrosting operation forcibly. (Effective only at startup, or 10 minutes after the last defrosting operation)	It performs the defrosting operation forcibly. (HEAT operation is stopped temporarily)	—
SW9 Function Switch	1	Auto change over from remote controller (IC with the minimum address)	Enable	Disable	Before turning the power ON	<Initial settings> 	Enables the indoor unit with the minimum address to select AUTO mode, and switches the operation mode of the other indoor units to the same mode.	Cannot be set when the centralized control is ON.	
	2	Switching the Silent/Demand mode	Demand control	Silent mode	Can be set when OFF or during operation	ON OFF 	—	About the Silent mode/Demand control setting, refer to "8-4. OUTDOOR UNIT INPUT/OUTPUT CONNECTOR".	
	3	—	—	—	—	—	—	—	
	4	—	—	—	—	—	—	—	

*4 During heating operation and the ambient temperature is 4°C (39°F) or below, the freeze prevention heater is energized.

*5 During heating mode is OFF (include thermo-OFF in cooling mode), and the ambient temperature is 4°C (39°F) or below, the freeze prevention heater is energized.

*6 Make sure to wait for 5 minutes after turning the breaker ON.

8-4. OUTDOOR UNIT INPUT/OUTPUT CONNECTOR

• State (CN51)

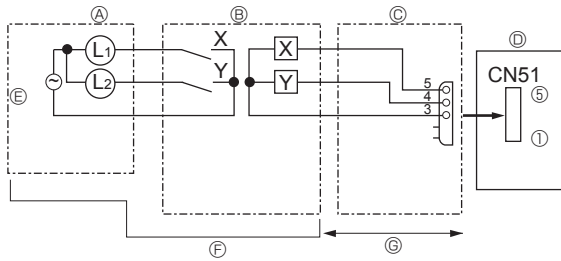

- Ⓐ Distant control board
- Ⓑ Relay circuit
- Ⓒ External output adapter (PAC-SA88HA-E)
- Ⓓ Outdoor unit control board
- Ⓔ Lamp power supply
- Ⓕ Procure locally
- Ⓖ Max. 10m

L1: Error display lamp
 L2: Compressor operation lamp
 X, Y: Relay (Coil standard of 0.9W or less for 12 V DC)
 X, Y: Relay (1 mA DC)

• Auto change over (CN3N)

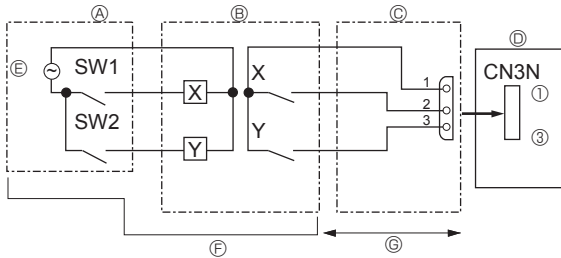

- Ⓐ Remote control panel
- Ⓑ Relay circuit
- Ⓒ External input adapter (PAC-SC36NA-E)
- Ⓓ Outdoor unit control board
- Ⓔ Relay power supply
- Ⓕ Procure locally
- Ⓖ Max. 10 m

	ON	OFF
SW1	Heating	Cooling
SW2	Validity of SW1	Invalidity of SW1

• Silent Mode/Demand Control (CN3D)

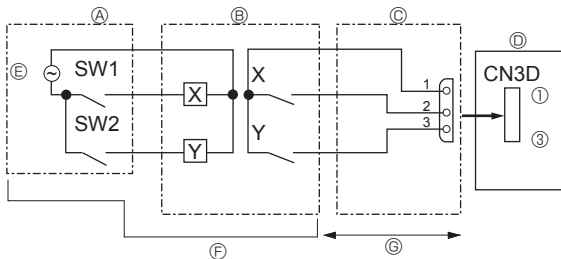

- Ⓐ Remote control panel
- Ⓑ Relay circuit
- Ⓒ External input adapter (PAC-SC36NA-E)
- Ⓓ Outdoor unit control board
- Ⓔ Relay power supply
- Ⓕ Procure locally
- Ⓖ Max. 10 m

The silent mode and the demand control are selected by switching the DIP switch 9-2 on outdoor controller board. It is possible to set it to the following power consumption (compared with ratings) by setting SW1, 2.

	Outdoor controller board DIP SW9-2	SW1	SW2	Function
Silent mode (Cooling only)	OFF	OFF	OFF	Normal
		ON	OFF	Silent mode
		OFF	ON	Super silent mode 1
		ON	ON	Super silent mode 2
Demand control	ON	OFF	OFF	100% (Normal)
		ON	OFF	75%
		ON	ON	50%
		OFF	ON	0% (Stop)

8-5. HOW TO CHECK THE PARTS

PUMY-SP112VKM.TH

PUMY-SP125VKM.TH

PUMY-SP140VKM.TH

PUMY-SP112YKM.TH

PUMY-SP125YKM.TH

PUMY-SP140YKM.TH

PUMY-SP112VKM.TH-BS

PUMY-SP125VKM.TH-BS

PUMY-SP140VKM.TH-BS

PUMY-SP112YKM.TH-BS

PUMY-SP125YKM.TH-BS

PUMY-SP140YKM.TH-BS

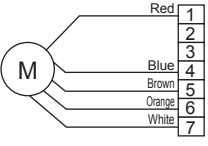
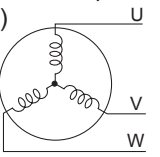
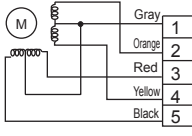
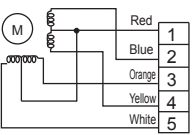
Parts name	Check points														
Thermistor (TH2) <HIC pipe> Thermistor (TH3) <Outdoor liquid pipe> Thermistor (TH4) <Compressor> Thermistor (TH6) <Suction pipe> Thermistor (TH7) <Ambient> Thermistor (TH8) <Heat sink>	Disconnect the connector then measure the resistance with a tester. (At the ambient temperature 10 to 30°C) <table border="1" style="margin-top: 10px;"> <thead> <tr> <th></th> <th>Normal</th> <th>Abnormal</th> </tr> </thead> <tbody> <tr> <td>TH4</td> <td>160 to 410 kΩ</td> <td rowspan="4">Open or short</td> </tr> <tr> <td>TH2 TH3 TH6 TH7</td> <td>4.3 to 9.6 kΩ</td> </tr> <tr> <td>TH8*</td> <td>39 to 105 kΩ</td> </tr> </tbody> </table> <p style="text-align: right; margin-top: 10px;">* TH8 is internal thermistor of power module. (Y)</p>		Normal	Abnormal	TH4	160 to 410 kΩ	Open or short	TH2 TH3 TH6 TH7	4.3 to 9.6 kΩ	TH8*	39 to 105 kΩ				
	Normal	Abnormal													
TH4	160 to 410 kΩ	Open or short													
TH2 TH3 TH6 TH7	4.3 to 9.6 kΩ														
TH8*	39 to 105 kΩ														
Fan motor (MF1) 	Measure the resistance between the connector pins with a tester. (At the ambient temperature 20°C) <table border="1" style="margin-top: 10px;"> <thead> <tr> <th colspan="4">Normal</th> <th>Abnormal</th> </tr> </thead> <tbody> <tr> <td>Red - Blue</td> <td>Brown - Blue</td> <td>Orange - Blue</td> <td>White - Blue</td> <td rowspan="2">Open or short (Short, for White - Blue)</td> </tr> <tr> <td>1.1 ± 0.05 MΩ</td> <td>40 ± 4 kΩ</td> <td>220 ± 22 kΩ</td> <td>Open</td> </tr> </tbody> </table>		Normal				Abnormal	Red - Blue	Brown - Blue	Orange - Blue	White - Blue	Open or short (Short, for White - Blue)	1.1 ± 0.05 MΩ	40 ± 4 kΩ	220 ± 22 kΩ
Normal				Abnormal											
Red - Blue	Brown - Blue	Orange - Blue	White - Blue	Open or short (Short, for White - Blue)											
1.1 ± 0.05 MΩ	40 ± 4 kΩ	220 ± 22 kΩ	Open												
Solenoid valve coil <4-way valve> (21S4)	Measure the resistance between the terminals with a tester. (At the ambient temperature 20°C) <table border="1" style="margin-top: 10px;"> <thead> <tr> <th>Normal</th> <th>Abnormal</th> </tr> </thead> <tbody> <tr> <td>1725 ± 172.5 Ω</td> <td>Open or short</td> </tr> </tbody> </table>	Normal	Abnormal	1725 ± 172.5 Ω	Open or short										
Normal	Abnormal														
1725 ± 172.5 Ω	Open or short														
Motor for compressor (MC) 	Measure the resistance between the terminals with a tester. (Winding temperature 20°C) <table border="1" style="margin-top: 10px;"> <thead> <tr> <th colspan="2">Normal</th> <th rowspan="2">Abnormal</th> </tr> </thead> <tbody> <tr> <td>PUMY-SP•VKM</td> <td>PUMY-SP•YKM</td> </tr> <tr> <td>0.015 Ω</td> <td>0.466 Ω</td> <td>Open or short</td> </tr> </tbody> </table>	Normal		Abnormal	PUMY-SP•VKM	PUMY-SP•YKM	0.015 Ω	0.466 Ω	Open or short						
Normal		Abnormal													
PUMY-SP•VKM	PUMY-SP•YKM														
0.015 Ω	0.466 Ω	Open or short													
Solenoid valve coil <Bypass valve> (SV1)	Measure the resistance between the terminals with a tester. (At the ambient temperature 20°C) <table border="1" style="margin-top: 10px;"> <thead> <tr> <th>Normal</th> <th>Abnormal</th> </tr> </thead> <tbody> <tr> <td>1182.5 ± 83 Ω</td> <td>Open or short</td> </tr> </tbody> </table>	Normal	Abnormal	1182.5 ± 83 Ω	Open or short										
Normal	Abnormal														
1182.5 ± 83 Ω	Open or short														
Linear expansion Valve (LEV-A) 	<table border="1" style="margin-top: 10px;"> <thead> <tr> <th colspan="4">Normal</th> <th>Abnormal</th> </tr> </thead> <tbody> <tr> <td>Gray - Black</td> <td>Gray - Red</td> <td>Gray - Yellow</td> <td>Gray - Orange</td> <td rowspan="2">Open or short</td> </tr> <tr> <td colspan="4" style="text-align: center;">46 ± 3 Ω</td> </tr> </tbody> </table>	Normal				Abnormal	Gray - Black	Gray - Red	Gray - Yellow	Gray - Orange	Open or short	46 ± 3 Ω			
Normal				Abnormal											
Gray - Black	Gray - Red	Gray - Yellow	Gray - Orange	Open or short											
46 ± 3 Ω															
Linear expansion Valve (LEV-B) 	<table border="1" style="margin-top: 10px;"> <thead> <tr> <th colspan="4">Normal</th> <th>Abnormal</th> </tr> </thead> <tbody> <tr> <td>Red - White</td> <td>Red - Orange</td> <td>Red - Yellow</td> <td>Red - Blue</td> <td rowspan="2">Open or short</td> </tr> <tr> <td colspan="4" style="text-align: center;">46 ± 4 Ω</td> </tr> </tbody> </table>	Normal				Abnormal	Red - White	Red - Orange	Red - Yellow	Red - Blue	Open or short	46 ± 4 Ω			
Normal				Abnormal											
Red - White	Red - Orange	Red - Yellow	Red - Blue	Open or short											
46 ± 4 Ω															

Check method of DC fan motor (fan motor/outdoor multi controller circuit board)

① Notes

- High voltage is applied to the connector (CNF1) for the fan motor. Pay attention to the service.
- Do not pull out the connector (CNF1) for the motor with the power supply on.
(It causes trouble of the outdoor multi controller circuit board and fan motor.)

② Self check

Symptom : The outdoor fan cannot rotate.

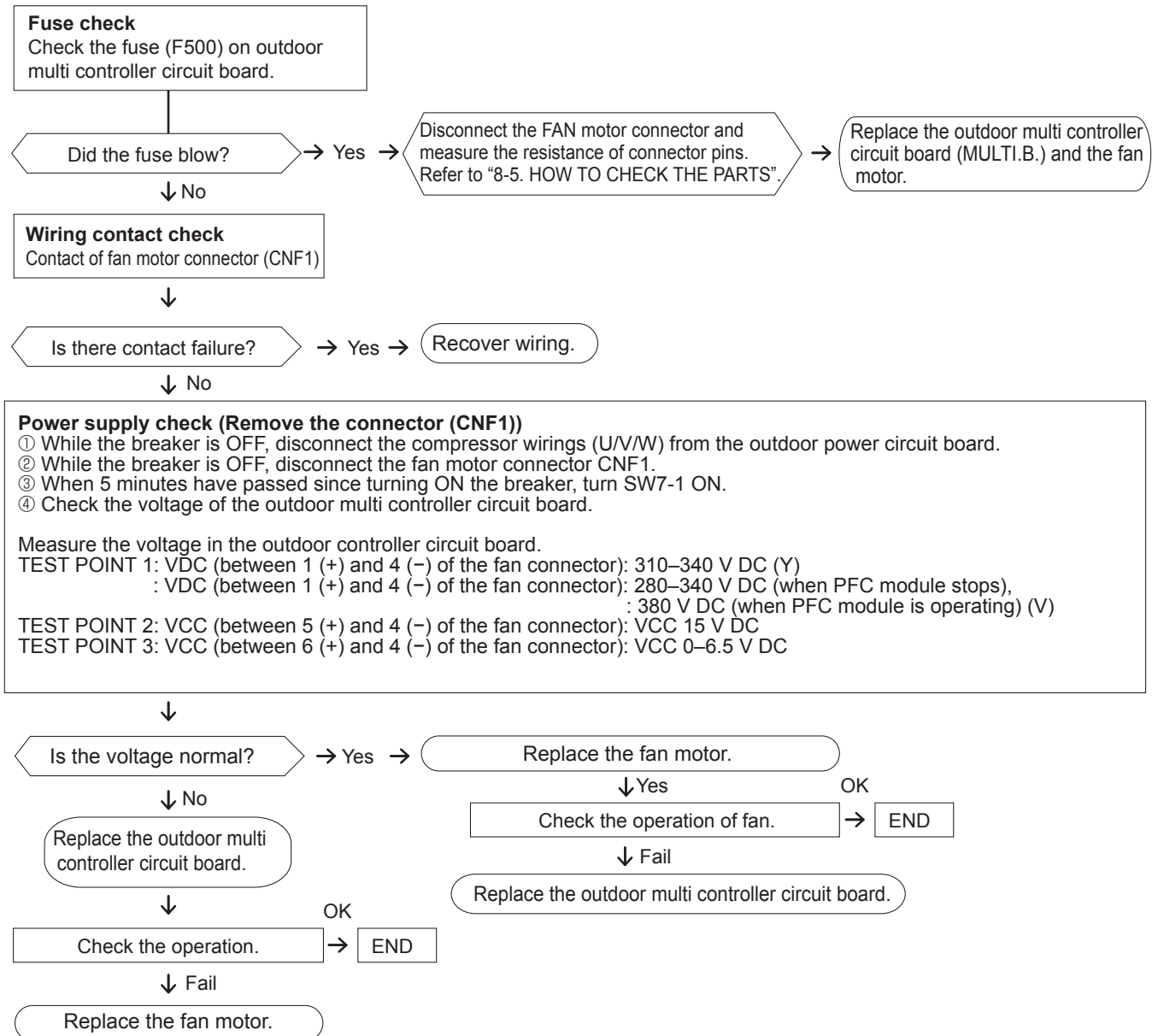

Note:

- Turn SW7-1 OFF after the troubleshooting completes.
- The fan sometimes starts on-off cycle operation during low-load operation or cooling at low outside temperature. It is not abnormal; the operation ensures reliability of the product.

8-6. HOW TO CHECK THE COMPONENTS

<Thermistor feature chart>

Low temperature thermistors

- Thermistor <HIC pipe> (TH2)
- Thermistor <Outdoor liquid pipe> (TH3)
- Thermistor <Suction pipe> (TH6)
- Thermistor <Ambient> (TH7)

Thermistor R0 = 15 kΩ ± 3 %

B constant = 3480 ± 2 %

$$R_t = 15 \exp\left\{3480 \left(\frac{1}{273+t} - \frac{1}{273} \right)\right\}$$

0°C	15 kΩ	30°C	4.3 kΩ
10°C	9.6 kΩ	40°C	3.0 kΩ
20°C	6.3 kΩ		
25°C	5.2 kΩ		

Medium temperature thermistor

- Thermistor <Heat sink> (TH8)

Thermistor R50 = 17 kΩ ± 2 %

B constant = 4170 ± 3 %

$$R_t = 17 \exp\left\{4170 \left(\frac{1}{273+t} - \frac{1}{323} \right)\right\}$$

0°C	180 kΩ
25°C	50 kΩ
50°C	17 kΩ
70°C	8 kΩ
90°C	4 kΩ

High temperature thermistor

- Thermistor <Compressor> (TH4)

Thermistor R120 = 7.465 kΩ ± 2 %

B constant = 4057 ± 2 %

$$R_t = 7.465 \exp\left\{4057 \left(\frac{1}{273+t} - \frac{1}{393} \right)\right\}$$

20°C	250 kΩ	70°C	34 kΩ
30°C	160 kΩ	80°C	24 kΩ
40°C	104 kΩ	90°C	17.5 kΩ
50°C	70 kΩ	100°C	13.0 kΩ
60°C	48 kΩ	110°C	9.8 kΩ

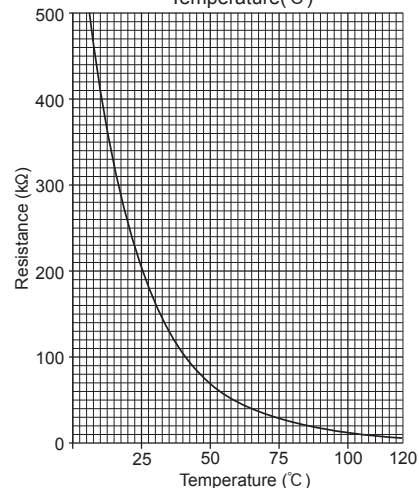
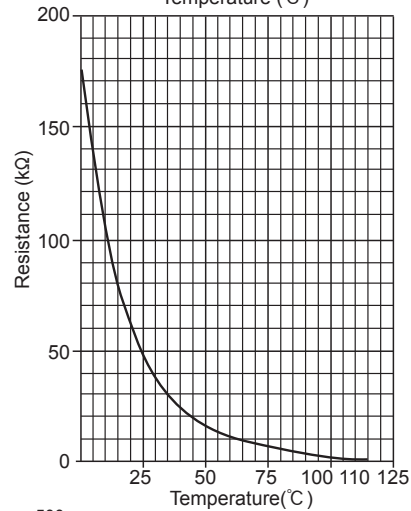
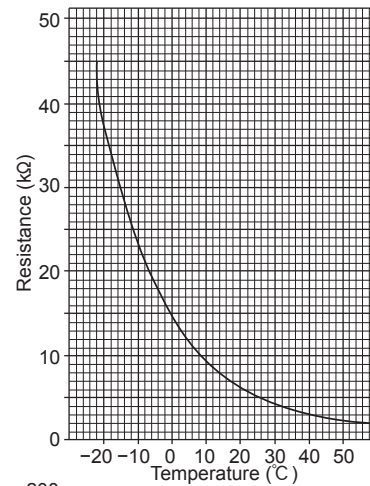

<HIGH PRESSURE SENSOR>

• Comparing the High Pressure Sensor Measurement and Gauge Pressure

By configuring the digital display setting switch (SW1) as shown in the figure below, the pressure as measured by the high pressure sensor appears on the LED1 on the control board.



The figure at left shows that the switches 1 through 4 are set to ON and 5 through 8 are set to OFF.

(1) While the outdoor unit is stopped, compare the gauge pressure and the pressure displayed on self-diagnosis LED1, 2.

- 1) When the gauge pressure is between 0 and 0.098 MPaG [14 PSIG], internal pressure is caused due to gas leak.
- 2) When the pressure displayed on self-diagnosis LED1, 2 is between 0.098 MPaG [14 PSIG], the connector may be defective or be disconnected. Check the connector and go to (4).
- 3) When the pressure displayed on self-diagnosis LED1, 2 exceeds 5.0 MPaG [725 PSIG], go to (3).
- 4) If other than 1), 2) or 3), compare the pressures while the sensor is running. Go to (2).

(2) Compare the gauge pressure and the pressure displayed on self-diagnosis LED1,2 after 15 minutes have passed since the start of operation. (Compare them by MPaG [PSIG] unit.)

- 1) When the difference between both pressures is within 0.25 MPaG [36 PSIG], both the high pressure sensor and the control board are normal.
- 2) When the difference between both pressures exceeds 0.25 MPaG [36 PSIG], the high pressure sensor has a problem. (performance deterioration)
- 3) When the pressure displayed on self-diagnosis LED1, 2 does not change, the high pressure sensor has a problem.

(3) Remove the high pressure sensor from the control board to check the pressure on the self-diagnosis LED1, 2.

- 1) When the pressure displayed on self-diagnosis LED1, 2 is between 0 and 0.098 MPaG [14 PSIG], the high pressure sensor has a problem.
- 2) When the pressure displayed on self-diagnosis LED1, 2 is approximately 5.0 MPaG [725 PSIG], the control board has a problem.

(4) Remove the high pressure sensor from the control board, and short-circuit between the pin 2 and pin 3 connectors (63HS) to check the pressure with self-diagnosis LED1, 2.

- 1) When the pressure displayed on the self-diagnosis LED1, 2 exceeds 5.0 MPaG [725 PSIG], the high pressure sensor has a problem.
- 2) If other than 1), the control board has a problem.

• High Pressure Sensor Configuration (63HS)

The high pressure sensor consists of the circuit shown in the figure below. If 5 V DC is applied between the white and the black wires, voltage corresponding to the pressure between the blue and the black wires will be output, and the value of this voltage will be converted by the microcomputer. The output voltage is 0.078 V per 0.098 MPaG [14 PSIG].

Note:

The pressure sensor on the body side is designed to connect to the connector. The connector pin number on the body side is different from that on the control board side.

	Body side	Control board side
Vcc	Pin 1	Pin 3
Vout	Pin 2	Pin 2
GND	Pin 3	Pin 1

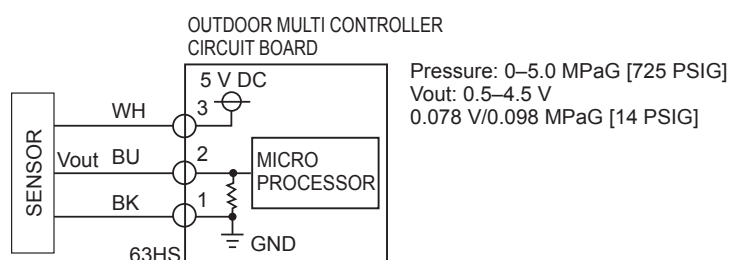

③-①: 5 V (DC)

②-①: Output Vout (DC)

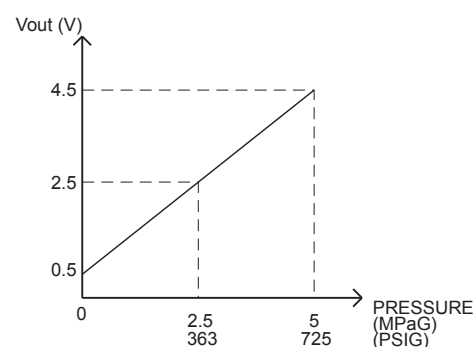

<LOW PRESSURE SENSOR>

• Comparing the Low Pressure Sensor Measurement and Gauge Pressure

By configuring the digital display setting switch (SW1) as shown in the figure below, the pressure as measured by the low pressure sensor appears on the LED1 on the control board.

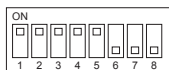
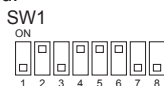

The figure at left shows that the switches 1 through 4 are set to ON and 5 through 8 are set to OFF.

(1) While the outdoor unit is stopped, compare the gauge pressure and the pressure displayed on self-diagnosis LED1, 2.

- 1) When the gauge pressure is between 0 and 0.098 MPaG [14 PSIG], internal pressure is caused due to gas leak.
- 2) When the pressure displayed on self-diagnosis LED1, 2 is between 0 and 0.098 MPaG [14 PSIG], the connector may be defective or be disconnected. Check the connector and go to (4).
- 3) When the outdoor temperature is 30°C [86°F] or less, and the pressure displayed on self-diagnosis LED1, 2 exceeds 1.7 MPaG [247 PSIG], go to (3).
When the outdoor temperature exceeds 30°C [86°F], and the pressure displayed on self-diagnosis LED1, 2 exceeds 1.7 MPaG [247 PSIG], go to (5).
- 4) If other than 1), 2) or 3), compare the pressures while the sensor is running. Go to (2).

(2) Compare the gauge pressure and the pressure displayed on self-diagnosis LED1, 2 after 15 minutes have passed since the start of operation. (Compare them by MPaG [PSIG] unit.)

- 1) When the difference between both pressures is within 0.2 MPaG [29 PSIG], both the low pressure sensor and the control board are normal.
- 2) When the difference between both pressures exceeds 0.2 MPaG [29 PSIG], the low pressure sensor has a problem. (performance deterioration)
- 3) When the pressure displayed on the self-diagnosis LED1, 2 does not change, the low pressure sensor has a problem.

(3) Remove the low pressure sensor from the control board to check the pressure with the self-diagnosis LED1, 2 display.

- 1) When the pressure displayed on the self-diagnosis LED1,2 is between 0 and 0.098 MPaG [14 PSIG], the low pressure sensor has a problem.
- 2) When the pressure displayed on self-diagnosis LED1, 2 is approximately 1.7 MPaG [247 PSIG], the control board has a problem.

(4) Remove the low pressure sensor from the control board, and short-circuit between the pin 2 and pin 3 connectors (63LS) to check the pressure with the self-diagnosis LED1, 2.

- 1) When the pressure displayed on the self-diagnosis LED1, 2 exceeds 1.7 MPaG [247 PSIG], the low pressure sensor has a problem.
- 2) If other than 1), the control board has a problem.

(5) Remove the high pressure sensor (63HS) from the control board, and insert it into the connector for the low pressure sensor (63LS) to check the pressure with the self-diagnosis LED1, 2.

- 1) When the pressure displayed on the self-diagnosis LED1, 2 exceeds 1.7 MPaG [247 PSIG], the control board has a problem.
- 2) If other than 1), go to (2).

• Low Pressure Sensor Configuration (63LS)

The low pressure sensor consists of the circuit shown in the figure below. If 5 V DC is applied between the red and the black wires, voltage corresponding to the pressure between the white and the black wires will be output, and the value of this voltage will be converted by the microcomputer. The output voltage is 0.173 V per 0.098 MPaG [14 PSIG].

Note:

The pressure sensor on the body side is designed to connect to the connector. The connector pin number on the body side is different from that on the control board side.

	Body side	Control board side
Vcc	Pin 1	Pin 3
Vout	Pin 2	Pin 2
GND	Pin 3	Pin 1

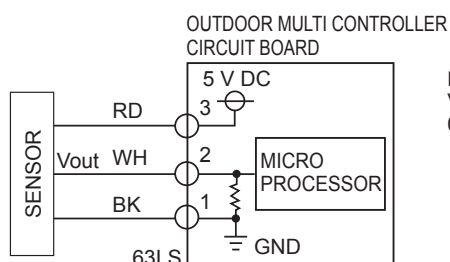

- ③—① : 5 V (DC)
②—① : Output Vout (DC)

Pressure: 0–1.7 MPaG [247 PSIG]
Vout: 0.5–3.5 V
0.173 V/0.098 MPaG [14 PSIG]

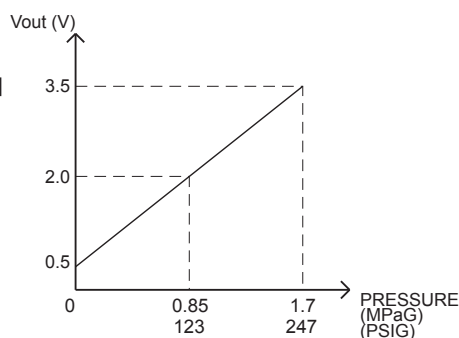

8-7. TEST POINT DIAGRAM

Outdoor multi controller circuit board

PUMY-SP112VKM.TH	PUMY-SP125VKM.TH	PUMY-SP140VKM.TH
PUMY-SP112YKM.TH	PUMY-SP125YKM.TH	PUMY-SP140YKM.TH
PUMY-SP112VKM.TH-BS	PUMY-SP125VKM.TH-BS	PUMY-SP140VKM.TH-BS
PUMY-SP112YKM.TH-BS	PUMY-SP125YKM.TH-BS	PUMY-SP140YKM.TH-BS

<CAUTION> TEST POINT ① is high voltage.

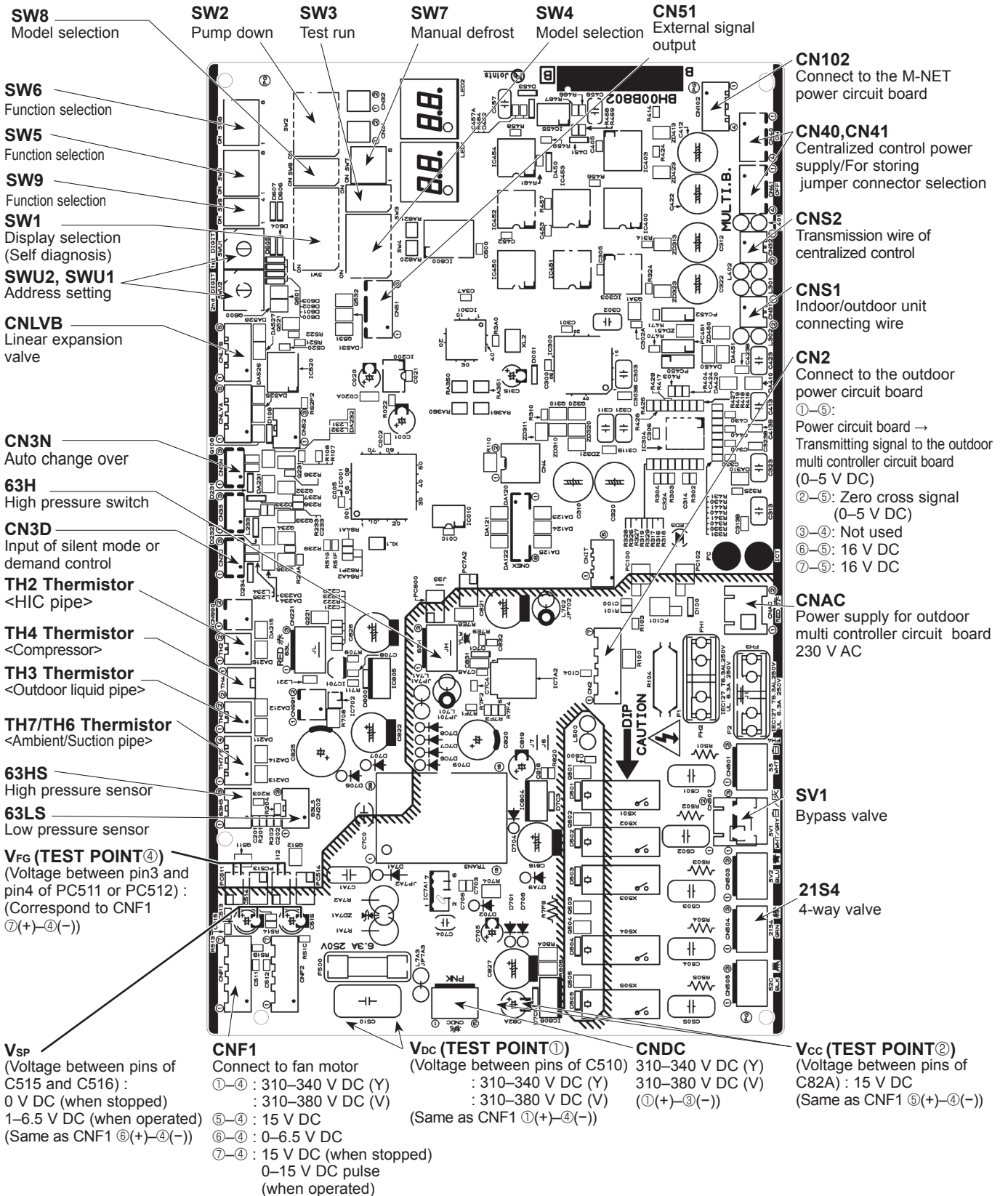

Outdoor power circuit board

PUMY-SP112VKM.TH

PUMY-SP125VKM.TH

PUMY-SP140VKM.TH

PUMY-SP112VKM.TH-BS

PUMY-SP125VKM.TH-BS

PUMY-SP140VKM.TH-BS

Brief Check of POWER MODULE

Usually, they are in a state of being short-circuited if they are broken. Measure the resistance in the following points (connectors, etc.). If they are short-circuited, it means that they are broken.

1. Check of POWER MODULE

① Check of DIODE circuit

R-P1 **S**-P1 **R**-N1 **S**-N1

② Check of IGBT circuit

P2-L1, **P2**-L2, **P2**-L3, **N2**-L1, **N2**-L2, **N2**-L3

③ Check of INVERTER circuit

P3-U, **P3**-V, **P3**-W, **N3**-U, **N3**-V, **N3**-W

Note: The marks **R**, **S**, **L1**, **L2**, **L3**, **P1**, **P2**, **P3**, **N1**, **N2**, **N3**, **U**, **V** and **W** shown in the diagram are not actually printed on the board.

CN2

Connect to the outdoor controller circuit board (CN2)

①-⑤: Transmitting signal to outdoor controller circuit board (0-5 V DC)

②-⑤: Zero cross signal (0-5 V DC)

③-④: 16 V DC

⑥-⑥: 16 V DC

⑦-⑥: 16 V DC

CN6
Thermistor

CN4
Connect to the outdoor controller circuit board (CN4)

U/V/W
Connect to the compressor (MC)
Voltage among phases: 10-180V AC

CNAC1
230 V AC
Connect to the M-NET power circuit board (CN1)
CNAC2
230 V AC
Connect to the outdoor multi controller circuit board (CNAC)

NI, LI
Voltage of 230 V AC is input (Connect to the terminal block (TB1))

TB1A, TB2A, TB3A,
TB1B, TB2B, TB3B
Connect to DCL

CNDC
280-380 V DC (①+, ③-)
Connect to the outdoor controller circuit board (CNDC)

E1, E3, E4
Connect to the electrical parts box

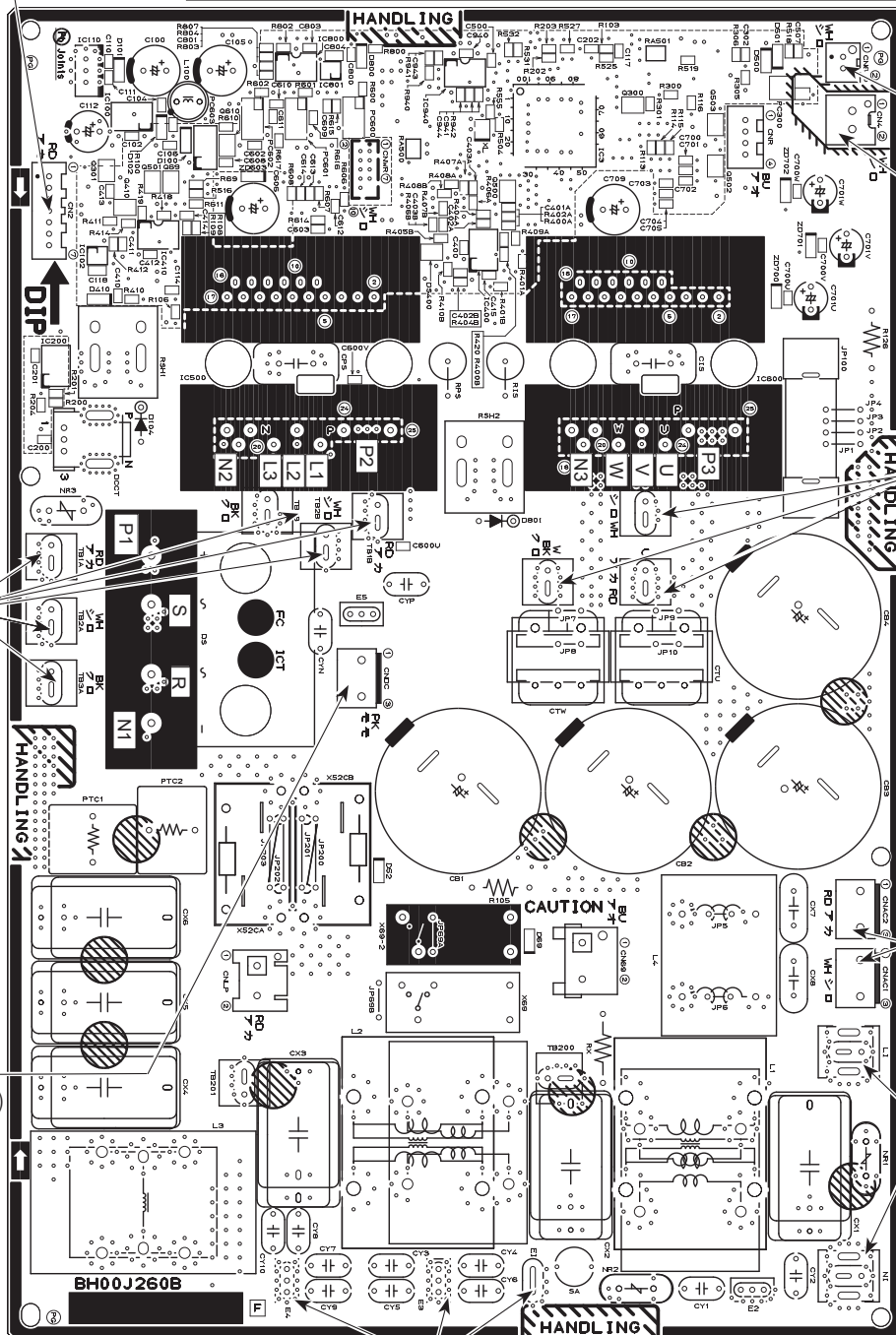

M-NET power circuit board

PUMY-SP112VKM.TH
 PUMY-SP112YKM.TH
 PUMY-SP112VKM.TH-BS
 PUMY-SP112YKM.TH-BS

PUMY-SP125VKM.TH
 PUMY-SP125YKM.TH
 PUMY-SP125VKM.TH-BS
 PUMY-SP125YKM.TH-BS

PUMY-SP140VKM.TH
 PUMY-SP140YKM.TH
 PUMY-SP140VKM.TH-BS
 PUMY-SP140YKM.TH-BS

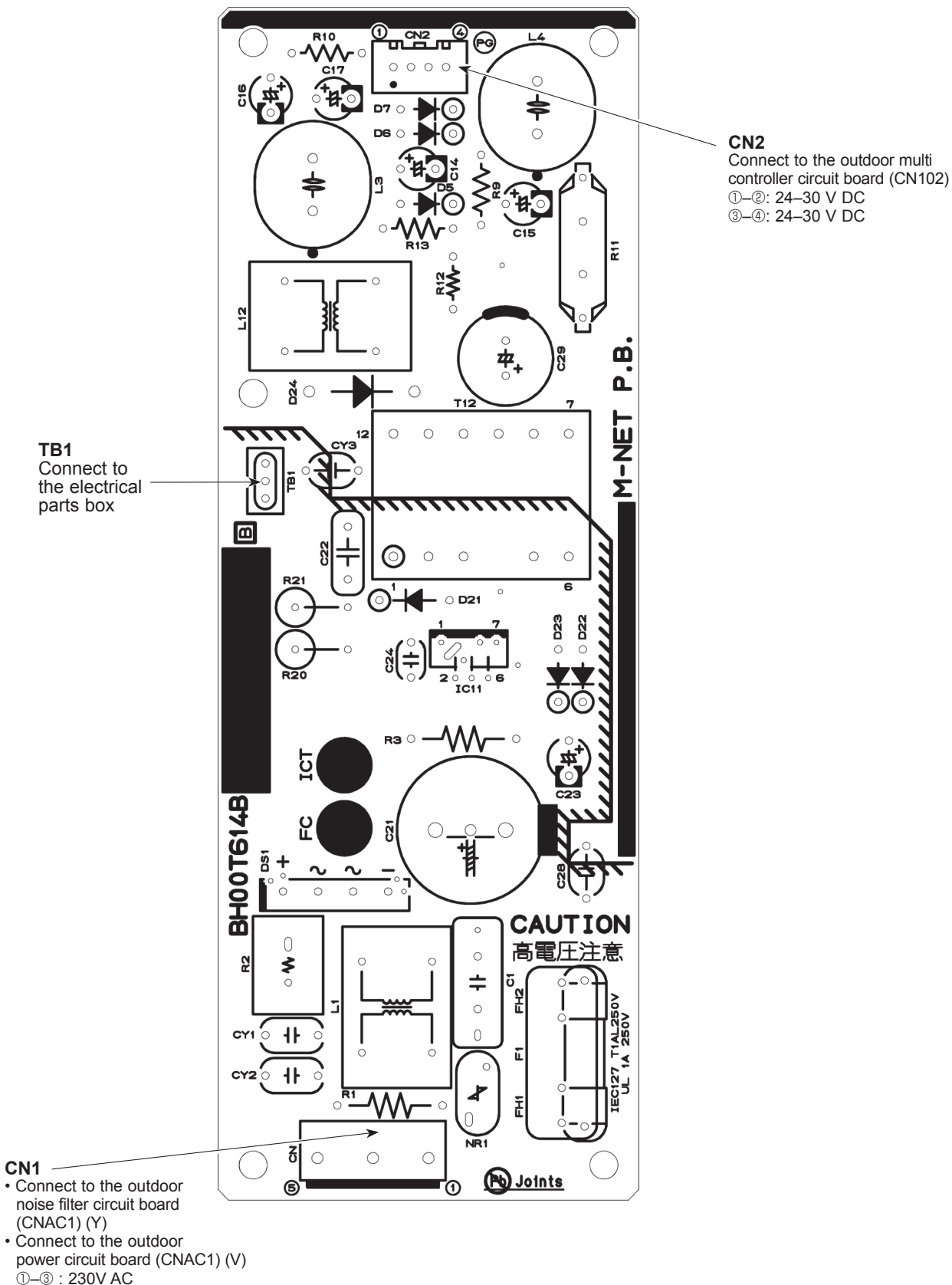

Outdoor noise filter circuit board

PUMY-SP112YKM.TH

PUMY-SP125YKM.TH

PUMY-SP140YKM.TH

PUMY-SP112YKM.TH-BS

PUMY-SP125YKM.TH-BS

PUMY-SP140YKM.TH-BS

LI1, LI2, LI3, NI
POWER SUPPLY
LI1-LI2/LI2-LI3/LI3-LI1: 400 V AC input
LI1-NI/LI2-NI/LI3-NI: 230 V AC input
(Connect to the terminal block (TB1))

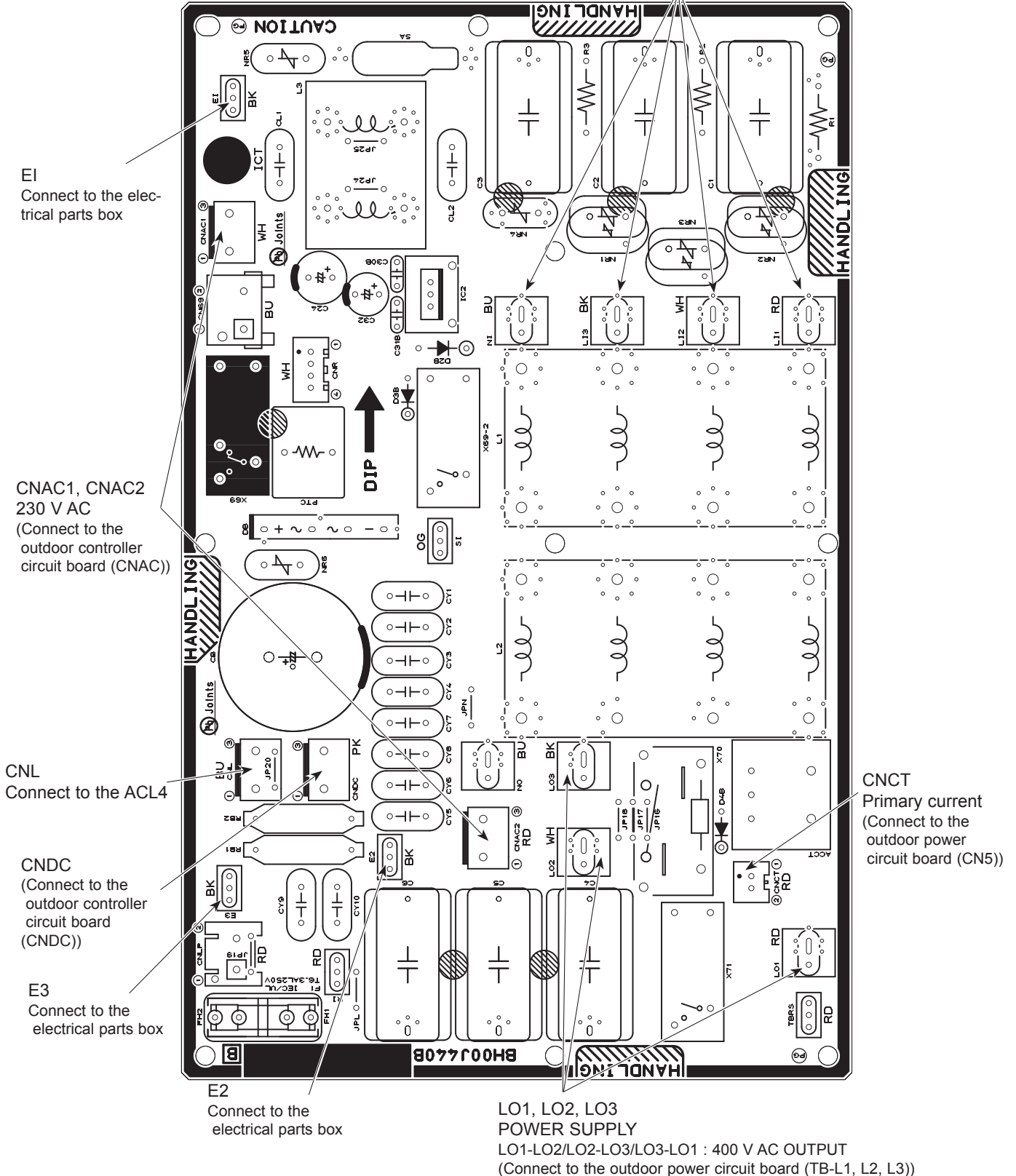

8-8. OUTDOOR UNIT INFORMATION DISPLAY

SW: setting
 0...OFF
 1...ON

No.	SW1 setting	Display on the LED1, 2 (display data)								Notes	
		1	2	3	4	5	6	7	8		
0	00000000	Relay output display	Compressor operation	21S4	SV1	(SV2)				Always lighting	ON: light on OFF: light off *When abnormality occurs, check display. Light on at time of abnormality
1	10000000	Check display	No.2 unit check	No.3 unit check	No.4 unit check	No.5 unit check	No.6 unit check	No.7 unit check	No.8 unit check		
2	01000000	Indoor unit check status	Superheat due to low discharge temperature	Compressor shell temperature abnormality	TH4 abnormality	TH3 abnormality	Outdoor fan rotation frequency abnormality	TH7 abnormality	TH8 abnormality		
3	11000000	Protection input	Compressor over current interception	Voltage abnormality	Insufficient refrigerant amount abnormality	Indoor unit capacity error	63LS abnormality	63HS abnormality	start over current interception abnormality delay	serial communication abnormality (outdoor unit)	Display detected microprocessor protection or abnormality
4	00100000	Protection input	Address double setting abnormality	Indoor unit capacity error	Over capacity	Indoor unit address error	Outdoor unit address error	Current sensor open/short	TH8 abnormality delay		
5	10100000	Abnormality delay display 1	Superheat due to low discharge temperature delay	Compressor shell temperature abnormality delay	TH4 abnormality delay	Compressor shell temperature abnormality delay	Outdoor fan rotation frequency abnormality delay	TH7 abnormality delay	TH8 abnormality delay		Display all abnormalities remaining in abnormality delay
6	01100000	Abnormality delay display 2	Compressor over current interception delay	Voltage abnormality delay	Insufficient refrigerant amount abnormality delay	Voltage abnormality delay	63LS abnormality delay	63HS abnormality delay	start over current interception abnormality delay		
7	11100000	Abnormality delay display 3	TH2 abnormality delay	4-way valve abnormality delay	Delay caused by blocked valve in cooling mode	4-way valve abnormality delay	TH6 abnormality delay	Current sensor open/short delay			
8	00010000	Abnormality delay history 1	Superheat due to low discharge temperature delay	Compressor shell temperature abnormality delay	TH4 abnormality delay	Compressor shell temperature abnormality delay	Outdoor fan rotation frequency abnormality delay	TH7 abnormality delay	TH8 abnormality delay		
9	10010000	Abnormality delay history 2	Compressor over current interception delay	Voltage abnormality delay	Insufficient refrigerant amount abnormality delay	Voltage abnormality delay	63LS abnormality delay	63HS abnormality delay	start over current interception abnormality delay		Display all abnormalities remaining in abnormality delay
10	01010000	Abnormality delay history 3	TH2 abnormality delay	4-way valve abnormality delay	Delay caused by blocked valve in cooling mode	4-way valve abnormality delay	TH6 abnormality delay	Current sensor open/short delay			
11	11010000	Abnormality code history 1 (the latest)	Abnormality delay	Abnormality delay	Abnormality delay	Abnormality delay	Abnormality delay	Abnormality delay			
12	00110000	Abnormality code history 2	Discharge/Comp. temperature	1202	1600	Discharge superheat (SHd)					
13	10110000	Abnormality code history 3	Thermistor <Compressor>(TH4)	1205	1601	Over charge refrigerant					
14	01110000	Abnormality code history 4	Thermistor <Outdoor liquid pipe> (TH3)	1211	1608	Insufficient refrigerant					
15	11110000	Abnormality code history 5	Thermistor <Suction pipe> (TH6)	1214	1608	Closed cooling valve					
16	00001000	Abnormality code history 6	Thermistor <Heat sink> (TH8)	1221	4310	4-way valve disconnection					
17	10001000	Abnormality code history 7	Thermistor <Ambient> (TH7)	1222	4320	Current sensor open/short					
18	01001000	Abnormality code history 8	Thermistor <TH2> (TH2)	1400	4330	Undervoltage, overvoltage, or power module					
19	11001000	Abnormality code history 9	Low pressure sensor	1402	4350	Heat sink temperature					
20	00101000	Abnormality code history 10 (the oldest)	High pressure sensor (63H)	1402	4500	Power module					
21	10101000	Cumulative time	0~9999 (unit: 1 hour)			Outdoor fan motor					Display of cumulative compressor operating time
22	01101000	Cumulative time	0~9999 (unit: 10 hour)								Light ON/Light OFF
23	11101000	Outdoor unit operation display	Compressor energizing	Compressor in operation	Abnormality detection						Cooling : light on, Heating: light blinking Stop fan: light off
24	00011000	Indoor unit operation mode	No. 1 unit mode	No. 2 unit mode	No. 3 unit mode	No. 4 unit mode	No. 5 unit mode	No. 6 unit mode	No. 7 unit mode	No. 8 unit mode	
25	10011000	Indoor unit operation display	No. 1 unit operation	No. 2 unit operation	No. 3 unit operation	No. 4 unit operation	No. 5 unit operation	No. 6 unit operation	No. 7 unit operation	No. 8 unit operation	Thermo ON: light on Thermo OFF: light off

* Display abnormalities up to present (including abnormality terminals)
 * History record in 1 is the latest; records become older in sequence; history record in 10 is the oldest.

No.	SW1 setting	Display mode	Display on the LED1, 2 (display data)								Notes												
			1	2	3	4	5	6	7	8													
26	01011000	Capacity code (No. 1 indoor unit)									<ul style="list-style-type: none"> •Display of indoor unit capacity code •The No. 1 unit will start from the M-NET address with the lowest number 												
27	11011000	Capacity code (No. 2 indoor unit)																					
28	00111000	Capacity code (No. 3 indoor unit)																					
29	10111000	Capacity code (No. 4 indoor unit)																					
30	01111000	Capacity code (No. 5 indoor unit)																					
31	11111000	IC1 operation mode									<ul style="list-style-type: none"> •Display of indoor unit operating mode 												
32	00001000	IC2 operation mode																					
33	10000100	IC3 operation mode																					
34	01000100	IC4 operation mode																					
35	11000100	IC5 operation mode																					
36	00100100	OC operation mode	Fan	Cooling thermo-ON	Cooling thermo-OFF	Heating thermo-ON	Heating thermo-OFF																
37	10100100	External connection status	Compressor ON/OFF	Heating/Cooling	CN3N1-3 input	CN3N1-2 input	Refrigerant pull back/no	Excitation current/no	3-minutes delay/no	Light on/light off													
38	01100100	Communication default capacity	CN3N1-3 input	CN3S1-2 input	CN3D1-3 input	CN3D1-2 input																	
39	11100100	Number of compressor ON/OFF	0-255 (%)																				
40	00010100	Compressor operating current	0000-9999 (unit: x10)																				
41	10010100	Input current of outdoor unit	0-999.9 (Arms)																				
42	01010100	Thermo-ON operating time	0000-9999 (unit: x10)																				
43	11010100	Total capacity of thermo-ON	0-255																				
44	00110100	Number of indoor units	0-255																				
45	10110100	DC bus voltage	0-999.9 (V)																				
46	01110100	State of LEV control	Td over heat prevention	SHd decrease prevention	Minimum Sj correction depends on Td	Minimum Sj correction depends on SHd	LEV opening correction depends on Pd	LEV opening correction depends on Td	Correction of high compression ratio prevention	Display active LEV control													
47	11110100	State of compressor frequency control 1	Condensing temperature limit control	Compressor temperature control	Secondary current control	Input current control	HIC abnormality	Frozen protection	Discharge temp. (heating) backup control	Pd abnormality control (heating)	Pd Back up control(heating)	Freeze prevention control at the beginning of SHd											
48	00001100	State of compressor frequency control 2	Heat sink over heat prevention control	Secondary current control	HIC abnormality	Input current control	HIC abnormality	Frozen protection	Frequency restrain of receipt voltage change	Low pressure decrease prevention	Hz-up inhibit control at the beginning of SHd	Display active compressor frequency control											
49	10001100	Protection input	63LS abnormality	HIC abnormality	Frozen protection	Input current control	Max Hz correction control due to receipt voltage change	Max Hz correction control due to receipt voltage change	4-way valve disconnection abnormality	Delay caused by blocked valve in cooling mode	TH6 abnormality	Power module abnormality											
50	01001100	The second current value when microprocessor of POWER BOARD abnormality is detected	0-999.9[Arms]									Display data at time of abnormality											
51	11001100	Head sink temperature when microprocessor of POWER BOARD abnormality is detected	-99.9-999.9 (°C)																				
			<table border="1"> <thead> <tr> <th>Content</th> </tr> </thead> <tbody> <tr> <td>State of compressor frequency(Hz) control</td> </tr> <tr> <td>Discharge pressure control</td> </tr> <tr> <td>Compressor temperature control</td> </tr> <tr> <td>SV control</td> </tr> <tr> <td>Abnormal rise of Pd control</td> </tr> <tr> <td>Heat sink over heat prevention control</td> </tr> <tr> <td>Secondary current control</td> </tr> <tr> <td>Input current control</td> </tr> <tr> <td>Hz correction of receipt voltage decrease prevention</td> </tr> <tr> <td>Hz restrain of receipt voltage change</td> </tr> </tbody> </table>										Content	State of compressor frequency(Hz) control	Discharge pressure control	Compressor temperature control	SV control	Abnormal rise of Pd control	Heat sink over heat prevention control	Secondary current control	Input current control	Hz correction of receipt voltage decrease prevention	Hz restrain of receipt voltage change
Content																							
State of compressor frequency(Hz) control																							
Discharge pressure control																							
Compressor temperature control																							
SV control																							
Abnormal rise of Pd control																							
Heat sink over heat prevention control																							
Secondary current control																							
Input current control																							
Hz correction of receipt voltage decrease prevention																							
Hz restrain of receipt voltage change																							

No.	SW1 setting	Display mode	Display on the LED1, 2 (display data)								Notes
			1	2	3	4	5	6	7	8	
128	00000001	Actual frequency of abnormality delay	0-255 (Hz)								Display of actual frequency at time of abnormality delay
129	10110001	Fan step number at time of abnormality delay	0-15								Display of fan step number at time of abnormality delay
131	11000001	IC1 LEV opening pulse abnormality delay	0-2000 (pulse)								Delay of opening pulse of indoor LEV at time of abnormality delay
132	00100001	IC2 LEV opening pulse abnormality delay									
133	10100001	IC3 LEV opening pulse abnormality delay									
134	01100001	IC4 LEV opening pulse abnormality delay									
135	11100001	IC5 LEV opening pulse abnormality delay									
136	00010001	High pressure sensor data at time of abnormality delay kgf/cm ²	-99.9-999.9 (kgf/cm ²)								Display of data from High pressure sensor, all thermistors, and SC/SH at time of abnormality delay
137	10010001	TH4 (Compressor) sensor data at time of abnormality delay									
138	01010001	TH6 (Suction pipe) sensor data at time of abnormality delay	-99.9-999.9 (°C)								
139	11010001	TH3 (Outdoor liquid pipe) sensor data at time of abnormality delay									
140	00110001	TH8 (Heat sink) sensor data at time of abnormality delay									
141	10110001	OC SC (cooling) at time of abnormality delay									
142	01110001	IC1 SC/SH at time of abnormality delay									
143	11110001	IC2 SC/SH at time of abnormality delay									
144	00001001	IC3 SC/SH at time of abnormality delay									
145	10001001	IC4 SC/SH at time of abnormality delay									
146	01001001	IC5 SC/SH at time of abnormality delay	-99.9-999.9(°C) During heating: subcool (SC) During cooling: superheat (SH) (Fixed to "0" during cooling operation)								
147	11001001	IC9 SC/SH at time of abnormality delay									
148	00100001	IC10 SC/SH at time of abnormality delay									
149	10101001	IC11 SC/SH at time of abnormality delay									
150	01101001	IC12 SC/SH at time of abnormality delay									

No.	SW1 setting	Display mode	Display on the LED1, 2 (display data)								Notes
			1	2	3	4	5	6	7	8	
151	11101001	IC9 LEV opening pulse at time of abnormality	0--2000 (pulse)								Display of opening pulse of indoor LEV at time of abnormality
152	00011001	IC10 LEV opening pulse at time of abnormality									
153	10011001	IC11 LEV opening pulse at time of abnormality									
154	01011001	IC12 LEV opening pulse at time of abnormality									
155	11011001	IC9 SC/SH at time of abnormality	-99.9--999.9(°C) During heating; subcool (SC) During cooling; superheat (SH) (Fixed to "0" during cooling operation)								Display of indoor SC/SH data at time of abnormality
156	00111001	IC10 SC/SH at time of abnormality									
157	10111001	IC11 SC/SH at time of abnormality									
158	01111001	IC12 SC/SH at time of abnormality									
159	11111001	IC9 Capacity code	0--255								Display of indoor unit capacity code The No. 1 unit will start from the M-NET address with the lowest number
160	00000101	IC10 Capacity code									
161	10000101	IC11 Capacity code									
162	01000101	IC12 Capacity code									
163	11000101	IC9 SC/SH	-99.9--999.9(°C) During heating; subcool (SC) During cooling; superheat (SH) (Fixed to "0" during cooling operation)								Display of indoor SC/SH data
164	00100101	IC10 SC/SH									
165	10100101	IC11 SC/SH									
166	01100101	IC12 SC/SH									
170	01010101	ROM version monitor	0.00--99.99 (ver)								Display of version data of ROM
171	11010101	ROM type									Display of ROM type
172	00110101	Check sum mode	0000--FFFF								Display of check sum code of ROM
173	10110101	IC9 TH23 (Gas)									
174	01110101	IC10 TH23 (Gas)									
175	11110101	IC11 TH23 (Gas)									
176	00001101	IC12 TH23 (Gas)									
177	10001101	IC9 TH22 (Liquid)									
178	01001101	IC10 TH22 (Liquid)									
179	11001101	IC11 TH22 (Liquid)									
180	00101101	IC12 TH22 (Liquid)									
185	10011101	IC9 TH21 (Intake)									
186	01011101	IC10 TH21 (Intake)									
187	11011101	IC11 TH21 (Intake)									
188	00111101	IC12 TH21 (Intake)									
189	10111101	History of voltage error (U9/4220)	-	-	PAM error	Converter Fault	Power synchronization signal error	L1 open phase error	Under voltage error	Over voltage error	
192	00000011	Actual frequency of abnormality	0-255 (Hz)								Display of actual frequency at time of abnormality
193	10000011	Fan step number at time of abnormality	0-15								Display of fan step number at time of abnormality

No.	SW1 setting	Display mode	Display on the LED1, 2 (display data)								Notes		
			1	2	3	4	5	6	7	8			
195	11000011	IC1 LEV opening pulse at time of abnormality									Display of opening pulse of indoor LEV at time of abnormality		
196	00100011	IC2 LEV opening pulse at time of abnormality											
197	10100011	IC3 LEV opening pulse at time of abnormality											
198	01100011	IC4 LEV opening pulse at time of abnormality											
199	11100011	IC5 LEV opening pulse at time of abnormality											
200	00010011	High pressure sensor data at time of abnormality	-99.9-999.9 (kgf/cm ²)								Display of data from High pressure sensor, all thermistors, and SC/SH at time of abnormality.		
201	10010011	TH4 (Compressor) sensor data at time of abnormality											
202	01010011	TH6 (Suction pipe) sensor data at time of abnormality											
203	11010011	TH3 (Outdoor liquid pipe) sensor data at time of abnormality											
204	00110011	TH8 (Heat sink) sensor data at time of abnormality	-99.9-999.9 (°C)										
205	10110011	OC SC (cooling) at time of abnormality									Display of indoor SC/SH data at time of abnormality		
206	01110011	IC1 SC/SH at time of abnormality											
207	11110011	IC2 SC/SH at time of abnormality											
208	00001011	IC3 SC/SH at time of abnormality	-99.9-999.9(°C) During heating: subcool (SC) During cooling: superheat (SH) (Fixed to "0" during cooling operation)										
209	10001011	IC4 SC/SH at time of abnormality											
210	01001011	IC5 SC/SH at time of abnormality											
211	11001011	IC6 Capacity code											
212	00101011	IC7 Capacity code	0-255										
213	10101011	IC8 Capacity code									Display of indoor unit capacity code The No.1 unit will start from the M-NET address with the lowest number		
214	01101011	IC6 operation mode	STOP		Fan		Cooling thermo-ON		Heating thermo-ON			Heating thermo-OFF	
215	11101011	IC7 operation mode											
216	00011011	IC8 operation mode											
217	10011011	IC6 LEV opening pulse											
218	01011001	IC7 LEV opening pulse											
219	11011001	IC8 LEV opening pulse	0-2000 (pulse)									Display of opening pulse of indoor LEV	

This chapter provides an introduction to electrical wiring for the CITY MULTI-S series, together with notes concerning power wiring, wiring for control (transmission wires and remote controller wires), and the frequency converter.

9-1. OVERVIEW OF POWER WIRING

- (1) Use a separate power supply for the outdoor unit and indoor unit.
- (2) Bear in mind ambient conditions (ambient temperature, direct sunlight, rain water, etc.) when proceeding with the wiring and connections.
- (3) The wire size is the minimum value for metal conduit wiring. The power cord size should be 1 rank thicker consideration of voltage drops. Make sure the power-supply voltage does not drop more than 10 %.
- (4) Specific wiring requirements should adhere to the wiring regulations of the region.
- (5) Power supply cords of parts of appliances for outdoor use shall not be lighter than polychloroprene sheathed flexible cord (design 60245 IEC57). For example, use wiring such as YZW.
- (6) Install an earth line longer than power cables.

⚠ Warning:

- Be sure to use specified wires to connect so that no external force is imparted to terminal connections. If connections are not fixed firmly, it may cause heating or fire.
- Be sure to use the appropriate type of overcurrent protection switch. Note that generated overcurrent may include some amount of direct current.

⚠ Caution:

- Some installation site may require attachment of an earth leakage breaker. If no earth leakage breaker is installed, it may cause an electric shock.
- Do not use anything other than breaker and fuse with correct capacity. Using fuse and wire or copper wire with too large capacity may cause a malfunction of unit or fire.
- Be sure to install N-Line. Without N-Line, it could cause damage to the unit.

9-2. WIRING OF MAIN POWER SUPPLY AND EQUIPMENT CAPACITY

9-2-1. Wiring diagram for main power supply

■ Schematic Drawing of Wiring : When NOT using a Branch Box (example)

PUMY-SP•VKM series

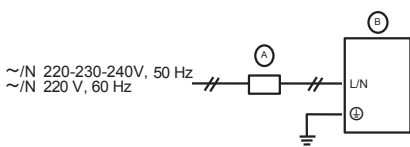

PUMY-SP•YKM series

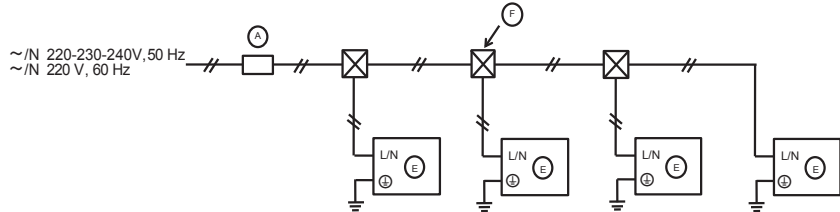
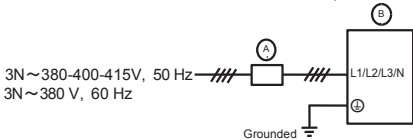

Note: The M-NET control indoor unit cannot receive power supplied from an outdoor unit, so provide it with power separately.

- Ⓐ Switch (Breakers for Wiring and Current Leakage)
- Ⓑ Outdoor Unit
- Ⓒ Branch Box
- Ⓓ A-Control Indoor Unit
- Ⓔ M-NET Control Indoor unit
- Ⓕ Pull Box

■ Schematic Drawing of Wiring : When using a Branch Box (example)

<When power is supplied from the outdoor unit>

PUMY-SP•VKM series

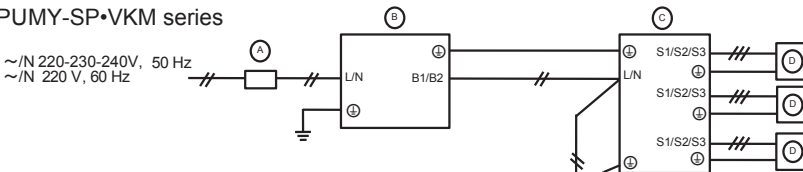

PUMY-SP•YKM series

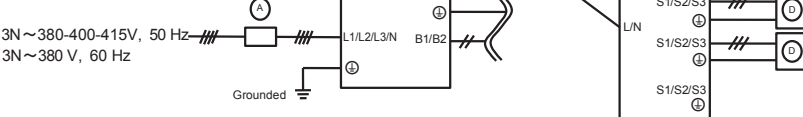

<When power is supplied separately>

PUMY-SP•VKM series

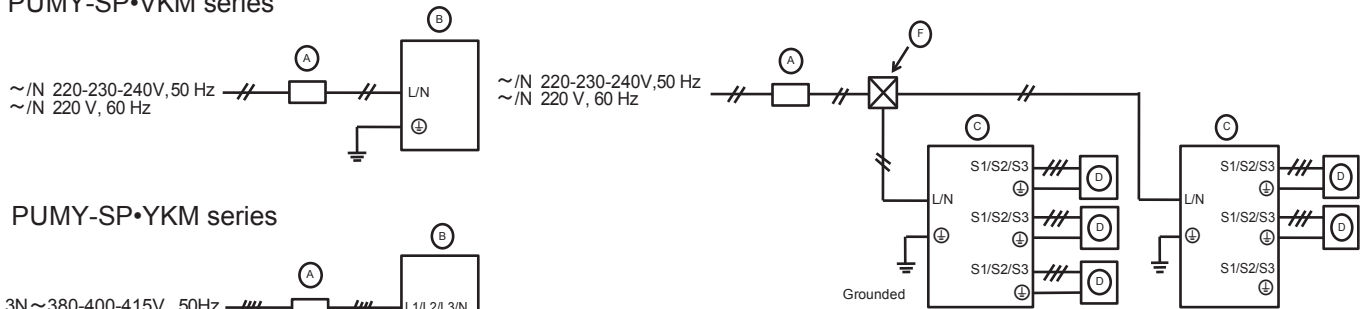

PUMY-SP•YKM series



- Ⓐ Switch (Breakers for Wiring and Current Leakage)
- Ⓑ Outdoor Unit
- Ⓒ Branch Box
- Ⓓ A-Control Indoor Unit
- Ⓔ M-NET Control Indoor unit
- Ⓕ Pull Box

■ Schematic Drawing of Wiring : When using a Branch Box and M-NET control indoor unit (example)

<When power is supplied separately>

PUMY-SP•VKM series

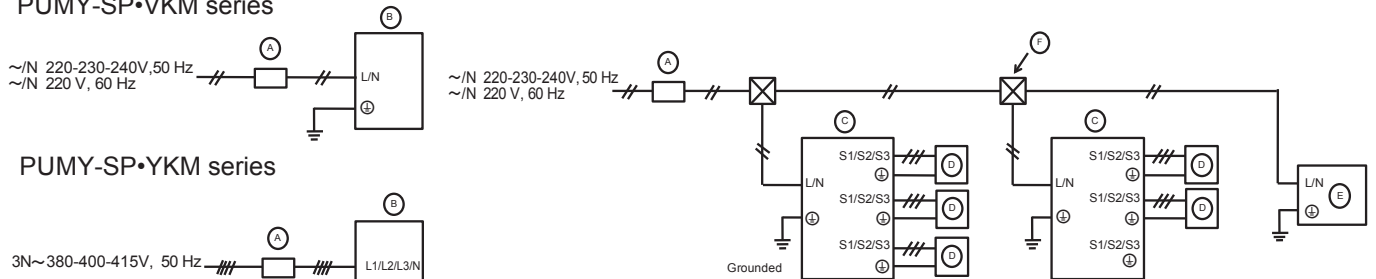

PUMY-SP•YKM series

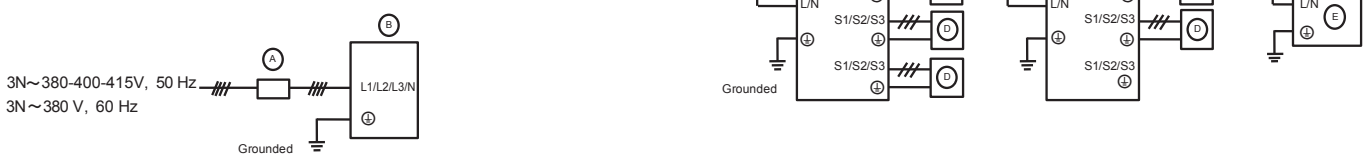

<When power is supplied from the outdoor unit>

PUMY-SP•VKM series

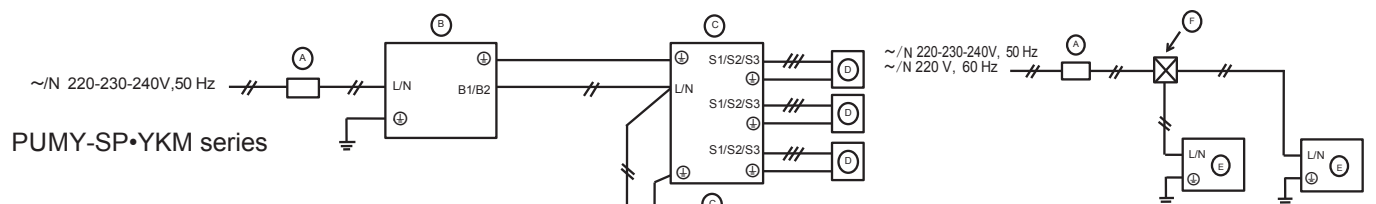

PUMY-SP•YKM series

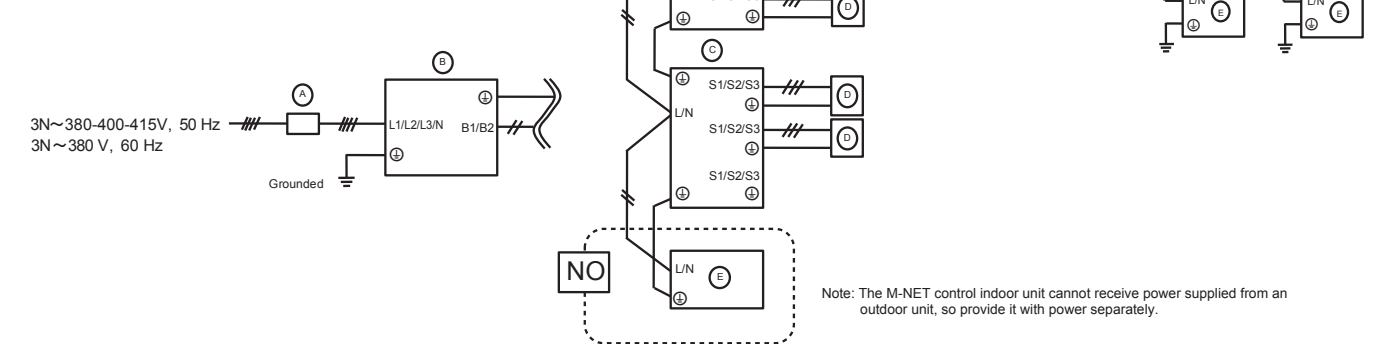

Note: The M-NET control indoor unit cannot receive power supplied from an outdoor unit, so provide it with power separately.

9-2-2. Cross section area of Wire for Main Power and ON/OFF capacities

PUMY-SP112VKM.TH PUMY-SP125VKM.TH PUMY-SP140VKM.TH
 PUMY-SP112YKM.TH PUMY-SP125YKM.TH PUMY-SP140YKM.TH
 PUMY-SP112VKM.TH-BS PUMY-SP125VKM.TH-BS PUMY-SP140VKM.TH-BS
 PUMY-SP112YKM.TH-BS PUMY-SP125YKM.TH-BS PUMY-SP140YKM.TH-BS

<Outdoor unit> <When power is supplied to outdoor unit and branch box separately>

Model	Power Supply	Minimum Wire Cross-sectional area (mm ²)			Breaker for Wiring *1	Breaker for Current Leakage	
		Main Cable	Branch	Ground			
Outdoor Unit	SP112-140V	~N 220-230-240V, 50 Hz ~N 220 V, 60 Hz	6	-	6	32 A	32 A 30 mA 0.1 seconds or less
	SP112-140Y	3N~380-400-415V, 50 Hz 3N~380 V, 60 Hz	1.5	-	1.5	16 A	16 A 30 mA 0.1 seconds or less

<Outdoor unit> <When power is supplied to branch box from the outdoor unit>

Model	Power Supply	Minimum Wire Cross-sectional area (mm ²)			Breaker for Wiring *1	Breaker for Current Leakage	
		Main Cable	Branch	Ground			
Outdoor Unit	SP112-140V	~N 220-230-240V, 50 Hz ~N 220 V, 60 Hz	6	-	6	40 A	40 A 30 mA 0.1 seconds or less
	SP112-140Y	3N~380-400-415V 50 Hz 3N~380 V, 60 Hz	2.5	-	2.5	25 A	25 A 30 mA 0.1 seconds or less

*1 A breaker with at least 3.0 mm contact separation in each poles shall be provided. Use non-fuse breaker (NF) or earth leakage breaker (NV).

<Indoor units> <When power is supplied to indoor unit and outdoor unit separately>

Total operating current of the indoor unit	Minimum wire thickness (mm ²)			Ground-fault interrupter *2	Local switch (A)		Breaker for wiring (NFB)
	Main Cable	Branch	Ground		Capacity	Fuse	
F0 = 16 A or less *3	1.5	1.5	1.5	20 A current sensitivity *4	16	16	20
F0 = 25 A or less *3	2.5	2.5	2.5	30 A current sensitivity *4	25	25	30
F0 = 32 A or less *3	4.0	4.0	4.0	40 A current sensitivity *4	32	32	40

Apply to IEC61000-3-3 about max. permissive system impedance.

*2 The Ground-fault interrupter should support inverter circuit.

The Ground-fault interrupter should combine using of local switch or wiring breaker.

*3 Please take the larger of F1 or F2 as the value for F0.

F1 = Total operating maximum current of the indoor units × 1.2

F2 = F2 = {V1 × (Quantity of Type 1)/C} + {V1 × (Quantity of Type 2)/C} + {V1 × (Quantity of Type 3)/C} + ... + {V1 × (Quantity of Type 15)/C}

Connect to Branch box (PAC-MK-BC)

Indoor unit	V1	V2
Type 1 PEAD-RP-JAQ(L).UK, PEAD-M-JA(Q)	26.9	2.4
Type 2 SEZ-KD-VA, PCA-RP-KAQ, SLZ-KF-VA, PLA-RP-EA(UK), PCA-M-KA	19.8	
Type 3 MLZ-KA-VA	9.9	
Type 4 MSZ-LN-VG	7.4	
Type 5 MSZ-FH-VE, MSZ-GF-VE, MSZ-SF-VE, MSZ-EF-VE, MSZ-SF-VA	6.8	
Type 6 Branch box (PAC-MK-BC(B))	5.1	3.0

Connect to Connection kit (PAC-LV11M)

Indoor unit	V1	V2
Type 7 MSZ-LN-VG	7.4	2.4
Type 8 MSZ-SF-VA, MSZ-SF-VE, MSZ-EF-VE, MSZ-FH-VE	6.8	
Type 9 Connection kit (PAC-LV11M)	3.5	

Indoor unit	V1	V2
Type 10 PMFY-P-VBM-E, PLFY-P-VBM-E, PLFY-P-VEM-E, PLFY-EP-VEM-E, PLFY-P-VFM-E, PEFY-P-VMS1(L)-E, PCFY-P-VKM-E, PKFY-P-VHM-E, PKFY-P-VKM-E, PFFY-P-VKM-E, PFFY-P-VLRMM-E	19.8	2.4
Type 11 PEFY-P-VMHS-E	13.8	
Type 12 PLFY-P-VCM-E	9.9	
Type 13 PKFY-P-VBM-E	3.5	
Type 14 PEFY-P-VMA(L)-E, PEFY-P-VMA3-E	38	1.6
Type 15 PLFY-P-VLMD-E, PEFY-P-VMR-E-L/R, PDFY-P-VM-E, PEFY-P-VMH-E-F, PFFY-P-VLEM-E, PFFY-P-VLRM-E, GUF*4-RD(H)4, PEFY-P-VMH-E	0.0	0.0

C: Multiple of tripping current at tripping time 0.01 s

Please pick up "C" from the tripping characteristic of the breaker.

<Example of "F2" calculation>

Condition PLFY-VBM × 4 + PEFY-VMA × 1, C = 8 (refer to right sample chart)

F2 = 19.8 × 4/8 + 38 × 1/8

= 14.65

→ 16 A breaker (Tripping current = 8 × 16 A at 0.01 s)

*4 Current sensitivity is calculated using the following formula.

G1 = V2 × (Quantity of Type1) + V2 × (Quantity of Type2) + V2 × (Quantity of Type3) + ... + V2 × (Quantity of Type15) + V3 × (Wire length[km])

<Example of "G1" calculation>

When connecting 3 units of the SEZ-KD respectively to a branch box with a wire that is 20 m long and 1.5 mm² in diameter, then connecting the branch box and PEFY-VMA to a single breaker with a wire that is 100 m long in total and 2.5 mm² in diameter.

G1 = 2.4 × 3 + 3 + 1.6 + 48 × 0.02 × 3 + 56 × 0.1

= 20.28

G1	Current sensitivity
30 or less	30 mA 0.1 seconds or less
100 or less	100 mA 0.1 seconds or less

Wire thickness	V3
1.5 mm ²	48
2.5 mm ²	56
4.0 mm ²	66

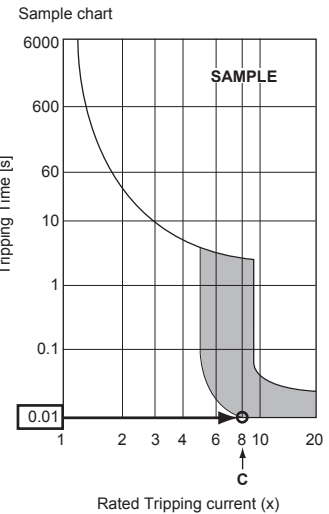

- Bear in mind ambient conditions (ambient temperature, direct sunlight, rain water, etc.) when proceeding with the wiring and connections.
- The wire size is the minimum value for metal conduit wiring. The power cord size should be 1 rank thicker consideration of voltage drops. Make sure the power-supply voltage does not drop more than 10%.
- Specific wiring requirements should adhere to the wiring regulations of the region.
- Power supply cords of parts of appliances for outdoor use shall not be lighter than polychloroprene sheathed flexible cord (design 60245 IEC57). For example, use wiring such as YZW.
- Install an earth line longer than power cables.

9-3. DESIGN FOR CONTROL WIRING

Please note that the types and numbers of control wires needed by the CITY MULTI-S series depend on the remote controllers and whether they are linked with the system or not.

9-3-1. Selection number of control wires

		M-NET remote controller
Use		Remote controller used in system control operations. • Group operation involving different refrigerant systems. • Linked operation with upper control system.
Remote controller → indoor unit		2-core wire (non-polar)
Transmission wires	Wires connecting → indoor units	
	Wires connecting → indoor units with outdoor unit	
	Wires connecting → outdoor units	

9-4. WIRING TRANSMISSION CABLES

9-4-1. Types of control cables

- Wiring transmission cables
 - Types of transmission cables: Shielding wire CVVS, CPEVS, or MVVS
 - Cable diameter: More than 1.25 mm²
 - Maximum wiring length: Within 200 m

2. M-NET Remote control cables

Kind of remote control cable	Shielding wire (2-core) CVVS, CPEVS, or MVVS
Cable diameter	0.5 to 1.25 mm ²
Remarks	When 10 m is exceeded, use a cable with the same specifications as transmission line wiring.

3. MA Remote control cables

Kind of remote control cable	Sheathed 2-core cable (unshielded) CVV
Cable diameter	0.3 to 1.25 mm ² (0.75 to 1.25 mm ²)*
Remarks	Within 200 m

* Connected with simple remote controller.

9-4-2. Wiring examples

- Controller name, symbol and allowable number of controllers.

Name	Symbol	Allowable number of controllers	
Outdoor unit controller	OC	—	
Indoor unit controller	M-IC	PUMY-SP112	1 to 9 units per 1 OC
		PUMY-SP125	1 to 10 units per 1 OC
		PUMY-SP140	1 to 12 units per 1 OC
	A-IC	PUMY-SP112	2 to 8 units per 1 OC
		PUMY-SP125	
		PUMY-SP140	
Branch box	—	—	0 to 2 units per 1 OC
Remote controller	RC	M-NET RC	Maximum of 12 controllers for 1 OC (Cannot be connected if Branch box is used.)
		MA-RC	Maximum of 2 per group

Note that the number of connectable units may be limited by some conditions such as an indoor unit's capacity or each unit's equivalent power consumption. (Refer to DATA BOOK.)

9-5. SYSTEM SWITCH SETTING

In order to identify the destinations of signals to the outdoor units, indoor units, and remote controller of the MULTI-S series, each microprocessor must be assigned an identification number (address). The addresses of outdoor units, indoor units, and remote controller must be set using their settings switches. Please consult the installation manual that comes with each unit for detailed information on setting procedures.

9-6. EXAMPLE EXTERNAL WIRING DIAGRAM FOR A BASIC SYSTEM (USING PUMY-SP-YKM)

■ Example of system when using a M-NET controller

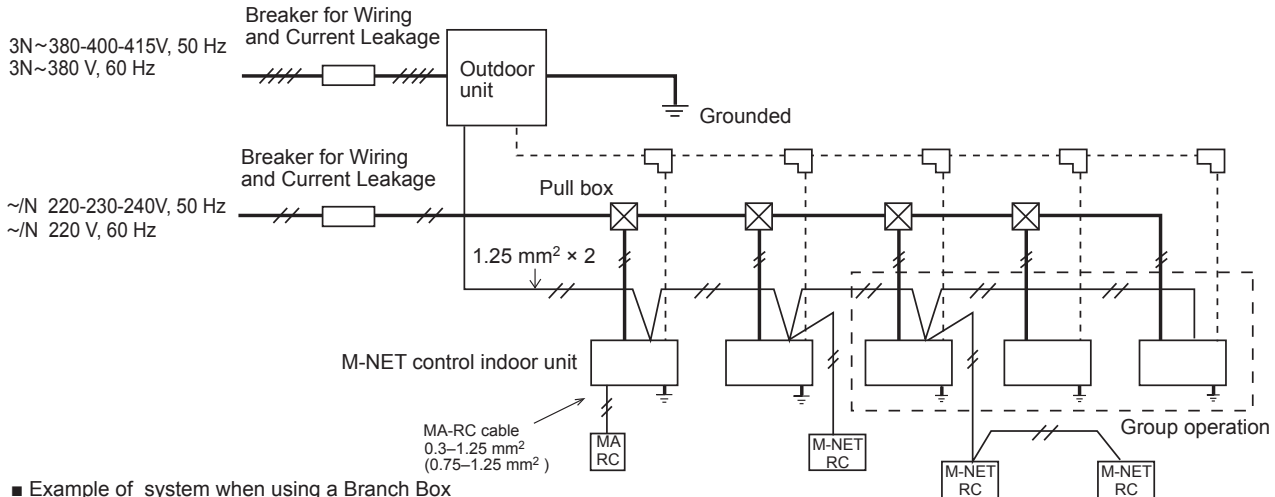

■ Example of system when using a Branch Box

<When power is supplied separately>

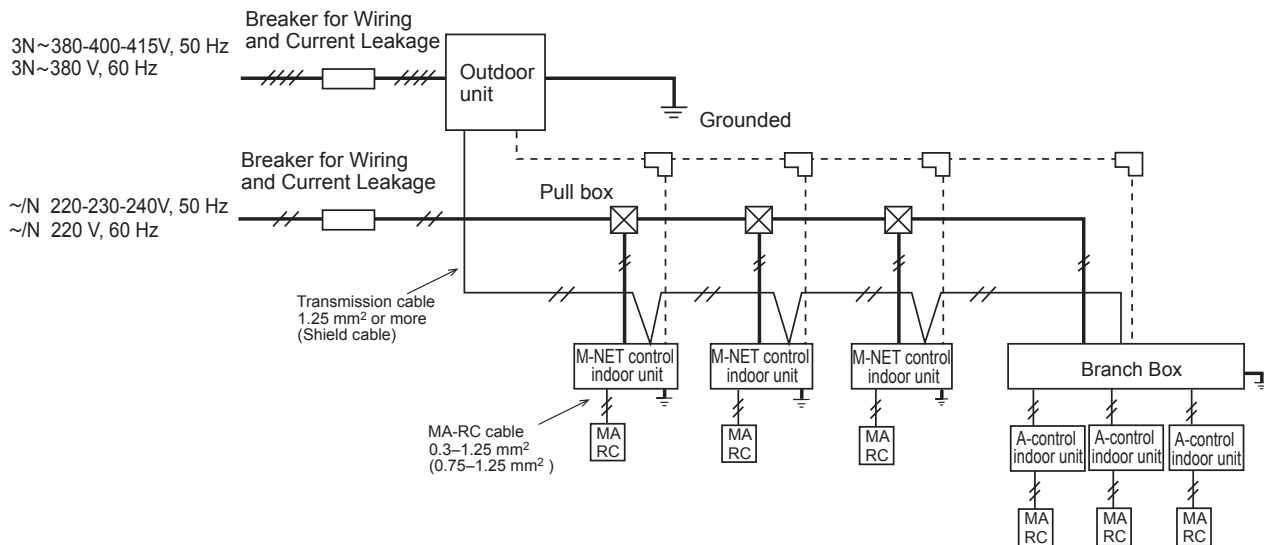

<When power is supplied from outdoor unit>

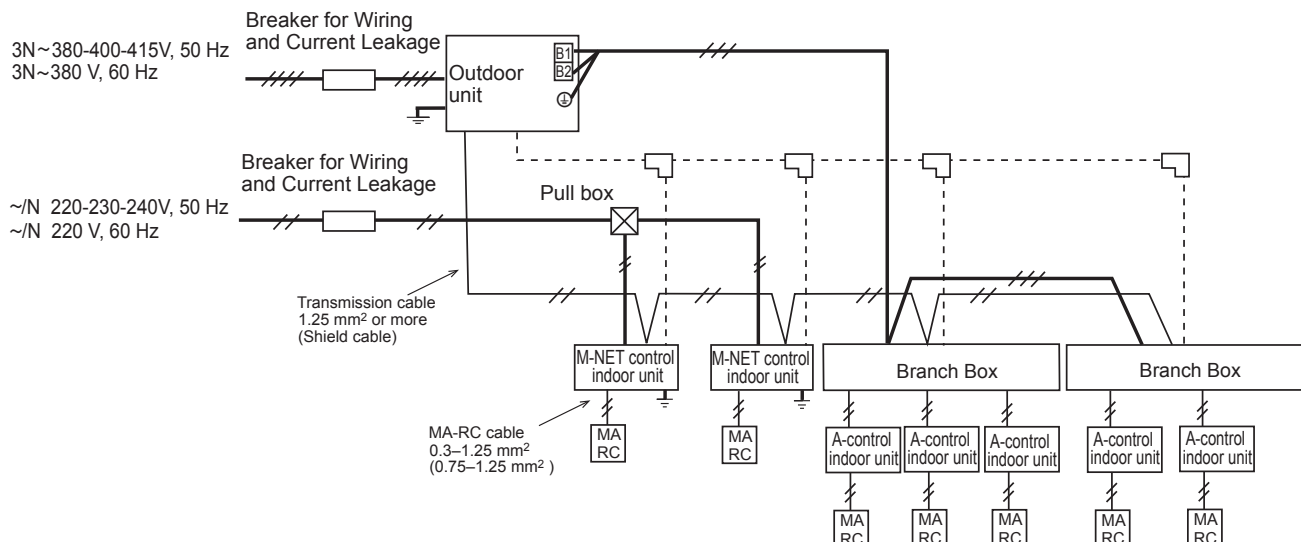

9-7. METHOD FOR OBTAINING ELECTRICAL CHARACTERISTICS WHEN A CAPACITY AGREEMENT IS TO BE SIGNED WITH AN ELECTRIC POWER COMPANY

The electrical characteristics of connected indoor unit system for air conditioning systems, including the MULTI-S series, depend on the arrangement of the indoor and outdoor units.

First read the data on the selected indoor and outdoor units and then use the following formulas to calculate the electrical characteristics before applying for a capacity agreement with the local electric power company.

9-7-1. Obtaining the electrical characteristics of a CITY MULTI-S series system

(1) Procedure for obtaining total power consumption

	Page numbers in this technical manual	Power consumption
Total power consumption of each indoor unit	See the technical manual of each indoor unit	①
Power consumption of outdoor unit*	Standard capacity diagram— Refer to 4-3.	②
Total power consumption of system	See the technical manual of each indoor unit	①+② <kW>

*The power consumption of the outdoor unit will vary depending on the total capacity of the selected indoor units.

(2) Method of obtaining total current

	Page numbers in this technical manual	Subtotal
Total current through each indoor unit	See the technical manual of each indoor unit	①
Current through outdoor unit*	Standard capacity diagram— Refer to 4-3.	②
Total current through system	See the technical manual of each indoor unit	①+② <A>

*The current through the outdoor unit will vary depending on the total capacity of the selected indoor units.

(3) Method of obtaining system power factor

Use the following formula and the total power and current obtained in parts ① and ② on the above tables to calculate the system power factor.

$$\text{System power factor} = \frac{(\text{Total system power consumption})}{(\text{Total system current} \times \text{voltage})} \times 100 \%$$

9-7-2. Applying to an electric power company for power and total current

Calculations should be performed separately for heating and cooling employing the same methods; use the largest resulting value in your application to the electric power company.

10-1. REFRIGERANT PIPING SYSTEM

Line-Branch Method
Connection Examples
(Connecting to 4 Indoor Units)

(A) Outdoor Unit
 (B) First Branch
 (C) Indoor unit

Permissible Length	Total Piping Length	$A+B+C+a+b+c+d \leq 120 \text{ m}$																								
	Farthest Piping Length (L)	$A+B+C+d \leq 70 \text{ m}$																								
	Farthest Piping Length After First Branch (ℓ)	$B+C+d \leq 50 \text{ m}$																								
Permissible High/Low Difference	High/Low Difference in Indoor/Outdoor Section (H)	50 meters or less (If the outdoor unit is lower, 30 meters or less)																								
	High/Low Difference in Indoor/Indoor Section (h)	15 meters or less																								
■ Selecting the Refrigerant Branch Kit		Use an optional branch piping kit (CMY-Y62-G-E).																								
■ Select Each Section of Refrigerant Piping		<div style="display: flex; justify-content: space-between;"> <div style="width: 45%;"> <p>(1) Section From Outdoor Unit to First Branch (A)</p> <p>(2) Sections From Branch to Indoor Unit (a,b,c,d)</p> <p>(3) Section From Branch to Branch (B,C)</p> </div> <div style="width: 10%; text-align: center; font-size: 2em;">}</div> <div style="width: 40%;"> <p>Each Section of Piping</p> </div> </div> <p>Select the size from the table to the right.</p>																								
		<div style="display: flex; justify-content: space-between;"> <div style="width: 45%;"> <p>(1) Refrigerant Piping Diameter In Section From Outdoor Unit to First Branch (Outdoor Unit Piping Diameter)</p> <table border="1" style="width: 100%; border-collapse: collapse;"> <thead> <tr> <th>Model</th> <th>Piping Diameter (mm)</th> </tr> </thead> <tbody> <tr> <td>PUMY-SP112</td> <td>Liquid Line $\phi 9.52$</td> </tr> <tr> <td>PUMY-SP125</td> <td rowspan="2">Gas Line $\phi 15.88$</td> </tr> <tr> <td>PUMY-SP140</td> </tr> </tbody> </table> </div> <div style="width: 45%;"> <p>(2) Refrigerant Piping Diameter In Section From Branch to Indoor Unit (Indoor Unit Piping Diameter)</p> <table border="1" style="width: 100%; border-collapse: collapse;"> <thead> <tr> <th>Model number</th> <th colspan="2">Piping Diameter (mm)</th> </tr> </thead> <tbody> <tr> <td rowspan="2">50 or lower</td> <td>Liquid Line</td> <td>$\ell \leq 30 \text{ m}$ $\phi 6.35$</td> </tr> <tr> <td>Gas Line</td> <td>$\phi 12.7$</td> </tr> <tr> <td rowspan="2">63 to 140</td> <td>Liquid Line</td> <td>$\phi 9.52$</td> </tr> <tr> <td>Gas Line</td> <td>$\phi 15.88$</td> </tr> </tbody> </table> </div> </div> <p>(3) Refrigerant Piping Diameter In Section From Branch to Branch</p> <table border="1" style="width: 100%; border-collapse: collapse;"> <thead> <tr> <th>Liquid Line (mm)</th> <th>Gas Line (mm)</th> </tr> </thead> <tbody> <tr> <td>$\phi 9.52$</td> <td>$\phi 15.88$</td> </tr> </tbody> </table> <p>Note: When connecting the CONNECTION KIT (PAC-LV11M-J) and an M-series indoor unit, refer to the installation manual for the CONNECTION KIT when selecting the pipe size and piping length.</p>	Model	Piping Diameter (mm)	PUMY-SP112	Liquid Line $\phi 9.52$	PUMY-SP125	Gas Line $\phi 15.88$	PUMY-SP140	Model number	Piping Diameter (mm)		50 or lower	Liquid Line	$\ell \leq 30 \text{ m}$ $\phi 6.35$	Gas Line	$\phi 12.7$	63 to 140	Liquid Line	$\phi 9.52$	Gas Line	$\phi 15.88$	Liquid Line (mm)	Gas Line (mm)	$\phi 9.52$	$\phi 15.88$
Model	Piping Diameter (mm)																									
PUMY-SP112	Liquid Line $\phi 9.52$																									
PUMY-SP125	Gas Line $\phi 15.88$																									
PUMY-SP140																										
Model number	Piping Diameter (mm)																									
50 or lower	Liquid Line	$\ell \leq 30 \text{ m}$ $\phi 6.35$																								
	Gas Line	$\phi 12.7$																								
63 to 140	Liquid Line	$\phi 9.52$																								
	Gas Line	$\phi 15.88$																								
Liquid Line (mm)	Gas Line (mm)																									
$\phi 9.52$	$\phi 15.88$																									
■ Additional refrigerant charge		<p>Refrigerant for the extended piping is not included in the outdoor unit when the unit is shipped from the factory. Therefore, charge each refrigerant piping system with additional refrigerant at the installation site. In addition, in order to carry out service, enter the size and length of each liquid pipe and additional refrigerant charge amounts in the spaces provided on the "Refrigerant amount" plate on the outdoor unit.</p> <p>Calculation of additional refrigerant charge</p> <table border="1" style="width: 100%; border-collapse: collapse;"> <thead> <tr> <th>Pipe size</th> <th>Pipe size</th> <th>Total capacity of connected indoor units</th> <th>Amount for the indoor units</th> </tr> </thead> <tbody> <tr> <td>Liquid pipe</td> <td>Liquid pipe</td> <td>up to 8.0 kW</td> <td>1.5 kg</td> </tr> <tr> <td>$\phi 6.35$</td> <td>$\phi 9.52$</td> <td>8.1 to 16.0 kW</td> <td>2.5 kg</td> </tr> <tr> <td>$(m) \times 19.0 \text{ (g/m)}$</td> <td>$(m) \times 50.0 \text{ (g/m)}$</td> <td>16.1 kW or above</td> <td>3.0 kg</td> </tr> </tbody> </table> <p>Included refrigerant amount when shipped from the factory</p> <table border="1" style="width: 100%; border-collapse: collapse;"> <thead> <tr> <th>Included refrigerant amount</th> </tr> </thead> <tbody> <tr> <td>3.5 kg</td> </tr> </tbody> </table> <p><Example> Outdoor model : P125 Indoor 1 : P63 (7.1 kW) 2 : P40 (4.5 kW) 3 : P25 (2.8 kW) 4 : P20 (2.2 kW)</p> <p>A : $\phi 9.52$ 20 m B : $\phi 9.52$ 5 m C : $\phi 9.52$ 5 m a : $\phi 9.52$ 15 m b : $\phi 6.35$ 10 m c : $\phi 6.35$ 10 m d : $\phi 6.35$ 20 m</p> <p style="text-align: right;">} At the conditions below:</p> <p>The total length of each liquid line is as follows: $\phi 9.52$: $A + B + C + a = 20 + 5 + 5 + 15 = 45 \text{ m}$ $\phi 6.35$: $b + c + d = 10 + 10 + 20 = 40 \text{ m}$ The total capacity of connected indoor unit is as follows: $7.1 + 4.5 + 2.8 + 2.2 = 16.6$</p> <p><Calculation example> Additional refrigerant charge</p> $40 \times \frac{19.0}{1000} + 45 \times \frac{50.0}{1000} + 3.0 = 6.1 \text{ kg (rounded up)}$	Pipe size	Pipe size	Total capacity of connected indoor units	Amount for the indoor units	Liquid pipe	Liquid pipe	up to 8.0 kW	1.5 kg	$\phi 6.35$	$\phi 9.52$	8.1 to 16.0 kW	2.5 kg	$(m) \times 19.0 \text{ (g/m)}$	$(m) \times 50.0 \text{ (g/m)}$	16.1 kW or above	3.0 kg	Included refrigerant amount	3.5 kg						
Pipe size	Pipe size	Total capacity of connected indoor units	Amount for the indoor units																							
Liquid pipe	Liquid pipe	up to 8.0 kW	1.5 kg																							
$\phi 6.35$	$\phi 9.52$	8.1 to 16.0 kW	2.5 kg																							
$(m) \times 19.0 \text{ (g/m)}$	$(m) \times 50.0 \text{ (g/m)}$	16.1 kW or above	3.0 kg																							
Included refrigerant amount																										
3.5 kg																										

Header-Branch Method
Connection Examples
(Connecting to 4 Indoor Units)

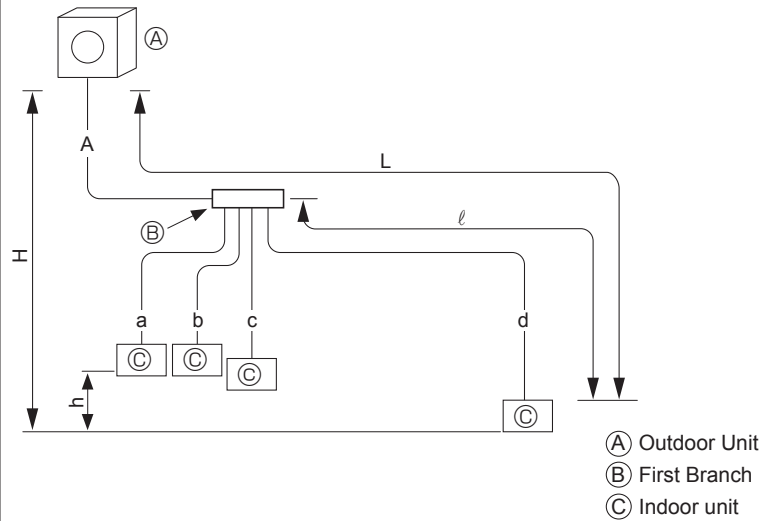

Permissible Length	Total Piping Length	$A+a+b+c+d \leq 120$ m
	Farthest Piping Length (L)	$A+d \leq 70$ m
	Farthest Piping Length After First Branch (l)	d is 50 meters or less
Permissible High/Low Difference	High/Low Difference in Indoor/Outdoor Section (H)	50 meters or less (If the outdoor unit is lower, 30 meters or less)
	High/Low Difference in Indoor/Indoor Section (h)	15 meters or less

■ **Selecting the Refrigerant Branch Kit**
Please select branching kit, which is sold separately, from the table below.
(The kit comprises sets for use with liquid pipes and for use with gas pipes.)

Branch header (4 branches)	Branch header (8 branches)
CMY-Y64-G-E	CMY-Y68-G-E

■ **Select Each Section of Refrigerant Piping**

(1) Section From Outdoor Unit to First Branch (A) } Each Section of Piping
 (2) Sections From Branch to Indoor Unit (a,b,c,d)

Select the size from the table to the right.

(1) Refrigerant Piping Diameter In Section From Outdoor Unit to First Branch (Outdoor Unit Piping Diameter)		(2) Refrigerant Piping Diameter In Section From Branch to Indoor Unit (Indoor Unit Piping Diameter)	
Model	Piping Diameter (mm)	Model number	Piping Diameter (mm)
PUMY-SP112 PUMY-SP125 PUMY-SP140	Liquid Line	50 or lower	$l \leq 30$ m $\phi 6.35$
	Gas Line		$l > 30$ m $\phi 9.52$
		63 to 140	$\phi 12.7$
			Liquid Line $\phi 9.52$
			Gas Line $\phi 15.88$

Note:
When connecting the CONNECTION KIT (PAC-LV11M-J) and an M-series indoor unit, refer to the installation manual for the CONNECTION KIT when selecting the pipe size and piping length.

■ **Additional refrigerant charge**
Refrigerant for the extended piping is not included in the outdoor unit when the unit is shipped from the factory. Therefore, charge each refrigerant piping system with additional refrigerant at the installation site. In addition, in order to carry out service, enter the size and length of each liquid pipe and additional refrigerant charge amounts in the spaces provided on the "Refrigerant amount" plate on the outdoor unit.

Calculation of additional refrigerant charge

- Calculate the additional charge using the liquid pipe size and length of the extended piping and total capacity of connected indoor units.
- Calculate the additional refrigerant charge using the procedure shown to the right, and charge with the additional refrigerant.
- For amounts less than 0.1 kg, round up the calculated additional refrigerant charge.
(For example, if the calculated charge is 6.01 kg, round up the charge to 6.1 kg.)

Calculation of additional refrigerant charge

Pipe size Liquid pipe $\phi 6.35$ (m) \times 19.0 (g/m)	+	Pipe size Liquid pipe $\phi 9.52$ (m) \times 50.0 (g/m)	+	Total capacity of connected indoor units up to 8.0 kW	Amount for the indoor units 1.5 kg
				8.1 to 16.0 kW	2.5 kg
				16.1 kW or above	3.0 kg

Included refrigerant amount when shipped from the factory

Included refrigerant amount
3.5 kg

<Example>

Outdoor model : P125	A : $\phi 9.52$ 30 m	}	At the conditions below:
Indoor 1 : P63 (7.1 kW)	a : $\phi 9.52$ 15 m		
2 : P40 (4.5 kW)	b : $\phi 6.35$ 10 m		
3 : P25 (2.8 kW)	c : $\phi 6.35$ 10 m		
4 : P20 (2.2 kW)	d : $\phi 6.35$ 20 m		

The total length of each liquid line is as follows:
 $\phi 9.52$: $A + a = 30 + 15 = 45$ m
 $\phi 6.35$: $b + c + d = 10 + 10 + 20 = 40$ m

The total capacity of connected indoor unit is as follows:
 $7.1 + 4.5 + 2.8 + 2.2 = 16.6$

<Calculation example>
 Additional refrigerant charge

$$40 \times \frac{19.0}{1000} + 45 \times \frac{50.0}{1000} + 3.0 = 6.1 \text{ kg (rounded up)}$$

Method of Combined Branching of Lines and Headers
 Connection Examples
 (Connecting to 5 Indoor Units)

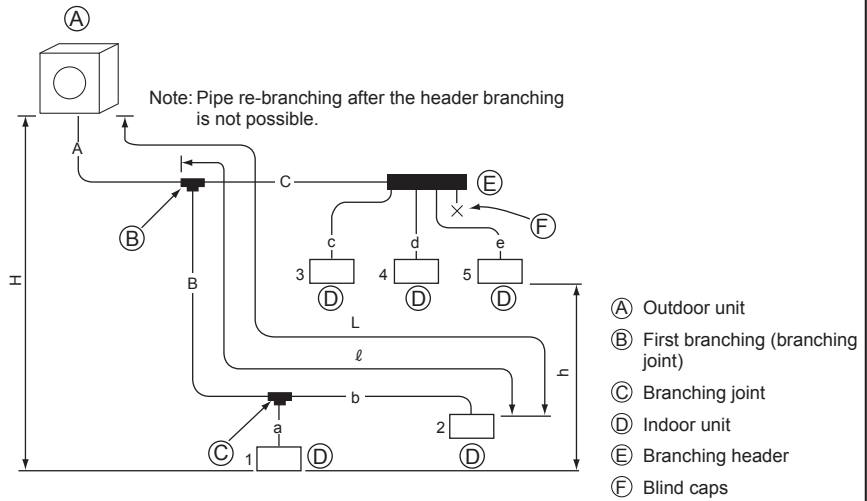

- (A) Outdoor unit
- (B) First branching (branching joint)
- (C) Branching joint
- (D) Indoor unit
- (E) Branching header
- (F) Blind caps

Permissible Length	Total Piping Length	A+B+C+a+b+c+d+e is 120 meters or less
	Farthest Piping Length (L)	A+B+b is 70 meters or less
	Farthest Piping Length After First Branch (ℓ)	B+b is 50 meters or less
Permissible High/Low Difference	High/Low Difference in Indoor/Outdoor Section (H)	50 meters or less (If the outdoor unit is lower, 30 meters or less)
	High/Low Difference in Indoor/Indoor Section (h)	15 meters or less

Selecting the Refrigerant Branch Kit

Please select branching kit, which is sold separately, from the table below.
 (The kit comprises sets for use with liquid pipes and for use with gas pipes.)

Branch Joint	Branch Header (4 branches)	Branch Header (8 branches)
CMY-Y62-G-E	CMY-Y64-G-E	CMY-Y68-G-E

Select Each Section of Refrigerant Piping

- (1) Section From Outdoor Unit to First Branch (A)
 - (2) Sections From Branch to Indoor Unit (a,b,c,d,e)
 - (3) Section From Branch to Branch (B,C)
- Each Section of Piping

Select the size from the table to the right.

(1) Refrigerant Piping Diameter In Section From Outdoor Unit to First Branch (Outdoor Unit Piping Diameter)

Model	Piping Diameter (mm)	
PUMY-SP112	Liquid Line	$\phi 9.52$
PUMY-SP125	Gas Line	$\phi 15.88$
PUMY-SP140		

(2) Refrigerant Piping Diameter In Section From Branch to Indoor Unit (Indoor Unit Piping Diameter)

Model number	Piping Diameter (mm)	
50 or lower	Liquid Line	$\ell \leq 30 \text{ m}$ $\phi 6.35$
		$\ell > 30 \text{ m}$ $\phi 9.52$
	Gas Line	$\phi 12.7$
63 to 140	Liquid Line	$\phi 9.52$
	Gas Line	$\phi 15.88$

(3) Refrigerant Piping Diameter In Section From Branch to Branch

Liquid Line (mm)	Gas Line (mm)
$\phi 9.52$	$\phi 15.88$

Note:
 When connecting the CONNECTION KIT (PAC-LV11M-J) and an M-series indoor unit, refer to the installation manual for the CONNECTION KIT when selecting the pipe size and piping length.

Additional refrigerant charge

Refrigerant for the extended piping is not included in the outdoor unit when the unit is shipped from the factory. Therefore, charge each refrigerant piping system with additional refrigerant at the installation site. In addition, in order to carry out service, enter the size and length of each liquid pipe and additional refrigerant charge amounts in the spaces provided on the "Refrigerant amount" plate on the outdoor unit.

Calculation of additional refrigerant charge

- Calculate the additional charge using the liquid pipe size and length of the extended piping and total capacity of connected indoor units.
- Calculate the additional refrigerant charge using the procedure shown to the right, and charge with the additional refrigerant.
- For amounts less than 0.1 kg, round up the calculated additional refrigerant charge.
 (For example, if the calculated charge is 6.01 kg, round up the charge to 6.1 kg.)

<Additional Charge>

Calculation of refrigerant charge

Pipe size Liquid pipe $\phi 6.35$ (m) \times 19.0 (g/m)	+	Pipe size Liquid pipe $\phi 9.52$ (m) \times 50.0 (g/m)	+	Total capacity of connected indoor units up to 8.0 kW	Amount for the indoor units 1.5 kg
				8.1 to 16.0 kW	2.5 kg
				16.1 kW or above	3.0 kg

Included refrigerant amount when shipped from the factory

Included refrigerant amount 3.5 kg	A : $\phi 9.52$ 30 m B : $\phi 9.52$ 10 m C : $\phi 9.52$ 10 m a : $\phi 9.52$ 15 m b : $\phi 6.35$ 10 m c : $\phi 6.35$ 10 m d : $\phi 6.35$ 20 m e : $\phi 6.35$ 10 m	} At the conditions below:
<Example> Outdoor model : P140 Indoor 1 : P63 (7.1 kW) 2 : P40 (4.5 kW) 3 : P25 (2.8 kW) 4 : P20 (2.2 kW) 5 : P20 (2.2 kW)		
The total length of each liquid line is as follows: $\phi 9.52$: A + B + C + a = 65 m $\phi 6.35$: b + c + d + e = 50 m		
The total capacity of connected indoor unit is as follows: 7.1 + 4.5 + 2.8 + 2.2 + 2.2 = 18.8		
<Calculation example> Additional refrigerant charge $50 \times \frac{19.0}{1000} + 65 \times \frac{50.0}{1000} + 3.0 = 7.2 \text{ kg}$ (rounded up)		

10-2. REFRIGERANT PIPING SYSTEM (WHEN USING BRANCH BOX)

Branch box Method Connection Examples (Connecting to 8 Indoor Units)

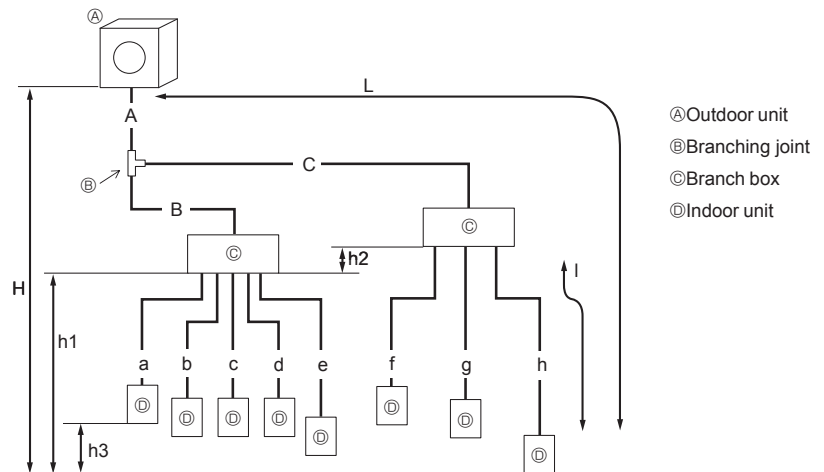

Permissible length (One-way)	Total piping length	$A + B + C + a + b + c + d + e + f + g + h \leq 120 \text{ m}$
	Farthest piping length (L)	$A + C + h \leq 80 \text{ m}$ ($A + C \leq 55 \text{ m}$, $h \leq 25 \text{ m}$)
	Piping length between outdoor unit and branch boxes	$A + B + C \leq 55 \text{ m}$
	Farthest piping length after branch box (1)	$I \leq 25 \text{ m}$
	Total piping length between branch boxes and indoor units	$a + b + c + d + e + f + g + h \leq 95 \text{ m}$
Permissible height difference (One-way)	In indoor/outdoor section (H)*	$H \leq 50 \text{ m}$ (In case of that outdoor unit is set higher than indoor unit) $H \leq 30 \text{ m}$ (In case of that outdoor unit is set lower than indoor unit)
	In branch box/indoor unit section (h1)	$h1 + h2 \leq 15 \text{ m}$
	In each branch unit (h2)	$h2 \leq 15 \text{ m}$
	In each indoor unit (h3)	$h3 \leq 12 \text{ m}$
Number of bends		≤ 15

*Branch box should be placed within the level between the outdoor unit and indoor units.

Select Each Section of Refrigerant Piping

- (1) Section From Outdoor Unit to Branch box (A, B, C) } Each Section of Piping
(2) Sections From Branch box to Indoor Unit (a to h)

Select the size from the table to the right.

(1) Refrigerant Piping Diameter In Section From Outdoor Unit to Branch box (Outdoor Unit Piping Diameter)

Model	Piping Diameter (mm)	
PUMY-SP112 PUMY-SP125 PUMY-SP140	Liquid Line	$\phi 9.52$
	Gas Line	$\phi 15.88$

(2) Refrigerant Piping Diameter In Section From Branch box to Indoor Unit (Indoor Unit Piping Diameter)

Indoor unit series	kW type	A Liquid pipe	B Gas pipe
M series or S series	15 to 42	$\phi 6.35$	$\phi 9.52$
	50	$\phi 6.35$	$\phi 12.7$
	60	$\phi 6.35$	$\phi 15.88$
	71	$\phi 9.52$	$\phi 15.88$
P series	35,50	$\phi 6.35$	$\phi 12.7$
	60 to 100	$\phi 9.52$	$\phi 15.88$

Additional refrigerant charge

Refrigerant for the extended piping is not included in the outdoor unit when the unit is shipped from the factory. Therefore, charge each refrigerant piping system with additional refrigerant at the installation site. In addition, in order to carry out service, enter the size and length of each liquid pipe and additional refrigerant charge amounts in the spaces provided on the "Refrigerant amount" plate on the outdoor unit.

Calculation of additional refrigerant charge

- Calculate the additional charge using the liquid pipe size and length of the extended piping and total capacity of connected indoor units.
- Calculate the additional refrigerant charge using the procedure shown to the right, and charge with the additional refrigerant.
- For amounts less than 0.1 kg, round up the calculated additional refrigerant charge.
(For example, if the calculated charge is 6.01 kg, round up the charge to 6.1 kg.)

<Additional Charge>

Calculation of refrigerant charge

Pipe size Liquid pipe $\phi 6.35$ (m) $\times 19.0$ (g/m)	+	Pipe size Liquid pipe $\phi 9.52$ (m) $\times 50.0$ (g/m)	+	Total capacity of connected indoor units	Amount for the indoor units
				up to 8.0 kW	1.5 kg
				8.1 to 16.0 kW	2.5 kg
				16.1 kW or above	3.0 kg

Included refrigerant amount when shipped from the factory

Included refrigerant amount
3.5 kg

<Example>

Outdoor model : P125	A : $\phi 9.52$ 30 m	} At the conditions below:
Indoor 1 : P63 (7.1 kW)	a : $\phi 9.52$ 15 m	
2 : P40 (4.5 kW)	b : $\phi 6.35$ 10 m	
3 : P25 (2.8 kW)	c : $\phi 6.35$ 10 m	
4 : P20 (2.2 kW)	d : $\phi 6.35$ 20 m	

The total length of each liquid line is as follows:

$$\phi 9.52 : A + a = 30 + 15 = 45 \text{ m}$$

$$\phi 6.35 : b + c + d = 10 + 10 + 20 = 40 \text{ m}$$

The total capacity of connected indoor unit is as follows:

$$7.1 + 4.5 + 2.8 + 2.2 = 16.6$$

<Calculation example>

Additional refrigerant charge

$$40 \times \frac{19.0}{1000} + 45 \times \frac{50.0}{1000} + 3.0 = 6.1 \text{ kg (rounded up)}$$

Mixed Method
Connection Examples
(Connecting to 1 Branch box)

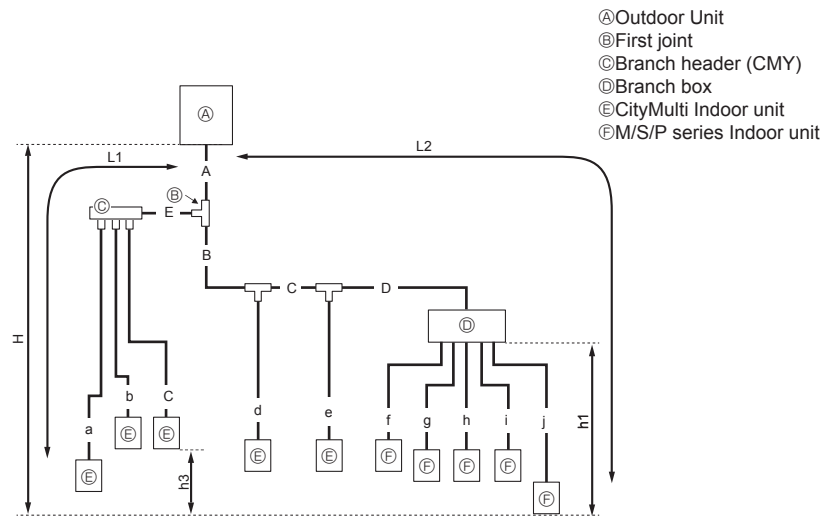

Permissible length (One-way)	Total piping length	$A+B+C+D+E+a+b+c+d+e+f+g+h+i+j \leq 120 \text{ m}$
	Farthest piping length (L1)	$A+E+a \text{ or } A+B+C+e \leq 70 \text{ m}$
	Farthest piping length. Via Branch box (L2)	$A+B+C+D+j \leq 80 \text{ m}$
	Piping length between outdoor unit and branch box	$A+B+C+D \leq 55 \text{ m}$
	Farthest piping length from the first joint	$B+C+D \text{ or } B+C+e \leq 50 \text{ m}$
	Farthest piping length after branch box	$j \leq 25 \text{ m}$
	Total piping length between branch boxes and indoor units	$f+g+h+i+j \leq 95 \text{ m}$
Permissible height difference (One-way)	In indoor/outdoor section (H)*	$H \leq 50 \text{ m}$ (In case of outdoor unit is set higher than indoor unit) $H \leq 30 \text{ m}$ (In case of outdoor unit is set lower than indoor unit)
	In branch box/indoor unit section (h1)	$h1 \leq 15 \text{ m}$
	In each indoor unit (h3)	$h3 \leq 12 \text{ m}$
Number of bends		$\leq 12 \text{ m}$

*Branch box should be placed within the level between the outdoor unit and indoor units.

■ **Selecting the Refrigerant Branch Kit**

Please select branching kit, which is sold separately, from the table below.
(The kit comprises sets for use with liquid pipes and for use with gas pipes.)

Branch header (4 branches)	Branch header (8 branches)
CMY-Y64-G-E	CMY-Y68-G-E

■ **Select Each Section of Refrigerant Piping**

- (1) Section From Outdoor Unit to Branch box or Branch header (A to E)
(2) Sections From Branch box or Branch header to Indoor Unit (a to j)
- Each Section of Piping

Select the size from the table to the right.

- (1) Refrigerant Piping Diameter In Section From Outdoor Unit to Branch box or Branch header (Outdoor Unit Piping Diameter)

Model	Piping Diameter (mm)	
PUMY-SP112 PUMY-SP125 PUMY-SP140	Liquid Line	$\phi 9.52$
	Gas Line	$\phi 15.88$

- (2) Refrigerant Piping Diameter In Section From Branch box or Branch header to Indoor Unit (Indoor Unit Piping Diameter)

Indoor unit series	kW type	A Liquid pipe	B Gas pipe
CityMulti	15 to 50	$\ell \leq 30 \text{ m}$ $\phi 6.35$	$\phi 12.7$
		$\ell > 30 \text{ m}$ $\phi 9.52$	
M series or S series	63 to 140	$\phi 9.52$	$\phi 15.88$
	22 to 42	$\phi 6.35$	$\phi 9.52$
	50	$\phi 6.35$	$\phi 12.7$
P series	60	$\phi 6.35$	$\phi 15.88$
	71	$\phi 9.52$	$\phi 15.88$
	35,50	$\phi 6.35$	$\phi 12.7$
	60 to 100	$\phi 9.52$	$\phi 15.88$

Note:
When connecting the CONNECTION KIT (PAC-LV11M-J) and an M-series indoor unit, refer to the installation manual for the CONNECTION KIT when selecting the pipe size and piping length.

■ **Additional refrigerant charge**

Refer to the same section in the previous page.

Mixed Method
Connection Examples
(Connecting to 2 Branch boxes)

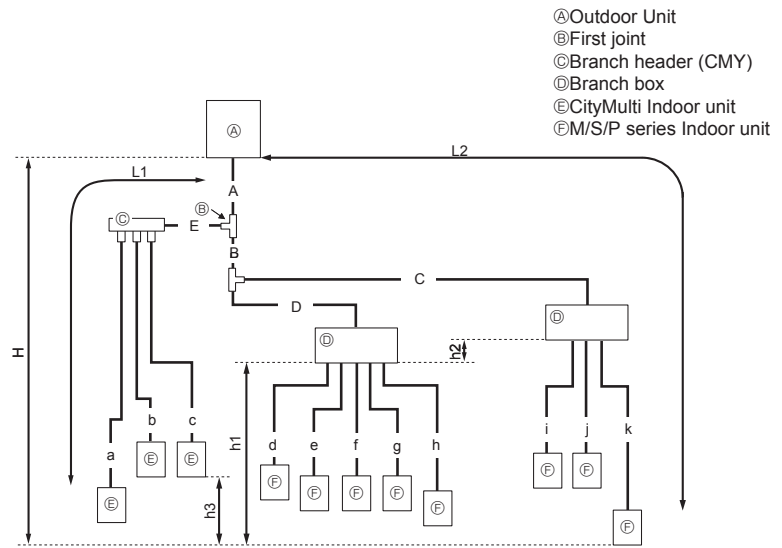

Permissible length (One-way)	Total piping length	$A+B+C+D+E+a+b+c+d+e+f+g+h+i+j+k \leq 120$ m
	Farthest piping length (L1)	$A+E+a \leq 70$ m
	Farthest piping length. Via Branch box (L2)	$A+B+C+k \leq 80$ m
	Piping length between outdoor unit and branch boxes	$A+B+C+D \leq 55$ m
	Farthest piping length from the first joint	$B+C$ or $E+a \leq 50$ m
	Farthest piping length after branch box	$k \leq 25$ m
	Farthest branch box form outdoor unit	$A+B+C \leq 55$ m
	Total piping length between branch boxes and indoor units	$d+e+f+g+h+i+j+k \leq 95$ m
Permissible height difference (One-way)	In indoor/outdoor section (H)*	$H \leq 50$ m (In case of outdoor unit is set higher than indoor unit) $H \leq 30$ m (In case of outdoor unit is set lower than indoor unit)
	In branch box/indoor unit section (h1)	$h1+h2 \leq 15$ m
	In each branch unit (h2)	$h2 \leq 15$ m
	In each indoor unit (h3)	$h3 \leq 12$ m
Number of bends		≤ 15

*Branch box should be placed within the level between the outdoor unit and indoor units.

■ **Selecting the Refrigerant Branch Kit**

Please select branching kit, which is sold separately, from the table below.
(The kit comprises sets for use with liquid pipes and for use with gas pipes.)

Branch header (4 branches)	Branch header (8 branches)
CMY-Y64-G-E	CMY-Y68-G-E

■ **Select Each Section of Refrigerant Piping**

- (1) Section From Outdoor Unit to Branch box or Branch header (A to E)
(2) Sections From Branch box or Branch header to Indoor Unit (a to k)
- } Each Section of Piping

Select the size from the table to the right.

(1) Refrigerant Piping Diameter In Section From Outdoor Unit to Branch box or Branch header (Out-door Unit Piping Diameter)

Model	Piping Diameter (mm)	
PUMY-SP112 PUMY-SP125 PUMY-SP140	Liquid Line	$\phi 9.52$
	Gas Line	$\phi 15.88$

(2) Refrigerant Piping Diameter In Section From Branch box or Branch header to Indoor Unit (Indoor Unit Piping Diameter)

Indoor unit series	kW type	A Liquid pipe	B Gas pipe
CityMulti	15 to 50	$l \leq 30$ m $\phi 6.35$	$\phi 12.7$
		$l > 30$ m $\phi 9.52$	
	63 to 140	$\phi 9.52$	$\phi 15.88$
M series or S series	22 to 42	$\phi 6.35$	$\phi 9.52$
	50	$\phi 6.35$	$\phi 12.7$
	60	$\phi 6.35$	$\phi 15.88$
	71	$\phi 9.52$	$\phi 15.88$
P series	35,50	$\phi 6.35$	$\phi 12.7$
	60 to 100	$\phi 9.52$	$\phi 15.88$

Note:
When connecting the CONNECTION KIT (PAC-LV11M-J) and an M-series indoor unit, refer to the installation manual for the CONNECTION KIT when selecting the pipe size and piping length.

■ **Additional refrigerant charge**

Refer to the same section in the previous page.

10-3. PRECAUTIONS AGAINST REFRIGERANT LEAKAGE

10-3-1. Introduction

R410A refrigerant of this air conditioner is non-toxic and non-flammable but leaking of large amount from an indoor unit into the room where the unit is installed may be deleterious. To prevent possible injury, the rooms should be large enough to keep the R410A concentration specified by ISO 5149-1 as follows.

Maximum concentration
 Maximum refrigerant concentration of R410A of a room is 0.44kg/m³ accordance with ISO 5149-1.
 To facilitate calculation, the maximum concentration is expressed in units of kg/m³ (kg of R410A per m³)
Maximum concentration of R410A: 0.44 kg/m³
 (ISO 5149-1)

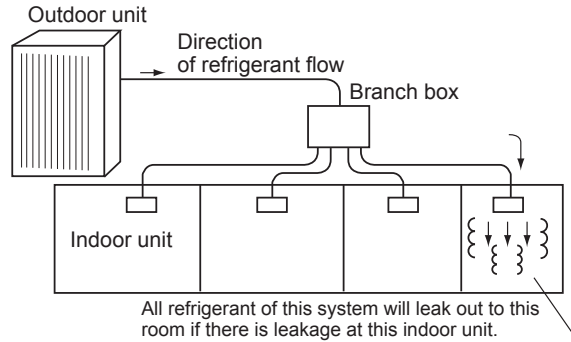

10-3-2. Confirming procedure of R410A concentration

Follow (1) to (3) to confirm the R410A concentration and take appropriate treatment, if necessary.

(1) Calculate total refrigerant amount by each refrigerant system. Total refrigerant amount is pre-charged refrigerant at ex-factory plus additional charged amount at field installation.

Note:
 When single refrigeration system consists of several independent refrigeration circuit, figure out the total refrigerant amount by each independent refrigerant circuit.

(2) Calculate room volumes (m³) and find the room with the smallest volume

The part with represents the room with the smallest volume.

(a) Situation in which there are no partitions

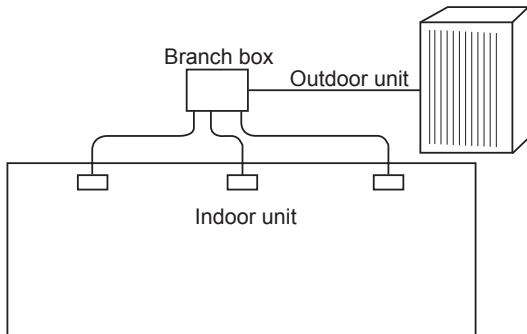

(b) There are partitions, but there are openings that allow the effective mixing of air.

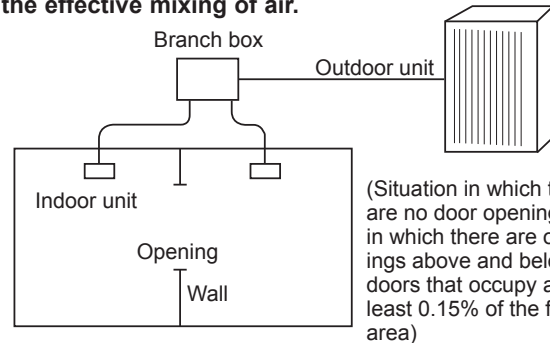

(c) If the smallest room has mechanical ventilation apparatus that is linked to a household gas detection and alarm device, the calculations should be performed for the second smallest room.

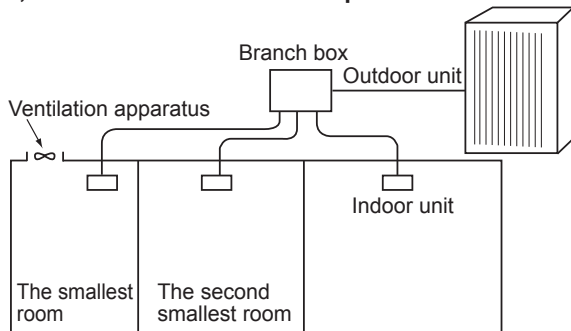

(3) Use the results of calculations (1) and (2) to calculate the refrigerant concentration:

$$\frac{\text{Total refrigerant in the refrigerating unit (kg)}}{\text{The smallest room in which an indoor unit has been installed (m}^3\text{)}} \leq \text{Maximum concentration (kg/m}^3\text{)}$$

The smallest room in which an indoor unit has been installed (m³)

Maximum concentration of R410A: 0.44kg/m³

If the calculation results do not exceed the maximum concentration, perform the same calculations for the larger second and third room, etc., until it has been determined that nowhere the maximum concentration will be exceeded.

PUMY-SP112VKM.TH
 PUMY-SP112YKM.TH
 PUMY-SP112VKM.TH-BS
 PUMY-SP112YKM.TH-BS

PUMY-SP125VKM.TH
 PUMY-SP125YKM.TH
 PUMY-SP125VKM.TH-BS
 PUMY-SP125YKM.TH-BS

PUMY-SP140VKM.TH
 PUMY-SP140YKM.TH
 PUMY-SP140VKM.TH-BS
 PUMY-SP140YKM.TH-BS

OPERATING PROCEDURE

1. Removing the service panel and the top panel

- (1) Remove 3 service panel fixing screws (5 × 12), and slide the hook on the right downward to remove the service panel.
- (2) Remove screws (2 for front, 3 for rear/5 × 12) of the top panel and remove it.

PHOTOS

Photo 1

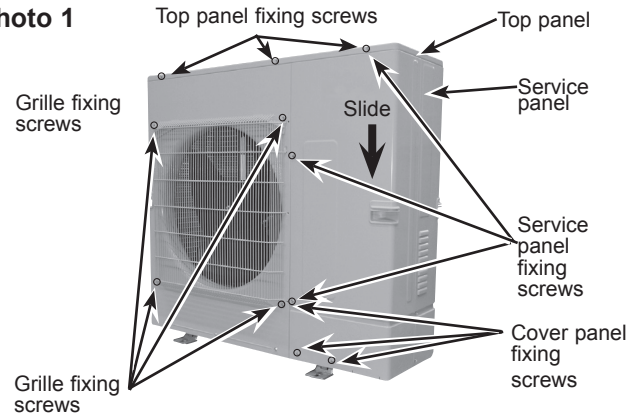

2. Removing the fan motor (MF1)

- (1) Remove the service panel. (See Photo 1)
- (2) Remove the top panel. (See Photo 1)
- (3) Remove 4 fan grille fixing screws (5 × 12) to detach the fan grille. (See Photo 1)
- (4) Remove a nut (for right handed screw of M6) to detach the propeller. (See Photo 2)
- (5) Disconnect the connector CNF1 on the multi controller circuit board in the electrical parts box. (See Photo 4)
- (6) Loosen a clamp on the side of the motor support. (See Photo 3)
- (7) Remove 4 fan motor fixing screws (5 × 20) to detach the fan motor. (See Photo 3)

Note: Tighten the propeller fan with a torque of 5.7 ± 0.3 N·m.

Photo 2

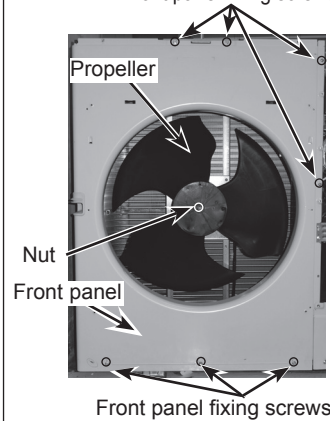
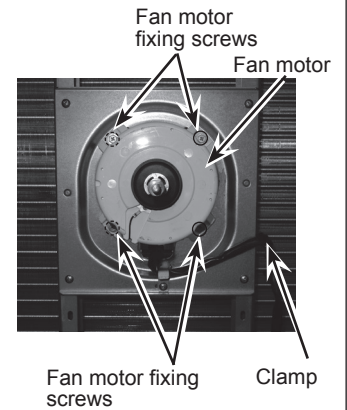

Photo 3



3. Removing the electrical parts box

- (1) Remove the service panel. (See Photo 1)
- (2) Remove the top panel. (See Photo 1)
- (3) Disconnect the connecting wire from terminal block. (See Photo 5 for VKM type, or Photo 7 for YKM type)
- (4) Disconnect the connector CNF1, 4-way valve coil, LEV-A and LEV-B on the multi controller circuit board. <Symbols on the board>
 - CNF1: Fan motor
 - LEV-A: LEV
 - LEV-B: LEV
 - 21S4: 4-way valve coil
 - 63HS: Pressure sensor
 - SV1: Solenoid valve coil
 - 63H: Pressure switch
 - 63LS: Pressure sensor
- (5) Disconnect the pipe-side connections of the following parts:
 - Thermistor <HIC> (TH2)
 - Thermistor <Compressor> (TH4)
 - Thermistor <Liquid> (TH3)
 - Thermistor <Suction> (TH6)
 - Thermistor <Ambient> (TH7)
- (6) Remove the comp felt (top).
- (7) Remove a nut from the terminal cover to remove the cover, and disconnect the compressor lead wire. (See Photo 11)
- (8) Remove 2 electrical parts box fixing screws (4 × 10), and detach the electrical parts box by pulling upward. The electrical parts box is fixed with 2 hooks on the left and 1 hook on the right.

Photo 4

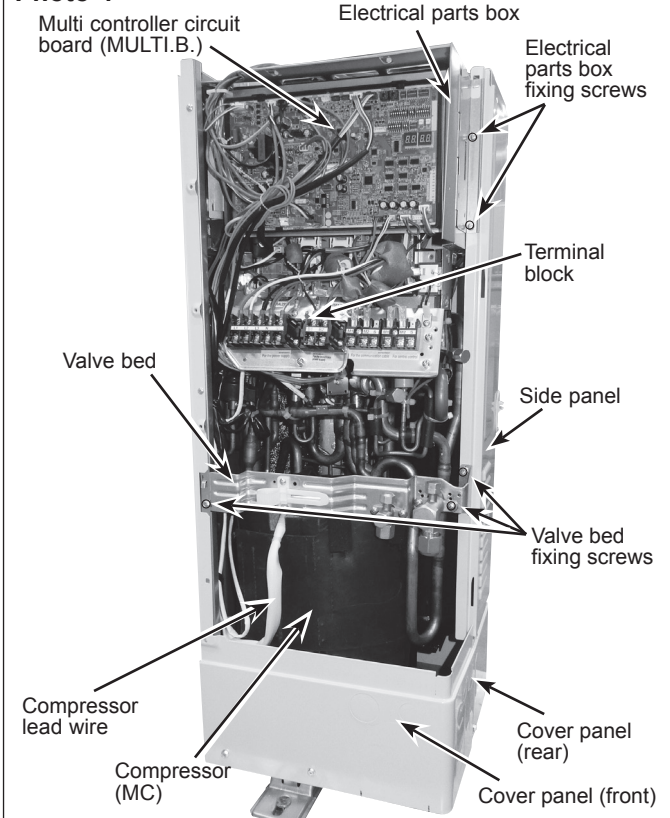

OPERATING PROCEDURE

4. Disassembling the electrical parts box (VKM type)

- (1) Disconnect all the connectors on the multi controller circuit board.
- (2) Remove 2 screws ① which fix the plate holding the multi controller circuit board and the electrical parts box. (See Photo 5)
- (3) Remove the multi controller circuit board. (See Photo 5)
- (4) Disconnect the M-NET power board connector on the back plate of the controller circuit board.
- (5) Disconnect the connectors of reactor on the back plate of the electrical parts box. (See Photo 6)
- (6) Remove 2 screws ② on the back plate of the electrical parts box. (See Photo 6)
- (7) Remove the 3 reactors. (See Photo 6)

Note 1: When reassembling the electrical parts box, make sure that the wirings are correct.

Note 2: When exchanging the reactor, make sure to exchange all the 3 reactors.

5. Disassembling the electrical parts box (YKM type)

- (1) Disconnect all the connectors on the multi controller circuit board.
- (2) Remove 2 screws ① which fix the plate holding the multi controller circuit board and the electrical parts box.
- (3) Remove the multi controller circuit board. (See Photo 7.)
- (4) Disconnect the M-NET power board connector on the back plate of the controller circuit board.
- (5) Disconnect all the connectors on the noise filter circuit board. (See Photo 8)
- (6) Remove 9 supports on the noise filter circuit board. (See Photo 8)
- (7) Remove the noise filter circuit board. (See Photo 9)
- (8) Remove the noise filter plate fixing screws. (See Photo 9)
- (9) Disconnect the connectors of reactor on the bottom plate of the electrical parts box. (See Photo 9)
- (10) Remove 4 screws ② on the bottom plate of the electrical parts box. (See Photo 9)
- (11) Remove the reactor. (See Photo 9)

Note : When reassembling the electrical parts box, make sure that the wirings are correct.

PHOTOS

Photo 5

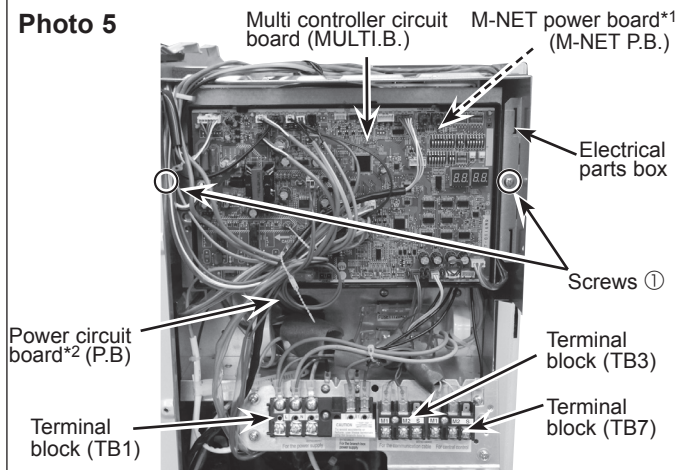
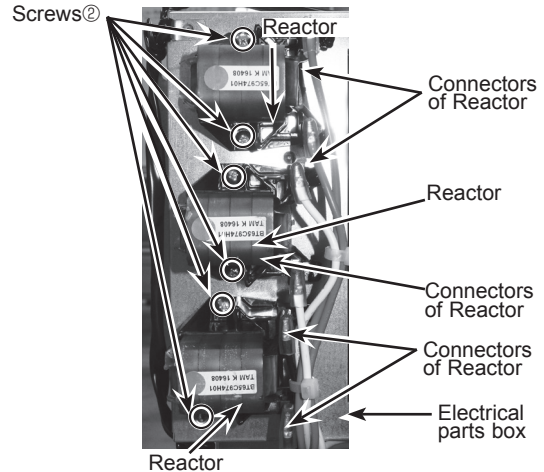

Photo 6



*1 The M-NET power board is installed behind the multi controller circuit board.
*2 The power circuit board is installed behind the multi controller circuit board.

Photo 7

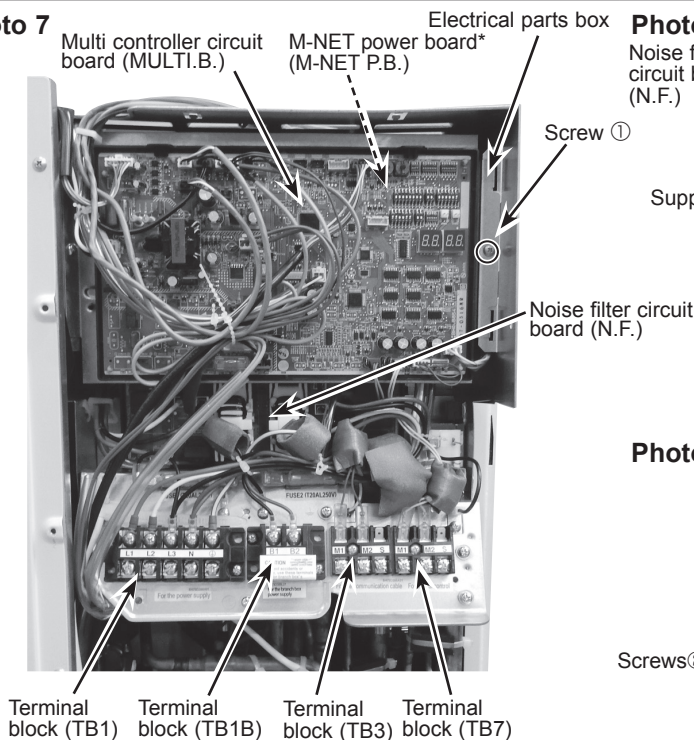

Photo 8

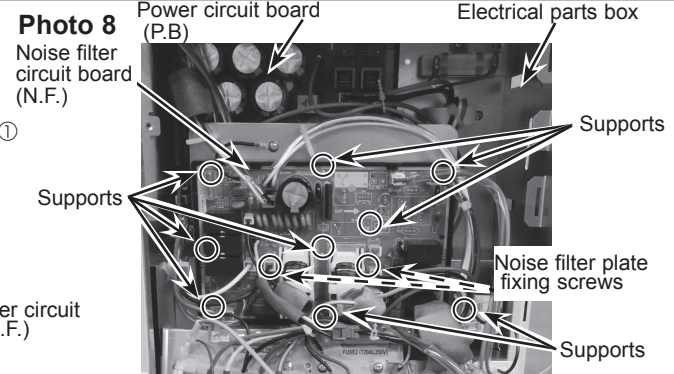
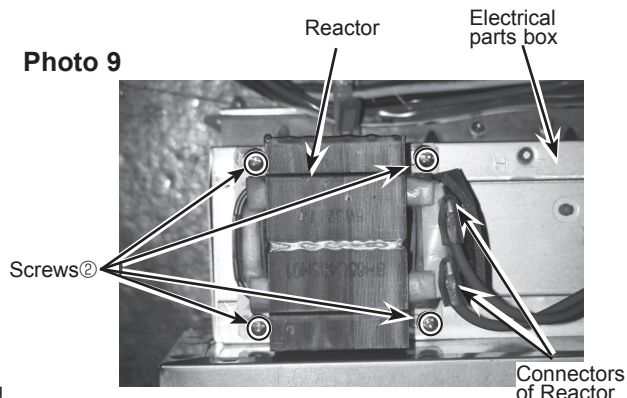
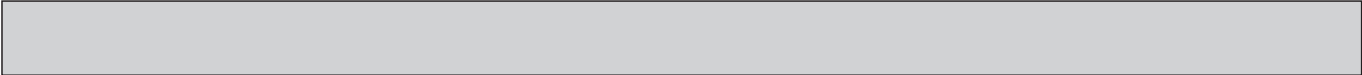
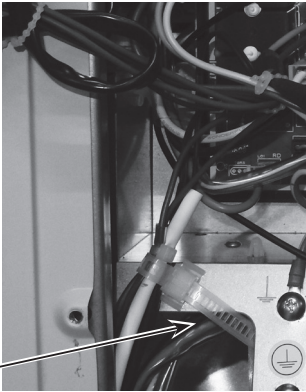
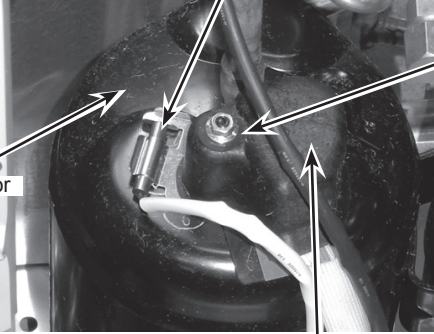

Photo 9



* The M-NET power board is installed behind the multi controller circuit board.



OPERATING PROCEDURE	PHOTOS
<p>6. Removing the thermistor <HIC> (TH2) and the thermistor <Compressor> (TH4)</p> <p>(1) Remove the service panel. (See Photo 1)</p> <p>(2) Remove the top panel. (See Photo 1)</p> <p>(3) Disconnect the following connectors on the controller circuit board in the electrical parts box.</p> <ul style="list-style-type: none">• TH2: Black• TH4: White <p>[Removing the thermistor <HIC> (TH2)]</p> <p>(4) Loosen the fastener fixing the connector to the electrical parts box. (See Photo 10)</p> <p>(5) Pull out the thermistor <HIC> (TH2) from the sensor holder. (See Photo 13)</p> <p>[Removing the thermistor <Compressor> (TH4)]</p> <p>(4) Loosen the fastener fixing the connector to the electrical parts box. (See Photo 10)</p> <p>(5) Remove the comp felt (top).</p> <p>(6) Pull out the thermistor <Compressor> (TH4) from the sensor holder. (See Photo 11)</p>	<p>Photo 10</p>  <p>Fastener</p>
<p>7. Removing the thermistor <Liquid> (TH3), the thermistor <Suction> (TH6), and thermistor <Ambient> (TH7)</p> <p>(1) Remove the service panel. (See Photo 1.)</p> <p>(2) Remove the top panel. (See Photo 1.)</p> <p>(3) Remove the side panel (R) by removing the following screws:</p> <ul style="list-style-type: none">• Electrical parts box fixing screws (4 × 12): 2 pieces• Valve bed fixing screws (5 × 12): 2 pieces• Side panel fixing screw on the right side of the panel (5 × 12): 1 piece• Side panel fixing screw in the rear of the panel (5 × 12): 3 pieces <p>(4) Disconnect the following connectors on the multi controller circuit board in the electrical parts box.</p> <ul style="list-style-type: none">• TH3: White• TH6/7: Red <p>(5) Loosen the fastener fixing the connector to the electrical parts box. (See Photo 10)</p> <p>(6) Pull out each thermistor from the sensor holder. (See Photo 12, 13)</p> <p>Note: When replacing thermistor <Ambient> (TH7), replace it together with thermistor <Suction> (TH6), since they are combined together.</p>	<p>Photo 11</p>  <p>Thermistor <Compressor> (TH4)</p> <p>Nut</p> <p>Compressor</p> <p>Terminal cover</p>

OPERATING PROCEDURE

8. Removing LEV coil

[LEV-A]

- (1) Remove the service panel. (See Photo 1)
- (2) Disconnect the connector CNL VA (WH) on the multi controller circuit board in the electrical parts box.
- (3) Remove the LEV coil by sliding the coil upward. (See Photo 13)

[LEV-B]

- (1) Remove the service panel. (See Photo 1)
- (2) Disconnect the connector CNL VB (RD) on the multi controller circuit board in the electrical parts box.
- (3) Remove the LEV coil by sliding the coil upward. (See Photo 13)

9. Removing LEV

- (1) Remove the service panel. (See Photo 1)
- (2) Remove the top panel. (See Photo 1)
- (3) Remove the electrical parts box. (Refer to procedure 3)
- (7) Remove the LEV coil. (Refer to procedure 8)
- (8) Recover refrigerant.
- (9) Remove the welded part of LEV.

Note 1: Recover refrigerant without spreading it in the air.

Note 2: The welded part can be removed easily by removing the right side panel.

Note 3: When installing the LEV, cover it with a wet cloth to prevent it from heating (120°C or more), then braze the pipes so that the inside of pipes are not oxidized.

PHOTOS

Photo 12

Thermistor <Ambient> (TH7)

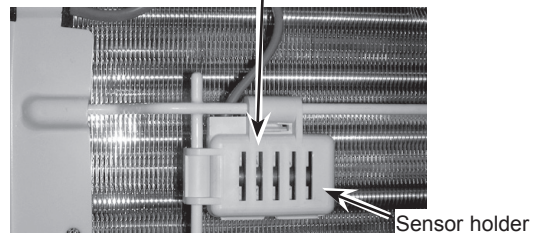

Photo 13

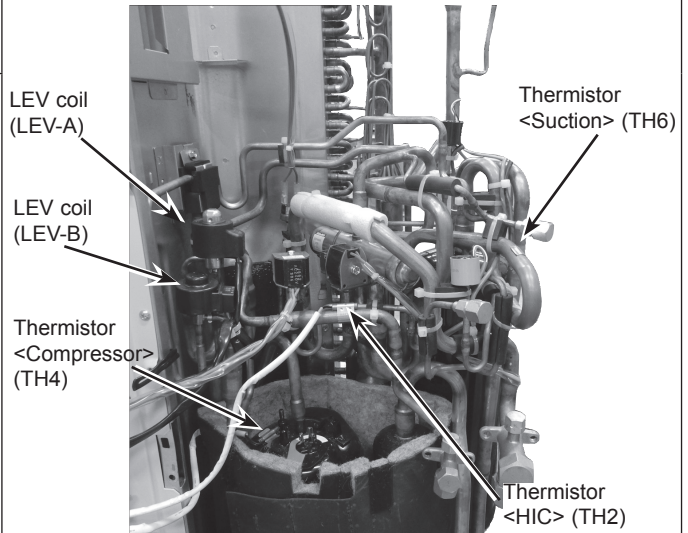
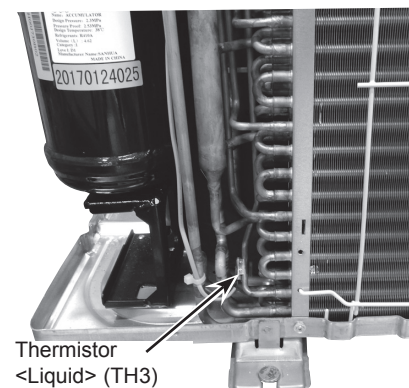
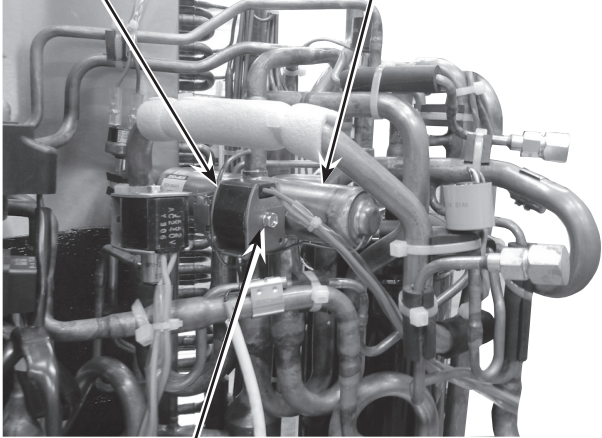

Photo 14





OPERATING PROCEDURE	PHOTOS
<p>10. Removing the 4-way valve coil (21S4) (1) Remove the service panel. (See Photo 1)</p> <p>[Removing the 4-way valve coil] (2) Remove 4-way valve coil fixing screw (M5 × 7). (3) Remove the 4-way valve coil by sliding the coil toward you. (4) Disconnect the connector 21S4 (green) on the outdoor multi controller circuit board in the electrical parts box.</p>	<p>Photo 15</p>  <p>4-way valve coil (21S4) 4-way valve</p> <p>4-way valve coil fixing screw</p>
<p>11. Removing the 4-way valve (1) Remove the service panel. (See Photo 1) (2) Remove the top panel. (See Photo 1) (3) Remove the electrical parts box (See Photo 4) (4) Remove 3 valve bed fixing screws (5 × 12) and 4 stop valve fixing screws (5 × 16) and then remove the valve bed. (See Photo 4) (5) Remove 4 right side panel fixing screw (5 × 12) in the rear of the unit and then remove the right side panel. (6) Remove the 4-way valve coil. (See Photo 15) (7) Recover refrigerant. (8) Remove the welded part of 4-way valve.</p> <p>Note 1: Recover refrigerant without spreading it in the air. Note 2: The welded part can be removed easily by removing the right side panel. Note 3: When installing the 4-way valve, cover it with a wet cloth to prevent it from heating (120°C or more), then braze the pipes so that the inside of pipes are not oxidized.</p>	

OPERATING PROCEDURE

12. Removing the solenoid valve coil (SV1) and the solenoid valve

- (1) Remove the service panel. (See Photo 1)
- (2) Remove the top panel. (See Photo 1)
- (3) Disconnect the connector SV1 (Gray) on the multi controller circuit board in the electrical parts box.
- (4) Remove the electrical parts box. (Refer to procedure 3)
- (5) Remove the solenoid valve coil fixing screw (M4 ×6).
- (6) Remove the solenoid valve coil by sliding the coil upward.
- (7) Recover refrigerant.
- (8) Remove the welded part of solenoid valve.

Note 1: Recover refrigerant without spreading it in the air.

Note 2: When installing the solenoid valve, cover it with a wet cloth to prevent it from heating (120°C or more), then braze the pipes so that the inside of pipes are not oxidized.

13. Removing the high pressure switch (63H) and the high pressure sensor (63HS)

- (1) Remove the service panel. (See Photo 1)
- (2) Remove the top panel. (See Photo 1)
- (3) Remove the electrical parts box. (See Photo 5)
- (4) Remove the side panel (R). (Refer to the procedure 7 (3))
- (5) Pull out the 2 lead wire of the high pressure switch.
- (6) Recover refrigerant.
- (7) Remove the welded part of high pressure switch and high pressure sensor.

Note 1: Recover refrigerant without spreading it in the air.

Note 2: The welded part can be removed easily by removing the right side panel.

Note 3: When installing the high pressure switch and high pressure sensor, cover them with a wet cloth to prevent them from heating (100°C or more), then braze the pipes so that the inside of pipes are not oxidized.

14. Removing the low pressure sensor (63LS)

- (1) Remove the service panel. (See Photo 1)
- (2) Remove the top panel. (See Photo 1)
- (3) Remove the side panel (R). (Refer to the procedure 7 (3))
- (4) Disconnect the connector 63LS (blue) on the multi controller circuit board in the electrical parts box.
- (5) Loosen the clamps, which are fixing the low pressure sensor lead wire to the top of the electrical parts box. (See Photo 15)
- (6) Recover refrigerant.
- (7) Remove the welded part of low pressure sensor.

Note 1: Recover refrigerant without spreading it in the air.

Note 2: The welded part can be removed easily by removing the right side panel.

Note 3: When installing the low pressure sensor, cover it with a wet cloth to prevent it from heating (100°C or more), then braze the pipes so that the inside of pipes are not oxidized.

PHOTOS

Photo 16

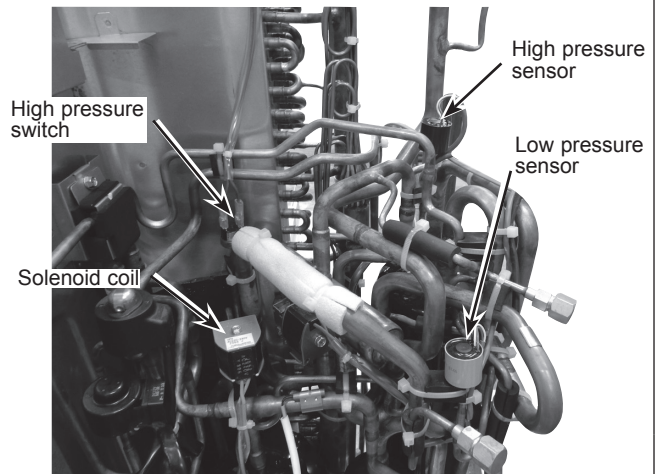
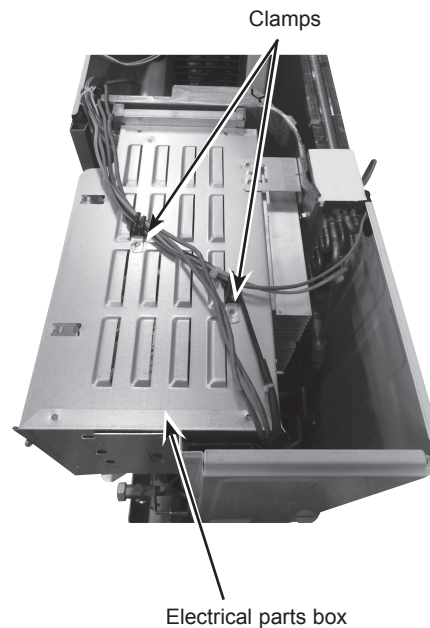

Photo 17



OPERATING PROCEDURE

15. Removing the compressor (MC)

- (1) Remove the service panel. (See Photo 1.)
- (2) Remove the top panel. (See Photo 1.)
- (3) Remove the electrical parts box. (See Photo 5)
- (4) Remove the valve bed by removing the following screws:
 - Valve bed fixing screws (5 × 12): 3 pieces
 - Stop valve fixing screws (5 × 16): 4 pieces
- (5) Remove 2 cover panel (front) fixing screws (5 × 12) to remove the cover panel (front).
- (6) Remove 5 cover panel (rear) fixing screws (5 × 12) to remove the cover panel (rear).
- (7) Remove 3 side panel (R) fixing screws in the rear of the panel (5 × 12) and remove the side panel (R).
- (8) Remove the comp felt (top) and (body).
- (9) Remove the nut on the terminal cover to remove the terminal cover, and remove the compressor lead wire. (See Photo18)
- (10) Remove the thermistor <Compressor> (TH4).
- (11) Recover refrigerant.
- (12) Remove the welded pipe of compressor inlet and outlet.
- (13) Remove 3 compressor fixing nuts.

Note 1: Recover refrigerant without spreading it in the air.

Note 2: When reconnecting the compressor wirings, ensure that the connection is correct: Check the color of the wiring and the label on the terminal block, and connect properly.

16. Removing the accumulator

- (1) Remove the service panel. (See Photo 1.)
- (2) Remove the top panel. (See Photo 1.)
- (3) Remove the electrical parts box. (See Photo 5)
- (4) Remove the valve bed. (Refer to the procedure 15 (4))
- (5) Remove 2 cover panel (front). (Refer to the procedure 15 (5))
- (6) Remove 2 cover panel (rear). (Refer to the procedure 15 (6))
- (7) Remove 3 side panel (R). (Refer to the procedure 15 (7))
- (8) Recover refrigerant.
- (9) Remove the welded pipe of accumulator inlet and outlet.
- (10) Remove 2 accumulator fixing screws. (See Photo18)

Note: Recover refrigerant without spreading it in the air.

PHOTOS

Photo 18

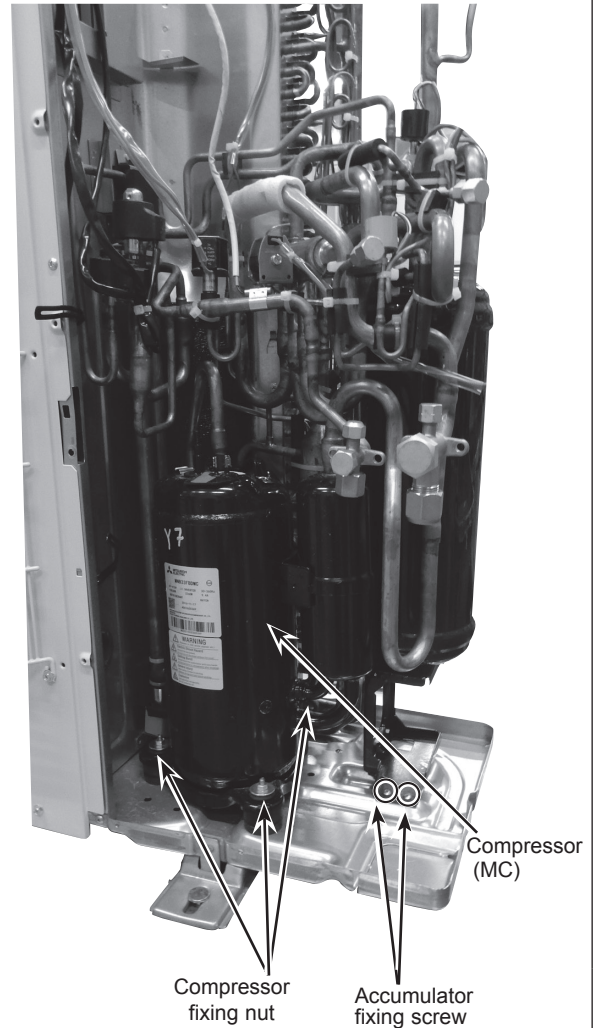

CITY MULTI

MITSUBISHI ELECTRIC CORPORATION

HEAD OFFICE : TOKYO BUILDING, 2-7-3, MARUNOUCHI, CHIYODA-KU, TOKYO100-8310, JAPAN
