

## OUTDOOR UNITS

1. SPECIFICATIONS .....	2 - 8
2. EXTERNAL DIMENSIONS .....	2 - 12
3. CENTER OF GRAVITY .....	2 - 13
4. ELECTRICAL WIRING DIAGRAMS .....	2 - 14
5. REFRIGERANT CIRCUIT DIAGRAMS .....	2 - 16
6. SOUND LEVELS .....	2 - 17
7. CAPACITY TABLES .....	2 - 18
7-1. Correction by temperature .....	2 - 18
7-2. Correction by total indoor.....	2 - 20
7-3. Correction by refrigerant piping length.....	2 - 22
7-4. Correction at frost and defrost .....	2 - 23
7-5. Operation temperature range .....	2 - 23
8. OPTIONAL PARTS.....	2 - 24
8-1. JOINT .....	2 - 24
8-2. HEADER.....	2 - 25

# 1. SPECIFICATIONS

DATA G6

Model		PUMY-P100YHMB		PUMY-P125YHMB		
Power source		3-phase 4-wire 380-400-415V 50Hz		3-phase 4-wire 380-400-415V 50Hz		
Cooling capacity (Nominal)	*1 kW	11.2		14.0		
	*1 kcal / h	9,600		12,000		
	*1 BTU / h	38,200		47,800		
	Power input	kW	3.30		4.27	
	Current input	A	5.28-5.02-4.84		6.83-6.49-6.26	
	COP	kW / kW	3.39		3.28	
Temp. range of cooling	Indoor	W.B.	15 to 24degC(59 to 75degF)		15 to 24degC(59 to 75degF)	
	Outdoor	D.B.	-5 to 46degC(23 to 115degF) 10 to 46degC(50 to 115degF) : in case of connecting PKFY-P15/P20/P25 type indoor unit.		-5 to 46degC(23 to 115degF) 10 to 46degC(50 to 115degF) : in case of connecting PKFY-P15/P20/P25 type indoor unit.	
Heating capacity (Nominal)	*2 kW	12.5		16.0		
	*2 kcal / h	10,800		13,800		
	*2 BTU / h	42,700		54,600		
	Power input	kW	3.63		4.29	
	Current input	A	5.81-5.52-5.32		6.87-6.52-6.29	
	COP	kW / kW	3.44		3.73	
Temp. range of heating	Indoor	D.B.	15 to 27degC(59 to 81degF)		15 to 27degC(59 to 81degF)	
	Outdoor	W.B.	-15 to 15degC(5 to 59degF)		-15 to 15degC(5 to 59degF)	
Indoor unit connectable	Total capacity	50 to 130 % of outdoor unit capacity		50 to 130 % of outdoor unit capacity		
	Model / Quantity	P15 to P125 / 1 to 8		P15 to P140 / 1 to 10		
Sound pressure level (measured in anechoic room)		dB <A>	49 / 51		50 / 52	
Refrigerant piping diameter	Liquid pipe	mm(in.)	9.52(3/8) Flare		9.52(3/8) Flare	
	Gas pipe	mm(in.)	15.88(5/8) Flare		15.88(5/8) Flare	
FAN	Type x Quantity		Propeller fan x 2		Propeller fan x 2	
	Air flow rate	m <sup>3</sup> / min	100		100	
		L/s	1,667		1,667	
		cfm	3,532		3,532	
	Control, Driving mechanism		DC-control, Direct-driven by motor		DC-control, Direct-driven by motor	
	Motor output	kW	0.06 x 2		0.06 x 2	
External static press.		0 Pa (0 mmH <sub>2</sub> O)		0 Pa (0 mmH <sub>2</sub> O)		
Compressor	Type x Quantity		Inverter scroll hermetic compressor		Inverter scroll hermetic compressor	
	Manufacture		MITSUBISHI ELECTRIC CORPORATION		MITSUBISHI ELECTRIC CORPORATION	
	Starting method		Inverter		Inverter	
	Motor output	kW	1.9		2.4	
	Case heater	kW	-		-	
Lubricant		FV50S		FV50S		
External finish		Galvanized steel sheets <MUNSELL 3Y 7.8/1.1>		Galvanized steel sheets <MUNSELL 3Y 7.8/1.1>		
External dimension HxWxD	mm	1,350 x 950 x 330		1,350 x 950 x 330		
	in.	53-3/16 x 37-7/16 x 13		53-3/16 x 37-7/16 x 13		
Protection devices	High pressure protection		High pressure sensor, High pressure switch at 4.15MPa (601 psi)		High pressure sensor, High pressure switch at 4.15MPa (601 psi)	
	Inverter circuit (COMP. / FAN)		Over-heat protection, Over-current protection		Over-heat protection, Over-current protection	
	Compressor		Discharge thermo protection, Over-current protection		Discharge thermo protection, Over-current protection	
	Fan motor		Over-heat protection, Voltage protection		Over-heat protection, Voltage protection	
Refrigerant	Type x original charge		R410A x 8.5kg (19lbs)		R410A x 8.5kg (19lbs)	
	Control		LEV circuit		LEV circuit	
Net weight		kg(lbs)	142(312)		142(312)	
Heat exchanger		Salt-resistant cross fin & copper tube		Salt-resistant cross fin & copper tube		
HIC circuit (HIC: Heat Inter-Changer)		-		-		
Defrosting method		Auto-defrost mode (Reversed refrigerant cycle)		Auto-defrost mode (Reversed refrigerant cycle)		
Drawing	External	YHM-BK01-B328		YHM-BK01-B328		
	Wiring	YHM-RG79-V705		YHM-RG79-V705		
Standard attachment	Document	Installation Manual		Installation Manual		
	Accessory	Grounded lead wire x 2		Grounded lead wire x 2		
Optional parts		Joint: CMY-Y62-G-E Header: CMY-Y64/68-G-E		Joint: CMY-Y62-G-E Header: CMY-Y64/68-G-E		
Remarks		* Details on foundation work, duct work, insulation work, electrical wiring, power source switch, and other items shall be referred to the Installation Manual. * Due to continuing improvement, above specifications may be subject to change without notice.				

Notes :	Unit converter
*1.Nominal cooling conditions(subject to JIS B8615-1) Indoor : 27degCDB/19degCWB(81degFDB/66degFWB), Outdoor : 35degCDB(95degFDB) Pipe length : 7.5m(24-9/16ft.), Level difference : 0m(0ft.)	kcal =kW x 860 BTU/h =kW x 3,412
*2.Nominal heating conditions(subject to JIS B8615-1) Indoor : 20degCDB(68degFDB), Outdoor : 7degCDB/6degCWB(45degFDB/43degFWB) Pipe length : 7.5m(24-9/16ft.), Level difference : 0m(0ft.)	cfm =m <sup>3</sup> /min x 35.31 lb =kg / 0.4536
	*Above specification data is subject to rounding variation.

# 1. SPECIFICATIONS

Model		PUMY-P140YHMB	
Power source		3-phase 4-wire 380-400-415V 50Hz	
Cooling capacity (Nominal)	*1 kW	15.5	
	*1 kcal / h	13,300	
	*1 BTU / h	52,900	
	Power input	kW	5.32
	Current input	A	8.51-8.09-7.80
	COP	kW / kW	2.91
Temp. range of cooling	Indoor	W.B.	15 to 24degC(59 to 75degF)
	Outdoor	D.B.	-5 to 46degC(23 to 115degF) 10 to 46degC(50 to 115degF) : in case of connecting PKFY-P15/P20/P25 type indoor unit.
Heating capacity (Nominal)	*2 kW	18.0	
	*2 kcal / h	15,500	
	*2 BTU / h	61,400	
	Power input	kW	5.32
	Current input	A	8.51-8.09-7.80
	COP	kW / kW	3.38
Temp. range of heating	Indoor	D.B.	15 to 27degC(59 to 81degF)
	Outdoor	W.B.	-15 to 15degC(5 to 59degF)
Indoor unit connectable	Total capacity	50 to 130 % of outdoor unit capacity	
	Model / Quantity	P15 to P140 / 1 to 12	
Sound pressure level (measured in anechoic room)		dB <A>	51 / 53
Refrigerant piping diameter	Liquid pipe	mm(in.)	9.52(3/8) Flare
	Gas pipe	mm(in.)	15.88(5/8) Flare
FAN	Type x Quantity		Propeller fan x 2
	Air flow rate	m <sup>3</sup> / min	100
		L/s	1,667
		cfm	3,532
	Control, Driving mechanism		DC-control, Direct-driven by motor
	Motor output	kW	0.06 x 2
External static press.		0 Pa (0 mmH <sub>2</sub> O)	
Compressor	Type x Quantity		Inverter scroll hermetic compressor
	Manufacture		MITSUBISHI ELECTRIC CORPORATION
	Starting method		Inverter
	Motor output	kW	2.9
	Case heater	kW	-
Lubricant		FV50S	
External finish		Galvanized steel sheets <MUNSELL 3Y 7.8/1.1>	
External dimension HxWxD	mm		1,350 x 950 x 330
	in.		53-3/16 x 37-7/16 x 13
Protection devices	High pressure protection		High pressure sensor, High pressure switch at 4.15MPa (601 psi)
	Inverter circuit (COMP. / FAN)		Over-heat protection,Over-current protection
	Compressor		Discharge thermo protection,Over-current protection
	Fan motor		Over-heat protection,Voltage protection
Refrigerant	Type x original charge		R410A x 8.5kg (19lbs)
	Control		LEV circuit
Net weight	kg(lbs)	142(312)	
Heat exchanger		Salt-resistant cross fin & copper tube	
HIC circuit (HIC: Heat Inter-Changer)		-	
Defrosting method		Auto-defrost mode (Reversed refrigerant cycle)	
Drawing	External		YHM-BK01-B328
	Wiring		YHM-RG79-V705
Standard attachment	Document		Installation Manual
	Accessory		Grounded lead wire x 2
Optional parts		Joint: CMY-Y62-G-E Header: CMY-Y64/68-G-E	
Remarks		* Details on foundation work, duct work, insulation work, electrical wiring, power source switch, and other items shall be referred to the Installation Manual. * Due to continuing improvement, above specifications may be subject to change without notice.	

Notes :	Unit converter
*1.Nominal cooling conditions(subject to JIS B8615-1) Indoor : 27degCDB/19degCWB(81degFDB/66degFWB), Outdoor : 35degCDB(95degFDB) Pipe length : 7.5m(24-9/16ft.), Level difference : 0m(0ft.)	kcal =kW x 860 BTU/h =kW x 3,412 cfm =m <sup>3</sup> /min x 35.31 lb =kg / 0.4536
*2.Nominal heating conditions(subject to JIS B8615-1) Indoor : 20degCDB(68degFDB), Outdoor : 7degCDB/6degCWB(45degFDB/43degFWB) Pipe length : 7.5m(24-9/16ft.), Level difference : 0m(0ft.)	
	*Above specification data is subject to rounding variation.

# 1. SPECIFICATIONS

DATA G6

Model			PUMY-P100VHMB	PUMY-P125VHMB	
Power source			1-phase 220-230-240V 50Hz / 1-phase 220V 60Hz	1-phase 220-230-240V 50Hz / 1-phase 220V 60Hz	
Cooling capacity (Nominal)	*1	kW	11.2	14.0	
	*1	kcal / h	9,600	12,000	
	*1	BTU / h	38,200	47,800	
	Power input		kW	3.34	4.32
	Current input		A	15.4-14.8-14.1 / 15.4	20.0-19.1-18.3 / 20.0
COP		kW / kW	3.35	3.24	
Temp. range of cooling	Indoor	W.B.	15 to 24degC(59 to 75degF)	15 to 24degC(59 to 75degF)	
	Outdoor	D.B.	-5 to 46degC(23 to 115degF) 10 to 46degC(50 to 115degF) : in case of connecting PKFY-P15/P20/P25 type indoor unit.	-5 to 46degC(23 to 115degF) 10 to 46degC(50 to 115degF) : in case of connecting PKFY-P15/P20/P25 type indoor unit.	
Heating capacity (Nominal)	*2	kW	12.5	16.0	
	*2	kcal / h	10,800	13,800	
	*2	BTU / h	42,700	54,600	
	Power input		kW	3.66	4.33
	Current input		A	16.9-16.2-15.5 / 16.9	20.0-19.1-18.3 / 20.0
COP		kW / kW	3.42	3.69	
Temp. range of heating	Indoor	D.B.	15 to 27degC(59 to 81degF)	15 to 27degC(59 to 81degF)	
	Outdoor	W.B.	-15 to 15degC(5 to 59degF)	-15 to 15degC(5 to 59degF)	
Indoor unit connectable	Total capacity		50 to 130 % of outdoor unit capacity	50 to 130 % of outdoor unit capacity	
	Model / Quantity		P15 to P125 / 1 to 8	P15 to P140 / 1 to 10	
Sound pressure level (measured in anechoic room)		dB <A>	49 / 51	50 / 52	
Refrigerant piping diameter	Liquid pipe	mm(in.)	9.52(3/8)	9.52(3/8)	
	Gas pipe	mm(in.)	15.88(5/8)	15.88(5/8)	
FAN	Type x Quantity		Propeller fan x 2	Propeller fan x 2	
	Air flow rate	m <sup>3</sup> / min	100	100	
		L/s	1,667	1,667	
		cfm	3,532	3,532	
	Control, Driving mechanism		DC-control, Direct-driven by motor	DC-control, Direct-driven by motor	
	Motor output	kW	0.06 x 2	0.06 x 2	
External static press.		0 Pa (0 mmH <sub>2</sub> O)	0 Pa (0 mmH <sub>2</sub> O)		
Compressor	Type x Quantity		Inverter scroll hermetic compressor	Inverter scroll hermetic compressor	
	Manufacture		MITSUBISHI ELECTRIC CORPORATION	MITSUBISHI ELECTRIC CORPORATION	
	Starting method		Inverter	Inverter	
	Motor output	kW	2.2	2.9	
	Case heater	kW	-	-	
	Lubricant		FV50S x 2.3L	FV50S x 2.3L	
External finish		Galvanized steel sheets <MUNSELL 3Y 7.8/1.1>	Galvanized steel sheets <MUNSELL 3Y 7.8/1.1>		
External dimension HxWxD	mm	1,350 x 950 x 330	1,350 x 950 x 330		
	in.	53-3/16 x 37-7/16 x 13	53-3/16 x 37-7/16 x 13		
Protection devices	High pressure protection		High pressure sensor, High pressure switch at 4.15MPa (601 psi)	High pressure sensor, High pressure switch at 4.15MPa (601 psi)	
	Inverter circuit (COMP. / FAN)		Over-heat protection, Over-current protection	Over-heat protection, Over-current protection	
	Compressor		Discharge thermo protection, Over-current protection	Discharge thermo protection, Over-current protection	
	Fan motor		Over-heat protection, Voltage protection	Over-heat protection, Voltage protection	
Refrigerant	Type x original charge		R410A x 8.5kg (19lbs)	R410A x 8.5kg (19lbs)	
	Control		LEV circuit	LEV circuit	
Net weight	kg(lbs)	129(284)	129(284)		
Heat exchanger		Salt-resistant cross fin & copper tube	Salt-resistant cross fin & copper tube		
HIC circuit (HIC: Heat Inter-Changer)		-	-		
Defrosting method		Auto-defrost mode (Reversed refrigerant cycle)	Auto-defrost mode (Reversed refrigerant cycle)		
Drawing	External	VHM-BK01-B434	VHM-BK01-B434		
	Wiring	VHM-RG79-V708	VHM-RG79-V708		
Standard attachment	Document	Installation Manual	Installation Manual		
	Accessory	Grounded lead wire x 2	Grounded lead wire x 2		
Optional parts		Joint: CMY-Y62-G-E Header: CMY-Y64/68-G-E	Joint: CMY-Y62-G-E Header: CMY-Y64/68-G-E		
Remarks		<p>* In case of connecting Fresh air intake type indoor unit PEFY-P-VHM-E-F, only one indoor unit can be connected with one PUMY.</p> <p>* Details on foundation work, duct work, insulation work, electrical wiring, power source switch, and other items shall be referred to the Installation Manual.</p> <p>* Due to continuing improvement, above specifications may be subject to change without notice.</p>			

Notes :	Unit converter
*1.Nominal cooling conditions(subject to JIS B8615-1) Indoor : 27degCDB/19degCWB(81degFDB/66degFWB), Outdoor : 35degCDB(95degFDB) Pipe length : 7.5m(24-9/16ft.), Level difference : 0m(0ft.)	kcal =kW x 860 BTU/h =kW x 3,412 cfm =m <sup>3</sup> /min x 35.31 lb =kg / 0.4536
*2.Nominal heating conditions(subject to JIS B8615-1) Indoor : 20degCDB(68degFDB), Outdoor : 7degCDB/6degCWB(45degFDB/43degFWB) Pipe length : 7.5m(24-9/16ft.), Level difference : 0m(0ft.)	
	*Above specification data is subject to rounding variation.

# 1. SPECIFICATIONS

Model		PUMY-P140VHMB		
Power source		1-phase 220-230-240V 50Hz / 1-phase 220V 60Hz		
Cooling capacity (Nominal)	*1 kW	15.5		
	*1 kcal / h	13,300		
	*1 BTU / h	52,900		
	Power input	kW		
	Current input	A		
	COP	kW / kW		
Temp. range of cooling	Indoor	W.B.	15 to 24degC(59 to 75degF)	
	Outdoor	D.B.	-5 to 46degC(23 to 115degF) 10 to 46degC(50 to 115degF) : in case of connecting PKFY-P15/P20/P25 type indoor unit.	
Heating capacity (Nominal)	*2 kW	18.0		
	*2 kcal / h	15,500		
	*2 BTU / h	61,400		
	Power input	kW		
	Current input	A		
	COP	kW / kW		
Temp. range of heating	Indoor	D.B.	15 to 27degC(59 to 81degF)	
	Outdoor	W.B.	-15 to 15degC(5 to 59degF)	
Indoor unit connectable	Total capacity	50 to 130 % of outdoor unit capacity		
	Model / Quantity	P15 to P140 / 1 to 12		
Sound pressure level (measured in anechoic room)		dB <A>	51 / 53	
Refrigerant piping diameter	Liquid pipe	mm(in.)	9.52(3/8)	
	Gas pipe	mm(in.)	15.88(5/8)	
FAN	Type x Quantity		Propeller fan x 2	
	Air flow rate	m <sup>3</sup> / min	100	
		L/s	1,667	
		cfm	3,532	
	Control, Driving mechanism		DC-control, Direct-driven by motor	
	Motor output	kW	0.06 x 2	
External static press.		0 Pa (0 mmH <sub>2</sub> O)		
Compressor	Type x Quantity		Inverter scroll hermetic compressor	
	Manufacture		MITSUBISHI ELECTRIC CORPORATION	
	Starting method		Inverter	
	Motor output	kW	3.3	
	Case heater	kW	-	
	Lubricant		FV50S x 2.3L	
External finish		Galvanized steel sheets <MUNSELL 3Y 7.8/1.1>		
External dimension HxWxD	mm	1,350 x 950 x 330		
	in.	53-3/16 x 37-7/16 x 13		
Protection devices	High pressure protection		High pressure sensor, High pressure switch at 4.15MPa (601 psi)	
	Inverter circuit (COMP. / FAN)		Over-heat protection,Over-current protection	
	Compressor		Discharge thermo protection,Over-current protection	
	Fan motor		Over-heat protection,Voltage protection	
Refrigerant	Type x original charge		R410A x 8.5kg (19lbs)	
	Control		LEV circuit	
Net weight	kg(lbs)	129(284)		
Heat exchanger		Salt-resistant cross fin & copper tube		
HIC circuit (HIC: Heat Inter-Changer)		-		
Defrosting method		Auto-defrost mode (Reversed refrigerant cycle)		
Drawing	External	VHM-BK01-B434		
	Wiring	VHM-RG79-V708		
Standard attachment	Document	Installation Manual		
	Accessory	Grounded lead wire x 2		
Optional parts		Joint: CMY-Y62-G-E Header: CMY-Y64/68-G-E		
Remarks		<p>* In case of connecting Fresh air intake type indoor unit PEFY-P-VHM-E-F, only one indoor unit can be connected with one PUMY.</p> <p>* Details on foundation work, duct work, insulation work, electrical wiring, power source switch, and other items shall be referred to the Installation Manual.</p> <p>* Due to continuing improvement, above specifications may be subject to change without notice.</p>		

Notes :	Unit converter
*1.Nominal cooling conditions(subject to JIS B8615-1) Indoor : 27degCDB/19degCWB(81degFDB/66degFWB), Outdoor : 35degCDB(95degFDB) Pipe length : 7.5m(24-9/16ft.), Level difference : 0m(0ft.)	kcal =kW x 860 BTU/h =kW x 3,412 cfm =m <sup>3</sup> /min x 35.31 lb =kg / 0.4536
*2.Nominal heating conditions(subject to JIS B8615-1) Indoor : 20degCDB(68degFDB), Outdoor : 7degCDB/6degCWB(45degFDB/43degFWB) Pipe length : 7.5m(24-9/16ft.), Level difference : 0m(0ft.)	
	*Above specification data is subject to rounding variation.

## PUMY-P100,125,140YHMB PUMY-P100,125,140VHMB

Unit : mm

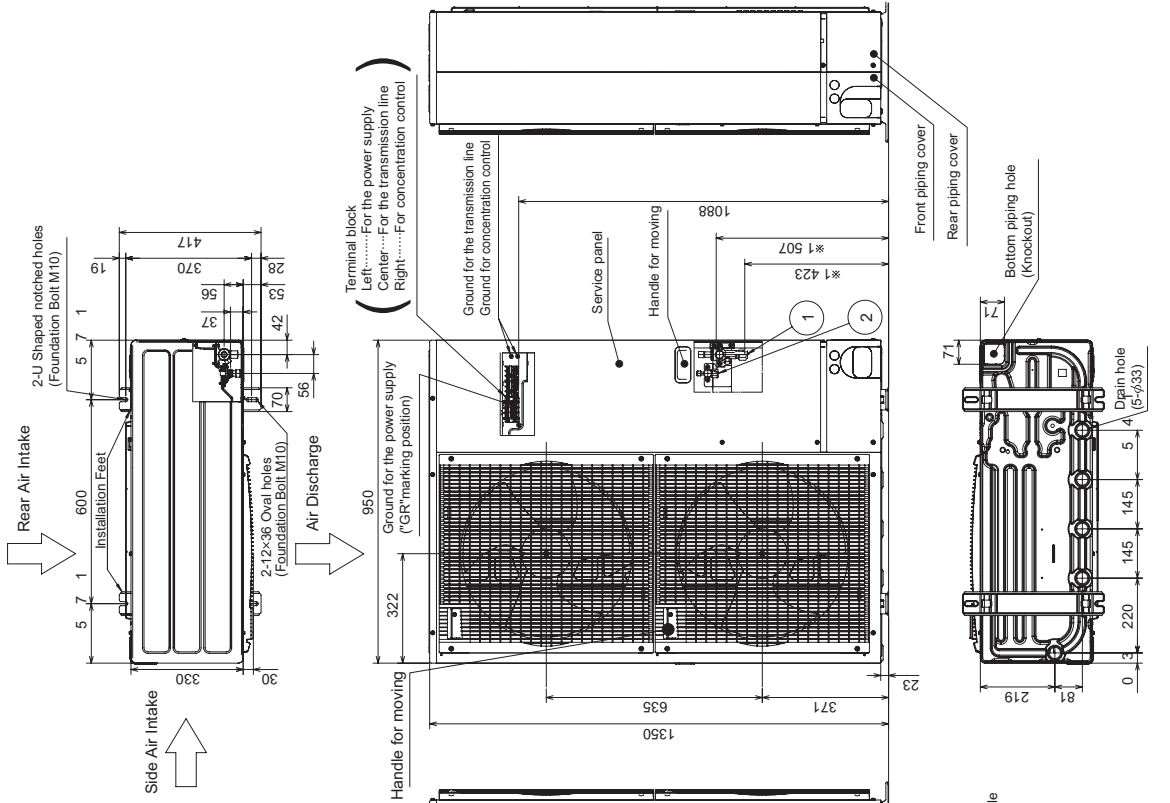

**1 FREE SPACE (Around the unit)**  
The diagram below shows a basic example.  
Explanation of particular details is given in the installation manuals etc.

**2 SERVICE SPACE**  
Dimensions of space needed for service access are shown in the below diagram.

**3 FOUNDATION BOLTS**  
Please secure the unit firmly with 4 foundation (M10) bolts. (Bolts and washers must be purchased locally.)

**4 PIPING-WIRING DIRECTIONS**  
Piping and wiring connections can be made from 4 directions: front, right, rear and below.

**Example of Notes**

① Refrigerant GAS pipe connection (FLARE) φ15.88(5/8 inch)  
 ② Refrigerant LIQUID pipe connection (FLARE) φ9.52(3/8 inch)  
 \*1 ..... Indication of STOP VALVE connection location.

**Piping Knockout Hole Details**

Power supply wiring hole (2-φ27 Knockout)  
 Right trunking hole (Knockout)  
 Front trunking hole (Knockout)  
 Front piping hole (Knockout)

PUMY-P100,125,140YHMB  
 PUMY-P100,125,140VHMB

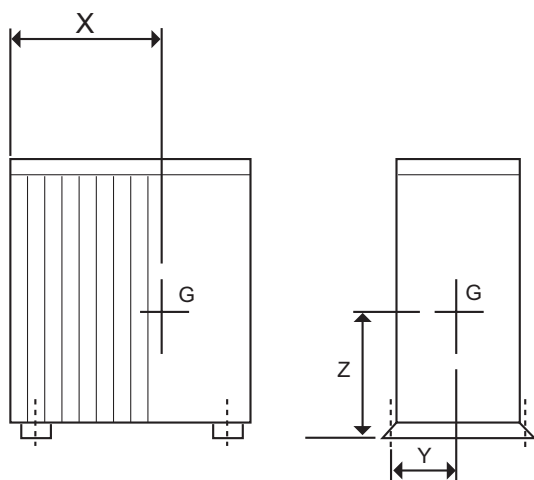

Model	W	D	H	X	Y	Z
PUMY-P100VHMB-E	950	330	1350	620	185	500
PUMY-P125VHMB-E						
PUMY-P140VHMB-E						
PUMY-P100YHMB-E						
PUMY-P125YHMB-E						
PUMY-P140YHMB-E						

PUMY-P100,125,140YHMB

SYMBOL	NAME
TB1	Terminal Block <Power Supply>
TB3	Terminal Block <Communication Line>
TB7	Terminal Block <Centralized Control Line>
MC	Motor For Compressor
MF1,MF2	Fan Motor
21S4	Solenoid Valve<Four-Way Valve>
63H	High Pressure Switch
63L	Low Pressure Switch
63HS	High Pressure Sensor
SV1	Solenoid Valve<Bypass Valve>
TH3	Thermistor<Outdoor Pipe>
TH4	Thermistor<Discharge>
TH6	Thermistor<Low Pressure Saturated>
TH7	Thermistor<Outdoor>
RS	Rush Current Protect Resistor
ACL1~ACL4	Reactor
CB1,CB2	Main Smoothing Capacitor
CK	Capacitor
P.B.	Power Circuit Board
TB-U/W/W	Connection Terminal<U/V/W-Phase>
TB-L1/L2/L3	Connection Terminal<L1/L2/L3-Power Supply>
TB-P2	Connection Terminal
TB-C1	Connection Terminal
TB-N1	Connection Terminal
X52A	Relay
N.F.	Noise Filter Circuit Board
LO1,LO2,LO3,NO	Connection Terminal<L1/L2/L3-Power Supply>
L1/L2/L3/N1	Connection Terminal<L1/L2/L3-Power Supply>
GD1,GD3	Connection Terminal<Ground>
CONV.B.	Converter Circuit Board
L1-A1/IN	Connection Terminal<L1-Power Supply>
L1-A2/OU	Connection Terminal<L1-Power Supply>
L2-A2/OU	Connection Terminal<L2-Power Supply>
L3-A2/OU	Connection Terminal<L3-Power Supply>
N-IN	Connection Terminal
CK-OU	Connection Terminal
C.B.	Controller Circuit Board
SW1	Switch<Display Selection>
SW2	Switch<Function Selection>
SW3	Switch<Test Run>
SW4	Switch<Model Selection>
SW5	Switch<Function Selection>
SW6	Switch<Function Selection>
SW7	Switch<Function Selection>
SW8	Switch<Function Selection>
SWU1	Switch<Unit Address Selection, 1s digit>
SWU2	Switch<Unit Address Selection, 10ths digit>
SS	Connector<Connection For Option>
CN3D	Connector<Connection For Option>
CN3S	Connector<Connection For Option>
CN3N	Connector<Connection For Option>
CN51	Connector<Connection For Option>
LED1,LED2	LED<Operation Inspection Display>
LED3	LED<Power Supply to Main Microcomputer>
F1,F2	Fuse<T6.3AL250V>
X501~X505	Relay
M-NET P.B.	M-NET Power Circuit Board
TP1	Connection Terminal<Ground>

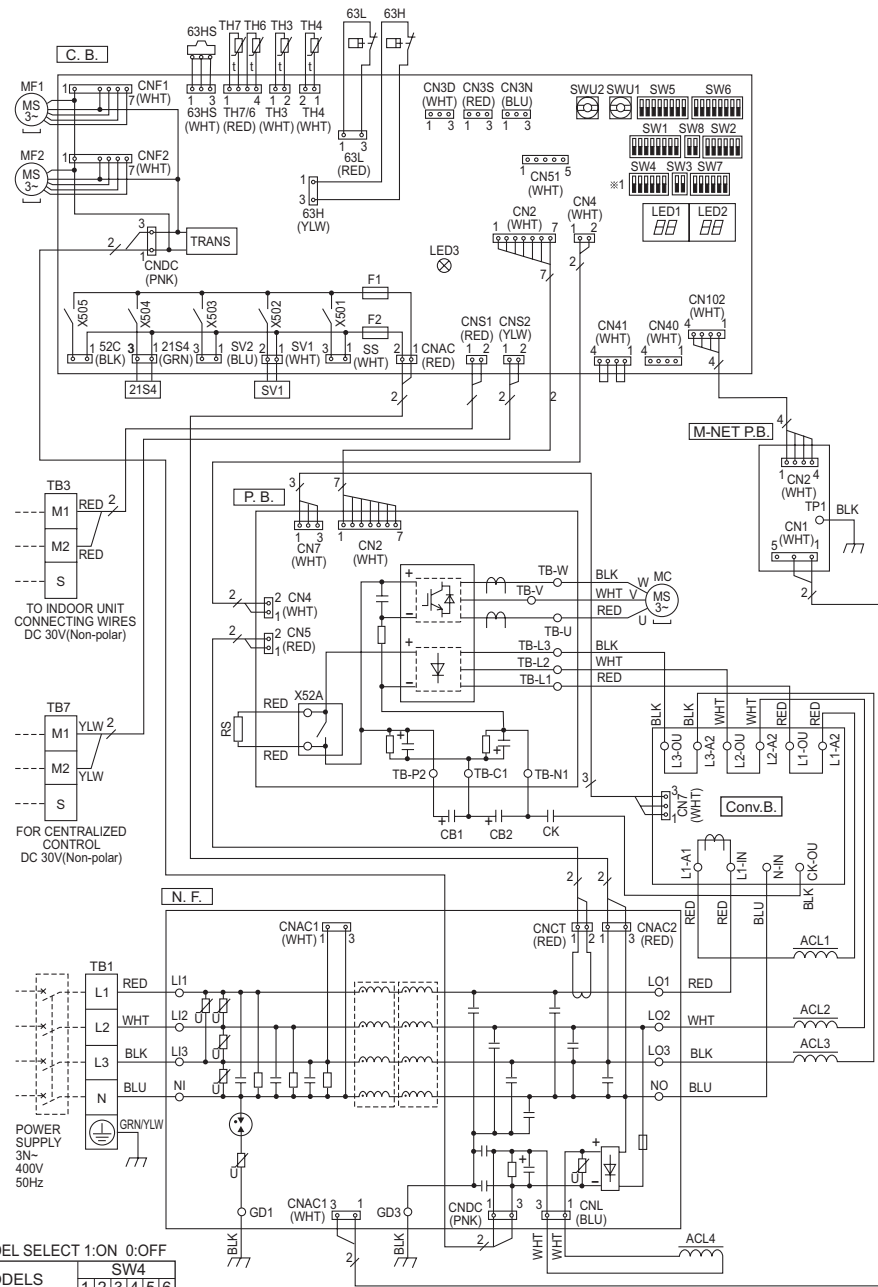

Cautions when Servicing

- ⚠ WARNING: When the main supply is turned off, the voltage [570 V] in the main capacitor will drop to 20 V in approx. 5 minutes (input voltage: 400 V). When servicing, make sure that LED1 and LED2 on the outdoor circuit board goes out, and then wait for at least 5 minute.
- Components other than the outdoor board may be faulty: Check and take corrective action, referring to the service manual. Do not replace the outdoor board without checking.

NOTES:

1. Refer to the wiring diagrams of the indoor units for details on wiring of each indoor unit.

Self-diagnosis function

The indoor and outdoor units can be diagnosed automatically using the self-diagnosis switch (SW1), LED1 and LED2 (LED indication) found on the multi-controller of the outdoor unit. LED indication : Set all contacts of SW1 to OFF.

- During normal operation

The LED indicates the drive state of the controller in the outdoor unit.

Bit	1	2	3	4	5	6	7	8
Indication	Compressor operated	52C	21S4	SV1	(SV2)	—	—	Always lit

- When fault requiring inspection has occurred, the LED alternately indicates the inspection code and the location of the unit in which the fault has occurred.

[Example]

When the compressor and SV1 are turned on during cooling operation.

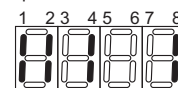



## PUMY-P100,125,140VHMB

SYMBOL	NAME
TB1	Terminal Block <Power Supply>
TB3	Terminal Block <Communication Line>
TB7	Terminal Block <Centralized Control Line>
MC	Motor For Compressor
MF1, MF2	Fan Motor
21S4	Solenoid Valve<Four-Way Valve>
63H	High Pressure Switch
63L	Low Pressure Switch
63HS	High Pressure Sensor
SV1	Solenoid Valve<Bypass valve>
TH3	Thermistor<Outdoor Pipe>
TH4	Thermistor<Discharge>
TH6	Thermistor<Low Pressure Saturated>
TH7	Thermistor<Outdoor>
TH8	Thermistor<Heatsink>
DCL	Reactor
ACTM	Active Filter Module
CE	Main Smoothing Capacitor
P.B.	Power Circuit Board
TABU/W/W	Connection Terminal<U/V/W-Phase>
TABS/T	Connection Terminal<L/N-Phase>
TABP1/P2/P	Connection Terminal<DC Voltage>
TABN1/N2/N	Connection Terminal<DC Voltage>
DS2, DS3	Diode Bridge
IPM	Power Module
N.F.	Noise Filter Circuit Board
L/L/O	Connection Terminal<L-Phase>
N/N/O	Connection Terminal<N-Phase>
EL, E2	Connection Terminal<Ground>
52C	52C Relay
C.B.	Controller Circuit Board
SW1	Switch<Display Selection>
SW2	Switch<Function Selection>
SW3	Switch<Test Run>
SW4	Switch<Model Selection>
SW5	Switch<Function Selection>
SW6	Switch<Function Selection>
SW7	Switch<Function Selection>
SW8	Switch<Function Selection>
SWU1	Switch<Unit Address Selection, 1s digit>
SWU2	Switch<Unit Address Selection, 10ths digit>
CNLVB	Connector<To N.F. Board CN52C> (Symbol of Board is CNLVB)
SS	Connector<Connection For Option>
CN3D	Connector<Connection For Option>
CN3S	Connector<Connection For Option>
CN3N	Connector<Connection For Option>
CN51	Connector<Connection For Option>
LED1, LED2	LED<Operation Inspection Display>
LED3	LED<Power Supply to Main Microcomputer>
F1, F2	Fuse<T6, 3AL250V>
X501-505	Relay
M-NET P.B.	M-NET Power Circuit Board
TP1	Connection Terminal<Ground>

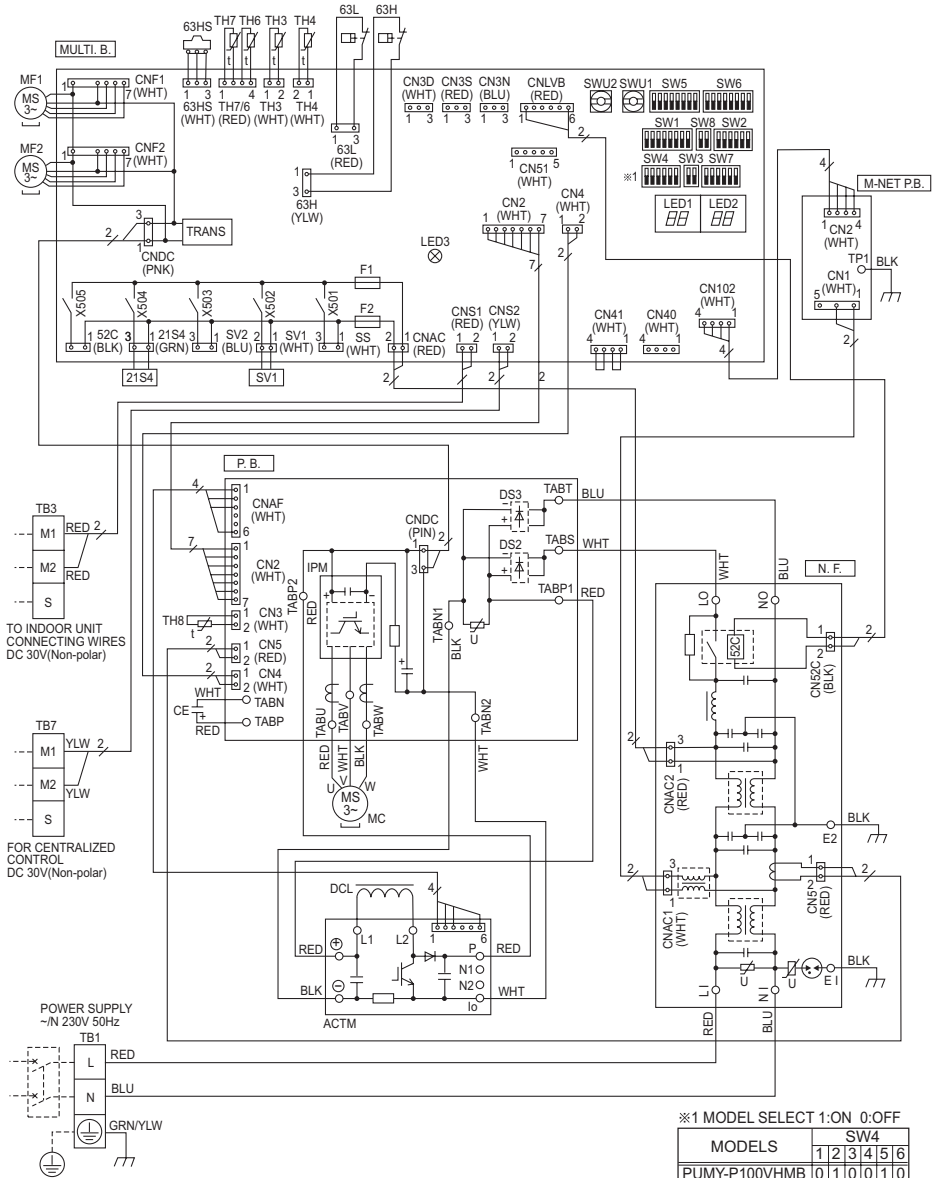

### Cautions when Servicing

- ⚠ **WARNING:** When the main supply is turned off, the voltage [340 V] in the main capacitor will drop to 20 V in approx. 2 minutes (input voltage: 240 V). When servicing, make sure that LED1, LED2 on the outdoor circuit board goes out, and then wait for at least 1 minute. Components other than the outdoor board may be faulty: Check and take corrective action, referring to the service manual. Do not replace the outdoor board without checking.

### NOTES:

- Refer to the wiring diagrams of the indoor units for details on wiring of each indoor unit.
  - Self-diagnosis function
  - The indoor and outdoor units can be diagnosed automatically using the self-diagnosis switch (SW1) and LED1, LED2 (LED indication) found on the multi-controller of the outdoor unit.
  - LED indication : Set all contacts of SW1 to OFF.

- During normal operation
  - The LED indicates the drive state of the controller in the outdoor unit.

Bit	1	2	3	4	5	6	7	8
Indication	Compressor operated	52C	21S4	SV1	(SV2)	—	—	Always lit

When fault requiring inspection has occurred

The LED alternately indicates the inspection code and the location of the unit in which the fault has occurred.

### [Example]

When the compressor and SV1 are turned on during cooling operation.

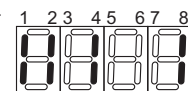

※1 MODEL SELECT 1:ON 0:OFF

MODELS	SW4					
	1	2	3	4	5	6
PUMY-P100VHMB	0	1	0	0	1	0
PUMY-P125VHMB	0	1	0	0	0	1
PUMY-P140VHMB	0	1	0	0	1	1

PUMY-P100,125,140YHMB  
PUMY-P100,125,140VHMB

..... Refrigerant flow in cooling  
 ————— Refrigerant flow in heating

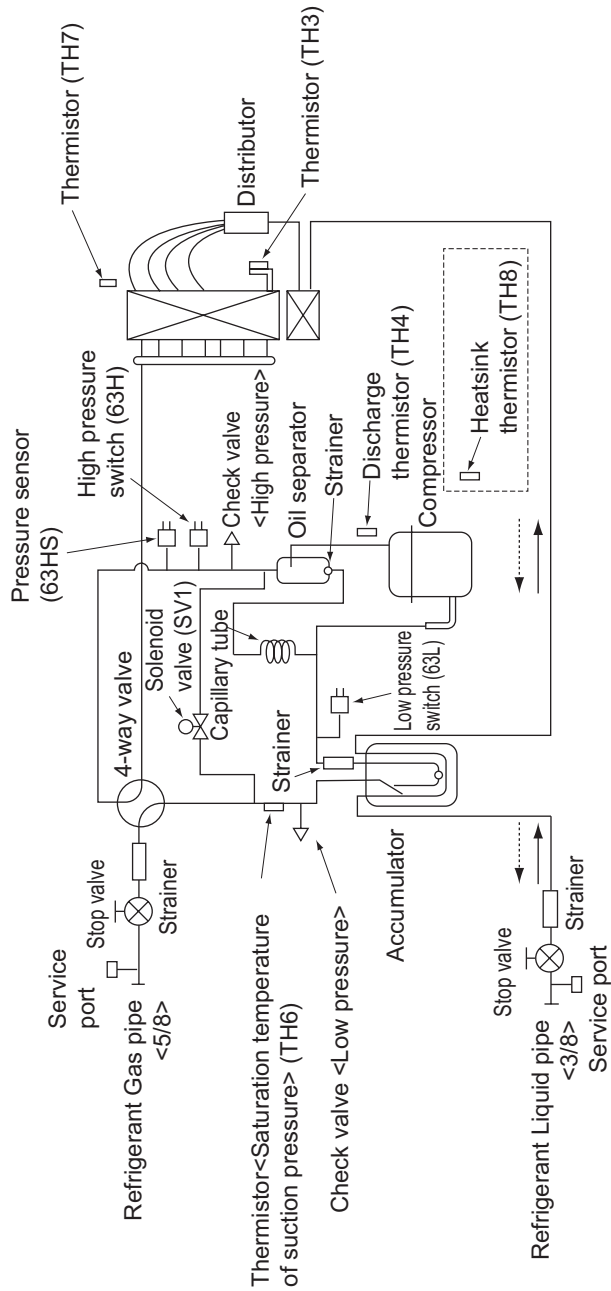

Refrigerant piping specifications <dimensions of flared connector>

Capacity	Item	Liquid piping	Gas piping
Indoor unit	P20, P25, P32, P40, P50	ø 6.35 <1/4">Flare	ø 12.7 <1/2">Flare
	P63, P80, P100 P125, P140	ø 9.52 <3/8">Flare	ø 15.88 <5/8">Flare
	P100, P125, P140	ø 9.52 <3/8">Flare	ø 15.88 <5/8">Flare

**Measurement condition**  
**PUMY-P100,125,140YHMB**  
**PUMY-P100,125,140VHMB**

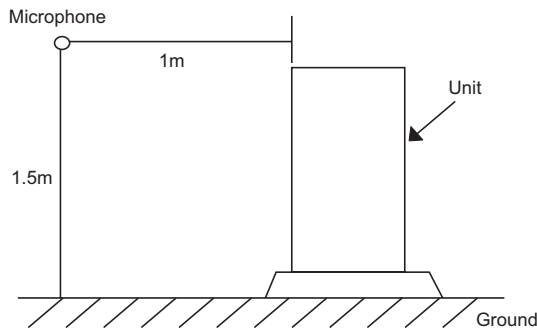

**Sound level of PUMY-P140YHMB,VHMB**

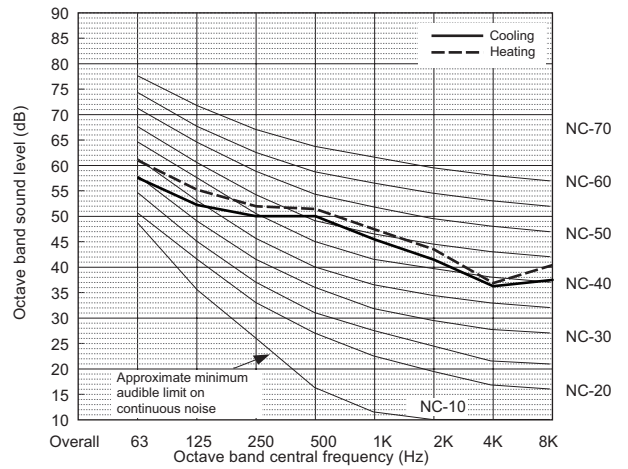

	63Hz	125Hz	250Hz	500Hz	1000Hz	2000Hz	4000Hz	8000Hz	dB(A)
Cooling	57.2	51.7	49.9	49.8	45.5	41.1	35.9	37.1	51.0
Heating	60.9	55.4	52.1	51.4	47.5	43.2	37.1	40.3	53.0
Low Noise Mode 50/60Hz	-	-	-	-	-	-	-	-	-

\* When Low Noise Mode is set, the A/C system's capacity is limited. The system could return to normal operation from Low Noise Mode automatically in the case that the operation condition is severe.

**Sound level of PUMY-P100YHMB,VHMB**

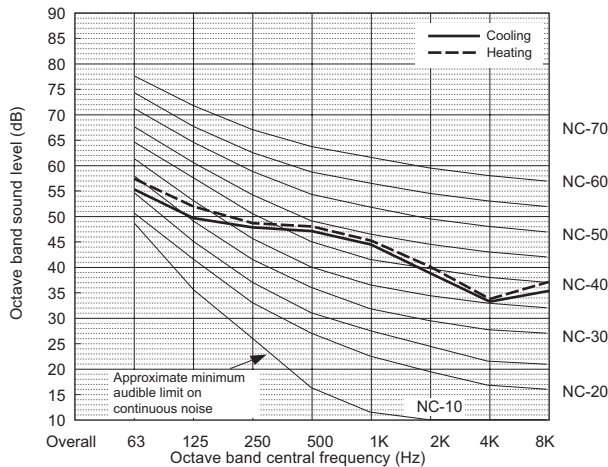

	63Hz	125Hz	250Hz	500Hz	1000Hz	2000Hz	4000Hz	8000Hz	dB(A)
Cooling	55.2	49.7	47.9	47.8	43.5	39.1	33.9	35.1	49.0
Heating	58.9	53.4	50.1	49.4	45.5	41.2	35.1	38.3	51.0
Low Noise Mode 50/60Hz	-	-	-	-	-	-	-	-	-

\* When Low Noise Mode is set, the A/C system's capacity is limited. The system could return to normal operation from Low Noise Mode automatically in the case that the operation condition is severe.

**Sound level of PUMY-P125YHMB,VHMB**

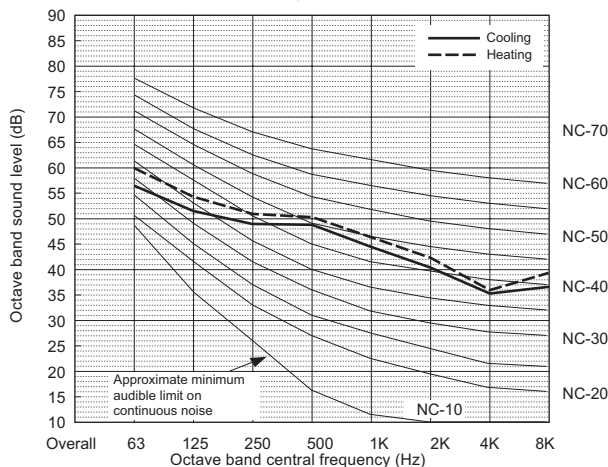

	63Hz	125Hz	250Hz	500Hz	1000Hz	2000Hz	4000Hz	8000Hz	dB(A)
Cooling	56.2	50.7	48.9	48.8	44.5	40.1	34.9	36.1	50.0
Heating	59.9	54.4	51.1	50.4	46.5	42.2	36.1	39.3	52.0
Low Noise Mode 50/60Hz	-	-	-	-	-	-	-	-	-

\* When Low Noise Mode is set, the A/C system's capacity is limited. The system could return to normal operation from Low Noise Mode automatically in the case that the operation condition is severe.

## 7-1. Correction by temperature

CITY MULTI could have various capacities at different designing temperatures. Using the nominal cooling/heating capacity values and the ratios below, the capacity can be found for various temperatures.

PUMY-		P100YHMB	P125YHMB
Nominal Cooling Capacity	kW	11.2	14.0
	kcal/h	9,600	12,000
	Btu/h	38,200	47,800
Input	kW	3.30	4.27

PUMY-		P140YHMB
Nominal Cooling Capacity	kW	15.5
	kcal/h	13,300
	Btu/h	52,900
Input	kW	5.32

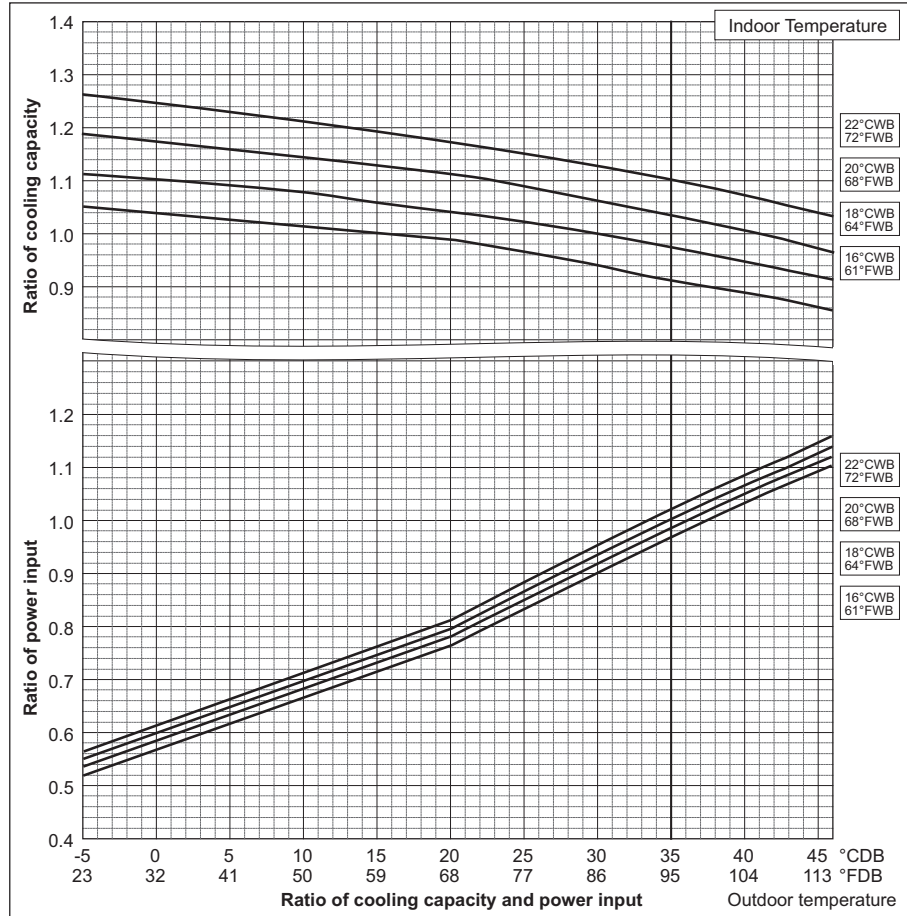

PUMY-		P100YHMB	P125YHMB
Nominal Heating Capacity	kW	12.5	16.0
	kcal/h	10,800	13,800
	Btu/h	42,700	54,600
Input	kW	3.63	4.29

PUMY-		P140YHMB
Nominal Heating Capacity	kW	18.0
	kcal/h	15,500
	Btu/h	61,400
Input	kW	5.32

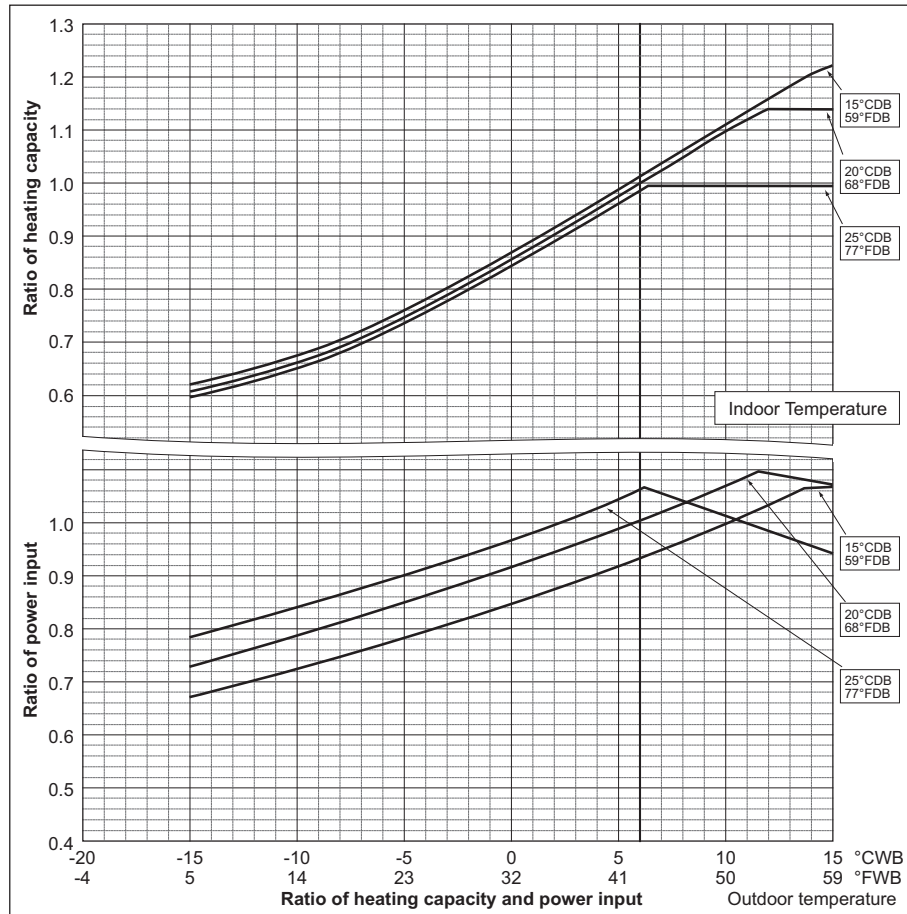

# 7. CAPACITY TABLES

PUMY-		P100VHMB	P125VHMB
Nominal Cooling Capacity	kW	11.2	14.0
	kcal/h	9,600	12,000
	Btu/h	38,200	47,800
Input	kW	3.34	4.32

PUMY-		P140VHMB
Nominal Cooling Capacity	kW	15.5
	kcal/h	13,300
	Btu/h	52,900
Input	kW	5.35

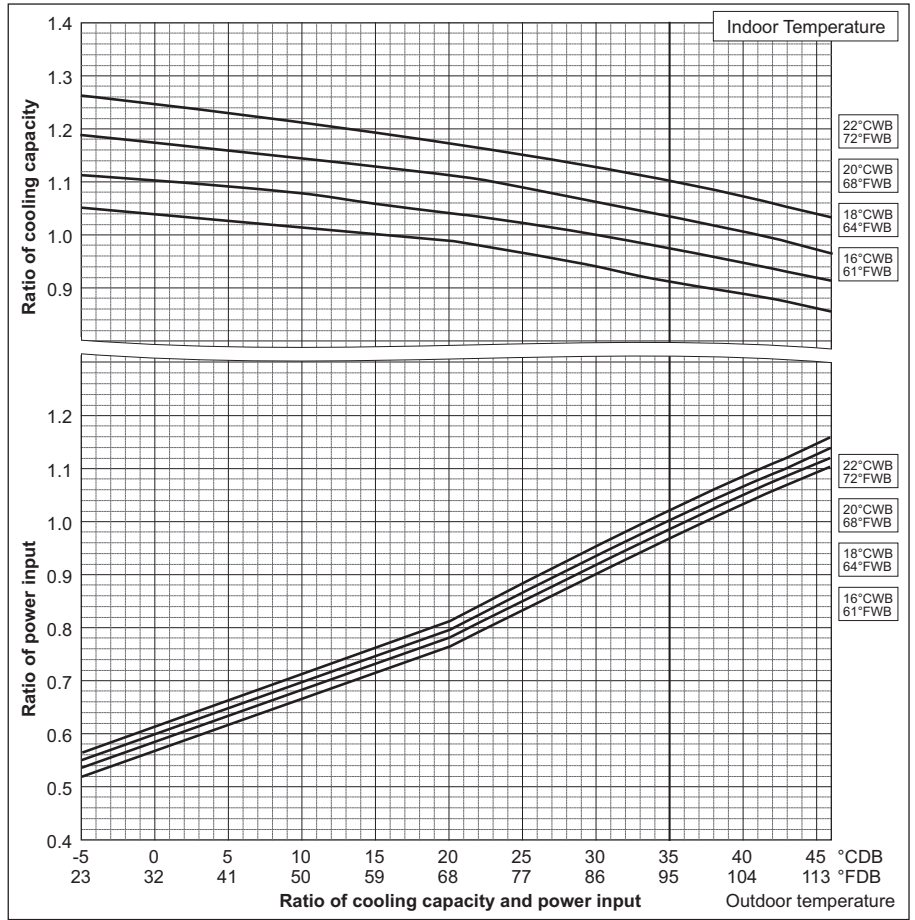

PUMY-		P100VHMB	P125VHMB
Nominal Heating Capacity	kW	12.5	16.0
	kcal/h	10,800	13,800
	Btu/h	42,700	54,600
Input	kW	3.66	4.33

PUMY-		P140VHMB
Nominal Heating Capacity	kW	18.0
	kcal/h	15,500
	Btu/h	61,400
Input	kW	5.58

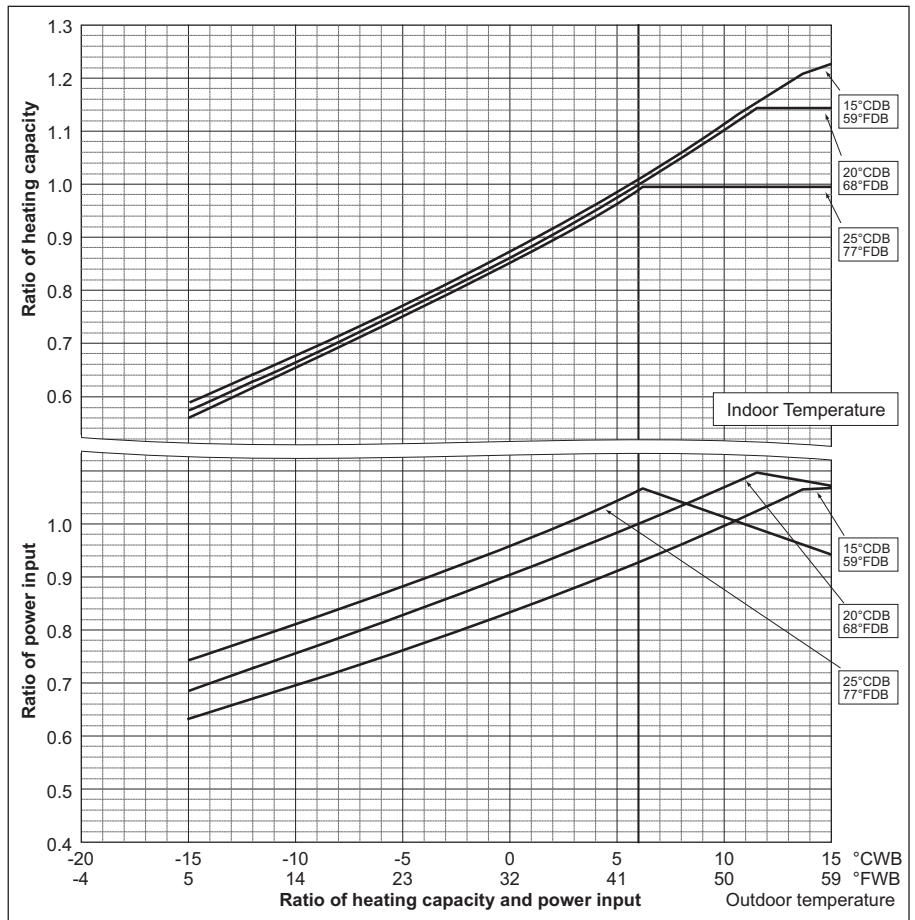



## 7-2. Correction by total indoor

CITY MULTI system have different capacities and inputs when many combinations of indoor units with different total capacities are connected. Using following tables, the maximum capacity can be found to ensure the system is installed with enough capacity for a particular application.

**PUMY-P100,125YHMB**

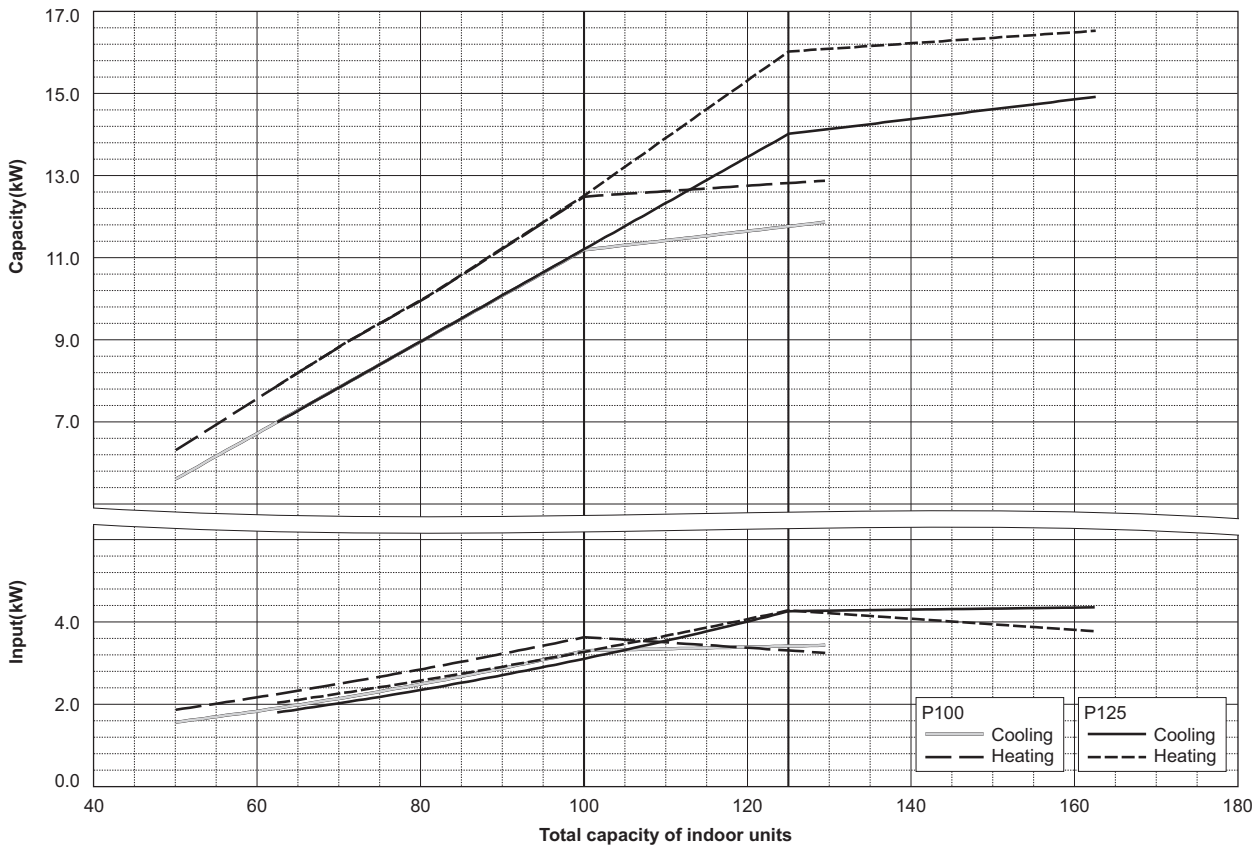

**PUMY-P140YHMB**

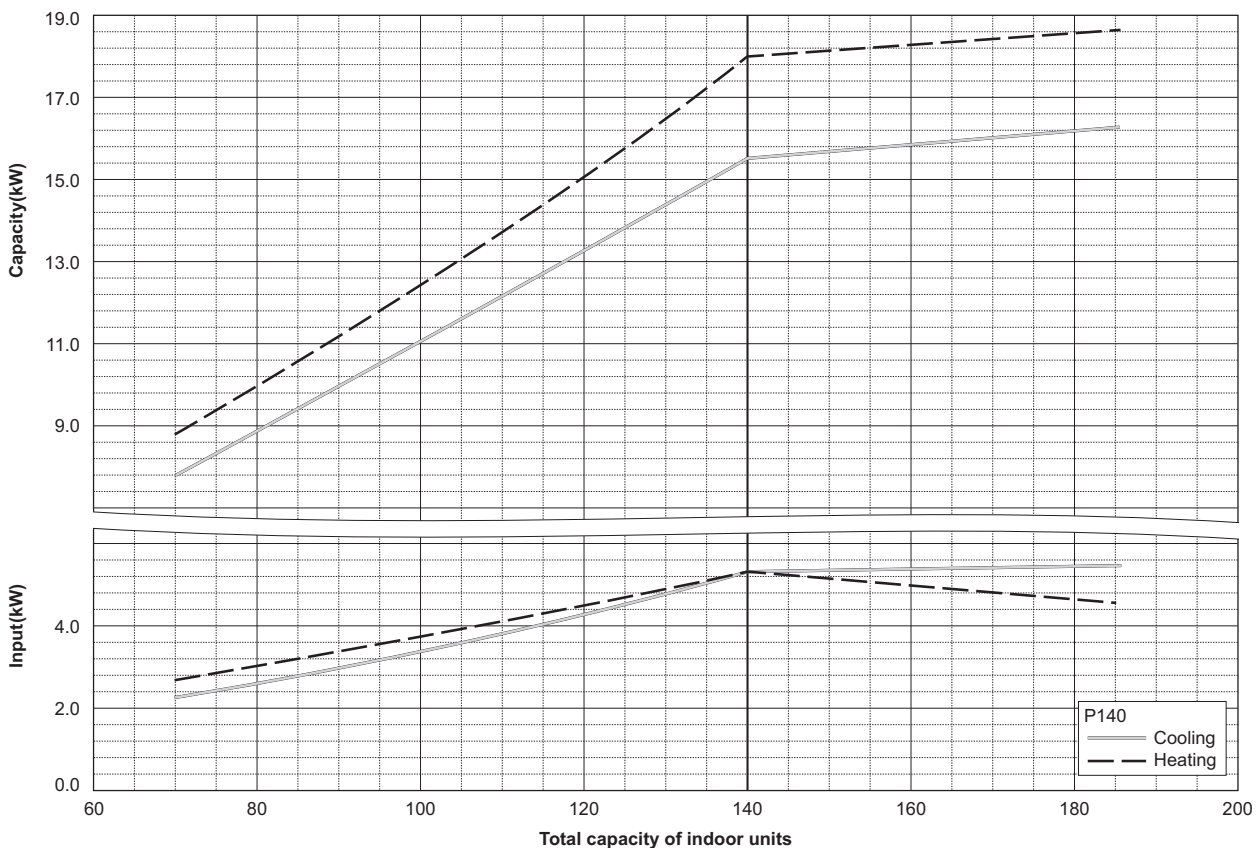

# 7. CAPACITY TABLES

S

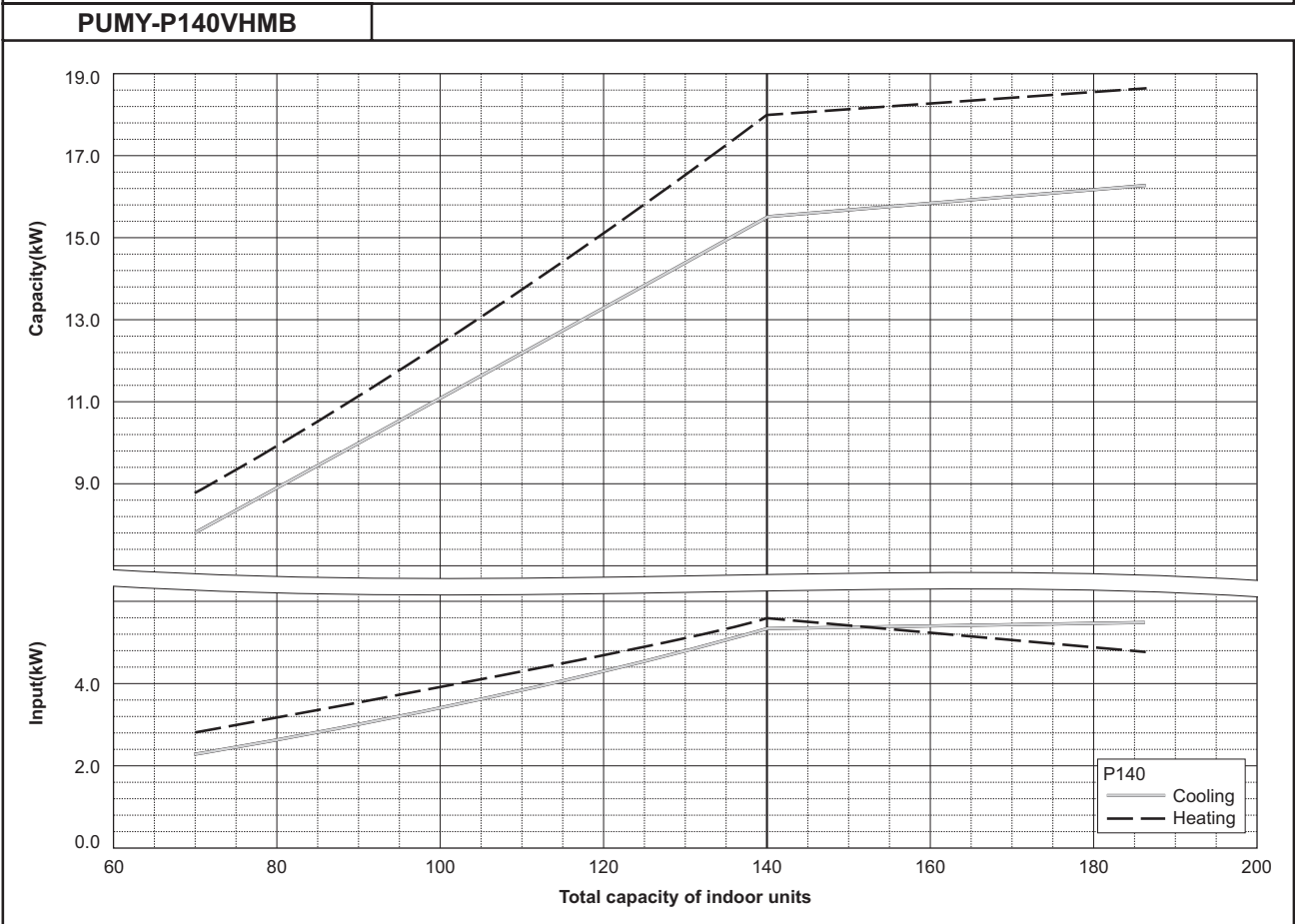
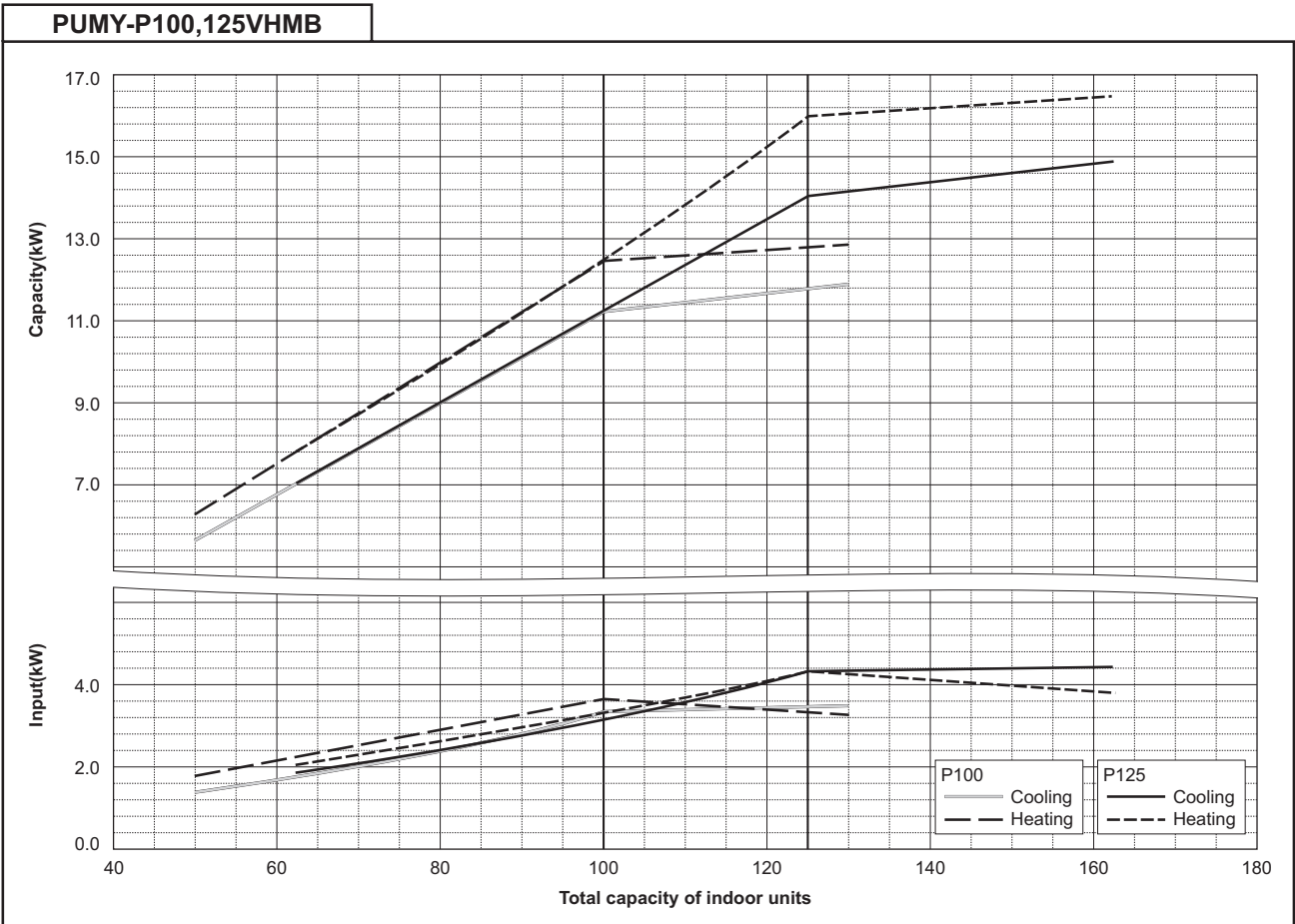

## 7-3. Correction by refrigerant piping length

CITY MULTI systems can have extended piping lengths if certain limitations are followed, but cooling/heating capacity could be reduced. Using following correction factor by equivalent piping length shown at 7-3-1 and 7-3-2, capacity can be found. 7-3-3 shows how to obtain the equivalent piping length.

### 7-3-1. Cooling capacity correction

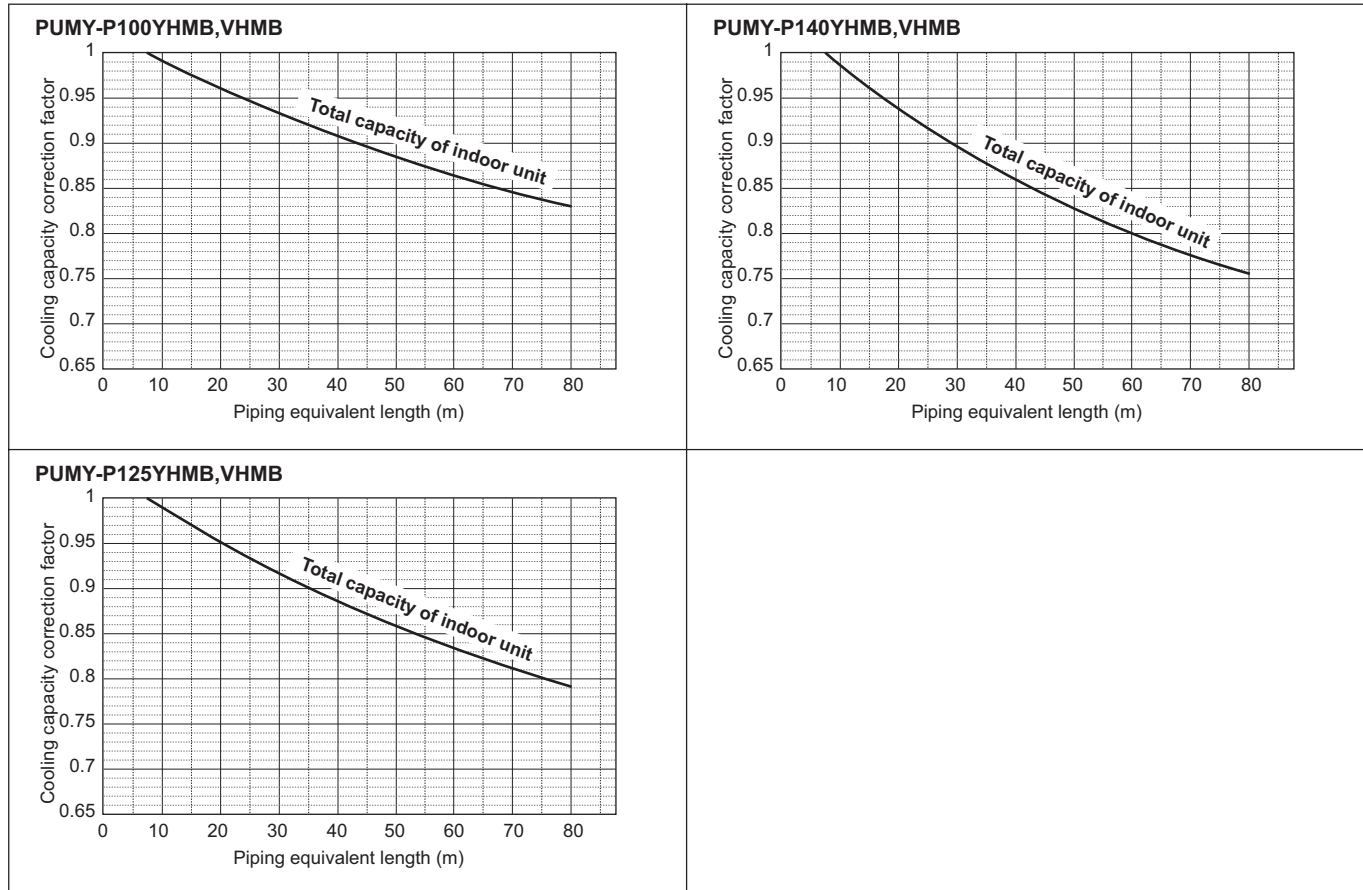

### 7-3-2. Heating capacity correction

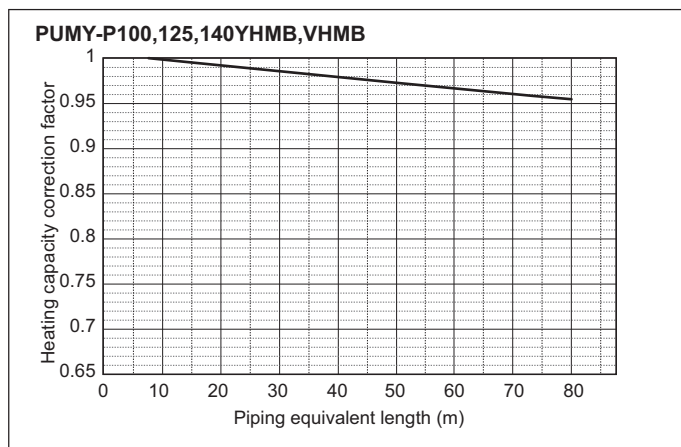

### 7-3-3. How to obtain the equivalent piping length

#### 1. PUMY-P100, 125, 140YHMB, VHMB

Equivalent length = (Actual piping length to the farthest indoor unit) + (0.30 x number of bends on the piping) m



## 7-4. Correction at frost and defrost

Due to frost at the outdoor heat exchanger and the automatic defrosting operation, the heating capacity of the outdoor unit should be considered by multiplying the correction factor which is shown in the table below.

Table of correction factor at frosting and defrosting

Outdoor inlet air temp. °C	6	4	2	1	0	-2	-4	-6	-8	-10	-20
Outdoor inlet air temp. °F	43	39	36	34	32	28	25	21	18	14	-4
PUMY-P100, 125, 140YHMB	1.0	0.98	0.855	0.85	0.845	0.89	0.90	0.95	0.95	0.95	-
PUMY-P100, 125, 140VHMB	1.0	0.98	0.855	0.85	0.845	0.89	0.90	0.95	0.95	0.95	-

## 7-5. Operation temperature range

### • Cooling

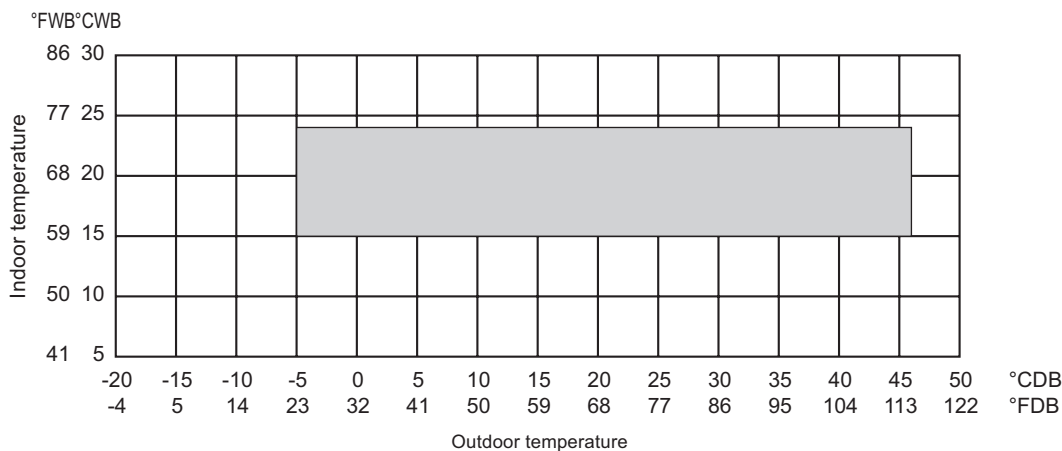

\* 10 to 40°CDB (50 to 115°FDB): in case of connecting PKFY-P15/P20/P25 type indoor unit.

### • Heating

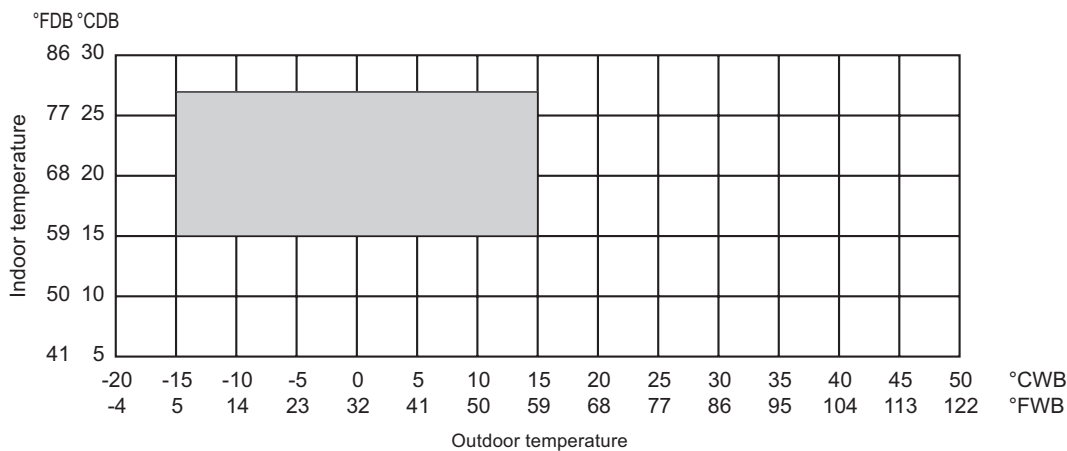

## 8-1. JOINT

CITY MULTI piping can be easily installed with joints and headers provided by MITSUBISHI ELECTRIC CORP.. There is one set of piping joints. Details for installing the joint sets are found in System Design 3, or their own Installation Manual.

### CMY-Y62-G-E

mm

#### 1. Specification

	Items	Details
Main	Number of ports	2 ports
	Number of branch joints	One for each liquid and gas pipe
	Pipe material	Phosphorus deoxidized copper C1220T-OL (JIS H3300)
Accessory	Insulation material	Foamed polyethylene (one for each liquid and gas pipe)
	Reducer	10 reducers of 7 types (Refer to the external drawing for details.)

#### 2. External drawing

For liquid pipe:

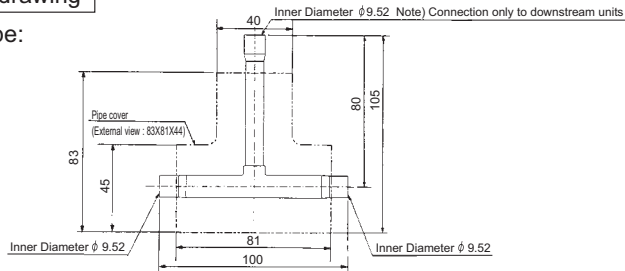

Reducer (Accessory):

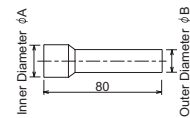

A (Inner Diameter)	B (Outer Diameter)	Number of reducers
$\phi$ 12.7	$\phi$ 9.52	2
$\phi$ 19.05	$\phi$ 15.88	1
$\phi$ 22.22	$\phi$ 19.05	1

For gas pipe:

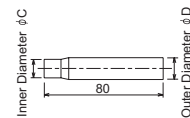
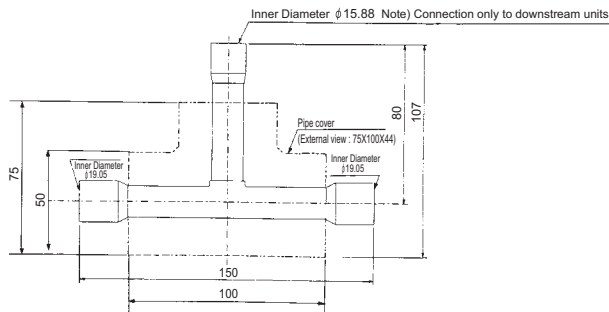

C (Inner Diameter)	D (Outer Diameter)	Number of reducers
$\phi$ 6.35	$\phi$ 9.52	2
$\phi$ 12.7	$\phi$ 15.88	1
$\phi$ 12.7	$\phi$ 19.05	1
$\phi$ 15.88	$\phi$ 19.05	2

8-2. HEADER

CITY MULTI piping can be easily installed with joints and headers provided by MITSUBISHI ELECTRIC CORP.. There are two sets of headers for piping. Details for installing the header sets are found in System Design 3, or their own Installation Manual.

CMY-Y64-G-E

mm

1. Specification

Items		Details
Main	Number of ports	3 ~ 4 ports
	Number of branch joints	One for each liquid and gas pipe
	Pipe material	Phosphorus deoxidized copper C1220T-OL (JIS H3300)
Accessory	Insulation material	Foamed polyethylene
	Reducer	7 reducers of 5 types
	Cap	2 caps of 2 different types for each liquid and gas pipe 4 caps in total

2. External drawing

For liquid pipe:

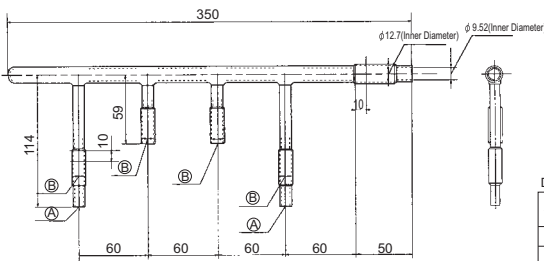

Dimension table

Symbol	Inner Diameter (mm)
(A)	φ 6.35
(B)	φ 9.52

Reducer (Accessory):

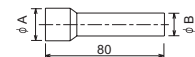

A (Inner Diameter)	B (Outer Diameter)	Number of reducers
φ 19.05	φ 15.88	1
φ 15.88	φ 12.7	2
φ 9.52	φ 6.35	2

For gas pipe:

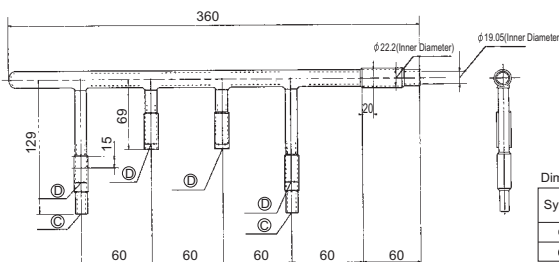

Dimension table

Symbol	Inner Diameter (mm)
(C)	φ 12.7
(D)	φ 15.88

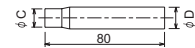

C (Inner Diameter)	D (Outer Diameter)	Number of reducers
φ 15.88	φ 19.05	1
φ 9.52	φ 12.7	1

CMY-Y68-G-E

mm

1. Specification

Items		Details
Main	Number of ports	5 ~ 8 ports
	Number of branch joints	One for each liquid and gas pipe
	Pipe material	Phosphorus deoxidized copper C1220T-OL (JIS H3300)
Accessory	Insulation material	Foamed polyethylene
	Reducer	3 reducers of 3 types
	Cap	3 caps for each liquid and gas pipe 6 in total

2. External drawing

For liquid pipe:

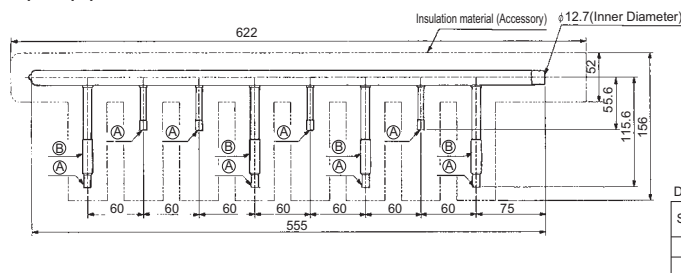

Dimension table

Symbol	Inner Diameter (mm)
(A)	φ 6.35
(B)	φ 9.52

Reducer (Accessory):

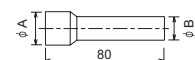

A (Inner Diameter)	B (Outer Diameter)	Number of reducers
φ 19.05	φ 15.88	1
φ 12.7	φ 9.52	1

For gas pipe:

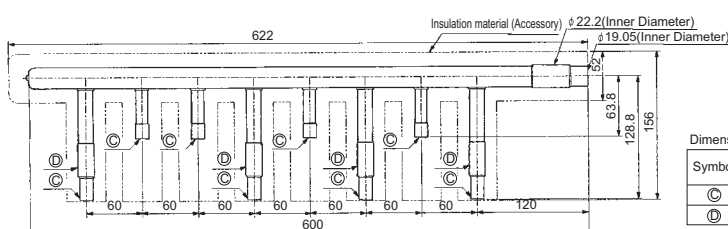

Dimension table

Symbol	Inner Diameter (mm)
(C)	φ 12.7
(D)	φ 15.88

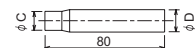

C (Inner Diameter)	D (Outer Diameter)	Number of reducers
φ 15.88	φ 19.05	1

