

# CITY MULTI™ OUTDOOR UNITS

# S SERIES

**S SERIES**

1. SPECIFICATIONS
2. CAPACITY TABLES
  - 2.1 Correction by temperature
  - 2.2 Correction by total indoor
  - 2.3 Correction by refrigerant piping length
  - 2.4 Correction at frosting and defrosting
  - 2.5 Temp. range of running
3. SOUND LEVELS
4. EXTERNAL DIMENSIONS
5. ELECTRICAL WIRING DIAGRAMS
6. REFRIGERANT CIRCUIT DIAGRAMS AND THERMAL SENSORS

- S-2
- S-6
- S-6
- S-8
- S-10
- S-11
- S-11
- S-12
- S-13
- S-15
- S-17

- Y
- R2
- WY
- WR2
- S**
- OP

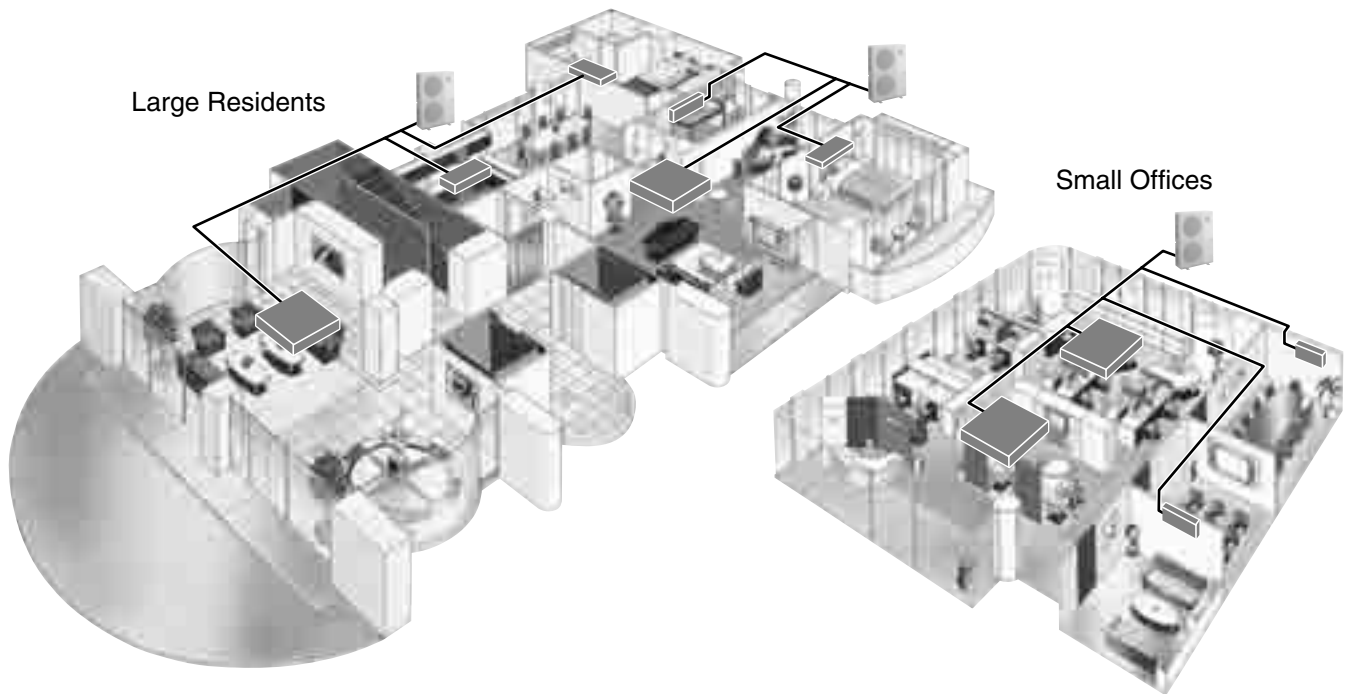

Heat pump: PUMY-P-YHM

3-phase 4-wire 380-400-415V/50Hz	100	125	140
	4HP	5HP	6HP
S Heat pump	●	●	●

Heat pump: PUMY-P-VHM

1-phase 2-wire 220-230-240V/50Hz 220V/60Hz	100	125	140
	4HP	5HP	6HP
S Heat pump	●	●	●

# 1. SPECIFICATIONS

R410A Data G3

Model			PUMY-P100YHM	PUMY-P125YHM	
Power source			3-phase 4-wire 380-400-415V 50Hz		
Cooling capacity (Nominal)	*1	kW	11.2	14.0	
	*1	kcal / h	9,600	12,000	
	*1	Btu / h	38,200	47,800	
	*2	kcal / h	-	12,500	
		Power input	kW	3.30	4.27
	Current input	A	5.28-5.02-4.84	6.83-6.49-6.26	
	COP (kW / kW)		3.39	3.28	
Temp. range of cooling	Indoor	W.B.	15 ~ 24°C (59 ~ 75°F)		
	Outdoor	D.B.	- 5 ~ 46°C (23 ~ 115°F)		
			10 to 46°C D.B. (50 to 115°F D.B.) : in case of connecting PKFY-P20/P25 type indoor unit.		
Heating capacity (Nominal)	*3	kW	12.5	16.0	
	*3	kcal / h	10,800	13,800	
	*3	Btu / h	42,700	54,600	
		Power input	kW	3.63	4.29
		Current input	A	5.81-5.52-5.32	6.87-6.52-6.29
	COP (kW / kW)		3.44	3.73	
Temp. range of heating	Indoor temp.	D.B.	15 ~ 27°C (59 ~ 81°F)		
	Outdoor temp.	W.B.	-15 ~ 15°C (5 ~ 59°F)		
Indoor unit connectable	Total capacity	50 ~ 130% of outdoor unit capacity			
	Model / Quantity	P20 ~ P125 / 1 ~ 6		P20 ~ P140 / 1 ~ 8	
Noise level (measured in anechoic room)	dB <A>		49 / 51	50 / 52	
Diameter of refrigerant pipe	Liquid (High press.)	mm (in.)	ø9.52 (ø3/8") Flare	ø9.52 (ø3/8") Flare	
	Gas (Low press.)	mm (in.)	ø15.88 (ø5/8") Flare	ø15.88 (ø5/8") Flare	

External finish		Galvanized steel sheet <MUNSELL 3Y 7.8/1.1>		
External dimension H x W x D	mm	1,350 x 950 x 330		1,350 x 950 x 330
	in.	53-3/16" x 37-7/16" x 13"		53-3/16" x 37-7/16" x 13"
Net weight	kg (lb)	140 (309)		140 (309)
Heat exchanger		Salt-resistant cross fin & copper tube		
Compressor	Type	Inverter scroll hermetic comp.		
	Manufacturer	MITSUBISHI ELECTRIC CORPORATION		
	Starting method	Inverter		
	Motor output	kW	1.9	2.4
	Case heater	kW	-	-
	Lubricant		MEL56	MEL56
FAN	Air flow rate	m³ / min	100	100
		L / s	1667	1667
		cfm	3532	3532
	External static press.		0 Pa	0 Pa
	Type x Quantity		Propeller fan x 2	Propeller fan x 2
	Control, Driving mechanism		DC-control, Direct-driven by motor	DC-control, Direct-driven by motor
Motor output	kW	0.06 x 2		
HIC circuit (HIC: Heat Inter-Changer)				
Protection	High pressure protection	High pressure sensor, High pressure switch 4.15 MPa		
	Inverter circuit (COMP. / FAN)	Over-heat protection, Over-current protection		
	Compressor	Discharge thermo protection, Over-current protection		
	Fan motor	Over-heat protection, Voltage protection		
Defrosting method				
Refrigerant	Type x Original charge	R410A x 8.5kg (19 lb)		R410A x 8.5kg (19 lb)
	Control	LEV circuit		
Drawing	External	YHM-BK01-B328		
	Wiring	YHM-RG79-V020		
	Refrigerant circle	RC_VBN-050092		
Standard attachment	Document	Installation Manual		
	Accessory	Grounded lead wire x 2		
Optional parts	Joint: CMY-Y62-G-E Header: CMY-Y64/68-G-E		Joint: CMY-Y62-G-E Header: CMY-Y64/68-G-E	
Remark	Details on foundation work, duct work, insulation work, electrical wiring, power source switch, and other items shall be referred to the Installation Manual.			

Note :	*1 Nominal cooling conditions	*2 Nominal cooling conditions	*3 Nominal heating conditions	Unit converter
	Indoor : 27°CDB/19°CWB (81°FDB/66°FWB)	27°CDB/19.5°CWB (81°FDB/67°FWB)	20°CDB (68°FDB)	kcal/h = kW x 860
	Outdoor : 35°CDB (95°FDB)	35°CDB (95°FDB)	7°CDB/6°CWB (45°FDB/43°FWB)	Btu/h = kW x 3,412
	Pipe length : 7.5 m (24-9/16 ft)	5 m (16-3/8 ft)	7.5 m (24-9/16 ft)	cfm = m³/min x 35.31
	Level difference : 0 m (0 ft)	0 m (0 ft)	0 m (0 ft)	lb = kg / 0.4536
* Nominal conditions *1, *2, *3 are subject to JIS B8615-1.				* Above specification data is subject to rounding variation.
* Due to continuing improvement, above specifications may be subject to change without notice.				

Ref. : Spec\_s\_p100\_125YHM

# 1. SPECIFICATIONS

R410A Data G3

Model			PUMY-P140YHM		
Power source			3-phase 4-wire 380-400-415V 50Hz		
Cooling capacity (Nominal)	*:1	kW	15.5		
	*:1	kcal / h	13,300		
	*:1	Btu / h	52,900		
	*:2	kcal / h	14,000		
		Power input	kW	5.32	
	Current input	A	8.51-8.09-7.80		
	COP (kW / kW)		2.91		
Temp. range of cooling	Indoor	W.B.	15 ~ 24°C (59 ~ 75°F)		
	Outdoor	D.B.	- 5 ~ 46°C (23 ~ 115°F)		
			10 to 46°C D.B. (50 to 115°F D.B.) : in case of connecting PKFY-P20/P25 type indoor unit.		
Heating capacity (Nominal )	*:3	kW	18.0		
	*:3	kcal / h	15,500		
	*:3	Btu / h	61,400		
		Power input	kW	5.32	
		Current input	A	8.51-8.09-7.80	
	COP (kW / kW)		3.38		
Temp. range of heating	Indoor temp.	D.B.	15 ~ 27°C (59 ~ 81°F)		
	Outdoor temp.	W.B.	-15 ~ 15°C (5 ~ 59°F)		
Indoor unit connectable	Total capacity		50 ~ 130% of outdoor unit capacity		
	Model / Quantity		P20 ~ P140 / 1 ~ 8		
Noise level (measured in anechoic room)	dB <A>		51 / 53		
Diameter of refrigerant pipe	Liquid (High press.)	mm (in.)	ø9.52 (ø3/8") Flare		
	Gas (Low press.)	mm (in.)	ø15.88 (ø5/8") Flare		

External finish			Galvanized steel sheet <MUNSELL 3Y 7.8/1.1>	
External dimension H x W x D	mm		1,350 x 950 x 330	
	in.		53-3/16" x 37-7/16" x 13"	
Net weight	kg (lb)		140 (309)	
Heat exchanger			Salt-resistant cross fin & copper tube	
Compressor	Type		Inverter scroll hermetic comp.	
	Manufacturer		MITSUBISHI ELECTRIC CORPORATION	
	Starting method		Inverter	
	Motor output	kW	2.9	
	Case heater	kW	-	
	Lubricant		MEL56	
FAN	Air flow rate	m <sup>3</sup> / min	100	
		L / s	1667	
		cfm	3532	
	External static press.		0 Pa	
	Type x Quantity		Propeller fan x 2	
	Control, Driving mechanism		DC-control, Direct-driven by motor	
	Motor output	kW	0.06 x 2	
HIC circuit (HIC: Heat Inter-Changer)			-	
Protection	High pressure protection		High pressure sensor, High pressure switch 4.15 MPa	
	Inverter circuit (COMP. / FAN)		Over-heat protection, Over-current protection	
	Compressor		Discharge thermo protection, Over-current protection	
	Fan motor		Over-heat protection, Voltage protection	
Defrosting method			Auto-defrost mode (Reversed refrigerant circle)	
Refrigerant	Type x Original charge		R410A x 8.5kg (19 lb)	
	Control		LEV circuit	
Drawing	External		YHM-BK01-B328	
	Wiring		YHM-RG79-V020	
	Refrigerant circle		RC_VBN-050092	
Standard attachment	Document		Installation Manual	
	Accessory		Grounded lead wire x 2	
Optional parts			Joint: CMY-Y62-G-E Header: CMY-Y64/68-G-E	
Remark			Details on foundation work, duct work, insulation work, electrical wiring, power source switch, and other items shall be referred to the Installation Manual.	

Note :	*:1 Nominal cooling conditions	*:2 Nominal cooling conditions	*:3 Nominal heating conditions	Unit converter
	Indoor : 27°CDB/19°CWB (81°FDB/66°FWB)	27°CDB/19.5°CWB (81°FDB/67°FWB)	20°CDB (68°FDB)	kcal/h = kW x 860
	Outdoor : 35°CDB (95°FDB)	35°CDB (95°FDB)	7°CDB/6°CWB (45°FDB/43°FWB)	Btu/h = kW x 3,412
	Pipe length : 7.5 m (24-9/16 ft)	5 m (16-3/8 ft)	7.5 m (24-9/16 ft)	cfm = m <sup>3</sup> /min x 35.31
	Level difference : 0 m (0 ft)	0 m (0 ft)	0 m (0 ft)	lb = kg / 0.4536
* Nominal conditions *:1, *:3 are subject to JIS B8615-1.				*Above specification data is subject to rounding variation.
* Due to continuing improvement, above specifications may be subject to change without notice.				

Ref. : Spec\_s\_p140YHM

# 1. SPECIFICATIONS

R410A Data G3

Model			PUMY-P100VHM	PUMY-P125VHM	
Power source			1-phase 220-230-240V 50Hz, 1-phase 220V 60Hz		
Cooling capacity (Nominal)	*1	kW	11.2	14.0	
	*1	kcal / h	9,600	12,000	
	*1	Btu / h	38,200	47,800	
	*2	kcal / h	10,000	12,500	
	Power input		kW	3.34	4.32
	Current input		A	15.4-14.8-14.1, 15.4	20.0-19.1-18.3, 20.0
COP (kW / kW)			3.35	3.24	
Temp. range of cooling	Indoor	W.B.	15 ~ 24°C (59 ~ 75°F)		
	Outdoor	D.B.	- 5 ~ 46°C (23 ~ 115°F)		
			10 to 46°C D.B. (50 to 115°F D.B.) : in case of connecting PKFY-P20 / P25 type indoor unit.		
Heating capacity (Nominal)	*3	kW	12.5	16.0	
	*3	kcal / h	10,800	13,800	
	*3	Btu / h	42,700	54,600	
	Power input		kW	3.66	4.33
	Current input		A	16.9-16.2-15.5, 16.9	20.0-19.1-18.3, 20.0
	COP (kW / kW)			3.42	3.69
Temp. range of heating	Indoor temp.	D.B.	15 ~ 27°C (59 ~ 81°F)		
	Outdoor temp.	W.B.	-15 ~ 15°C (5 ~ 59°F)		
Indoor unit connectable	Total capacity		50 ~ 130% of outdoor unit capacity		
	Model / Quantity		P20 ~ P125 / 1 ~ 6	P20 ~ P140 / 1 ~ 8	
Noise level (measured in anechoic room)		dB <A>	49 / 51	50 / 52	
Diameter of refrigerant pipe	Liquid (High press.)	mm (in.)	ø9.52 (ø3/8") Liquid	ø9.52 (ø3/8") Liquid	
	Gas (Low press.)	mm (in.)	ø15.88 (ø5/8") Gas	ø15.88 (ø5/8") Gas	

External finish			Galvanized steel sheet <MUNSELL 3Y 7.8/1.1>		
External dimension H x W x D	mm		1,350 x 950 x 330	1,350 x 950 x 330	
	in.		53-3/16" x 37-7/16" x 13"	53-3/16" x 37-7/16" x 13"	
Net weight		kg (lb)	127 (280 lb)	127 (280 lb)	
Heat exchanger			Salt-resistant cross fin & copper tube		
Compressor	Type		Inverter scroll hermetic comp.		
	Manufacturer		MITSUBISHI ELECTRIC CORPORATION		
	Starting method		Inverter		
	Motor output		kW	2.2	2.9
	Case heater		kW	-	-
	Lubricant		MEL56 x 2.3 L		
FAN	Air flow rate	m³ / min	100	100	
		L / s	1667	1667	
		cfm	3532	3532	
	External static press.		0 Pa		
	Type x Quantity		Propeller fan x 2		
	Control, Driving mechanism		DC-control, Direct-driven by motor		
	Motor output		kW	0.06 x 2	0.06 x 2
HIC circuit (HIC: Heat Inter-Changer)			-		
Protection	High pressure protection		High pressure sensor, High pressure switch 4.15 MPa		
	Inverter circuit (COMP. / FAN)		Over-heat protection, Over-current protection		
	Compressor		Discharge thermo protection, Over-current protection		
	Fan motor		Over-heat protection, Voltage protection		
Defrosting method			Auto-defrost mode (Reversed refrigerant circle)		
Refrigerant	Type x Original charge		R410A x 8.5kg (19 lb)	R410A x 8.5kg (19 lb)	
	Control		LEV circuit		
Drawing	External		VHM-BK01-B434		
	Wiring		VHM-RG79-V221		
	Refrigerant circle		RC_VBN-050092		
Standard attachment	Document		Installation Manual		
	Accessory		Grounded lead wire x 2		
Optional parts			Joint: CMY-Y62-G-E Header: CMY-Y64/68-G-E	Joint: CMY-Y62-G-E Header: CMY-Y64/68-G-E	
Remark			In case of connecting All fresh air type indoor unit PEFY-P-VHM-E-F, only one indoor unit can be connected with one PUMY. Details on foundation work, duct work, insulation work, electrical wiring, power source switch, and other items shall be referred to the Installation Manual.		

Note :	*1 Nominal cooling conditions	*2 Nominal cooling conditions	*3 Nominal heating conditions	Unit converter
	Indoor : 27°CDB/19°CWB (81°FDB/66°FWB)	27°CDB/19.5°CWB (81°FDB/67°FWB)	20°CDB (68°FDB)	kcal/h = kW x 860
	Outdoor : 35°CDB (95°FDB)	35°CDB (95°FDB)	7°CDB/6°CWB (45°FDB/43°FWB)	Btu/h = kW x 3,412
	Pipe length : 7.5 m (24-9/16 ft)	5 m (16-3/8 ft)	7.5 m (24-9/16 ft)	cfm = m³/min x 35.31
	Level difference : 0 m (0 ft)	0 m (0 ft)	0 m (0 ft)	lb = kg / 0.4536
* Nominal conditions *1, *2, *3 are subject to JIS B8615-1.				* Above specification data is subject to rounding variation.
* Due to continuing improvement, above specifications may be subject to change without notice.				

Ref. : Spec\_s\_p100\_125VHM

# 1. SPECIFICATIONS

Model			PUMY-P140VHM		
Power source			1-phase 220-230-240V 50Hz, 1-phase 220V 60Hz		
Cooling capacity (Nominal)	*:1	kW	15.5		
	*:1	kcal / h	13,300		
	*:1	Btu / h	52,900		
	*:2	kcal / h	14,000		
		Power input	kW	5.35	
		Current input	A	24.7-23.6-22.7, 24.7	
COP (kW / kW)			2.9		
Temp. range of cooling	Indoor	W.B.	15 ~ 24°C (59 ~ 75°F)		
	Outdoor	D.B.	- 5 ~ 46°C (23 ~ 115°F)		
10 to 46°C D.B. (50 to 115°F D.B.) : in case of connecting PKFY-P20/P25 type indoor unit.					
Heating capacity (Nominal )	*:3	kW	18.0		
	*:3	kcal / h	15,500		
	*:3	Btu / h	61,400		
		Power input	kW	5.58	
		Current input	A	25.8-24.7-23.6, 25.8	
	COP (kW / kW)			3.23	
Temp. range of heating	Indoor temp.	D.B.	15 ~ 27°C (59 ~ 81°F)		
	Outdoor temp.	W.B.	-15 ~ 15°C (5 ~ 59°F)		
Indoor unit connectable	Total capacity		50 ~ 130% of outdoor unit capacity		
	Model / Quantity		P20 ~ P140 / 1 ~ 8		
Noise level (measured in anechoic room)	dB <A>		51 / 53		
Diameter of refrigerant pipe	Liquid (High press.)	mm (in.)	ø9.52 (ø3/8") Liquid		
	Gas (Low press.)	mm (in.)	ø15.88 (ø5/8") Gas		

External finish			Galvanized steel sheet <MUNSELL 3Y 7.8/1.1>	
External dimension H x W x D	mm		1,350 x 950 x 330	
	in.		53-3/16" x 37-7/16" x 13"	
Net weight	kg (lb)		127 (280 lb)	
Heat exchanger			Salt-resistant cross fin & copper tube	
Compressor	Type		Inverter scroll hermetic comp.	
	Manufacturer		MITSUBISHI ELECTRIC CORPORATION	
	Starting method		Inverter	
	Motor output	kW	3.3	
	Case heater	kW	-	
	Lubricant		MEL56 x 2.3L	
FAN	Air flow rate	m <sup>3</sup> / min	100	
		L / s	1667	
		cfm	3532	
	External static press.		0 Pa	
	Type x Quantity		Propeller fan x 2	
	Control, Driving mechanism		DC-control, Direct-driven by motor	
	Motor output	kW	0.06 x 2	
HIC circuit (HIC: Heat Inter-Changer)			-	
Protection	High pressure protection		High pressure sensor, High pressure switch 4.15 MPa	
	Inverter circuit (COMP. / FAN)		Over-heat protection, Over-current protection	
	Compressor		Discharge thermo protection, Over-current protection	
	Fan motor		Over-heat protection, Voltage protection	
Defrosting method			Auto-defrost mode (Reversed refrigerant circle)	
Refrigerant	Type x Original charge		R410A x 8.5kg (19 lb)	
	Control		LEV circuit	
Drawing	External		VHM-BK01-B434	
	Wiring		VHM-RG79-V221	
	Refrigerant circle		RC_VBN-050092	
Standard attachment	Document		Installation Manual	
	Accessory		Grounded lead wire x 2	
Optional parts			Joint: CMY-Y62-G-E Header:CMY-Y64/68-G-E	
Remark			In case of connecting All fresh air type indoor unit PEFY-P-VHM-E-F, only one indoor unit can be connected with one PUMY. Details on foundation work, duct work, insulation work, electrical wiring, power source switch, and other items shall be referred to the Installation Manual.	

Note :	*:1 Nominal cooling conditions	*:2 Nominal cooling conditions	*:3 Nominal heating conditions	Unit converter
Indoor :	27°CDB/19°CWB (81°FDB/66°FWB)	27°CDB/19.5°CWB (81°FDB/67°FWB)	20°CDB (68°FDB)	kcal/h = kW x 860
Outdoor :	35°CDB (95°FDB)	35°CDB (95°FDB)	7°CDB/6°CWB (45°FDB/43°FWB)	Btu/h = kW x 3,412
Pipe length :	7.5 m (24-9/16 ft)	5 m (16-3/8 ft)	7.5 m (24-9/16 ft)	cfm = m <sup>3</sup> /min x 35.31
Level difference :	0 m (0 ft)	0 m (0 ft)	0 m (0 ft)	lb = kg / 0.4536
* Nominal conditions *:1, *:3 are subject to JIS B8615-1.				*Above specification data is subject to rounding variation.
* Due to continuing improvement, above specifications may be subject to change without notice.				

## 2. CAPACITY TABLES

### 2-1. Correction by temperature

CITY MULTI™ could have varied capacity at different designing temperature. Using the nominal cooling/heating capacity value and the ratio below, the capacity can be observed at various temperature.

PUMY-		P100YHM	P125YHM
Nominal Cooling Capacity	kW	11.2	14.0
	kcal/h	9,600	12,000
	Btu/h	38,200	47,800
Input	kW	3.30	4.27

PUMY-		P140YHM
Nominal Cooling Capacity	kW	15.5
	kcal/h	13,300
	Btu/h	52,900
Input	kW	5.32

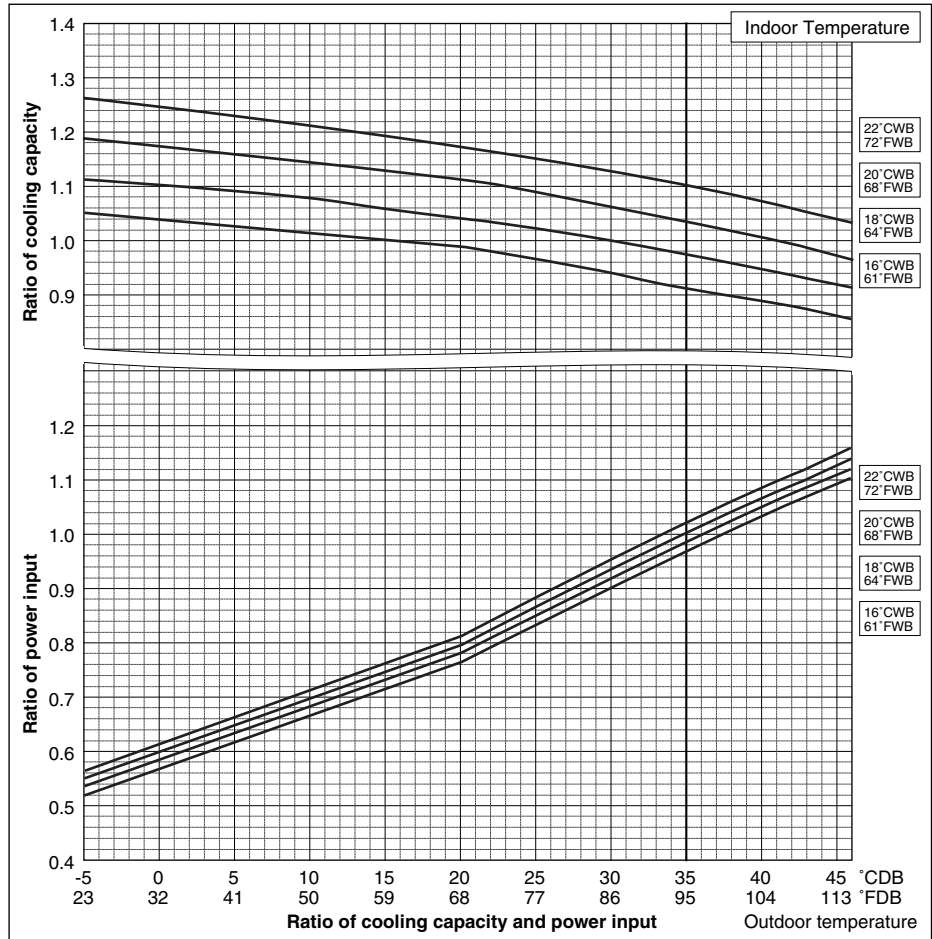

PUMY-		P100YHM	P125YHM
Nominal Heating Capacity	kW	12.5	16.0
	kcal/h	10,800	13,800
	Btu/h	42,700	54,600
Input	kW	3.63	4.29

PUMY-		P140YHM
Nominal Heating Capacity	kW	18.0
	kcal/h	15,500
	Btu/h	61,400
Input	kW	5.32

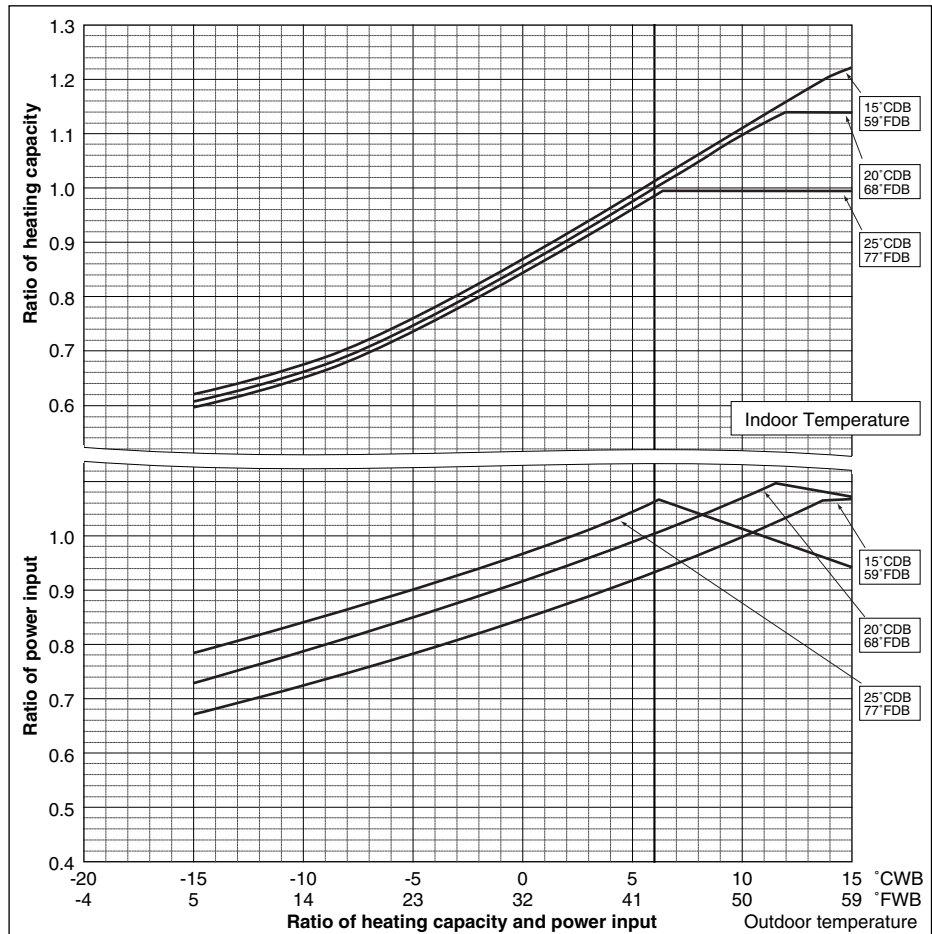

Ref:cbl\_p100-140



## 2. CAPACITY TABLES

### 2-1. Correction by temperature

CITY MULTI™ could have varied capacity at different designing temperature. Using the nominal cooling/heating capacity value and the ratio below, the capacity can be observed at various temperature.

PUMY-		P100VHM	P125VHM
Nominal Cooling Capacity	kW	11.2	14.0
	kcal/h	9,600	12,000
	Btu/h	38,200	47,800
Input	kW	3.34	4.32

PUMY-		P140VHM
Nominal Cooling Capacity	kW	15.5
	kcal/h	13,300
	Btu/h	52,900
Input	kW	5.35

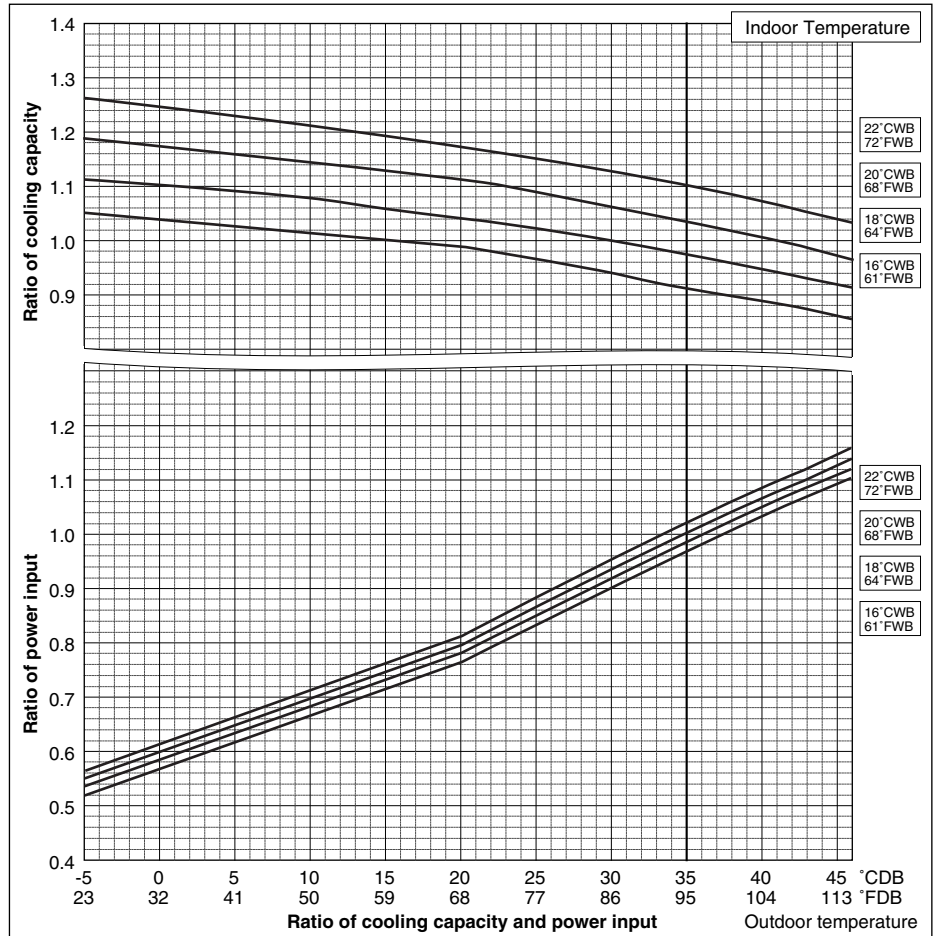

PUMY-		P100VHM	P125VHM
Nominal Heating Capacity	kW	12.5	16.0
	kcal/h	10,800	13,800
	Btu/h	42,700	54,600
Input	kW	3.66	4.33

PUMY-		P140VHM
Nominal Heating Capacity	kW	18.0
	kcal/h	15,500
	Btu/h	61,400
Input	kW	5.58

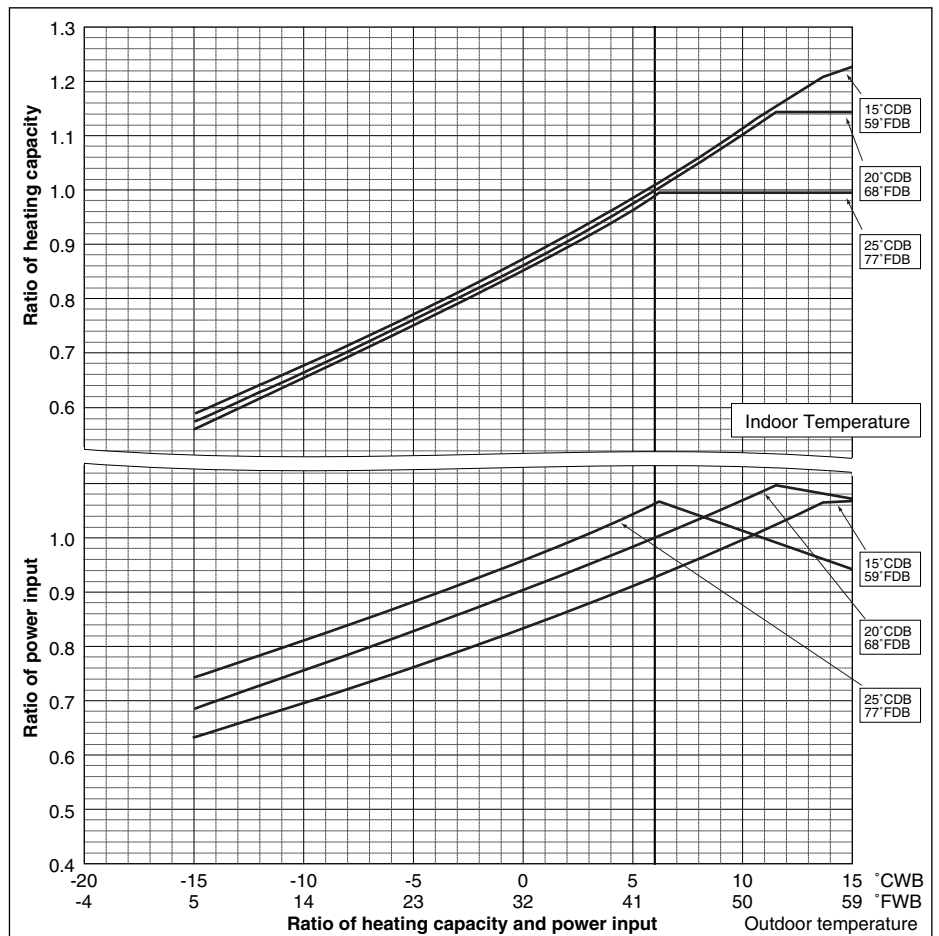

## 2. CAPACITY TABLES

### 2-2. Correction by total indoor

CITY MULTI™ system has different capacity and input at different total capacity of indoor unit connected. Using following tables, the maximum capacity can be observed so as to ensure the system having enough capacity.

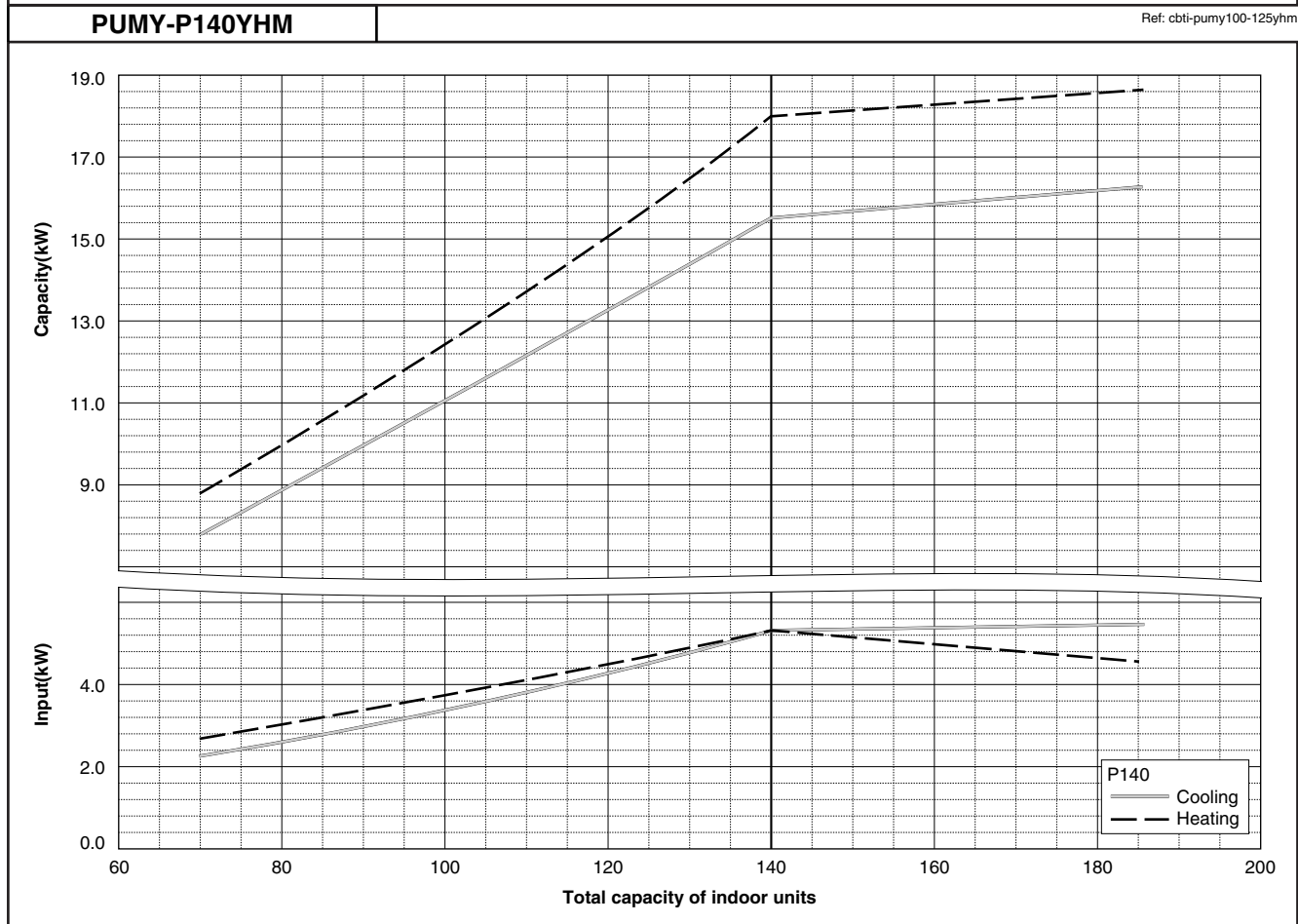
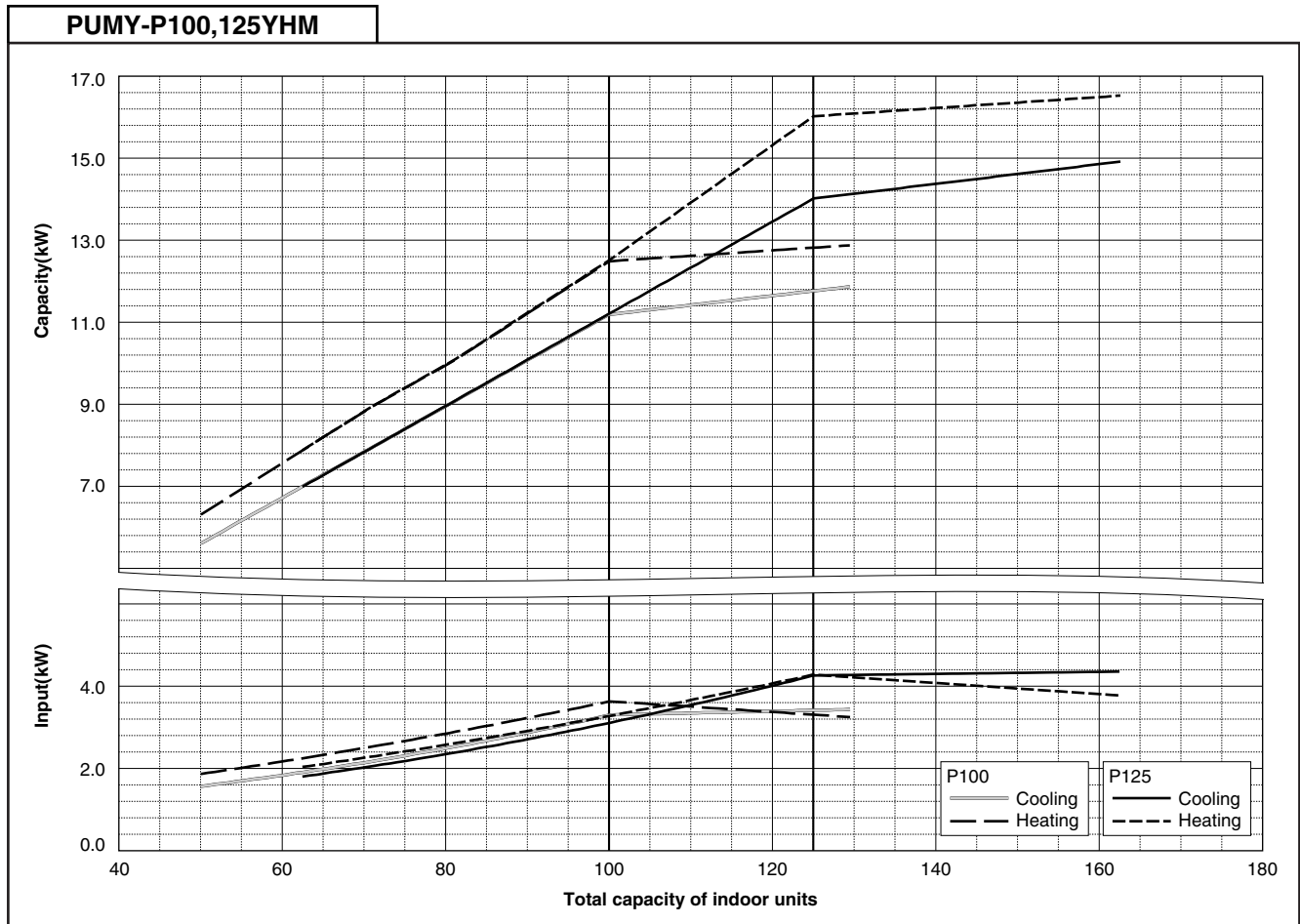

Ref: cbti-pumy140yhm



## 2. CAPACITY TABLES

### 2-2. Correction by total indoor

CITY MULTI™ system has different capacity and input at different total capacity of indoor unit connected. Using following tables, the maximum capacity can be observed so as to ensure the system having enough capacity.

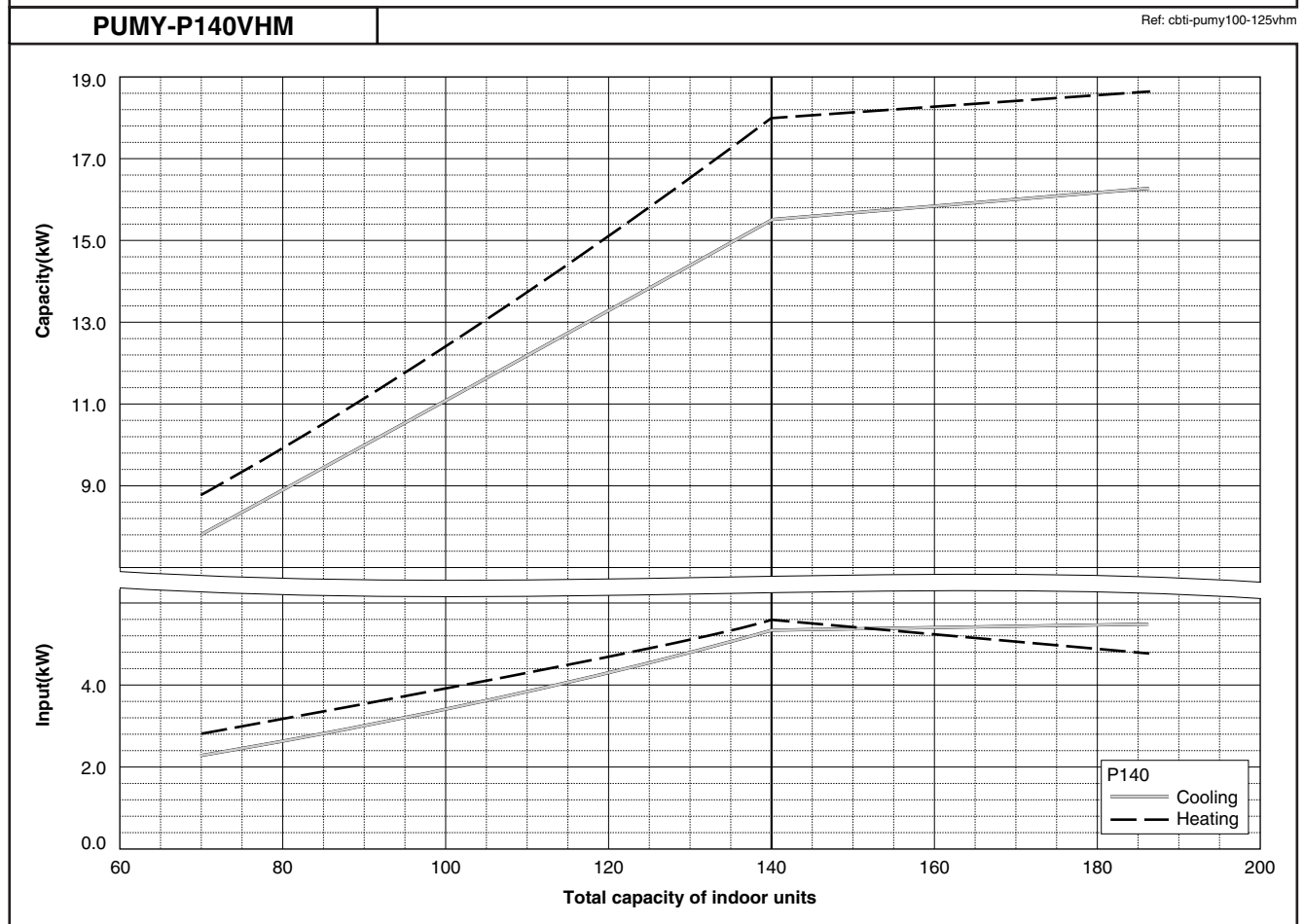
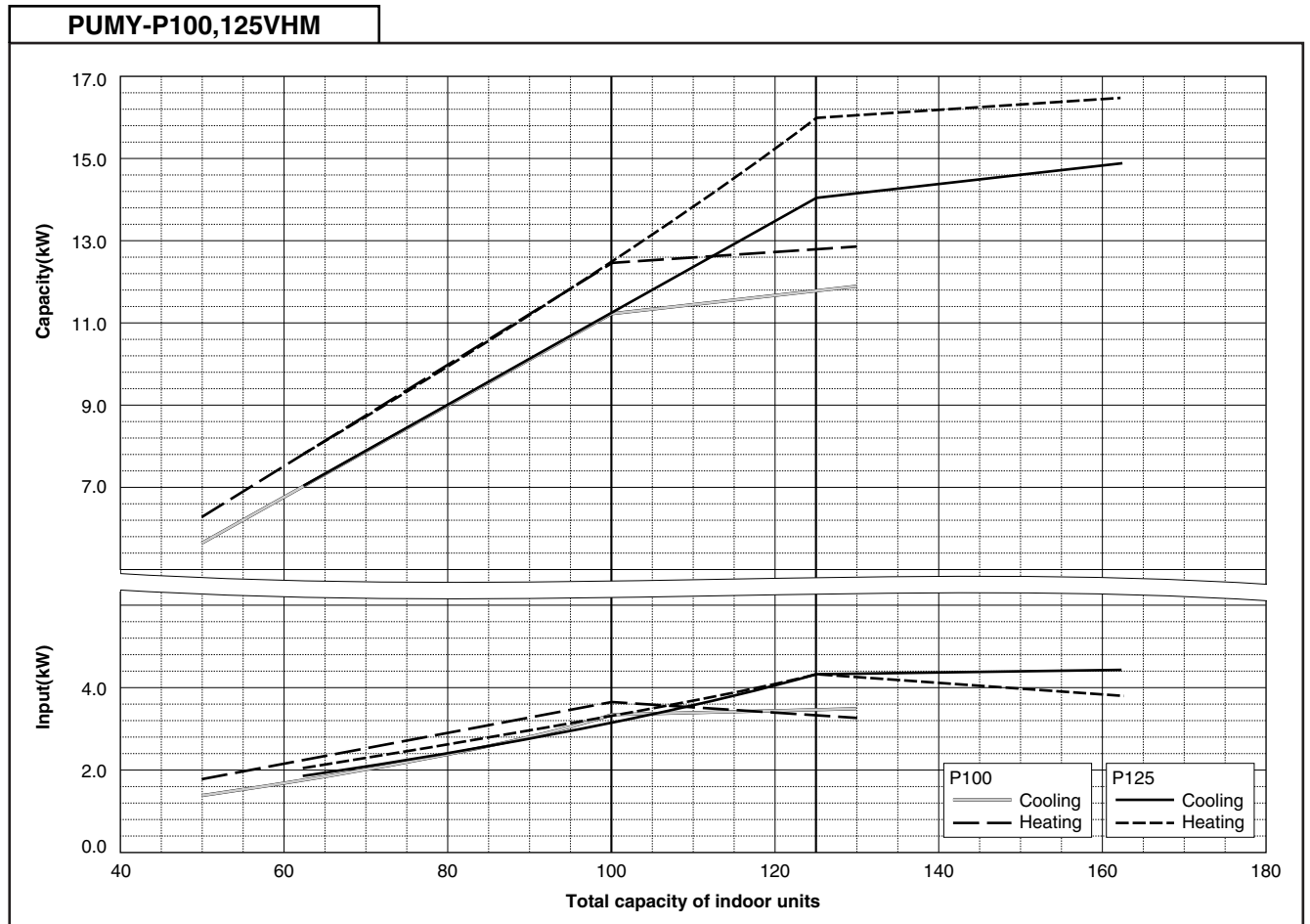

### 2-3. Correction by refrigerant piping length

CITY MULTI™ system can extend the piping flexibly within its limitation for the actual situation. Yet, a decrease of cooling/heating capacity could happen correspondently. Using following correction factor according to the equivalent length of the piping shown at 2.3a and 2.3b, the capacity can be observed. 2.3c shows how to obtain the equivalent length of piping.

#### 2-3a. Cooling capacity correction

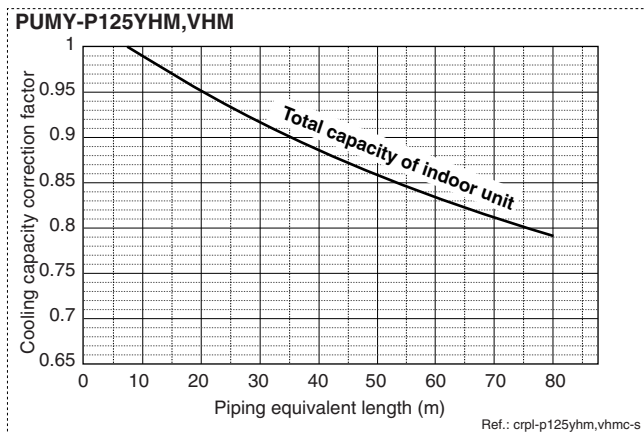
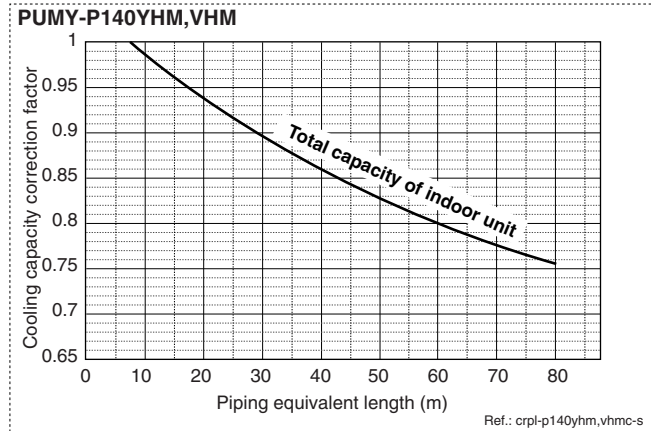
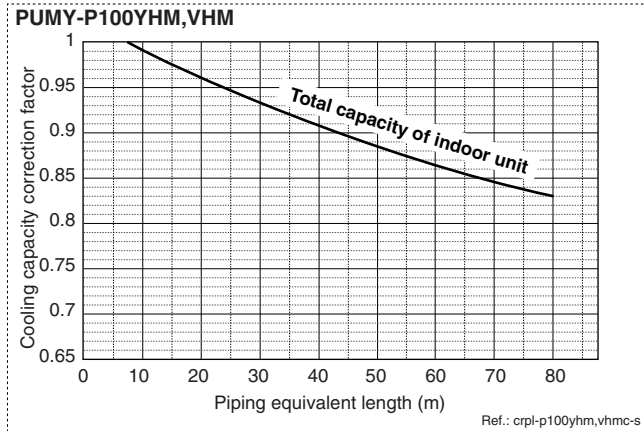

#### 2-3b. Heating capacity correction

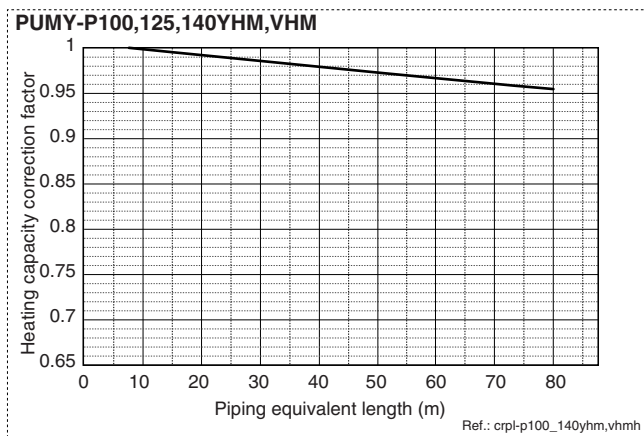

#### 2-3c. How to obtain the equivalent length of piping

##### 1 PUMY-P100,125,140YHM,VHM

Equivalent length = (Actual piping length to the farthest indoor unit) + (0.30 x number of bent on the piping) m

### 2-4. Correction at frosting and defrosting

Due to frosting at the outdoor heat exchanger and the automatic defrosting operation, the heating capacity of the outdoor unit should be considered by multiplying the correction factor which shown in the table below.

Table of correction factor at frosting and defrosting

Outdoor inlet air temp. °C	6	4	2	1	0	-2	-4	-6	-8	-10	-20
Outdoor inlet air temp. °F	43	39	36	34	32	28	25	21	18	14	-4
PUMY-P100,125,140YHM	1.0	0.98	0.855	0.85	0.845	0.89	0.90	0.95	0.95	0.95	-
PUMY-P100,125,140VHM	1.0	0.98	0.855	0.85	0.845	0.89	0.90	0.95	0.95	0.95	-

### 2-5. Temp. range of running

#### • Cooling

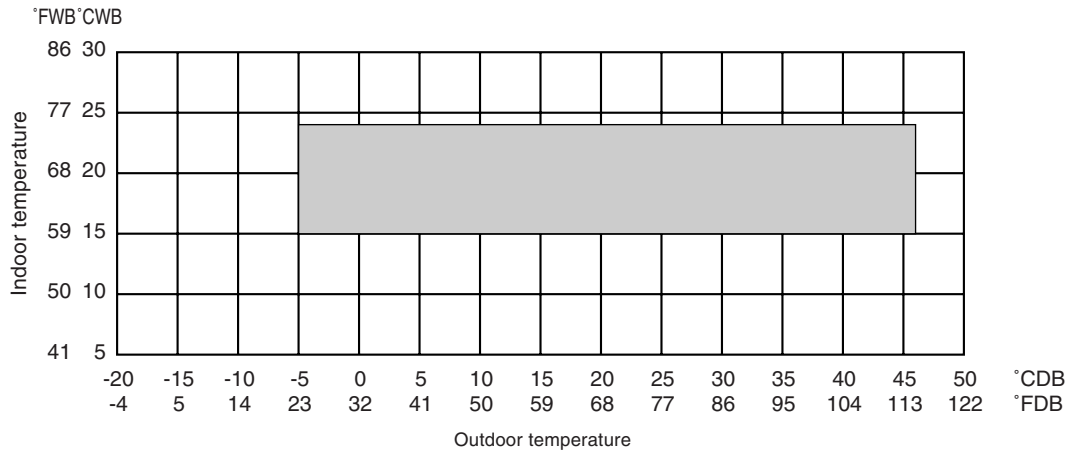

#### • Heating

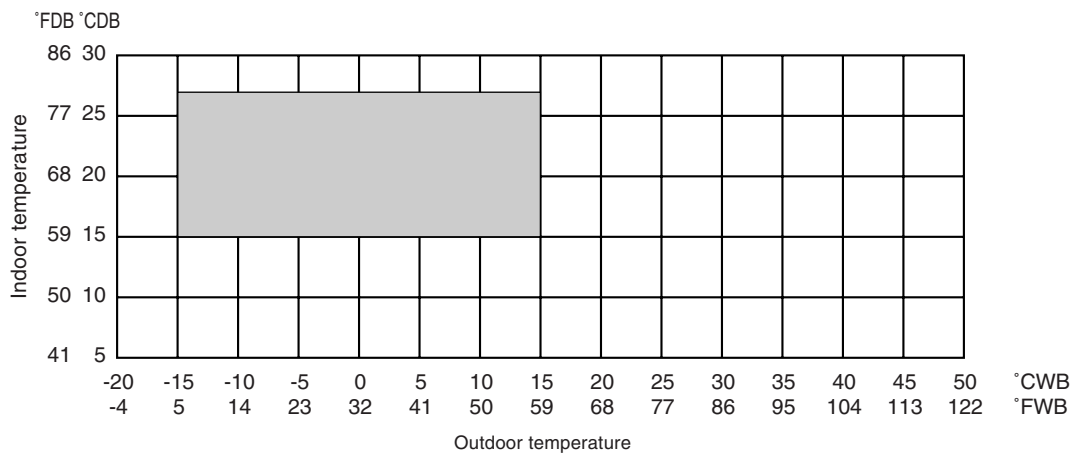

**Measurement condition**  
**PUMY-P100,125,140YHM**  
**PUMY-P100,125,140VHM**

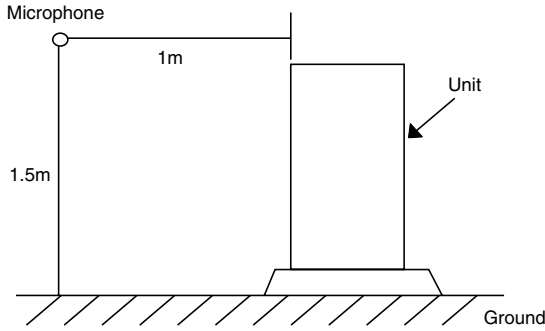

### Sound level of PUMY-P140YHM,VHM

Ref. : P140YHM,VHM-VBN-050093

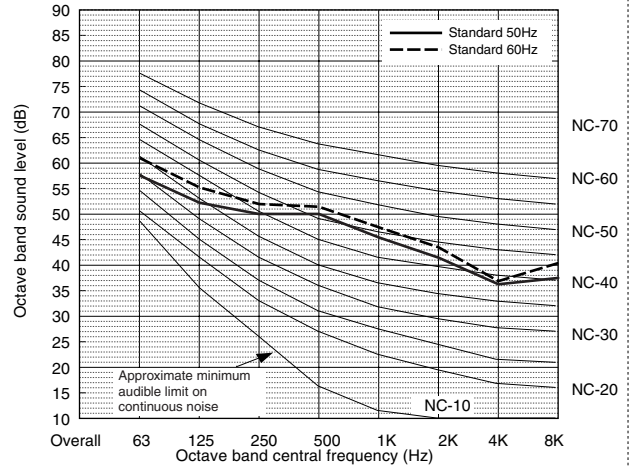

		63Hz	125Hz	250Hz	500Hz	1000Hz	2000Hz	4000Hz	8000Hz	dB(A)
Standard	50Hz	57.2	51.7	49.9	49.8	45.5	41.1	35.9	37.1	51.0
	60Hz	60.9	55.4	52.1	51.4	47.5	43.2	37.1	40.3	53.0
Night mode	50/60Hz	-	-	-	-	-	-	-	-	-

\* When Night Mode is set, the A/C system's capacity is limited. The system could return to normal operation from Night Mode automatically in the case that the operation condition is severe.

### Sound level of PUMY-P100YHM,VHM

Ref. : P100YHM,VHM-VBN-050093

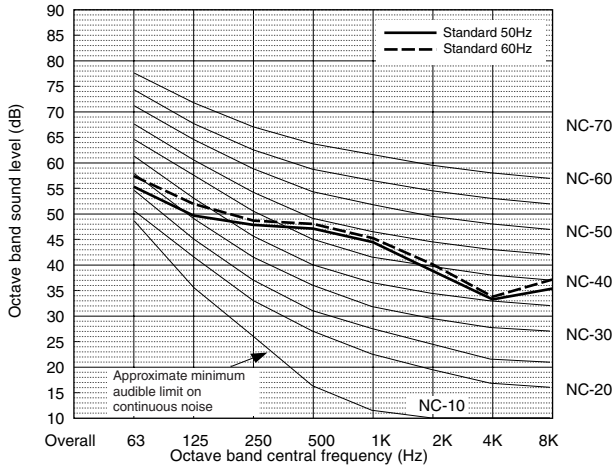

		63Hz	125Hz	250Hz	500Hz	1000Hz	2000Hz	4000Hz	8000Hz	dB(A)
Standard	50Hz	55.2	49.7	47.9	47.8	43.5	39.1	33.9	35.1	49.0
	60Hz	58.9	53.4	50.1	49.4	45.5	41.2	35.1	38.3	51.0
Night mode	50/60Hz	-	-	-	-	-	-	-	-	-

\* When Night Mode is set, the A/C system's capacity is limited. The system could return to normal operation from Night Mode automatically in the case that the operation condition is severe.

### Sound level of PUMY-P125YHM,VHM

Ref. : P125YHM,VHM-VBN-050093

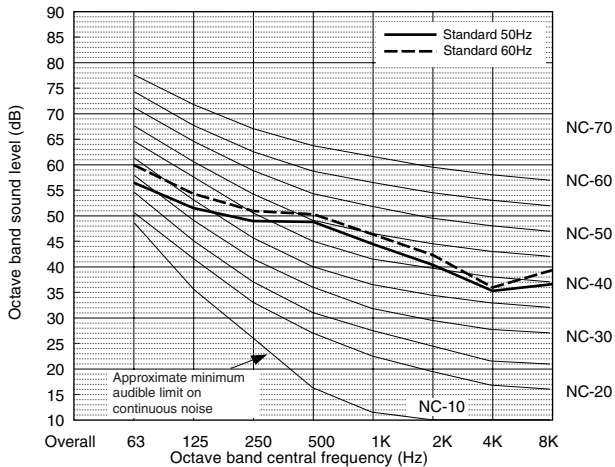

		63Hz	125Hz	250Hz	500Hz	1000Hz	2000Hz	4000Hz	8000Hz	dB(A)
Standard	50Hz	56.2	50.7	48.9	48.8	44.5	40.1	34.9	36.1	50.0
	60Hz	59.9	54.4	51.1	50.4	46.5	42.2	36.1	39.3	52.0
Night mode	50/60Hz	-	-	-	-	-	-	-	-	-

\* When Night Mode is set, the A/C system's capacity is limited. The system could return to normal operation from Night Mode automatically in the case that the operation condition is severe.

## PUMY-P100,125,140YHM

Draw. : YHM-BK01-B328  
Unit : mm

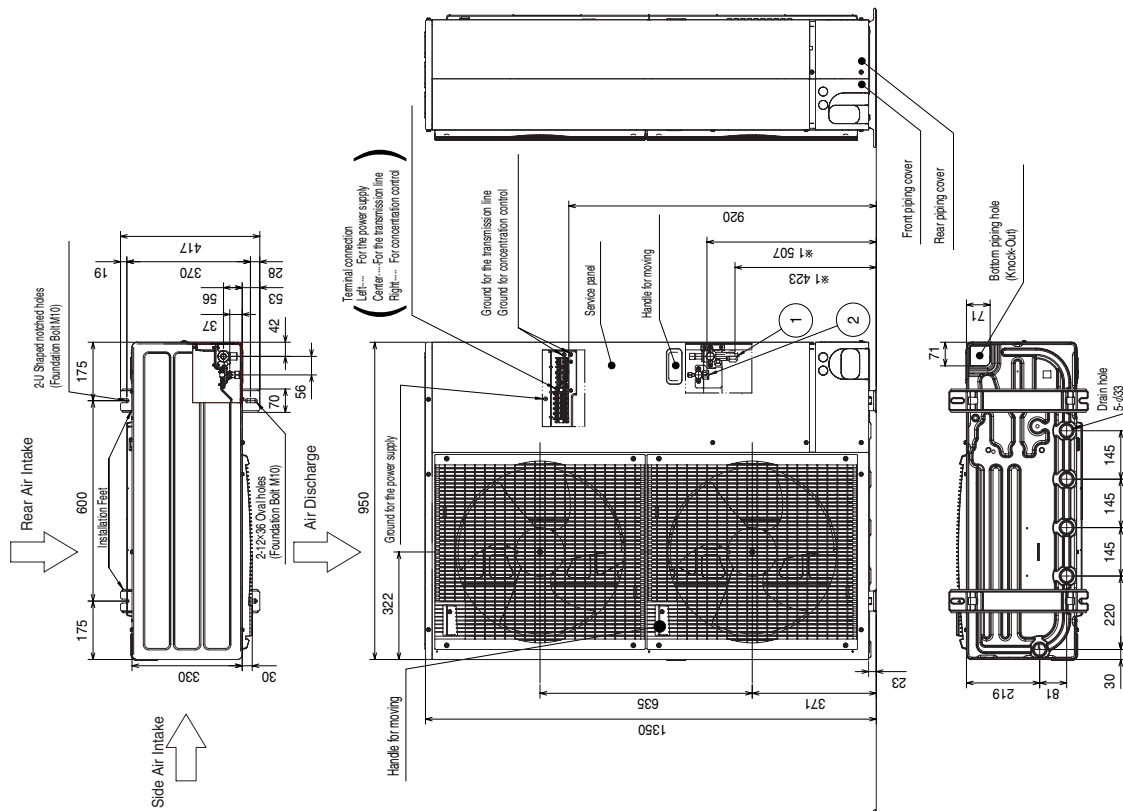

**1 FREE SPACE (Around the unit)**  
The diagram below shows a basic example. Explanation of particular details are given in the installation manuals etc.

**2 SERVICE SPACE**  
Dimensions of space needed for service access are shown in the below diagram.

**3 FOUNDATION BOLTS**  
Please secure the unit firmly with 4 foundation (M10) bolts. (Bolts and washers must be purchased locally.)

**4 PIPING-WIRING DIRECTIONS**  
Piping and wiring connections can be made from 4 directions: FRONT, Right, Rear and Below.

### Example of Notes

- ① Refrigerant GAS pipe connection:  $\phi 15.88$  (5/8") Flare
- ② Refrigerant LIQUID pipe connection:  $\phi 9.52$  (3/8") Flare
- \*1 Indication of STOP VALVE connection location.

### Piping Knock-Out Hole Details

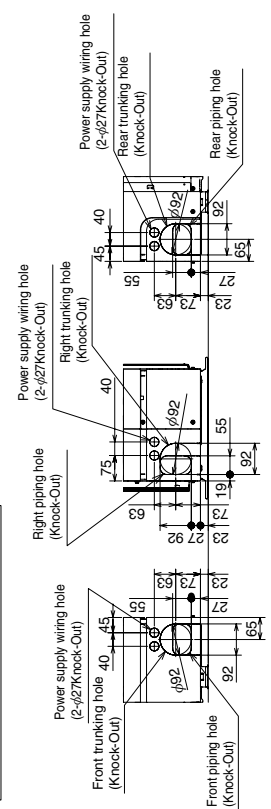

PUMY-P100,125,140VHM

Drw. : VHM-BK01-B434  
Unit : mm

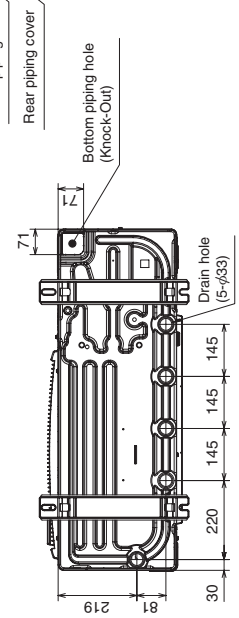
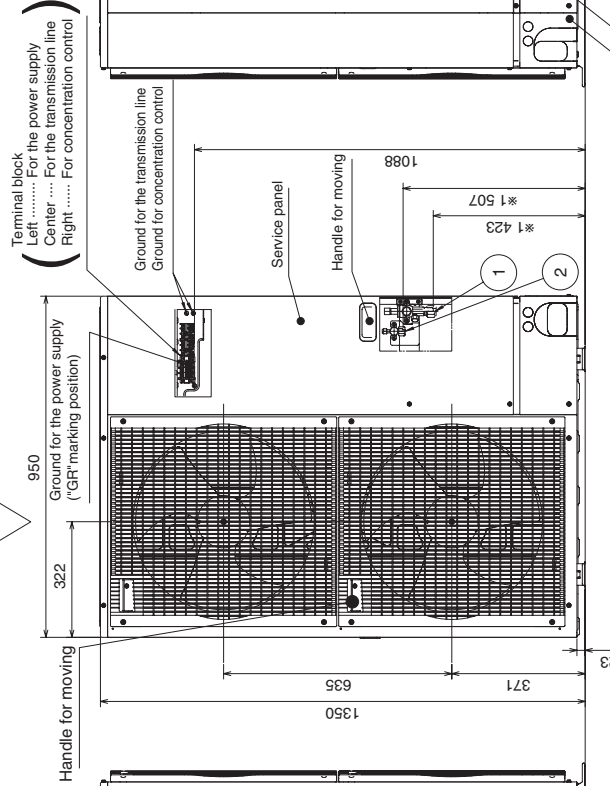
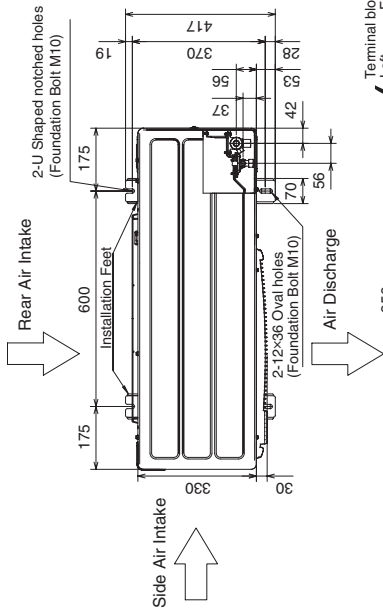

**1 FREE SPACE (Around the unit)**  
The diagram below shows a basic example.  
Explanation of particular details are given in the installation manuals etc.

**2 SERVICE SPACE**  
Dimensions of space needed for service access are shown in the below diagram.

**3 FOUNDATION BOLTS**  
Please secure the unit firmly with 4 foundation (M10) bolts. Bolts and washers must be purchased locally.

**4 PIPING-WIRING DIRECTIONS**  
Piping and wiring connections can be made from 4 directions: FRONT, Right, Rear and Below.

**Example of Notes**  
 ① Refrigerant GAS pipe connection (FLARE) φ15.88(5/8F)  
 ② Refrigerant LIQUID pipe connection (FLARE) φ9.52(3/8F)  
 ※1 ..... Indication of STOP VALVE connection location.

Piping Knock-Out Hole Details

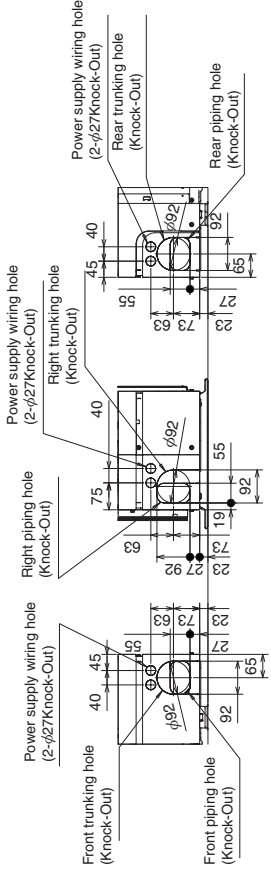



## PUMY-P100,125,140YHM

Draw. : YHM-RG79-V020

SYMBOL	NAME	SYMBOL	NAME	SYMBOL	NAME
TB1	Terminal Block <Power Supply>	SV1	Connector<Bypass Valve>	N.F.	Noise Filter Circuit Board
TB3	Terminal Block <Transmission>	SS	Connector<For Option>	L1/L12/L13/N	Connection Terminal<L1/L2/L3/N-Power Supply>
TB7	Terminal Block <Centralized Control>	CN3D	Connector<For Option>	L01/L02/L03/N0	Connection Terminal<L1/L2/L3/N-Power Supply>
MC	Motor for Compressor	CN3S	Connector<For Option>	CNAC1	Connector<To Transmission Power Board>
MF1,MF2	Fan Motor	CN3N	Connector<For Option>	CNAC2	Connector<To Multi Controller Board>
21S4	Solenoid Valve<Four way valve>	CN51	Connector<For Option>	CNCT	Connector<To Power Circuit Board>
SV1	Solenoid Valve<Bypass valve>	X501-505	Relay	CNL	Connector<To Reactor>
TH3	Thermistor<Outdoor Pipe Temperature>	CONV.B.	Converter Circuit Board	FUSE	Fuse<6.3A>
TH4	Thermistor<Discharge Temperature>	L1-A1,L1-IN	Connection Terminal<L1-Power Supply>	M-P.B.	Transmission Power Board
TH6	Thermistor<Low Pressure Saturated Temperature>	L1-A2,L1-OU	Connection Terminal<L1-Power Supply>	CN1	Connector<To Noise Filter Circuit Board>
TH7	Thermistor<Outdoor Temperature>	L2-A2,L2-OU	Connection Terminal<L2-Power Supply>	CN2	Connector<To Multi Controller Board>
63HS	High Pressure Sensor<Discharge Pressure>	L3-A2,L3-OU	Connection Terminal<L3-Power Supply>		
63H	High Pressure Switch	N-IN	Connection Terminal		
63L	Low Pressure Switch	CK-OU	Connection Terminal		
CB1,CB2	Main Smoothing Capacitor	CN7	Connector<To Power Circuit Board>		
CK	Capacitor				
RS	Rush Current Protect Resistor				
ACL1-ACL4	Reactor				
P.B	Power Circuit Board				
TB-U/V/W	Connection Terminal<U/V/W-Phase>				
TB-L1/L2/L3	Connection Terminal<L1/L2/L3-Power Supply>				
TB-P2	Connection Terminal				
TB-C1	Connection Terminal				
TB-N1	Connection Terminal				
CN2	Connection <To Multi Controller Boards>				
CN4	Connection <To Multi Controller Boards>				
CN5	Connection <To Noise Filter Circuit Board>				
CNDC	Connection <To Multi Controller Board>				
MULTI.B.	Multi Controller Board				
F1,F2	Fuse<6.3A>				
F500	Fuse<3A>				
SW1	Switch<Display Selection>				
SW2	Switch<Function Selection>				
SW3	Switch<Test Run>				
SW4	Switch<Model Selection>				
SW5	Switch<Function Selection>				
SW6	Switch<Function Selection>				
SW7	Switch<Function Selection>				
SW8	Switch<Function Selection>				
SWU1	Switch<Unit Address Selection, 1st digit>				
SWU2	Switch<Unit Address Selection, 2nd digit>				
TRANS	Transformer				
LED1,2	Digital Indicator<Operation Inspection Display>				
LED3	LED<Power Supply to Main Microcomputer>				
CNS1	Connector<Multi System>				
CNS2	Connector<Centralized Control>				
CNAC	Connector<To Noise Filter Circuit Board>				
CNDC	Connector<To Noise Filter Circuit>				
CN2	Connector<To Power Circuit Board>				
CN4	Connector<To Power Circuit Board>				
CN40	Connector<Centralized Control Power Supply>				
CN41	Connector<For storing Jumper Connector>				
TH3	Connector<Thermistor>				
TH4	Connector<Thermistor>				
TH7/6	Connector<Thermistor>				
63HS	Connector<High Pressure Sensor>				
63H	Connector<High Pressure Switch>				
63L	Connector<Low Pressure Switch>				
CNF1,CNF2	Connector<Fan Motor>				
21S4	Connector<Four-way Valve>				

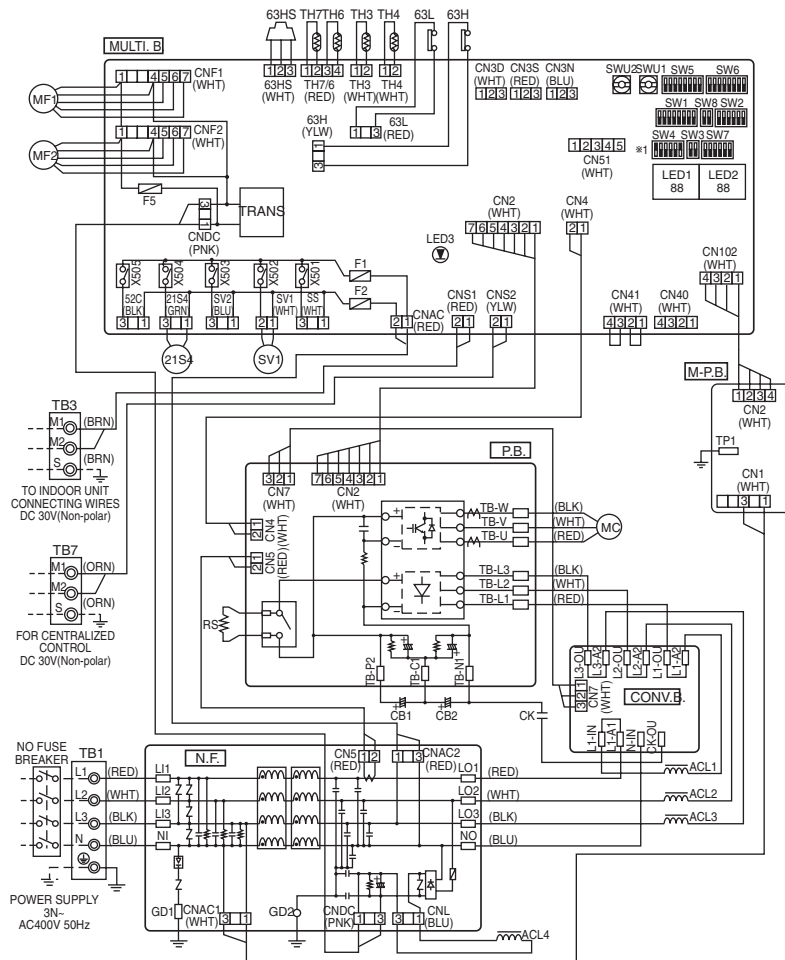

\*1 MODEL SELECT 1:ON 0:OFF

MODELS	1	2	3	4	5	6	7	8
PUMY-P100YHM	1	1	0	0	1	1	0	1
PUMY-P125YHM	1	1	0	0	0	1	1	0
PUMY-P140YHM	1	1	0	0	0	1	1	1

### Cautions when Servicing

- ⚠ **WARNING:** When the main supply is turned off, the voltage [540 V] in the main capacitor will drop to 20 V in approx. 5 minutes (input voltage: 380 V). When servicing, make sure that LED1, LED2 on the outdoor circuit board goes out, and then wait for at least 5 minute. Components other than the outdoor board may be faulty: Check and take corrective action, referring to the service manual. Do not replace the outdoor board without checking.

### NOTES:

1. Refer to the wiring diagrams of the indoor units for details on wiring of each indoor unit.
  - Self-diagnosis function
  - The indoor and outdoor units can be diagnosed automatically using the self-diagnosis switch (SW1) and LED1, LED2 (LED indication) found on the multi-controller of the outdoor unit.
  - LED indication : Set all contacts of SW1 to OFF.
  - During normal operation
  - The LED indicates the drive state of the controller in the outdoor unit.

[Example]  
When the compressor and SV1 are turned during cooling operation.

Bit	1	2	3	4	5	6	7	8
Indication	Compressor operated	52C	21S4	SV1	(SV2)	—	—	Always lit

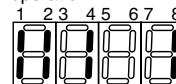

When fault requiring inspection has occurred  
The LED alternately indicates the inspection code and the location of the unit in which the fault has occurred.

PUMY-P100,125,140VHM

Drw. : VHM-RG79-V221

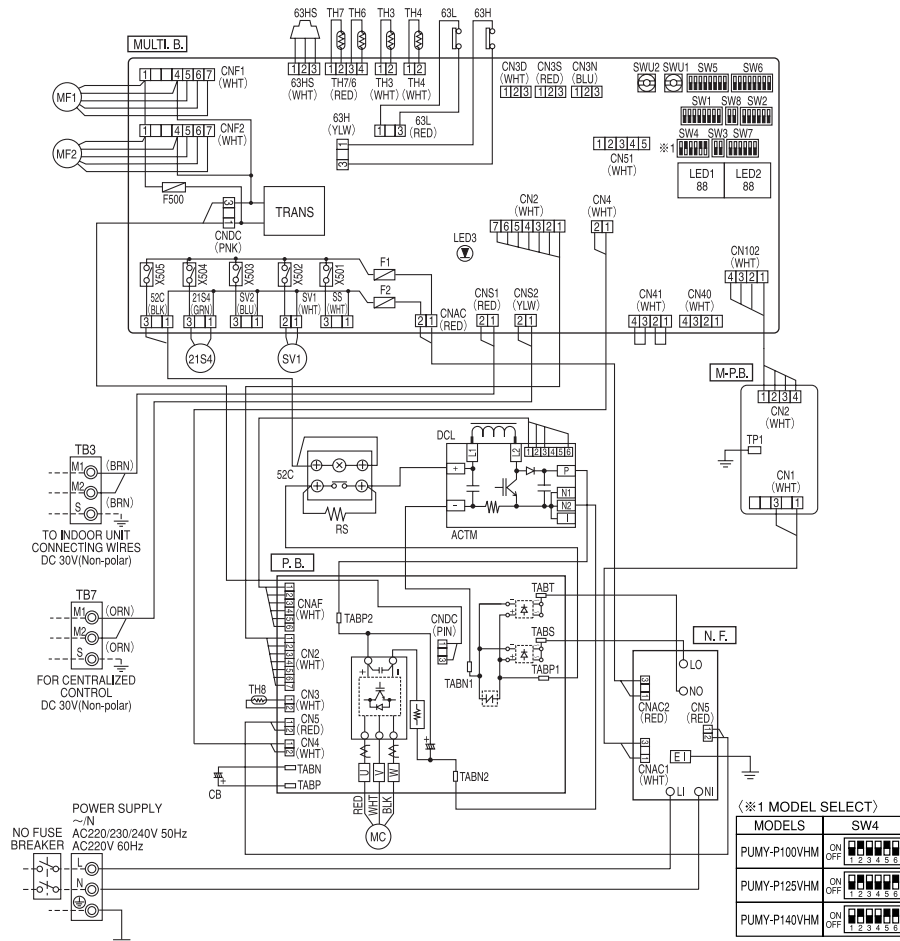

SYMBOL	NAME	SYMBOL	NAME	SYMBOL	NAME
TB1	Terminal Block (Power Supply)	IPM	Inverter	CNAC	Connector (To Noise Filter Circuit Board)
TB3	Terminal Block (Transmission)	LED1	Light Emitting Diodes (Inverter Control Status)	CNDC	Connector (To Noise Filter Circuit)
TB7	Terminal Block (Centralized Control)	N.F.	Noise Filter Circuit Board	CN2	Connector (To Power Circuit Board)
MC	Motor for Compressor	LI/LO	Connection Lead (L-Phase)	CN4	Connector (To Power Circuit Board)
MF1, MF2	Fan Motor	NI/NO	Connection Lead (N-Phase)	CN40	Connector (Centralized Control Power Supply)
SV1	Solenoid Valve (Four way valve)	EI	Connection Terminal (Ground)	CN41	Connector (For storing Jumper Connector)
SV2	Solenoid Valve (Bypass valve)	CNAC1/2	Connector	TH3	Connector (Thermistor)
TH3	Thermistor (Outdoor Pipe Temperature)	CN5	Connector	TH4	Connector (Thermistor)
TH4	Thermistor (Discharge Temperature)	MULTI.B.	Multi Controller Board	TH7/6	Connector (Thermistor)
TH6	Thermistor (Low Pressure Saturated Temperature)	F1, F2	Fuse (6.3A)	63HS	Connector (High Pressure Sensor)
TH7	Thermistor (Outdoor Temperature)	F500	Fuse (3A)	63H	Connector (High Pressure Switch)
63HS	High Pressure Sensor (Discharge Pressure)	SW1	Switch (Display Selection)	63L	Connector (Low Pressure Switch)
63H	High Pressure Switch	SW2	Switch (Function Selection)	CNF1, CNF2	Connector (Fan Motor)
63L	Low Pressure Switch	SW3	Switch (Test Run)	21S4	Connector (Four-way Valve)
CB	Main Smoothing Capacitor	SW4	Switch (Model Selection)	SV1	Connector (Bypass Valve)
ACTM	Active filter Module	SW5	Switch (Function Selection)	SS	Connector (For Option)
RS	Rush Current Protect Resistor	SW6	Switch (Function Selection)	CN3D	Connector (For Option)
DCL	Reactor	SW7	Switch (Function Selection)	CN3S	Connector (For Option)
P.B.	Power Circuit Board	SW8	Switch (Function Selection)	CN3N	Connector (For Option)
U/V/W	Connection Terminal (U/V/W-Phase)	SWU1	Switch (Unit Address Selection, 1st digit)	CN3N	Connector (For Option)
TAB-S/T	Terminal (L/N-Phase)	SWU2	Switch (Unit Address Selection, 2nd digit)	CN51	Connector (For Option)
TAB-PP1/P2	Terminal (DC Voltage)	TRANS	Transformer	X501~505	Relay
TAB-NN1/N2	Terminal (DC Voltage)	LED1.2	Digital Indicator (Operation Inspection Display)	M-P.B.	Transmission Power Board
CN2~5	Connector	LED3	LED (Power Supply to Main Microcomputer)	CN1	Connector (To Noise Filter Circuit Board)
CNDC	Connector	CN1	Connector (Multi System)	CN2	Connector (To Multi Controller Board)
CNAF	Connector	CN2	Connector (Centralized Control)		

Cautions when Servicing

- ⚠ WARNING: When the main supply is turned off, the voltage [340 V] in the main capacitor will drop to 20 V in approx. 2 minutes (input voltage: 240 V). When servicing, make sure that LED1, LED2 on the outdoor circuit board goes out, and then wait for at least 1 minute.
- Components other than the outdoor board may be faulty: Check and take corrective action, referring to the service manual. Do not replace the outdoor board without checking.

NOTES:

- Refer to the wiring diagrams of the indoor units for details on wiring of each indoor unit. Self-diagnosis function  
The indoor and outdoor units can be diagnosed automatically using the self-diagnosis switch (SW1) and LED1, LED2 (LED indication) found on the multi-controller of the outdoor unit.  
LED indication : Set all contacts of SW1 to OFF.

- During normal operation
- The LED indicates the drive state of the controller in the outdoor unit.

Bit	1	2	3	4	5	6	7	8
Indication	Compressor operated	52C	21S4	SV1	(SV2)	—	—	Always lit

- When fault requiring inspection has occurred  
The LED alternately indicates the inspection code and the location of the unit in which the fault has occurred.

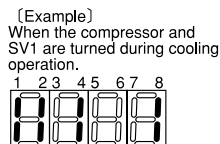

PUMY-P100,125,140YHM  
PUMY-P100,125,140VHM

Draw : RC\_VBN-050092

..... Refrigerant flow in cooling  
——— Refrigerant flow in heating

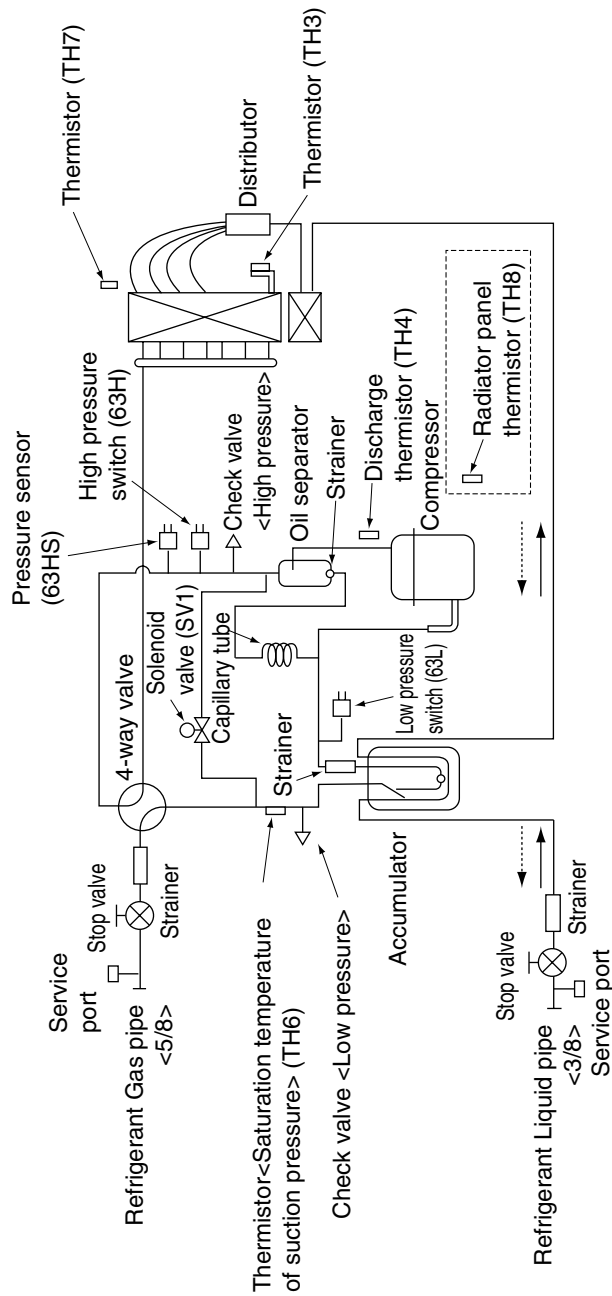

Refrigerant piping specifications <dimensions of flared connector>

Capacity	Item	Liquid piping	Gas piping
Indoor unit	P20, P25, P32, P40, P50	φ 6.35 <1/4">Flare	φ 12.7 <1/2">Flare
	P63, P80, P100 P125, P140	φ 9.52 <3/8">Flare	φ 15.88 <5/8">Flare
Outdoor unit	P100, P125, P140	φ 9.52 <3/8">Flare	φ 15.88 <5/8">Flare