



**MITSUBISHI
ELECTRIC**

CITY MULTI

Changes for the Better

CITY MULTI DATA BOOK

CITY MULTI

2003-2004

CITY MULTI

I Outdoor Unit

P. I -1 ~ I -256

Introduction	I -2
R407C refrigerant unit	
S series	
PUMY-P125VMA	I -3
PUMY-P125YMA	I -15
Y series	
PUHY-P200-250-315YEM-A(-BF, -BS)	I -27
PUY-P200-250-315YEM-A(-BF, -BS)	I -27
Big Y series	
PUHY-P400-500YEM-A(-BF, -BS)	I -43
Super Y series	
PUHY-P600-650-700-750YSEM-A(-BF, -BS)	I -55
R2 series	
PURY-P200-250YEM-A(-BF, -BS)	I -75
Big R2 series	
PURY-P400-500YEM-A	I -87
WY series	
PQHY-P200-250YEM-A	I -99
WR2 series	
PQRY-P200-250YEM-A	I -125
R22 refrigerant unit	
S series	
PUMY-71VM-125VMA	I -151
PUMY-125YM-125YMA	I -165
Y series	
PUHY-200-250-315YEM-A(-BF, -BS)	I -177
PUY-200-250-315YEM-A(-BF, -BS)	I -177
PUHY-250-315YEMK-A	I -177
PUHY-200-250-315YEMC-A(-BS)	I -177
PUHY-200-250-315TEM-A(-BF)	I -193
Big Y series	
PUHY-400-500YEM-A(-BF, -BS)	I -213
PUHY-400-500YEMK-A	I -213
PUHY-400-500YEMC-A(-BS)	I -213
Super Y series	
PUHY-600-650-700-750YSEM-A(-BF, -BS)	I -225
PUHY-600-650-700-750YSEMK-A	I -225
PUHY-600-650-700-750YSEMC-A(-BS)	I -225
R2 series	
PURY-200-250YEMC-A	I -245

II Indoor Unit

P. II -1 ~ II -234

CE indoor unit	
Introduction	II -2
Ceiling concealed	
PEFY-P-VML-A1	II -5
PEFY-P-VMH-A	
PEFY-P-VMM-A	II -35
PEFY-P-VMH-A-F	II -63
Ceiling mounted built-in	
PDFY-P-VM-A	II -77
Floor standing	
Exposed	
PFFY-P-VLEM-A	II -101
Cassette ceiling	
Concealed	
1-way flow	
PMFY-P-VBM-A	II -115
2-way flow	
PLFY-P-VLMD-A	II -127
PLFY-P-VLMD-B	II -127
4-way flow	
PLFY-P-VKM-A/VAM-A	II -151

Wall mounted	PKFY-P-VAM-A/VGM-A	II -169
	PKFY-P-VFM-A	II -185
Ceiling suspended	PCFY-P-VGM-A	II -195
OA Processing unit Non-humidifier	GUF-RD2	II -205
Include humidifier	GUF-RDH2	II -205
LOSSNAY	LGH-RX ₃ -E	II -213
BC controller (with PURY, PQRY)	CMB-P-V-F	II -221
	CMB-P-V-FA	II -221
	CMB-P-V-FB	II -221

III Controller

P. III-1 ~ III-44

Function table of controller		III-2
Local remote controller		
Wired remote controller	PAR-20MAA	III-3
	PAR-F27MEA	III-4
Simple remote controller	PAC-SE51CRA	III-5
Simple MA controller	PAC-YT51CRA	III-6
Wireless remote controller	PAR-FL31MA	III-7
	PAR-FA31MA	
LOSSNAY remote controller	PZ-52SF-E	III-8
Program timer	PAC-YT32PTA	III-9
System controller		
Group remote controller	PAC-SC30GRA	III-10
System remote controller	PAC-SF44SRA	III-12
Schedule timer	PAC-YT34STA	III-14
ON/OFF remote controller	PAC-YT40ANRA	III-16
Centralized controller	G-50A	III-18
	TG-2000A	III-24
	MB-300	III-28
Air conditioner interface	LMAP02-E	III-34
Power supply unit	PAC-SC34KUA	III-36
	PAC-SC50KUA	III-37
Transmission booster unit	PAC-SF46EPA	III-38
System component		III-39

IV System Design

P. IV-1 ~ IV-68

Electrical Work & M-NET control	IV-2
Refrigerant & Piping	IV-21
Caution For Refrigerant Leak	IV-66

CITY MULTI OUTDOOR UNIT

CONTENTS

Introduction	I -2
R407C refrigerant & CE units	
S series	PUMY-P125VMA I -3
	PUMY-P125YMA I -15
Y series	PUHY-P200-250-315YEM-A(-BF, -BS) I -27
	PUY-P200-250-315YEM-A(-BF, -BS) I -27
Big Y series	PUHY-P400-500YEM-A(-BF, -BS) I -43
Super Y series	PUHY-P600-650-700-750YSEM-A(-BF, -BS) I -55
R2 series	PURY-P200-250YEM-A(-BF, -BS) I -75
Big R2 series	PURY-P400-500YEM-A(-BF, -BS) I -87
WY series	PQHY-P200-250YEM-A..... I -99
WR2 series	PQRY-P200-250YEM-A I -125
R22 refrigerant units	
S series	PUMY-71VM-125VMA..... I -151
	PUMY-125YM-125YMA I -165
Y series	PUHY-200-250-315YEM-A(-BF, -BS) ... I -177
	PUY-200-250-315YEM-A(-BF, -BS) I -177
	PUHY-250-315YEMK-A..... I -177
	PUHY-200-250-315YEMC-A(-BS) I -177
	PUHY-200-250-315TEM-A(-BF) I -197
Big Y series	PUHY-400-500YEM-A(-BF, -BS) I -213
	PUHY-400-500YEMK-A I -213
	PUHY-400-500YEMC-A(-BS) I -213
Super Y series	PUHY-600-650-700-750YSEM-A(-BF, -BS) I -225
	PUHY-600-650-700-750YSEMK-A I -225
	PUHY-600-650-700-750YSEMC-A(-BS) I -225
R2 series	PURY-200-250YEMC-A I -245

Introduction

CITY MULTI OUTDOOR UNITS

Introduction

Standard	Refrigerant	Series	Model Name	71 (2.8HP)	125 (5HP)	200 (8HP)	250 (10HP)	315 (13HP)	400 (16HP)	500 (20HP)	600 (24HP)	650 (26HP)	700 (28HP)	750 (30HP)	
CE	R407C	S	PUMY-P-VMA		●										
			PUMY-P-YMA		●										
		Y / Big Y / Super Y	PUHY-P-Y(S)EM-A(-BF/-BS)			●	●	●	●	●	●	●	●	●	●
			PUY-P-YEM-A(-BF/-BS)			●	●	●							
		R2 / BigR2	PURY-P-YEM-A(BF/-BS)			●	●								
			PURY-P-YEM-A			●	●		●	●					
		WY	PQHY-P-YEM-A			●	●								
	WR2	PQRY-P-YEM-A			●	●									
	R22	S	PUMY-VM/VMA	●	●										
			PUMY-YM(A)		●										
		Y / Big Y / Super Y	PUHY-Y(S)EM-A(-BF/-BS)			●	●	●	●	●	●	●	●	●	●
			PUY-YEM-A(-BF/-BS)			●	●	●							
			PUHY-Y(S)EMK-A				●	●	●	●	●	●	●	●	●
			PUHY-Y(S)EMC-A(-BS)			●	●	●	●	●	●	●	●	●	●
		PUHY-TEM-A(-BF)			●	●	●								
R2	PURY-YEMC-A			●	●										

Meaning of model name

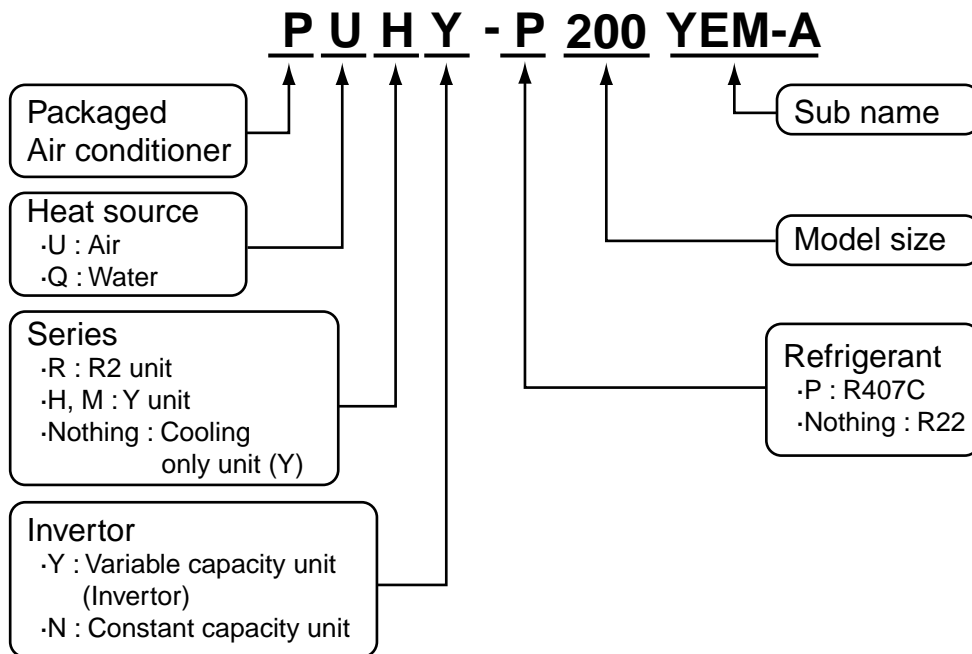

PUMY-P125VMA

CONTENTS

S-5(R407C)

1. Specifications	I -4
2. Capacity Tables	I -5
2-1 Correction by temperature	I -5
2-2 Correction by total indoor	I -7
2-3 Correction by refrigerant piping length	I -8
2-4 Correction at frosting and defrosting	I -9
2-5 Operation limit	I -9
3. Sound Levels	I -10
4. External Dimensions	I -11
5. Electrical Wiring Diagram	I -12
6. Refrigerant Circuit Diagram	I -13
And Thermal Sensor	

1. Specifications

S-5(R407C)

Model name			PUMY-P125VMA	
			Cooling	Heating
Capacity	*1	kW	14.0	16.0
	*2	kcal/h	12,500	—
Power source			~N 220/230/240V,50Hz	
Power input		kW	6.10	6.03
Current		A	28.3/27.1/26.0	28.0/26.8/25.7
Fan	Type X Quantity		Propeller fan X 2	
	Airflow rate	m ³ /min	90	
	Motor output	kW	0.06 X 2	
Compressor	Type		Hermetic	
	Motor output	kW	3.5	
	Crankcase heater	kW	—	
Refrigerant / Lubricant			R407C/MEL32	
External finish			Steel plate painting with polyester powder <MUNSELL 5Y8/1>	
External dimension		mm	1280(H)X1020(W)X350+30(D)	
Protection devices	High pressure protection		3.0MPa	
	Compressor / Fan		Internal thermal switch / Internal thermal switch	
	Inverter		Over current protection , Overheat protection	
Refrigerant piping diameter		Liquid / Gas	ø9.52 /ø19.05 (Flare)	
Indoor unit	Total capacity		50 ~ 130% of outdoor unit capacity	
	Model / Quantity		Model 20 ~ 125 / 1 ~ 8	
Noise level		* dB<A>	54	
Net weight		kg	128	
Operating temperature range			Indoor:15°CWB ~ 24°CWB Outdoor:-5°CDB ~ 46°CDB	Indoor:15°CDB ~ 27°CDB Outdoor:-15°CWB ~ 15.5°CWB

Note: 1.Cooling/heating capacity indicates the maximum value at operation under the following condition.

*1 **Cooling** Indoor : 27°CDB/19°CWB Outdoor : 35°CDB

Heating Indoor : 20°CDB Outdoor : 7°CDB/6°CWB

Pipe length : 7.5m Height difference : 0m

*2 **Cooling** Indoor : 27°CDB/19.5°CWB Outdoor : 35°CDB

Pipe length : 5m Height difference : 0m

* It is measured in anechoic room.

2. Capacity Table

2-1. Correction by temperature

Cooling

- Standard Specifications (Outdoor : 35°CDB/- Indoor : 27°CDB/19°CWB)

		PUMY-P125
Capacity	kW	14.0
Input	kW	5.95

S-5(R407C)

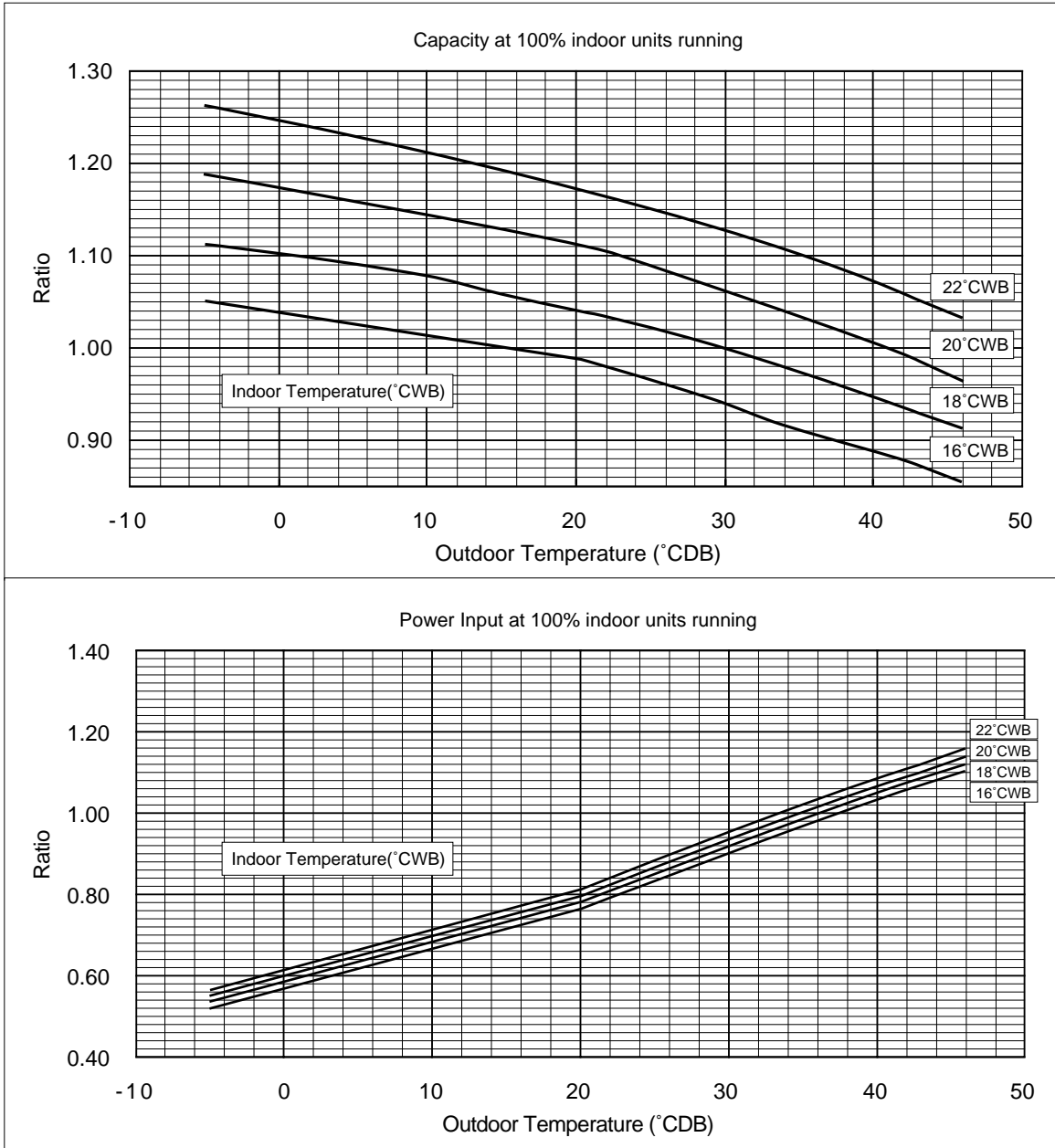

Heating

- Standard Specifications (Outdoor 7°CDB/6°CWB Indoor 20°CDB/-)

		PUMY-P125
Capacity	kW	16.0
Input	kW	5.58

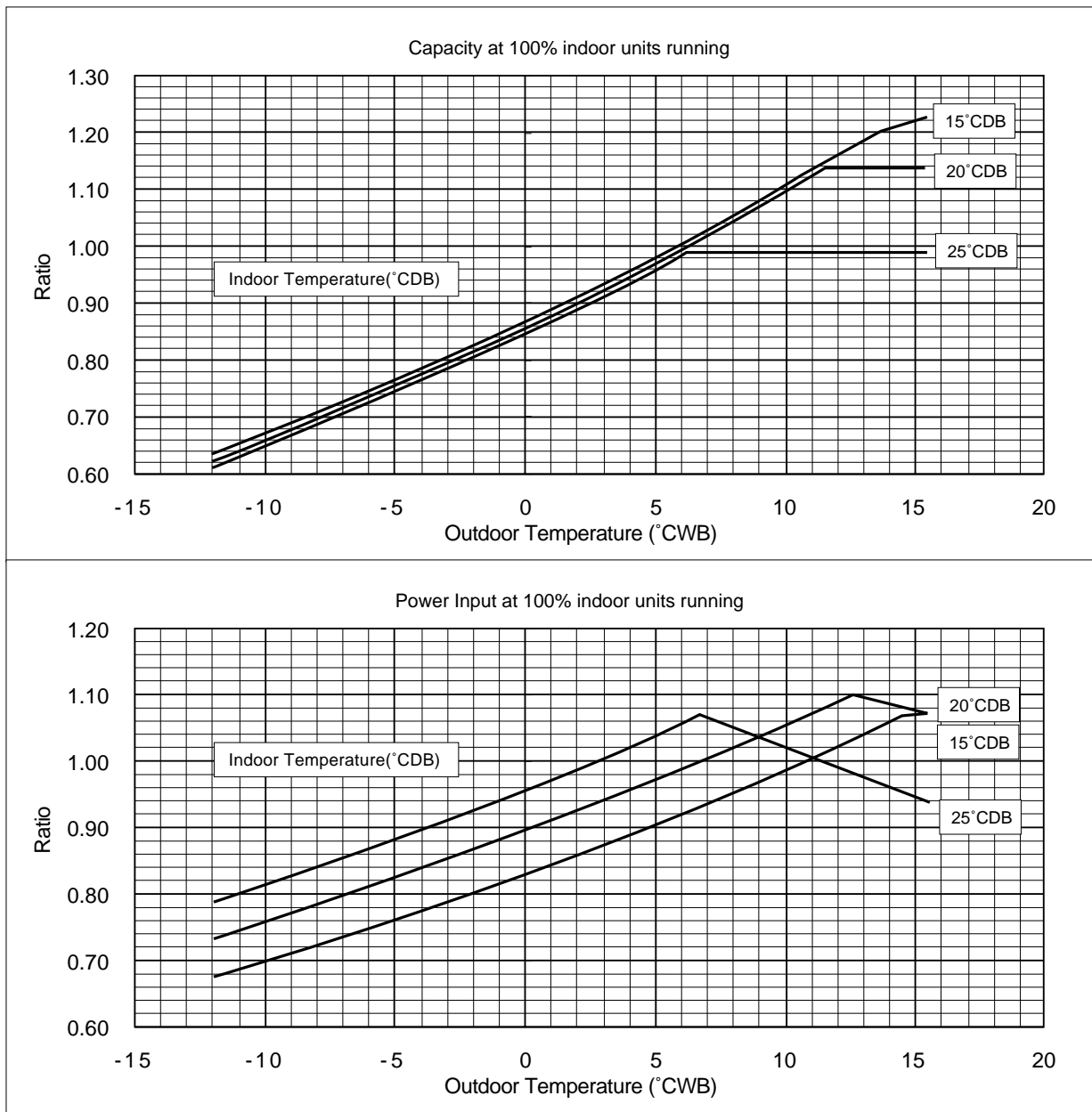

2-2. Correction by total indoor

PUMY-P125

1) Capacity

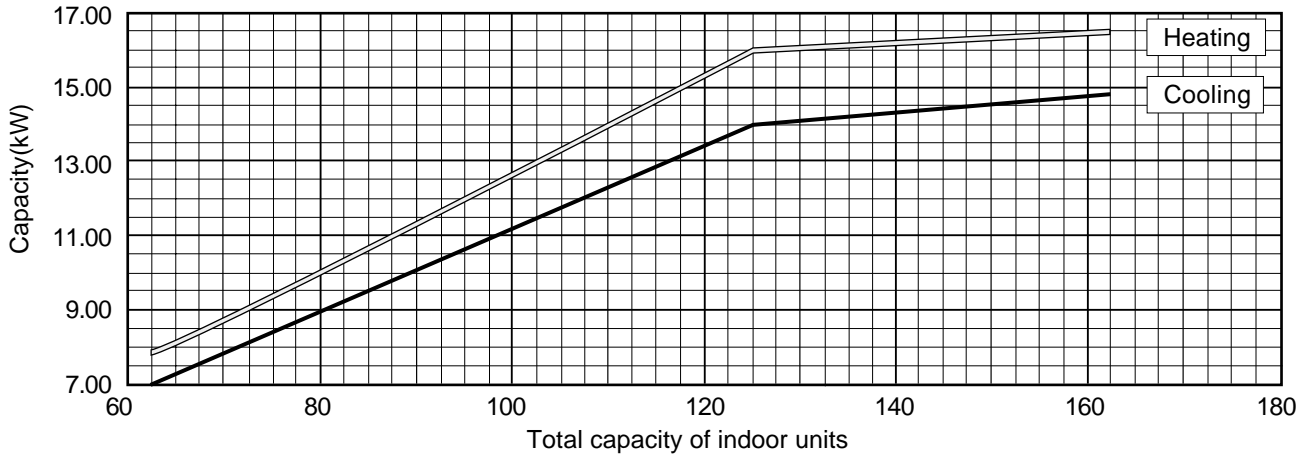

2) Input

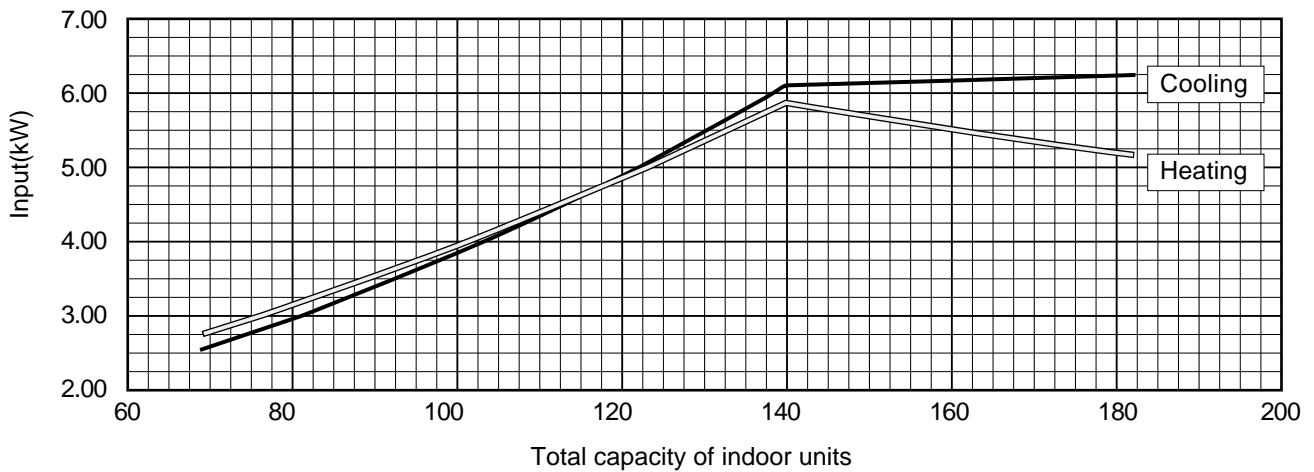

S-F(R407C)

2-3. Correction by refrigerant piping length

To obtain a decrease in cooling/heating capacity due to refrigerant piping extension, multiply by the capacity correction factor based on the refrigerant piping equivalent length in the table below.

- **Cooling capacity correction**

PUMY-P125

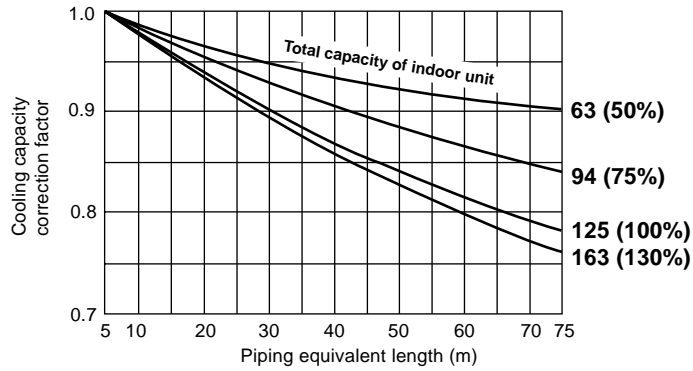

- **Heating capacity correction**

PUMY-P125

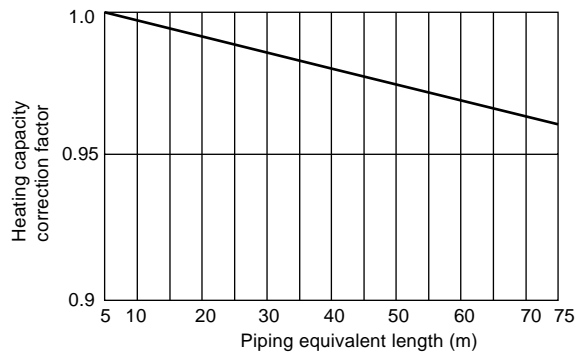

- **How to obtain piping equivalent length**

PUMY-P125

Equivalent length = (Actual piping length to the farthest indoor unit) + (0.35 X number of bent on the piping)m

2-4. Correction at frosting and defrosting

When a decrease in heating capacity due to frosted and defrosting operations is considered, the value multiplied by the correction factor in the table below represents the heating capacity.

Correction factor table

Outdoor inlet air temp (°CWB)	6	4	2	0	-2	-4	-6	-8	-10
Correction factor	1.0	0.98	0.89	0.88	0.89	0.9	0.95	0.95	0.95

2-5. Operation limit

• Cooling

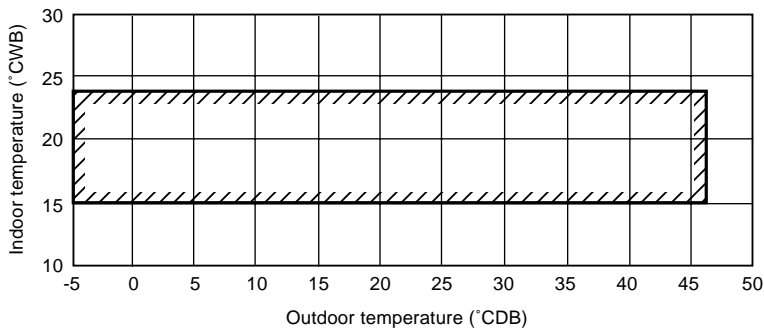

• Heating

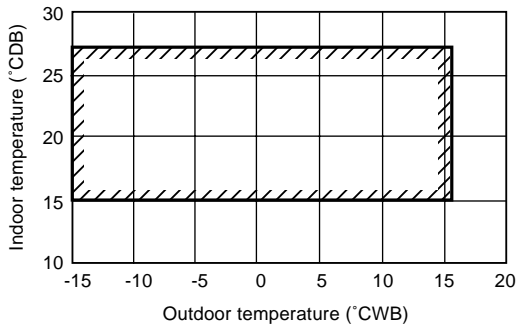

3. Sound Levels

PUMY-P125

Measurement condition

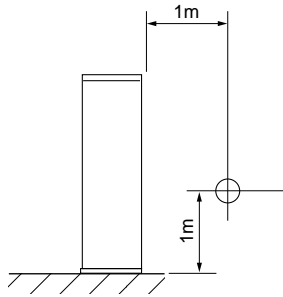

Sound pressure level in anechoic room

57 dB (A)

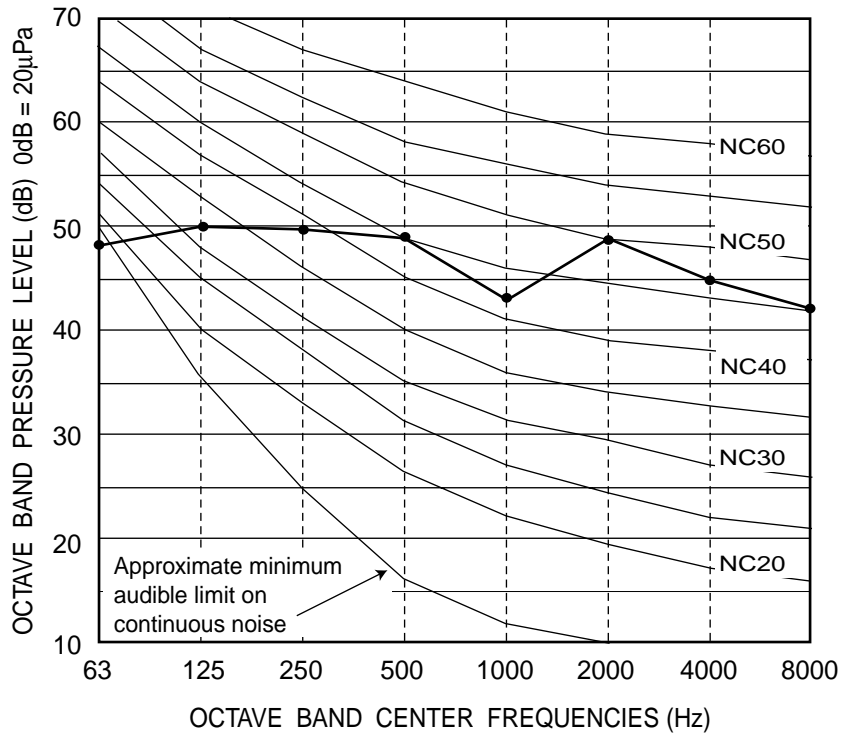

S-5(R407C)

4. External Dimensions

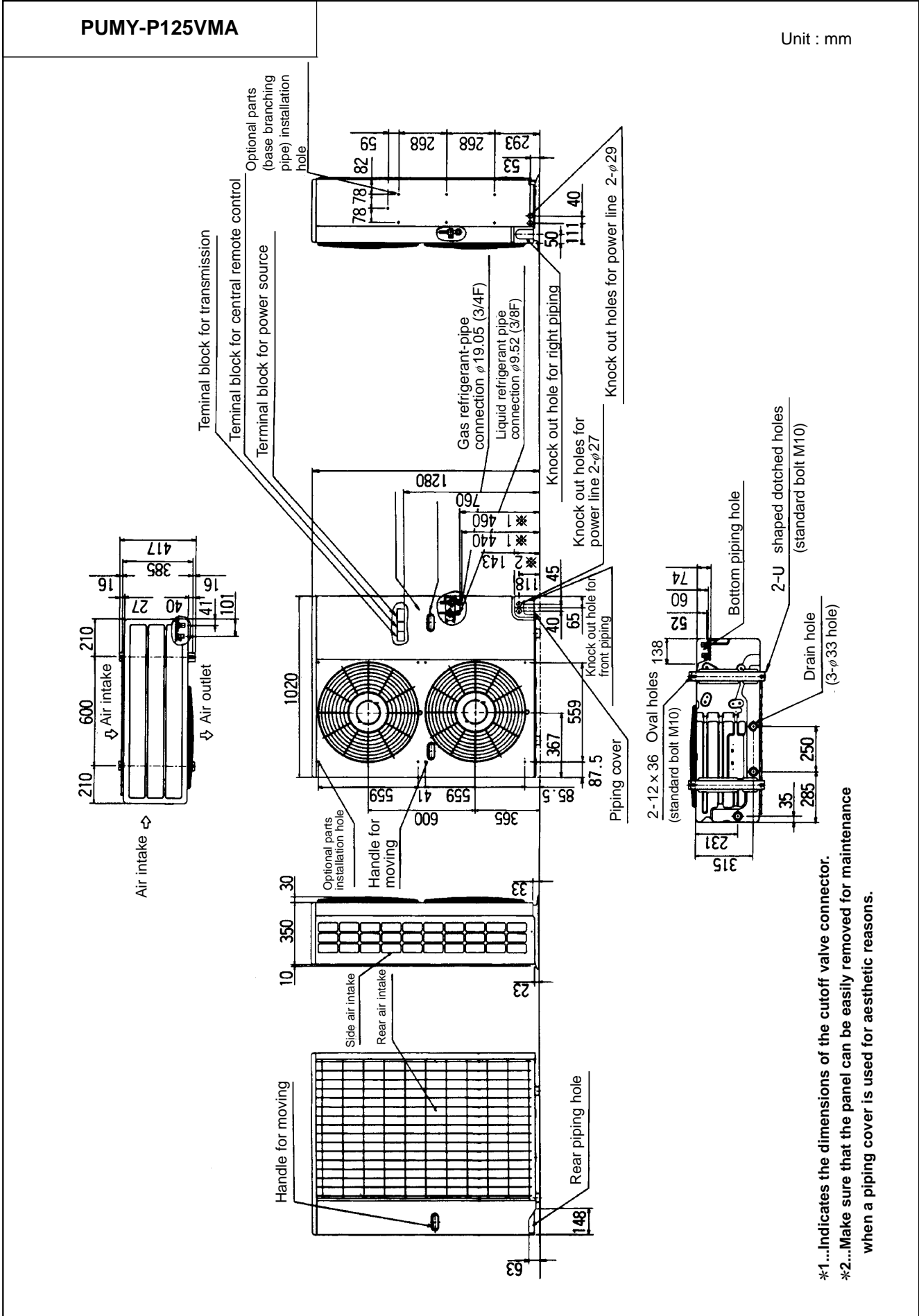

S-5(R407C)

5. Electrical Wiring Diagram

PUMY-P125VMA

S-5(R407C)

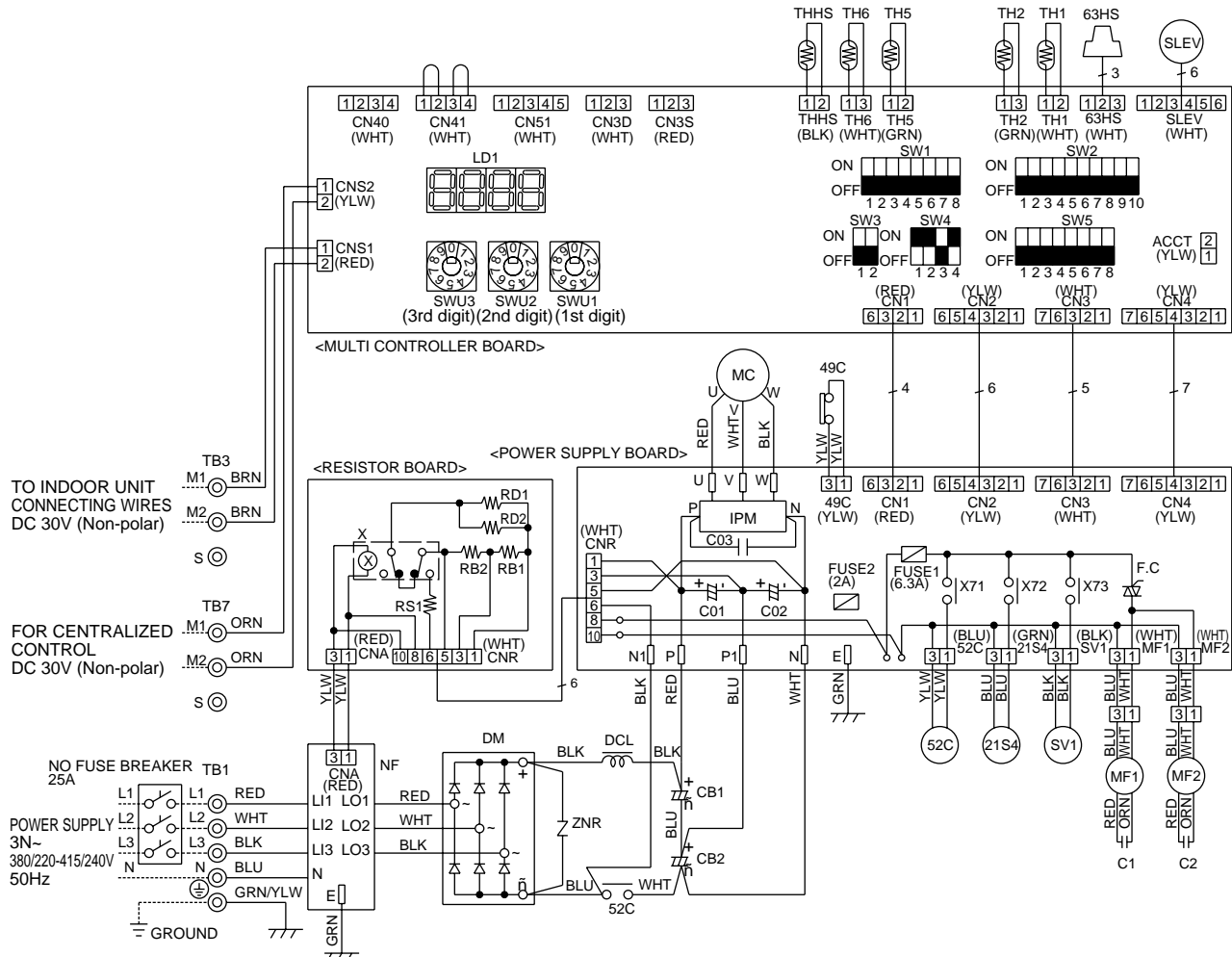

- NOTES : 1. Refer to the wiring diagrams of the indoor units for details on wiring of each indoor unit.
 2. Symbols used in wiring diagram above are. ⊙: Terminal block, □: Connector, □: Insertion tab.
 3. Self-diagnosis function
 The indoor and outdoor units can be diagnosed automatically using the self-diagnosis switch (SW1) and LD1(LED indication) found on the multi-controller of the outdoor unit.
 LED indication : Set all contacts of SW1 to OFF.

1. During normal operation
 The LED indicates the drive state of the controller in the outdoor unit.

Bit	1	2	3	4	5	6	7	8
Indication	Compressor operated	52C	21S4	SV1	-	-	-	Always lit

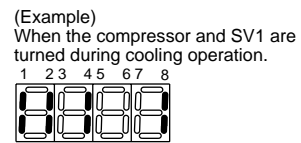

2. When fault requiring inspection has occurred
 The LED alternately indicates the inspection code and the location of the unit in which the fault has occurred.

<SYMBOL EXPLANATION>

SYMBOL	NAME	SYMBOL	NAME	SYMBOL	NAME	SYMBOL	NAME
ACCT	CONNECTOR <CURRENT DETECTION>	C1,C2	FAN MOTOR CAPACITOR	SV1	SOLENOID VALVE <HOT GAS BYPASS>	TH2	THERMISTOR <LOW PRESSURE SATURATED TEMPERATURE DETECTION>
CB1,CB2	SMOOTHING CAPACITOR	DM	DIODE MODULE	SW1	SWITCH <DISPLAY SELECTION>	TH5	THERMISTOR <PIPE TEMPERATURE DETECTION JUDGING DEFROST>
CNA	CONNECTOR <POWER SUPPLY>	DCL	REACTOR	SW2	SWITCH <FUNCTION SELECTION>	TH6	THERMISTOR <OUTDOOR TEMPERATURE DETECTION>
CNR	CONNECTOR <DISCHARGE CIRCUIT, POWER SUPPLY>	F.C	FAN CONTROL	SW3	SWITCH <TEST RUN>	X	RELAY
CNS1	CONNECTOR <MULTI SYSTEM>	FUSE1	FUSE (6.3A)	SW4	SWITCH <MODEL SELECTION>	X71	RELAY <MAGNETIC CONTACTOR>
CNS2	CONNECTOR <CENTRALIZED CONTROL>	FUSE2	FUSE (2A)	SW5	SWITCH <FUNCTION SELECTION>	X72	RELAY <4-WAY VALVE>
CN1	CONNECTOR <CONTROLLER DRIVE CONTROL>	IPM	INTELLIGENT POWER MODULE	SWU1	SWITCH <UNIT ADDRESS SELECTION,1ST DIGIT>	X73	RELAY <SOLENOID VALVE>
CN2	CONNECTOR <POWER SYNC SIGNAL, PROTECTION>	LD1	DIGITAL INDICATION LED <OPERATION INSPECTION INDICATION>	SWU2	SWITCH <UNIT ADDRESS SELECTION,2ND DIGIT>	ZNR	VARIATOR
CN3	CONNECTOR <POWER SUPPLY 30V,12V,5V>	MF1,MF2	FAN MOTOR <INNER THERMOSTAT>	SWU3	SWITCH <UNIT ADDRESS SELECTION,3RD DIGIT>	21S4	4-WAY VALVE
CN4	CONNECTOR <INVERTER SIGNAL 5V>	MC	COMPRESSOR <INNER THERMOSTAT>	TB1	TERMINAL BLOCK <POWER SUPPLY>	49C	THERMAL SWITCH <COMPRESSOR>
CN40	CONNECTOR <CENTRALIZED CONTROL POWER SUPPLY>	RS1	RESISTOR <RUSH CURRENT PROTECT>	TB3	TERMINAL BLOCK <TRANSMISSION>	52C	MAGNETIC CONTACTOR
CN41	CONNECTOR <FOR STORING JUMPER CONNECTOR>	RB1,RB2	RESISTOR <VOLTAGE BALANCE ADJUSTMENT>	TB7	TERMINAL BLOCK <CENTRALIZED CONTROL>	63HS	HIGH PRESSURE SENSOR <DISCHARGE PRESSURE DETECTION>
CN51	CONNECTOR <COMPRESSOR DRIVE SIGNAL OUTPUT>	RD1,RD2	RESISTOR <DISCHARGE>	THHS	THERMISTOR <IPM RADIATOR PANEL TEMPERATURE DETECTION>		
CN3D	CONNECTOR <AUTO CHANGE OVER SIGNAL>	SLEV	EXPANSION VALVE	TH1	THERMISTOR <DISCHARGE TEMPERATURE DETECTION>		
CN3S	CONNECTOR <DEMAND SIGNAL>						
C01,C02	SMOOTHING CAPACITOR						
C03	CAPACITOR <FILTER>						

6. Refrigerant Circuit Diagram And Thermal Sensor

PUMY-P125

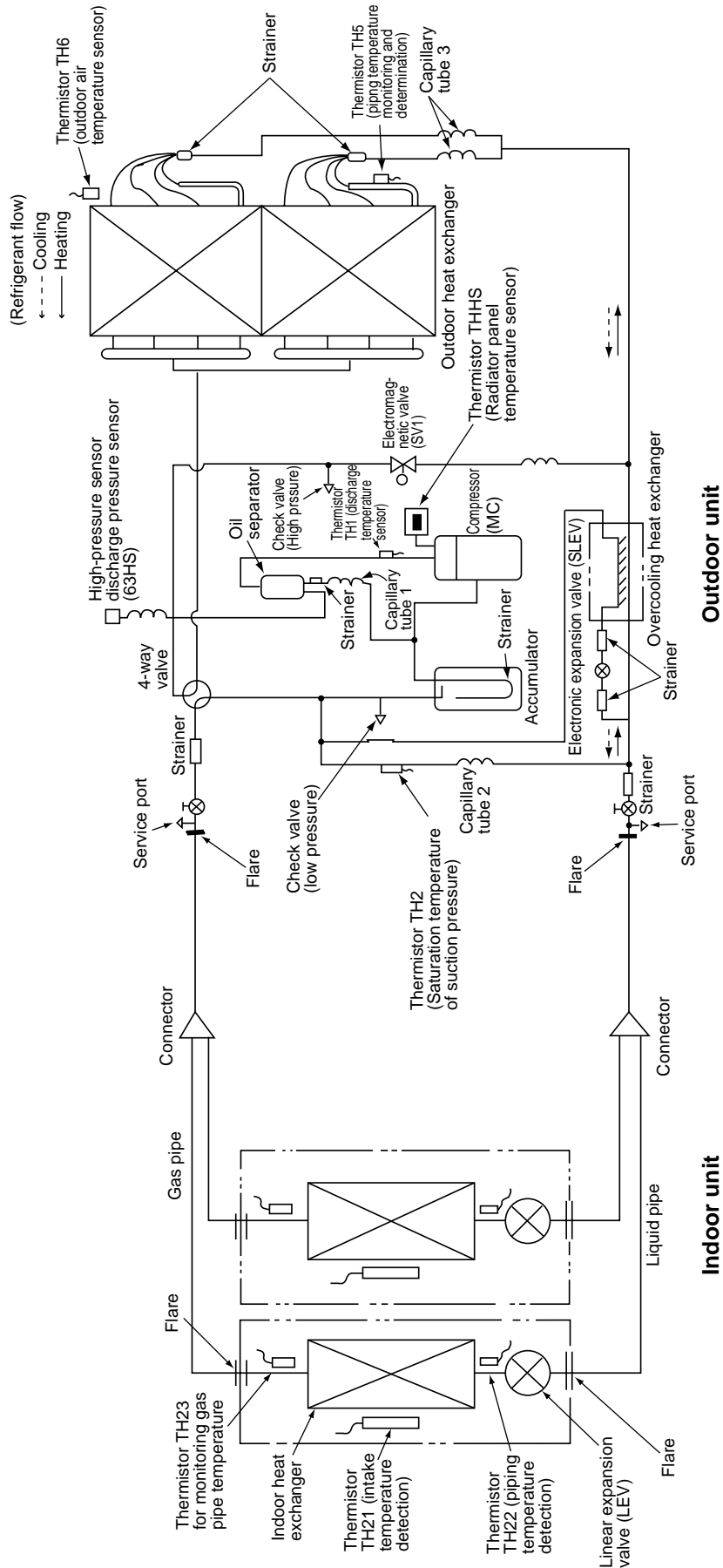

S-5(R407C)

PUMY-P125YMA

CONTENTS

1. Specifications	I -16
2. Capacity Tables	I -17
2-1 Correction by temperature	I -17
2-2 Correction by total indoor	I -19
2-3 Correction by refrigerant piping length	I -20
2-4 Correction at frosting and defrosting	I -21
2-5 Operation limit	I -21
3. Sound Levels	I -22
4. External Dimensions	I -23
5. Electrical Wiring Diagram	I -24
6. Refrigerant Circuit Diagram	I -25
And Thermal Sensor	

S-5(R407C)

1. Specifications

S-5(R407C)

Model name			PUMY-P125YMA	
			Cooling	Heating
Capacity	*1	kW	14.0	16.0
	*2	kcal/h	12,500	—
Power source			3N ~ 380/400/415V 50Hz	
Power input		kW	5.95	5.58
Current		A	9.6/9.1/8.8	9.2/8.8/8.5
Fan	Type X Quantity		Propeller fan X 2	
	Airflow rate	m ³ /min	90	
	Motor output	kW	0.06 X 2	
Compressor	Type		Hermetic	
	Motor output	kW	3.5	
	Crankcase heater	kW	—	
Refrigerant / Lubricant			R407C/MEL32	
External finish			Steel plate painting with polyester powder <MUNSELL 5Y8/1>	
External dimension		mm	1280(H)X1020(W)X350+30(D)	
Protection devices	High pressure protection		3.0MPa	
	Compressor / Fan		Internal thermal switch / Internal thermal switch	
	Inverter		Over current protection , Overheat protection	
Refrigerant piping diameter		Liquid / Gas	φ9.52 / φ19.05 (Flare)	
Indoor unit	Total capacity		50 ~ 130% of outdoor unit capacity	
	Model / Quantity		Model 20 ~ 125 / 1 ~ 8	
Noise level	*	dB<A>	54	
Net weight		kg	127	
Operating temperature range			Indoor:15°CWB ~ 24°CWB Outdoor:-5°CDB ~ 46°CDB	Indoor:15°CDB ~ 27°CDB Outdoor:-15°CWB ~ 15.5°CWB

Note: 1.Cooling/heating capacity indicates the maximum value at operation under the following condition.

*1 Cooling Indoor : 27°CDB/19°CWB	Outdoor : 35°CDB	*2 Cooling Indoor : 27°CDB/19.5°CWB	Outdoor : 35°CDB
Heating Indoor : 20°CDB	Outdoor : 7°CDB/6°CWB	Pipe length : 5m	Height difference : 0m
Pipe length : 7.5m	Height difference : 0m		

* It is measured in anechoic room.

2. Capacity Table

2-1. Correction by temperature

Cooling

- Standard Specifications

		PUMY-P125
Capacity	kW	14.0
Input	kW	5.95

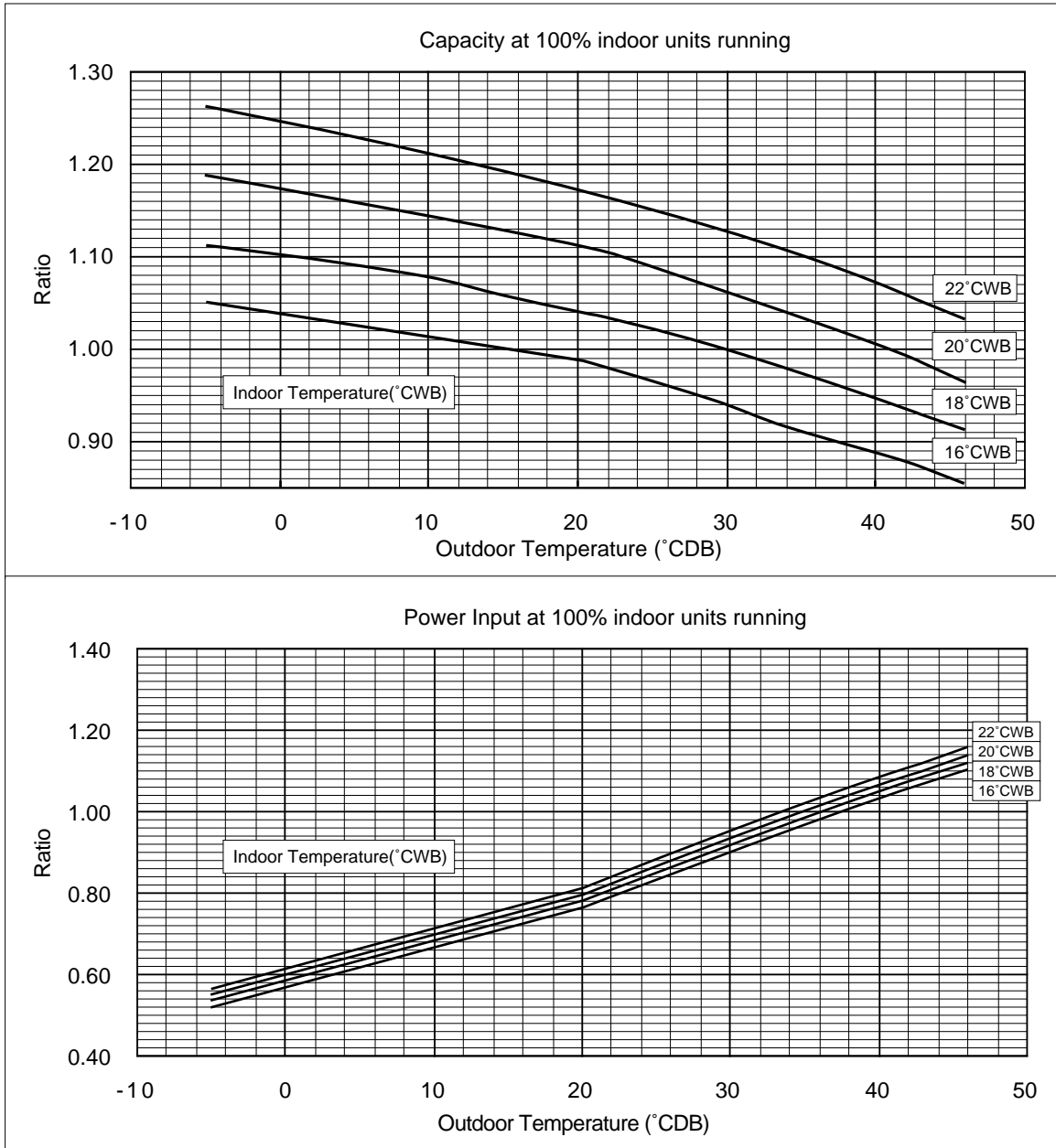

S-5(R407C)

Heating

- Standard Specifications (Outdoor : 7°CDB/6°CWB Indoor : 20°CDB/-)

		PUMY-P125
Capacity	kW	16.0
Input	kW	5.58

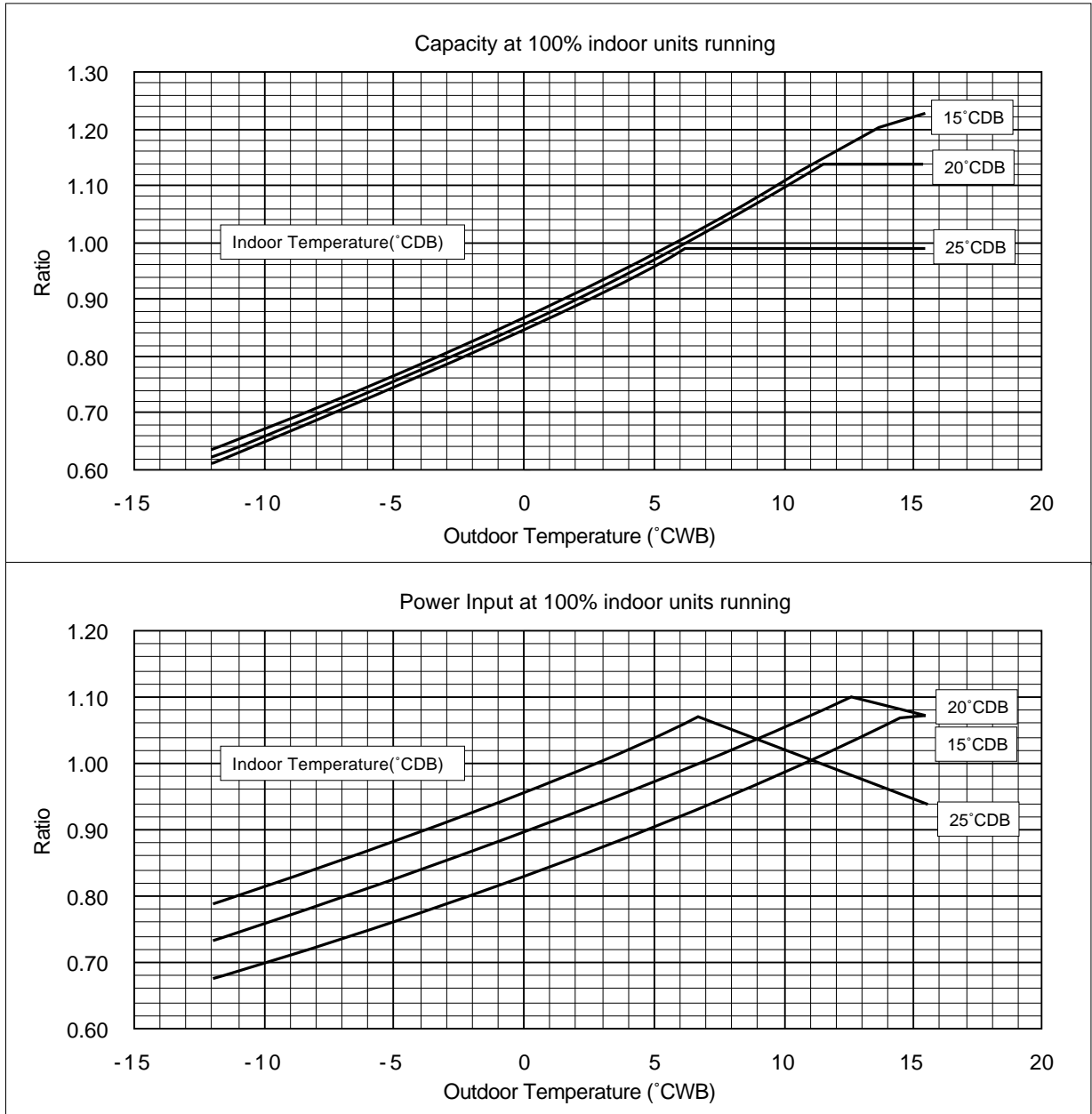

S-5(R407C)

2-2. Correction by total indoor

PUMY-P125

1) Capacity

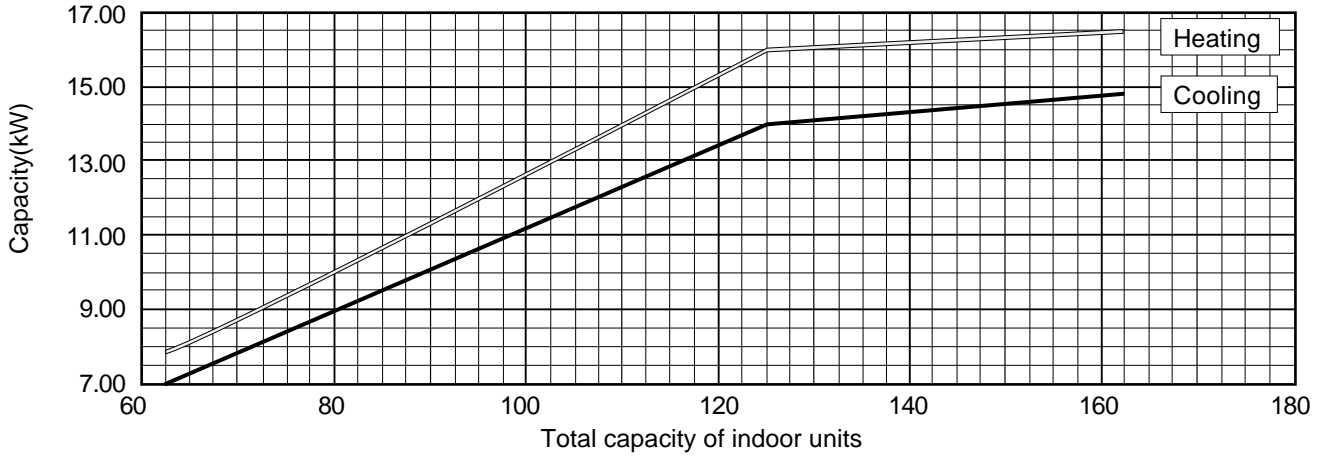

2) Input

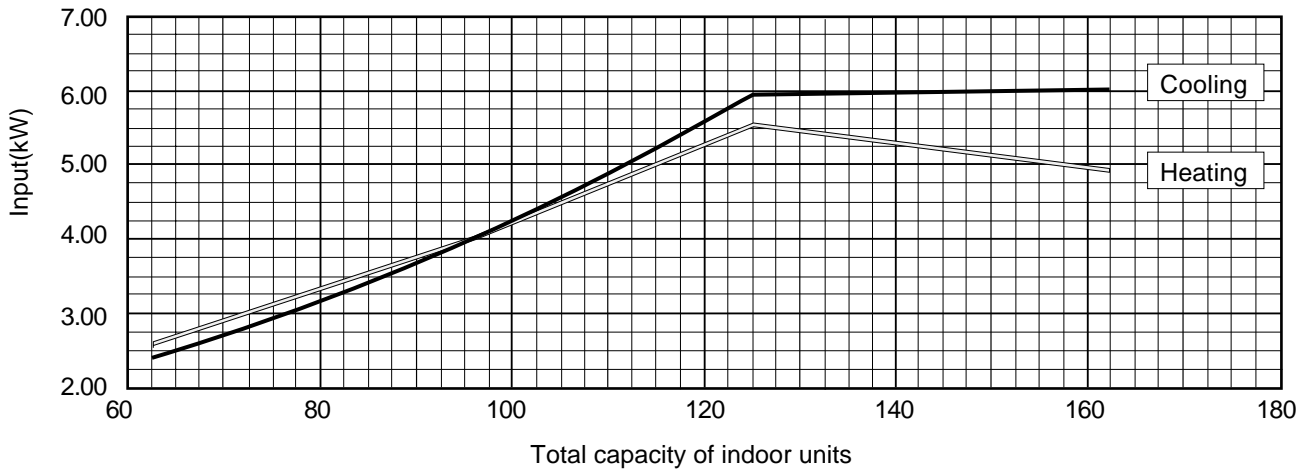

S-5(R407C)

2-3. Correction by refrigerant piping length

To obtain a decrease in cooling/heating capacity due to refrigerant piping extension, multiply by the capacity correction factor based on the refrigerant piping equivalent length in the table below.

• Cooling capacity correction

PUMY-P125

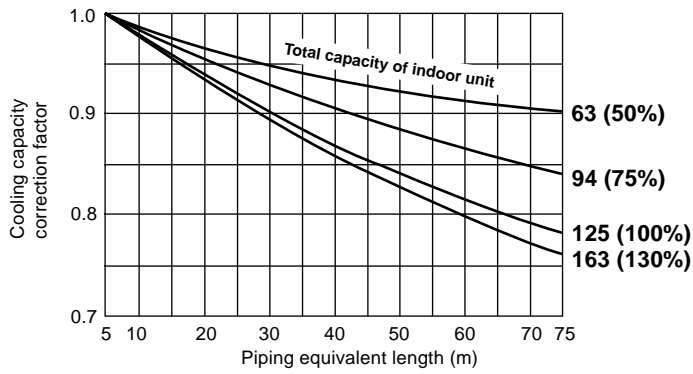

• Heating capacity correction

PUMY-P125

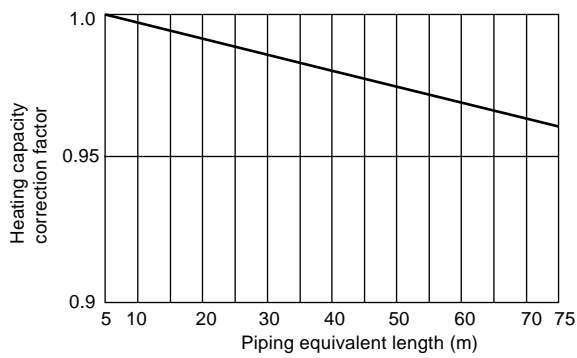

• How to obtain piping equivalent length

PUMY-P125

Equivalent length = (Actual piping length to the farthest indoor unit) + (0.35 × number of bent on the piping)m

2-4. Correction at frosting and defrosting

When a decrease in heating capacity due to frosted and defrosting operations is considered, the value multiplied by the correction factor in the table below represents the heating capacity.

Correction factor table

Outdoor inlet air temp (°CWB)	6	4	2	0	-2	-4	-6	-8	-10
Correction factor	1.0	0.98	0.89	0.88	0.89	0.9	0.95	0.95	0.95

2-5. Operation limit

• Cooling

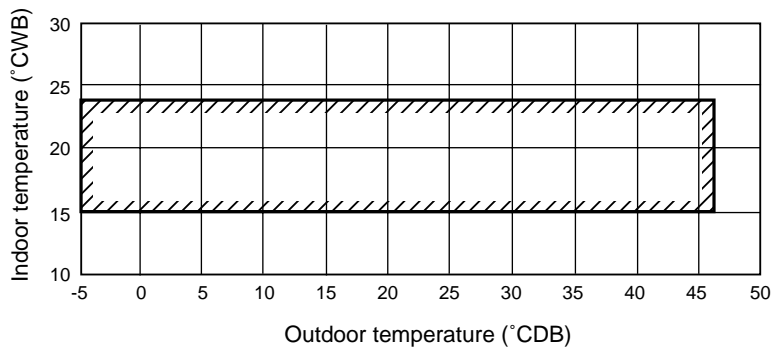

• Heating

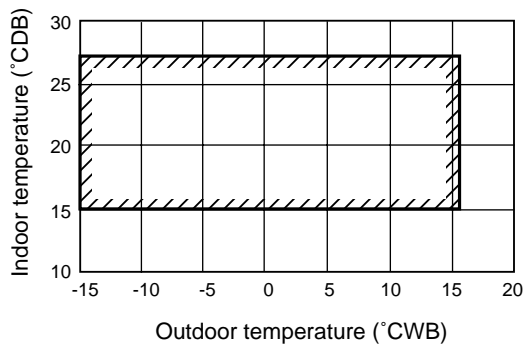

3. Sound Levels

PUMY-P125

Measurement condition

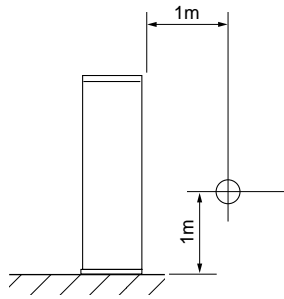

Sound pressure level in anechoic room

57 dB (A)

S-5(R407C)

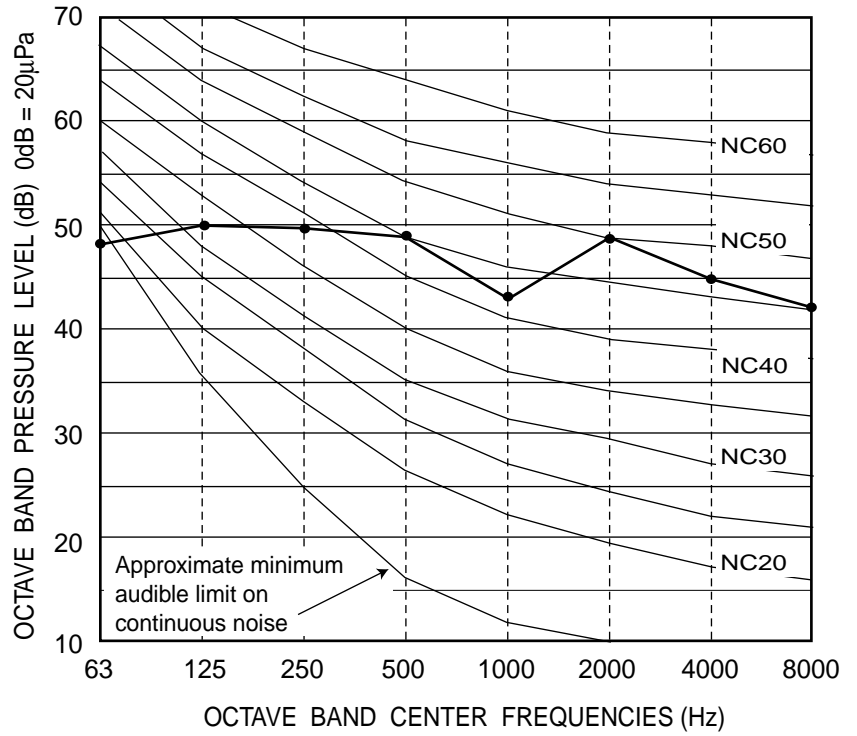

4. External Dimensions

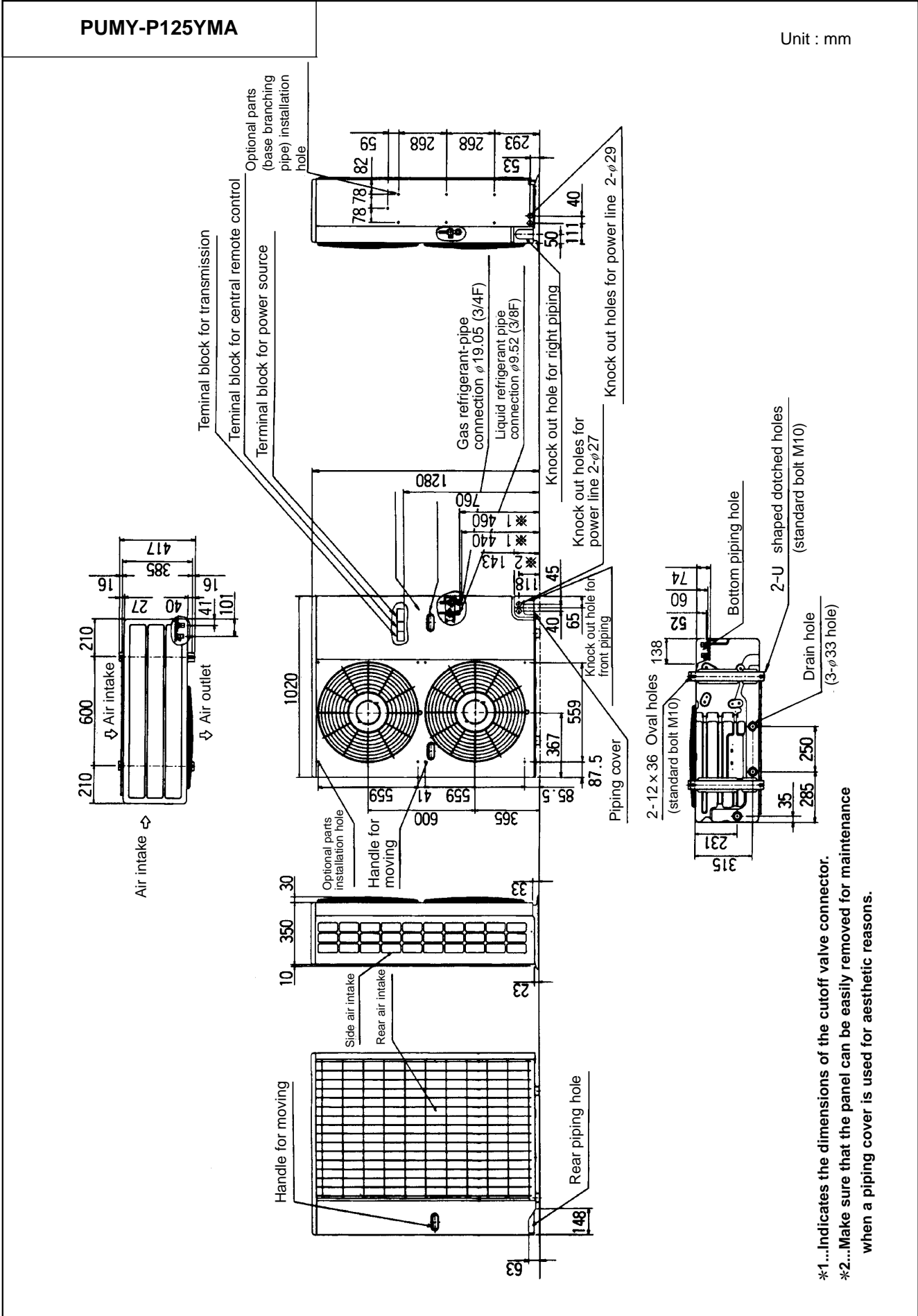

*1...Indicates the dimensions of the cutoff valve connector.
 *2...Make sure that the panel can be easily removed for maintenance when a piping cover is used for aesthetic reasons.

5. Electrical Wiring Diagram

PUMY-P125YMA

S-5(R407C)

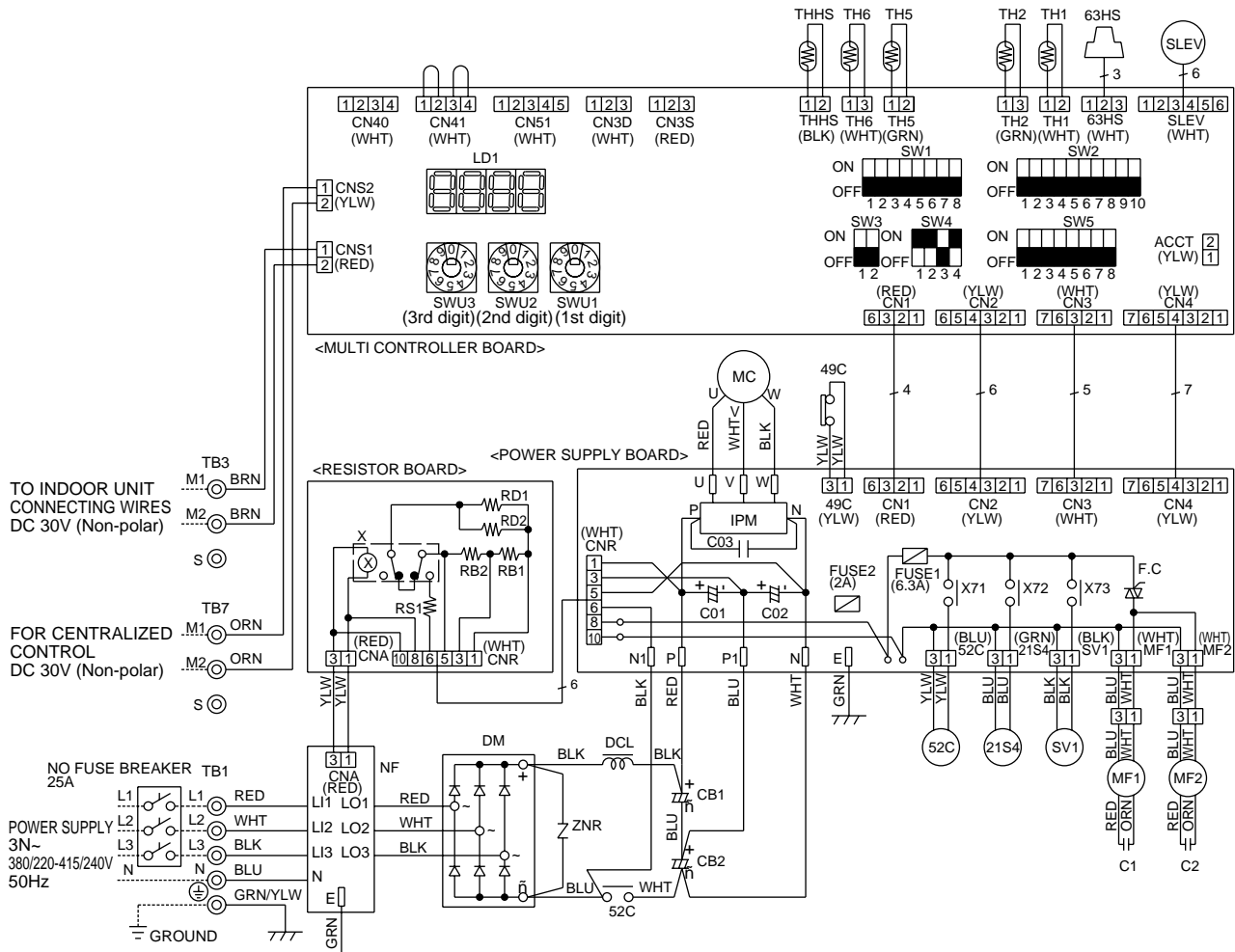

- NOTES : 1. Refer to the wiring diagrams of the indoor units for details on wiring of each indoor unit.
 2. Symbols used in wiring diagram above are. Ⓞ: Terminal block, □: Connector, □: Insertion tab.
 3. Self-diagnosis function
 The indoor and outdoor units can be diagnosed automatically using the self-diagnosis switch (SW1) and LD1(LED indication) found on the multi-controller of the outdoor unit.
 LED indication : Set all contacts of SW1 to OFF.

1. During normal operation
 The LED indicates the drive state of the controller in the outdoor unit.

Bit	1	2	3	4	5	6	7	8
Indication	Compressor operated	52C	21S4	SV1	-	-	-	Always lit

(Example)
 When the compressor and SV1 are turned during cooling operation.

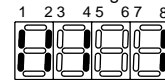

2. When fault requiring inspection has occurred
 The LED alternately indicates the inspection code and the location of the unit in which the fault has occurred.

<SYMBOL EXPLANATION>

SYMBOL	NAME	SYMBOL	NAME	SYMBOL	NAME	SYMBOL	NAME
ACCT	CONNECTOR <CURRENT DETECTION>	C1,C2	FAN MOTOR CAPACITOR	SV1	SOLENOID VALVE <HOT GAS BYPASS>	TH2	THERMISTOR <LOW PRESSURE SATURATED TEMPERATURE DETECTION>
CB1,CB2	SMOOTHING CAPACITOR	DM	DIODE MODULE	SW1	SWITCH <DISPLAY SELECTION>	TH5	THERMISTOR <PIPE TEMPERATURE DETECTION JUDGING DEFROST>
CNA	CONNECTOR <POWER SUPPLY>	DCL	REACTOR	SW2	SWITCH <FUNCTION SELECTION>	TH6	THERMISTOR <OUTDOOR TEMPERATURE DETECTION>
CNR	CONNECTOR <DISCHARGE CIRCUIT, POWER SUPPLY>	F.C	FAN CONTROL	SW3	SWITCH <TEST RUN>	X	RELAY
CN1	CONNECTOR <MULTI SYSTEM>	FUSE1	FUSE (6.3A)	SW4	SWITCH <MODEL SELECTION>	X71	RELAY <MAGNETIC CONTACTOR>
CN2	CONNECTOR <CENTRALIZED CONTROL>	FUSE2	FUSE (2A)	SW5	SWITCH <FUNCTION SELECTION>	X72	RELAY <4-WAY VALVE>
CN3	CONNECTOR <POWER SUPPLY 30V,12V,5V>	IPM	INTELLIGENT POWER MODULE	SWU1	SWITCH <UNIT ADDRESS SELECTION,1ST DIGIT>	X73	RELAY <SOLENOID VALVE>
CN4	CONNECTOR <INVERTER SIGNAL 5V>	LD1	DIGITAL INDICATION LED <OPERATION INSPECTION INDICATION>	SWU2	SWITCH <UNIT ADDRESS SELECTION,2ND DIGIT>	49C	THERMAL SWITCH <COMPRESSOR>
CN40	CONNECTOR <CENTRALIZED CONTROL POWER SUPPLY>	MC	COMPRESSOR <INNER THERMOSTAT>	SWU3	SWITCH <UNIT ADDRESS SELECTION,3RD DIGIT>	52C	MAGNETIC CONTACTOR
CN41	CONNECTOR <FOR STORING JUMPER CONNECTOR>	MF1,MF2	FAN MOTOR <INNER THERMOSTAT>	TB1	TERMINAL BLOCK <POWER SUPPLY>	21S4	4-WAY VALVE
CN51	CONNECTOR <COMPRESSOR DRIVE SIGNAL OUTPUT>	NF	NOISE FILTER	TB3	TERMINAL BLOCK <TRANSMISSION>	63HS	HIGH PRESSURE SENSOR <DISCHARGE PRESSURE DETECTION>
CN3D	CONNECTOR <AUTO CHANGE OVER SIGNAL>	RS1	RESISTOR <RUSH CURRENT PROTECT>	THHS	THERMISTOR <IPM RADIATOR PANEL TEMPERATURE DETECTION>		
CN3S	CONNECTOR <DEMAND SIGNAL>	RB1,RB2	RESISTOR <VOLTAGE BALANCE ADJUSTMENT>	TH1	THERMISTOR <DISCHARGE TEMPERATURE DETECTION>		
C01,C02	SMOOTHING CAPACITOR	RD1,RD2	RESISTOR <DISCHARGE>				
C03	CAPACITOR <FILTER>	SLEV	EXPANSION VALVE				

6. Refrigerant Circuit Diagram And Thermal Sensor

PUMY-P125

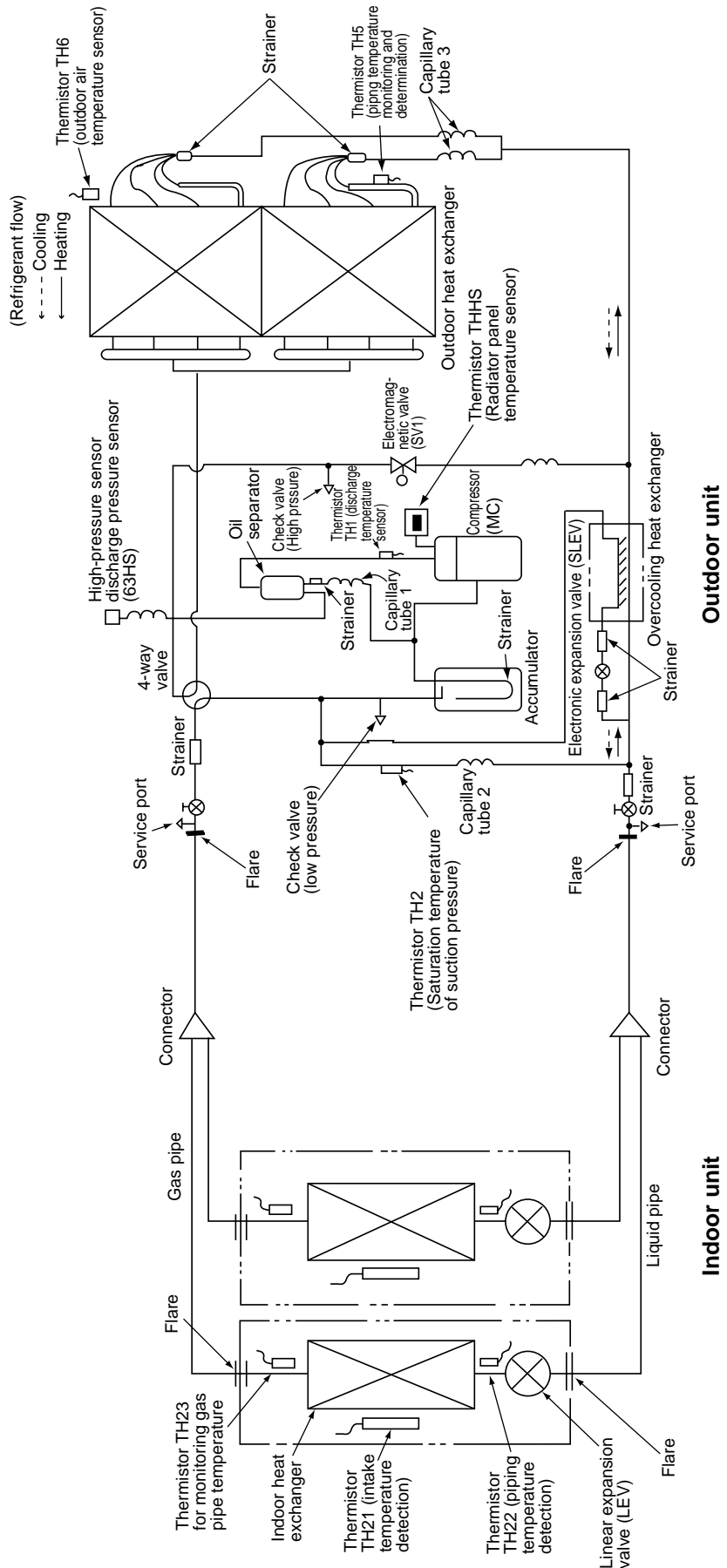

S-5(R407C)

PUHY-P200-250-315YEM-A (-BF, -BS)
PUY-P200-250-315YEM-A (-BF, -BS)

CONTENTS

1. Specifications	I -28
2. Capacity Tables	I -31
2-1 Correction by temperature	I -31
2-2 Correction by total indoor	I -33
2-3 Correction by refrigerant piping length	I -35
2-4 Correction at frosting and defrosting	I -36
2-5 Operation limit	I -36
3. Sound Levels	I -37
4. External Dimensions	I -39
5. Electrical Wiring Diagram	I -40
6. Refrigerant Circuit Diagram	I -41
And Thermal Sensor	

V-8,10,13(R407C)

1. Specifications

Model name			PUHY-P200YEM-A (-BF, -BS)		
			PUY-P200YEM-A (-BF, -BS)		
Capacity			Cooling	Heating	
			*1 kW	22.4	25.0
			*2 kcal/h	20,000	—
Power source			3N ~ 380/400/415V 50/60Hz		
Power input		kW	6.32	6.80	
Current		A	10.6/10.1/9.7	11.4/10.9/10.5	
Fan	Type X Quantity		Propeller fan X 1		
	Airflow rate	m ³ /min	200		
	Motor output	kW	0.38		
Compressor	Type		Hermetic		
	Motor output	kW	5.3		
	Crankcase heater	kW	0.045(240V)		
Refrigerant / Lubricant			R407C/MEL32		
External finish			Pre-coated galvanized sheets (Powder coating) <MUNSELL 5Y8/1 or similar>		
External dimension		mm	1755(H)X990(W)X840(L)		
Protection devices	High pressure protection		2.94MPa		
	Compressor / Fan		Over current protection / Thermal switch		
	Inverter		AC bus current protection, thermal switch		
Refrigerant piping diameter		Liquid / Gas	φ 12.7 (Flare) / φ 25.4 (Flange)		
Indoor unit	Total capacity		50 ~ 130% of outdoor unit capacity		
	Model / Quantity		Model 20 ~ 250 / 1 ~ 13		
Noise level		* dB<A>	56		
Net weight		kg	225		
Operating temperature range			Indoor:15°CWB ~ 24°CWB Outdoor:-5°CDB ~ 43°CDB (0°CDB ~ 43°CDB with outdoor unit at lower position)	Indoor:15°CDB ~ 27°CDB Outdoor:-15°CWB ~ 15.5°CWB	
Matters Deserving Special Mention			A pipe of φ28.58 can be used for the gas pipe		

Note: 1.Cooling/heating capacity indicates the maximum value at operation under the following condition.

*1 Cooling Indoor : 27°CDB/19°CWB	Outdoor : 35°CDB	*2 Cooling Indoor : 27°CDB/19.5°CWB	Outdoor : 35°CDB
Heating Indoor : 20°CDB	Outdoor : 7°CDB/6°CWB	Pipe length : 5m	Height difference : 0m
Pipe length : 7.5m	Height difference : 0m		

* It is measured in anechoic room.

V-81013(R407C)

Model name			PUHY-P250YEM-A (-BF, -BS)	
			PUY-P250YEM-A (-BF, -BS)	
			Cooling	Heating
Capacity	*1	kW	28.0	31.5
	*2	kcal/h	25,000	-
Power source			3N ~ 380/400/415V 50/60Hz	
Power input		kW	8.54	8.95
Current		A	14.4/13.6/13.2	15.1/14.3/13.8
Fan	Type X Quantity		Propeller fan X 1	
	Airflow rate	m ³ /min	200	
	Motor output	kW	0.38	
Compressor	Type		Hermetic	
	Motor output	kW	6.8	
	Crankcase heater	kW	0.045(240V)	
Refrigerant / Lubricant			R407C/MEL32	
External finish			Pre-coated galvanized sheets <MUNSELL 5Y8/1 or similar>	
External dimension		mm	1755(H)X990(W)X840(L)	
Protection devices	High pressure protection		2.94MPa	
	Compressor / Fan		Over current protection / Thermal switch	
	Inverter		AC bus current protection, thermal switch	
Refrigerant piping diameter		Liquid / Gas	φ 12.7 (Flare) / φ 28.58 (Flange)	
Indoor unit	Total capacity		50 ~ 130% of outdoor unit capacity	
	Model / Quantity		Model 20 ~ 250 / 1 ~ 16	
Noise level		* dB<A>	57	
Net weight		kg	225	
Operating temperature range			Indoor:15°CWB ~ 24°CWB Outdoor:-5°CDB ~ 43°CDB (0°CDB ~ 43°CDB with outdoor unit at lower position)	Indoor:15°CDB ~ 27°CDB Outdoor:-15°CWB~15.5°CWB

Note: 1.Cooling/heating capacity indicates the maximum value at operation under the following condition.

*1 Cooling	Indoor : 27°CDB/19°CWB	Outdoor : 35°CDB	*2 Cooling	Indoor : 27°CDB/19.5°CWB	Outdoor : 35°CDB
Heating	Indoor : 20°CDB	Outdoor : 7°CDB/6°CWB	Pipe length : 5m	Height difference : 0m	
	Pipe length : 7.5m	Height difference : 0m			

* It is measured in anechoic room.

Model name			PUHY-P315YEM-A (-BF, -BS)	
			PUY-P315YEM-A (-BF, -BS)	
			Cooling	Heating
Capacity	*1	kW	35.5	40.0
	*2	kcal/h	31,500	–
Power source			3N ~ 380/400/415V 50/60Hz	
Power input		kW	12.30	12.49
Current		A	20.3/19.2/18.5	20.6/19.5/18.8
Fan	TypeX Quantity		Propeller fan X 1	
	Airflow rate	m ³ /min	200	
	Motor output	kW	0.38	
Compressor	Type		Hermetic	
	Motor output	kW	8.6	
	Crankcase heater	kW	0.045(240V)	
Refrigerant / Lubricant			R407C/MEL32	
External finish			Pre-coated galvanized sheets <MUNSELL 5Y8/1 or similar>	
External dimension		mm	1755(H)X 990(W) X 840(L)	
Protection devices	High pressure protection		2.94MPa	
	Compressor / Fan		Overcurrent protection / Thermal switch	
	Inverter		AC bus current protection, thermal switch	
Refrigerant piping diameter		Liquid / Gas	ϕ 12.7 (Flare) / ϕ 31.75 (Flange)	
Indoor unit	Total capacity		50 ~ 130% of outdoor unit capacity	
	Model / Quantity		Model 20 ~ 250 / 1 ~ 16	
Noise level	*	dB<A>	60	
Net weight		kg	240	
Operating temperature range			Indoor:15°CWB ~ 24°CWB Outdoor:-5°CDB ~ 43°CDB (0°CDB~43°CDB with outdoor unit at lower position)	Indoor:15°CDB ~ 27°CDB Outdoor:-15°CWB ~ 15.5°CWB (-12°C(-5°C)WB ~ 10°CWB with indoor unit P25(P20) type only is working)
Matters Deserving Special Mention			A pipe of ϕ 34.93 can be used for the gas pipe	

Note: 1.Cooling/heating capacity indicates the maximum value at operation under the following condition.

*1 **Cooling** Indoor : 27°CDB/19°CWB Outdoor : 35°CDB

*2 **Cooling** Indoor : 27°CDB/19.5°CWB Outdoor : 35°CDB

Heating Indoor : 20°CDB Outdoor : 7°CDB/6°CWB

Pipe length : 5m Height difference : 0m

Pipe length : 7.5m Height difference : 0m

* It is measured in anechoic room.

2. Capacity Tables

2-1. Correction by temperature

Cooling

- Standard Specifications

		PU(H)Y-P200	PU(H)Y-P250	PU(H)Y-P315
Capacity	kW	22.4	28.0	35.5
Input	kW	6.32	8.54	12.3

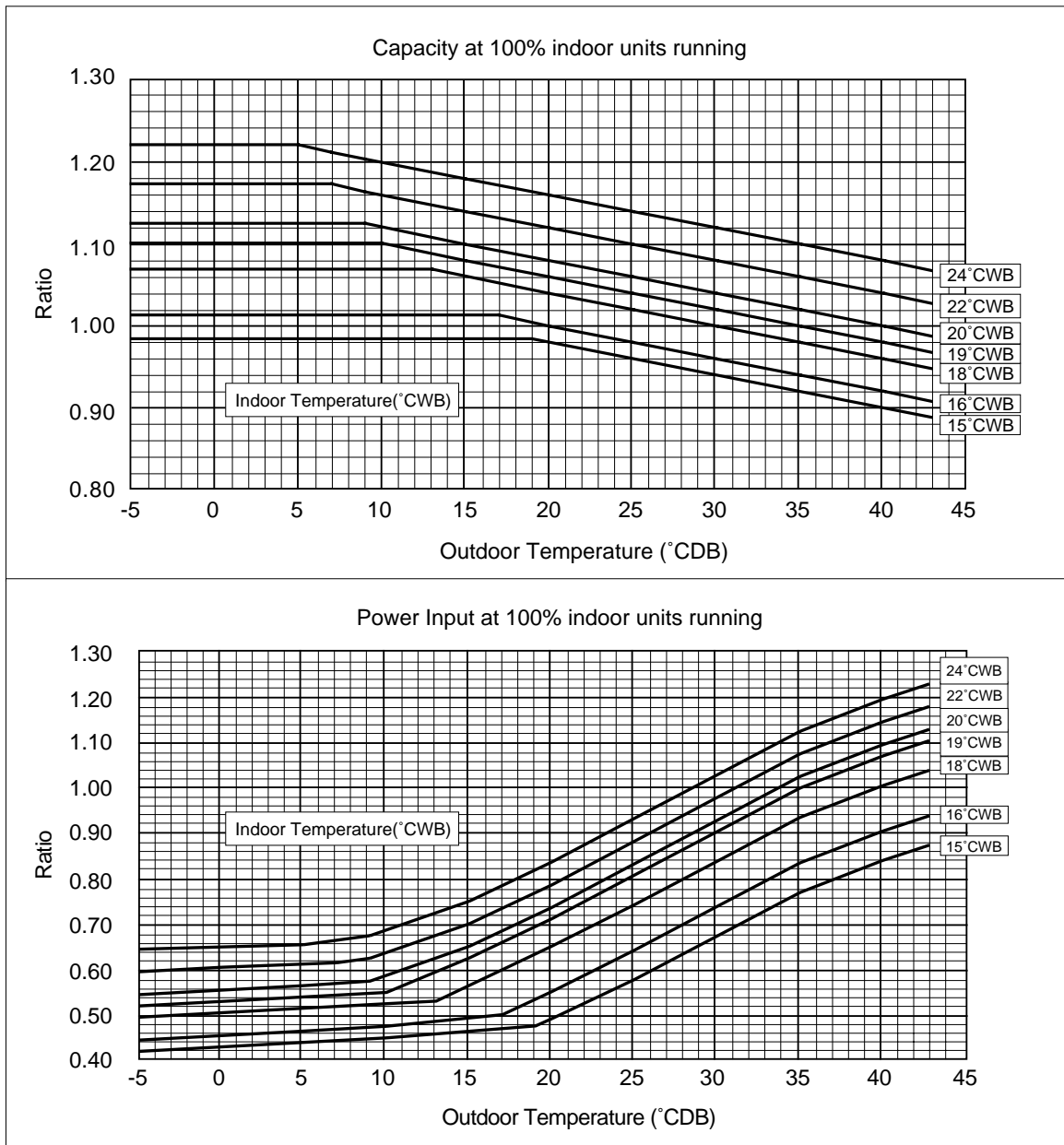

V-8.10.13(R407C)

Heating

- Standard Specifications (Outdoor 7°CDB/6°CWB Indoor 20°CDB/-)

		PUHY-P200	PUHY-P250	PUHY-P315
Capacity	kW	25.0	31.5	40.0
Input	kW	6.80	8.95	12.49

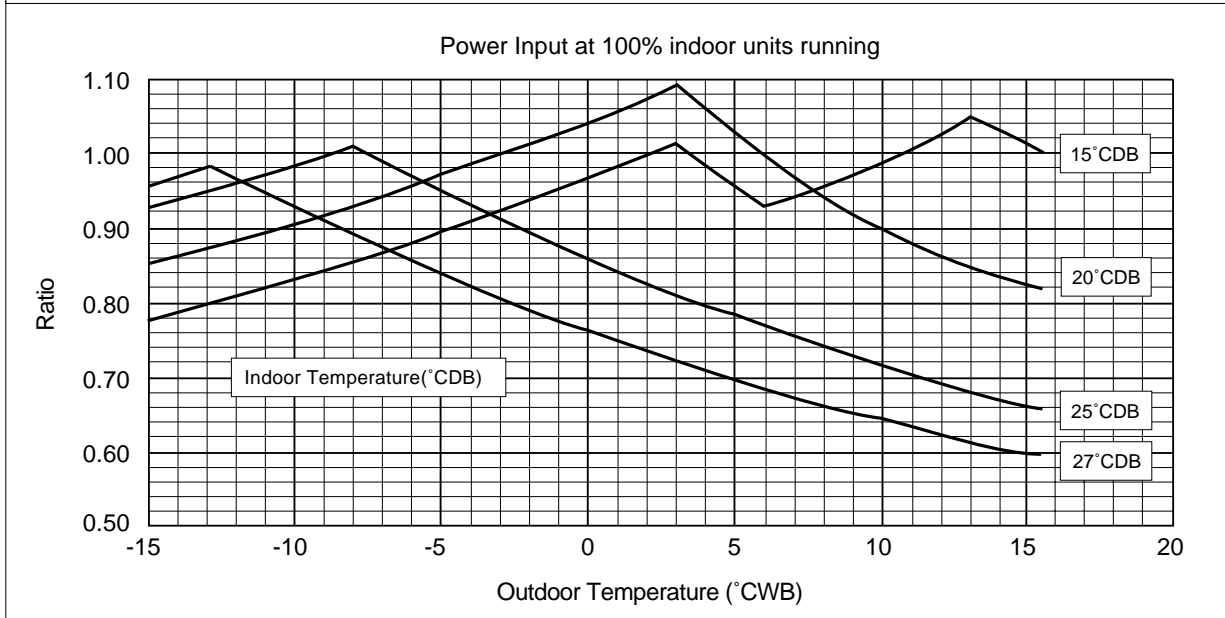
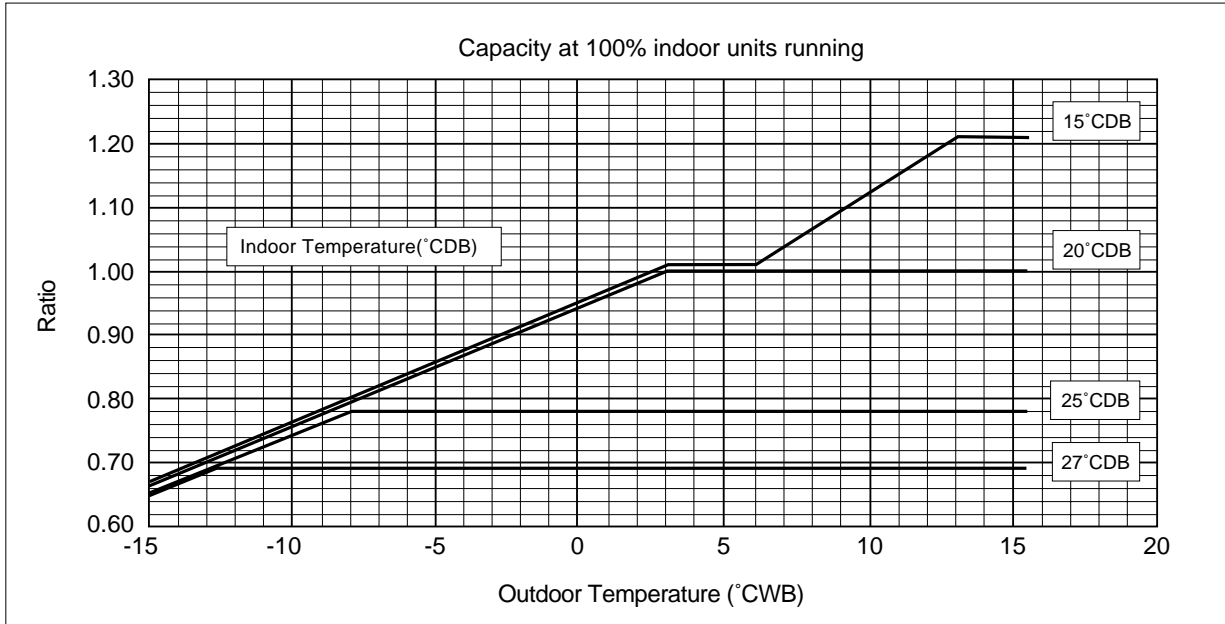

Y-8,10,13(R407C)

2-2. Correction by total indoor

PU(H)Y-P200

1) Capacity

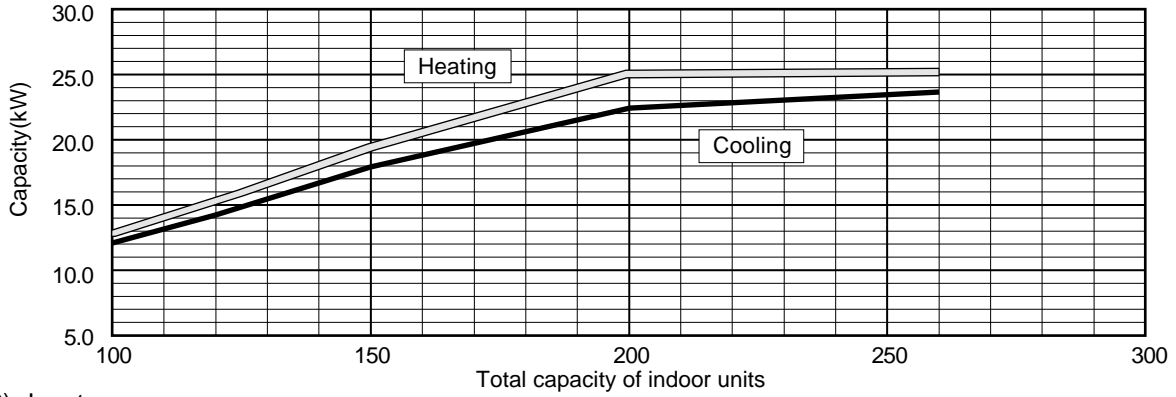

2) Input

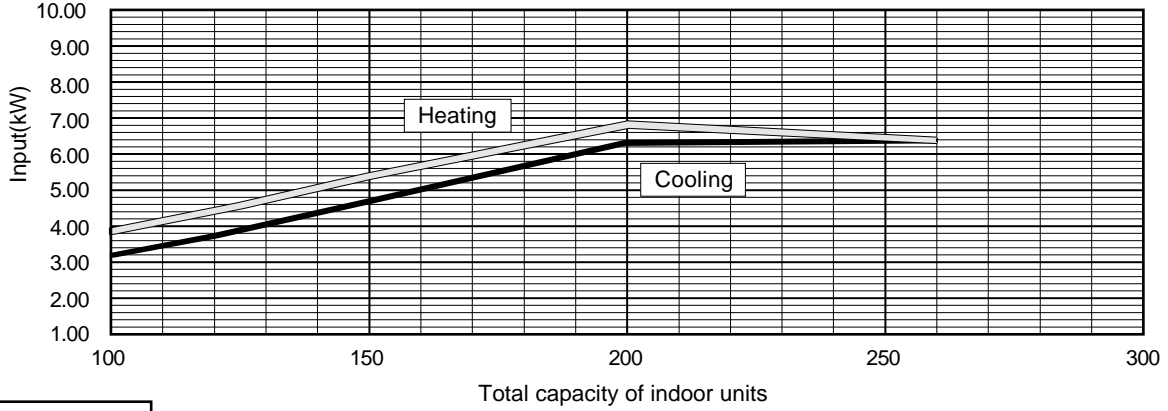

PU(H)Y-P250

1) Capacity

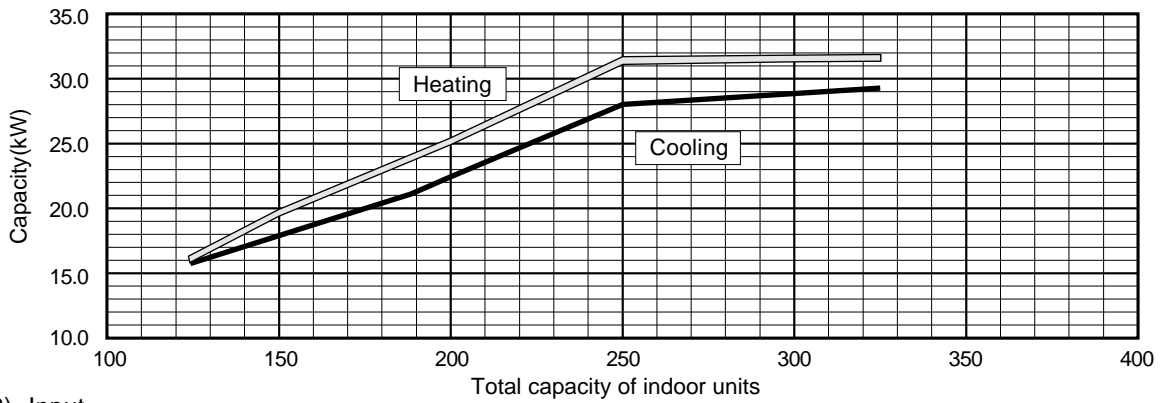

2) Input

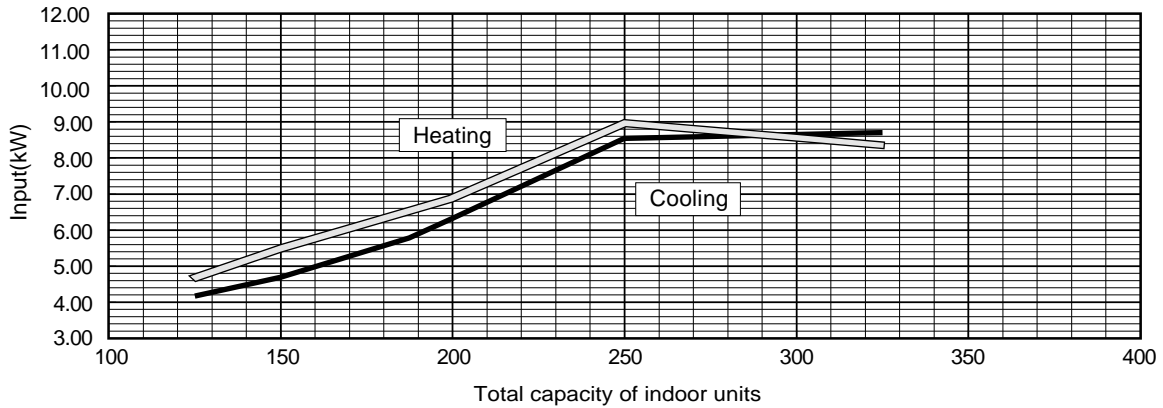

V-8.10.13 (R407C)

PU(H)Y-P315

1) Capacity

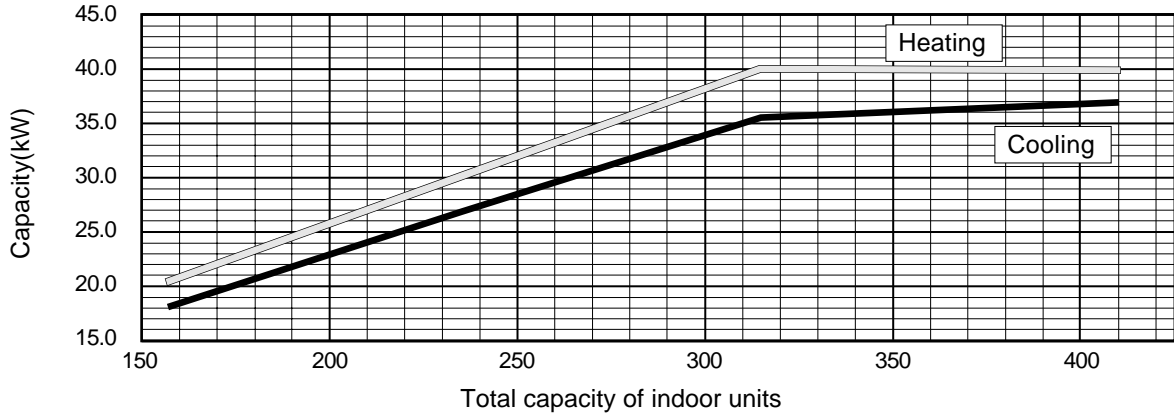

2) Input

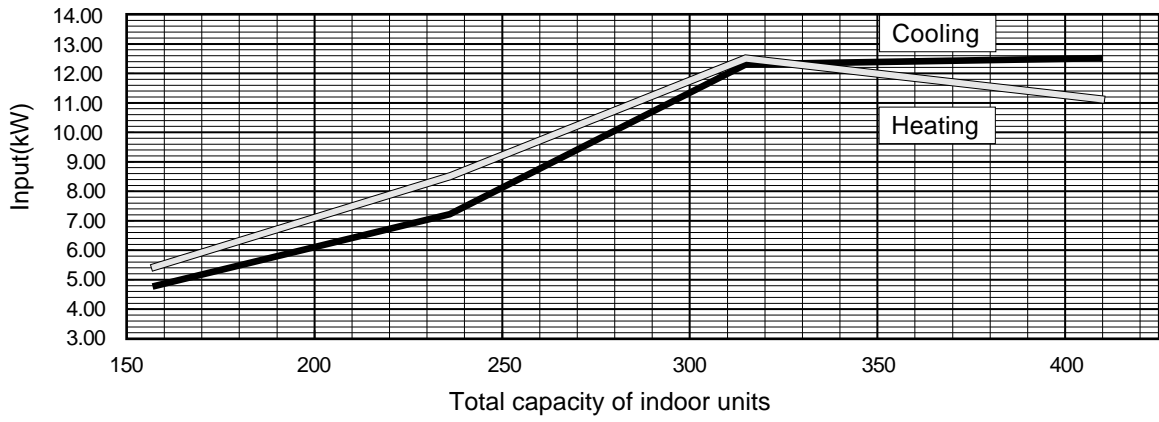

Y-8,10,13(R407C)

2-3. Correction by refrigerant piping length

To obtain a decrease in cooling/heating capacity due to refrigerant piping extension, multiply by the capacity correction factor based on the refrigerant piping equivalent length in the table below.

• Cooling capacity correction

PU(H)Y-P200

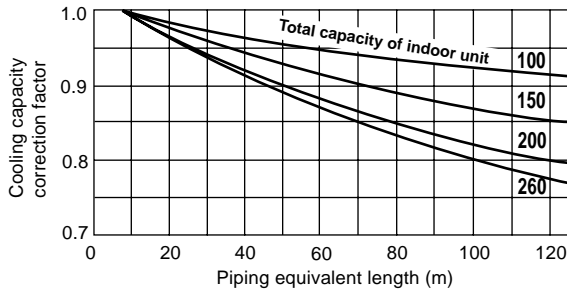

PU(H)Y-P250

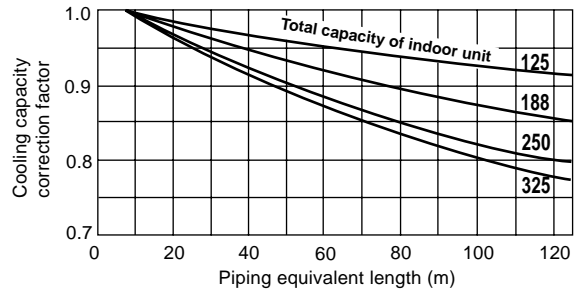

PU(H)Y-P315

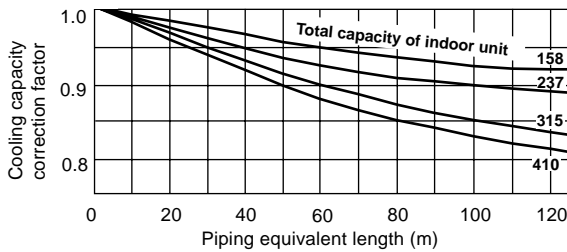

• Heating capacity correction

PUHY-P200

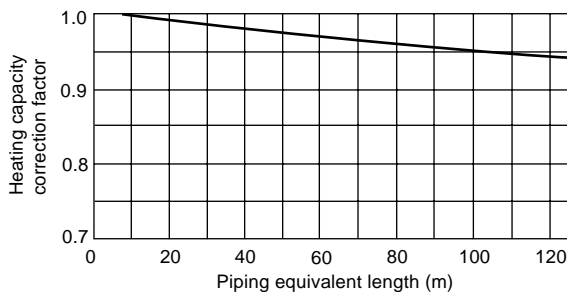

PUHY-P250

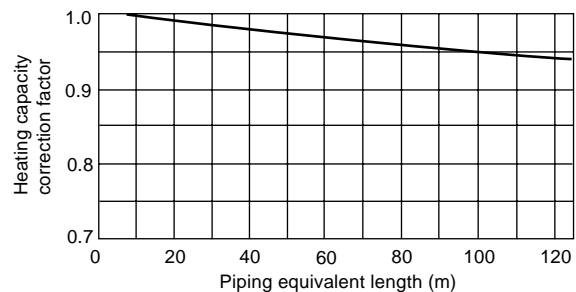

PUHY-P315

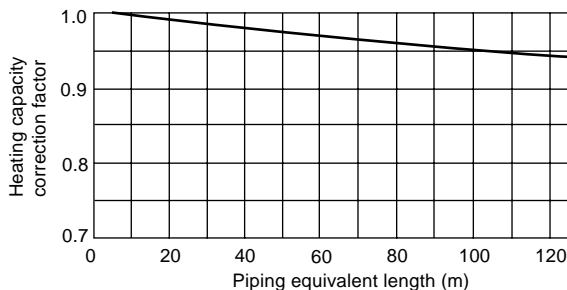

• How to obtain piping equivalent length

① **PU(H)Y-P200**

Equivalent length = (Actual piping length to the farthest indoor unit) + (0.47 × number of bent on the piping)m

② **PU(H)Y-P250**

Equivalent length = (Actual piping length to the farthest indoor unit) + (0.50 × number of bent on the piping)m

③ **PU(H)Y-P315**

Equivalent length = (Actual piping length to the farthest indoor unit) + (0.70 × number of bent on the piping)m

V-8.10.13(R407C)

2-4. Correction at frosting and defrosting

When a decrease in heating capacity due to frosted and defrosting operations is considered, the value multiplied by the correction factor in the table below represents the heating capacity.

Correction factor table

Outdoor inlet air temp (°CWB)		6	4	2	0	-2	-4	-6	-8	-10
Correction factor	PUHY-P200-250	1.0	0.95	0.84	0.83	0.87	0.9	0.95	0.95	0.95
	PUHY-P315	1.0	0.93	0.82	0.82	0.86	0.9	0.9	0.95	0.95

2-5. Operation limit

• Cooling

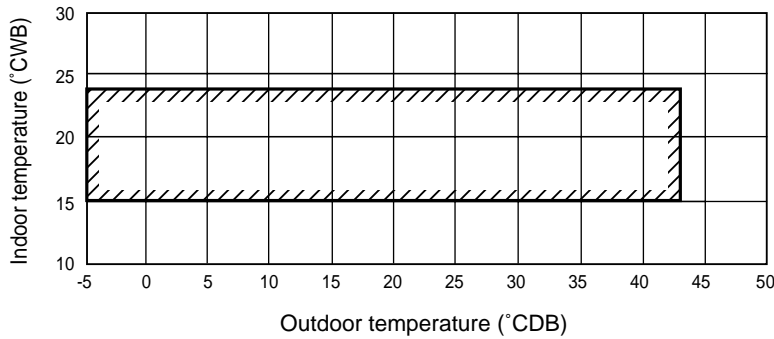

(Outdoor door temperature :
0°CDB~43°CDB with outdoor unit
at lower position in cooling mode.)

• Heating

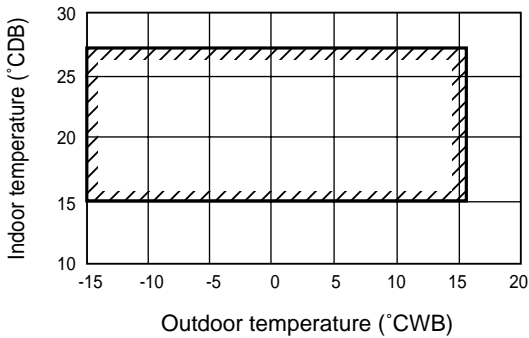

(When the indoor P25(P20)type only is working,
the outdoor unit [PUHY-P315] inlet air temperature
becomes -12°C(-5°C)WB~10°CWB.)

Y-8,10,13(R407C)

3. Sound Levels

PU(H)Y-P200

Measurement condition

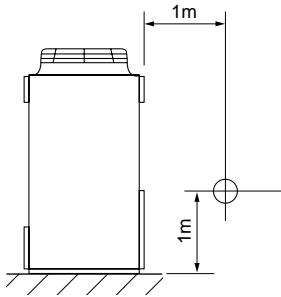

Sound pressure level in anechoic room
56 dB (A)

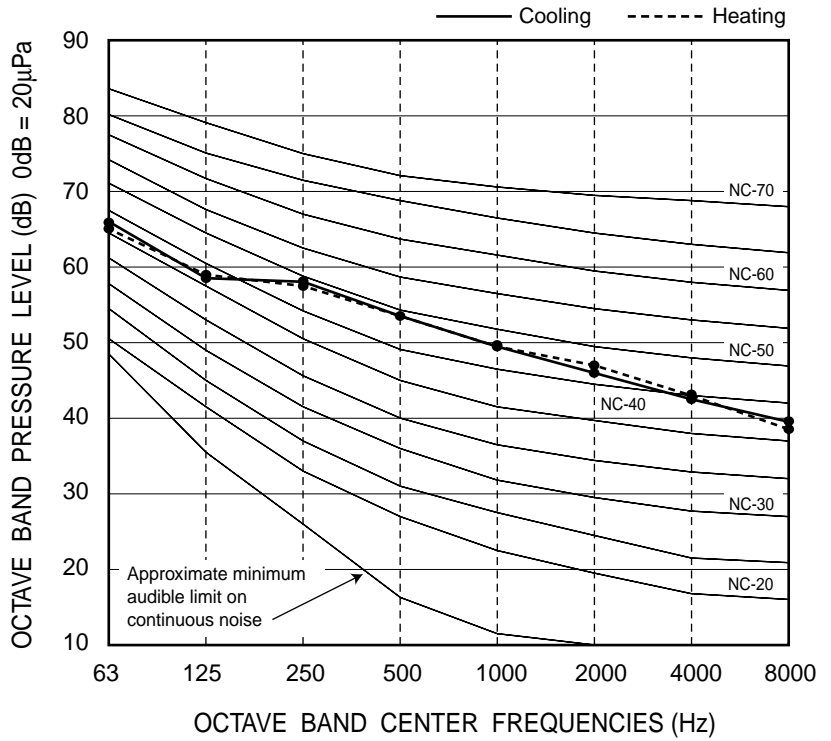

PU(H)Y-P250

Measurement condition

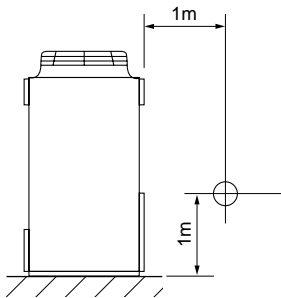

Sound pressure level in anechoic room
57 dB (A)

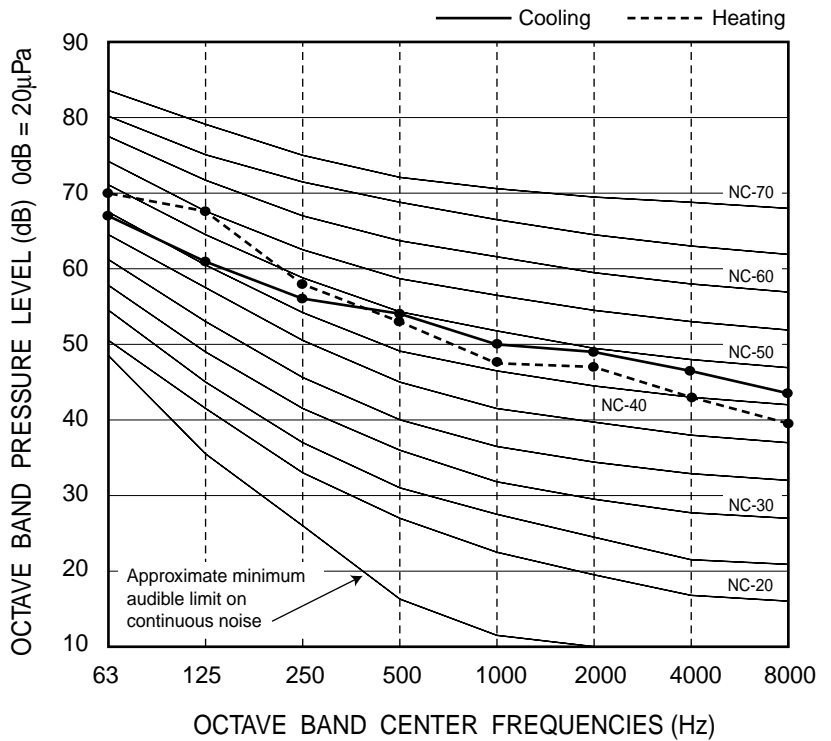

V-81013(R407C)

PU(H)Y-P315

Measurement condition

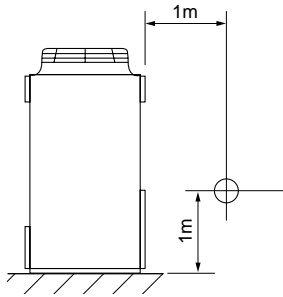

Sound pressure level in anechoic room

60 dB (A)

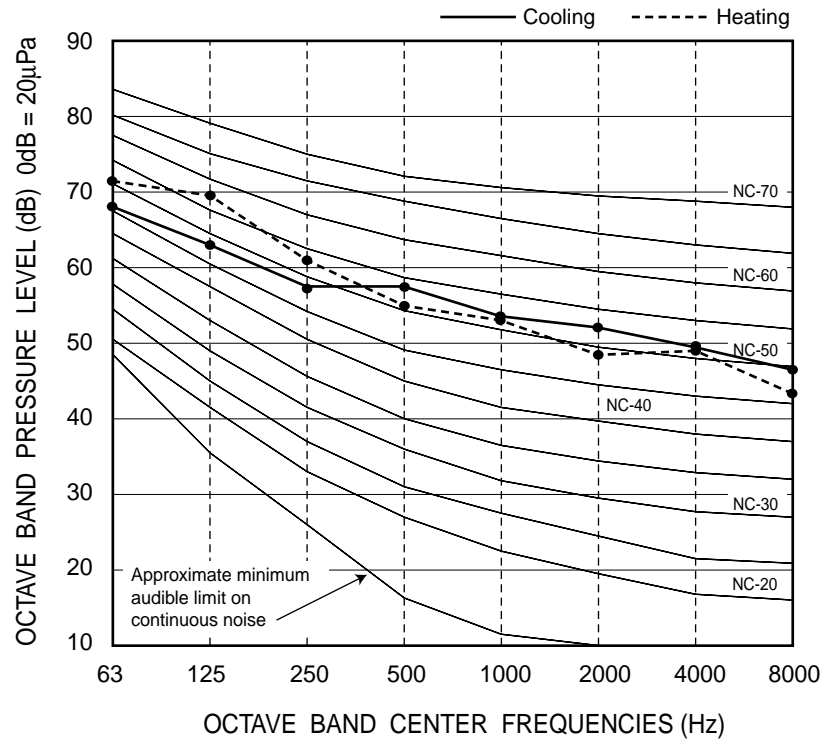

Y-8,10,13(R407C)

4. External Dimensions

PU(H)Y-P200,250,315YEM-A(-BF,-BS)

Unit : mm

- <Accessory>
 - Refrigerant (gas) conn. pipe.....1pc.
(The connecting pipe is fixed with the unit)
 - Packing for conn. pipe1pc.
(Attached near the ball valve)
 - Wiring mounting board
 - Conduit mounting plate
(Painted the same color as the unit body)
 - $\phi 40$1pc.
 - $\phi 33$1pc.
 - $\phi 27$1pc.
 - Tapping screw 4 X 10.....6pcs.
- Note1: Please leave a space under the outdoor unit for the piping. When you connect the piping from the bottom.
(Please be careful not to close the hole of the bottom plate by the basement)

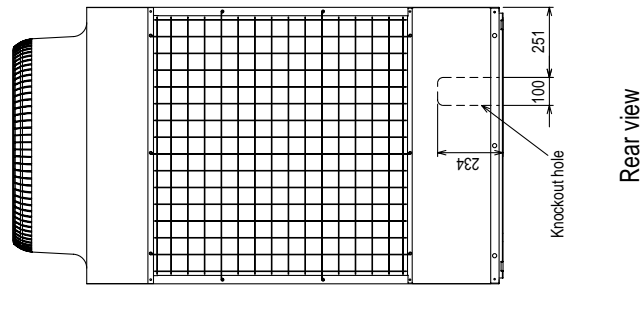
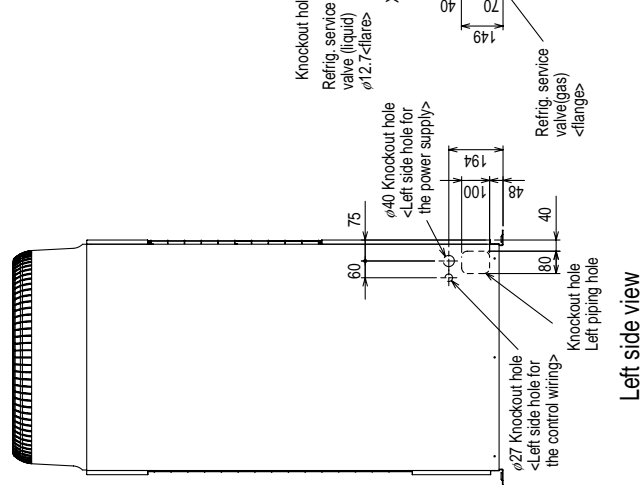
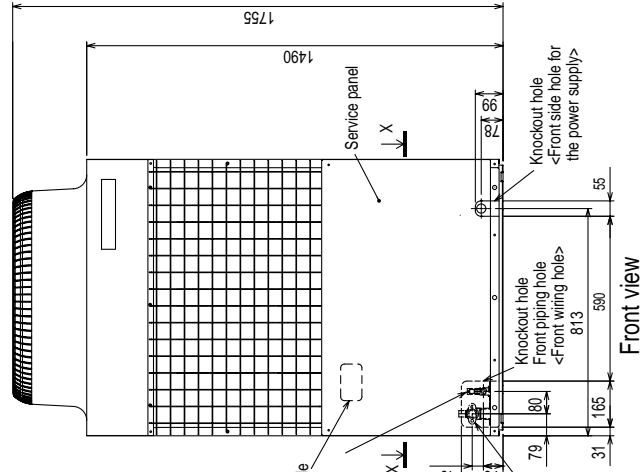
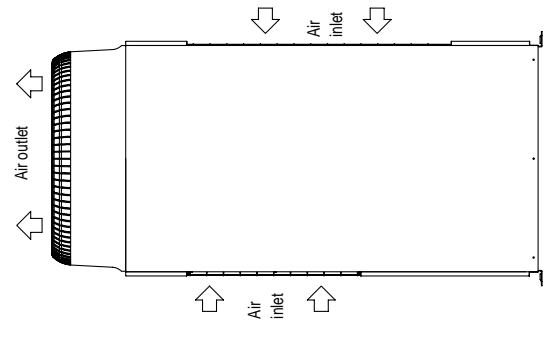
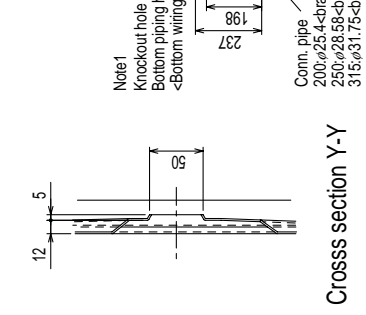
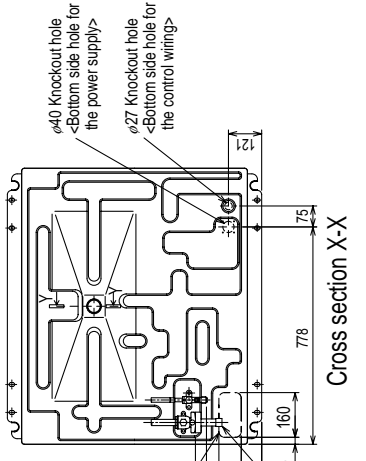
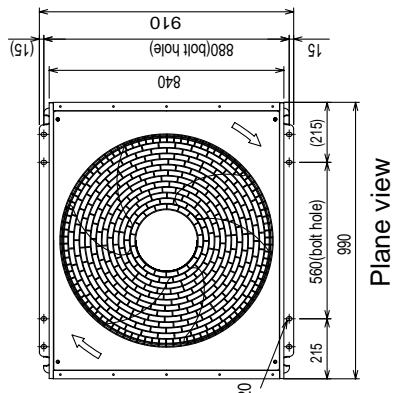

Y-81013(R407C)

5. Electrical Wiring Diagram

PU(H)Y-P200, 250, 315YEM-A(-BF, -BS)

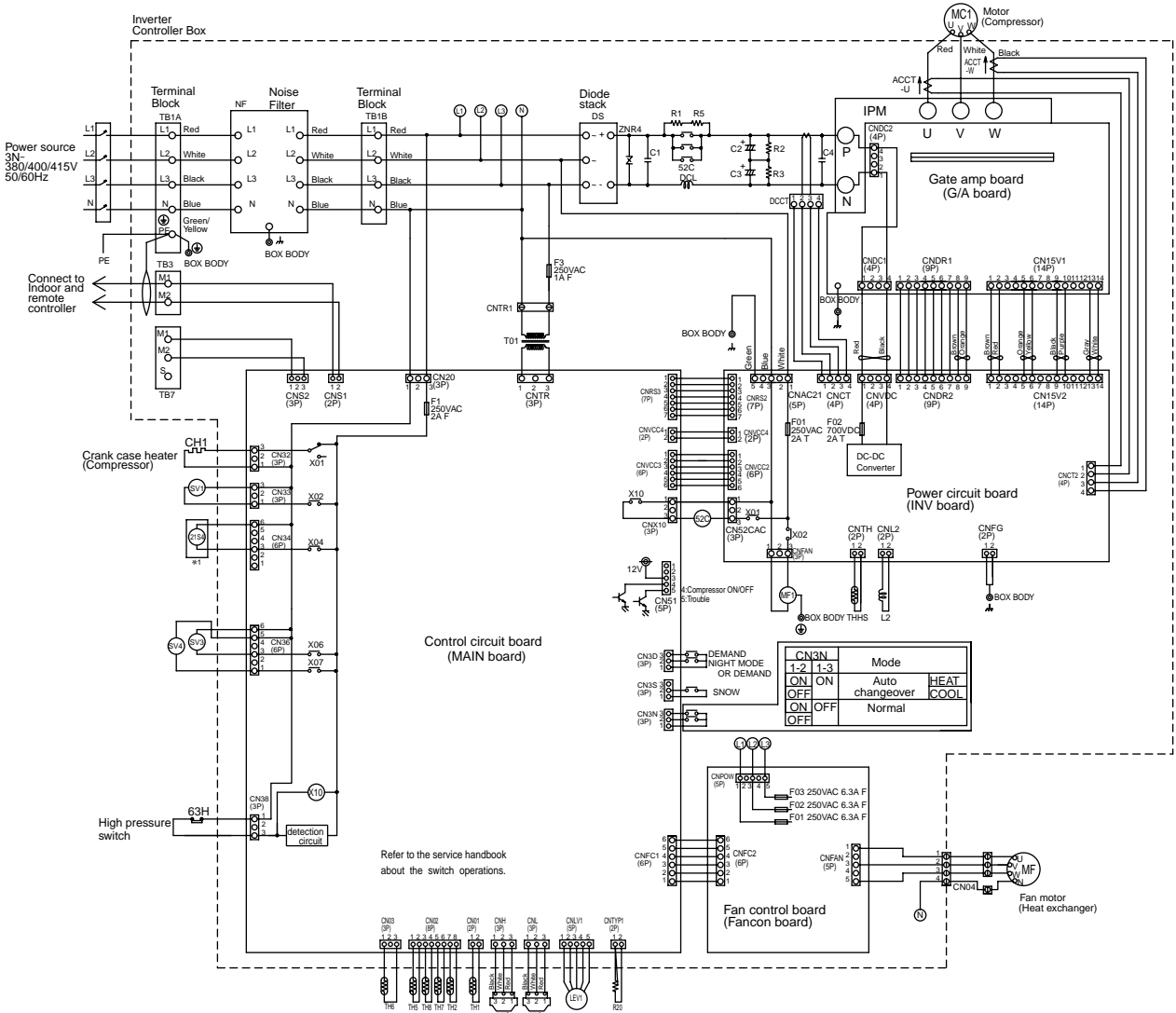

Y-8,10,13 (R407C)

<DIFFERENCE OF APPLIANCE>

Appliance	N a m e
PUHY-P200/250/315YEM-A(-BF, -BS)	All exists
PUY-P200/250/315YEM-A(-BF, -BS)	*1* are not existed

<SYMBOL EXPLANATION>

Symbol	N a m e	Symbol	N a m e	Symbol	N a m e	Symbol	N a m e
DCL	DC reactor (Power factor improvement)	SV3	Solenoid valve (Heat exchanger capacity control)	L2	Choke coil (Transmission)	TH8	Thermistor bypass outlet temp. detect at Sub-cool coil
DCCT	Current Sensor	SV4	Solenoid valve (Heat exchanger capacity control)	IPM	Intelligent power module	THHS	Radiator panel temp. detect
ACCT-U,W	Current Sensor			TH1	Thermistor Discharge pipe temp. detect		
ZNR4	Varistor			TH2	Saturation evapo. temp. detect	X1-10	Aux. relay
52C	Magnetic contactor (Inverter main circuit)	LEV1	Electric expansion valve (Sub-cool coil bypass)	TH5	Pipe temp. detect	⊕	Earth terminal
MF1	Fan motor (Radiator panel)			TH6	OA temp. detect		
21S4 *1	4-way valve	63HS	High pressure sensor	TH7	liquid outlet temp. detect at Sub-cool coil		
SV1	Solenoid valve (Discharge-suction bypass)	63LS	Low pressure sensor				

6. Refrigerant Circuit Diagram And Thermal Sensor

PUHY-P200, 250, 315

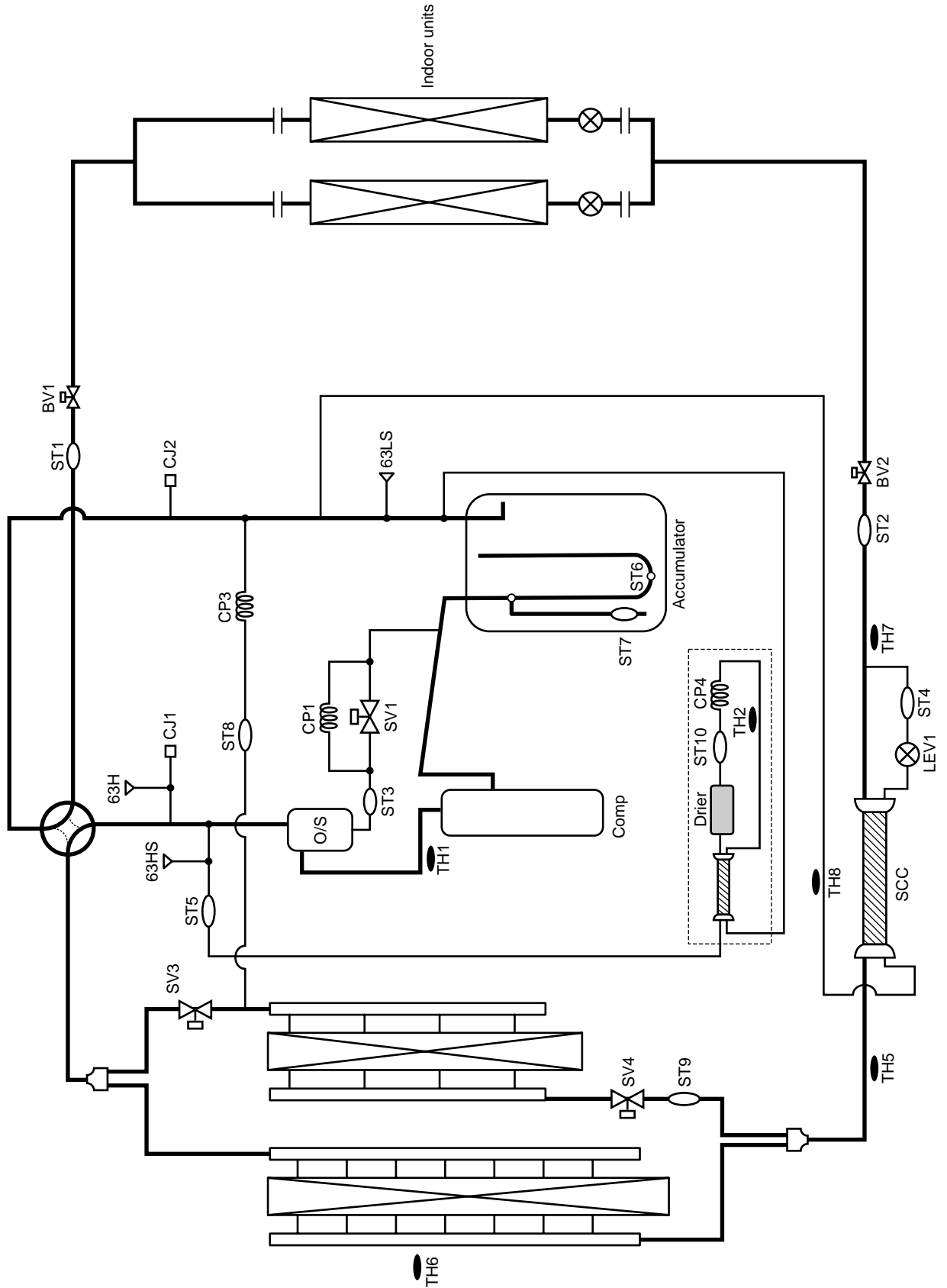

V-8,10,13(R407C)

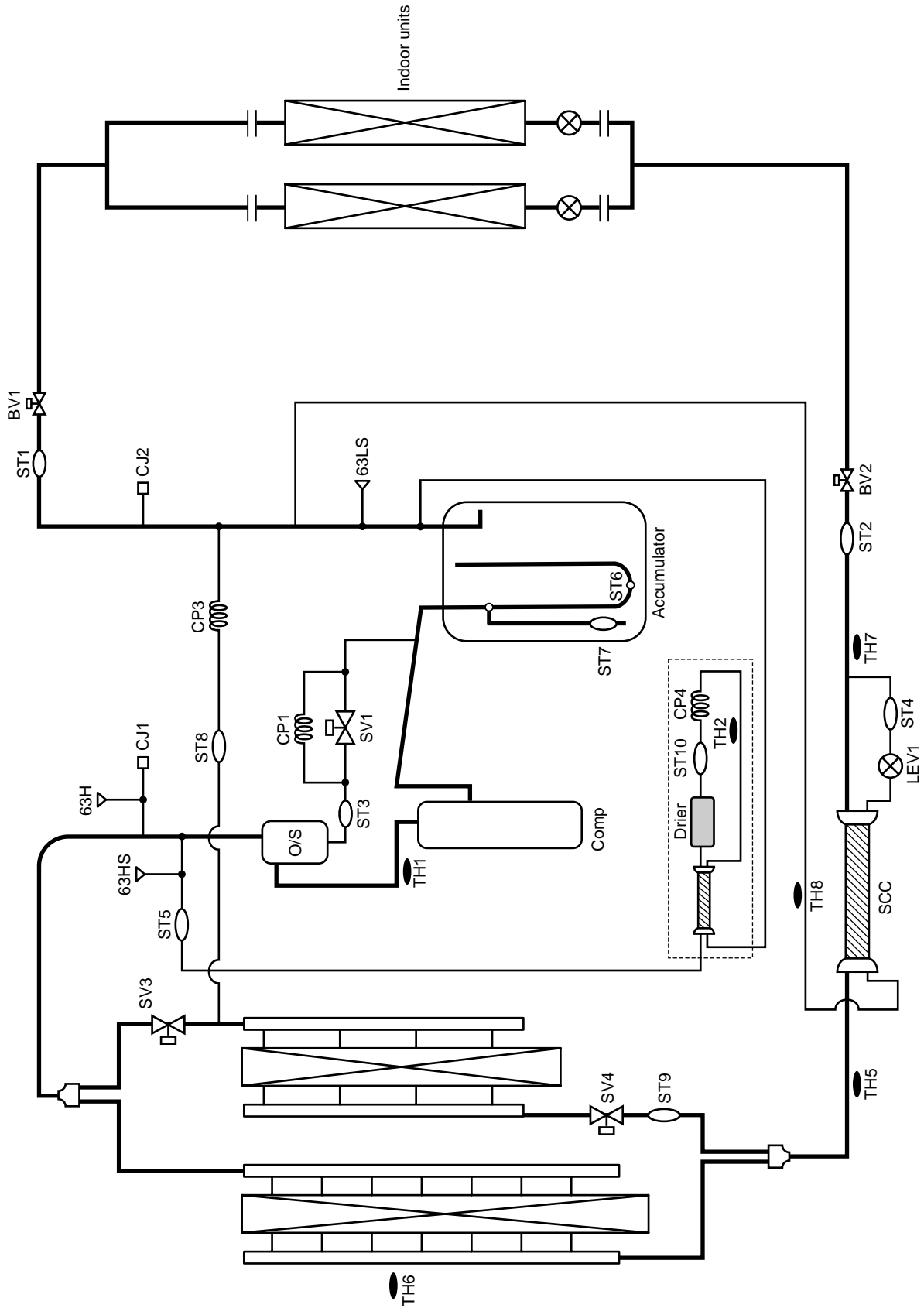

PUHY-P400-500YEM-A(-BF, -BS)

CONTENTS

1. Specifications	I -44
2. Capacity Tables	I -46
2-1 Correction by temperature	I -46
2-2 Correction by total indoor	I -48
2-3 Correction by refrigerant piping length	I -49
2-4 Correction at frosting and defrosting	I -50
2-5 Operation limit	I -50
3. Sound Levels	I -51
4. External Dimensions	I -52
5. Electrical Wiring Diagram	I -53
6. Refrigerant Circuit Diagram	I -54
And Thermal Sensor	

1. Specifications

Model name			PUHY-P400YEM-A(-BF, -BS)	
			Cooling	Heating
Capacity	*1	kW	45.0	50.0
	*2	kcal/h	40,000	—
Power source			3N ~ 380/400/415V 50/60Hz	
Power input		kW	15.87	14.59
Current		A	26.7/25.4/24.5	24.6/23.4/22.5
Fan	TypeX Quantity		Propeller fan X2	
	Airflow rate		m ³ /min	
	Motor output		kW	
			400	
			0.38 X 2	
Compressor	Type		Hermetic	
	Motor output		kW	
	Crankcase heater		kW	
			7.5 + 4.5	
			0.045 + 0.045	
Refrigerant / Lubricant			R407C / MEL32	
External finish			Pre-coated galvanized sheets (Powder coating) <MUNSELL 5Y8/1 or similar>	
External dimension		mm	1755(H)X 1990(W) X 840(L)	
Protection devices	High pressure protection		2.94MPa	
	Compressor / Fan		Overcurrent protection / Thermal switch	
	Inverter		AC bus current protection, thermal switch	
Refrigerant piping diameter		Liquid / Gas	φ 15.88 (Flare) / φ 34.93 (Flange)	
Indoor unit	Total capacity		50 ~ 130% of outdoor unit capacity	
	Model / Quantity		Model 25 ~ 250 / 1 ~ 20	
Noise level		* dB<A>	60 / 61	
Net weight		kg	440	
Operating temperature range			Indoor:15°CWB ~ 24°CWB Outdoor:-5°CDB ~ 43°CDB (0°CDB ~43°CDB with outdoor unit at lower position.)	Indoor:15°CDB ~ 27°CDB Outdoor:-12°CWB ~ 15.5°CWB (-12°CWB~10°CWB with indoor unit 25 type only is working)

Note: 1.Cooling/heating capacity indicates the maximum value at operation under the following condition.

*1 **Cooling** Indoor : 27°CDB/19°CWB Outdoor : 35°CDB

*2 **Cooling** Indoor : 27°CDB/19.5°CWB Outdoor : 35°CDB

Heating Indoor : 20°CDB Outdoor : 7°CDB/6°CWB

Pipe length : 5m Height difference : 0m

Pipe length : 7.5m Height difference : 0m

* It is measured in anechoic room.

Model name			PUHY-P500YEM-A(-BF, -BS)	
			Cooling	Heating
Capacity	*1	kW	56.0	63.0
	*2	kcal/h	50,000	—
Power source			3N ~ 380/400/415V 50/60Hz	
Power input		kW	19.89	18.27
Current		A	33.5/31.9/30.7	30.8/29.2/28.2
Fan	TypeX Quantity		Propeller fanX 2	
	Airflow rate		m ³ /min	
	Motor output		kW	
			400	0.38 X 2
Compressor	Type		Hermetic	
	Motor output		kW	
	Crankcase heater		kW	
			7.5 + 7.5	0.045 + 0.056
Refrigerant / Lubricant			R407C / MEL32	
External finish			Pre-coated galvanized sheets (Powder coating) <MUNSELL 5Y8/1 or similar>	
External dimension		mm	1755(H)X 1990(W) X 840(L)	
Protection devices	High pressure protection		2.94MPa	
	Compressor / Fan		Overcurrent protection / Thermal switch	
	Inverter		AC bus current protection, thermal switch	
Refrigerant piping diameter		Liquid / Gas	φ 15.88 (Flare) / φ 34.93 (Flange)	
Indoor unit	Total capacity		50 ~ 130% of outdoor unit capacity	
	Model / Quantity		Model 25 ~ 250 / 1 ~ 20	
Noise level		* dB<A>	60 / 61	
Net weight		kg	475	
Operating temperature range			Indoor:15°CWB ~ 24°CWB Outdoor:-5°CDB ~ 43°CDB (0°CDB ~43°CDB with outdoor unit at lower position.)	Indoor:15°CDB ~ 27°CDB Outdoor:-12°CWB ~ 15.5°CWB (-12°CWB~10°CWB with indoor unit 25 type only is working)

Note: 1.Cooling/heating capacity indicates the maximum value at operation under the following condition.

*1 Cooling Indoor : 27°CDB/19°CWB	Outdoor : 35°CDB	*2 Cooling Indoor : 27°CDB/19.5°CWB	Outdoor : 35°CDB
Heating Indoor : 20°CDB	Outdoor : 7°CDB/6°CWB	Pipe length : 5m	Height difference : 0m
Pipe length : 7.5m	Height difference : 0m		

* It is measured in anechoic room.

Big (R407C)

2. Capacity Tables

2-1. Correction by temperature

Cooling

- Standard Specifications

		PUHY-P400	PUHY-P500
Capacity	kW	45.0	56.0
Input	kW	15.87	19.89

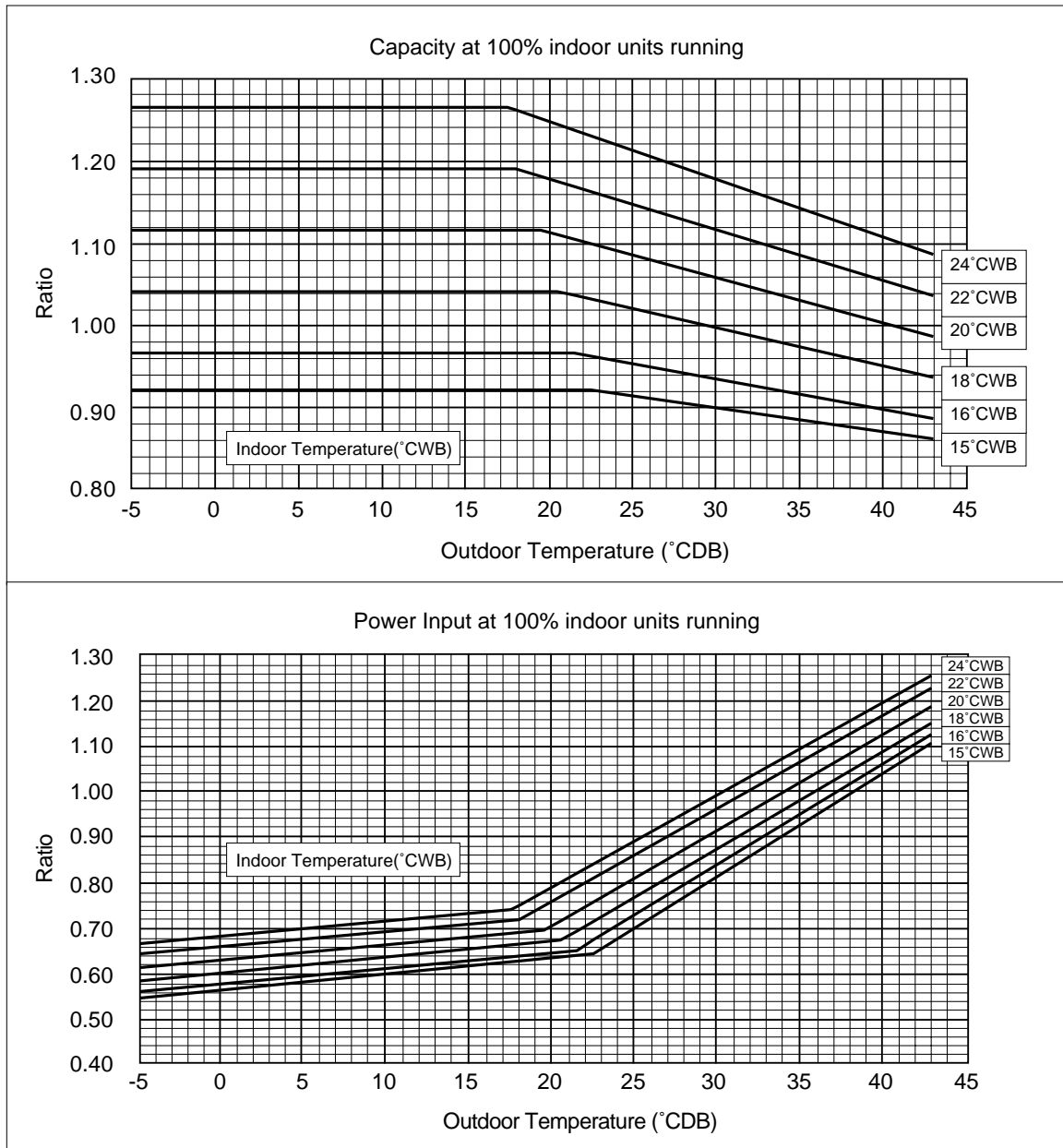

Big Y(R407C)

Heating

- Standard Specifications

		PUHY-P400	PUHY-P500
Capacity	kW	50.0	63.0
Input	kW	14.59	18.27

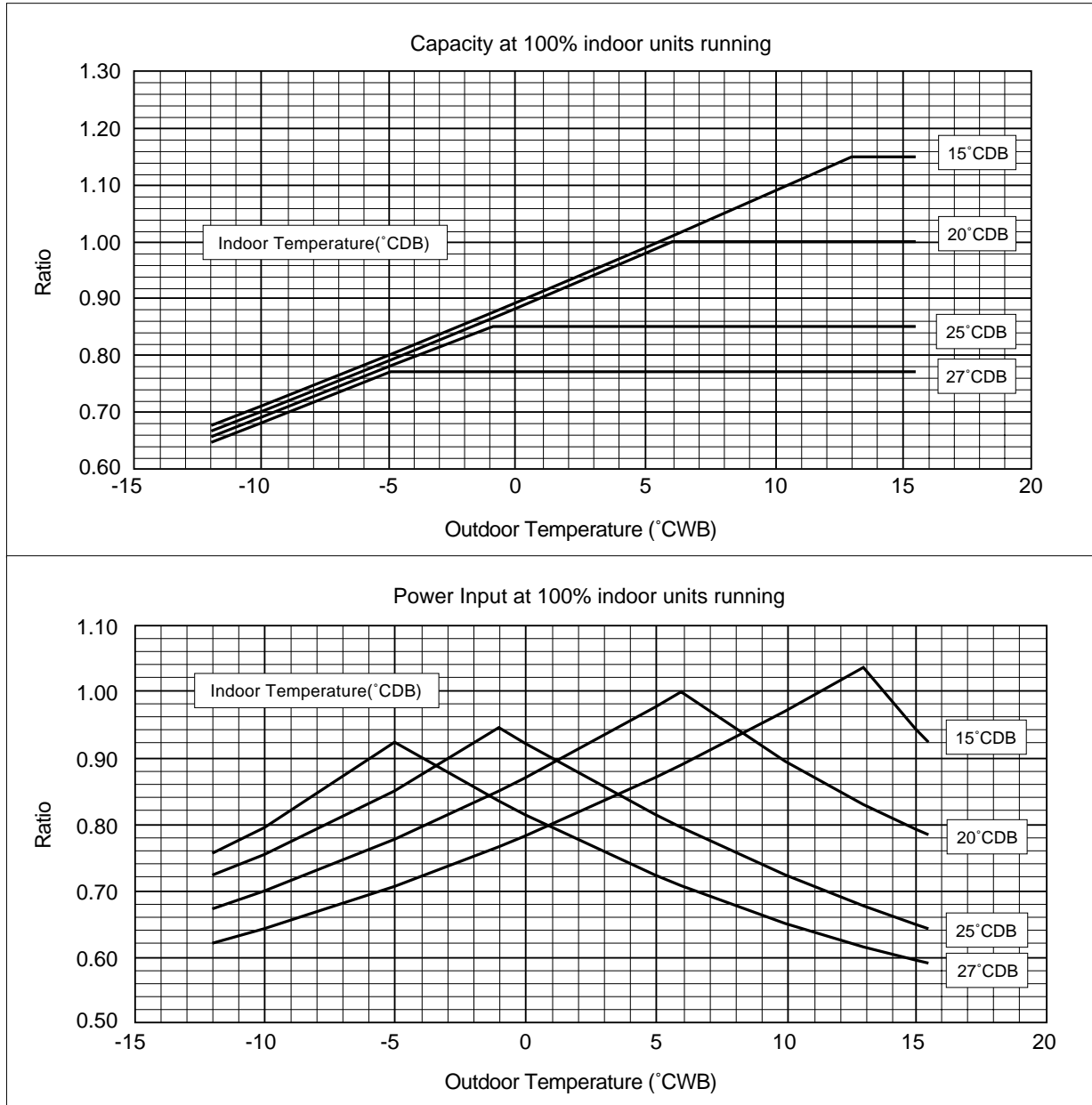

Big V(R407C)

2-2. Correction by total indoor

PUHY-P400

1) Capacity

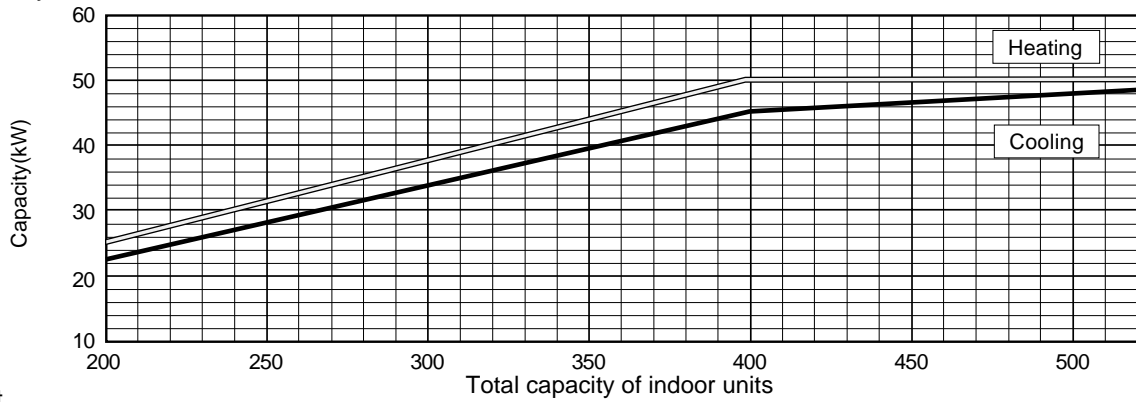

2) Input

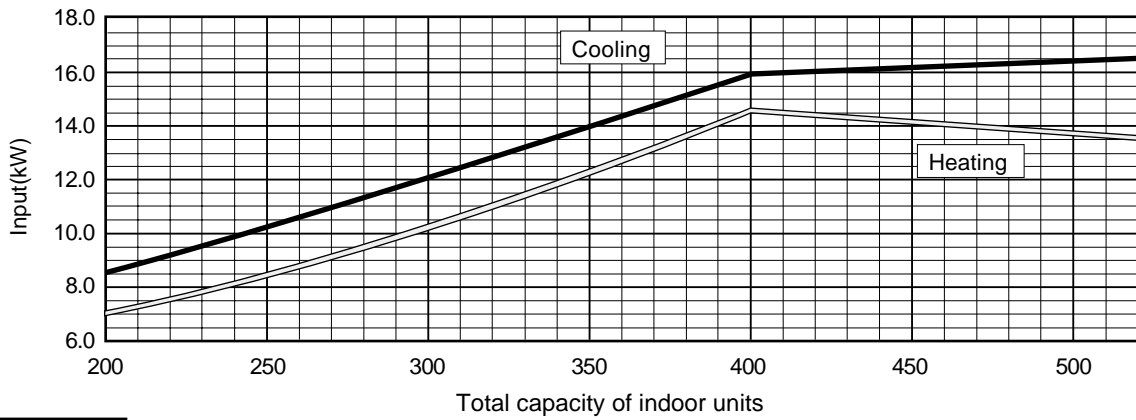

PUHY-P500

1) Capacity

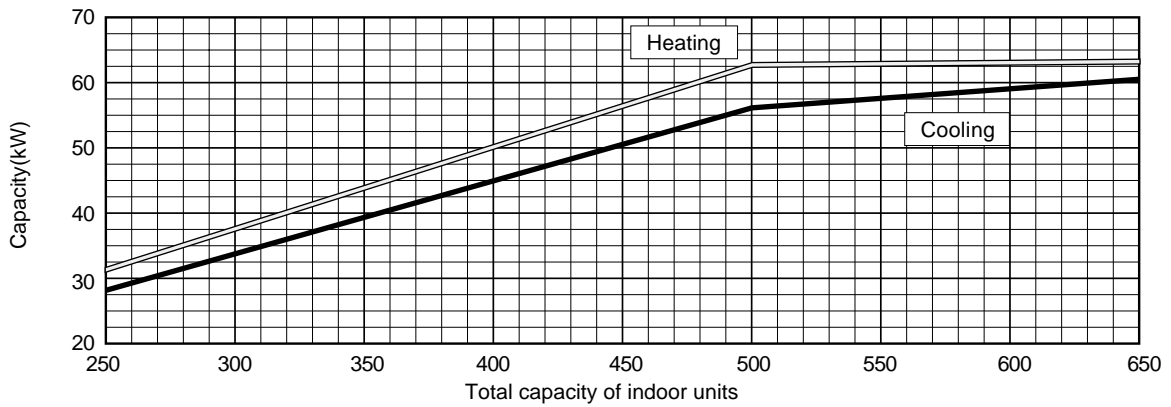

2) Input

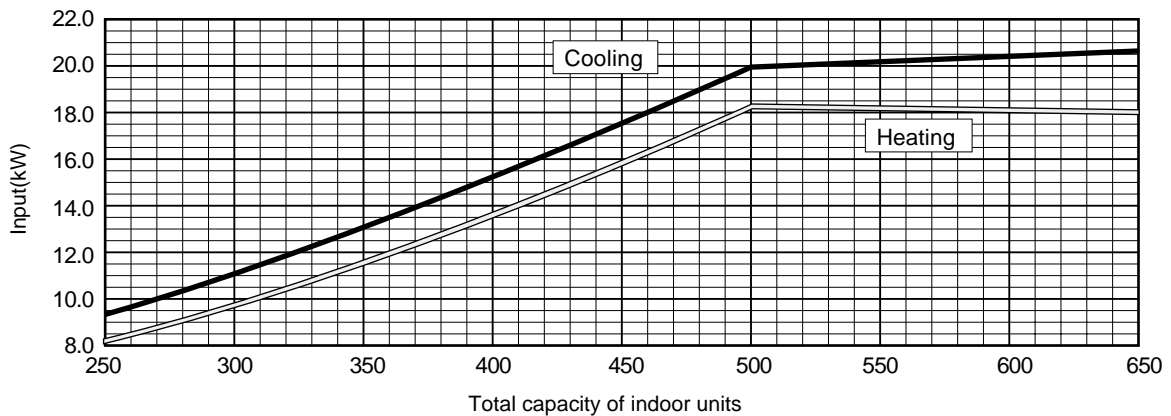

Big Y(R407C)

2-3. Correction by refrigerant piping length

To obtain a decrease in cooling/heating capacity due to refrigerant piping extension, multiply by the capacity correction factor based on the refrigerant piping equivalent length in the table below.

• Cooling capacity correction

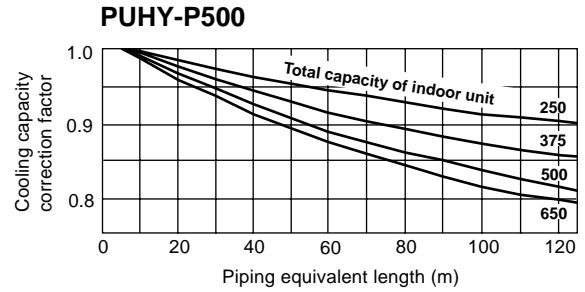
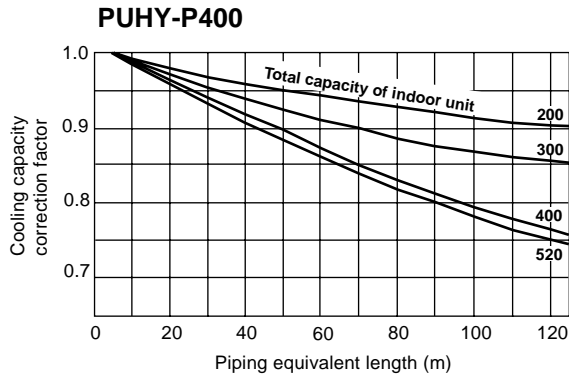

• Heating capacity correction

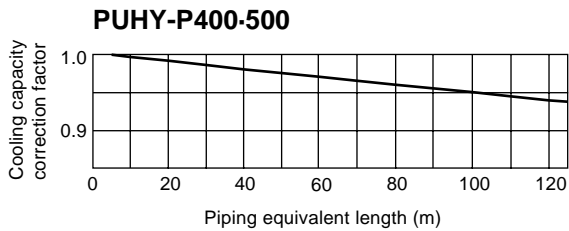

• How to obtain piping equivalent length

① PUHY-P400

Equivalent length = (Actual piping length to the farthest indoor unit) + (0.70 × number of bent on the piping)m

② PUHY-P500

Equivalent length = (Actual piping length to the farthest indoor unit) + (0.80 × number of bent on the piping)m

2-4. Correction at frosting and defrosting

When a decrease in heating capacity due to frosted and defrosting operations is considered, the value multiplied by the correction factor in the table below represents the heating capacity.

Correction factor table

Outdoor inlet air temp (°CWB)	6	4	2	0	-2	-4	-6	-8	-10
Correction factor	1.0	0.98	0.89	0.89	0.90	0.92	0.95	0.95	0.95

2-5. Operation limit

• Cooling

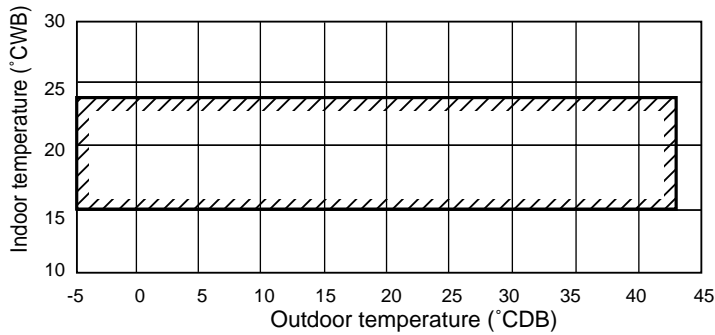

When the indoor unit is located above the outdoor unit for 4m or more, the outdoor unit inlet air temperature becomes 0~43°CDB.

• Heating

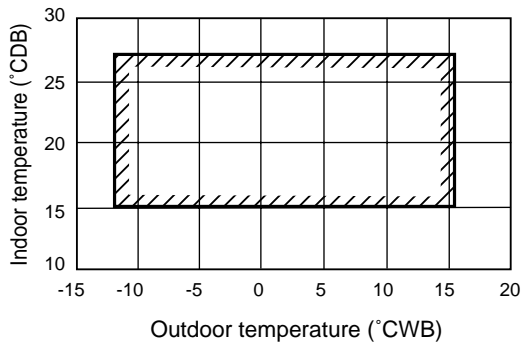

When the indoor unit 25type only is working, the outdoor unit inlet air temperature becomes -12~10°CWB.

3. Sound Levels

PUHY-P400

Measurement condition

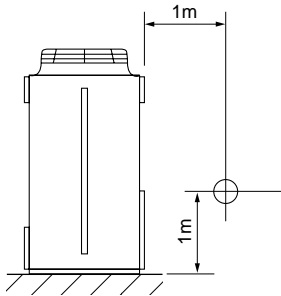

Sound pressure level in anechoic room

60 / 61 dB (A)

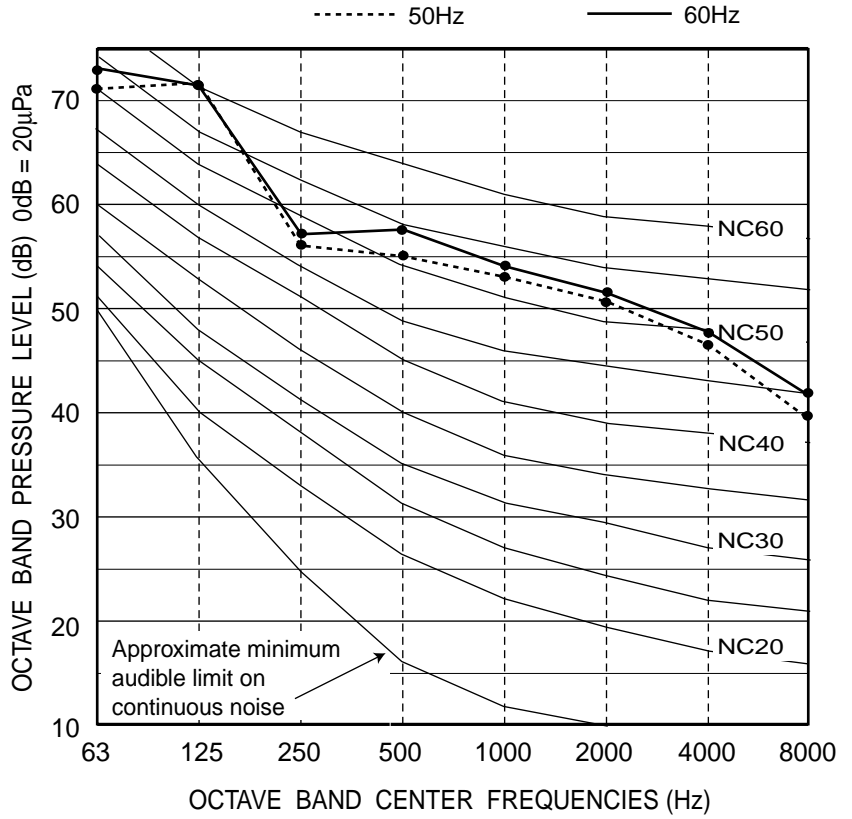

PUHY-P500

Measurement condition

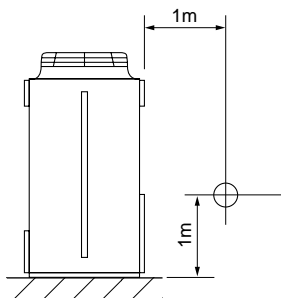

Sound pressure level in anechoic room

60 / 61 dB (A)

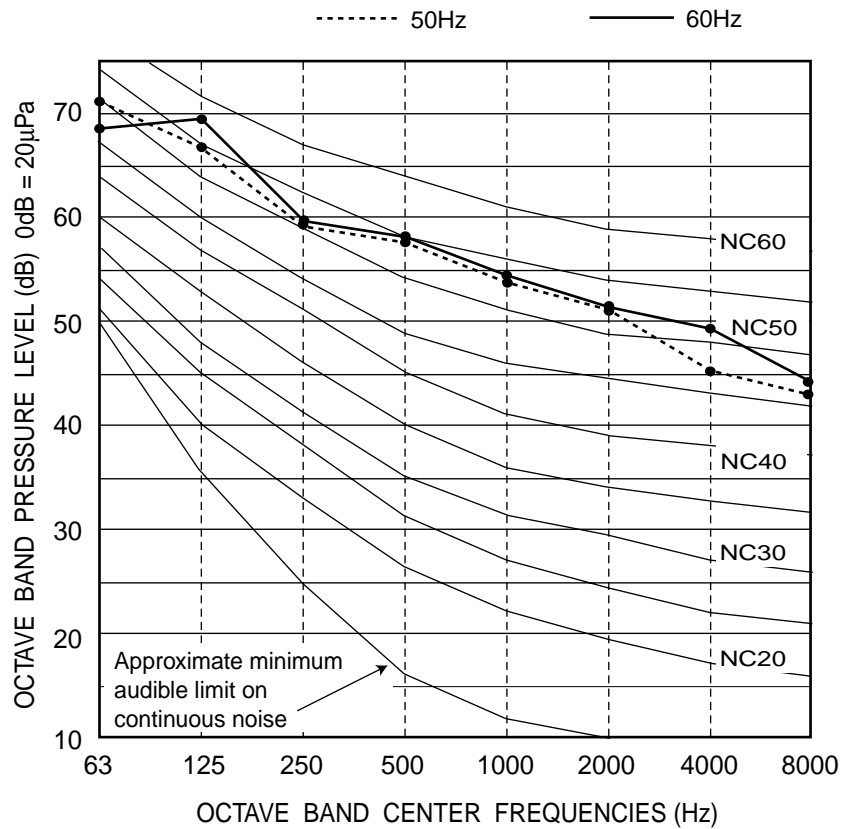

Big (R407C)

5. Electrical Wiring Diagram

PUHY-P400, 500YEM-A(-BF, -BS)

<Symbol explanation>

Symbol	Name	Symbol	Name
DCL	DC reactor (Power factor improvement)	TH11.12	Thermistor
ACCT-U,W	Current Sensor	TH2	Discharge pipe temp. detect
ZNR4	Varistor	TH3	Saturation expo. temp. detect
52C1	Magnetic contactor (Inverter main circuit)	TH4	Accumulator liquid temp. detect
52C2	Magnetic contactor	TH5	Pipe temp. detect (Fan outlet)
51C2	Overload relay	TH6	OA temp. detect
M1	Magnetic contactor (Fan motor)	TH7	SC coil temp. detect (Liquid exit area)
2F1	Fan motor (Radiator panel)	TH8	SC coil temp. detect (Bypass exit area)
2V1,2,3,2,3,2	4-way valve	TH9a	LEI (temp. detect (area))
SV5,6,7,8	Solenoid valve (Heat exchanger capacity control)	TH9b	Composition sensing temp.
SLEV	Electronic expansion valve(Oil return)	TH10a	Gas pipe temp. (Hex outlet)
LEV1	Electronic expansion valve(SC coil)	TH10b	Compressor shell temp.
63HS	High pressure sensor	TH10c	Radiator panel temp. detect
63HL	Low pressure sensor	LD	Accumulator liquid level detect
63H1.2	High pressure switch	CH11.12	Crank case heater(Compressor)
L2	Choke coil(Transmission)	CH2.3	Cord heater
IPM	Intelligent power module	SSR	Solid state relay
T1-10	Terminal	X1.2,4-12	Aux. relay
		FB1-5	Ferrite core
			E earth terminal

<Difference of appliances>

Appliance	Name
PUHY-P400	PUHY-P400
PUHY-500YEM-A(-BF, -BS)	PUHY-500YEM-A(-BF, -BS)
PUHY-500YEM-L1-2,3,4,5,6,7,8,9,10,11,12	PUHY-500YEM-L1-2,3,4,5,6,7,8,9,10,11,12
PUHY-500YEM-L1-2,3,4,5,6,7,8,9,10,11,12	PUHY-500YEM-L1-2,3,4,5,6,7,8,9,10,11,12

NOTE: Mark ○ indicates terminal lead
 ■ connector
 □ board insertion connector

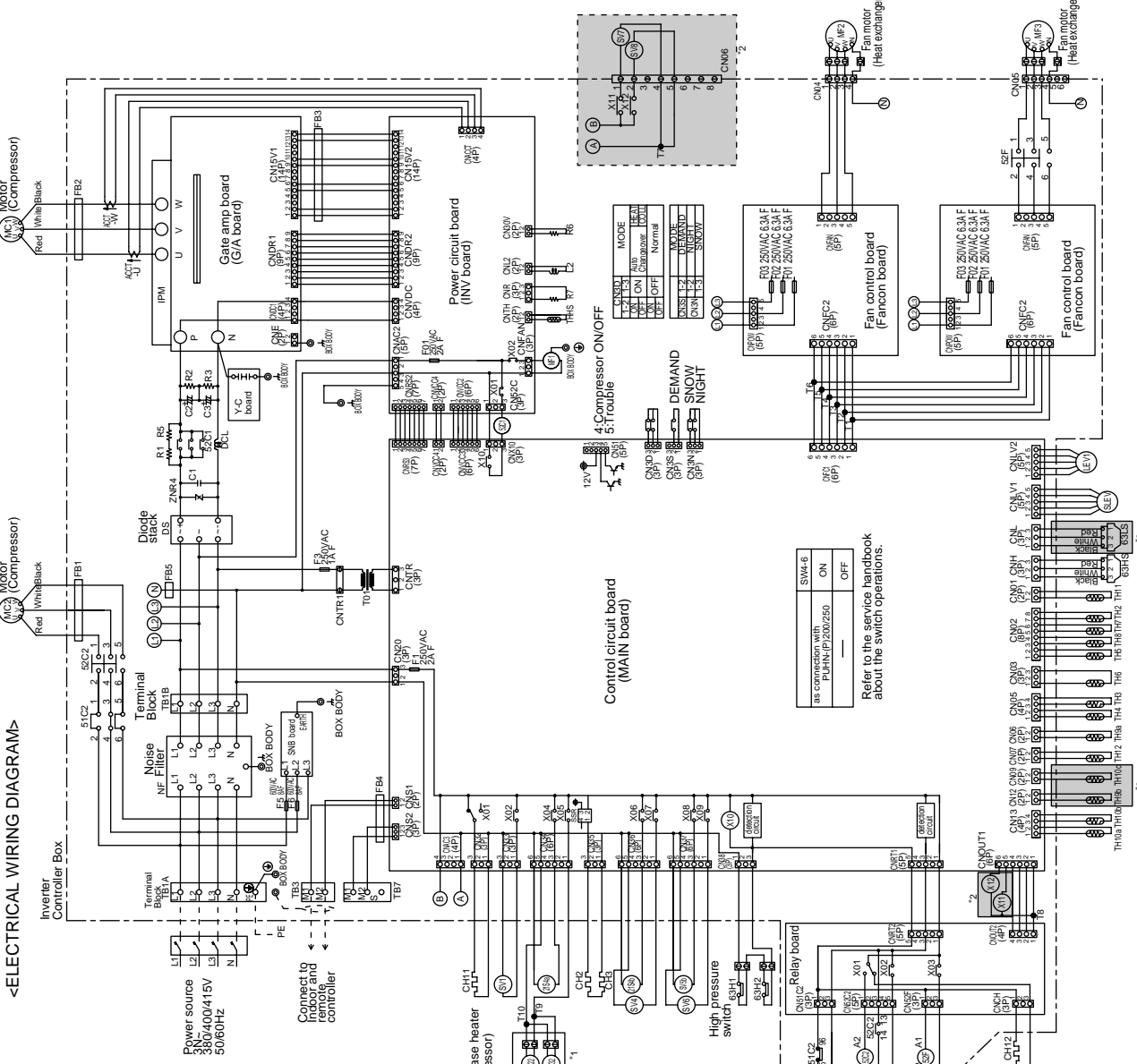
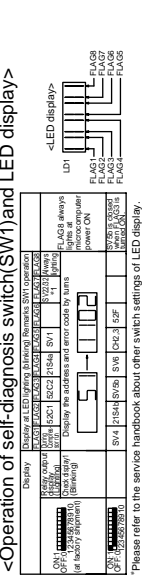
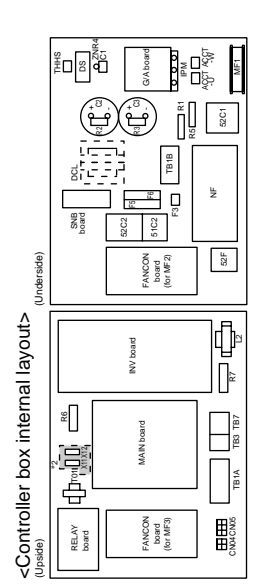
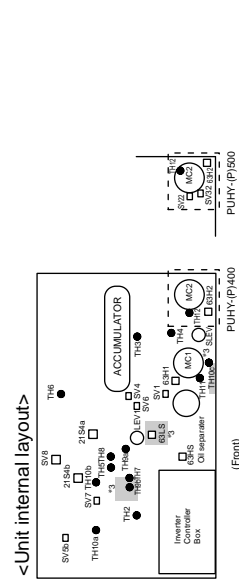

Big (R407C)

6. Refrigerant Circuit Diagram And Thermal Sensor

* There are SV22,SV32 only for PUHY-P500.

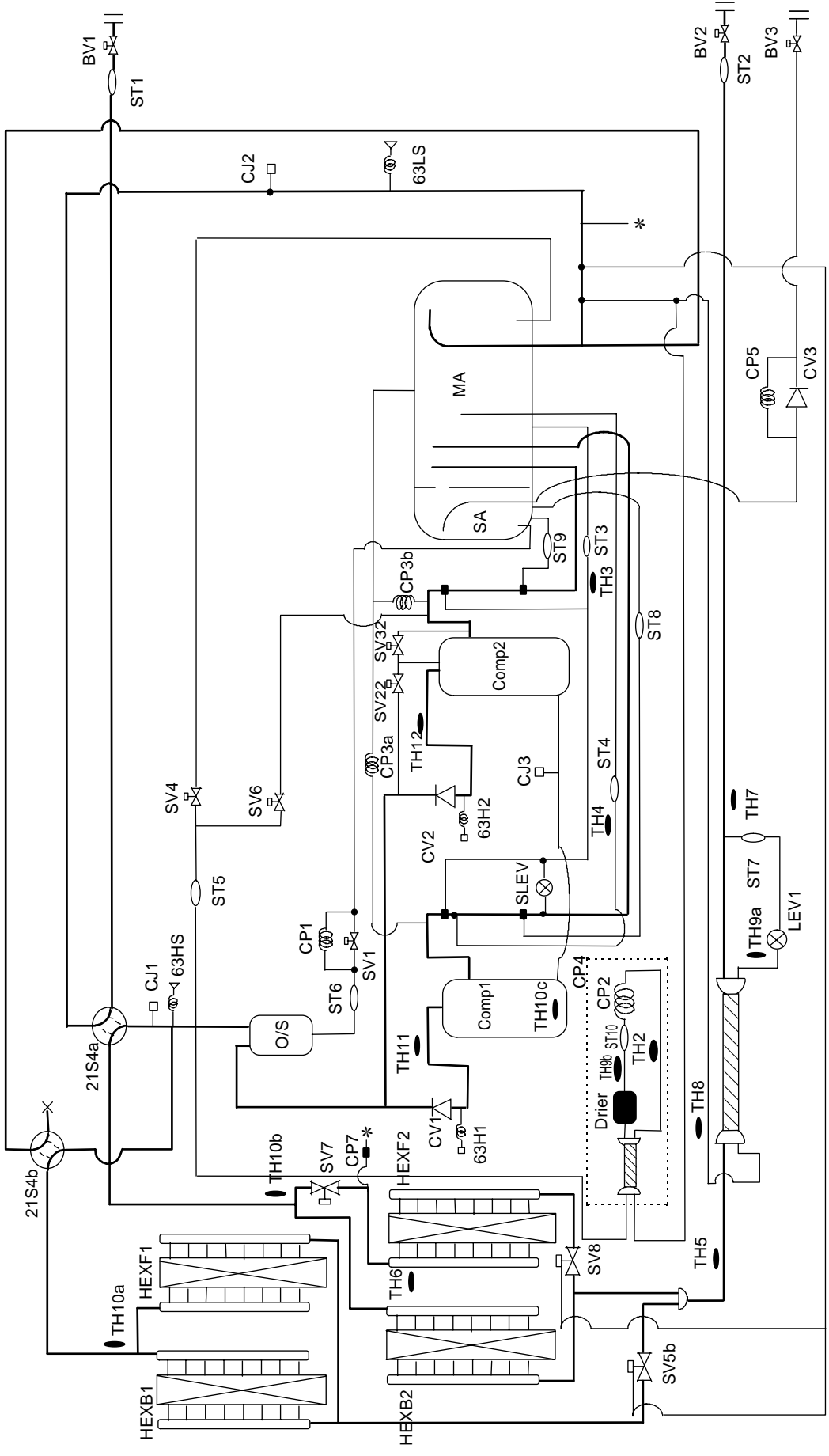

Big Y(R407C)

PUHY-P600-650-700-750YSEM-A (-BF, -BS)

CONTENTS

1. Specifications	I -56
2. Capacity Tables	I -60
2-1 Correction by temperature	I -60
2-2 Correction by total indoor	I -62
2-3 Correction by refrigerant piping length	I -64
2-4 Correction at frosting and defrosting	I -65
2-5 Operation limit	I -65
3. Sound Levels	I -66
4. External Dimensions	I -68
5. Electrical Wiring Diagram	I -71
6. Refrigerant Circuit Diagram	I -73
And Thermal Sensor	

1. Specifications

This unit consists of a combination of PUHY-P400YEM-A(-BF, -BS) and PUHN-P200YEM-A(-BF, -BS).

Model name		PUHY-P600YSEM-A(-BF, -BS)	
		Cooling	Heating
Capacity	*1 kW	67.4	75.0
	*2 kcal/h	60,000	—
Power source		3N ~ 380/400/415V 50/60Hz	
Power input	kW	23.89	21.08
Current	A	40.3/38.3/36.9	35.5/33.8/32.5
Refrigerant / Lubricant		R407C/MEL32	
External finish		Pre-coated galvanized sheets (Powder coating) <MUNSELL 5Y8/1 or similar>	
Indoor unit	Total capacity	50 ~ 130% of outdoor unit capacity	
	Model / Quantity	Model 20 ~ 250 / 2 ~ 32	
Noise level	* dB<A> (50/60Hz)	61.5 / 62	
Refrigerant piping diameter (main)	Liquid / Gas	φ 19.05 / φ 34.93	
Operating temperature range		Indoor:15°CWB ~ 24°CWB Outdoor:-5°CDB ~ 43°CDB (0°CDB~43°CDB with outdoor unit at lower position)	Indoor:15°CDB ~ 27°CDB Outdoor:-15°CWB ~ 15.5°CWB (-12°CWB~10°CWB with indoor unit 20 or 25 type only is working)

Model name		PUHY-P400YEM-A(-BF, -BS)	PUHN-P200YEM-A(-BF, -BS)
Fan	TypeX Quantity	Propeller fan X 2	Propeller fan X 1
	Airflow rate	m ³ /min	400
	Motor output	kW	0.38 X 2
Compressor	Type	Hermetic	
	Motor output	kW	7.5 + 4.5
	Crankcase heater	kW	0.045 + 0.045
External dimension	mm	1755(H)X 1990(W) X 840(L)	1755(H)X 990(W)X 840(L)
Protection devices	High pressure protection	2.94MPa	
	Compressor / Fan	Overcurrent protection / Thermal switch	
	Inverter	AC bus current protection, thermal switch	—
Refrigerant piping diameter	Liquid / Gas	φ 15.88 (Flare) / φ 34.93 (Flange)	φ 12.7 (Flare) / φ 28.58 (Flange)
Net weight	kg	440	248

Note: 1.Cooling/heating capacity indicates the maximum value at operation under the following condition.

*1 Cooling	Indoor : 27°CDB/19°CWB	Outdoor : 35°CDB	*2 Cooling	Indoor : 27°CDB/19.5°CWB	Outdoor : 35°CDB
Heating	Indoor : 20°CDB	Outdoor : 7°CDB/6°CWB		Pipe length : 10m	Height difference : 0m
	Pipe length : 12.5m	Height difference : 0m			

* It is measured in anechoic room.

This unit consists of a combination of PUHY-P400YEM-A(-BF, -BS) and PUHN-P250YEM-A(-BF, -BS).

Model name		PUHY-P650YSEM-A(-BF, -BS)	
		Cooling	Heating
Capacity	*1	kW	73.0
	*2	kcal/h	65,000
Power source		3N ~ 380/400/415V 50/60Hz	
Power input		kW	25.71
Current		A	43.4/41.2/39.7
Refrigerant / Lubricant		R407C/MEL32	
External finish		Pre-coated galvanized sheets (Powder coating) <MUNSELL 5Y8/1 or similar>	
Indoor unit	Total capacity		50 ~ 130% of outdoor unit capacity
	Model / Quantity		Model 20 ~ 250 / 2 ~ 32
Noise level	*	dB<A> (50/60Hz)	62.0 / 62.5
Refrigerant piping diameter (main)		Liquid / Gas	φ 19.05 / φ 41.28
Operating temperature range		Indoor:15°CWB ~ 24°CWB Outdoor:-5°CDB ~ 43°CDB (0°CDB~43°CDB with outdoor unit at lower position)	Indoor:15°CDB ~ 27°CDB Outdoor:-15°CWB ~ 15.5°CWB (-12°CWB~10°CWB with indoor unit 20 or 25 type only is working)
Model name		PUHY-P400YEM-A(-BF, -BS)	PUHN-P250YEM-A(-BF, -BS)
Fan	TypeX Quantity		Propeller fan X 2
	Airflow rate	m³/min	400
	Motor output	kW	0.38 X 2
Compressor	Type		Hermetic
	Motor output	kW	7.5 + 4.5
	Crankcase heater	kW	0.045 + 0.045
External dimension		mm	1755(H)X 1990(W) X 840(L)
Protection devices	High pressure protection		2.94MPa
	Compressor / Fan		Overcurrent protection / Thermal switch
	Inverter		AC bus current protection, thermal switch
Refrigerant piping diameter		Liquid / Gas	φ 15.88 (Flare) / φ 34.93 (Flange)
Net weight		kg	440

Note: 1. Cooling/heating capacity indicates the maximum value at operation under the following condition.

*1 Cooling Indoor : 27°CDB/19°CWB	Outdoor : 35°CDB	*2 Cooling Indoor : 27°CDB/19.5°CWB	Outdoor : 35°CDB
Heating Indoor : 20°CDB	Outdoor : 7°CDB/6°CWB	Pipe length : 10m	Height difference : 0m
Pipe length : 12.5m	Height difference : 0m		

* It is measured in anechoic room.

Super V(R407C)

This unit consists of a combination of PUHY-P500YEM-A(-BF, BS) and PUHN-P200YEM-A(-BF, BS).

Model name		PUHY-P700YSEM-A(-BF, -BS)	
		Cooling	Heating
Capacity	*1	kW	78.4
	*2	kcal/h	70,000
Power source		3N ~ 380/400/415V 50/60Hz	
Power input		kW	27.77
Current		A	46.8/44.5/42.9
Refrigerant / Lubricant		R407C/MEL32	
External finish		Pre-coated galvanized sheets (Powder coating) <MUNSELL 5Y8/1 or similar>	
Indoor unit	Total capacity		50 ~ 130% of outdoor unit capacity
	Model / Quantity		Model 20 ~ 250 / 2 ~ 32
Noise level	*	dB<A> (50/60Hz)	61.5 / 62.0
Refrigerant piping diameter (main)		Liquid / Gas	φ 19.05 / φ 41.28
Operating temperature range		Indoor:15°CWB ~ 24°CWB Outdoor:-5°CDB ~ 43°CDB (0°CDB~43°CDB with outdoor unit at lower position)	Indoor:15°CDB ~ 27°CDB Outdoor:-15°CWB ~ 15.5°CWB (-12°CWB~10°CWB with indoor unit 20 or 25 type only is working)

Model name		PUHY-P500YEM-A(-BF, -BS)		PUHN-P200YEM-A(-BF, -BS)		
Fan	TypeX Quantity		Propeller fan X 2		Propeller fan X 1	
	Airflow rate	m ³ /min	400		200	
	Motor output	kW	0.38 X 2		0.38 X 1	
Compressor	Type		Hermetic			
	Motor output	kW	7.5 + 7.5		5.5	
	Crankcase heater	kW	0.045 + 0.056		0.056	
External dimension		mm	1755(H)X 1990(W)X 840(L)		1755(H)X 990(W)X 840(L)	
Protection devices	High pressure protection		2.94MPa			
	Compressor / Fan		Overcurrent protection / Thermal switch			
	Inverter		AC bus current protection, thermal switch		—	
Refrigerant piping diameter		Liquid / Gas	φ 15.88 (Flare) / φ 34.93 (Flange)		φ 12.7 (Flare) / φ 28.58 (Flange)	
Net weight		kg	475		248	

Note: 1.Cooling/heating capacity indicates the maximum value at operation under the following condition.

*1 Cooling Indoor : 27°CDB/19°CWB	Outdoor : 35°CDB	*2 Cooling Indoor : 27°CDB/19.5°CWB	Outdoor : 35°CDB
Heating Indoor : 20°CDB	Outdoor : 7°CDB/6°CWB	Pipe length : 10m	Height difference : 0m
Pipe length : 12.5m	Height difference : 0m		

* It is measured in anechoic room.

This unit consists of a combination of PUHY-P500YEM-A(-BF, -BS) and PUHN-P250YEM-A(-BF, -BS).

Model name			PUHY-P750YSEM-A(-BF, -BS)	
			Cooling	Heating
Capacity	*1	kW	84.0	94.5
	*2	kcal/h	75,000	—
Power source			3N ~ 380/400/415V 50/60Hz	
Power input		kW	29.59	26.94
Current		A	49.9/47.4/45.7	45.4/43.2/41.6
Refrigerant / Lubricant			R407C/MEL32	
External finish			Pre-coated galvanized sheets (Powder coating) <MUNSELL 5Y8/1 or similar>	
Indoor unit	Total capacity		50 ~ 130% of outdoor unit capacity	
	Model / Quantity		Model 20 ~ 250 / 2 ~ 32	
Noise level		* dB<A> (50/60Hz)	62.0 / 62.5	
Refrigerant piping diameter (main)		Liquid / Gas	φ 19.05 / φ 41.28	
Operating temperature range			Indoor:15°CWB ~ 24°CWB Outdoor:-5°CDB ~ 43°CDB (0°CDB~43°CDB with outdoor unit at lower position)	Indoor:15°CDB ~ 27°CDB Outdoor:-15°CWB ~ 15.5°CWB (-12°CWB~10°CWB with indoor unit 20 or 25 type only is working)
			PUHY-P500YEM-A(-BF, -BS)	PUHN-P250YEM-A(-BF, -BS)
Fan	TypeX Quantity		Propeller fan X 2	Propeller fan X 1
	Airflow rate	m³/min	400	200
	Motor output	kW	0.38 X 2	0.38 X 1
Compressor	Type		Hermetic	
	Motor output	kW	7.5 + 7.5	7.5
	Crankcase heater	kW	0.045 + 0.056	0.056
External dimension		mm	1755(H)X 1990(W) X 840(L)	1755(H)X 990(W) X 840(L)
Protection devices	High pressure protection		2.94MPa	
	Compressor / Fan		Overcurrent protection / Thermal switch	
	Inverter		AC bus current protection, thermal switch	—
Refrigerant piping diameter		Liquid / Gas	φ 15.88 (Flare) / φ 34.93 (Flange)	φ 12.7 (Flare) / φ 28.58 (Flange)
Net weight		kg	475	263

Note: 1.Cooling/heating capacity indicates the maximum value at operation under the following condition.

*1 Cooling Indoor : 27°CDB/19°CWB	Outdoor : 35°CDB	*2 Cooling Indoor : 27°CDB/19.5°CWB	Outdoor : 35°CDB
Heating Indoor : 20°CDB	Outdoor : 7°CDB/6°CWB	Pipe length : 10m	Height difference : 0m
Pipe length : 12.5m	Height difference : 0m		

* It is measured in anechoic room.

Super V(R407C)

2. Capacity Tables

2-1. Correction by temperature

Cooling

•Standard Specifications

	PUHY-P600	PUHY-P650	PUHY-P700	PUHY-P750
Capacity kW	67.4	73.0	78.4	84.0
Input kW	23.89	25.71	27.77	29.59

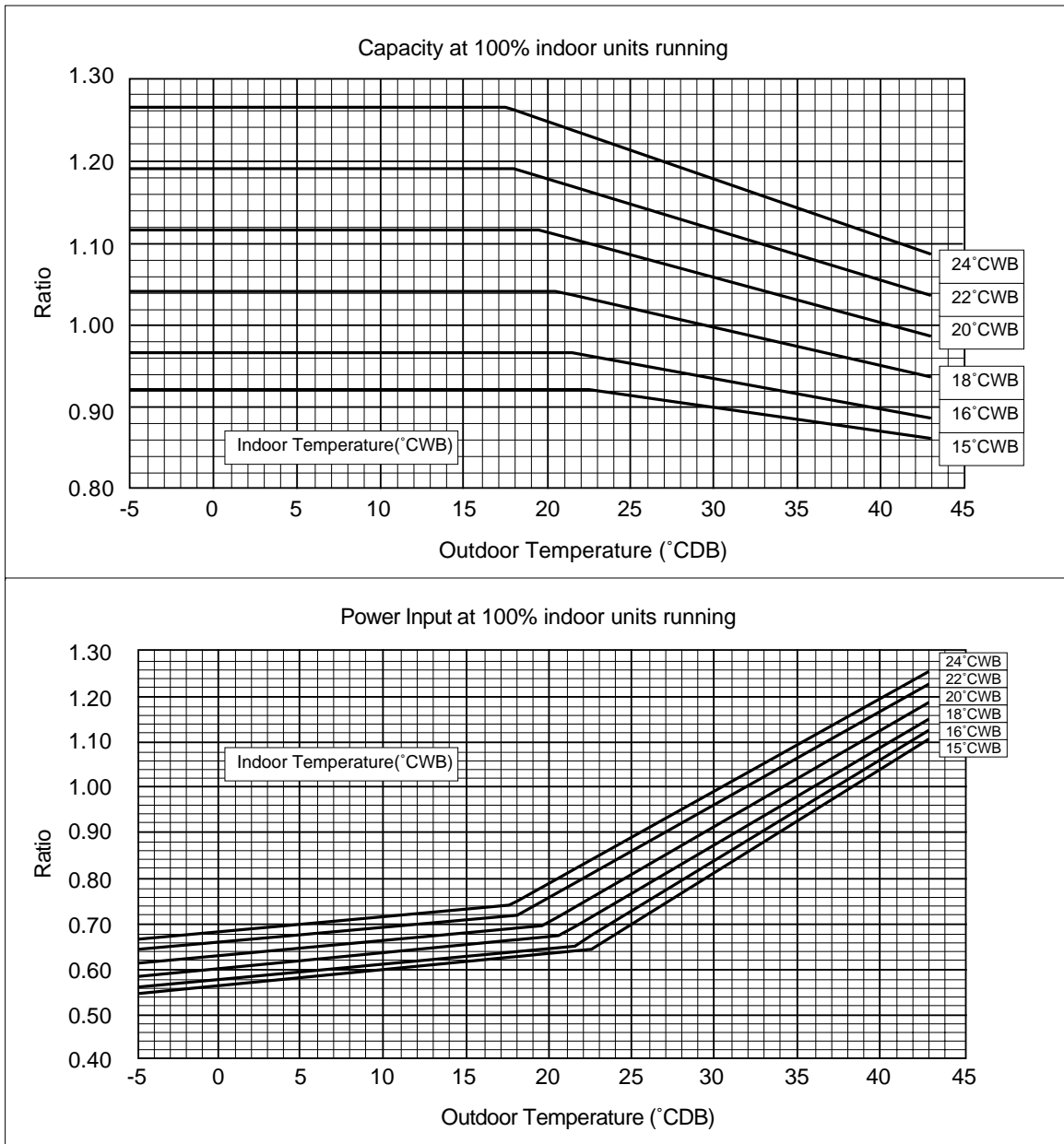

Super Y(R407C)

Heating

•Standard Specifications

	PUHY-P600	PUHY-P650	PUHY-P700	PUHY-P750
Capacity kW	75.0	81.5	88.0	94.5
Input kW	21.08	23.04	24.98	26.94

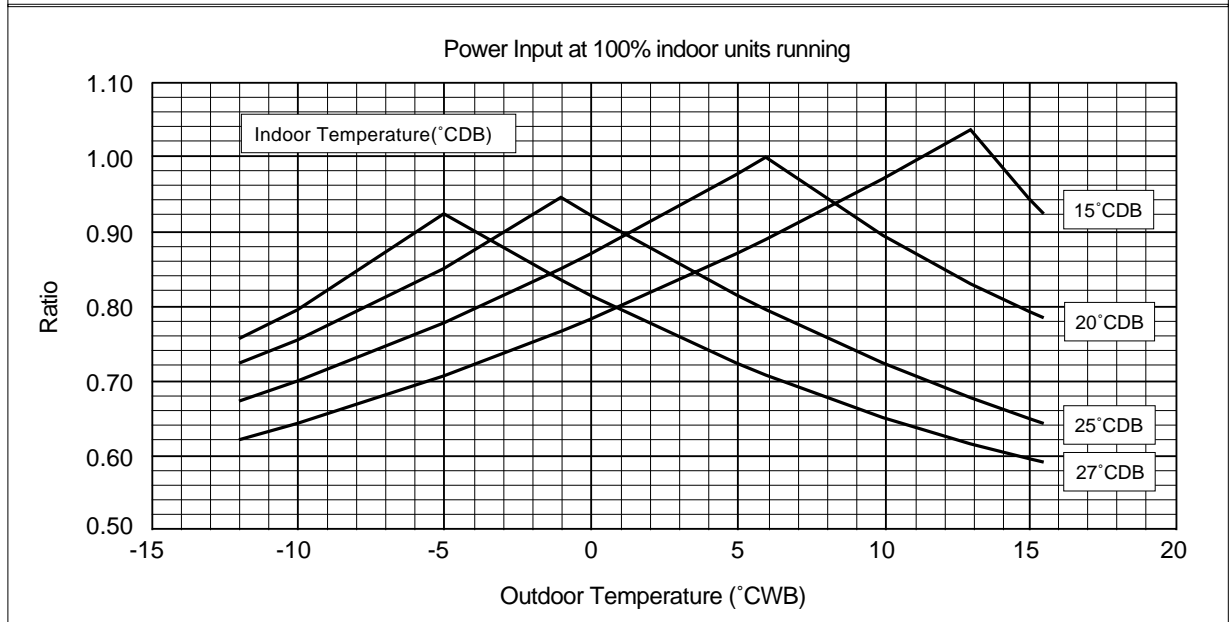
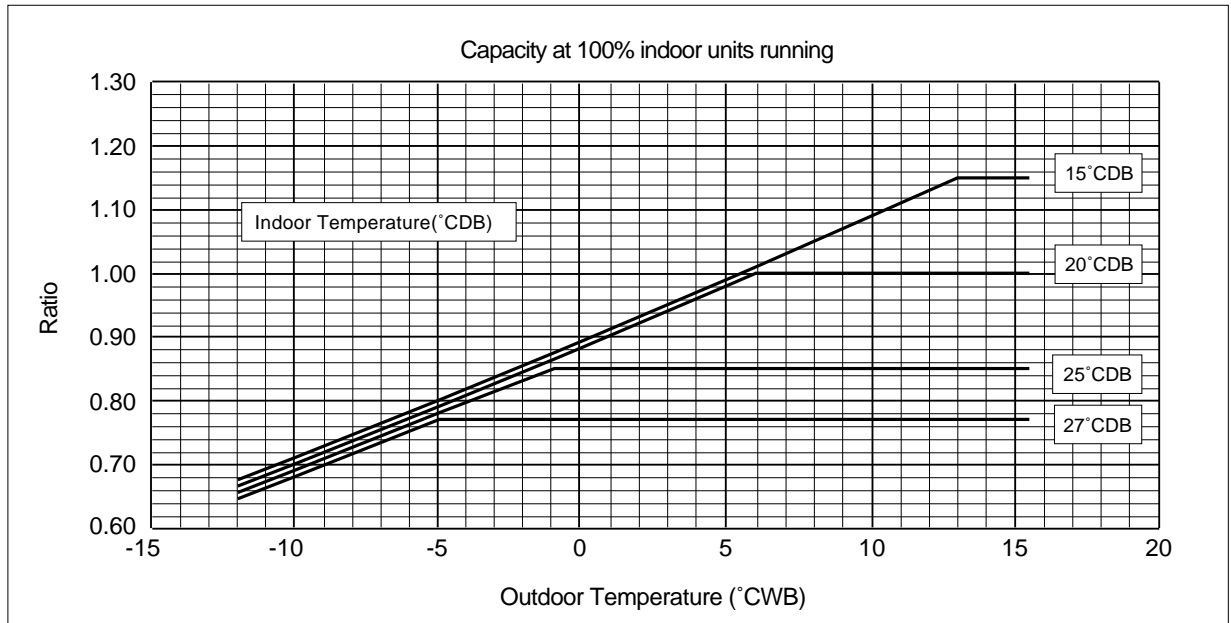

Super V(R407C)

2-2. Correction by total indoor

PUHY-P600

1) Capacity

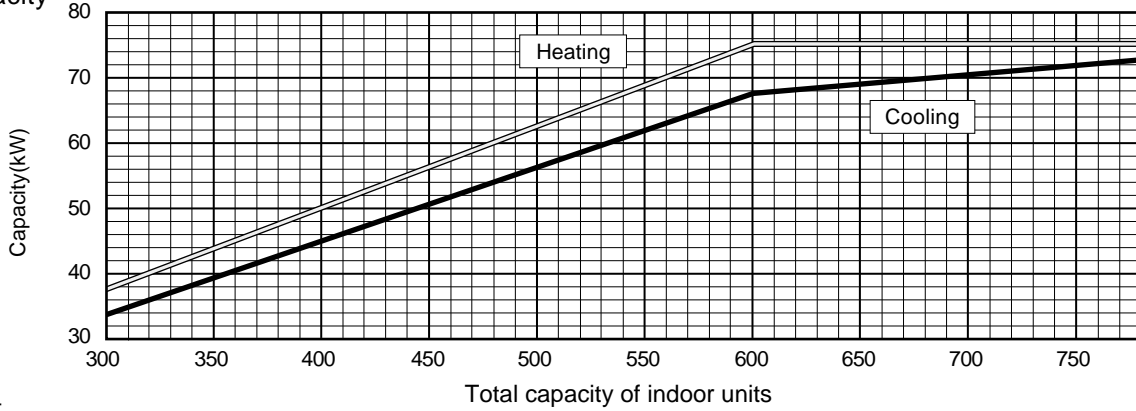

2) Input

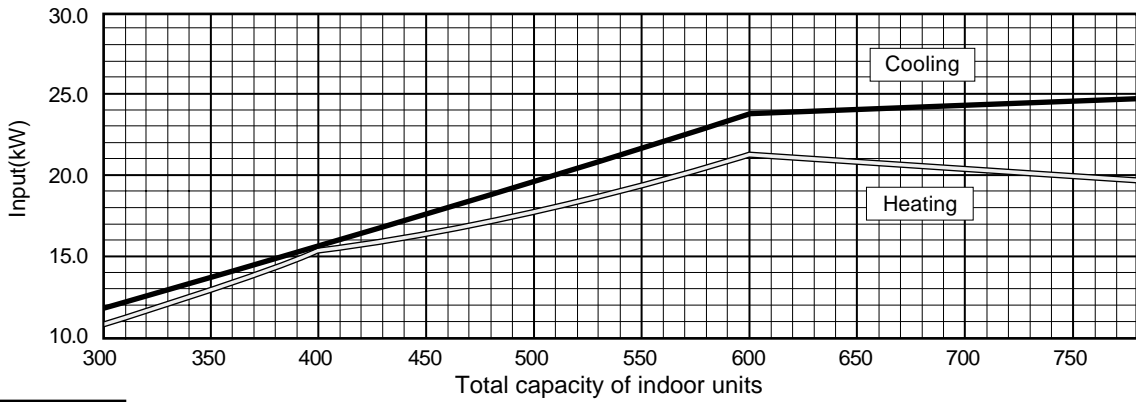

PUHY-P650

1) Capacity

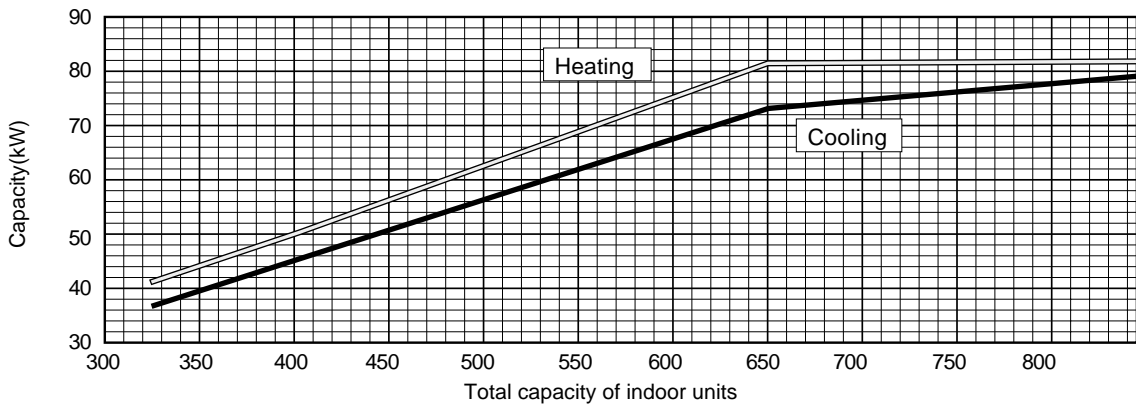

2) Input

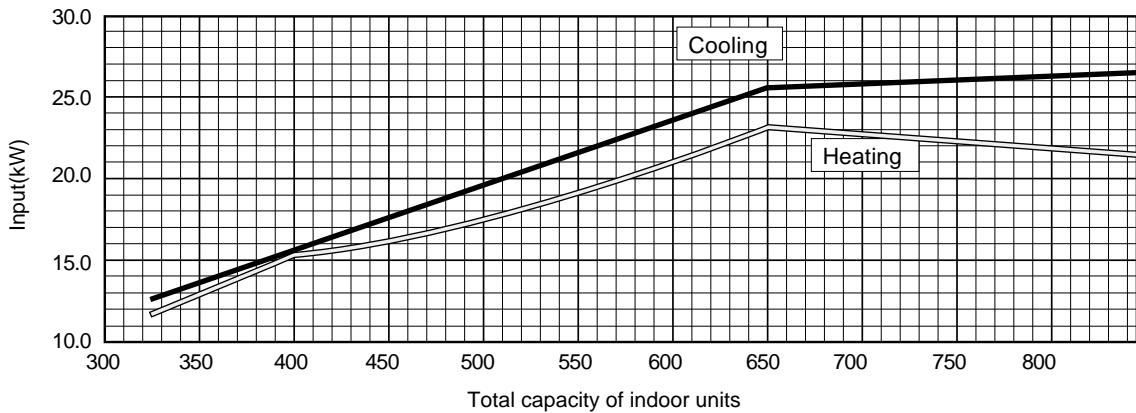

Super Y(R407C)

PUHY-P700

1) Capacity

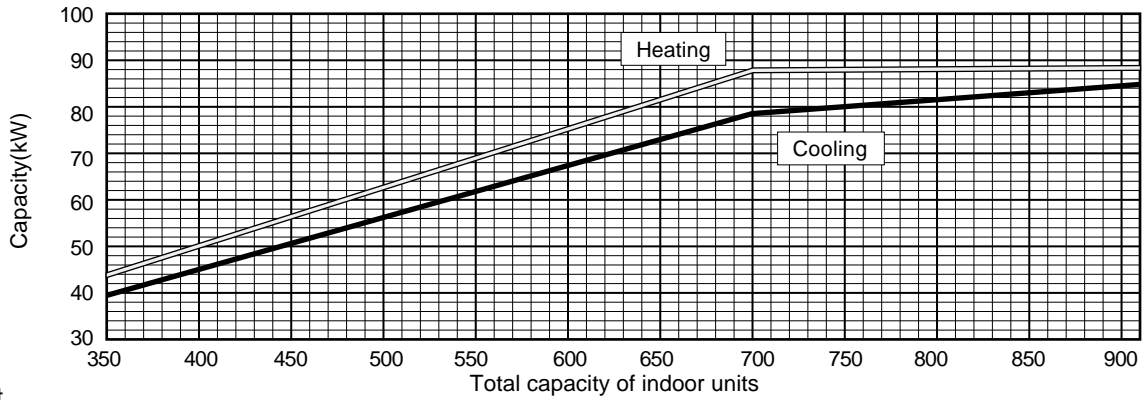

2) Input

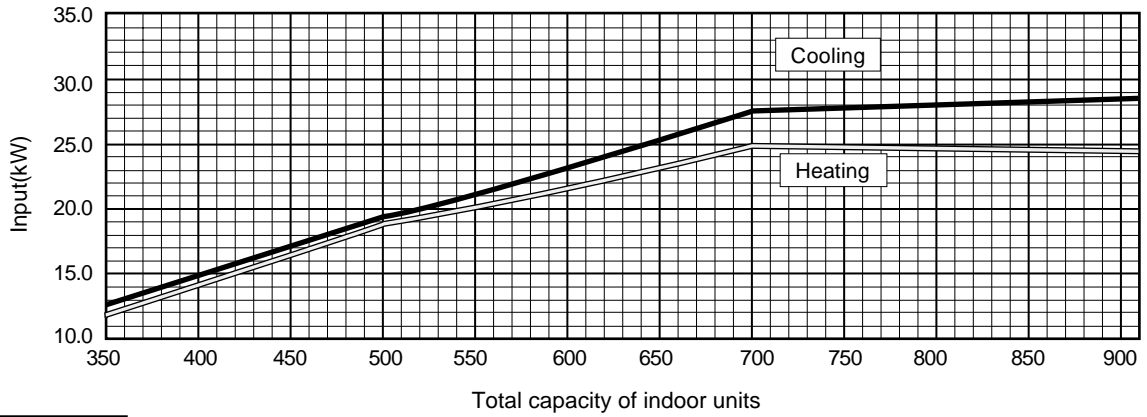

PUHY-P750

1) Capacity

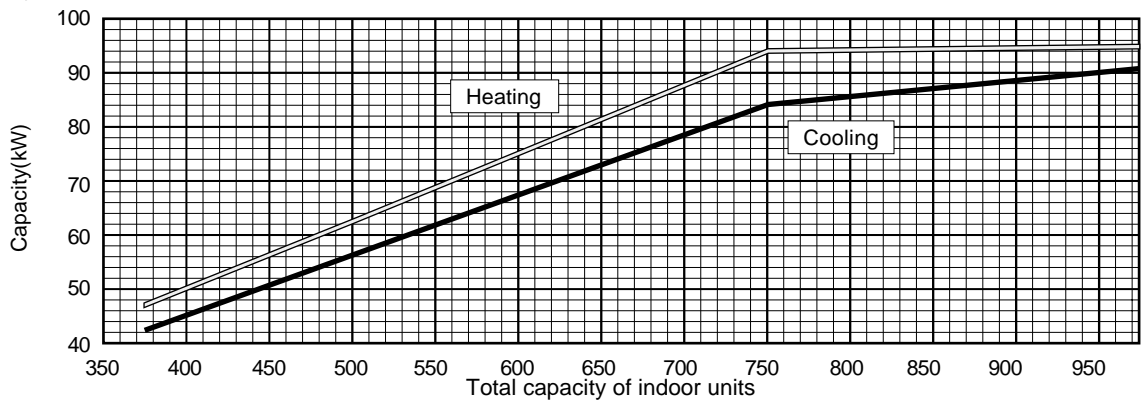

2) Input

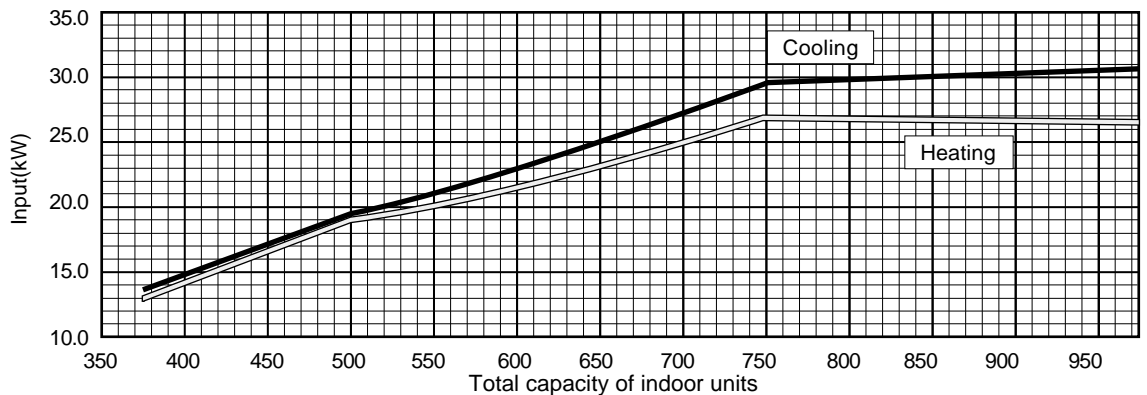

Super Y (R407C)

2-3. Correction by refrigerant piping length

To obtain a decrease in cooling/heating capacity due to refrigerant piping extension, multiply by the capacity correction factor based on the refrigerant piping equivalent length in the table below.

• Cooling capacity correction

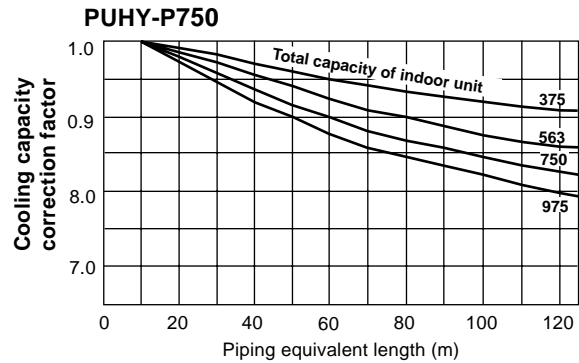
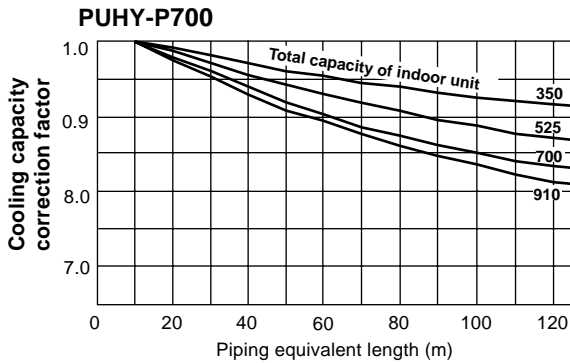
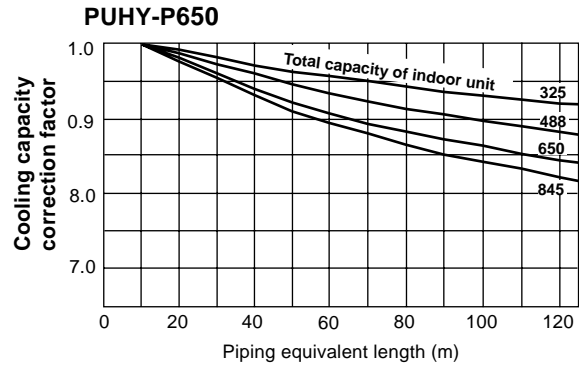
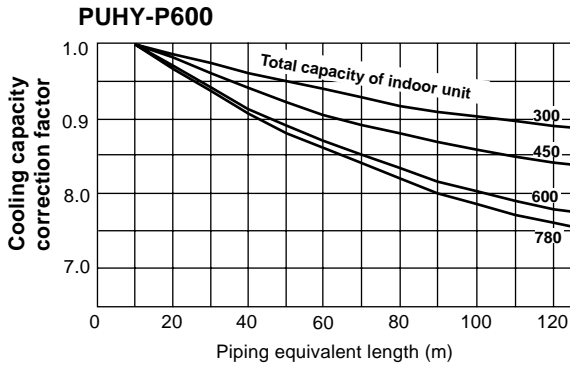

• Heating capacity correction

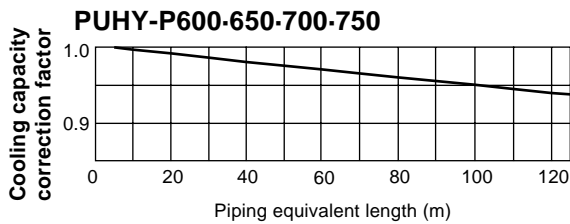

• How to obtain piping equivalent length

① PUHY-P600

Equivalent length = (Actual piping length to the farthest indoor unit) + (0.80 × number of bent on the piping)m

② PUHY-P650 - 750

Equivalent length = (Actual piping length to the farthest indoor unit) + (0.95 × number of bent on the piping)m

2-4. Correction at frosting and defrosting

When a decrease in heating capacity due to frosted and defrosting operations is considered, the value multiplied by the correction factor in the table below represents the heating capacity.

Outdoor inlet air temp (°CWB)	6	4	2	0	-2	-4	-6	-8	-10
Correction factor	1.0	0.98	0.89	0.89	0.90	0.92	0.95	0.95	0.95

2-5. Operation limit

• Cooling

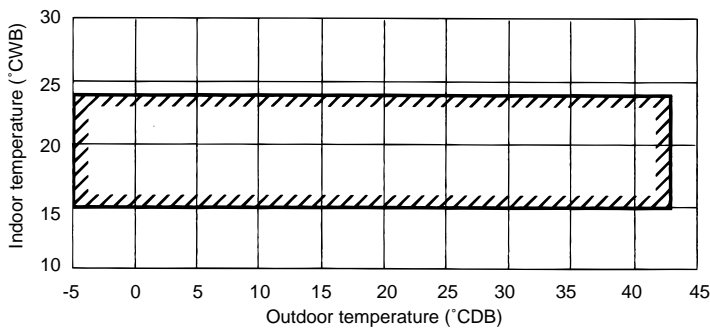

When the indoor unit is located above the outdoor unit for 4m or more, the outdoor unit inlet air temperature becomes 0~43°CDB.

• Heating

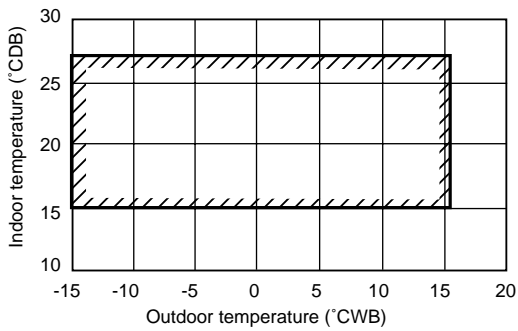

When the indoor unit 20 or 25type only is working, the outdoor unit inlet air temperature becomes -12~15°CWB.

3. Sound Levels

PUHY-P600

Measurement condition

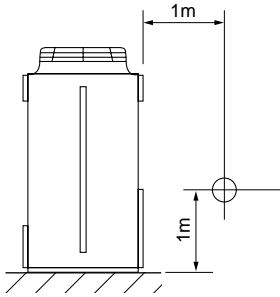

Sound pressure level in anechoic room
61.5 / 62.0 dB (A)

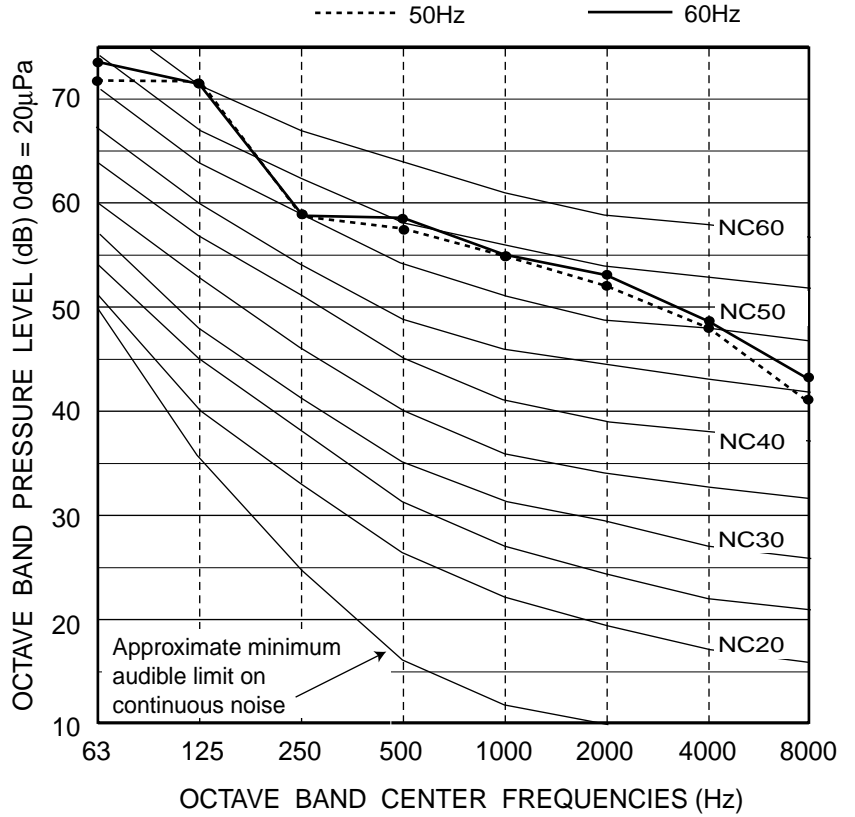

Super Y(R407C)

PUHY-P650

Measurement condition

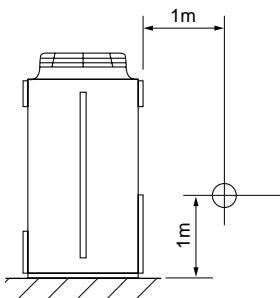

Sound pressure level in anechoic room
62.0 / 62.5 dB (A)

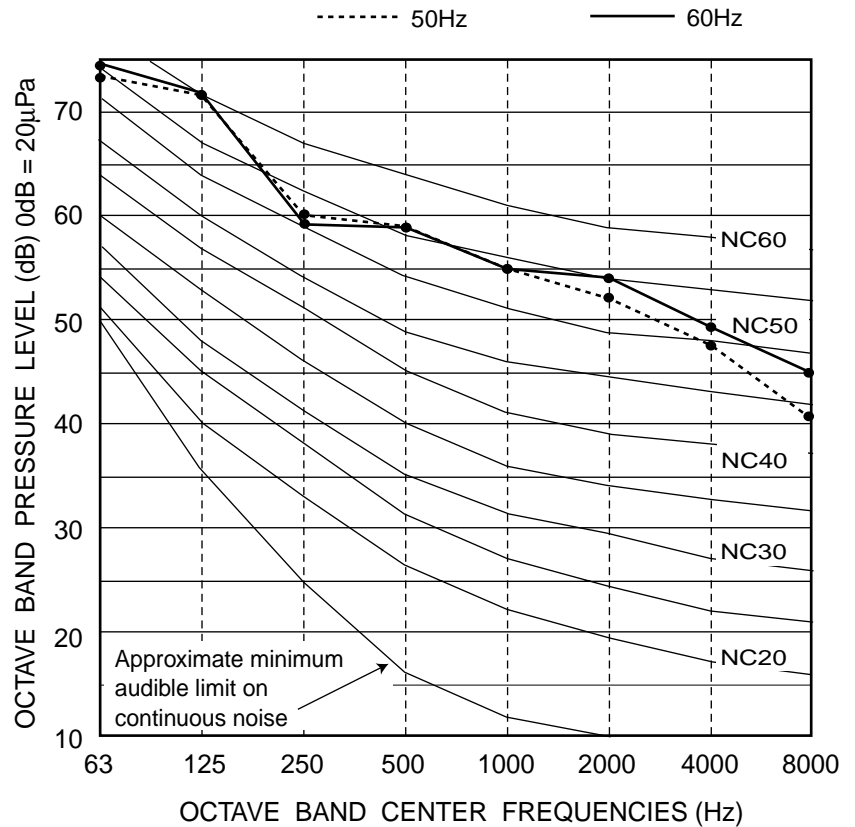

PUHY-P700

Measurement condition

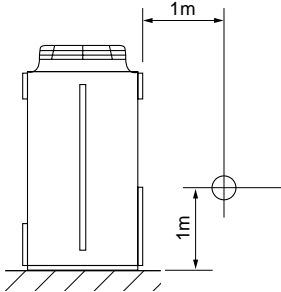

Sound pressure level in anechoic room
61.5 / 62.0 dB (A)

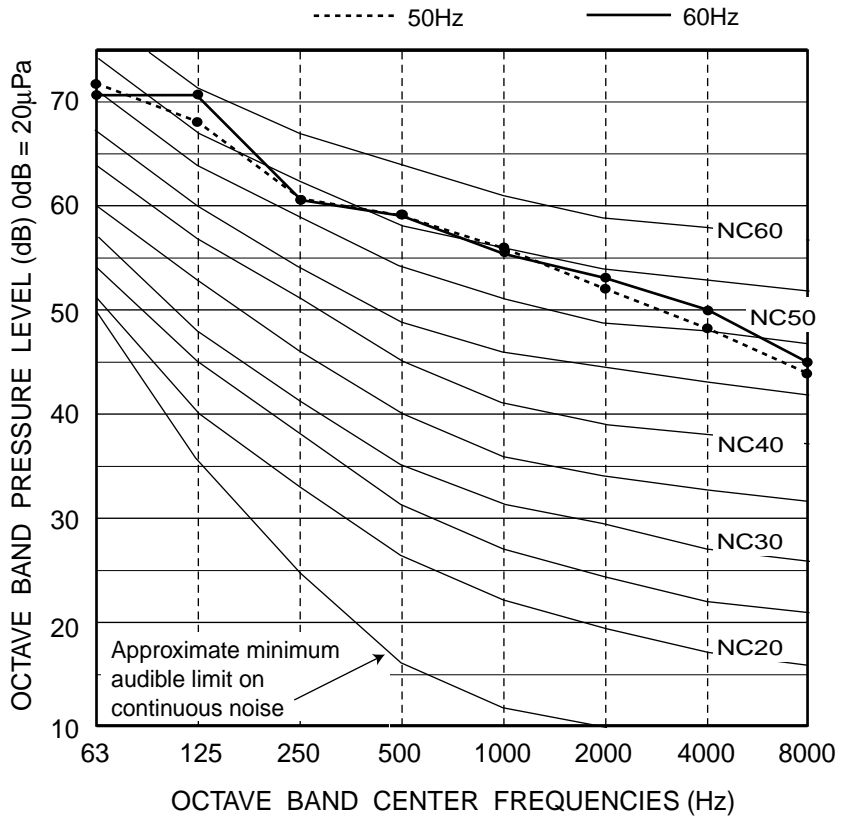

PUHY-P750

Measurement condition

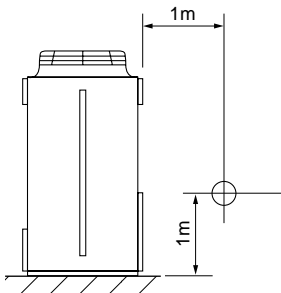

Sound pressure level in anechoic room
62.0 / 62.5 dB (A)

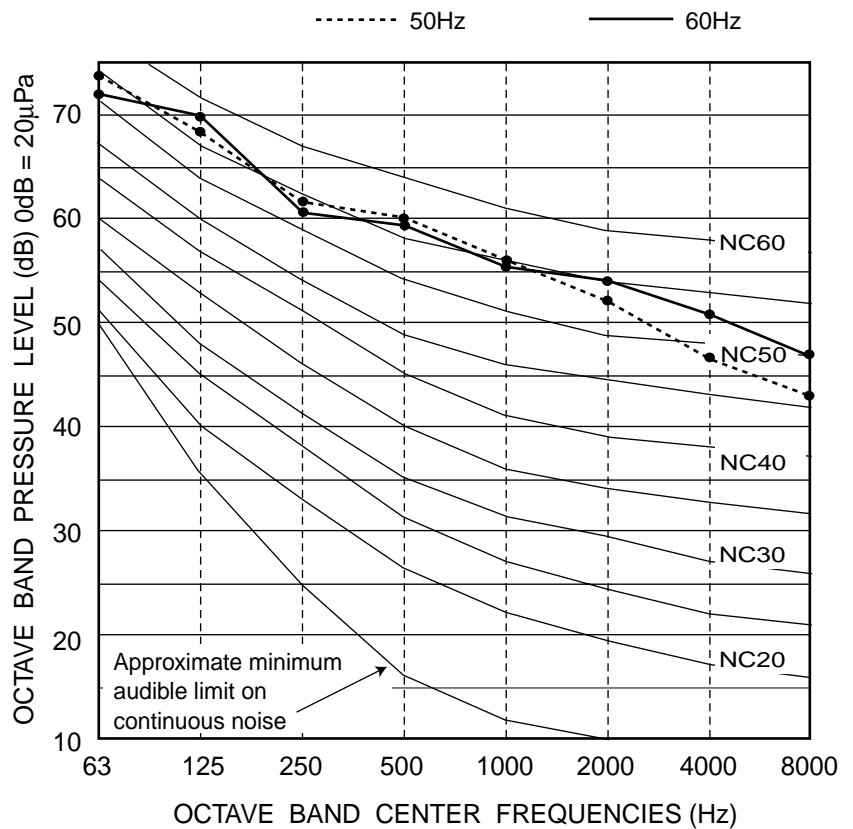

Super V(R407C)

4. External Dimensions

PUHY-P400, 500YEM-A(-BF, -BS)

Unit : mm

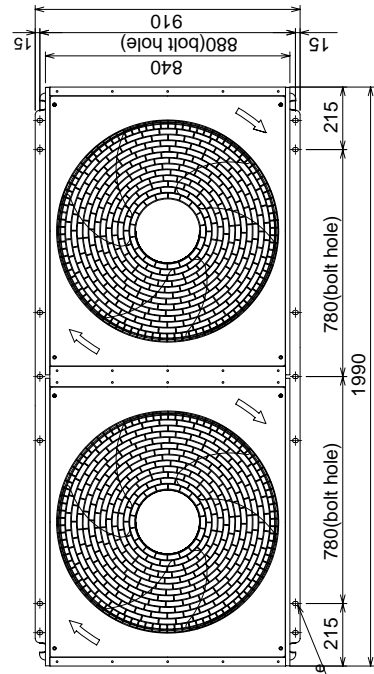

Plane view

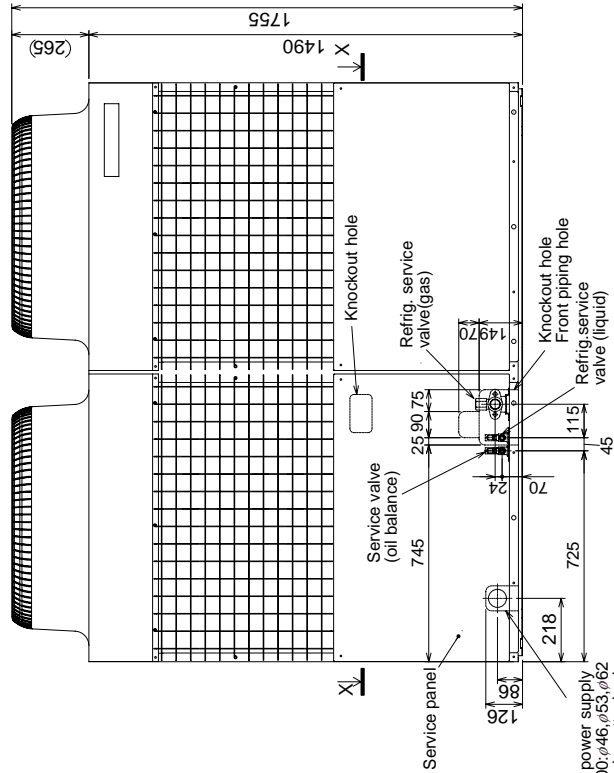

Front view

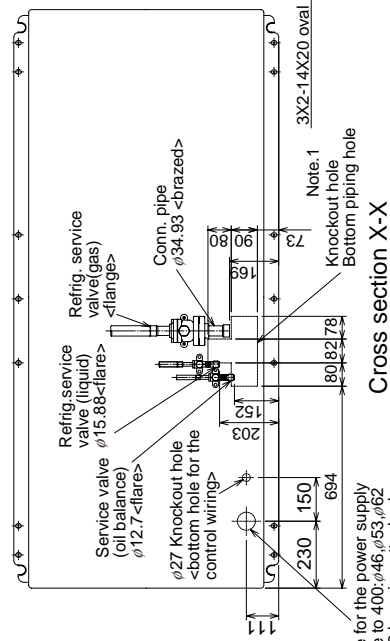

Cross section X-X

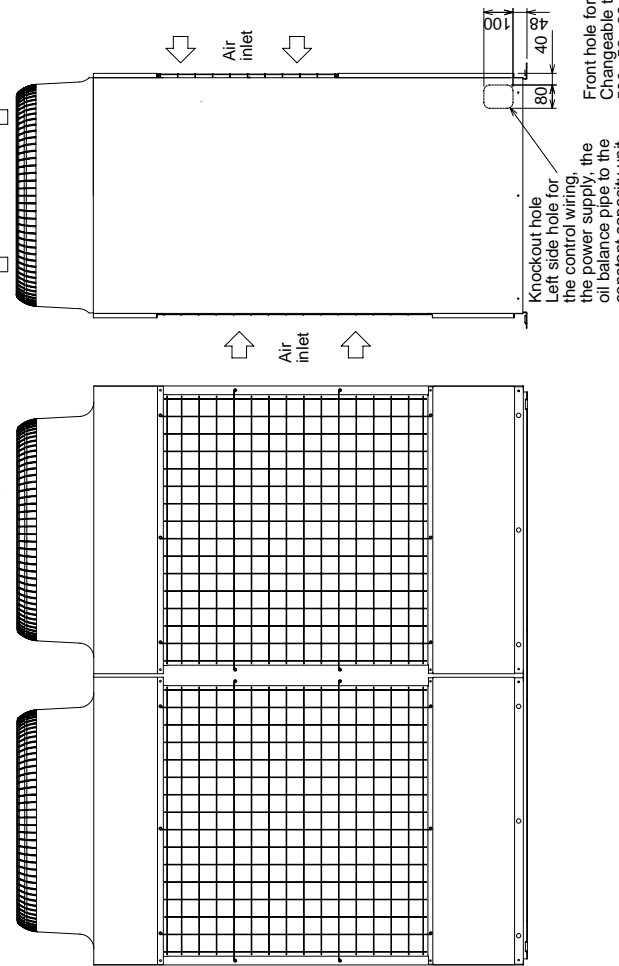

Left side view

- <Accessories>
- Refrigerant (gas) conn. pipe 1pc.
(The connecting pipe has been fixed with the unit)
 - Packing for conn. pipe 1pc.
(Attached near the ball valve)
 - Conduit mounting plate
(Painted the same color as the unit body)
φ62, φ53, φ46 Each 1pc.
 - Tapping screw 4X10 6pcs.
 - Wiring partition plate 1pc.
for the piping when you connect the piping from the bottom.
 - Knockout hole for the power supply
(Please be careful not to close the hole of the bottom plate by the basement)

Bottom hole for the power supply
Changeable to 400, φ46, φ53, φ62
500, φ53, φ62 by using attached
conduit mounting plate (accessory)

Front hole for the power supply
Changeable to 400, φ46, φ53, φ62
500, φ53, φ62 by using attached
conduit mounting plate (accessory)

Rear view

Super Y(R407C)

PUHY-P600,650,700,750YSEM-A(-BF, -BS)

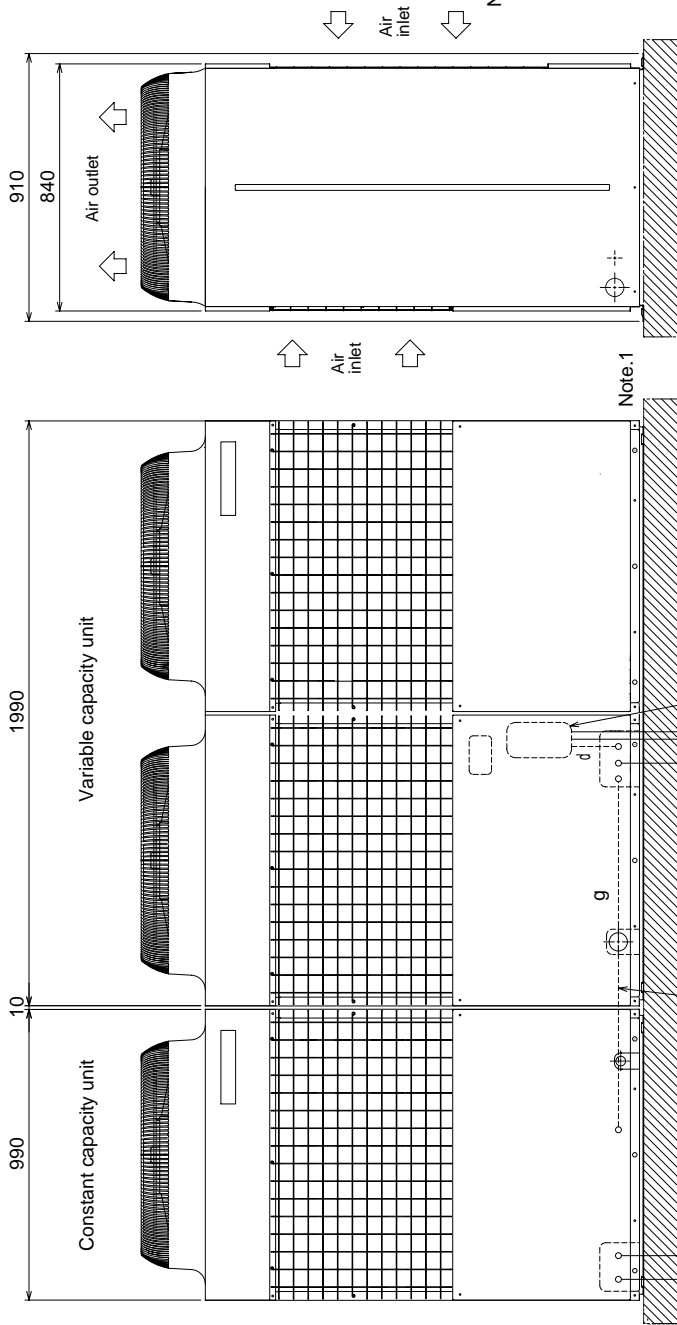

- Note 1. Please install the constant capacity unit and the variable capacity unit on a same level stand.
 2. Pipe size is as follows.
 3. Please install the constant capacity unit and the variable capacity unit side by side, the constant capacity unit on the left side and the variable capacity unit on the right side.
 4. Distributor kit(Accessory) is needed to compose PUHY-(P)600~750YSEM-A(-BF,-BS)

Unit : mm

	600	650	700	750
Indoor units ~ Distributor	liquid a	φ19.05		
	gas b	φ34.93	φ41.28	
Distributor ~ Variable capacity unit	liquid c	φ15.88		
Distributor ~ Constant capacity unit	gas d	φ34.93 ※1		
	liquid e	φ12.7		
Oil balance pipe	gas f	φ28.58		
	g	φ12.7 ※2		

- ※1 This pipe has been fixed.
- ※2 The oil balance pipe is usually fixed inside of the unit.
- ※3 Accessory

5. Electrical Wiring Diagram

PUHY-P400-500YEM-A(-BF, -BS)

<Symbol explanation>

Symbol	Name	Symbol	Name
DCL	DC reactor (Power factor improvement)	TH1.1,2	Thermistor
ACCT-U/W	Current Sensor	TH2	Thermistor
ZNR4	Varistor	TH3	Thermistor
52C1	Magnetic contactor (Inverter main circuit)	TH4	Thermistor
52C2	Magnetic contactor (Overload relay)	TH5	Thermistor
52F	Magnetic contactor (Fan motor)	TH6	Thermistor
MF1	Fan motor (Radiator panel)	TH7	Thermistor
SV1.22.32.4.6	Solenoid valve	TH8a	Thermistor
SV5.6.7.8	Solenoid valve (Heat exchange capacity control)	TH10a	Thermistor
SLEV	Electronic expansion valve (Oil return)	TH10c	Thermistor
LEV1	Electronic expansion valve (SC coil)	THHS	Thermistor
63HS	High pressure sensor	LD	Accumulator liquid level detect
63H1.2	High pressure switch	CH2.3	Crank case heater (Compressor)
IPM	Intelligent power module	SSR	Solid state relay
T1-10	Terminal	X1.2.4-12	Aux. relay
		FBI-5	Ferrite core
		⊕	Earth terminal

<Difference of appliance>

Appliance	Name
PUHY-400YEM	LT, TH, not installed
PUHY-400YEM	LT, TH, not installed
PUHY-500YEM	LT, TH, not installed
PUHY-500YEM	LT, TH, not installed

NOTE: Mark ⊕ indicates terminal bed connector
 ⊕ board insertion connector

<Unit internal layout>

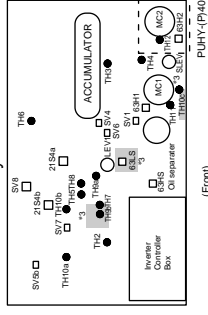

<Controller box internal layout>

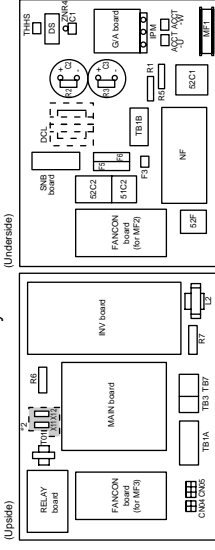

<Operation of self-diagnosis switch (SW1) and LED display>

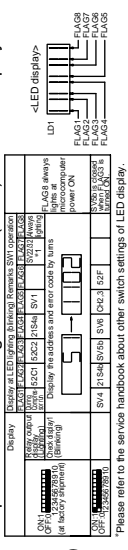

Please refer to the service handbook about other switch settings of LED display.

<ELECTRICAL WIRING DIAGRAM>

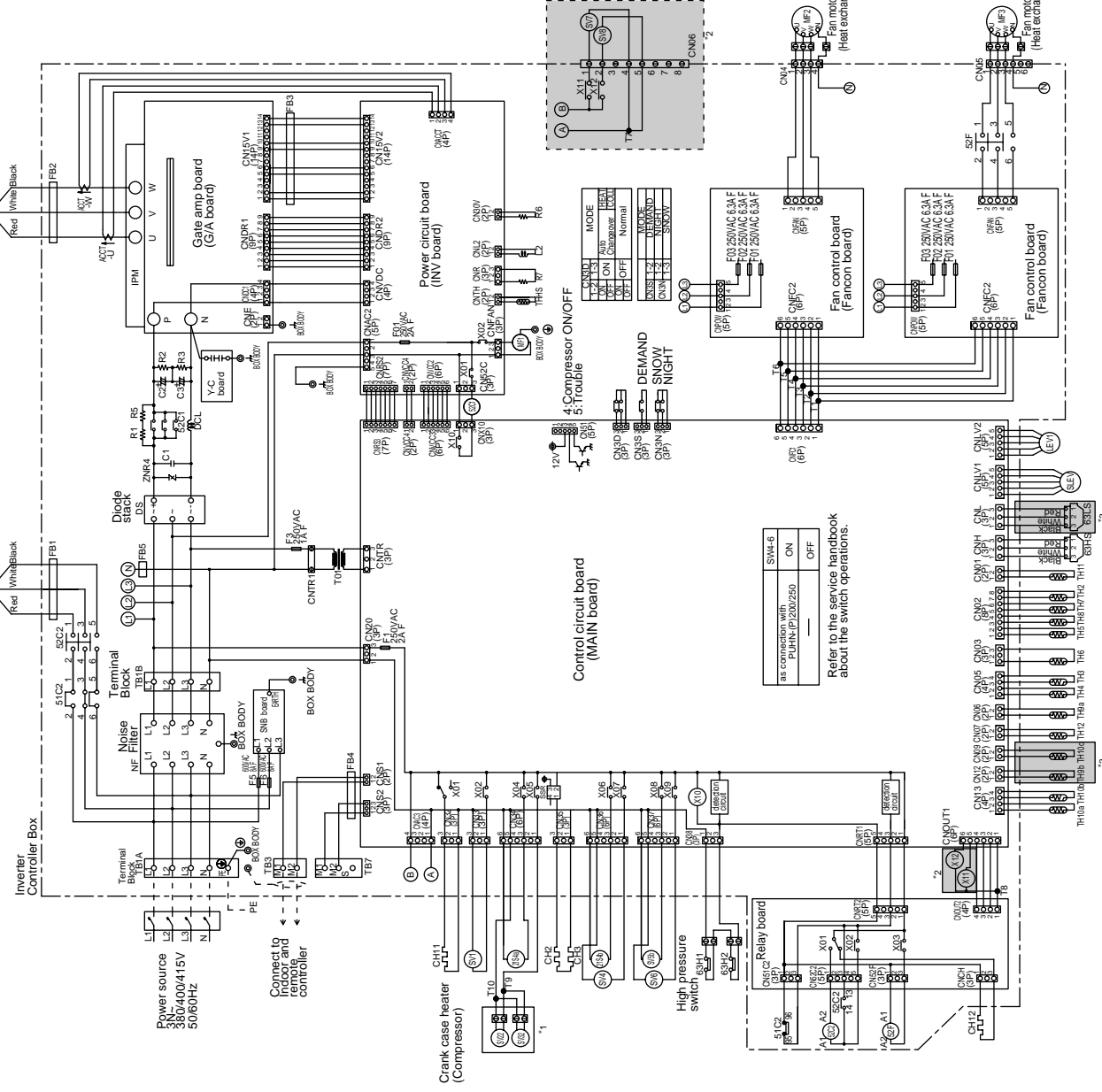

Super (R407C)

PUHN-P200-250YEM-A(-BF, -BS)

SYMBOL	NAME	SYMBOL	NAME
ZNR01	VARIATOR	TH3	THERMISTER
SSR	SOLID STATE RELAY	TH4	THERMISTER
F1	FUSE(6.3A) <CONT BOARD>	TH5	THERMISTER
F1,F2	FUSE(8A)	TH6	THERMISTER
F3	FUSE(1A)	TH7	THERMISTER
52C1	MAGNET CONTACTOR	TH8	THERMISTER
51C1	OVER CURRENT RELAY	TH9	THERMISTER
MC1	ELECTRIC MOTOR OF COMPRESSOR	TH10a	THERMISTER
MF	FAN MOTOR(HEAT EXCHANGER)	TH10b	THERMISTER
CH11	CRANK CASE HEATER(COMPRESSOR)	LEV1	ELECTRONIC EXPANSION VALVE
CH2,CH3	CORD HEATER	LEV2	ELECTRONIC EXPANSION VALVE
Z/S4	4-WAY VALVE	X01-X07	RELAY
SV1,SV4	SOLENOID VALVE	SW2,SW3	SWITCH
SV5b	SOLENOID VALVE	SWU1,2	SWITCH
SV2,SV3	SOLENOID VALVE	TB1	POWER SOURCE TERMINAL BLOCK
63H	HIGH PRESSURE CUT OUT SWITCH	⊕	EARTH TERMINAL
63LS	LOW SIDE PRESSURE SENSOR	T1,T2	TERMINAL
TH11	THERMISTER		

<Difference of appliance>

Appliance	Difference
PUHN-P200-250YEM-A(-BS,-BF)	ALL exists

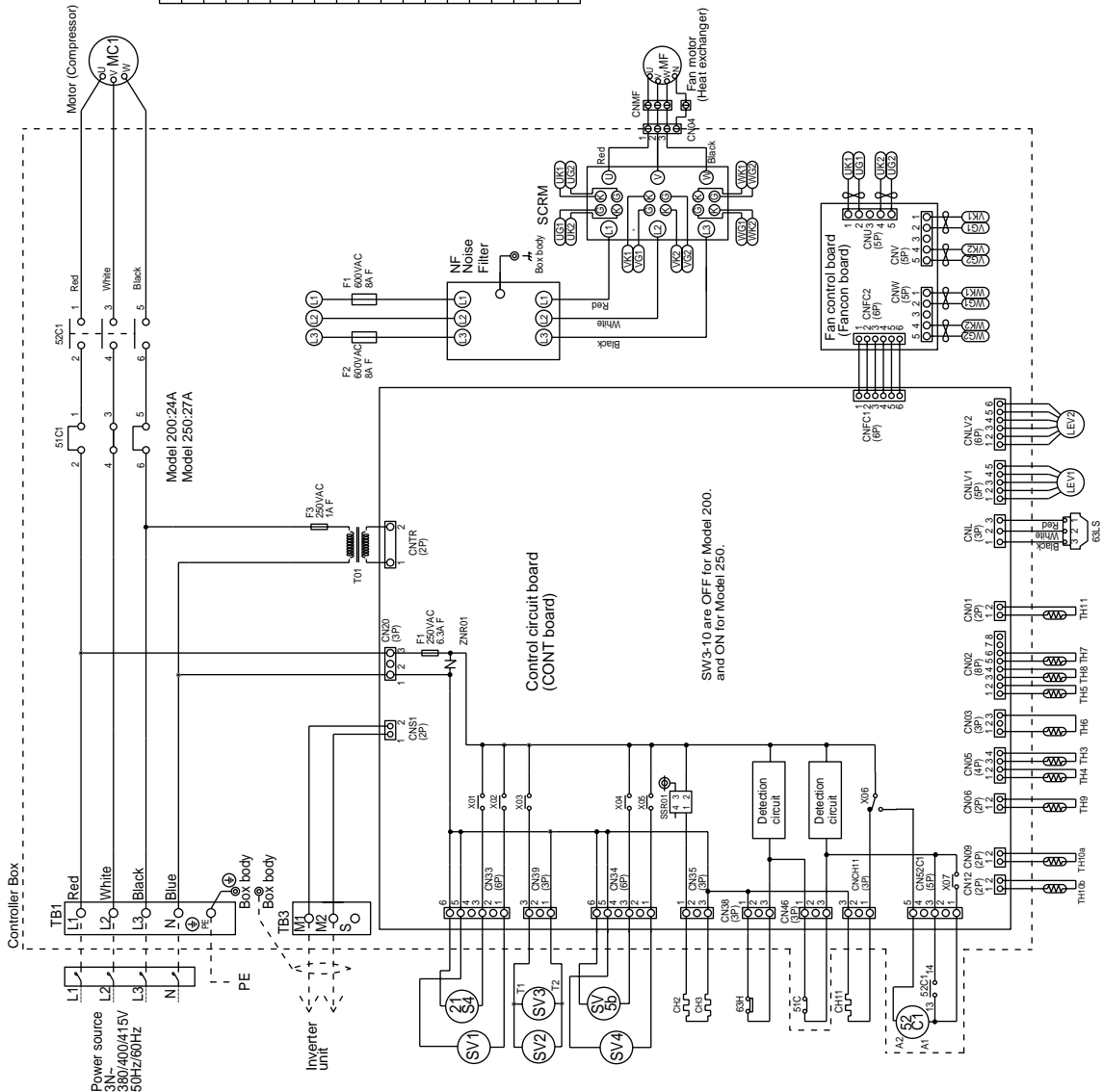

PURY-P200-250YEM-A(-BF, -BS)

CONTENTS

1. Specifications	I -76
2. Capacity Tables	I -78
2-1 Correction by temperature	I -78
2-2 Correction by total indoor	I -80
2-3 Correction by refrigerant piping length	I -81
2-4 Correction at frosting and defrosting	I -82
2-5 Operation limit	I -82
3. Sound Levels	I -83
4. External Dimensions	I -84
5. Electrical Wiring Diagram	I -85
6. Refrigerant Circuit Diagram	I -86
And Thermal Sensor	

R2(R407G)

1. Specifications

Model name		PURY-P200YEM-A(-BF, -BS)	
		Cooling	Heating
Capacity	*1	kW	22.4
	*2	kcal/h	20,000
Power source		3N~380/400/415V 50/60Hz	
Power input		kW	6.32
Current		A	10.6/10.1/9.7
Fan	TypeX Quantity		Propeller fanX1
	Airflow rate	m ³ /min	200
	Motor output	kW	0.38
Compressor	Type		Hermetic
	Motor output	kW	5.3
	Crankcase heater	kW	0.045(240V)
Refrigerant / Lubricant		R407C/MEL32	
External finish		Pre-coated galvanized sheets (Powder coating) <MUNSELL 5Y8/1 or similar>	
External dimension		mm	1755(H)X990(W)X840(L)
Protection devices	High pressure protection		2.94MPa
	Compressor / Fan		Over current protection / Thermal switch
	Inverter		AC bus current protection, thermal switch
Refrigerant piping diameter		High press. / Low press.	φ 19.05 (Flare) / φ 25.4 (Flange)
Indoor unit	Total capacity		50~150% of outdoor unit capacity
	Model / Quantity		Model 20~250 / 1~15
Noise level	*	dB<A>	56
Net weight		kg	238
Operating temperature range		Indoor:15°CWB ~ 24°CWB Outdoor:-5°CDB ~ 43°CDB	Indoor:15°CDB ~ 27°CDB Outdoor:-15°CWB ~ 15.5°CWB
		-5°CDB/-6°CWB ~ 21°CDB/15.5°CWB with cooling/heating mixed operation.	
Matters Deserving Special Mention		A pipe of φ 28.58 can be used for the low pressure pipe	

Note: 1.Cooling/heating capacity indicates the maximum value at operation under the following condition.

*1 Cooling Indoor : 27°CDB/19°CWB	Outdoor : 35°CDB	*2 Cooling Indoor : 27°CDB/19.5°CWB	Outdoor : 35°CDB
Heating Indoor : 20°CDB	Outdoor : 7°CDB/6°CWB	Pipe length : 5m	Height difference : 0m
Pipe length : 7.5m	Height difference : 0m		

* It is measured in anechoic room.

Model name			PURY-P250YEM-A(-BF, -BS)	
			Cooling	Heating
Capacity	*1	kW	28.0	31.5
	*2	kcal/h	25,000	-
Power source			3N ~ 380/400/415V 50/60Hz	
Power input		kW	8.54	8.95
Current		A	14.4/13.6/13.2	15.1/14.3/13.8
Fan	TypeX Quantity		Propeller fanX 1	
	Airflow rate	m ³ /min	200	
	Motor output	kW	0.38	
Compressor	Type		Hermetic	
	Motor output	kW	6.8	
	Crankcase heater	kW	0.045(240V)	
Refrigerant / Lubricant			R407C/MEL32	
External finish			Pre-coated galvanized sheets (Powder coating) <MUNSELL 5Y8/1 or similar>	
External dimension		mm	1755(H)X 990(W)X 840(L)	
Protection devices	High pressure protection		2.94MPa	
	Compressor / Fan		Over current protection / Thermal switch	
	Inverter		AC bus current protection, thermal switch	
Refrigerant piping diameter		High press. / Low press.	φ 19.05 (Flare) / φ 28.58 (Flange)	
Indoor unit	Total capacity		50 ~ 150% of outdoor unit capacity	
	Model / Quantity		Model 20 ~ 250 / 1 ~ 16	
Noise level		* dB<A>	57	
Net weight		kg	238	
Operating temperature range			Indoor:15°CWB ~ 24°CWB Outdoor:-5°CDB ~ 43°CDB	Indoor:15°CDB ~ 27°CDB Outdoor:-15°CWB ~ 15.5°CWB
			-5°CDB/-6°CWB ~ 21°CDB/15.5°CWB with cooling/heating mixed operation.	

Note: 1.Cooling/heating capacity indicates the maximum value at operation under the following condition.

*1 Cooling Indoor : 27°CDB/19°CWB	Outdoor : 35°CDB	*2 Cooling Indoor : 27°CDB/19.5°CWB	Outdoor : 35°CDB
Heating Indoor : 20°CDB	Outdoor : 7°CDB/6°CWB	Pipe length : 5m	Height difference : 0m
Pipe length : 7.5m	Height difference : 0m		

* It is measured in anechoic room.

R2(R407C)

2. Capacity Tables

2-1. Correction by temperature

Cooling

- Standard Specifications

		PURY-P200	PURY-P250
Capacity	kW	22.4	28.0
Input	kW	6.32	8.54

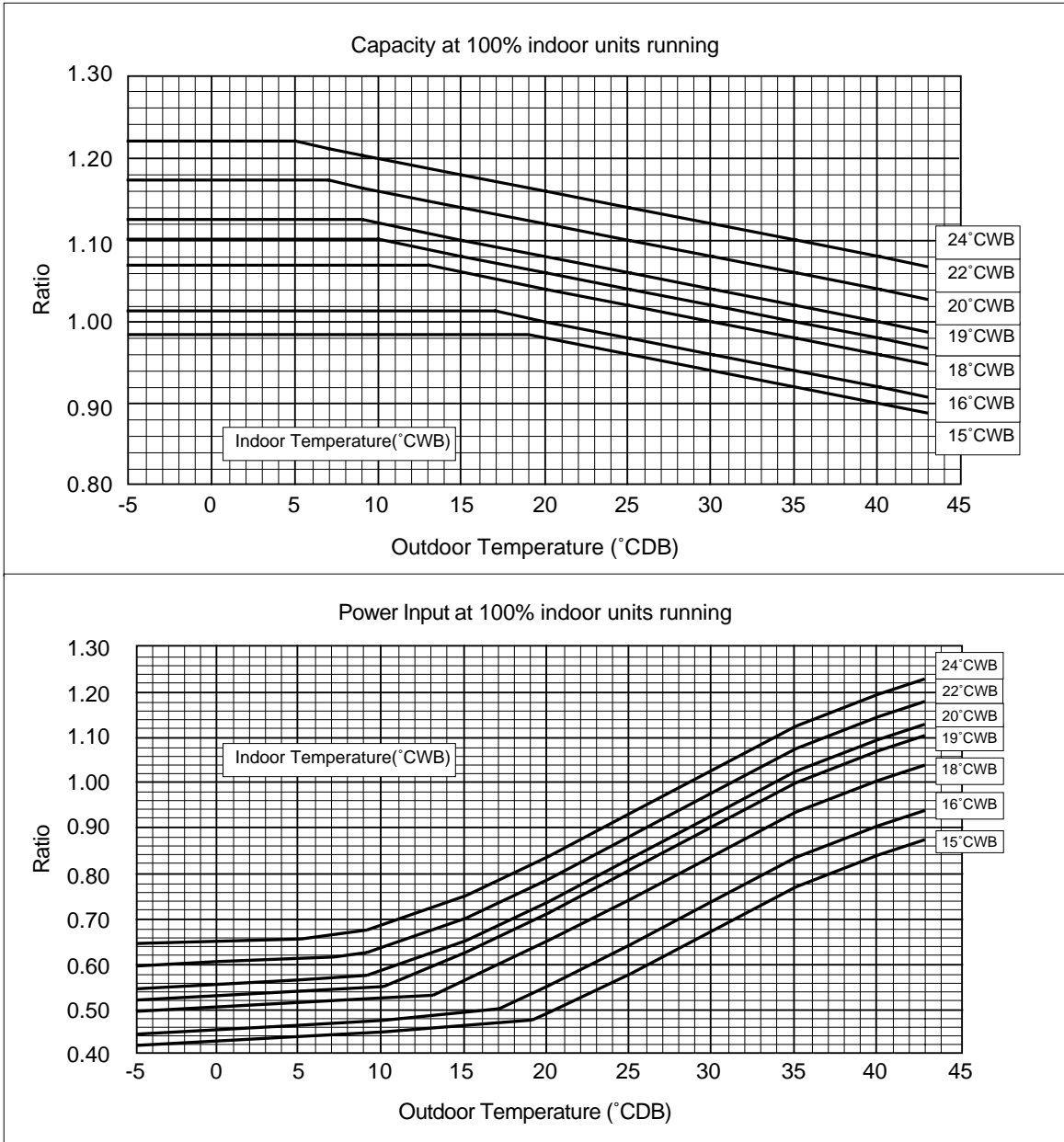

R2(R407C)

Heating

- Standard Specifications

		PURY-P200	PURY-P250
Capacity	kW	25.0	31.5
Input	kW	6.80	8.95

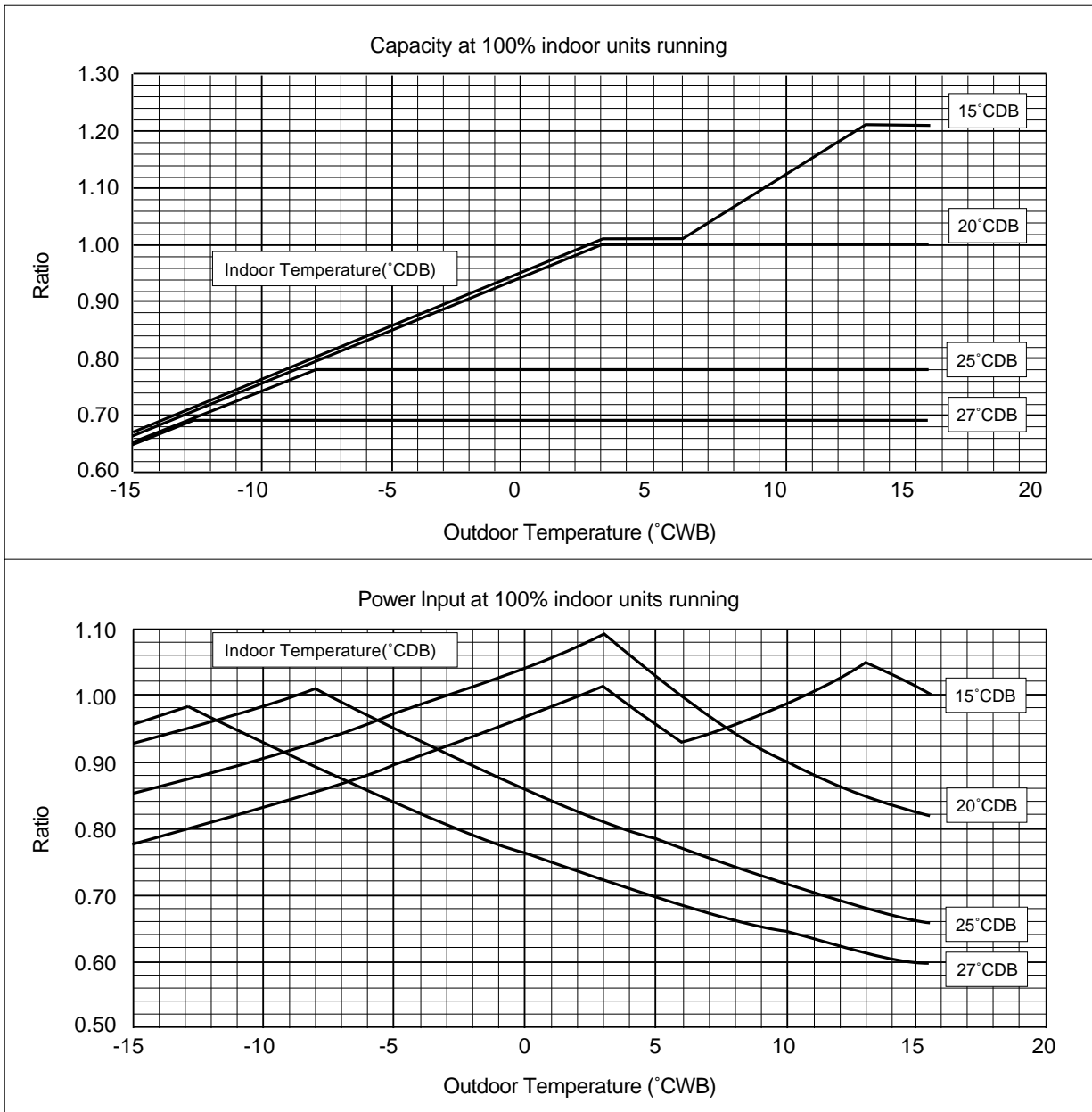

R2(R407G)

2-2. Correction by total indoor

PURY-P200

1) Capacity

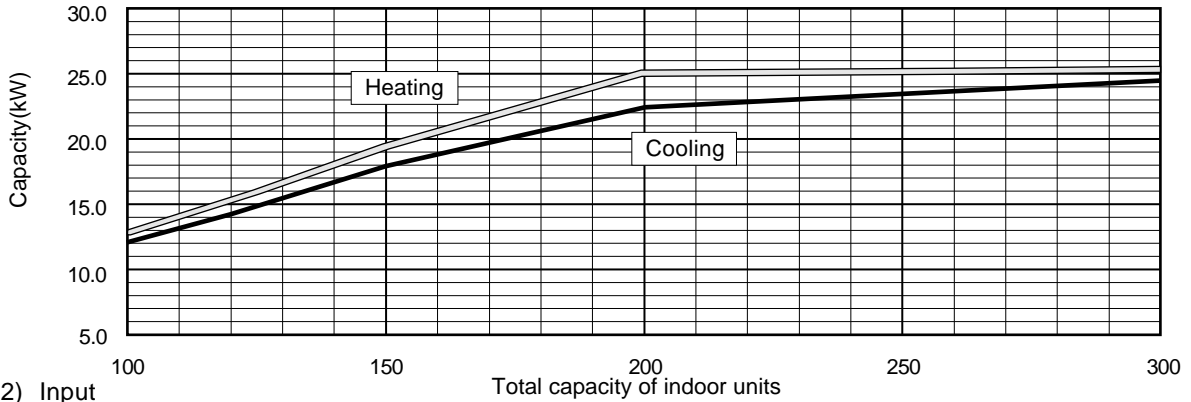

2) Input

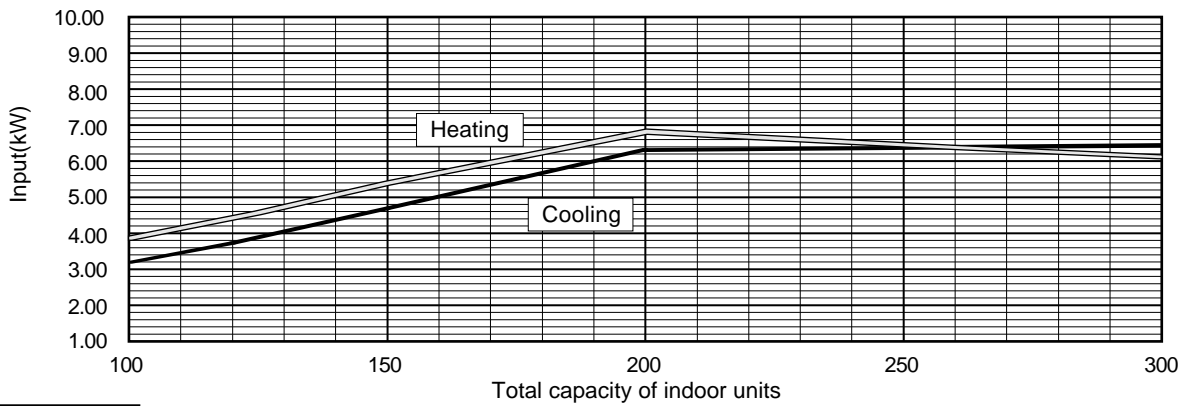

PURY-P250

1) Capacity

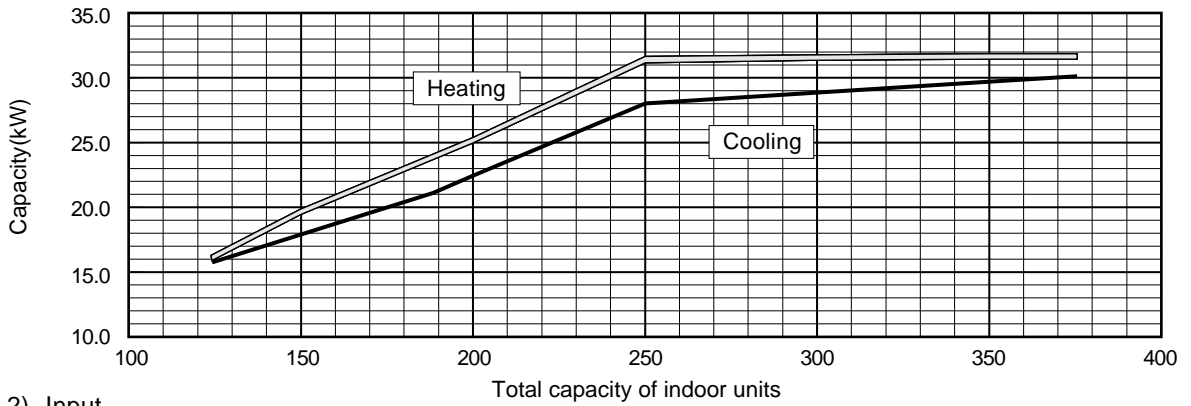

2) Input

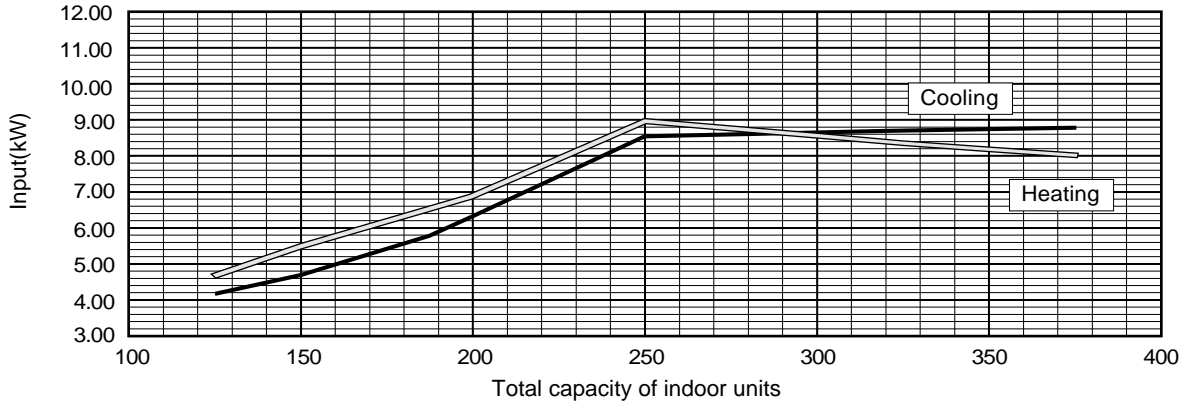

R2(R407C)

2-3. Correction by refrigerant piping length

To obtain a decrease in cooling/heating capacity due to refrigerant piping extension, multiply by the capacity correction factor based on the refrigerant piping equivalent length in the table below.

• Cooling capacity correction

PURY-P200

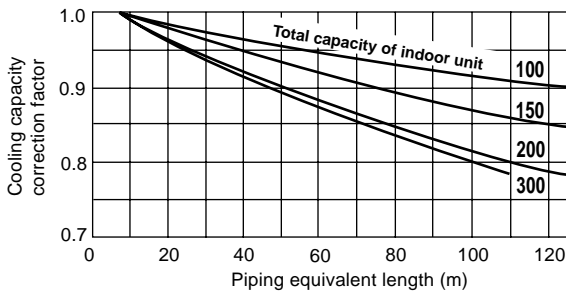

PURY-P250

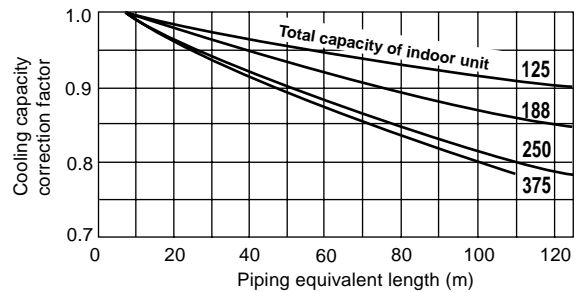

• Heating capacity correction

PURY-P200

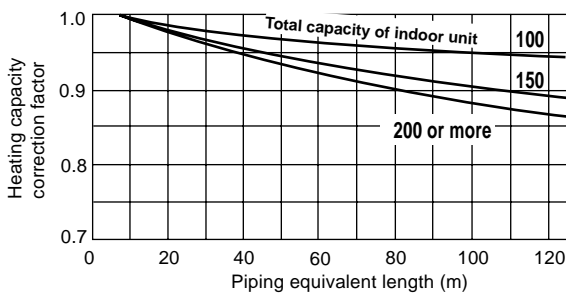

PURY-P250

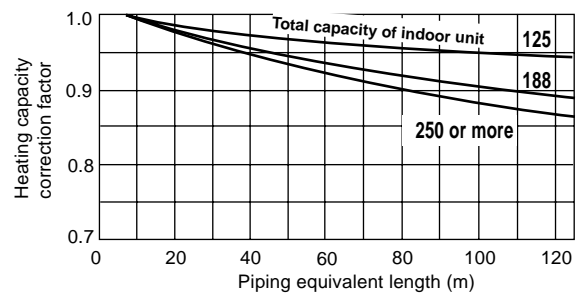

• How to obtain piping equivalent length

① **PURY-P200**

Equivalent length = (Actual piping length to the farthest indoor unit) + (0.47 × number of bent on the piping)m

② **PURY-P250**

Equivalent length = (Actual piping length to the farthest indoor unit) + (0.50 × number of bent on the piping)m

R2(R407C)

2-4. Correction at frosting and defrosting

When a decrease in heating capacity due to frosted and defrosting operations is considered, the value multiplied by the correction factor in the table below represents the heating capacity.

Correction factor table

Outdoor inlet air temp (°CWB)	6	4	2	0	-2	-4	-6	-8	-10
Correction factor	1.0	0.95	0.84	0.83	0.87	0.9	0.95	0.95	0.95

2-5. Operation limit

• Cooling

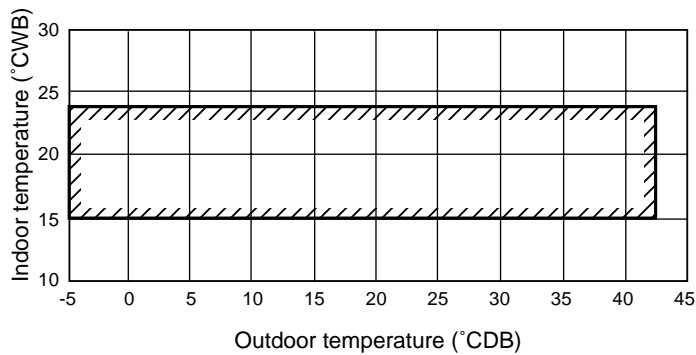

• Heating

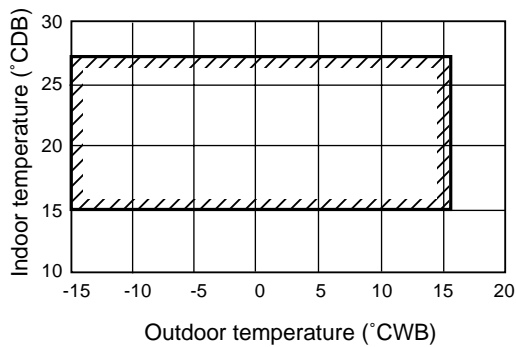

* Outdoor temperature : -5°CDB/-6°CWB ~ 21°CDB/15.5°CWB in cooling/heating mixed mode.

3. Sound Levels

PURY-P200

Measurement condition

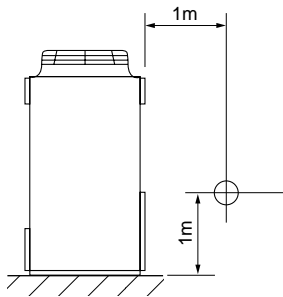

Sound pressure level in anechoic room

56 dB (A)

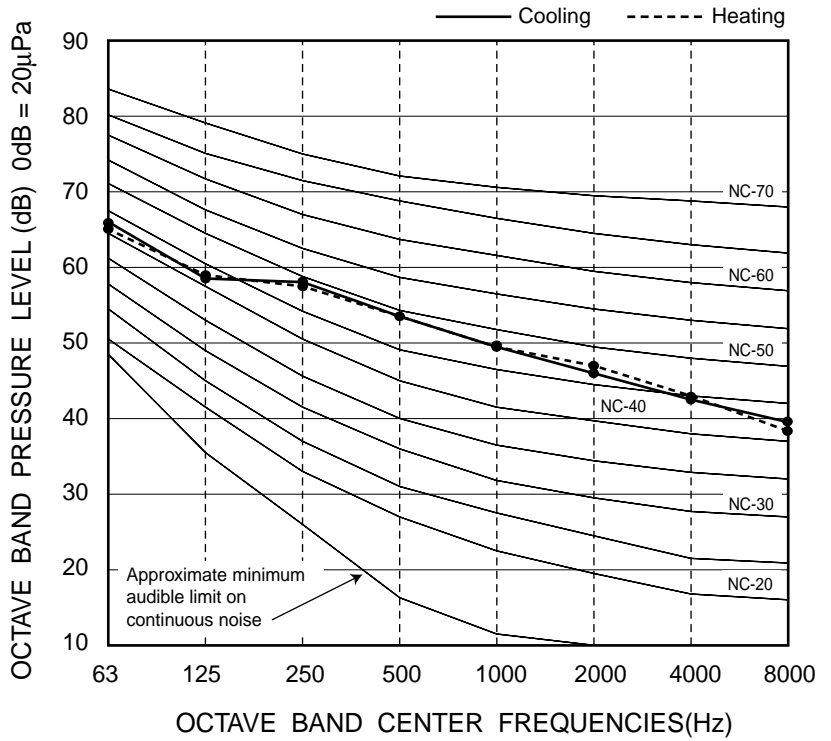

PURY-P250

Measurement condition

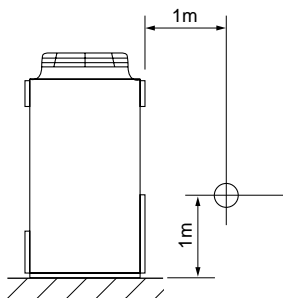

Sound pressure level in anechoic room

57 dB (A)

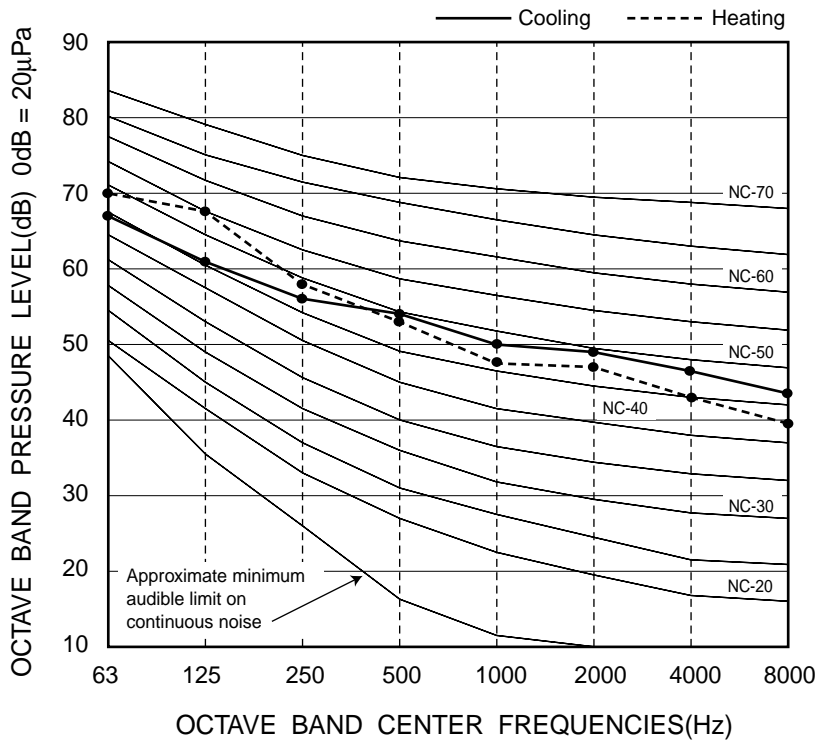

R2(R407G)

4. External Dimensions

PURY-P200,250YEM-A(-BF, -BS)

Unit : mm

- <Accessory>
- Refrigerant (gas) conn. pipe ... 1pc.
(The connecting pipe is fixed with the unit)
- Packing for conn. pipe 1pc.
(Attached near the ball valve)
- Wiring mounting board
- Conduit mounting plate
(Painted the same color as the unit body)
- $\phi 40$ 1pc.
- $\phi 33$ 1pc.
- $\phi 27$ 1pc.
- Tapping screw 4 X 10..... 6pcs.

Note 1: Please leave a space under the outdoor unit for the piping. When you connect the piping from the bottom.
(Please be careful not to close the hole of the bottom plate by the basement)

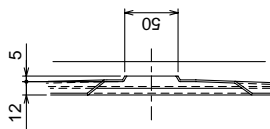
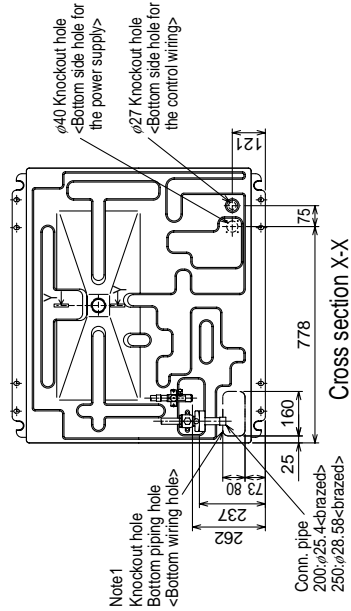
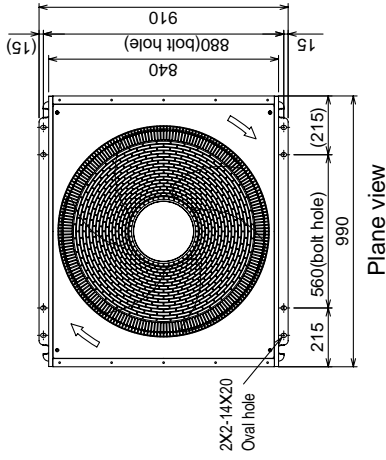

Note 1
Knockout hole
Bottom piping hole
<Bottom wiring hole>

Conn. pipe
200: $\phi 25$ -4-brazed<
250: $\phi 28$ -56-brazed>

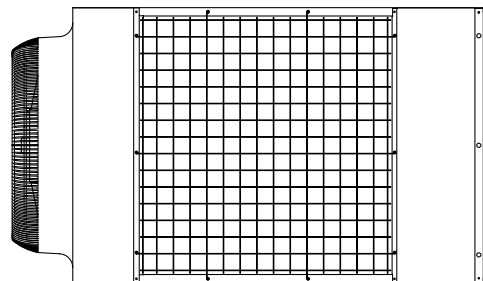
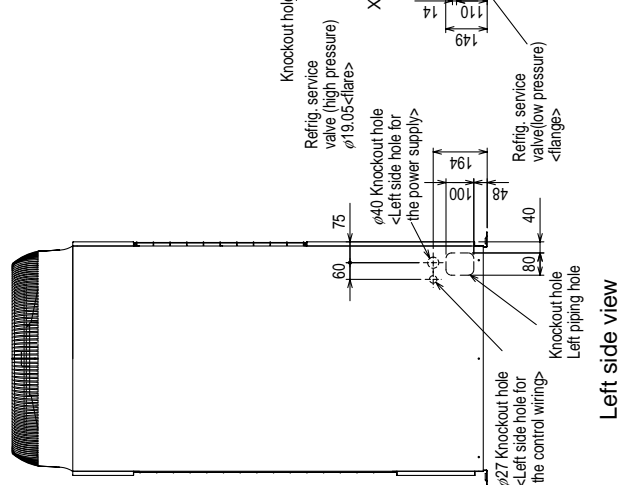
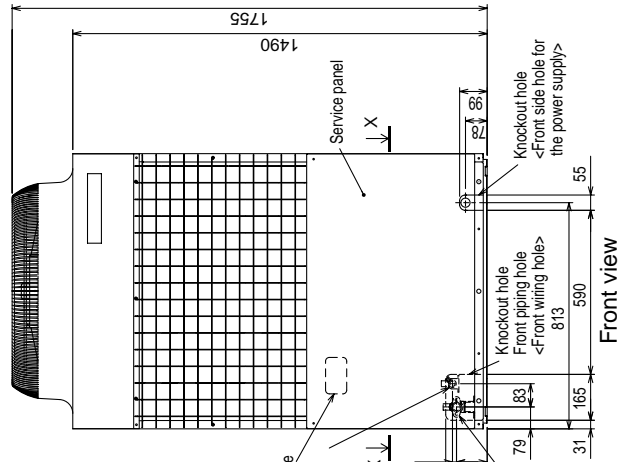
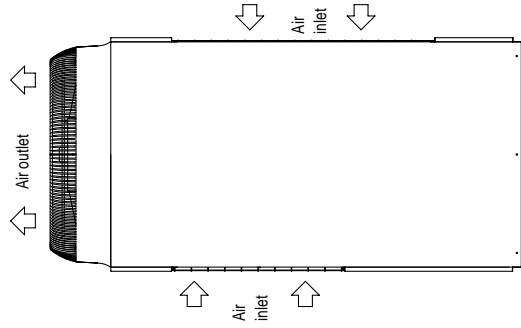

R2(R407C)

5. Electrical Wiring Diagram

PURY-P200, 250YEM-A(-BF, -BS)

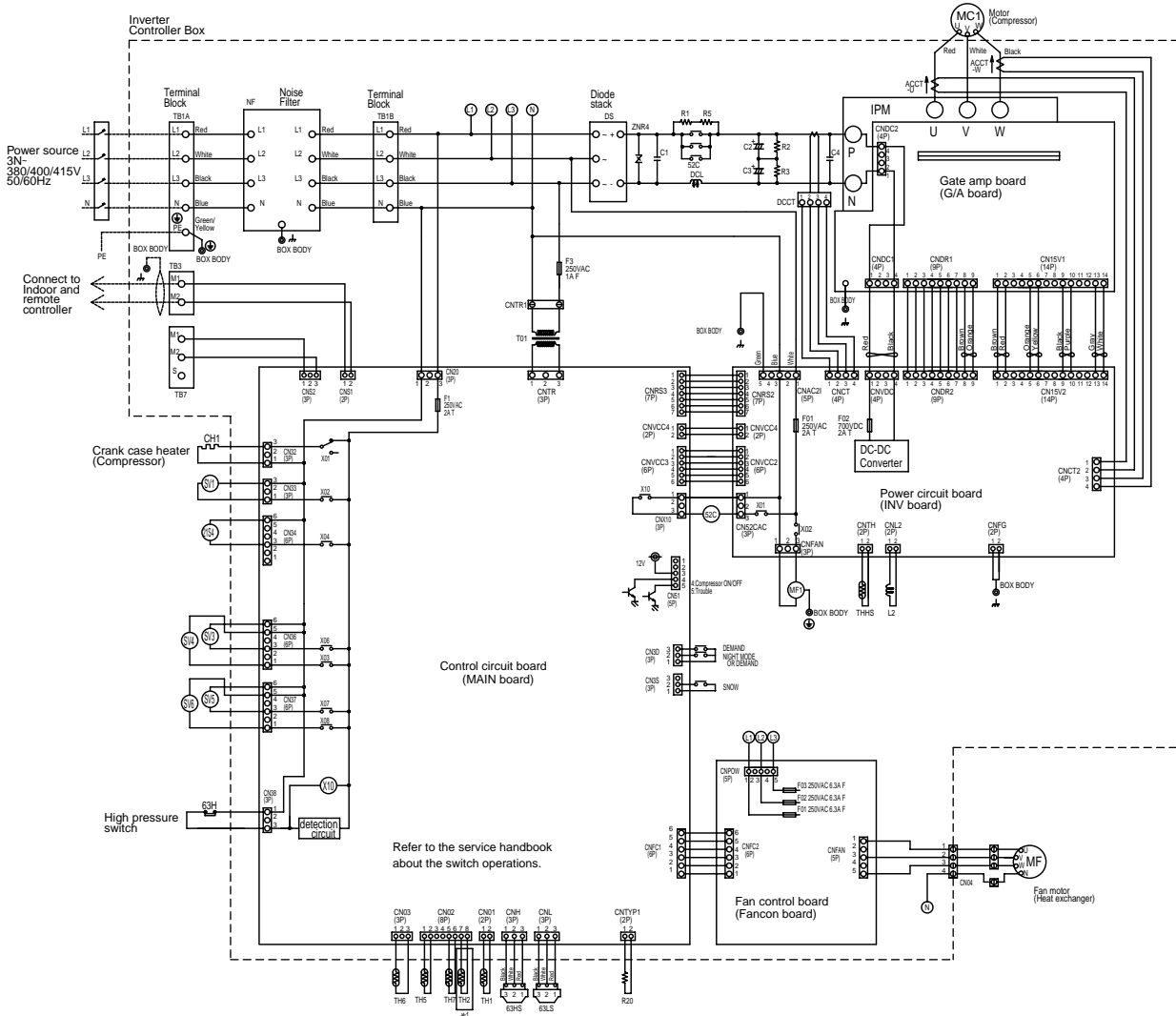

no fuse breaker

PURY-(P)200YEM-A	30A
PURY-(P)250YEM-A	30A

<DIFFERENCE OF APPLIANCE>

Appliance	N a m e
PURY-P200/250YEM-A	All exists
PURY-P200/250YEM-A	"*1" are not existed

<SYMBOL EXPLANATION>

Symbol	N a m e	Symbol	N a m e	Symbol	N a m e	
DCL	DC reactor (Power factor improvement)	SV1	Solenoid valve (Discharge-suction bypass)	TH2 #1	Thermistor Saturation evapo. temp. detect	
DCCT	Current Sensor	SV3-SV6	Solenoid valve (Heat exchanger capacity control)	TH5		Pipe temp. detect
ACCT-U,W	Current Sensor	63HS	High pressure sensor	TH6		OA temp. detect
ZNR4	Varistor	63LS	Low pressure sensor	TH7		liquid outlet temp. detect at Sub-cool coil
52C	Magnetic contactor (Inverter main circuit)	L2	Choke coil(Transmission)	THHS	Radiator panel temp. detect	
MF1	Fan motor (Radiator panel)	IPM	Intelligent power module	X1-10	Aux. relay	
21S4	4-way valve	TH1	Thermistor Discharge pipe temp. detect	⊕	Earth terminal	

R2(R407G)

6. Refrigerant Circuit Diagram And Thermal Sensor

PURY-P200, 250

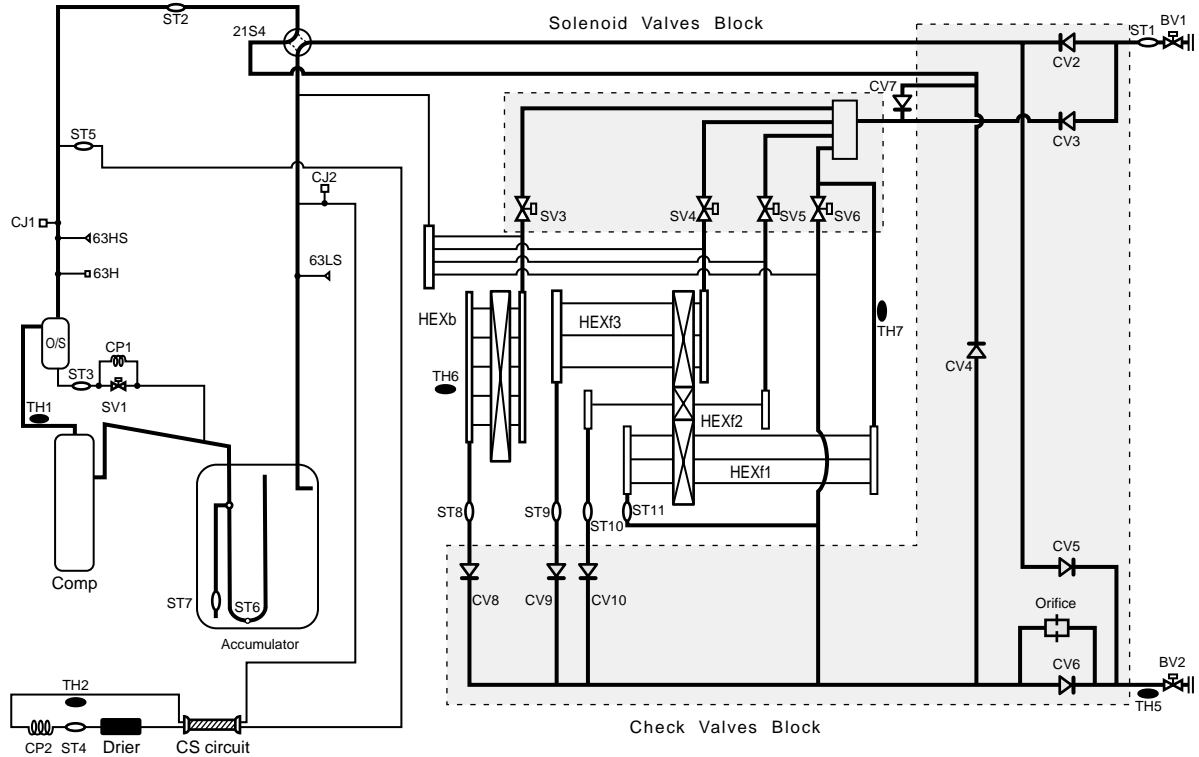

- ⊗ : Solenoid valve
- : Thermal sensor
- ⊕ : Orifice
- : Strainer
- ⌞ : Capillary
- SP : Service port
- ⌞ : Check valve
- ACC : Accumulator

R2(R407C)

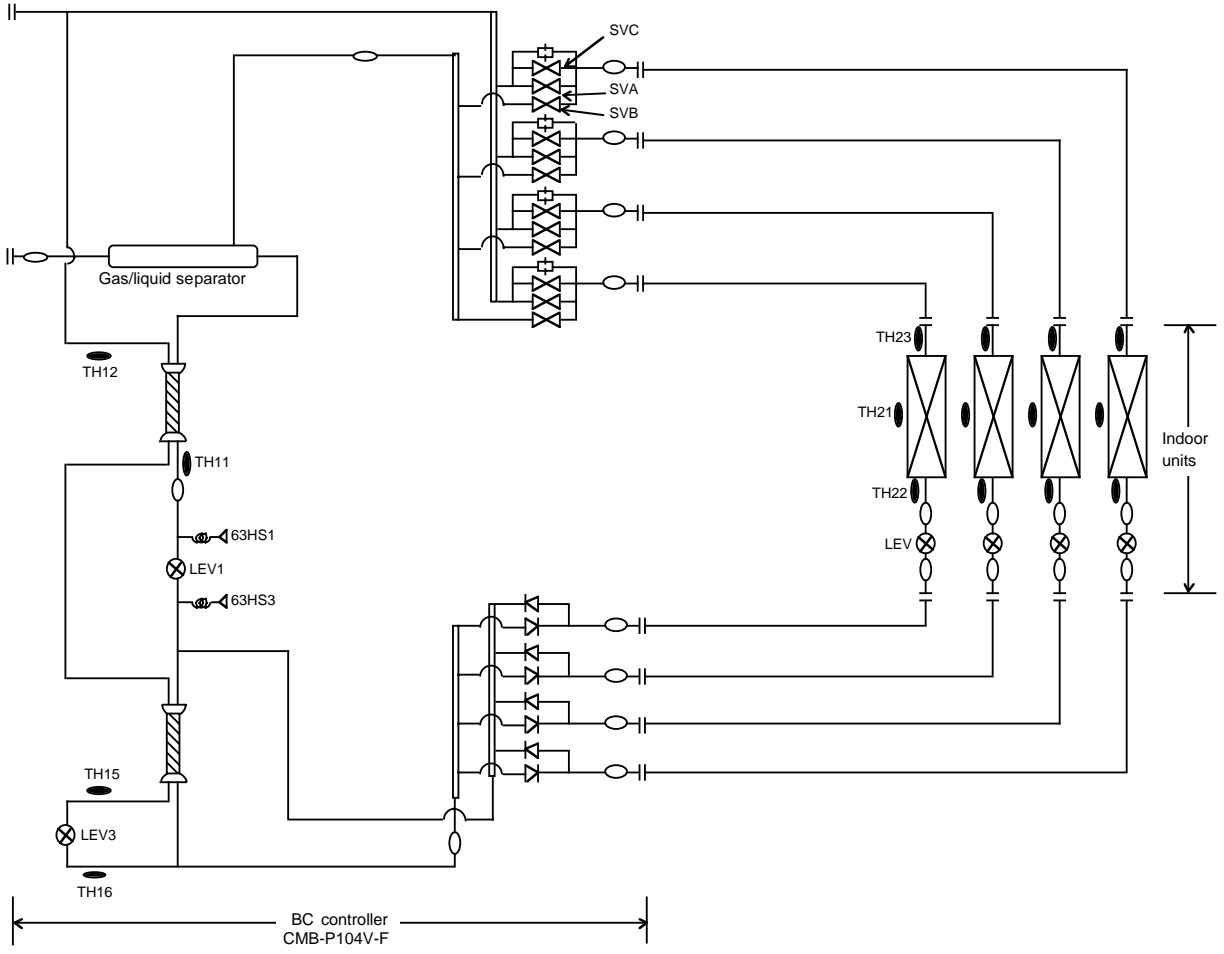

PURY-P400-500YEM-A

CONTENTS

1. Specifications	I -88
2. Capacity Tables	I -90
2-1 Correction by temperature	I -90
2-2 Correction by total indoor	I -92
2-3 Correction by refrigerant piping length	I -93
2-4 Correction at frosting and defrosting	I -94
2-5 Operation limit	I -94
3. Sound Levels	I -95
4. External Dimensions	I -96
5. Electrical Wiring Diagram	I -97
6. Refrigerant Circuit Diagram	I -98
And Thermal Sensor	

1. Specifications

Model name		PURY-P400YEM-A	
		Cooling	Heating
Capacity	*1	kW	45.0
	*2	kcal/h	40,000
Power source		3N~380/400/415V 50/60Hz	
Power input		kW	15.87
Current		A	26.7/25.4/24.5
Fan	TypeX Quantity		Propeller fanX2
	Airflow rate	m ³ /min	400
	Motor output	kW	0.38 X 2
Compressor	Type		Hermetic
	Motor output	kW	7.5 + 4.5
	Crankcase heater	kW	0.045 + 0.045
Refrigerant / Lubricant		R407C/MEL32	
External finish		Pre-coated galvanized sheets (Powder coating) <MUNSELL 5Y8/1 or similar>	
External dimension		mm	1755(H)X1990(W)X840(L)
Protection devices	High pressure protection		2.94MPa
	Compressor / Fan		Overcurrent protection / Thermal switch
	Inverter		DC bus current protection, thermal switch
Refrigerant piping diameter	High press. / Low press.	φ 25.4 (Flange) / φ 34.93 (Flange)	
Indoor unit	Total capacity		50~150% of outdoor unit capacity
	Model / Quantity		Model P20~250 / 2~24
Noise level	*	dB<A>	60/61
Net weight		kg	470
Operating temperature range		Indoor : 15°CWB~24°CWB Outdoor : -5°CDB~43°CDB	Indoor : 15°CDB~27°CDB Outdoor : -15°CWB~15.5°CWB
		-5°CDB/-6°CWB ~ 21°CDB/15.5°CWB with cooling/heating mixed operation.	

Note: 1.Cooling/heating capacity indicates the maximum value at operation under the following condition.

*1 **Cooling** Indoor : 27°CDB/19°CWB Outdoor : 35°CDB

Heating Indoor : 20°CDB

Pipe length : 7.5m

Outdoor : 7°CDB/6°CWB

Height difference : 0m

*2 **Cooling** Indoor : 27°CDB/19.5°CWB Outdoor : 35°CDB

Pipe length : 5m

Height difference : 0m

* It is measured in anechoic room.

Model name			PURY-P500YEM-A	
			Cooling	Heating
Capacity	*1	kW	56.0	63.0
	*2	kcal/h	50,000	-
Power source			3N~380/400/415V 50/60Hz	
Power input		kW	19.89	18.27
Current		A	33.5/31.9/30.7	30.8/29.2/28.2
Fan	TypeX Quantity		Propeller fanX2	
	Airflow rate	m ³ /min	400	
	Motor output	kW	0.38 X 2	
Compressor	Type		Hermetic	
	Motor output	kW	7.5 + 7.5	
	Crankcase heater	kW	0.045 + 0.056	
Refrigerant / Lubricant			R407C/MEL32	
External finish			Pre-coated galvanized sheets (Powder coating) <MUNSELL 5Y8/1 or similar>	
External dimension		mm	1755(H)X1990(W)X840(L)	
Protection devices	High pressure protection		2.94MPa	
	Compressor / Fan		Overcurrent protection / Thermal switch	
	Inverter		DC bus current protection, thermal switch	
Refrigerant piping diameter		High press. / Low press.	φ 25.4 (Flange) / φ 34.93 (Flange)	
Indoor unit	Total capacity		50~150% of outdoor unit capacity	
	Model / Quantity		Model P20~250 / 2~24	
Noise level		* dB<A>	60/61	
Net weight		kg	500	
Operating temperature range			Indoor : 15°CWB~24°CWB Outdoor : -5°CDB~43°CDB	Indoor : 15°CDB~27°CDB Outdoor : -15°CWB~15.5°CWB
			-5°CDB/-6°CWB ~ 21°CDB/15.5°CWB with cooling/heating mixed operation.	

Note: 1.Cooling/heating capacity indicates the maximum value at operation under the following condition.

*1 Cooling Indoor : 27°CDB/19°CWB	Outdoor : 35°CDB	*2 Cooling Indoor : 27°CDB/19.5°CWB	Outdoor : 35°CDB
Heating Indoor : 20°CDB	Outdoor : 7°CDB/6°CWB	Pipe length : 5m	Height difference : 0m
Pipe length : 7.5m	Height difference : 0m		

* It is measured in anechoic room.

Big R2(R407C)

2. Capacity Tables

2-1. Correction by temperature

Cooling

- Standard Specifications

		PURY-P400	PURY-P500
Capacity	kW	45.0	56.0
Input	kW	15.87	19.89

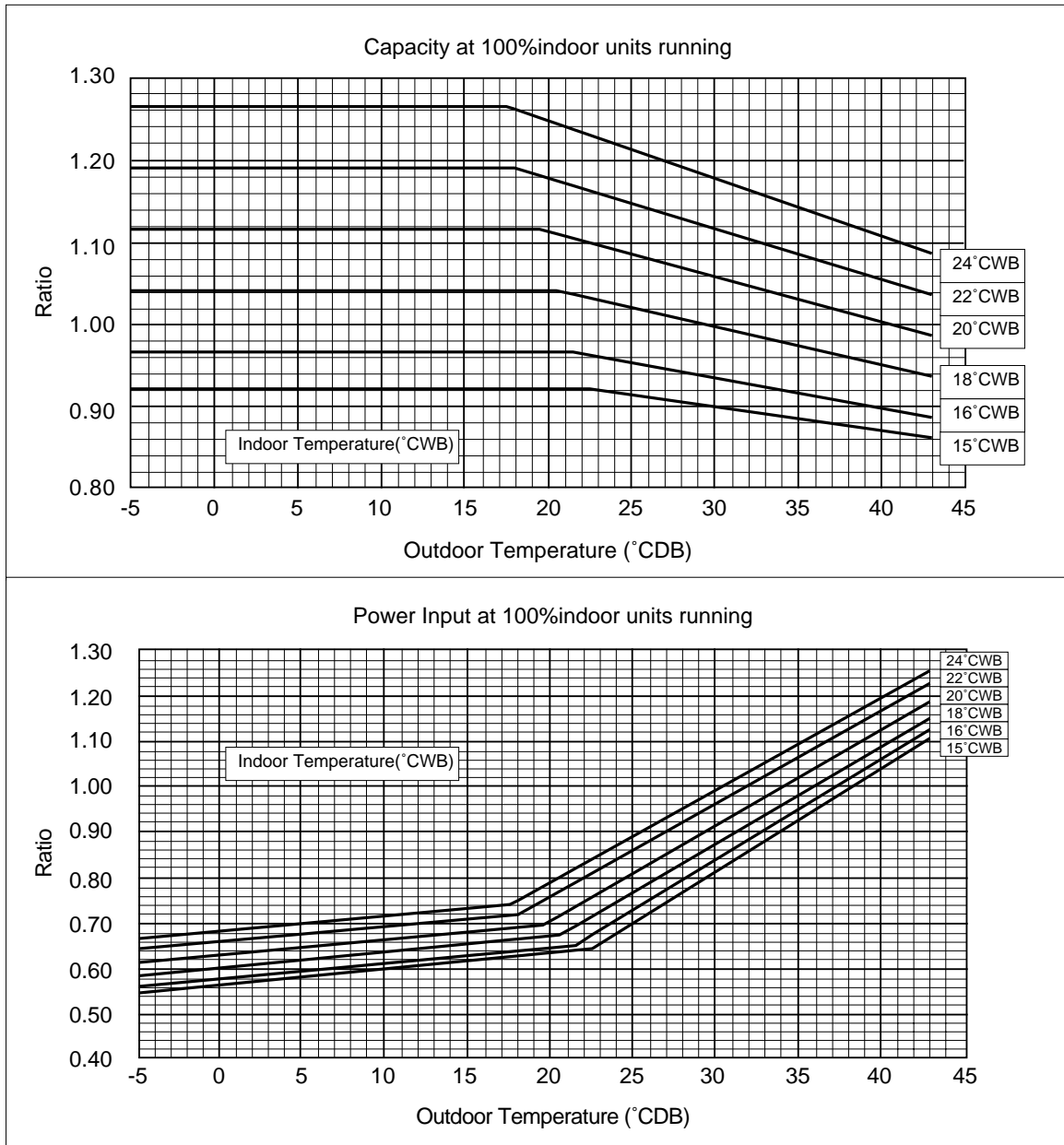

Big R2(R407C)

Heating

- Standard Specifications

	PURY-P400	PURY-P500
Capacity kW	50.0	63.0
Input kW	14.59	18.27

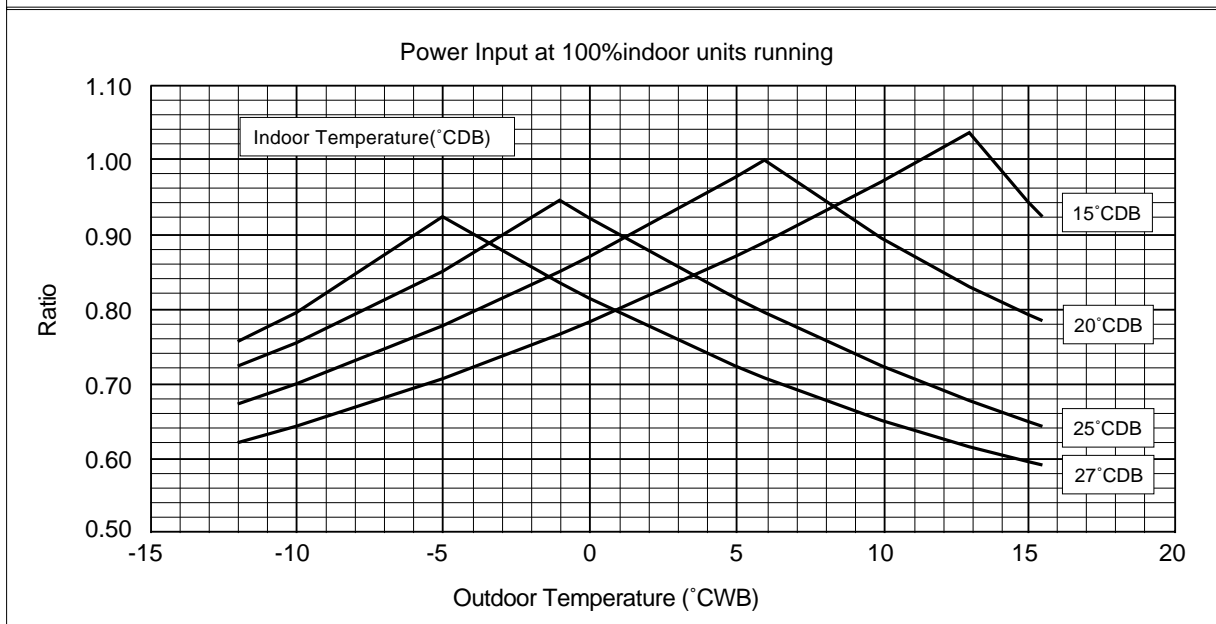
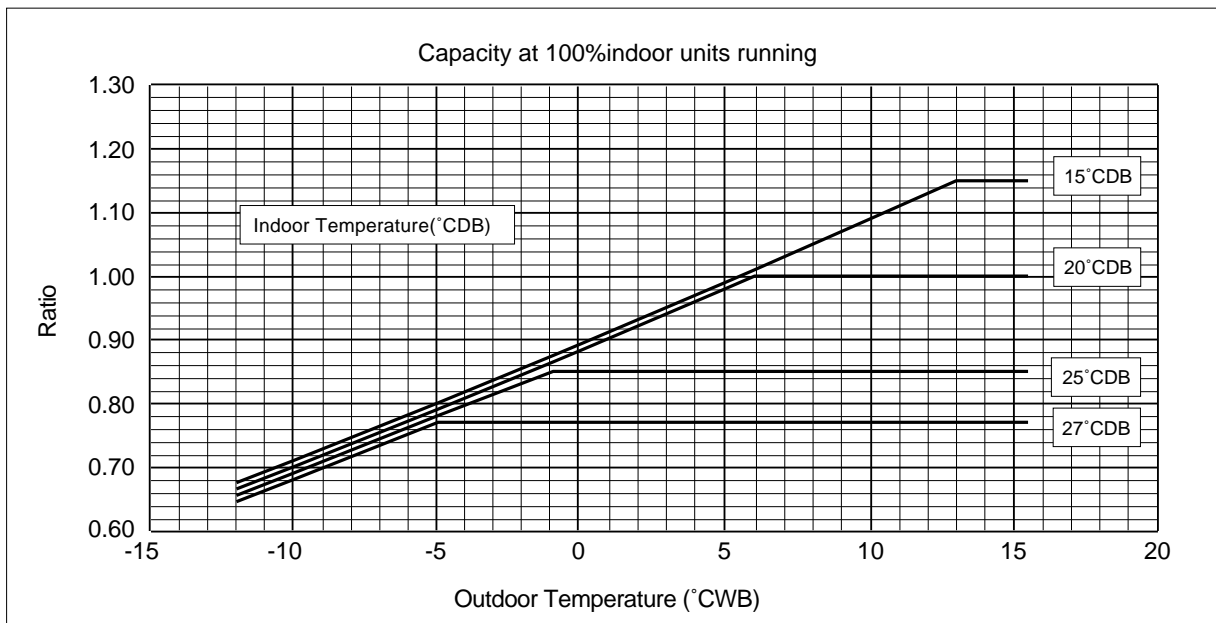

Big R2(R407C)

2-2. Correction by total indoor

PURY-P400

1) Capacity

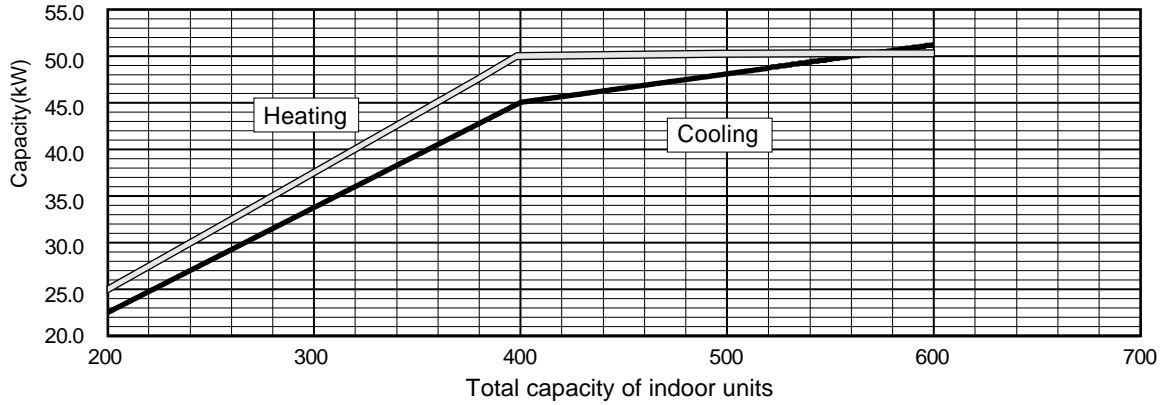

2) Input

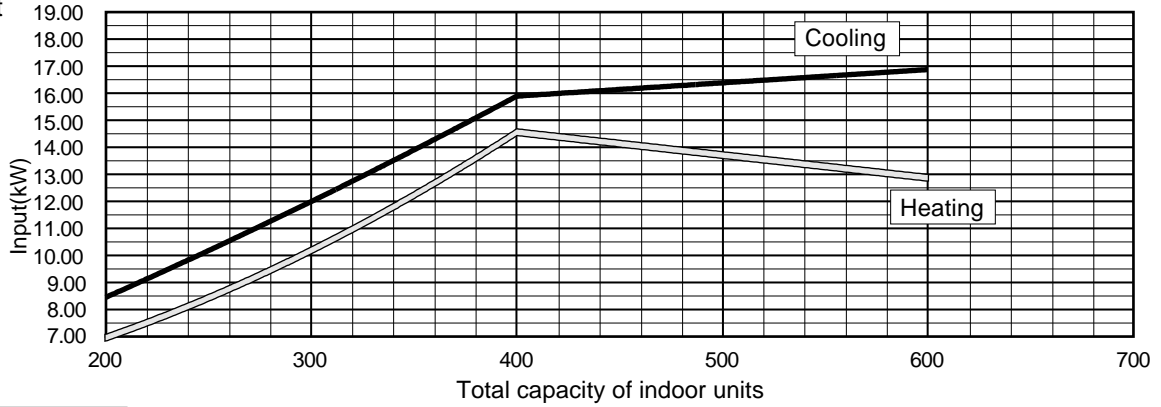

PURY-P500

1) Capacity

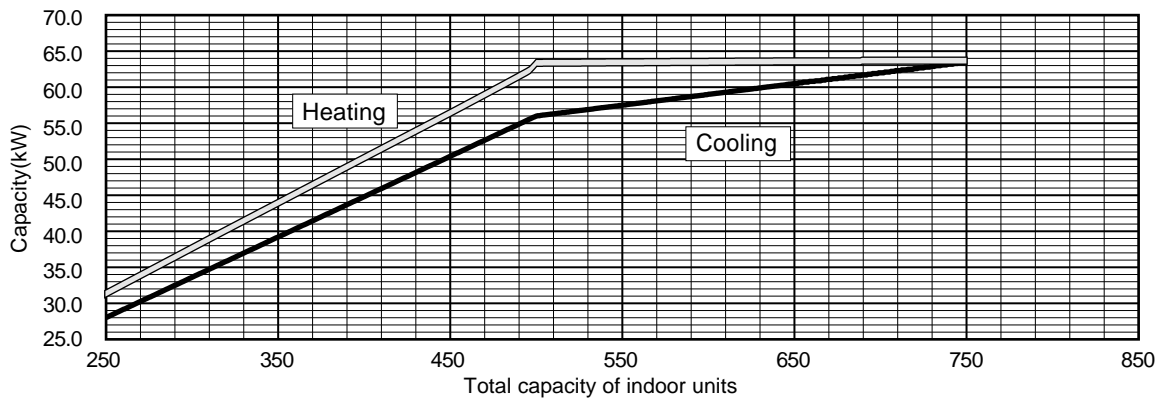

2) Input

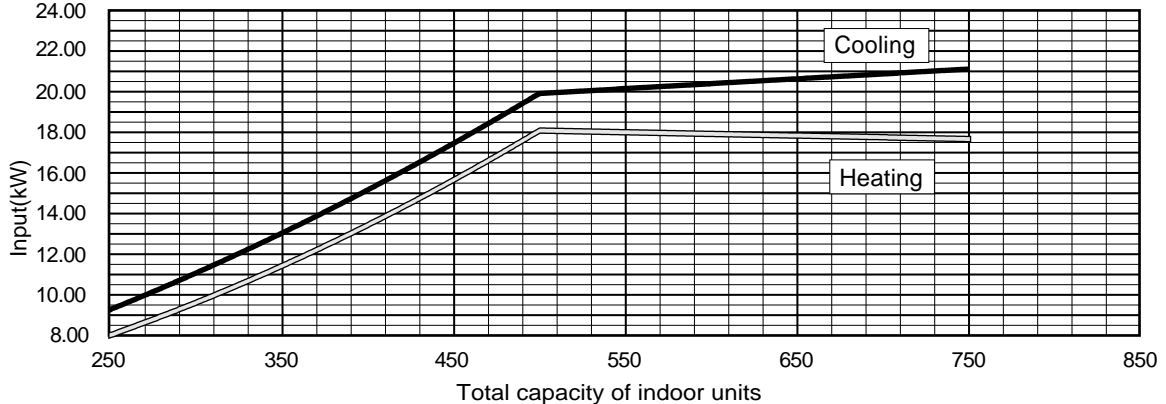

Big R2(R407C)

2-3. Correction by refrigerant piping length

To obtain a decrease in cooling/heating capacity due to refrigerant piping extension, multiply by the capacity correction factor based on the refrigerant piping equivalent length in the table below.

• Cooling capacity correction

PURY-P400

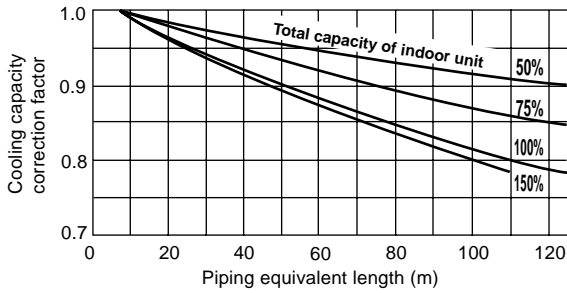

PURY-P500

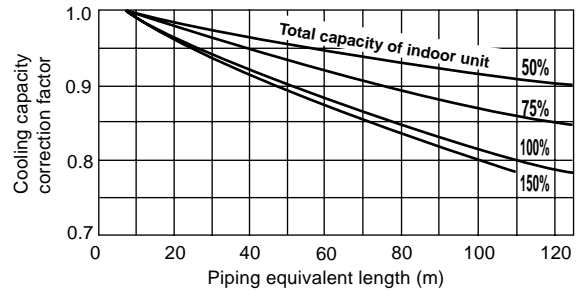

• Heating capacity correction

PURY-P400

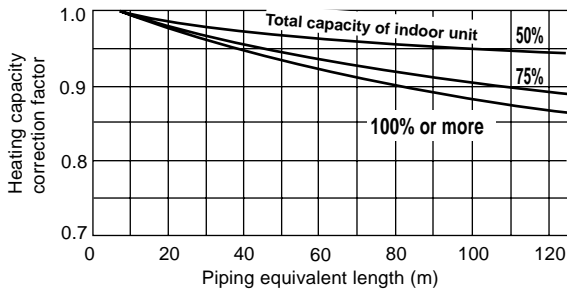

PURY-P500

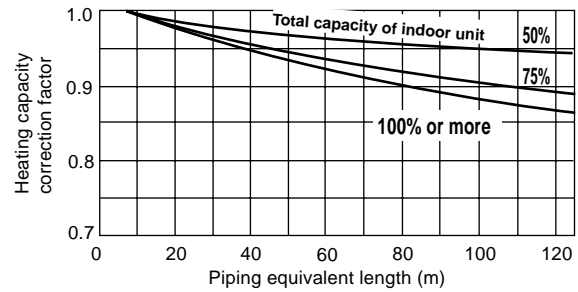

* In case of using $\phi 22.22$ pipe
PURY-P400, 500

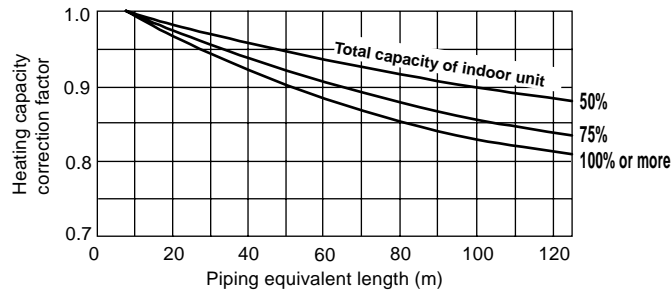

• How to obtain piping equivalent length

① PURY-P400

Equivalent length = (Actual piping length to the farthest indoor unit) + (0.70 × number of bent on the piping)m

② PURY-P500

Equivalent length = (Actual piping length to the farthest indoor unit) + (0.80 × number of bent on the piping)m

2-4. Correction at frosting and defrosting

When a decrease in heating capacity due to frosted and defrosting operations is considered, the value multiplied by the correction factor in the table below represents the heating capacity.

Correction factor table

Outdoor inlet air temp (°CWB)	6	4	2	0	-2	-4	-6	-8	-10
Correction factor	1.0	0.95	0.84	0.83	0.87	0.9	0.95	0.95	0.95

2-5. Operation limit

• Cooling

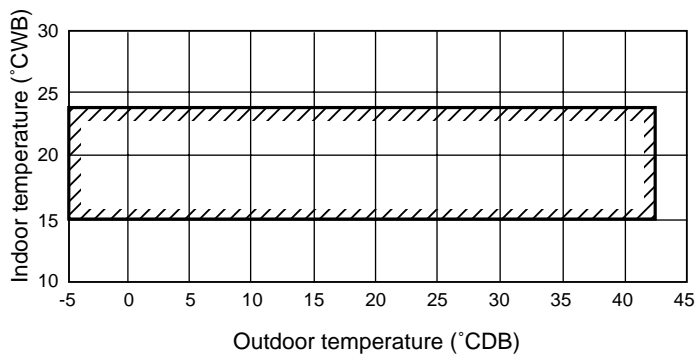

• Heating

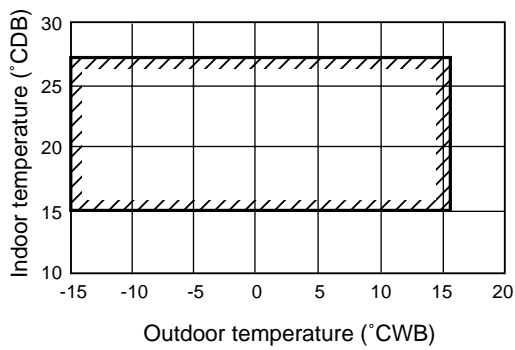

* Outdoor temperature : -5°CDB/-6°CWB ~ 21°CDB/15.5°CWB in cooling/heating mixed mode.

3. Sound Levels

PURY-P400
Measurement condition

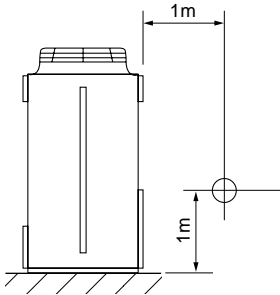

Sound pressure level in anechoic room
60/61 dB (A)

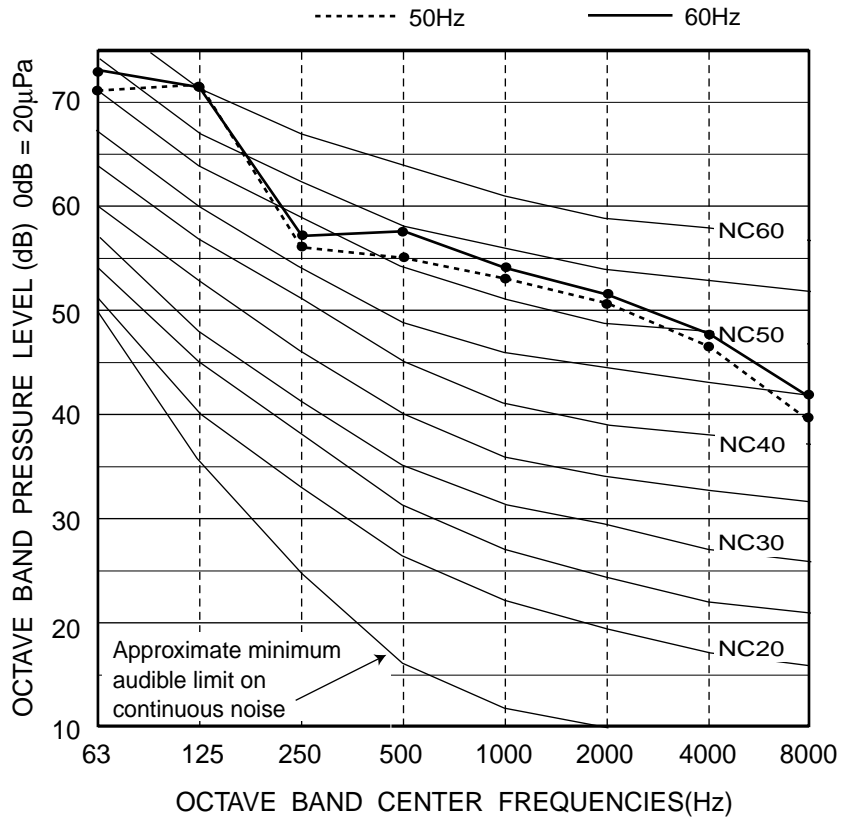

PURY-P500
Measurement condition

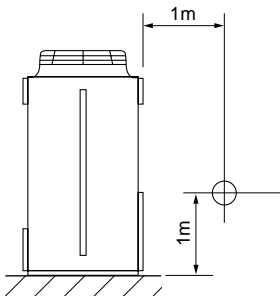

Sound pressure level in anechoic room
60/61 dB (A)

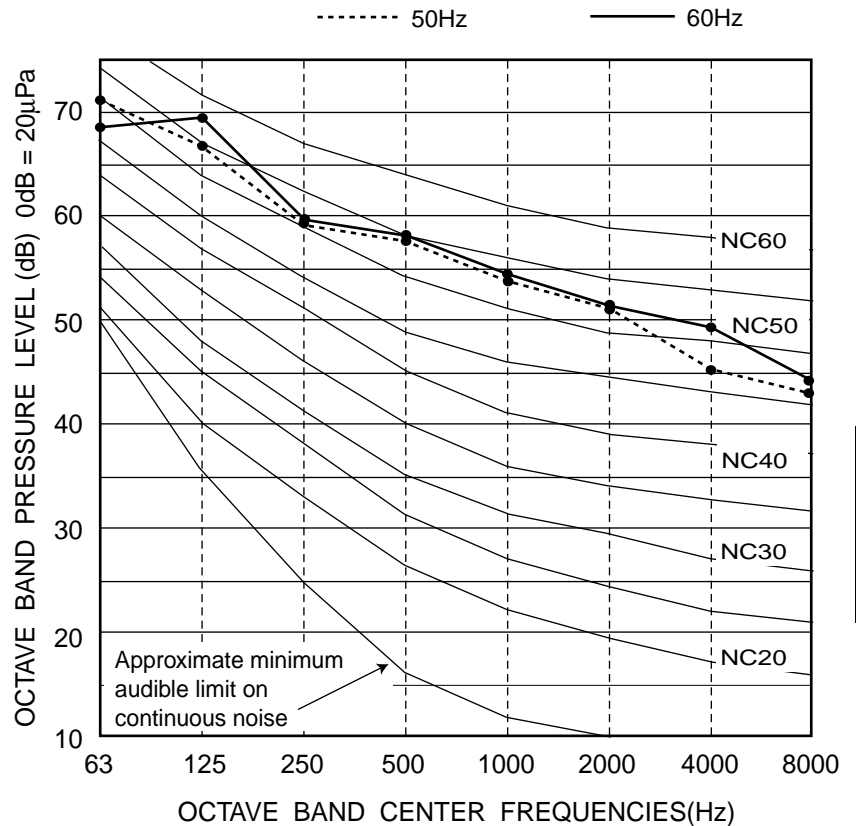

Big R2(R407C)

4. External Dimensions

PURY-P400,500YEM-A

Unit : mm

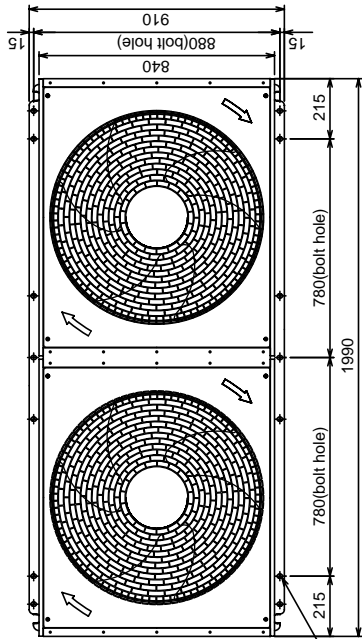

Plane view

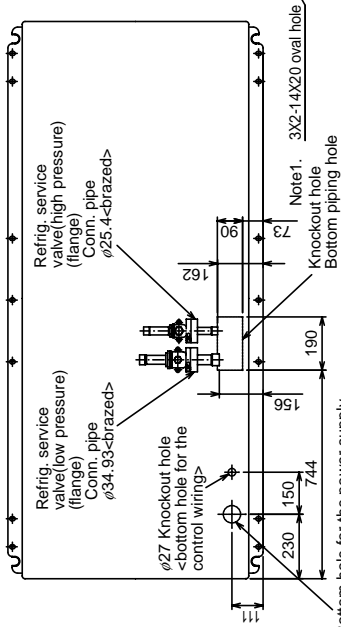

Cross section X-X

- <Accessories>
- Refrigerant (high pressure) conn. pipe.....1pc.
(The connecting pipe has been fixed with the unit)
 - Refrigerant (low pressure) conn. pipe.....1pc.
(The connecting pipe has been fixed with the unit)
 - Packing for conn. high pressure pipe.....1pc.
(Attached near the ball valve)
 - Packing for conn. low pressure pipe.....1pc.
(Attached near the ball valve)
 - Conduit mounting plate
(Painted the same color as the unit body)
 - Tapping screw 4X12.....4pcs.
 - Wiring partition plate.....1pc.

Note 1. Please leave a space under the outdoor unit for the piping when you connect the piping from the bottom.
(Please be careful not to close the hole of the bottom plate by the basement)

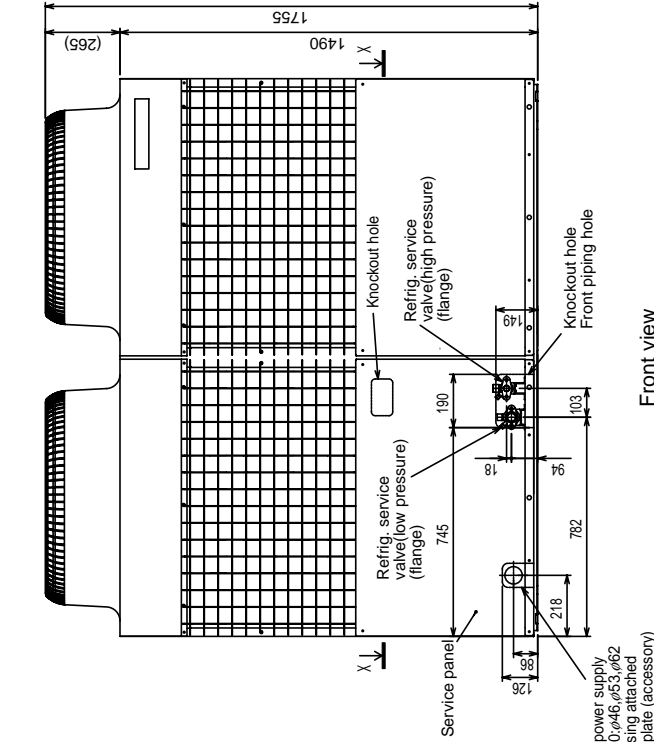

Front view

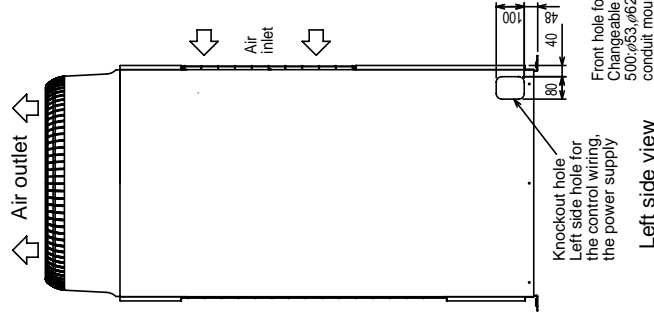

Left side view

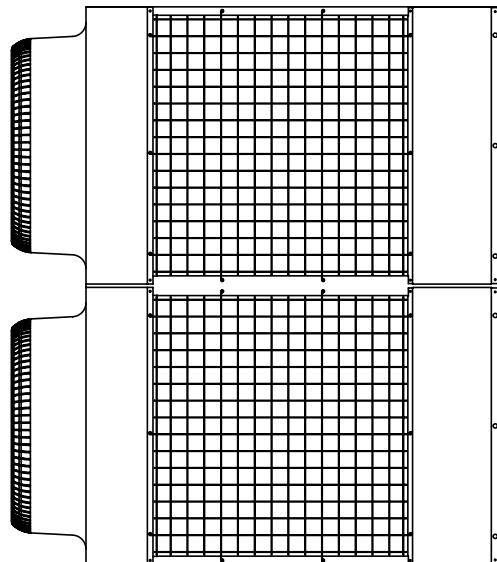

Rear view

Front hole for the power supply
Changeable to 400,φ46,φ53,φ62
500,φ53,φ62 by using attached
conduit mounting plate (accessory)

Knockout hole
Left side hole for
the control wiring,
the power supply

Big R2(R407C)

5. Electrical Wiring Diagram

PURY-P400, 500YEM-A

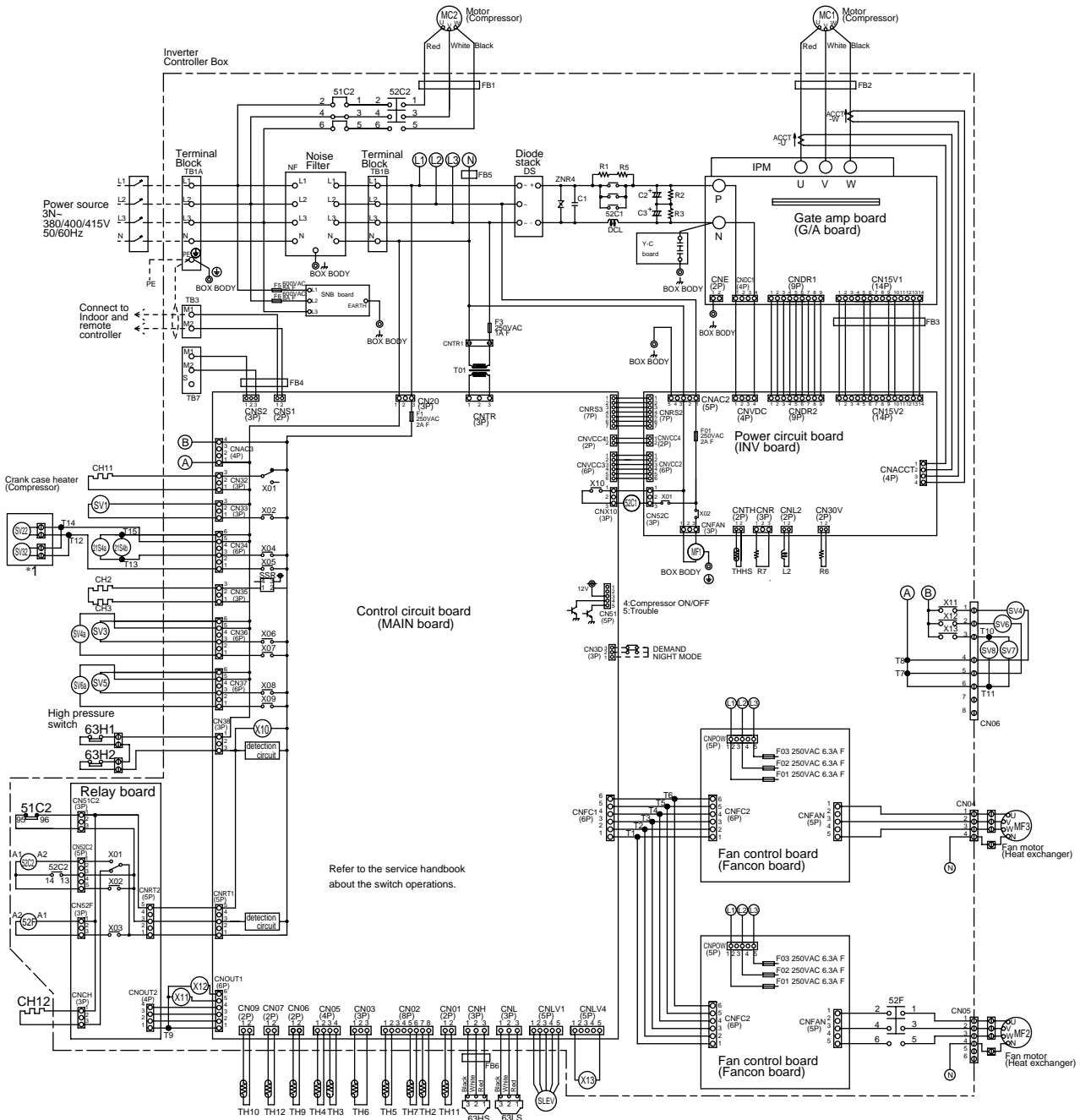

<Symbol explanation>

Symbol	Name	Symbol	Name
DCL	DC reactor (Power factor improvement)	IPM	Intelligent power module
ACCT-U,W	Current Sensor	TH11,12	Thermistor
ZNR4	Varistor	TH2	Discharge pipe temp. detect
52C1	Magnetic contactor (Inverter main circuit)	TH3	Saturation evapo. temp. detect
52C2	Magnetic contactor	TH4	Accumulator liquid Lower temp. detect
51C2	Overload relay	TH5	Accumulator liquid Upper temp. detect
52F	Magnetic contactor(Fan motor)	TH6	Pipe temp. detect(Hex outlet)
MF1	Fan motor (Radiator panel)	TH7	OA temp. detect
21S4a,4b	4-way valve	TH9	Pipe temp. (Hex inlet)
SV1,22,32,4a,6a	Solenoid valve	TH10	High pressure liquid temp.
SV3,4,5,6,7,8	Solenoid valve (Heat exchanger capacity control)	THHS	Compressor shell temp.
SLEV	Electronic expansion valve(Oil return)	LD	Radiator panel temp. detect
63HS	High pressure sensor	CH11,12	Accumulator liquid level detect
63LS	Low pressure sensor	CH2,3	Crank case heater(Compressor)
63H1,2	High pressure switch	CH2,3	Cord heater
L2	Choke coil(Transmission)	SSR	Solid state relay
		X1,2,4-13	Aux. relay
		FB1-6	Ferrite core
		⊕	Earth terminal
		T1-15	Terminal

NOTE : Mark ○ indicates terminal bed, ⊗ connector, ⊕ board insertion connector

<Difference of appliance>

Appliance	Name
PURY-P400	**1* are not existed
PURY-P500	All exists

Big R2(R407C)

6. Refrigerant Circuit Diagram And Thermal Sensor

PURY-P400, 500

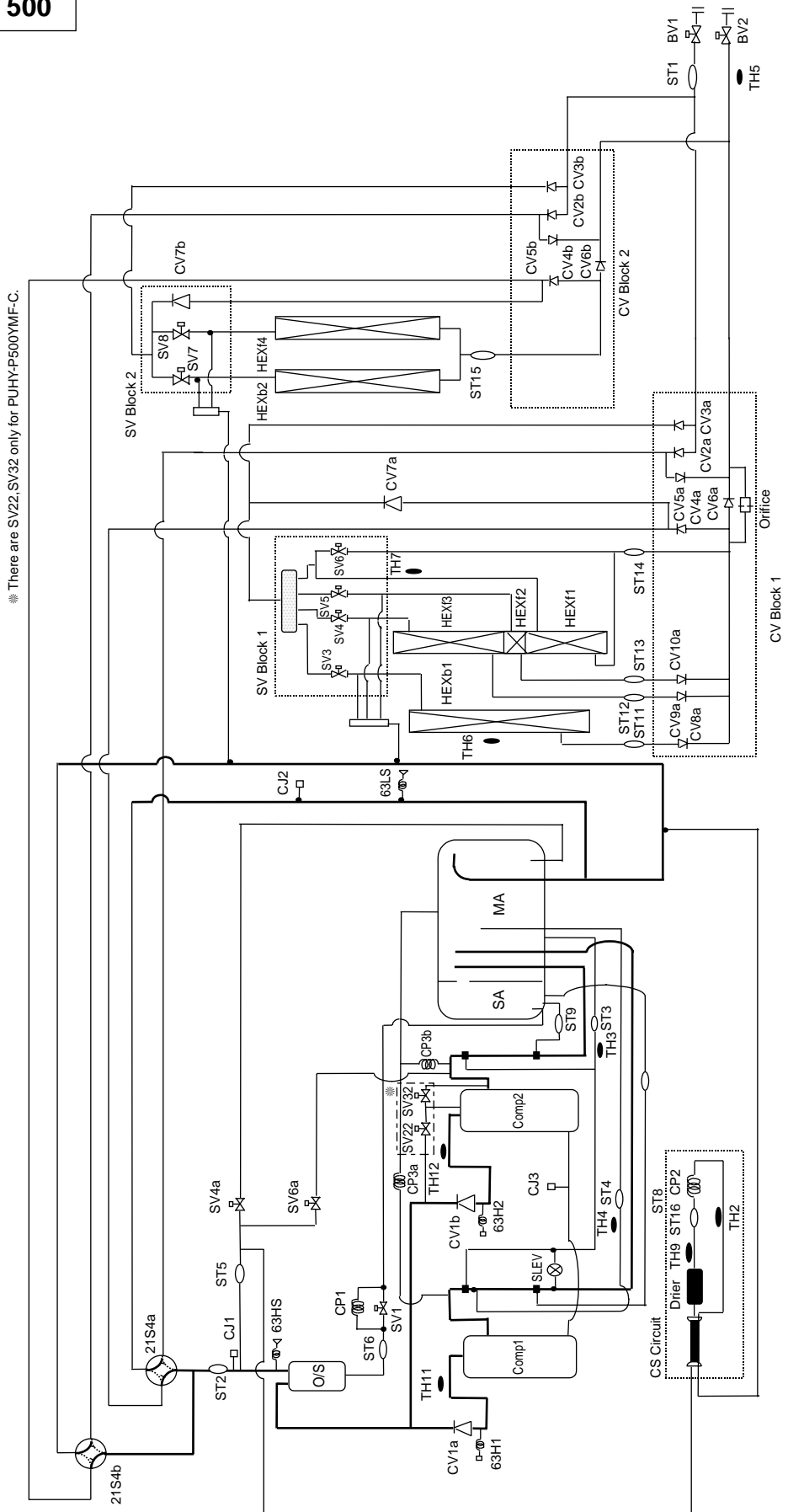

Big R2(R407C)

PQHY-P200-250YEM-A

CONTENTS

1. Specifications	I -100
2. Capacity Tables	I -102
2-1 Correction by temperature	I -102
2-2 Correction by total indoor	I -104
2-3 Correction by refrigerant piping length	I -105
2-4 Operation limit	I -105
3. Sound Levels	I -106
4. External Dimensions	I -107
5. Electrical Wiring Diagram	I -108
6. Refrigerant Circuit Diagram	I -109
And Thermal Sensor	
7. System design guide	I -110

1. Specifications

Model name		PQHY-P200YEM-A	
		Cooling	Heating
Capacity	kW	22.4	25.0
Power source		3N ~ 380/400/415V 50Hz/60Hz	
Power input	kW	7.22	7.24
Current	A	12.1/11.5/11.1	12.2/11.6/11.1
Compressor	Type	Hermetic	
	Motor output	kW	5.5
	Crankcase heater	kW	0.045(240V)
Heat exchanger	Type	Double coil	
	Water volume in the coil	l	10.5
Circulating water	Volume	m ³ /h	4.27
	Pressure drop	kPa	8
Refrigerant / Lubricant		R407C/MEL32	
External finish		Galvanized sheets	
External dimension	mm	1670(H)X 1150(W) X 500(L)	
Protection devices	High pressure protection		2.94MPa
	Compressor		Over current protection
	Inverter		DC bus current protection, thermal switch
Refrigerant piping diameter	Liquid / Gas	φ 12.7 (Flare) / φ 25.4 (Flange)	
Indoor unit	Total capacity		50~130% of heat source unit capacity
	Model / Quantity		Model 20~250/1~13
Noise level	*	dB<A>	51
Net weight		kg	270
Operating temperature range		Indoor:15°CWB ~ 24°CWB Water :10°C ~ 45°C	Indoor:15°CDB ~ 27°CDB Water :10°C ~ 45°C

Note: 1.Cooling/heating capacity indicates the maximum value at operation under the following condition.

Cooling Indoor : 27°CDB/19°CWB Water temperature : 30°C

Heating Indoor : 20°CDB Water temperature : 20°C

Pipe length : 7.5m Height difference : 0m

2.The ambient temperature of heat source unit has to be kept below 40°C (dry valve).

The ambient relative humidity of heat source unit has to be kept below 80%.

3.This unit can not be installed in the outdoor. (No protection against the weather.)

* It is measured in anechoic room.

WY(R407C)

Model name		PQHY-P250YEM-A	
		Cooling	Heating
Capacity	kW	28.0	31.5
Power source		3N ~ 380/400/415V 50Hz/60Hz	
Power input	kW	9.02	9.23
Current	A	15.2/14.4/13.9	15.5/14.8/14.2
Compressor	Type	Hermetic	
	Motor output	kW	7.5
	Crankcase heater	kW	0.045(240V)
Heat exchanger	Type	Double coil	
	Water volume in the coil	l	13
Circulating water	Volume	m ³ /h	5.79
	Pressure drop	kPa	10
Refrigerant / Lubricant		R407C/MEL32	
External finish		Galvanized sheets	
External dimension	mm	1670(H)X 1150(W) X 500(L)	
Protection devices	High pressure protection		2.94MPa
	Compressor		Over current protection
	Inverter		DC bus current protection, thermal switch
Refrigerant piping diameter		Liquid / Gas	φ 12.7 (Flare) / φ 28.58 (Flange)
Indoor unit	Total capacity		50~130% of heat source unit capacity
	Model / Quantity		Model 20~250/1~16
Noise level	*	dB<A>	52
Net weight	kg	280	
Operating temperature range		Indoor:15°CWB ~ 24°CWB Water :10°C ~ 45°C	Indoor:15°CDB ~ 27°CDB Water :10°C ~ 45°C

Note: 1.Cooling/heating capacity indicates the maximum value at operation under the following condition.

*1 **Cooling** Indoor : 27°CDB/19°CWB Water temperature : 30°C

Heating Indoor : 20°CDB Water temperature : 20°C

Pipe length : 7.5m Height difference : 0m

2.The ambient temperature of heat source unit has to be kept below 40°C (dry valve).

The ambient relative humidity of heat source unit has to be kept below 80%.

3.This unit can not be installed in the outdoor. (No protection against the weather.)

* It is measured in anechoic room.

WY(R407C)

2. Capacity Tables

2-1. Correction by temperature

Cooling

- Standard Specifications

		PQHY-P200	PQHY-P250
Capacity	kW	22.4	28.0
Input	kW	7.22	9.02

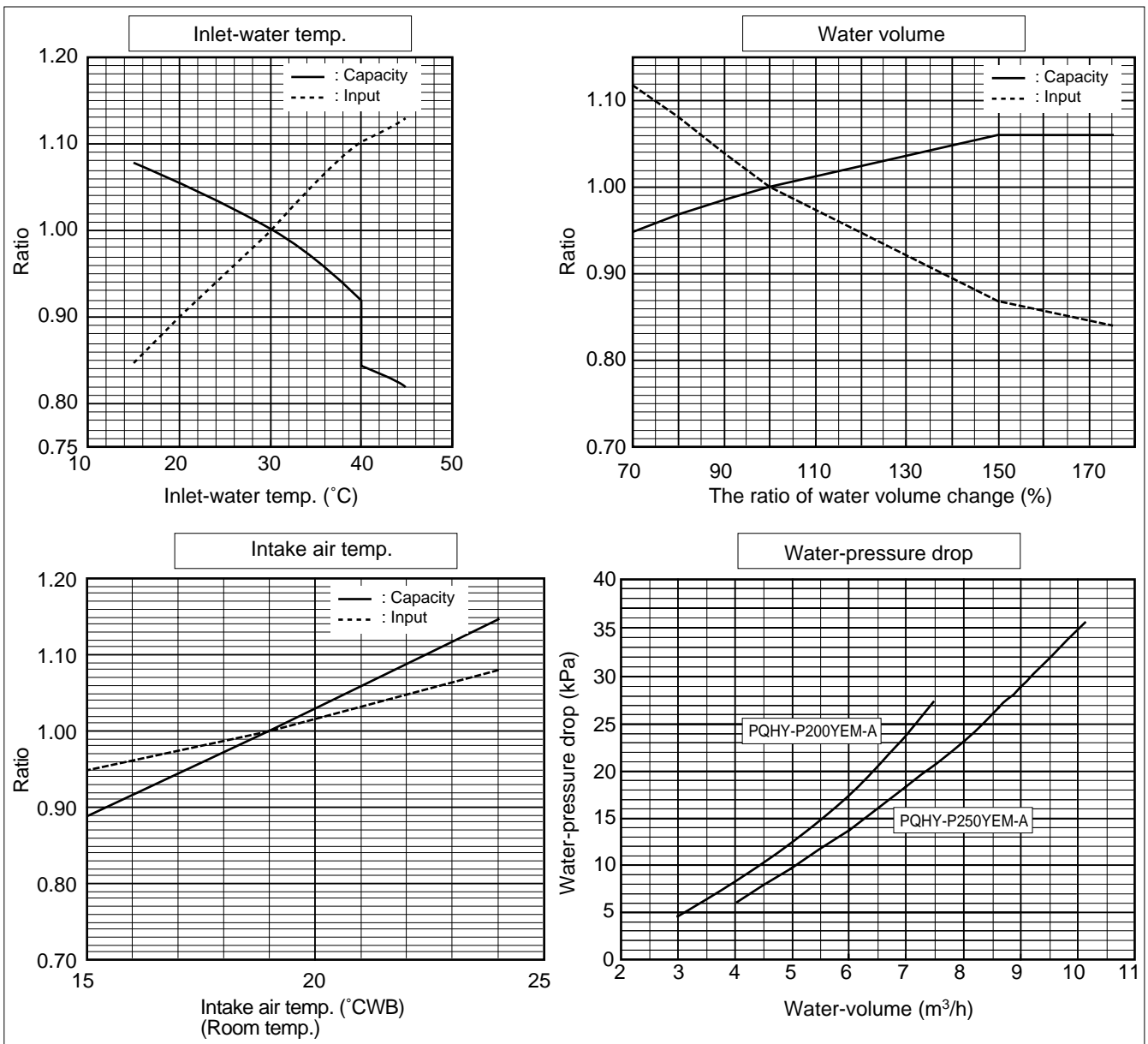

WY(R407C)

Heating

- Standard Specifications

		PQHY-P200	PQHY-P250
Capacity	kW	25.0	31.5
Input	kW	7.24	9.23

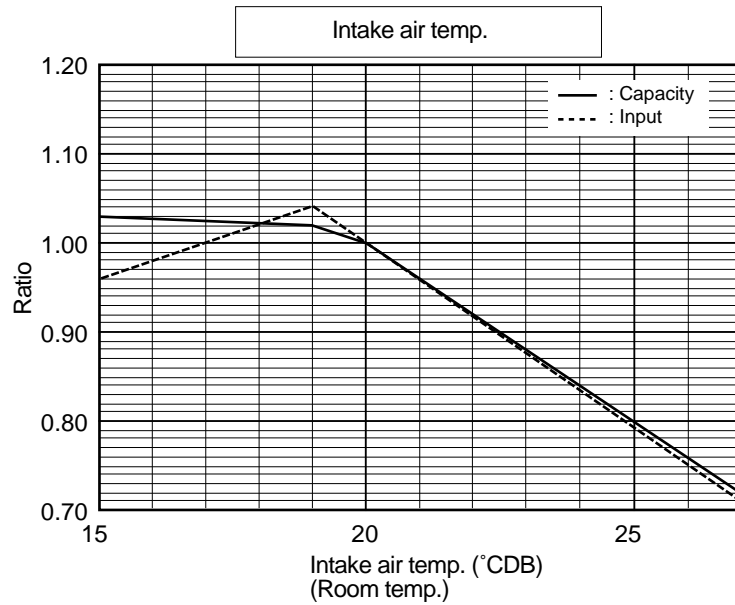
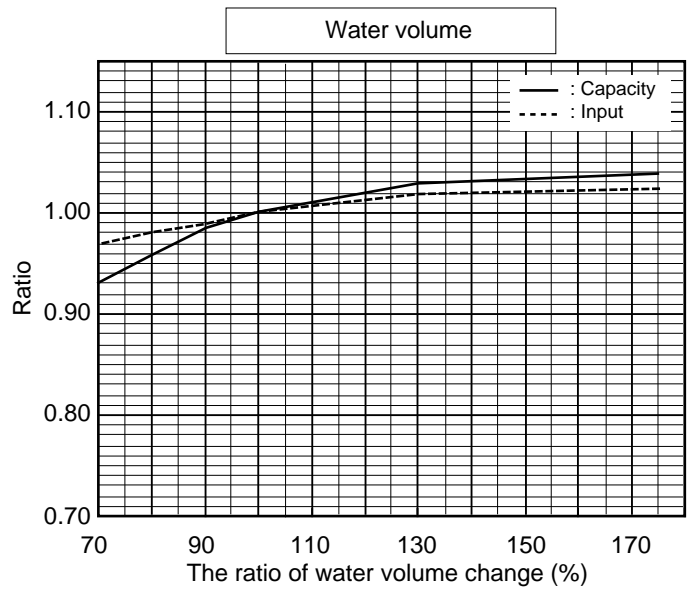
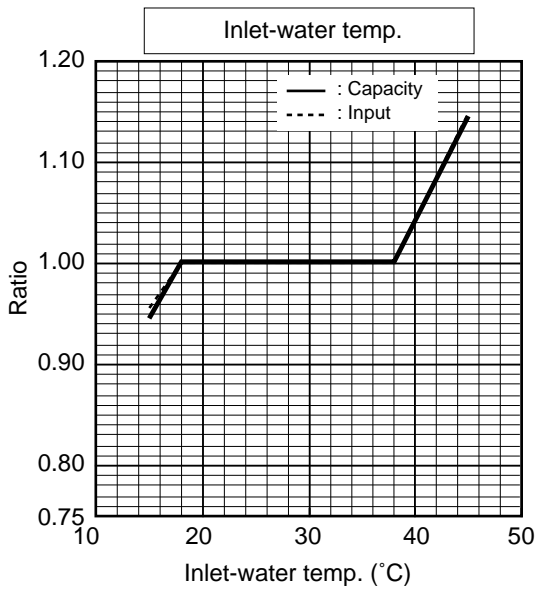

2-2. Correction by total indoor

PQHY-P200

1) Capacity

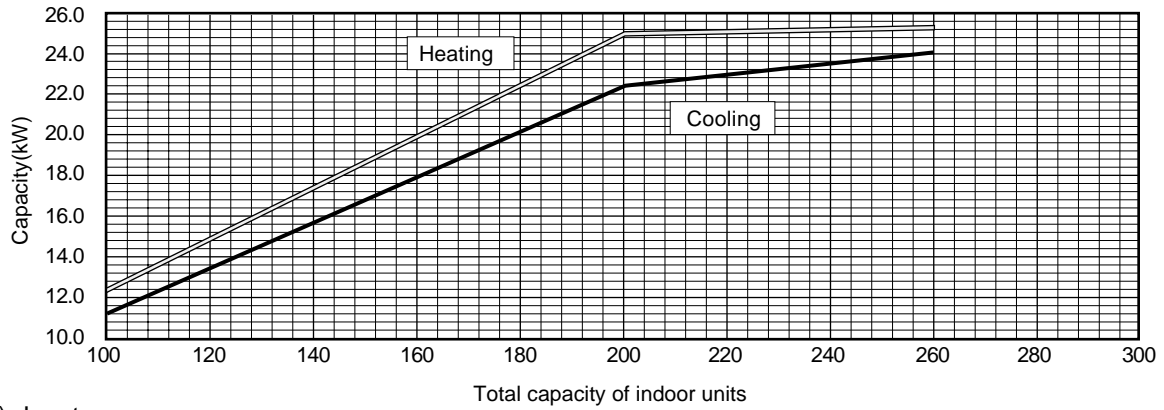

2) Input

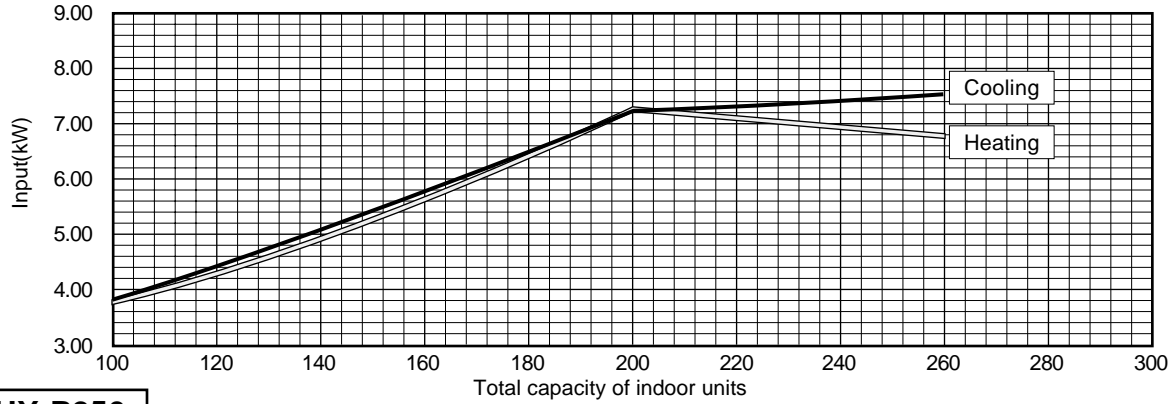

PQHY-P250

1) Capacity

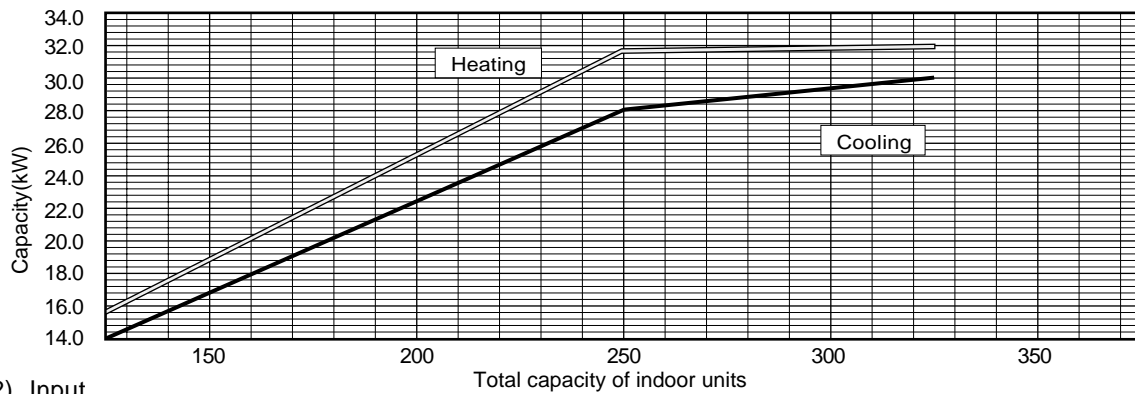

2) Input

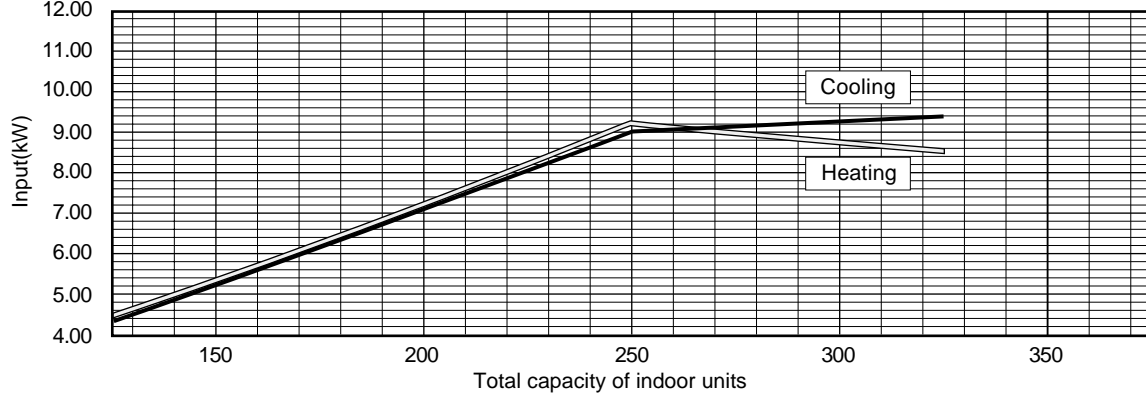

WY(R407C)

2-3. Correction by refrigerant piping length

To obtain a decrease in cooling/heating capacity due to refrigerant piping extension, multiply by the capacity correction factor based on the refrigerant piping equivalent length in the table below.

• Cooling capacity correction

PQHY-P200

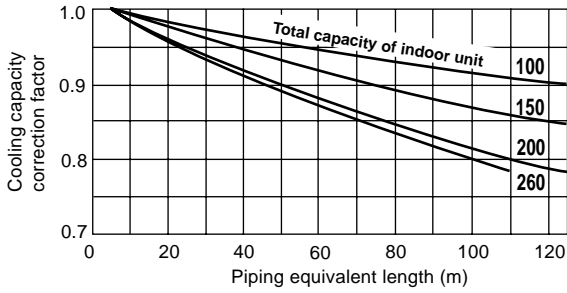

PQHY-P250

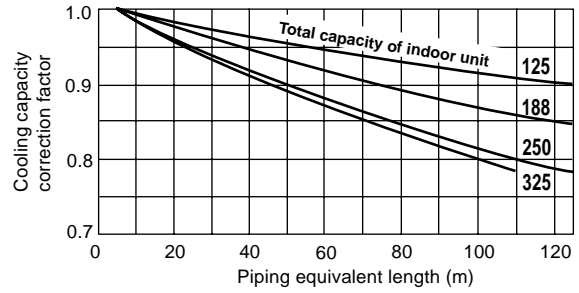

• Heating capacity correction

PQHY-P200

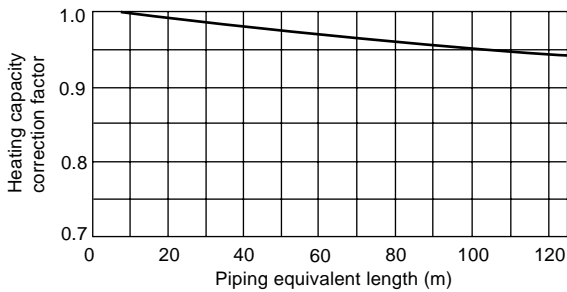

PQHY-P250

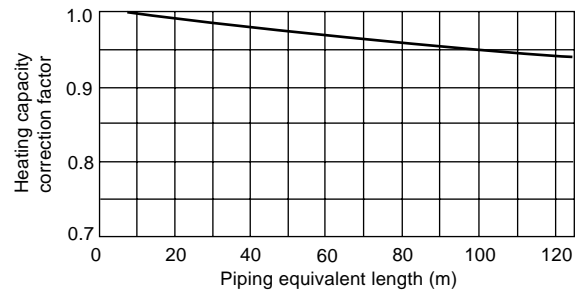

• How to obtain piping equivalent length

① PQHY-P200

Equivalent length = (Actual piping length to the farthest indoor unit) + (0.47 × number of bent on the piping)m

② PQHY-P250

Equivalent length = (Actual piping length to the farthest indoor unit) + (0.50 × number of bent on the piping)m

2-4. Operation limit

• Cooling

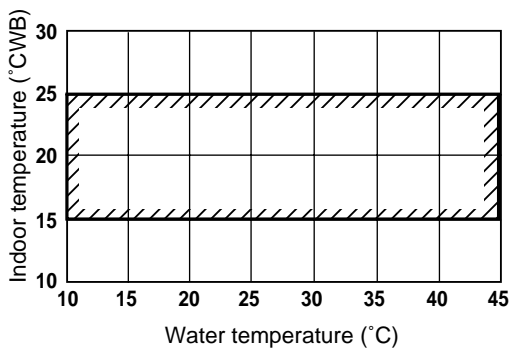

• Heating

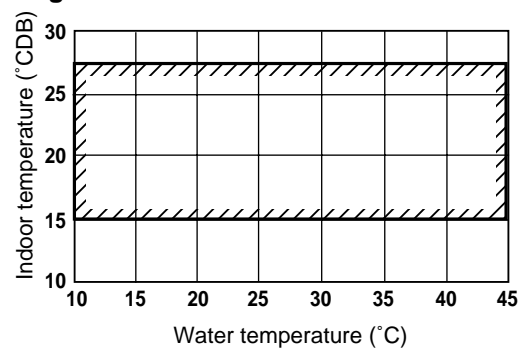

3. Sound Levels

PQHY-P200

Measurement condition

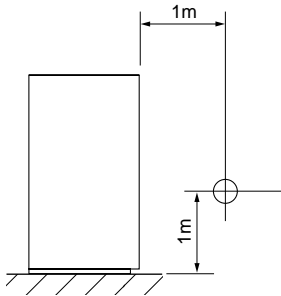

Sound pressure level in anechoic room
51 dB (A)

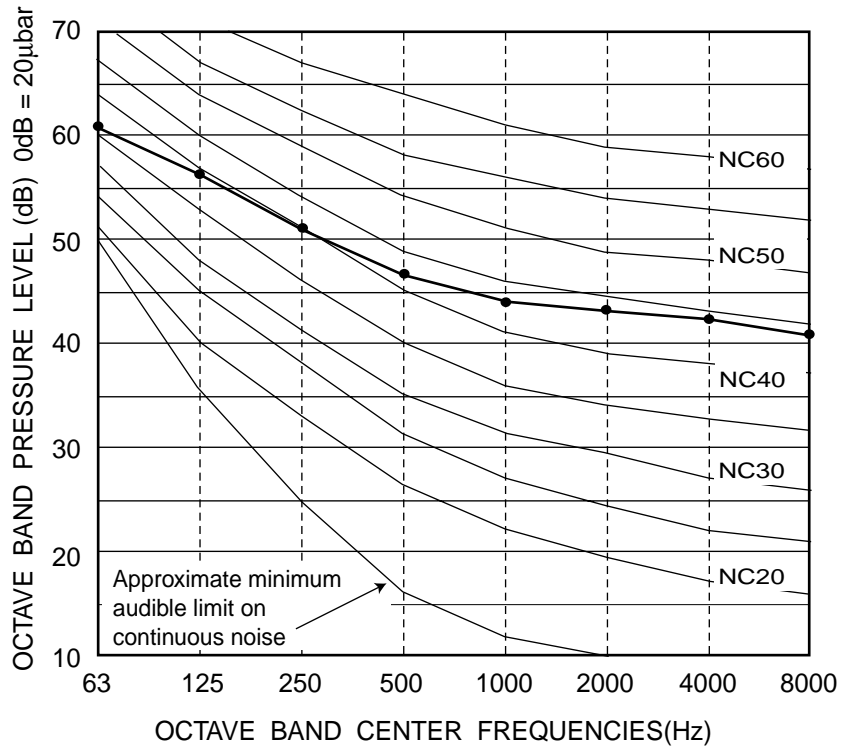

PQHY-P250

Measurement condition

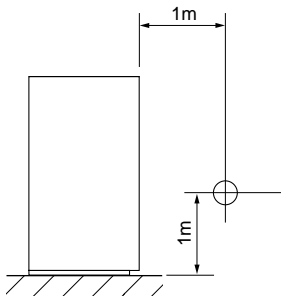

Sound pressure level in anechoic room
52 dB (A)

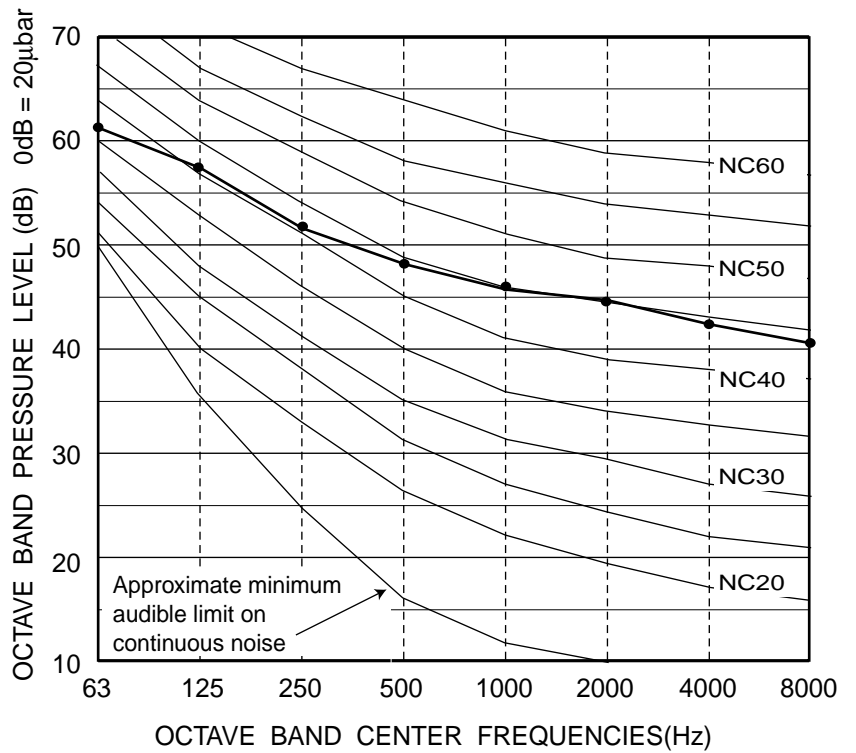

4. External Dimensions

PQHY-P200,250YEM-A

Unit : mm

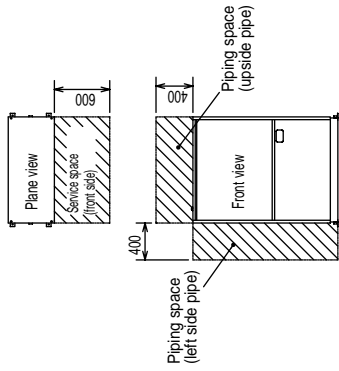
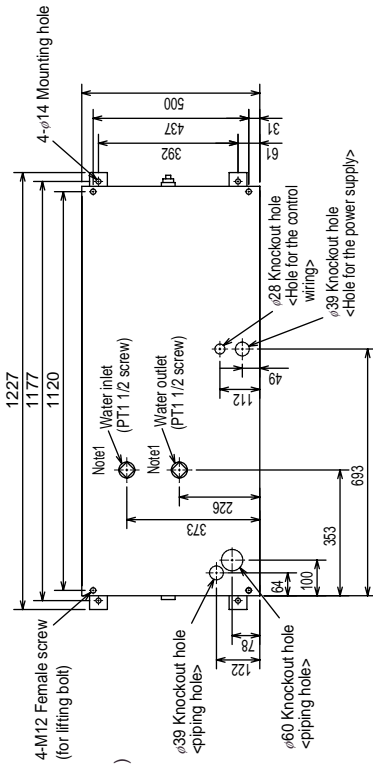
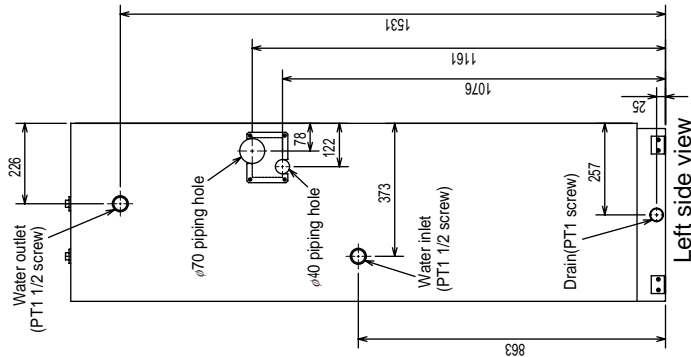

Fig. A



Plane view



Left side view

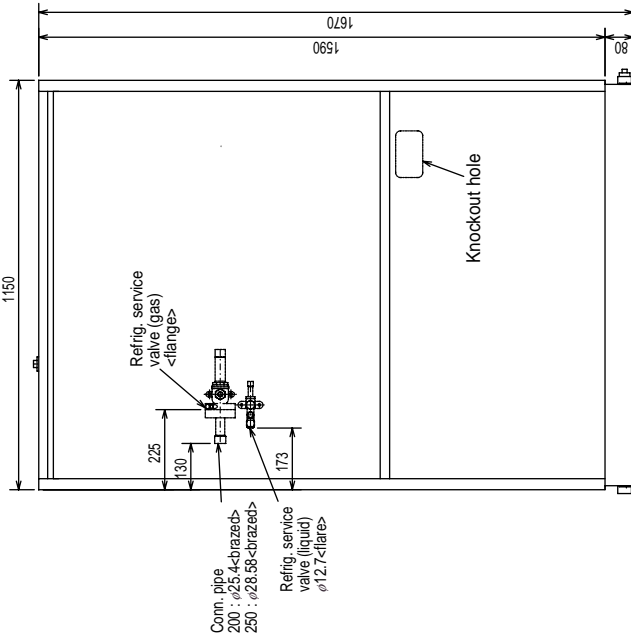

Front view

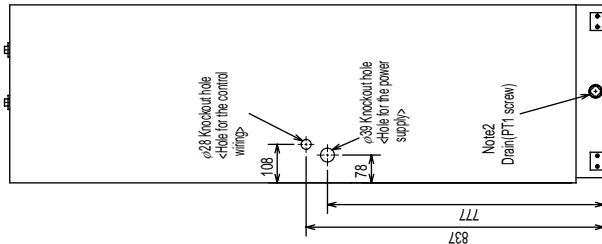

Right side view

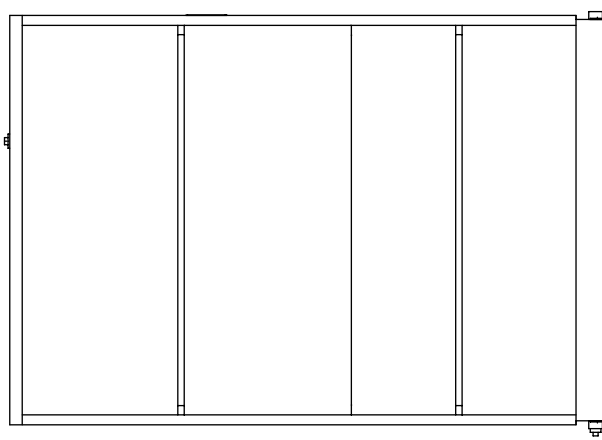

Rear view

- <Accessory>
- Refrigerant (gas) conn.pipe1pc.
(The connecting pipe is fixed with the unit)
- Packing for conn. pipe 1pc.
(Attached near the ball valve)
- Lifting bolt M12 4pcs.
- Bushing 2pcs.

- Note 1. At the time of product shipment, the left side piping specification serves as the local water piping connection. When connecting to the upper piping, please remove the plug sealing corks from the upper piping connection, and attach a left piping connection part.
Ensure there is no leak after the attachment has been fitted.
2. At the time of product shipment, the left side piping specification serves as the local drainage connection. When connecting on the right side, please remove the right side plug sealing corks, and attach a left side. Ensure there is no leak after the attachment has been fitted.
3. Take notice of service space as Fig A.

WY(R407G)

5. Electrical Wiring Diagram

PQHY-P200, 250YEM-A

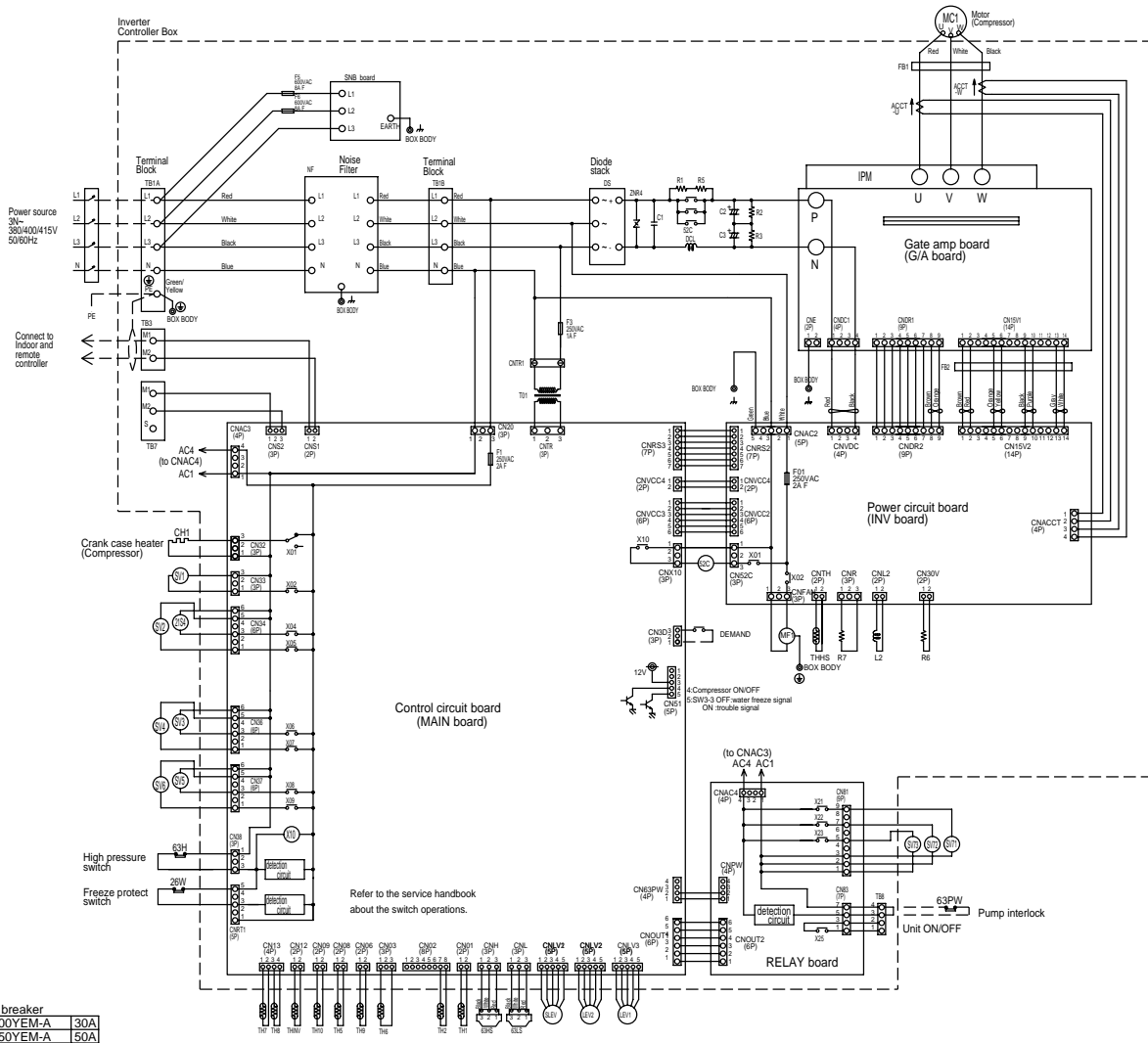

no fuse breaker	
PQHY-P200YEM-A	30A
PQHY-P250YEM-A	50A

<Operation of self-diagnosis switch(SW1)and LED display>

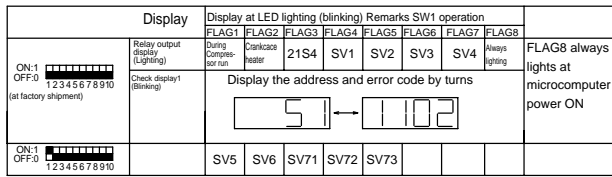

*Please refer to the service handbook about other switch settings of LED display.

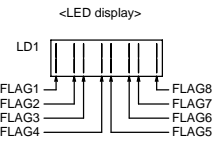

<Symbol explanation>

Symbol	Name
DCL	DC reactor (Power factor improvement)
ACCT-U,W	Current Sensor
ZNR4	Varistor
52C	Magnetic contactor (Inverter main circuit)
MF1	Fan motor (Radiator panel)
21S4	4-way valve
SV1,SV2	Solenoid valve (Discharge-suction bypass)
SV3~6	Solenoid valve (Heat exchanger capacity control)
SV71~73	Solenoid valve (Heat exchanger capacity control)
LEV1	Electronic expansion valve (Sub-cool coil bypass)
LEV2	Electronic expansion valve (Heat exchanger for inverter)
SLEV	Electronic expansion valve(Oil return)
63HS	High pressure sensor
63LS	Low pressure sensor
L2	Choke coil(Transmission)
IPM	Intelligent power module
TH1	Thermistor Discharge pipe temp. detect
TH2	Saturation evapo. temp. detect
TH5	Pipe temp. detect
TH6	OA temp. detect
TH7	liquid outlet temp. detect at Sub-cool coil
TH8	bypass outlet temp. detect at Sub-cool coil
TH9	High pressure liquid temp.
TH10	Compressor shell temp.
THINV	Outlet temp. detect of heat exchanger for inverter
THHS	Radiator panel temp. detect
X1~10	Aux. relay
X21~25	Ferrite core
FB1~2	Ferrite core
⊕	Earth terminal

<Controller box internal layout> (Upside)

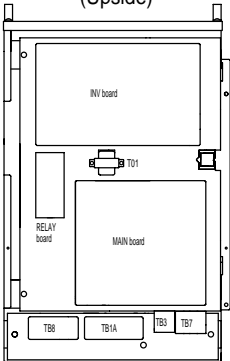

(Underside)

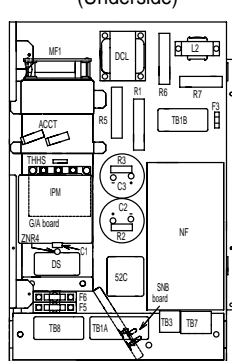

<Unit internal layout> (Upside)

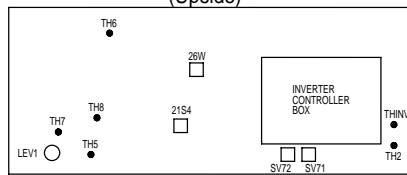

(Underside)

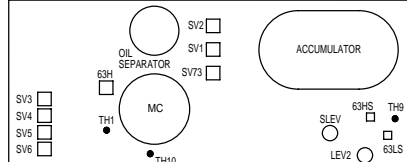

WY(R407C)

6. Refrigerant Circuit Diagram And Thermal Sensor

PQHY-P200, 250

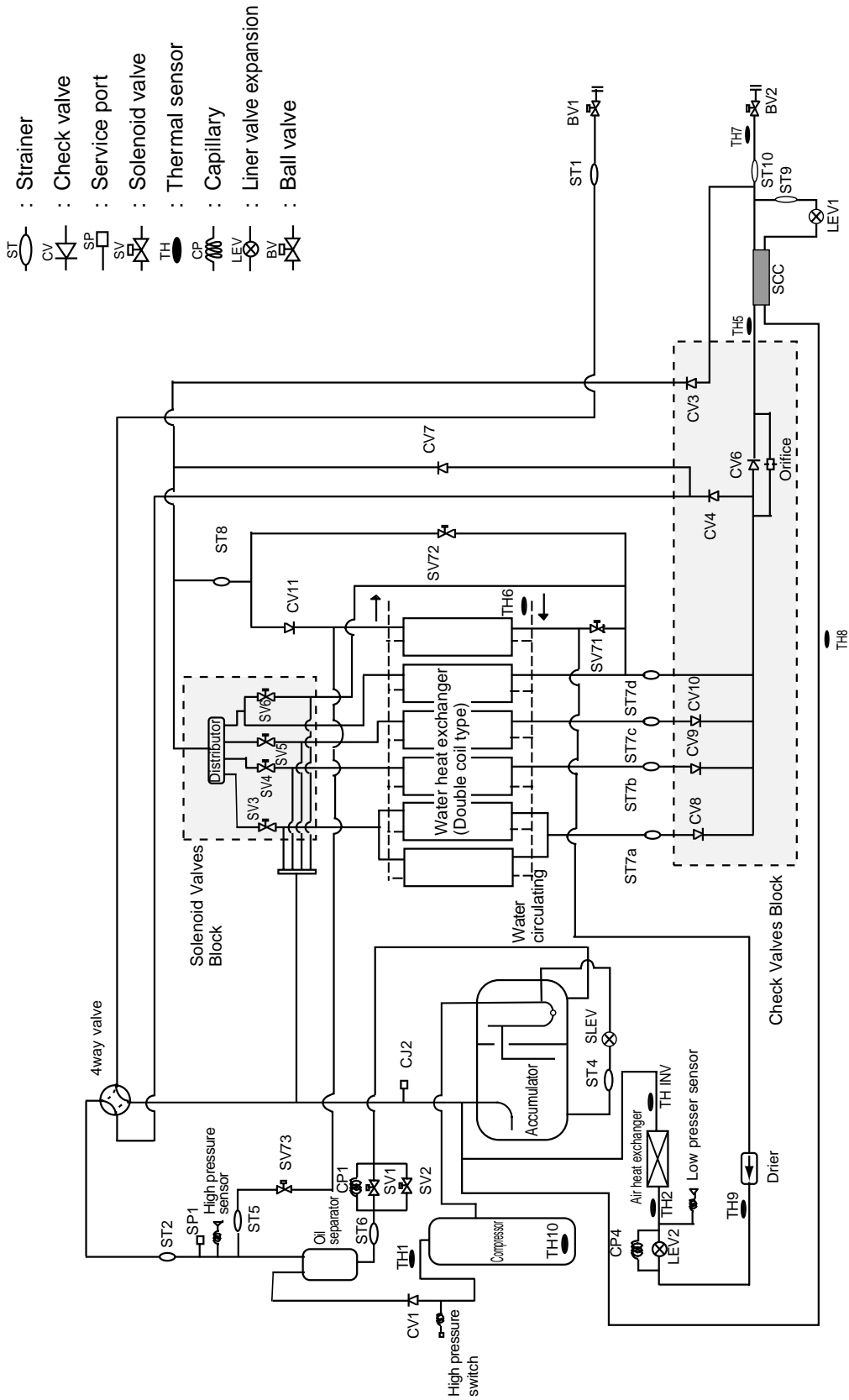

7. System design guide

7-1. Designing of water circuit system

1) Example of basic water circuit

The water circuit of the water heat source CITY MULTI connects the heat source unit with the cooling tower/auxiliary heat source/heat storage tank/circulation pump with a single system water piping as shown in the figure below. The selector valve automatically controls to circulate water toward the cooling tower in the cooling season, while toward the heat storage tank in the heating season. If the circulation water temperature is kept in a range of 10~45°C* regardless of the building load, the water heat source CITY MULTI can be operated for either cooling or heating. Therefore in the summer when only cooling load exists, the temperature rise of circulation water will be suppressed by operating the cooling tower. While in the winter when heating load increases, the temperature of circulation water may be dropped below 10°C. Under such situation, the circulation water will be heated with the auxiliary heat source if it drops below a certain temperature.

When the thermal balance between cooling and heating operation is in a correct proportion, the operation of the

auxiliary heat source and cooling tower is not required. In order to control the above thermal balance properly and use thermal energy effectively, utilizing of heat storage tanks, and night-time discounted electric power as an auxiliary heat source will be economical.

Meantime as this system uses plural sets of heat source unit equipped with water heat exchangers, water quality control is important. Therefore it is recommended to use closed type cooling towers as much as possible to prevent the circulation water from being contaminated.

When open type cooling towers are used, it is essential to provide proper maintenance control such as that to install water treatment system to prevent troubles caused by contaminated circulation water.

*10~45°C : 50%~130% of indoor units can be connected

Example of basic water circuit for water heat source CITY MULTI

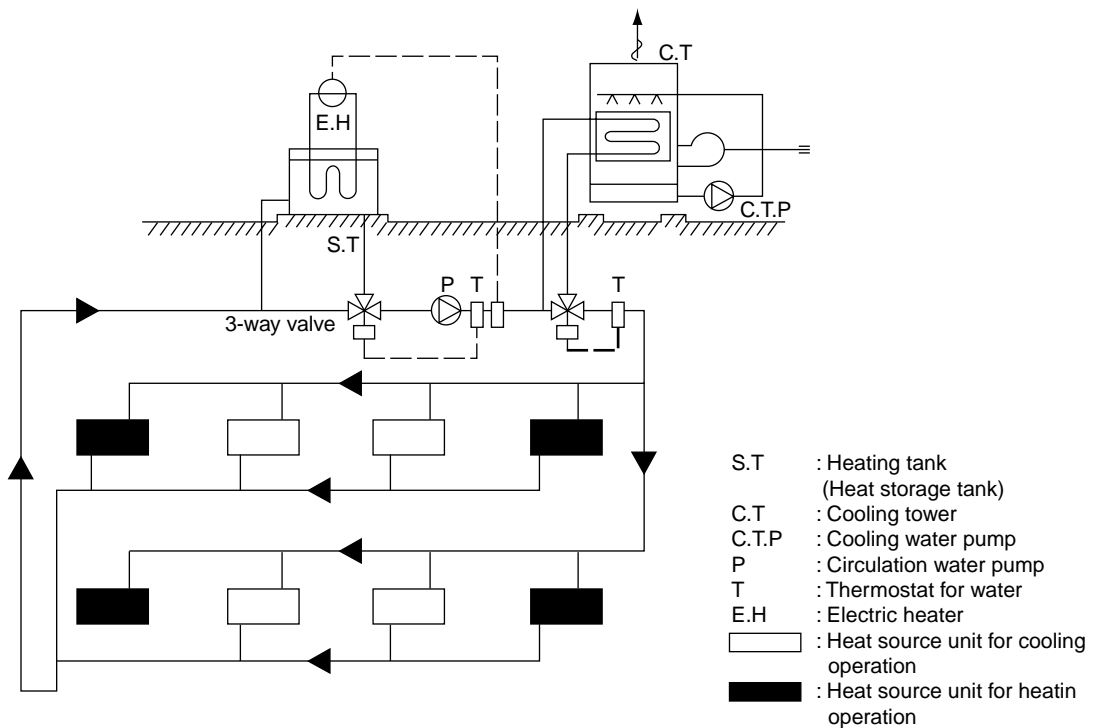

The indoor unit and refrigerant piping system are excluded in this figure.

WY(R407C)

2) Cooling tower

a) Types of cooling tower

The cooling towers presently used include the open type cooling tower, open type cooling tower + heat exchanger, closed type cooling tower, and air-cooled type cooling tower. However, as the quality control of circulation water is essential when units are installed in decentralized state inside a building, the closed type cooling tower is generally employed in such case.

Although the circulation water will not be contaminated by atmospheric air, it is recommended to periodically blow water inside the system and replenish fresh water instead.

In a district where the coil may be frozen in the winter, it is necessary to apply antifreeze solution to the circulation water, or take freeze protection measures such as to automatically discharge water inside the cooling coil at the stopping of the pump.

When the open type cooling tower is used, be sure to install a water quality control device in addition to the freeze protection measures, as the water may be deteriorated by atmospheric contaminants entered into the cooling tower and dissolved into the circulation water.

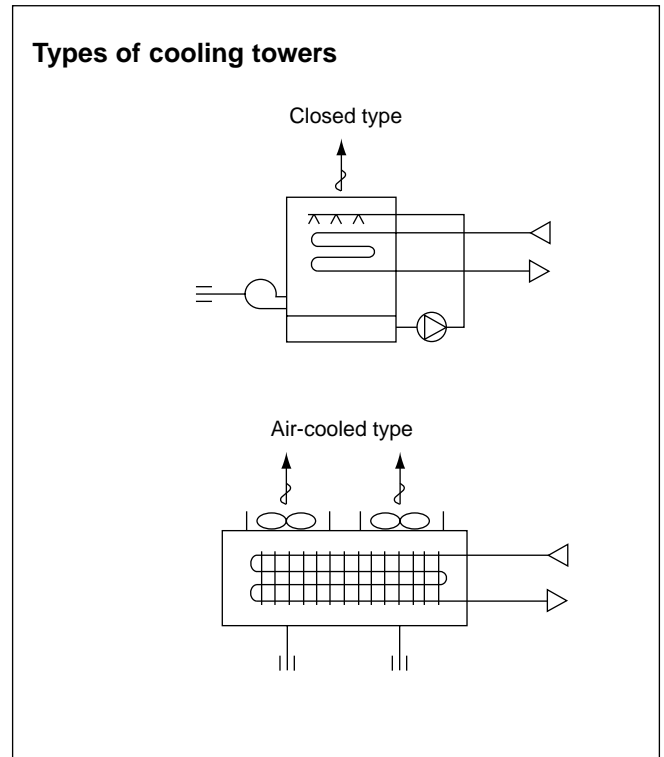

b) Calculation method of cooling tower capacity

All units of the water heat source CITY MULTI may possibly be in cooling operation temporarily (at pulling down) in the summer, however, it is not necessary to determine the capacity according to the total cooling capacity of all CITY MULTI units as this system has a wide operating water temperature range (10~45°C).

It is determined in accordance with the value obtained by adding the maximum cooling load of an actual building, the input heat equivalent value of all CITY MULTI units, and the cooling load of the circulating pumps. Please check for the values of the cooling water volume and circulation water volume.

$$\text{Cooling tower capacity} = \frac{Q_c + 860 \times (\sum Q_w + R_w)}{3,900} \quad (\text{Refrigeration ton})$$

- Q_c** : Maximum cooling load under actual state (kcal/h)
Q_w : Total input of water heat source CITY MULTI at simultaneous operation under maximum state (kW)
P_w : Shaft power of circulation pumps (kW)

3) Auxiliary heat source and heat storage tank

When the heating load is larger than the cooling load, the circulation water temperature lowers in accordance with the heat balance of the system. It should be heated by the auxiliary heat source in order to keep the inlet water temperature within the operating range (10°C or more).

of the water heat source CITY MULTI.

Further in order to operate the water heat source CITY MULTI effectively, it is recommended to utilize the heat storage tank to cover the warming up load in the morning and the insufficient heat amount.

Effective heat utilization can be expected to cover insufficient heat at the warming up in the next morning or peak load time by storing heat by installing a heat storage tank or operating a low load auxiliary heat source at the stopping of the water heat source CITY MULTI. As it can also be possible to reduce the running cost through the heat storage by using the discounted night-time electric power, using both auxiliary heat source and heat storage tank together is recommended.

The effective temperature difference of an ordinary heat storage tank shows about 5deg. even with the storing temperature at 45°C.

However with the water heat source CITY MULTI, it can be utilized as heating heat source up to 15°C with an effective temperature of a high 30deg. approximately, thus the capacity of the heat storage tank can be minimized.

a)Auxiliary heat source

The following can be used as the auxiliary heat source.

- Boiler (Heavy oil, kerosine, gas, electricity)
- Electric heat (Insertion of electric heater into heat storage tank)
- Outdoor air (Air-heat source heat pump chiller)
- Warm discharge water (Exhaust water heat from machines inside building and hot water supply)
- Utilization of night-time lighting
- Solar heat

Please note that the auxiliary heat source should be selected after studying your operating environment and economical feasibility.

Determining the auxiliary heat source capacity

For the CITY MULTI water heat source system, a heat storage tank is recommended to use. When employment of the heat storage tank is difficult, the warming up operation should be arranged to cover the starting up heating load. Since the holding water inside the piping circuit owns heat capacity and the warming up operation can be assumed for about one hour except that in a cold region, the heat storage tank capacity is required to be that at the maximum daily heating load including the warming up load at the next morning of the holiday.

However the auxiliary heat source capacity should be determined by the daily heating load including warming up load on the week day.

For the load at the next morning of the holiday, heat storage is required by operating the auxiliary heat source even outside of the ordinary working hour.

When heat storage tank is not used

$$QH = HC_T \left(1 - \frac{1}{COP_h} \right) - 1000 \times V_w \times \Delta T - 860 \times P_w$$

QH	: Auxiliary heat source capacity	(kcal/h)
HC _T	: Total heating capacity of each water heat source CITY MULTI	(kcal/h)
COP _H	: COP of water heat source CITY MULTI at heating	
V _w	: Holding water volume inside piping	(m ³)
ΔT	: Allowable water temperature drop = T _{WH} - T _{WL}	(°C)
T _{WH}	: Heat source water temperature at high temperature side	(°C)
T _{WL}	: Heat source water temperature at low temperature side	(°C)
P _w	: Heat source water pump shaft power	(kW)

When heat storage tank is used;

$$QH = \frac{HQ_{1T} \left(1 - \frac{1}{COP_h} \right) - 860 \times P_w \times T_2}{T_1} \times K \quad (\text{Kcal})$$

QH _{1T}	: Total of heating load on weekday including warming up	(kcal/day)
T ₁	: Operating hour of auxiliary heat source	(h)
T ₂	: Operating hour of heat source water pump	(h)
K	: Allowance factor (Heat storage tank, piping loss, etc.)	1.05~1.10

HQ_{1T} is calculated from the result of steady state load calculation similarly by using the equation below.
 $HQ_{1T} = 1.15 \times (\sum Q'a + \sum Q'b + \sum Q'c + \sum Q'd + \sum Q'f) T_2 - \psi (\sum Qe_1 + \sum Qe_2 + \sum Qe_3) (T_2 - 1)$

Q'a	: Thermal load from external wall/roof in each zone	(kcal/h)
Q'b	: Thermal load from glass window in each zone	(kcal/h)
Q'c	: Thermal load from partition/ceiling/floor in each zone	(kcal/h)
Q'd	: Thermal load by infiltration in each zone	(kcal/h)
Q'f	: Fresh outdoor air load in each zone	(kcal/h)
Q'e ₁	: Thermal load from human body in each zone	(kcal/h)
Q'e ₂	: Thermal load from lighting fixture in each zone	(kcal/h)
Q'e ₃	: Thermal load from equipment in each zone	(kcal/h)
ψ	: Radiation load rate	0.6~0.8
T ₂	: Air conditioning hour	

b) Heat storage tank

Heat storage tank can be classified by types into the open type heat storage tank exposed to atmosphere, and the closed type heat storage tank with structure separated from atmosphere. Although the size of the tank and its installation place should be taken into account, the closed type tank is being usually employed by con-

sidering corrosion problems.

The capacity of heat storage tanks is determined in accordance with the daily maximum heating load that includes warming up load to be applied for the day after the holiday.

When auxiliary heat source is operated during operation and even after stopping of water heat source CITY MULTI unit

$$V = \frac{HQ_{2T} \left(1 - \frac{1}{COP_h} \right) - 860 \times P_w \times T_2 - QH \times T_2}{\Delta T \times 1000 \times \eta V} \quad (\text{ton})$$

When auxiliary heat source is operated after stopping of water heat source CITY MULTI unit

$$V = \frac{HQ_{2T} \left(1 - \frac{1}{COP_h} \right) - 860 \times P_w \times T_2}{\Delta T \times 1000 \times \eta V} \quad (\text{ton})$$

HQ _{2T}	: Maximum heating load including load required for the day after the holiday (kcal/day)
ΔT	: Temperature difference utilized by heat storage tank (deg)
ηV	: Heat storage tank efficiency

$$HQ_{2T} : 1.3 \times (\sum Q'a + \sum Q'c + \sum Q'd + \sum Q'f) T_2 - \psi (\sum Qe_2 + \sum Qe_3) (T_2 - 1)$$

4) Piping system

The following items should be kept in your mind in planning / designing water circuits.

- a) All units should be constituted in a single circuit in principle.
- b) When plural numbers of the water heat source CITY MULTI unit are installed, the rated circulating water flow rate should be kept by making the piping resistance to each unit almost same value. As an example, the reverse return system as shown below may be employed.
- c) Depending on the structure of a building, the water circuit may be prefabricated by making the layout uniform.
- d) When a closed type piping circuit is constructed, install an expansion tank usable commonly for a make-up water
- e) If the operating temperature range of circulation water stays within the temperature near the normal temperature (summer : 30°C, winter : 20°C), thermal insulation or anti-sweating work is not required for the piping inside buildings.

In case of the conditions below, however, thermal insulation is required.

- When well water is used for heat source water.
- When piped to outdoor or a place where freezing may be caused.
- When vapor condensation may be generated on piping due to an increase in dry bulb temperature caused by the entry of fresh outdoor air.

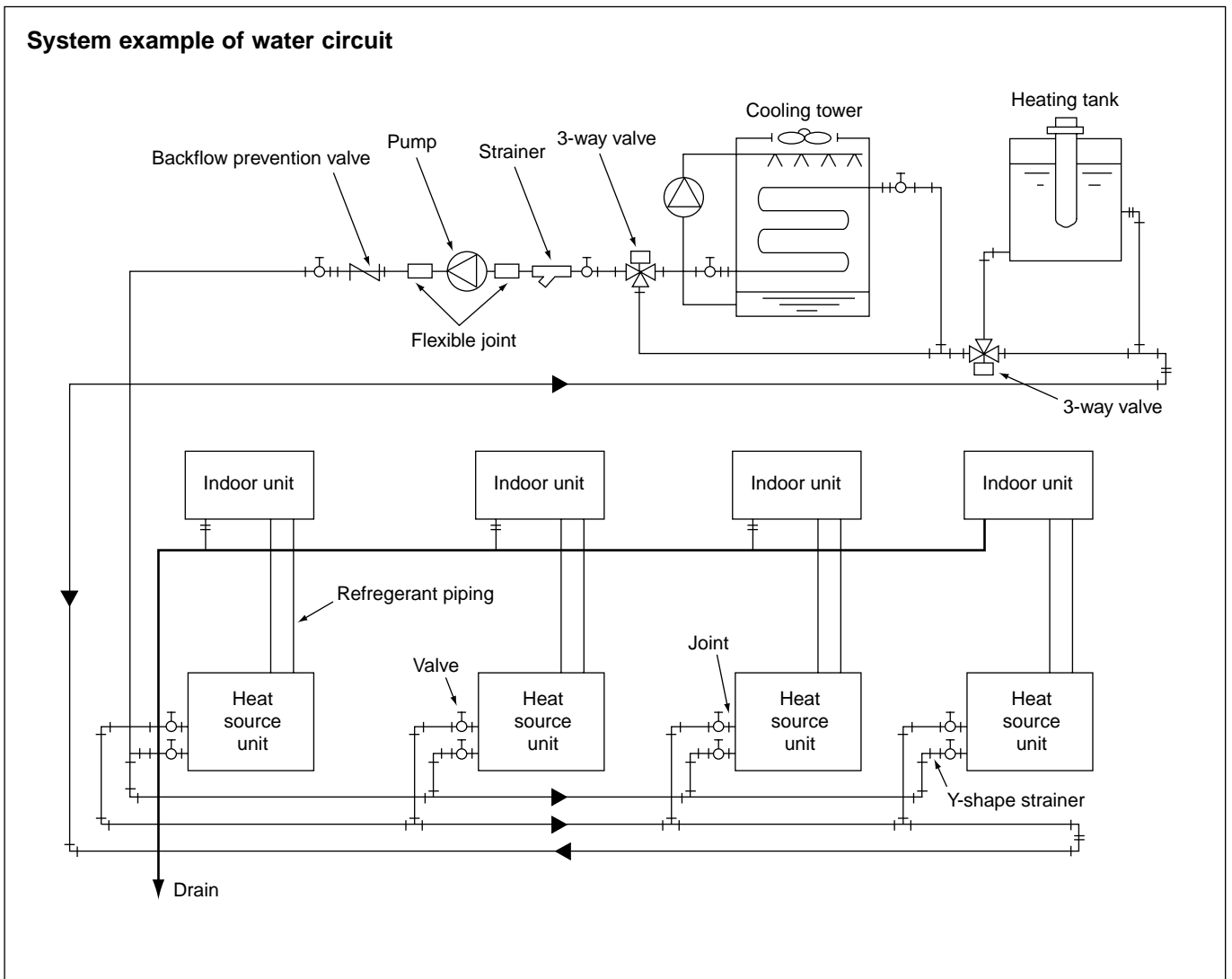

WY(R407C)

5) Cleaning of water heat exchanger

For the water heat exchanger, scale adheres in less amount generally in the case of closed type cooling towers. However in a long period of use, scale will adhere that may lower the heat exchange capacity and increase the water resistance.

In such case, conduct cleaning work under the procedure given below.

procedure given below.

The cleaning work procedure generally used is as follows. However as the cleaning agents have various differences in their cleaning effect, corrosion characteristics, processing time, and condensation for use, conduct the work after consulting the relating maker.

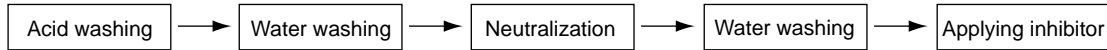

a) Still standing method

This method feeds the raw liquid or diluted solution of cleaning agent into the water circuit and leave it for a while, and requires only a simple device.

- Since the cleaning time required differs by the agent of each maker, be sufficiently careful for the time and not to exceed the time specified.

- Fully recover the cleaning liquid through the water discharge plug of the heat exchanger, and then fully clean the water circuit with clean water. If the water washing can not be made sufficiently, neutralization processing will be effective.

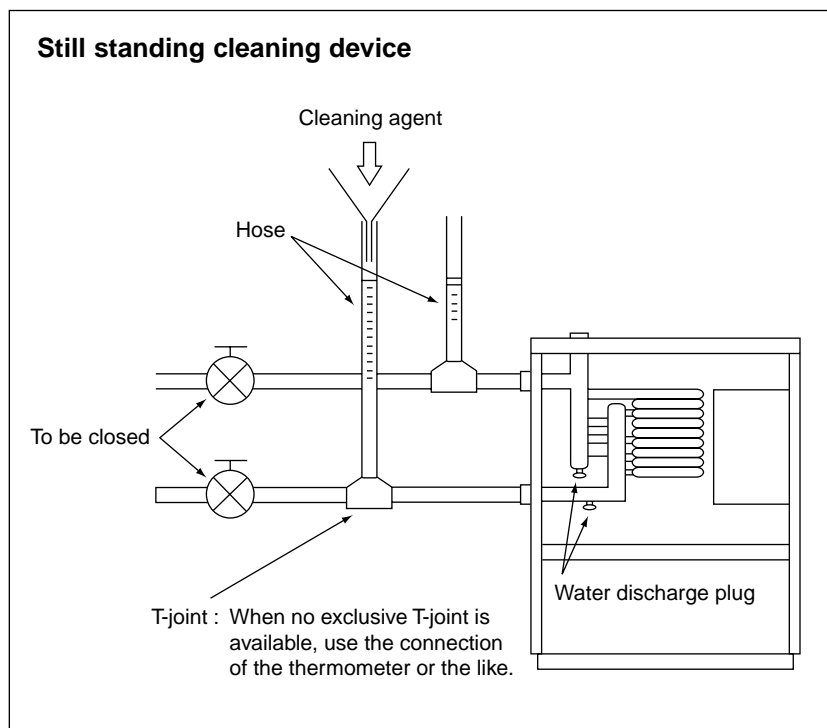

b) Circulation method

Although this method can clean in shorter time than that required by the still standing method, be careful that the circulation pump may be damaged if using cleaning agent with strong corrosive characteristics.

- After completing washing work, fully recover the washing liquid through the water discharge plug installed at the bottom of the piping and that at the heat exchanger.
- Conduct water washing for three times or more after removing cleaning agent. If this can not be made satisfactorily, apply neutralization treatment. Full replacement of water can be ascertained by measuring the PH of the water.
- Note that it may be required to control the cleaning time depending on the scale generation or water quality.
- At cleaning work, remove or shut down the instruments like water pressure gauges so that the cleaning liquid will not enter into them.
- Check for the connections of piping beforehand so that cleaning agent will not leak from the piping during cleaning work.
- Start cleaning operation after fully mixing the cleaning agent with water.
- Cleaning at the earlier timing is recommended as the removal of scale will be difficult if it has accumulated seriously. Periodical cleaning is necessary in a district with inferior water quality.
- Conduct water washing sufficiently with clear water after cleaning work as all cleaning agents own strong acidity.
- To verify the completion of cleaning, remove the hose and observe the inner wall of the piping whether it is clean.
- Be sufficiently careful for fire when using inflammable cleaning agent (GOSPEL R).

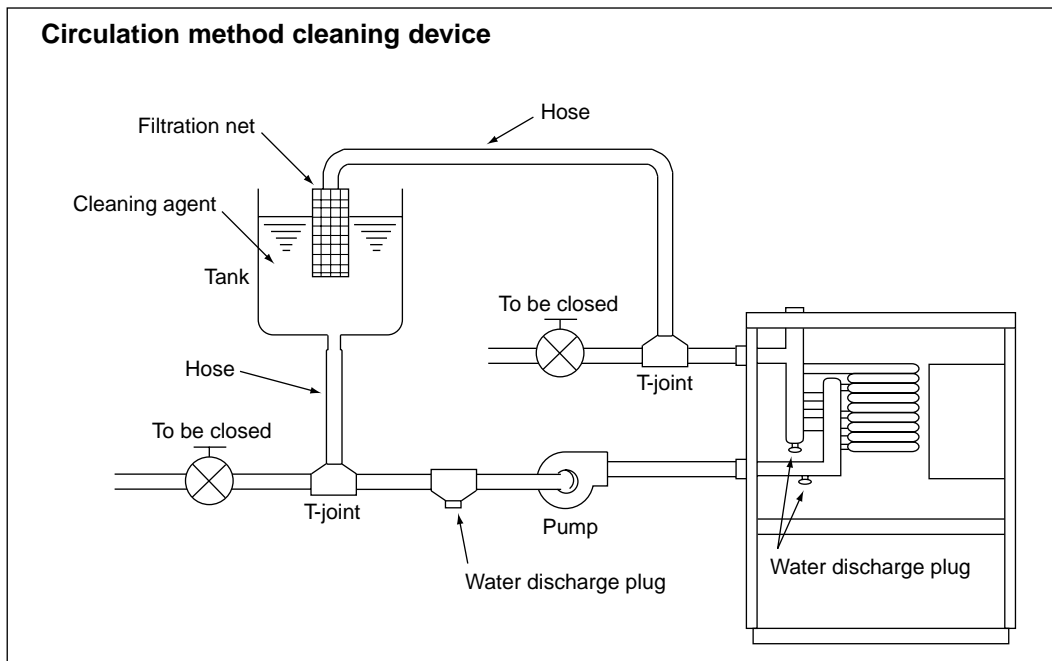

Example of cleaning agents

Name	Shape	Condensation	Time	Makers
CLEARLITE RK	Powder/Liquid	10~20%	2~3Hr.	Koei Kagaku
CLEARLITE ACE	Powder/Liquid	3~5%	1~3Hr.	Koei Kagaku
GOSPEL R	Liquid	7% (Upper limit 10%, lower limit 5%)	1~4Hr.	Gospel Kako
GOSPEL SR	Powder			Marusan
ADDITION DR	Powder			Seiwa kogyo
SS-100	Liquid			Saver Kagaku
NEOLUX F	Powder	4~7%		
DISCALER	Powder			

6) Practical System Examples and Circulation Water Control

Since the water heat source CITY MULTI is of water heat source system, versatile systems can be constituted by combining it with various heat sources.

The practical system examples are given below.

Either cooling or heating operation can be performed if the circulation water temperature of the water heat

source CITY MULTI stays within a range of 10~45°C. However, the circulation water temperature near 32°C for cooling and 20°C for heating is recommended by taking the life, power consumption and capacity of the air conditioning units into consideration. The detail of the control is also shown below.

Example-1 Combination of closed type cooling tower and hot water heat storage tank (using underground hollow slab)

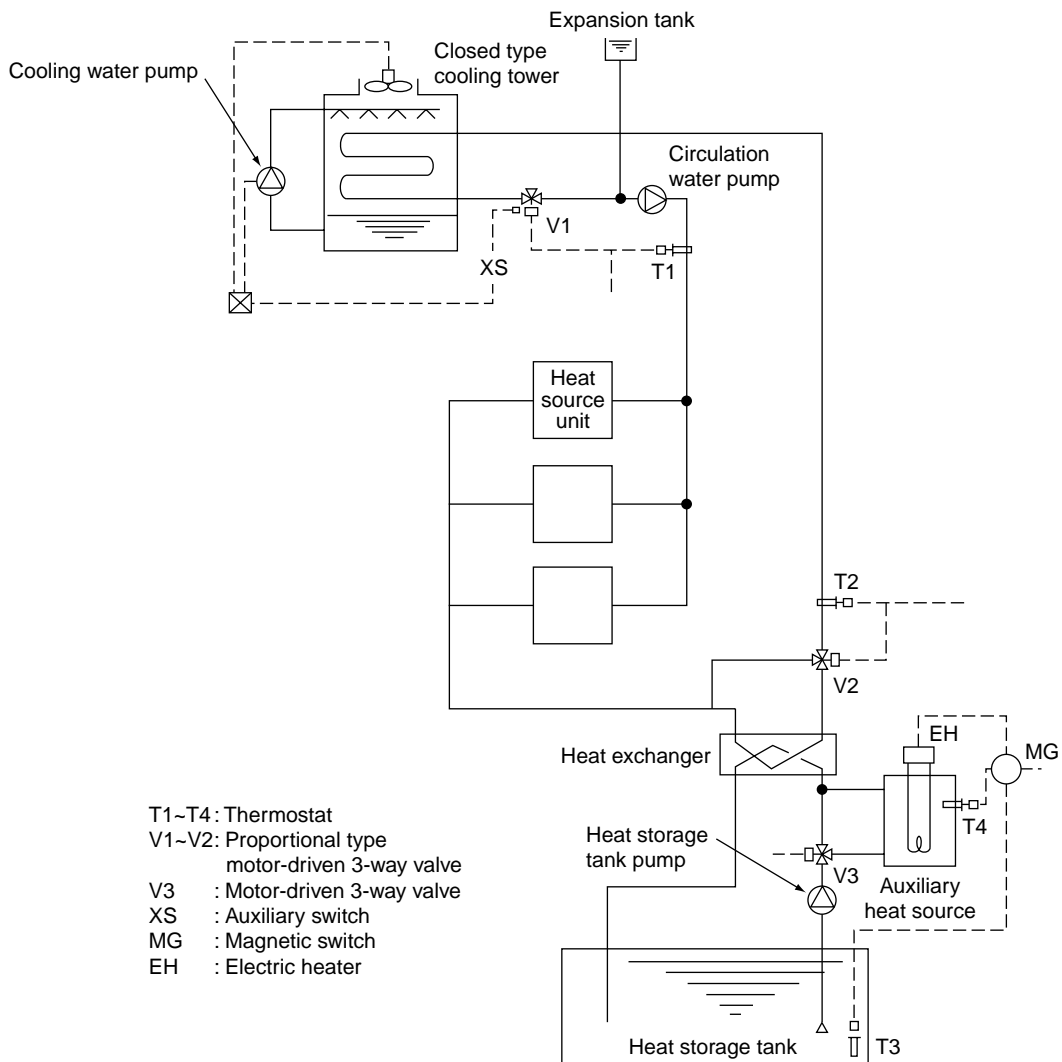

By detecting the circulation water temperature of the water heat source CITY MULTI system with T1 (around 32°C) and T2 (around 20°C), the temperature will be controlled by opening/closing V1 in the summer and V2 in the winter.

In the summer, as the circulation water temperature rises exceeding the set temperature of T1, the bypass port of V1 will open to lower the circulation water temperature. While in the winter, as the circulation water temperature drops, V2 will open following the command of T2 to rise the circulation water temperature.

The water inside the heat storage tank will be heated by the auxiliary heat source by V3 being opened with timer operation in the night-time. The electric heater of the auxiliary heat source will be controlled by T3 and the timer. The start/stop control of the fan and pump of the closed type cooling tower is applied with the step control of the fan and pump following the command of the auxiliary switch XS of V1, that operates only the fan at the light load while the fan and pump at the maximum load thus controlling water temperature and saving motor power.

Example-2 Combination of closed type cooling tower and hot water heat storage tank

- T1 : Proportional type, insertion system thermostat
- T2 : Proportional type, insertion system thermostat
- T3 : Proportional type, insertion system thermostat
- V1 : Proportional type, motor-driven 3-way valve
- V2 : Proportional type, motor-driven 3-way valve
- XS : Auxiliary switch (Duplex switch type)
- SC : Step controller
- R : Relay
- MG : Magnetic

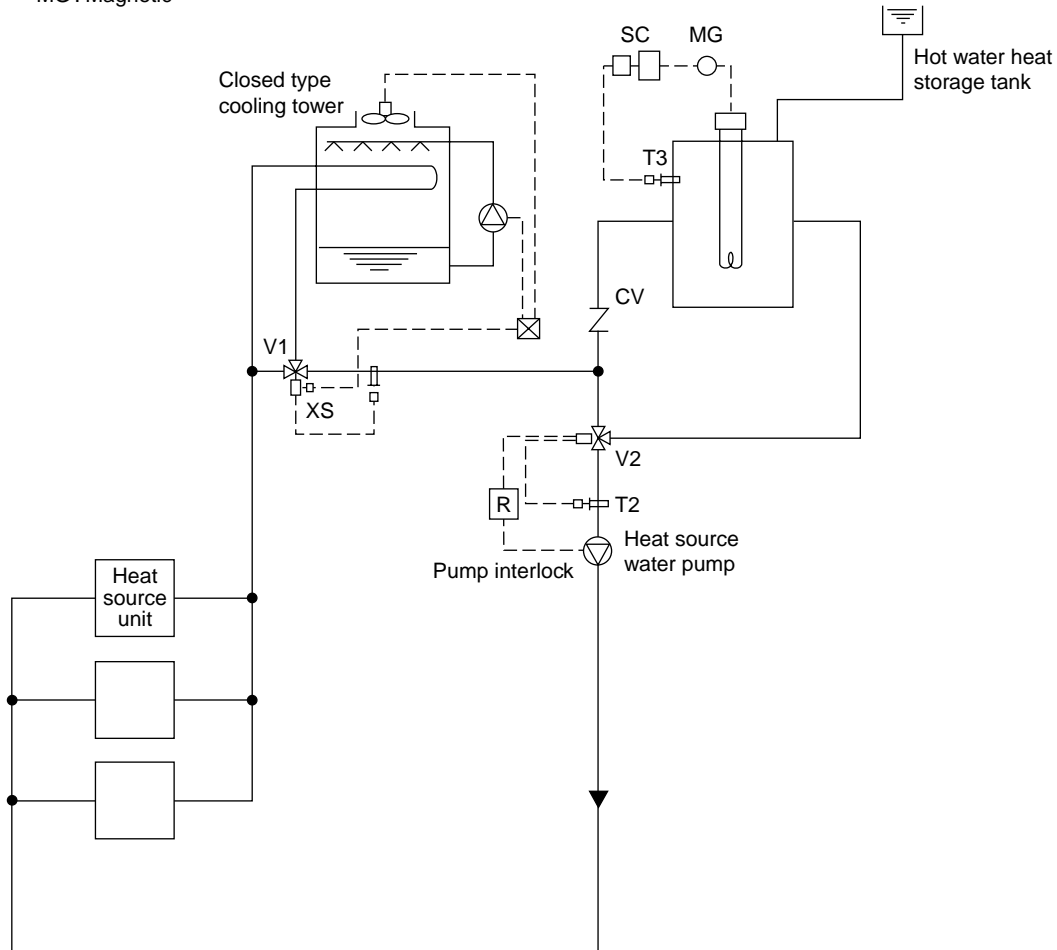

=In the summer, as the circulation water temperature rises exceeding the set temperature of T1, the bypass port of V1 will open to lower the circulation water temperature. In the winter, if the circulation water temperature stays below 25°C, V2 will open/close by the command of T2 to keep the circulation water temperature constant.

The temperature of the hot water inside the heat storage tank will be controlled through the step control of the electric heater by step controller operation following the command of T3.

During the stopping of the heat source water pump, the bypass port of V2 will be closed fully by interlocking thus preventing the high temperature water from entering into the system at the starting of the pump.

The start/stop control of the fan and pump of the closed type cooling tower is applied with the step control of the fan and pump following the command of the auxiliary switch XS of V1, that operates only the fan at the light load while the fan and pump at the maximum load thus controlling water temperature and saving motor power.

Example-3 Combination of closed type cooling tower and boiler

- T1 : Proportional type, insertion system thermostat
- T2 : Proportional type, insertion system thermostat
- T3 : Proportional type, insertion system thermostat
- V1 : Proportional type, motor-driven 3-way valve
- S : Selector switch
- R : Relay
- XS : Auxiliary switch (Duplex switch type)

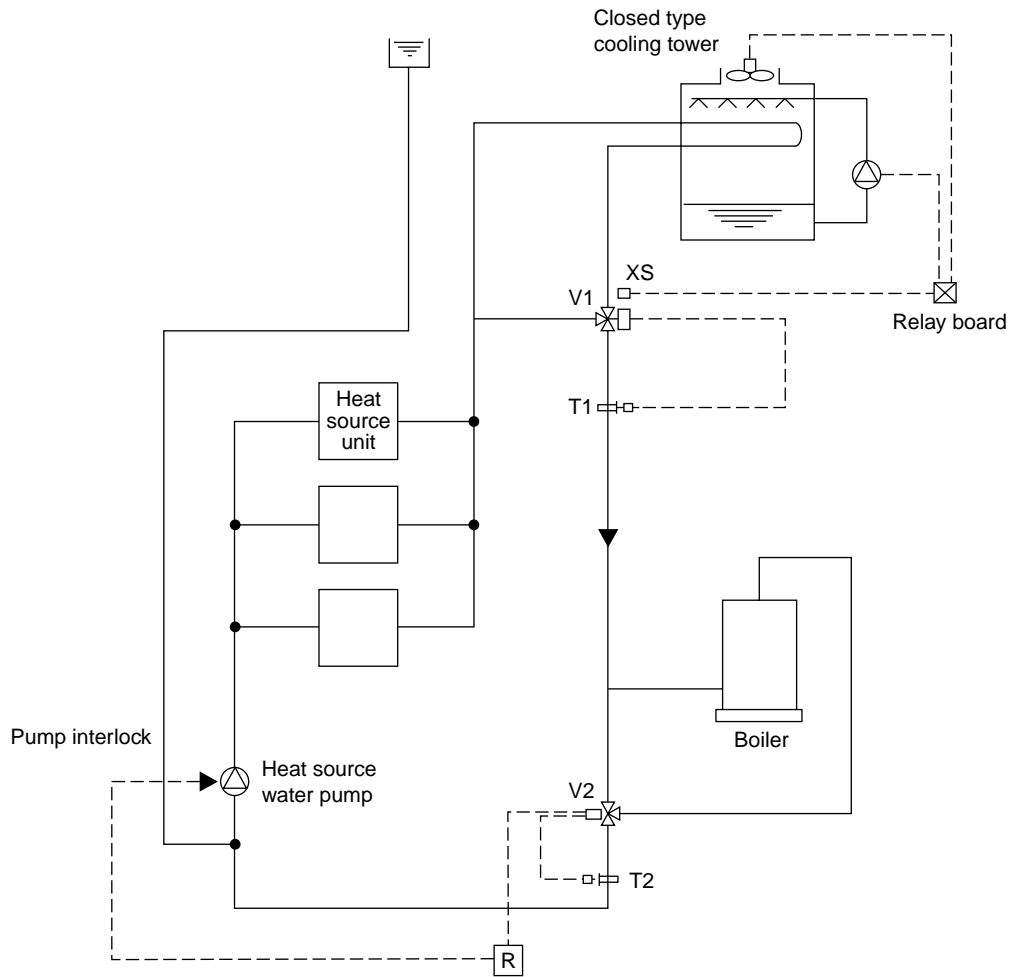

In the summer, as the circulation water temperature rises exceeding the set temperature of T1, the bypass port of V1 will close to lower the circulation water temperature. In the winter, if the circulation water temperature drops below 25°C, V2 will conduct water temperature control to keep the circulation water temperature constant.

During the stopping of the heat source water pump, the bypass port of V2 will be closed fully by interlocking.

The start/stop control of the fan and pump of the closed type cooling tower is applied with the step control following the command of the auxiliary switch XS of V1, thus controlling water temperature and saving motor power.

WY(R407G)

Example-4 Combination of closed type cooling tower and heat exchanger (of other heat source)

- T1 : Proportional type, insertion system thermostat
- T2 : Proportional type, insertion system thermostat
- V1 : Proportional type, motor-driven 3-way valve
- V2 : Proportional type, motor-driven 3-way valve
- S : Selector switch
- R : Relay
- XS : Auxiliary switch (Duplex switch type)

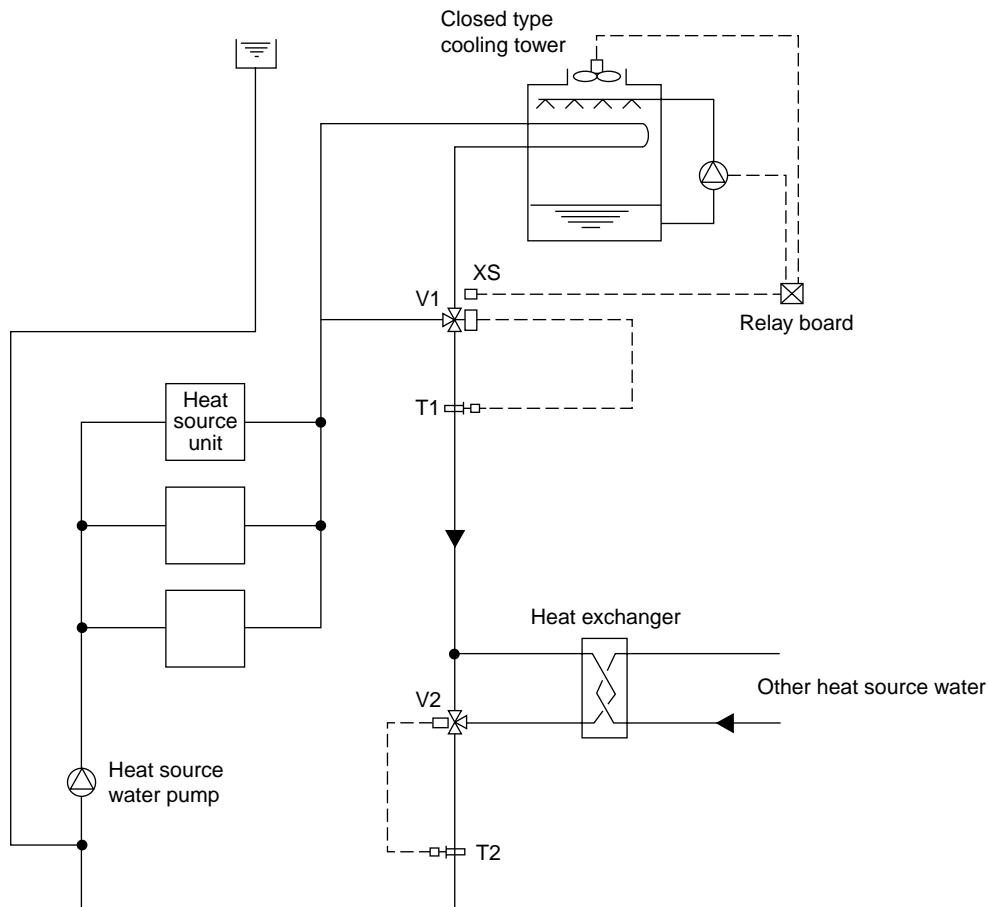

In the summer, as the circulation water temperature rises exceeding the set temperature of T1, the bypass port of V1 will close to lower the circulation water temperature. In the winter, if the circulation water temperature drops below 26°C, V2 will conduct water temperature control to keep the circulation water temperature constant.

During the stopping of the heat source water pump, the bypass port of V2 will be closed fully by interlocking.

The start/stop control of the fan and pump of the closed type cooling tower is applied with the step control following the command of the auxiliary switch XS of V1, thus controlling water temperature and saving motor power.

7) Pump interlock circuit

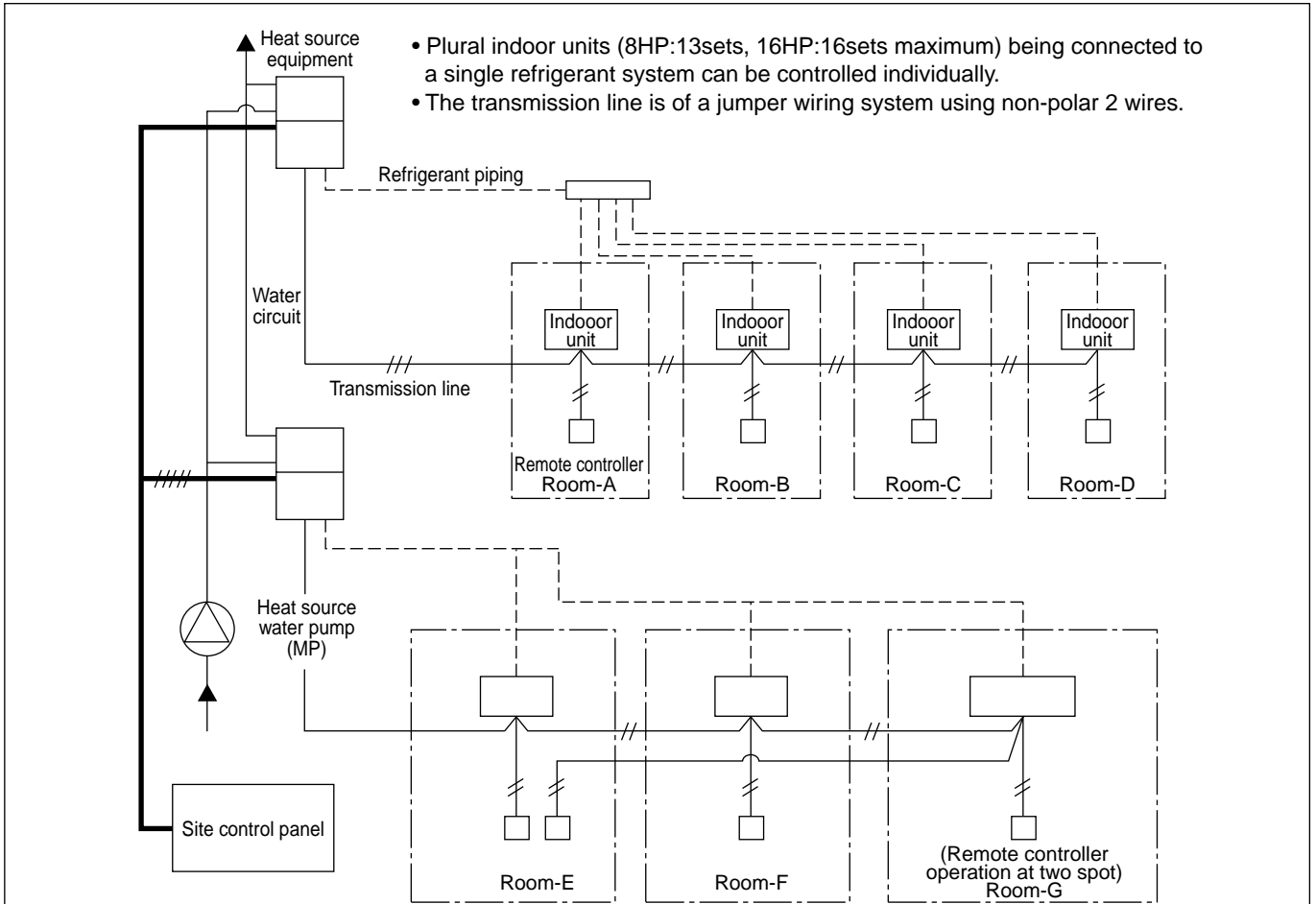

Wiring diagram

This circuit uses the "Terminal block for pump interlock (TB8)" inside the electrical parts box of the heat source equipment. This circuit is for interlocking of the heat source equipment operation and the heat source water pump.

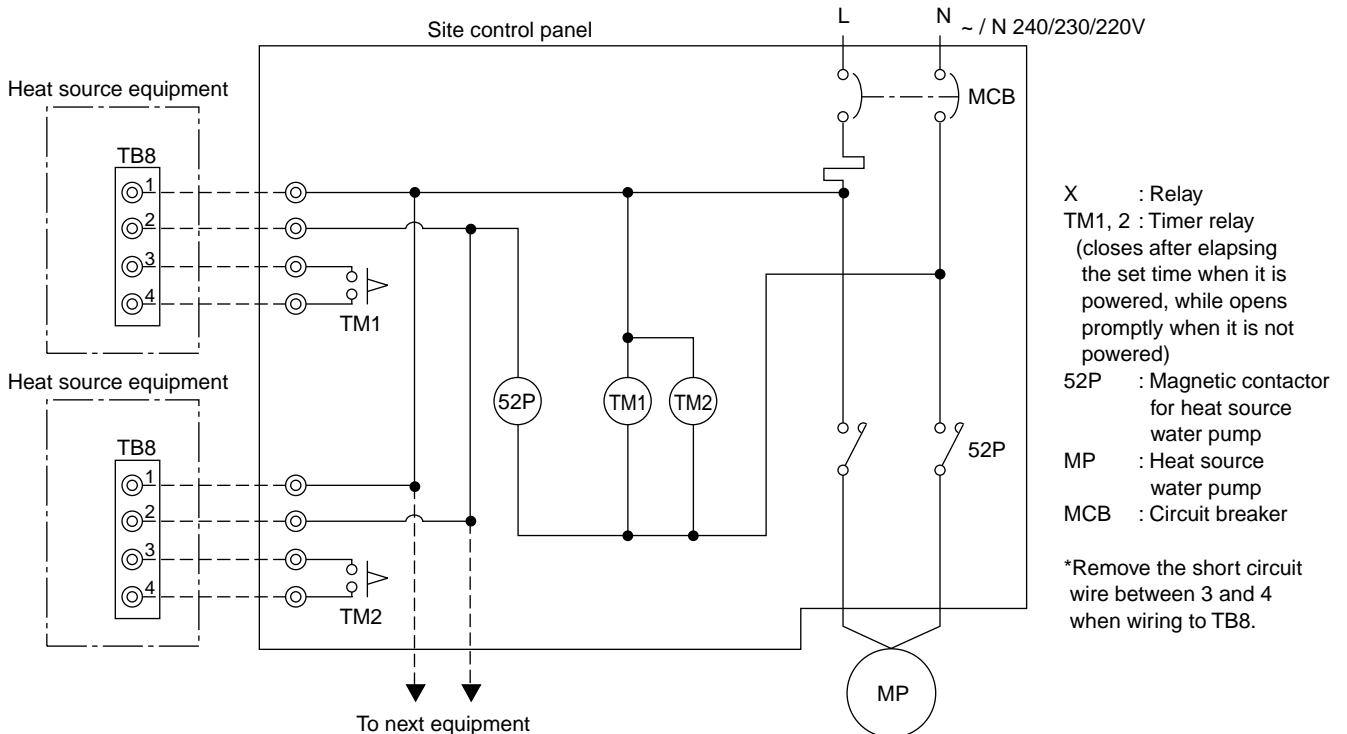

Operation ON signal

Terminal No.	TB8-1, 2
Output	Relay contacts output Rated voltage : L1 - N : 220 ~ 240V Rated load : 1A
Operation	<ul style="list-style-type: none">• When Dip switch 2-7 is OFF The relay closes during compressor operation.• When DIP switch 2-7 is ON. The relay closes during reception of cooling or the heating operation signal from the controller. (Note : It is output even if the thermostat is OFF (when the compressor is stopped).)

Pump Interlock

Terminal No.	TB8-3, 4
Input	Level signal
Operation	If the circuit between TB8-3 and TB8-4 is open, compressor operation is prohibited.

7-2.WATER PIPING WORK

Although the water piping for the CITY MULTI WY system does not differ from that for ordinary air conditioning systems, pay special attention to the items below in conducting the piping work.

1) Items to be observed on installation work

- In order to equalize piping resistance for each unit, adapt the reverse return system.
- Mount a joint and a valve onto the water outlet/inlet of the unit to allow for maintenance, inspection and replacement work. Be sure to mount a strainer at the water inlet piping of the unit. (The strainer is required at the circulation water inlet to protect the heat source unit.)
- * The installation example of the heat source unit is shown right.
- Be sure to provide an air relief opening on the water piping properly, and purge air after feeding water to the piping system.
- Condensate will generate at the low temperature part inside the heat source equipment. Connect drain piping to the drain piping connection located at the bottom of the heat source equipment to discharge it outside the equipment.
- At the center of the header of the heat exchanger water inlet inside the unit, a plug for water discharge is being provided.
Use it for maintenance work or the like.
- Mount a backflow prevention valve and a flexible joint for vibration control onto the pump.
- Provide a sleeve to the penetrating parts of the wall to prevent the piping.
- Fasten the piping with metal fitting, arrange the piping not to expose to cutting or bending force, and pay sufficient care for possible vibration.
- Be careful not to erroneously judge the position of the inlet and outlet of water.
(Lower position : Inlet, Upper position : Outlet)

2) Thermal insulation work

Thermal insulation or antisweating work is not required for the piping inside buildings in the case of the CITY MULTI WY system if the operating temperature range of circulation water stays within the temperature near the normal (summer : 30°C, winter : 20°C).

In case of the conditions below, however, thermal insulation is required.

- Use of well water for heat source water
- Outdoor piping portions
- Indoor piping portions where freezing may be caused in winter
- A place where vapor condensation may be generated on piping due to an increase in dry bulb temperature inside the ceiling caused by the entry of fresh outdoor air
- Drain piping portions

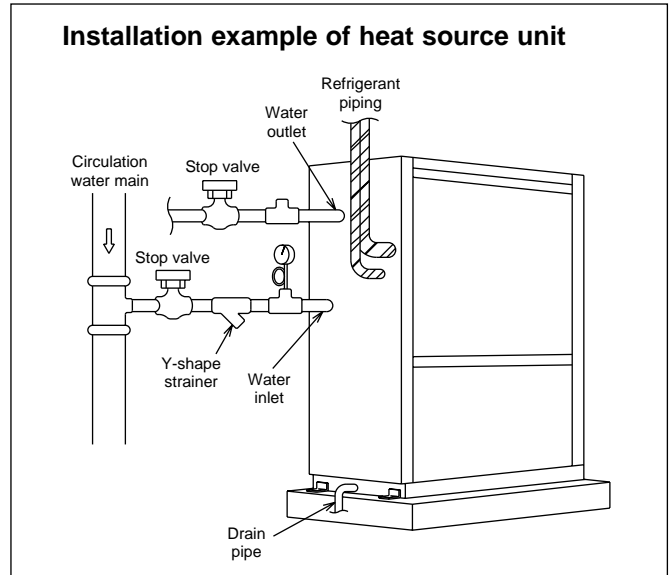

3) Water treatment and water quality control

For the circulation water cooling tower of the CITY MULTI WY system, employment of the closed type is recommended to keep water quality. However, in the case that an open type cooling tower is employed or the circulating water quality is inferior, scale will adhere onto the water heat exchanger leading to the decreased heat exchange capacity or the corrosion of the heat exchanger. Be sufficiently careful for water quality control and water treatment at the installation of the circulation water system.

- Removal of impurities inside piping
Be careful not to allow impurities such as welding fragment, remaining sealing material and rust from mixing into the piping during installation work.
- Water treatment

The water quality standards have been established by the industry (Japan Refrigeration, Air Conditioning Industry Association, in case of Japan) for water treatment to be applied.

	Items	Standard values
Standard items	PH(25°C)	7.0 ~ 8.0
	Electric conductivity (25°C)($\mu\text{s}/\text{cm}$)	300 or less
	Chlorine ion Cl^- (mg/l)	50 or less
	Sulfate ion SO_4^{2-} (mg/l)	50 or less
	M-alkalinity CaCO_3 (mg/l)	50 or less
	Total hardness CaCO_3 (mg/l)	70 or less
	Iron Fe (mg/l)	1.0 or less
Reference items Note.1	Sulfur ion S^{2-} (mg/l)	Not be detected
	Ammonium ion NH_4^+ (mg/l)	Not be detected
	Silica SiO_2 (mg/l)	30 or less

Note.1 It is clearly found that the component of the reference items will be hazardous, however, the quantitative relationship between the content and hazard has not been clarified yet. Therefore, they are listed as the reference items.

In order to keep the water quality within such standards, you are kindly requested to conduct bleeding-off by overflow and periodical water quality tests, and use inhibitors to suppress condensation or corrosion. Since piping may be corroded by some kinds of inhibitor, consult an appropriate water treatment expert for proper water treatment.

(4) Pump interlock

Operating the heat source unit without circulation water inside the water piping can cause a trouble. Be sure to provide interlocking for the unit operation and water circuit. Since the terminal block is being provided inside the unit, use it as required.

PQRY-P200-250YEM-A

CONTENTS

WR2(R407G)

1. Specifications	I -126
2. Capacity Tables	I -128
2-1 Correction by temperature	I -128
2-2 Correction by total indoor	I -130
2-3 Correction by refrigerant piping length	I -131
2-4 Operation limit	I -131
3. Sound Levels	I -132
4. External Dimensions	I -133
5. Electrical Wiring Diagram	I -134
6. Refrigerant Circuit Diagram	I -135
And Thermal Sensor	
7. System design guide	I -136

1. Specifications

WR2(R407C)

Model name		PQRY-P200YEM-A	
		Cooling	Heating
Capacity	kW	22.4	25.0
Power source		3N ~ 380/400/415V 50Hz/60Hz	
Power input	kW	7.22	7.24
Current	A	12.1/11.5/11.1	12.2/11.6/11.1
Compressor	Type	Hermetic	
	Motor output	kW	5.5
	Crankcase heater	kW	0.045(240V)
Heat exchanger	Type	Double coil	
	Water volume in the coil	l	10.5
Circulating water	Volume	m ³ /h	4.27
	Pressure drop	kPa	8
Refrigerant / Lubricant		R407C/MEL32	
External finish		Galvanized sheets	
External dimension	mm	1670(H)X 1150(W) X 500(L)	
Protection devices	High pressure protection		2.94MPa
	Compressor		Over current protection
	Inverter		DC bus current protection, thermal switch
Refrigerant piping diameter	High press. / Low press.	φ 19.05 (Flare) / φ 25.4 (Flange)	
Indoor unit	Total capacity		50 ~150% of heat source unit capacity
	Model / Quantity		Model 20 ~ 250 / 1 ~ 15
Noise level	* dB<A>	51	
Net weight	kg	270	
Operating temperature range		Indoor:15°CWB ~ 24°CWB Water :10°C ~ 45°C	Indoor:15°CDB ~ 27°CDB Water :10°C ~ 45°C

Note: 1.Cooling/heating capacity indicates the maximum value at operation under the following condition.

Cooling Indoor : 27°CDB/19°CWB Water temperature : 30°C

Heating Indoor : 20°CDB Water temperature : 20°C

Pipe length : 7.5m Height difference : 0m

2.When the total capacity of indoor units exceeds 130% of heat source units capacity, the operating temperature range of circulating water is 15°C ~ 45°C.

3.The ambient temperature of heat source unit has to be kept below 40°C (dry valve).
The ambient relative humidity of heat source unit has to be kept below 80%.

4.This unit can not be installed in the outdoor. (No protection against the weather.)

* It is measured in anechoic room.

Model name		PQRY-P250YEM-A	
		Cooling	Heating
Capacity	kW	28.0	31.5
Power source		3N ~ 380/400/415V 50Hz/60Hz	
Power input	kW	9.02	9.23
Current	A	15.2/14.4/13.9	15.5/14.8/14.2
Compressor	Type	Hermetic	
	Motor output	kW	7.5
	Crankcase heater	kW	0.045(240V)
Heat exchanger	Type	Double coil	
	Water volume in the coil	l	13
Circulating water	Volume	m ³ /h	5.79
	Pressure drop	kPa	10
Refrigerant / Lubricant		R407C/MEL32	
External finish		Galvanized sheets	
External dimension		mm	1670(H)X 1150(W)X 500(L)
Protection devices	High pressure protection		2.94MPa
	Compressor		Over current protection
	Inverter		DC bus current protection, thermal switch
Refrigerant piping diameter	High press. / Low press.	φ 19.05 (Flare) / φ 28.58 (Flange)	
Indoor unit	Total capacity		50 ~ 150% of heat source unit capacity
	Model / Quantity		Model 20 ~ 250/ 1 ~ 16
Noise level	*	dB<A>	52
Net weight		kg	280
Operating temperature range		Indoor:15°CWB ~ 24°CWB Water :10°C ~ 45°C	Indoor:15°CDB ~ 27°CDB Water :10°C ~ 45°C

Note: 1.Cooling/heating capacity indicates the maximum value at operation under the following condition.

*1 **Cooling** Indoor : 27°CDB/19°CWB Water temperature : 30°C

Heating Indoor : 20°CDB Water temperature : 20°C

Pipe length : 7.5m Height difference : 0m

2.When the total capacity of indoor units exceeds 130% of heat source units capacity, the operating temperature range of circulating water is 15°C ~ 45°C.

3.The ambient temperature of heat source unit has to be kept below 40°C (dry valve).

The ambient relative humidity of heat source unit has to be kept below 80%.

4.This unit can not be installed in the outdoor. (No protection against the weather.)

* It is measured in anechoic room.

2. Capacity Tables

2-1. Correction by temperature

Cooling

- Standard Specifications

		PQRY-P200	PQRY-P250
Capacity	kW	22.4	28.0
Input	kW	7.22	9.02

WR2(R407C)

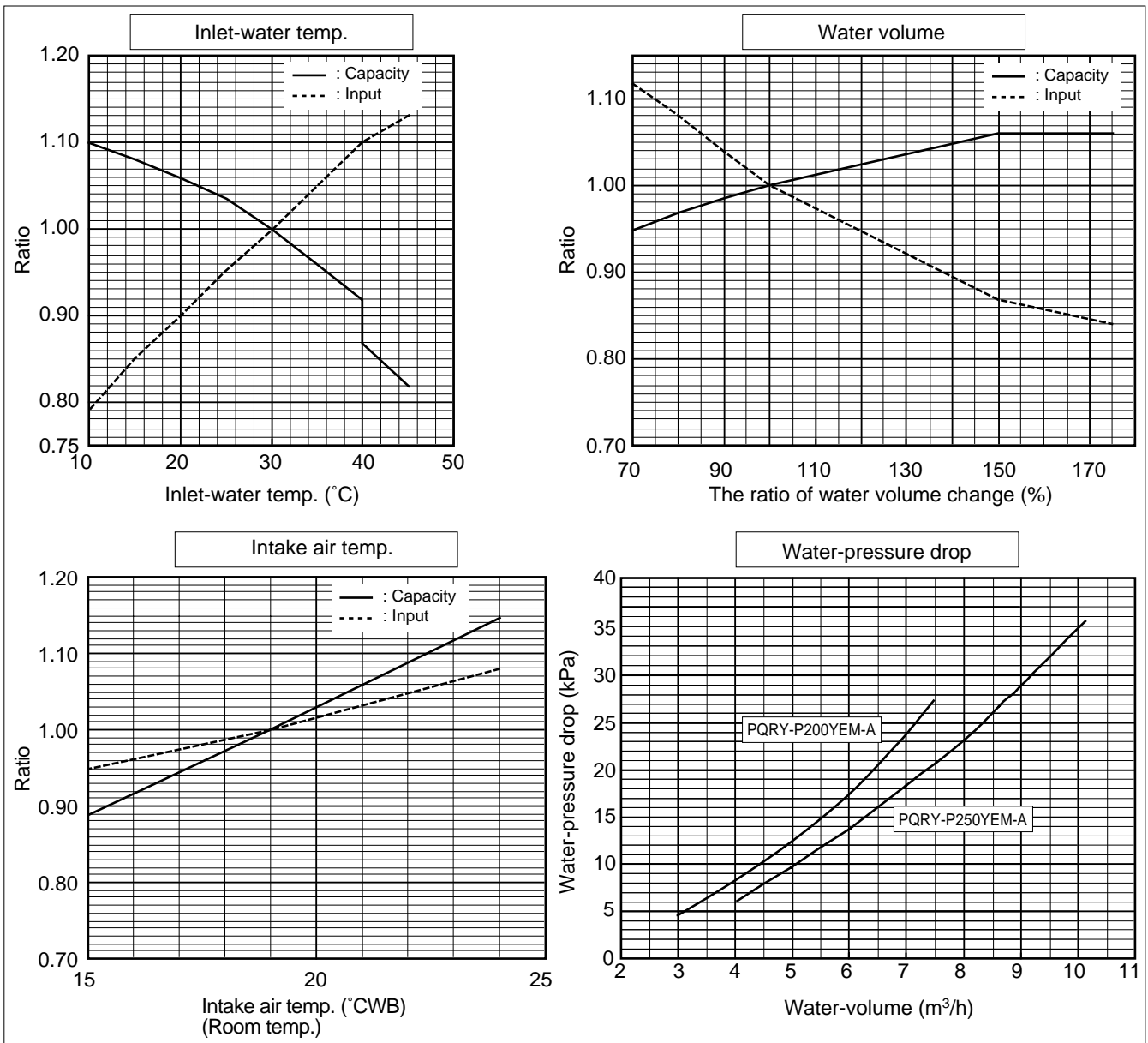

Heating

• Standard Specifications

		PQRY-P200	PQRY-P250
Capacity	kW	25.0	31.5
Input	kW	7.24	9.23

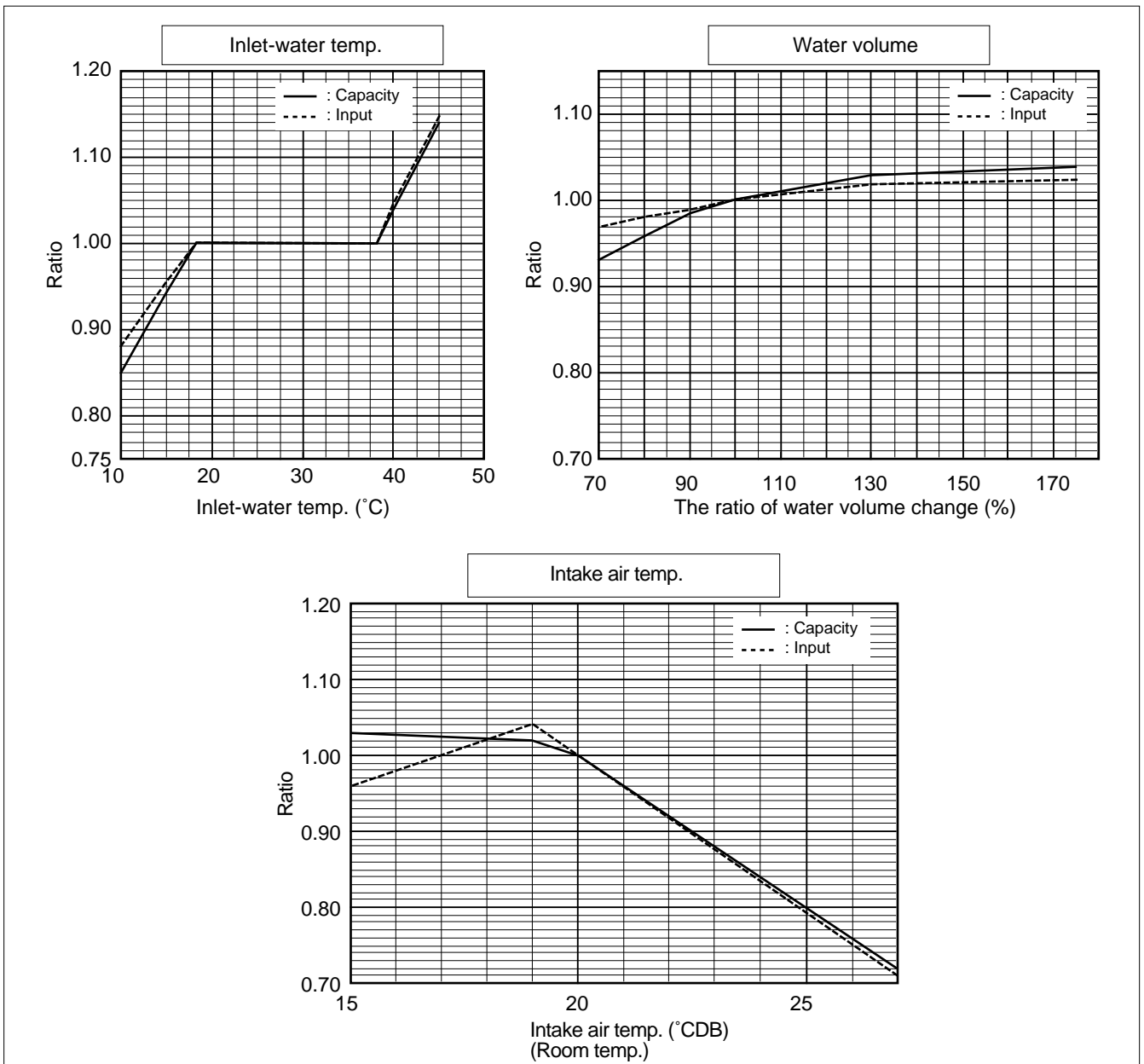

2-2. Correction by total indoor

PQRY-P200

1) Capacity

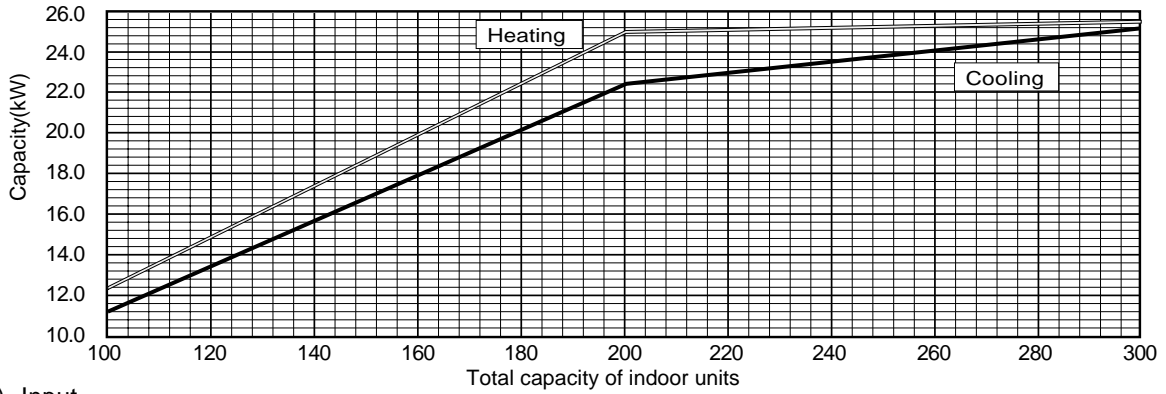

2) Input

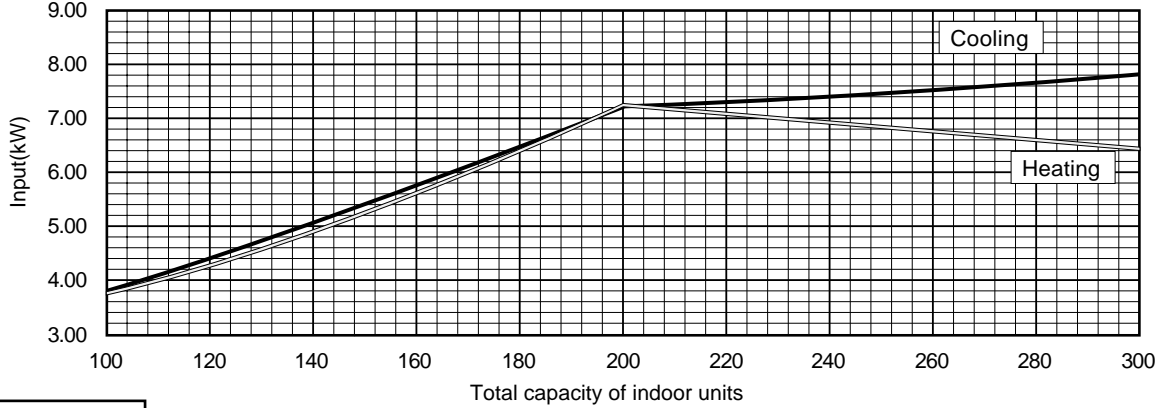

PQRY-P250

1) Capacity

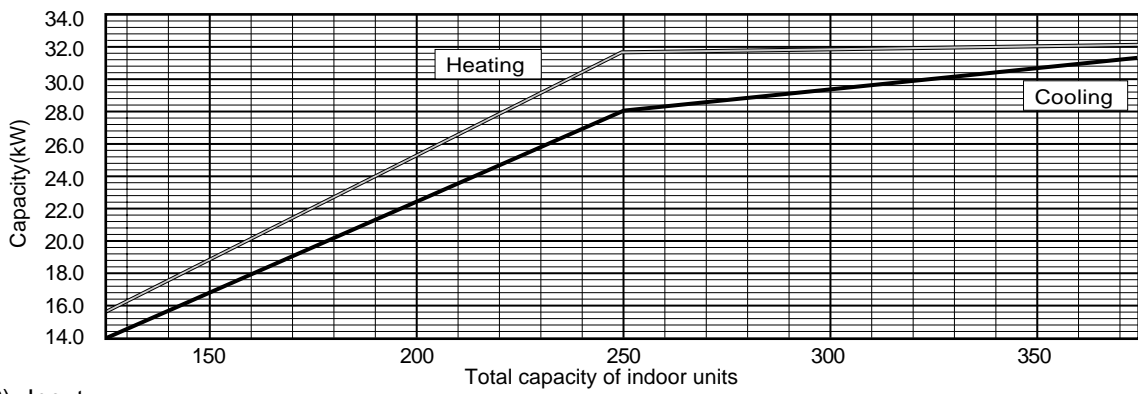

2) Input

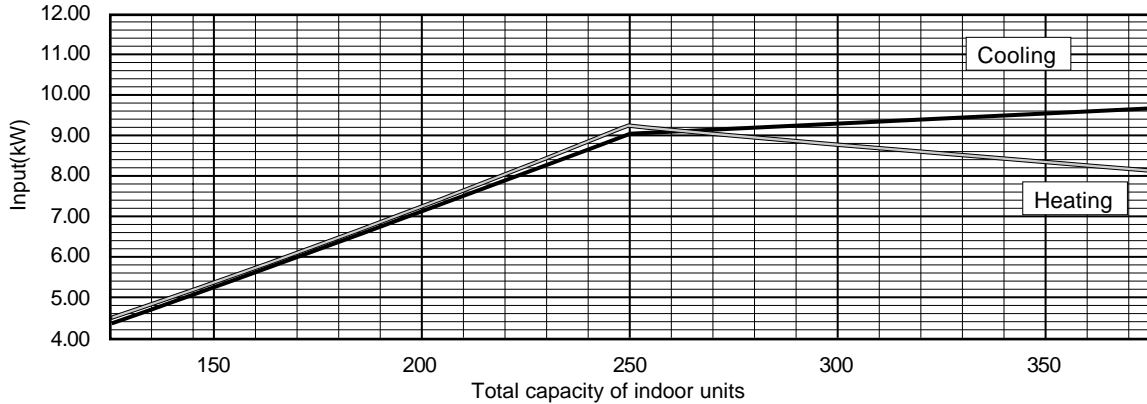

2-3. Correction by refrigerant piping length

To obtain a decrease in cooling/heating capacity due to refrigerant piping extension, multiply by the capacity correction factor based on the refrigerant piping equivalent length in the table below.

• **Cooling capacity correction**

PQRY-P200

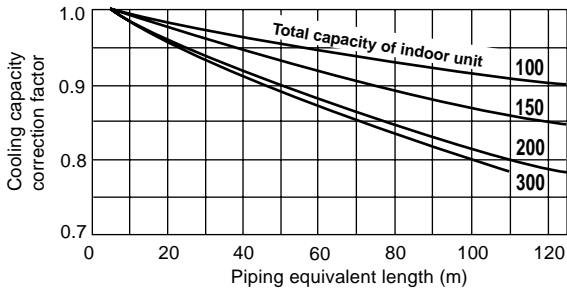

PQRY-P250

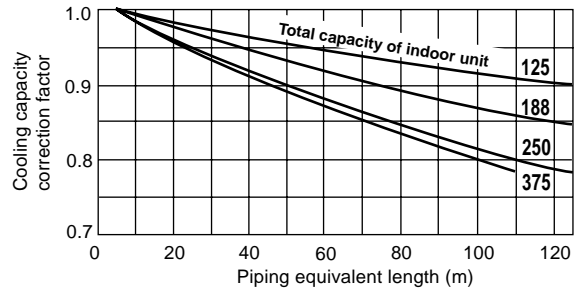

• **Heating capacity correction**

PQRY-P200

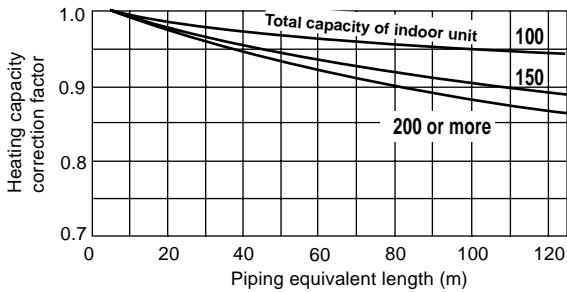

PQRY-P250

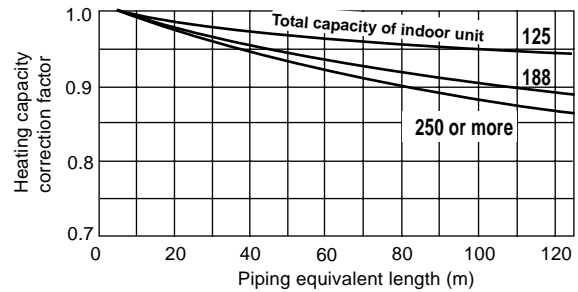

• **How to obtain piping equivalent length**

① **PQRY-P200**

Equivalent length = (Actual piping length to the farthest indoor unit) + (0.47 X number of bent on the piping)m

② **PQRY-P250**

Equivalent length = (Actual piping length to the farthest indoor unit) + (0.50 X number of bent on the piping)m

2-4. Operation limit

• **Cooling**

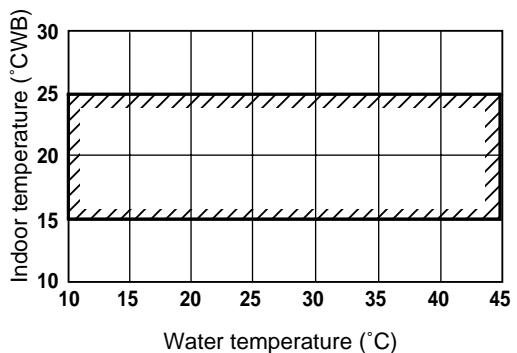

(Indoor capacity ≥ 130% : Water temp. 15~45°C)

• **Heating**

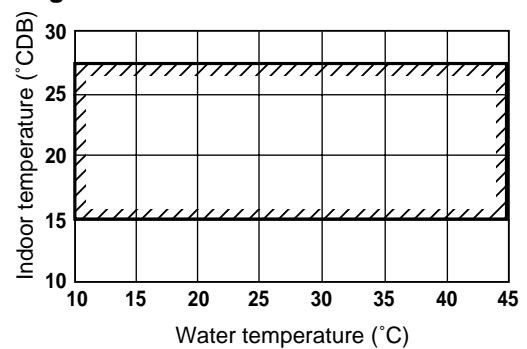

(Indoor capacity ≥ 130% : Water temp. 15~45°C)

3. Sound Levels

PQRY-P200

Measurement condition

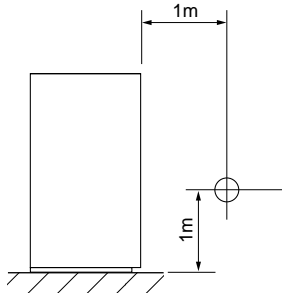

Sound pressure level in anechoic room
51 dB (A)

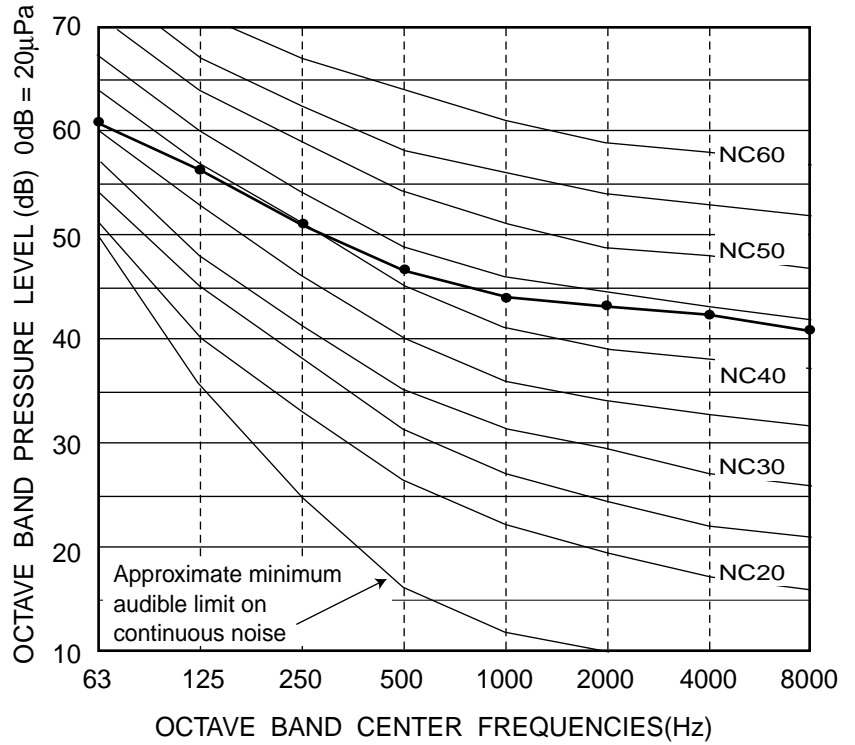

PQRY-P250

Measurement condition

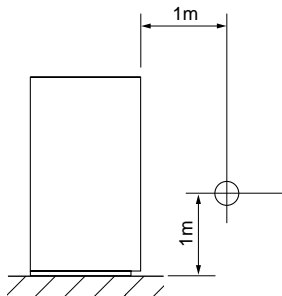

Sound pressure level in anechoic room
52 dB (A)

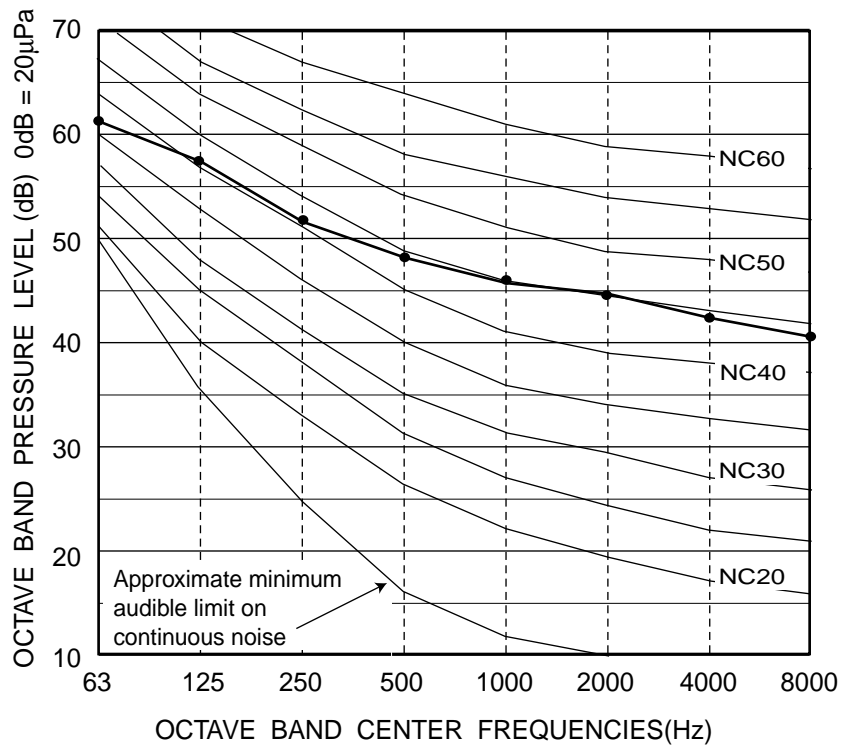

4. External Dimensions

PQRY-P200,250YEM-A

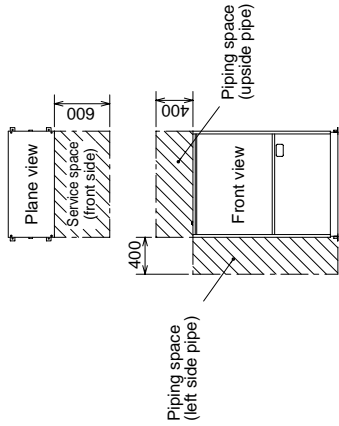
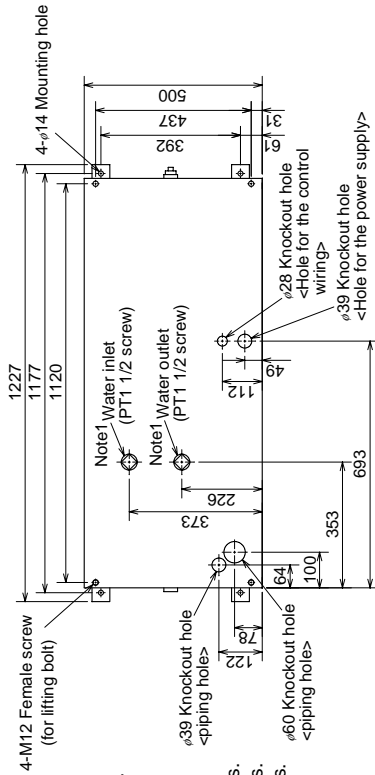
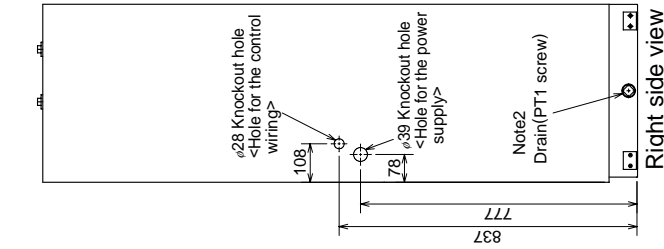

Fig. A

Unit : mm



Plane view



Right side view

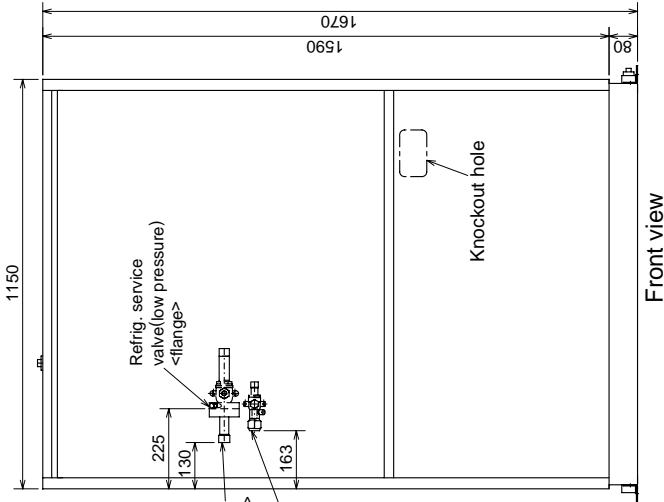

Front view

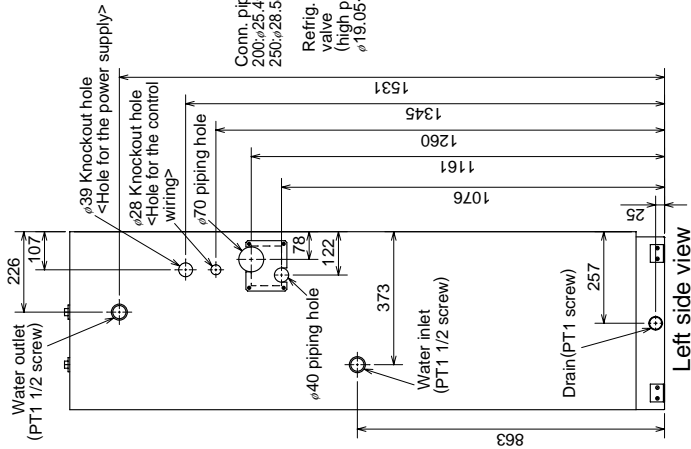

Left side view

- <Accessory>
- Refrigerant (low pressure) conn. pipe 1pc.
(The connecting pipe is fixed with the unit)
 - Packing for conn. pipe 1pc.
(Attached near the ball valve)
 - Wiring mounting plate 1pc.
 - Tapping screw M4 2pcs.
 - Lifting bolt M12 4pcs.
 - Bushing 2pcs.

- Note1. At the time of product shipment, the left side piping specification serves as the local water piping connection. When connecting to the upper piping, please remove the plug sealing corks from the upper piping connection, and attach a left piping connection part.
Ensure there is no leak after the attachment has been fitted.
2. At the time of product shipment, the left side piping specification serves as the local drainage connection. When connecting on the right side, please remove the right side plug sealing corks, and attach a left side. Ensure there is no leak after the attachment has been fitted.
3. Take notice of service space as Fig A.

WR2(R407C)

5. Electrical Wiring Diagram

PQRY-P200, 250YEM-A

WR2(R407C)

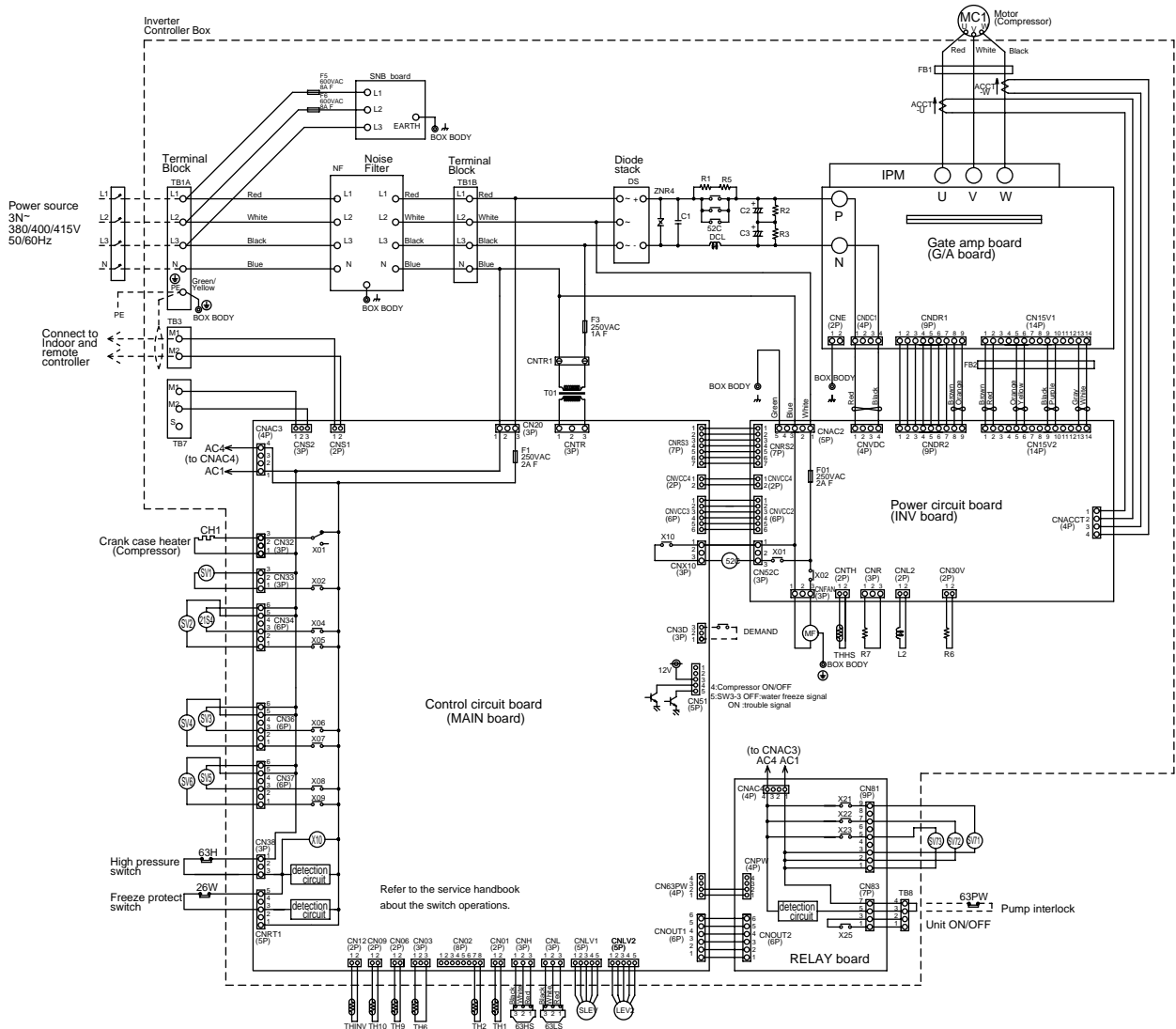

<SYMBOL EXPLANATION>

Symbol	N a m e	Symbol	N a m e	Symbol	N a m e	Symbol	N a m e
DCL	DC reactor (Power factor improvement)	SV3-6	Solenoid valve (Heat exchanger capacity control)	63LS	Low pressure sensor	THINV	Thermistor Outlet temp. detect of heat exchanger for inverter
ACCT-U,W	Current Sensor	SV71-73	Solenoid valve (Heat exchanger capacity control)	L2	Choke coil (Transmission)	THHS	Radiator panel temp. detect
ZNR4	Varistor	LEV2	Electric expansion valve (Heat exchanger for inverter)	IPM	Intelligent power module	X1-10	Discharge pipe temp. detect
52C	Magnetic contactor (Inverter main circuit)	SLEV	Electronic expansion valve(Oil return)	TH1	Thermistor	X21-25	Saturation evapo. temp. detect
MF1	Fan motor (Radiator panel)	63HS	High pressure sensor	TH2		FB1-2	OA temp. detect
21S4	4-way valve			TH6			High pressure liquid temp.
SV1,SV2	Solenoid valve (Discharge-suction bypass)			TH9			Compressor shell temp.
				TH10		⊕	Ferrite core
							Earth terminal

6. Refrigerant Circuit Diagram And Thermal Sensor

PQRY-P200, 250

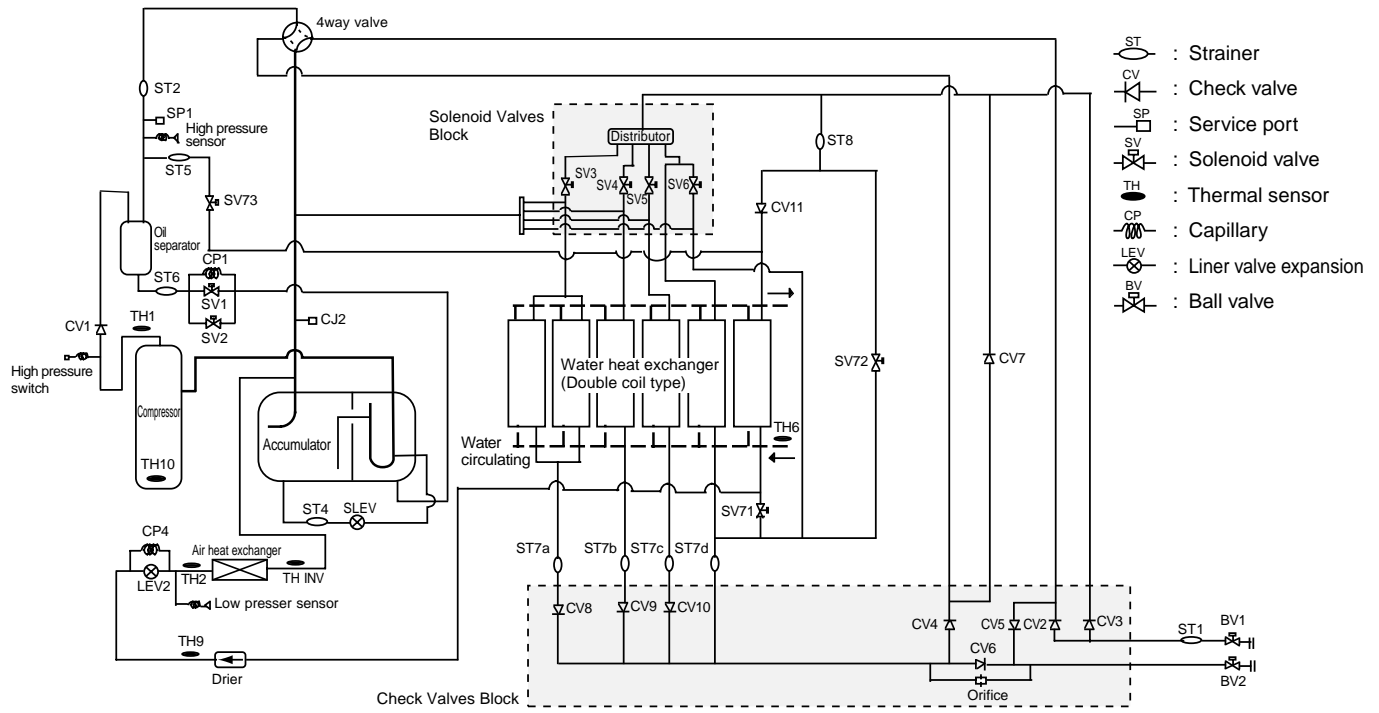

WR2(R407C)

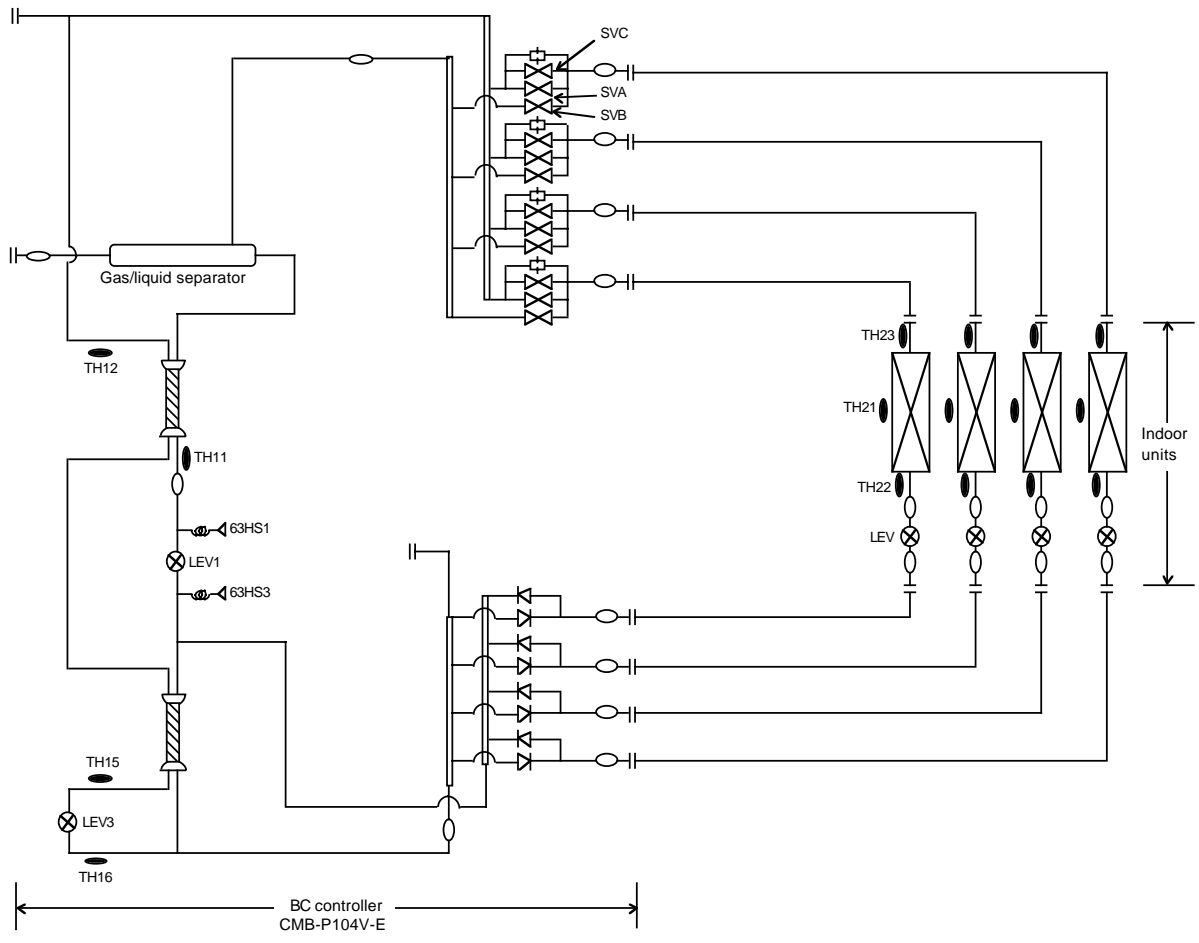

7. System design guide

7-1. Designing of water circuit system

1) Example of basic water circuit

The water circuit of the water heat source CITY MULTI connects the heat source unit with the cooling tower/auxiliary heat source/heat storage tank/circulation pump with a single system water piping as shown in the figure below. The selector valve automatically controls to circulate water toward the cooling tower in the cooling season, while toward the heat storage tank in the heating season. If the circulation water temperature is kept in a range of 10~45°C* regardless of the building load, the water heat source CITY MULTI can be operated for either cooling or heating. Therefore in the summer when only cooling load exists, the temperature rise of circulation water will be suppressed by operating the cooling tower. While in the winter when heating load increases, the temperature of circulation water may be dropped below 10°C. Under such situation, the circulation water will be heated with the auxiliary heat source if it drops below a certain temperature.

When the thermal balance between cooling and heating operation is in a correct proportion, the operation of the

auxiliary heat source and cooling tower is not required. In order to control the above thermal balance properly and use thermal energy effectively, utilizing of heat storage tanks, and night-time discounted electric power as an auxiliary heat source will be economical.

Meantime as this system uses plural sets of heat source unit equipped with water heat exchangers, water quality control is important. Therefore it is recommended to use closed type cooling towers as much as possible to prevent the circulation water from being contaminated.

When open type cooling towers are used, it is essential to provide proper maintenance control such as that to install water treatment system to prevent troubles caused by contaminated circulation water.

*15~45°C : 50%~150% of indoor units can be connected

*10~40°C : 50%~130% of indoor units can be connected

Example of basic water circuit for water heat source CITY MULTI

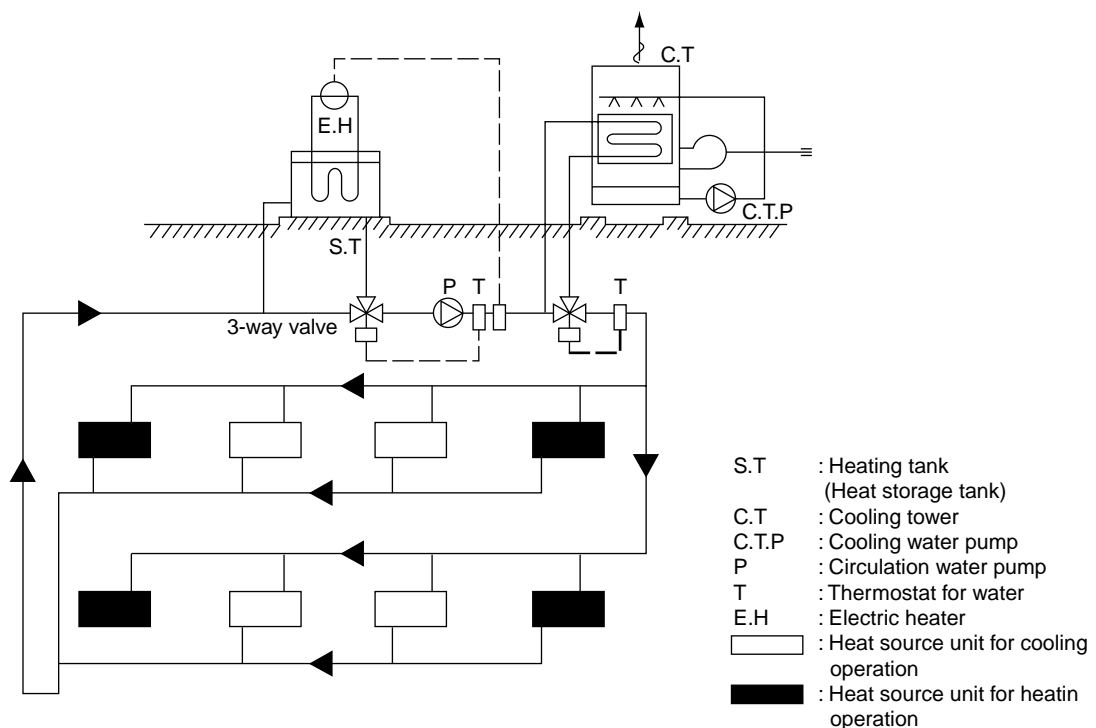

The indoor unit and refrigerant piping system are excluded in this figure.

2) Cooling tower

a) Types of cooling tower

The cooling towers presently used include the open type cooling tower, open type cooling tower + heat exchanger, closed type cooling tower, and air-cooled type cooling tower. However, as the quality control of circulation water is essential when units are installed in decentralized state inside a building, the closed type cooling tower is generally employed in such case.

Although the circulation water will not be contaminated by atmospheric air, it is recommended to periodically blow water inside the system and replenish fresh water instead.

In a district where the coil may be frozen in the winter, it is necessary to apply antifreeze solution to the circulation water, or take freeze protection measures such as to automatically discharge water inside the cooling coil at the stopping of the pump.

When the open type cooling tower is used, be sure to install a water quality control device in addition to the freeze protection measures, as the water may be deteriorated by atmospheric contaminants entered into the cooling tower and dissolved into the circulation water.

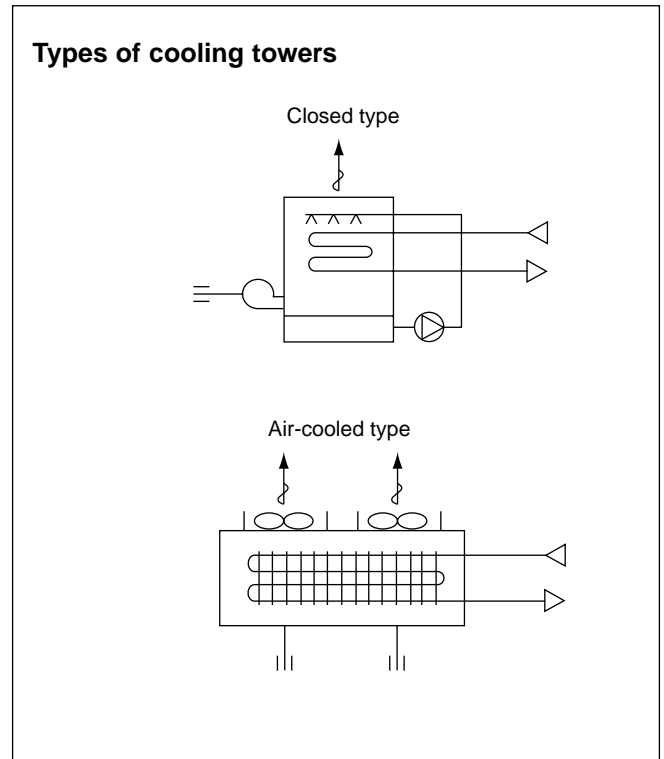

WR2(R407G)

b) Calculation method of cooling tower capacity

All units of the water heat source CITY MULTI may possibly be in cooling operation temporarily (at pulling down) in the summer, however, it is not necessary to determine the capacity according to the total cooling capacity of all CITY MULTI units as this system has a wide operating water temperature range

(15~45°C : 130% over
10~45°C : 130% or less).

It is determined in accordance with the value obtained by adding the maximum cooling load of an actual building, the input heat equivalent value of all CITY MULTI units, and the cooling load of the circulating pumps. Please check for the values of the cooling water volume and circulation water volume.

$$\text{Cooling tower capacity} = \frac{Q_c + 860 \times (\sum Q_w + R_w)}{3,900} \quad (\text{Refrigeration ton})$$

Q_c : Maximum cooling load under actual state (kcal/h)
 Q_w : Total input of water heat source CITY MULTI at simultaneous operation under maximum state (kW)
 P_w : Shaft power of circulation pumps (kW)

3) Auxiliary heat source and heat storage tank

When the heating load is larger than the cooling load, the circulation water temperature lowers in accordance with the heat balance of the system. It should be heated by the auxiliary heat source in order to keep the inlet water temperature within the operating range

$$\left(\begin{array}{l} 15^{\circ}\text{C or more : 130\% over} \\ 10^{\circ}\text{C or more : 130\% or less} \end{array} \right)$$

of the water heat source CITY MULTI.

Further in order to operate the water heat source CITY MULTI effectively, it is recommended to utilize the heat storage tank to cover the warming up load in the morning and the insufficient heat amount.

Effective heat utilization can be expected to cover insufficient heat at the warming up in the next morning or peak load time by storing heat by installing a heat storage tank or operating a low load auxiliary heat source at the stopping of the water heat source CITY MULTI. As it can also be possible to reduce the running cost through the heat storage by using the discounted night-time electric power, using both auxiliary heat source and heat storage tank together is recommended.

The effective temperature difference of an ordinary heat storage tank shows about 5deg. even with the storing temperature at 45°C.

However with the water heat source CITY MULTI, it can be utilized as heating heat source up to 15°C with an effective temperature of a high 30deg. approximately, thus the capacity of the heat storage tank can be minimized.

a)Auxiliary heat source

The following can be used as the auxiliary heat source.

- Boiler (Heavy oil, kerosine, gas, electricity)
- Electric heat (Insertion of electric heater into heat storage tank)
- Outdoor air (Air-heat source heat pump chiller)
- Warm discharge water (Exhaust water heat from machines inside building and hot water supply)
- Utilization of night-time lighting
- Solar heat

Please note that the auxiliary heat source should be selected after studying your operating environment and economical feasibility.

Determining the auxiliary heat source capacity

For the CITY MULTI water heat source system, a heat storage tank is recommended to use. When employment of the heat storage tank is difficult, the warming up operation should be arranged to cover the starting up heating load. Since the holding water inside the piping circuit owns heat capacity and the warming up operation can be assumed for about one hour except that in a cold region, the heat storage tank capacity is required to be that at the maximum daily heating load including the warming up load at the next morning of the holiday.

However the auxiliary heat source capacity should be determined by the daily heating load including warming up load on the week day.

For the load at the next morning of the holiday, heat storage is required by operating the auxiliary heat source even outside of the ordinary working hour.

When heat storage tank is not used

$$QH = HC_T \left(1 - \frac{1}{COP_h} \right) - 1000 \times V_w \times \Delta T - 860 \times P_w$$

QH	: Auxiliary heat source capacity	(kcal/h)
HC _T	: Total heating capacity of each water heat source CITY MULTI	(kcal/h)
COP _H	: COP of water heat source CITY MULTI at heating	
V _w	: Holding water volume inside piping	(m ³)
ΔT	: Allowable water temperature drop = T _{WH} - T _{WL}	(°C)
T _{WH}	: Heat source water temperature at high temperature side	(°C)
T _{WL}	: Heat source water temperature at low temperature side	(°C)
P _w	: Heat source water pump shaft power	(kW)

When heat storage tank is used;

$$QH = \frac{HQ_{1T} \left(1 - \frac{1}{COP_h} \right) - 860 \times P_w \times T_2}{T_1} \times K \quad (\text{Kcal})$$

- QH_{1T} : Total of heating load on weekday including warming up (kcal/day)
- T₁ : Operating hour of auxiliary heat source (h)
- T₂ : Operating hour of heat source water pump (h)
- K : Allowance factor (Heat storage tank, piping loss, etc.) 1.05~1.10

HQ_{1T} is calculated from the result of steady state load calculation similarly by using the equation below.
 $HQ_{1T} = 1.15 \times (\sum Q'a + \sum Q'b + \sum Q'c + \sum Q'd + \sum Q'f) T_2 - \psi (\sum Qe_1 + \sum Qe_2 + \sum Qe_3) (T_2 - 1)$

- Q'a : Thermal load from external wall/roof in each zone (kcal/h)
- Q'b : Thermal load from glass window in each zone (kcal/h)
- Q'c : Thermal load from partition/ceiling/floor in each zone (kcal/h)
- Q'd : Thermal load by infiltration in each zone (kcal/h)
- Q'f : Fresh outdoor air load in each zone (kcal/h)
- Q'e₁ : Thermal load from human body in each zone (kcal/h)
- Q'e₂ : Thermal load from lighting fixture in each zone (kcal/h)
- Q'e₃ : Thermal load from equipment in each zone (kcal/h)
- ψ : Radiation load rate 0.6~0.8
- T₂ : Air conditioning hour

b) Heat storage tank

Heat storage tank can be classified by types into the open type heat storage tank exposed to atmosphere, and the closed type heat storage tank with structure separated from atmosphere. Although the size of the tank and its installation place should be taken into account, the closed type tank is being usually employed by con-

sidering corrosion problems.

The capacity of heat storage tanks is determined in accordance with the daily maximum heating load that includes warming up load to be applied for the day after the holiday.

When auxiliary heat source is operated during operation and even after stopping of water heat source CITY MULTI unit

$$V = \frac{HQ_{2T} \left(1 - \frac{1}{COP_h} \right) - 860 \times P_w \times T_2 - QH \times T_2}{\Delta T \times 1000 \times \eta V} \quad (\text{ton})$$

When auxiliary heat source is operated after stopping of water heat source CITY MULTI unit

$$V = \frac{HQ_{2T} \left(1 - \frac{1}{COP_h} \right) - 860 \times P_w \times T_2}{\Delta T \times 1000 \times \eta V} \quad (\text{ton})$$

- HQ_{2T} : Maximum heating load including load required for the day after the holiday (kcal/day)
- ΔT : Temperature difference utilized by heat storage tank (deg)
- ηV : Heat storage tank efficiency

$$HQ_{2T} : 1.3 \times (\sum Q'a + \sum Q'c + \sum Q'd + \sum Q'f) T_2 - \psi (\sum Qe_2 + \sum Qe_3) (T_2 - 1)$$

4) Piping system

The following items should be kept in your mind in planning / designing water circuits.

- a) All units should be constituted in a single circuit in principle.
- b) When plural numbers of the water heat source CITY MULTI unit are installed, the rated circulating water flow rate should be kept by making the piping resistance to each unit almost same value. As an example, the reverse return system as shown below may be employed.
- c) Depending on the structure of a building, the water circuit may be prefabricated by making the layout uniform.
- d) When a closed type piping circuit is constructed, install an expansion tank usable commonly for a make-up water

tank to absorb the expansion/contraction of water caused by temperature fluctuation.

- e) If the operating temperature range of circulation water stays within the temperature near the normal temperature (summer : 30°C, winter : 20°C), thermal insulation or anti-sweating work is not required for the piping inside buildings.

In case of the conditions below, however, thermal insulation is required.

- When well water is used for heat source water.
- When piped to outdoor or a place where freezing may be caused.
- When vapor condensation may be generated on piping due to an increase in dry bulb temperature caused by the entry of fresh outdoor air.

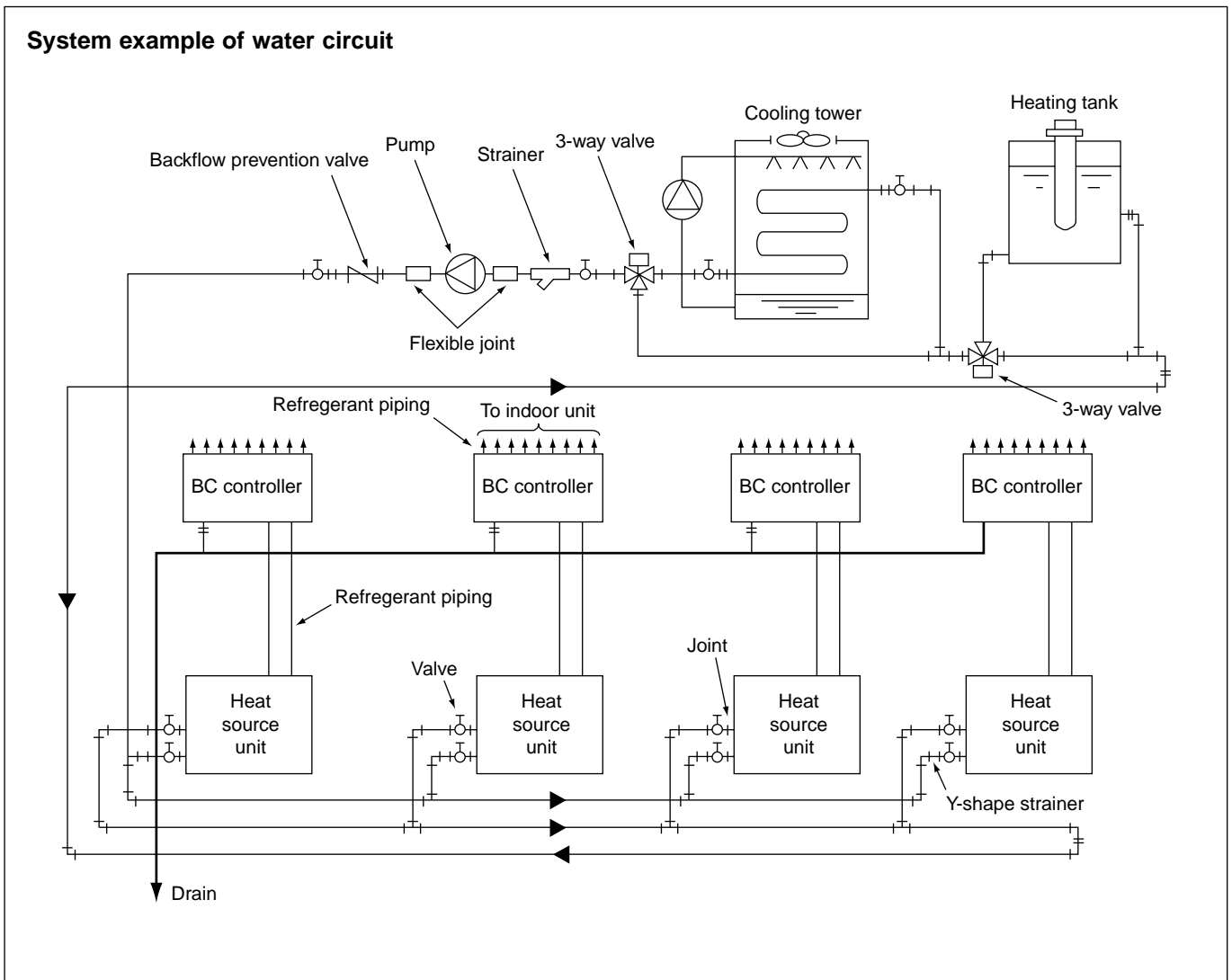

5) Cleaning of water heat exchanger

For the water heat exchanger, scale adheres in less amount generally in the case of closed type cooling towers. However in a long period of use, scale will adhere that may lower the heat exchange capacity and increase the water resistance.

In such case, conduct cleaning work under the procedure given below.

procedure given below.

The cleaning work procedure generally used is as follows. However as the cleaning agents have various differences in their cleaning effect, corrosion characteristics, processing time, and condensation for use, conduct the work after consulting the relating maker.

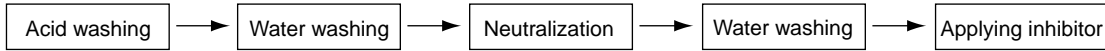

a) Still standing method

This method feeds the raw liquid or diluted solution of cleaning agent into the water circuit and leave it for a while, and requires only a simple device.

- Since the cleaning time required differs by the agent of each maker, be sufficiently careful for the time and not to exceed the time specified.

- Fully recover the cleaning liquid through the water discharge plug of the heat exchanger, and then fully clean the water circuit with clean water. If the water washing can not be made sufficiently, neutralization processing will be effective.

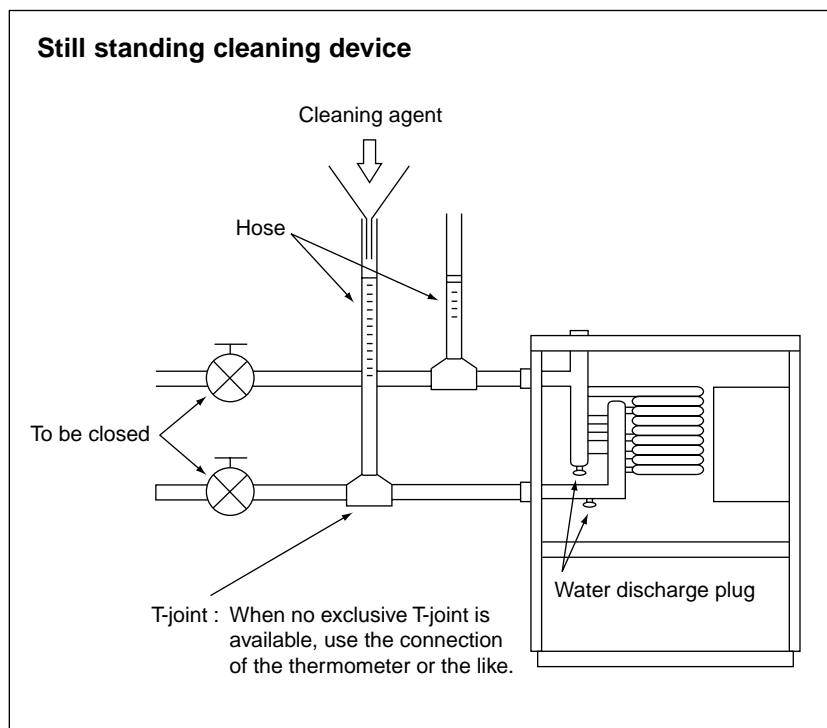

b)Circulation method

Although this method can clean in shorter time than that required by the still standing method, be careful that the circulation pump may be damaged if using cleaning agent with strong corrosive characteristics.

- After completing washing work, fully recover the washing liquid through the water discharge plug installed at the bottom of the piping and that at the heat exchanger.
- Conduct water washing for three times or more after removing cleaning agent. If this can not be made satisfactorily, apply neutralization treatment. Full replacement of water can be ascertained by measuring the PH of the water.
- Note that it may be required to control the cleaning time depending on the scale generation or water quality.
- At cleaning work, remove or shut down the instruments like water pressure gauges so that the cleaning liquid will not enter into them.
- Check for the connections of piping beforehand so that cleaning agent will not leak from the piping during cleaning work.
- Start cleaning operation after fully mixing the cleaning agent with water.
- Cleaning at the earlier timing is recommended as the removal of scale will be difficult if it has accumulated seriously. Periodical cleaning is necessary in a district with inferior water quality.
- Conduct water washing sufficiently with clear water after cleaning work as all cleaning agents own strong acidity.
- To verify the completion of cleaning, remove the hose and observe the inner wall of the piping whether it is clean.
- Be sufficiently careful for fire when using inflammable cleaning agent (GOSPEL R).

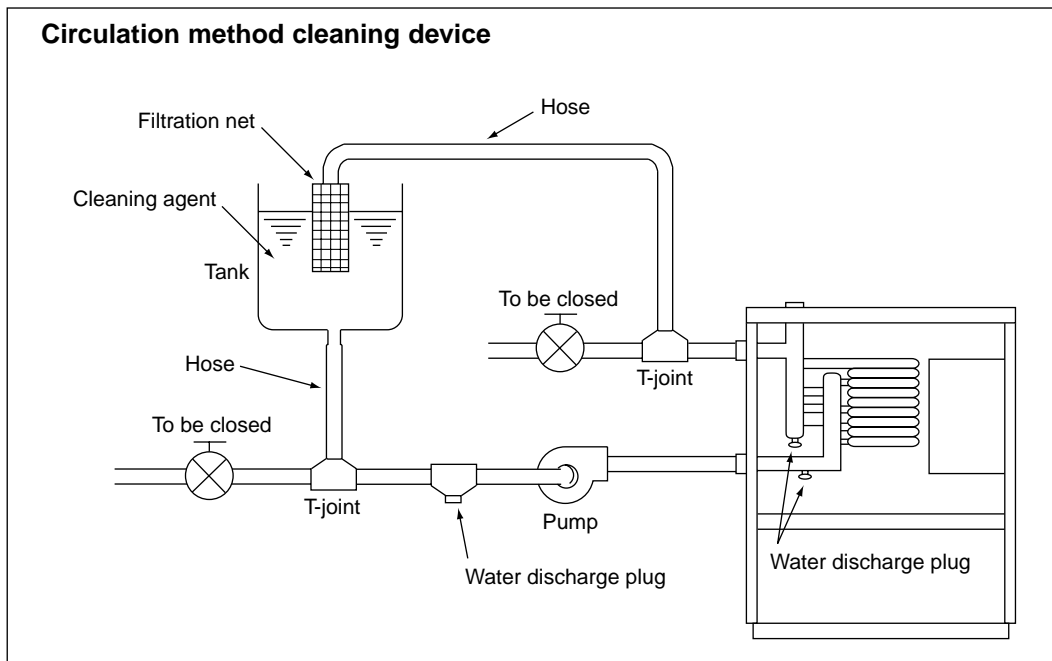

Example of cleaning agents

Name	Shape	Condensation	Time	Makers
CLEARLITE RK	Powder/Liquid	10~20%	2~3Hr.	Koei Kagaku
CLEARLITE ACE	Powder/Liquid	3~5%	1~3Hr.	Koei Kagaku
GOSPEL R	Liquid	7% (Upper limit 10%, lower limit 5%)	1~4Hr.	Gospel Kako
GOSPEL SR	Powder			Marusan
ADDITION DR	Powder			Seiwa kogyo
SS-100	Liquid			Saver Kagaku
NEOLUX F	Powder			
DISCALER	Powder	4~7%		

6) Practical System Examples and Circulation Water Control

Since the water heat source CITY MULTI is of water heat source system, versatile systems can be constituted by combining it with various heat sources.

The practical system examples are given below.

Either cooling or heating operation can be performed if the circulation water temperature of the water heat

source CITY MULTI stays within a range of 15~45°C. However, the circulation water temperature near 32°C for cooling and 20°C for heating is recommended by taking the life, power consumption and capacity of the air conditioning units into consideration. The detail of the control is also shown below.

Example-1 Combination of closed type cooling tower and hot water heat storage tank (using underground hollow slab)

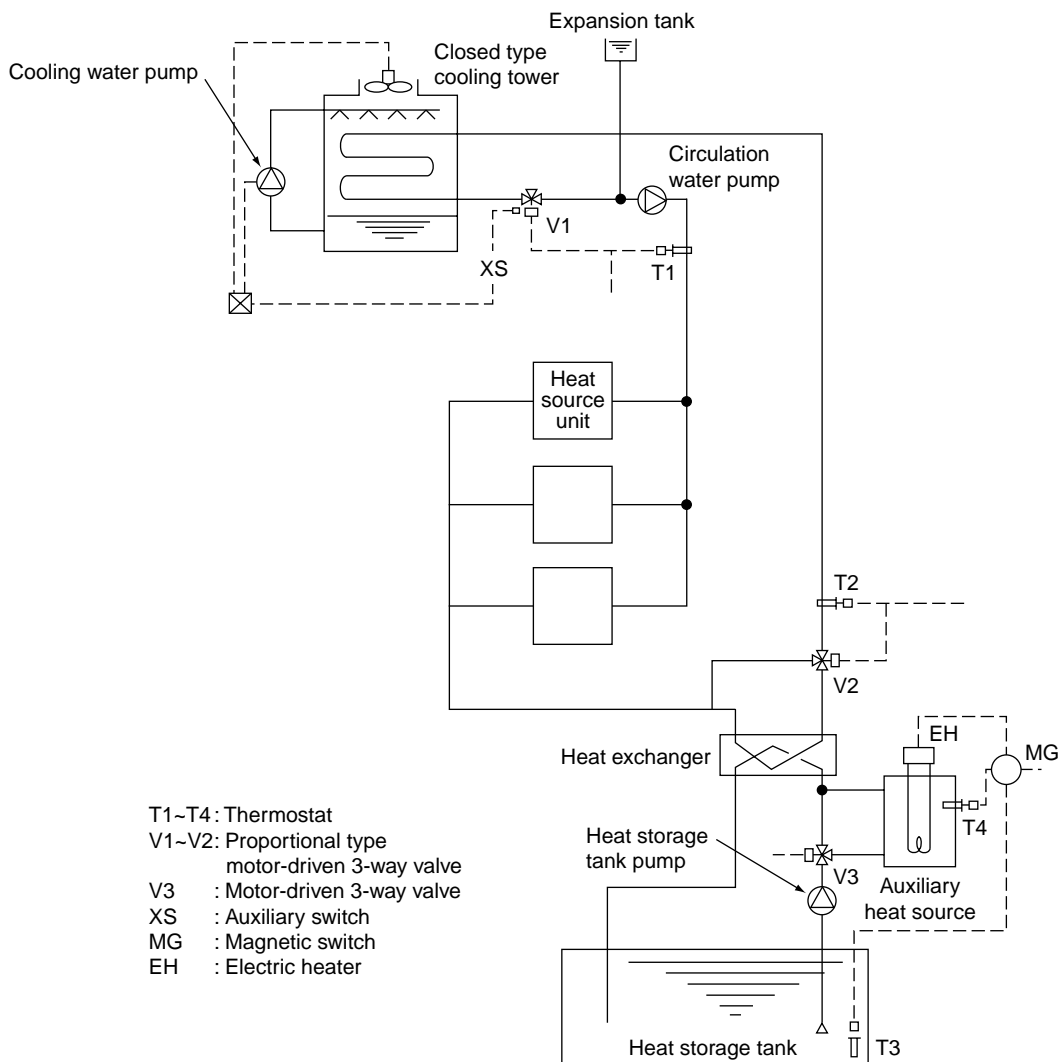

By detecting the circulation water temperature of the water heat source CITY MULTI system with T1 (around 32°C) and T2 (around 20°C), the temperature will be controlled by opening/closing V1 in the summer and V2 in the winter.

In the summer, as the circulation water temperature rises exceeding the set temperature of T1, the bypass port of V1 will open to lower the circulation water temperature. While in the winter, as the circulation water temperature drops, V2 will open following the command of T2 to rise the circulation water temperature.

The water inside the heat storage tank will be heated by the auxiliary heat source by V3 being opened with timer operation in the night-time. The electric heater of the auxiliary heat source will be controlled by T3 and the timer. The start/stop control of the fan and pump of the closed type cooling tower is applied with the step control of the fan and pump following the command of the auxiliary switch XS of V1, that operates only the fan at the light load while the fan and pump at the maximum load thus controlling water temperature and saving motor power.

Example-2 Combination of closed type cooling tower and hot water heat storage tank

- T1 : Proportional type, insertion system thermostat
- T2 : Proportional type, insertion system thermostat
- T3 : Proportional type, insertion system thermostat
- V1 : Proportional type, motor-driven 3-way valve
- V2 : Proportional type, motor-driven 3-way valve
- XS : Auxiliary switch (Duplex switch type)
- SC : Step controller
- R : Relay
- MG : Magnetic

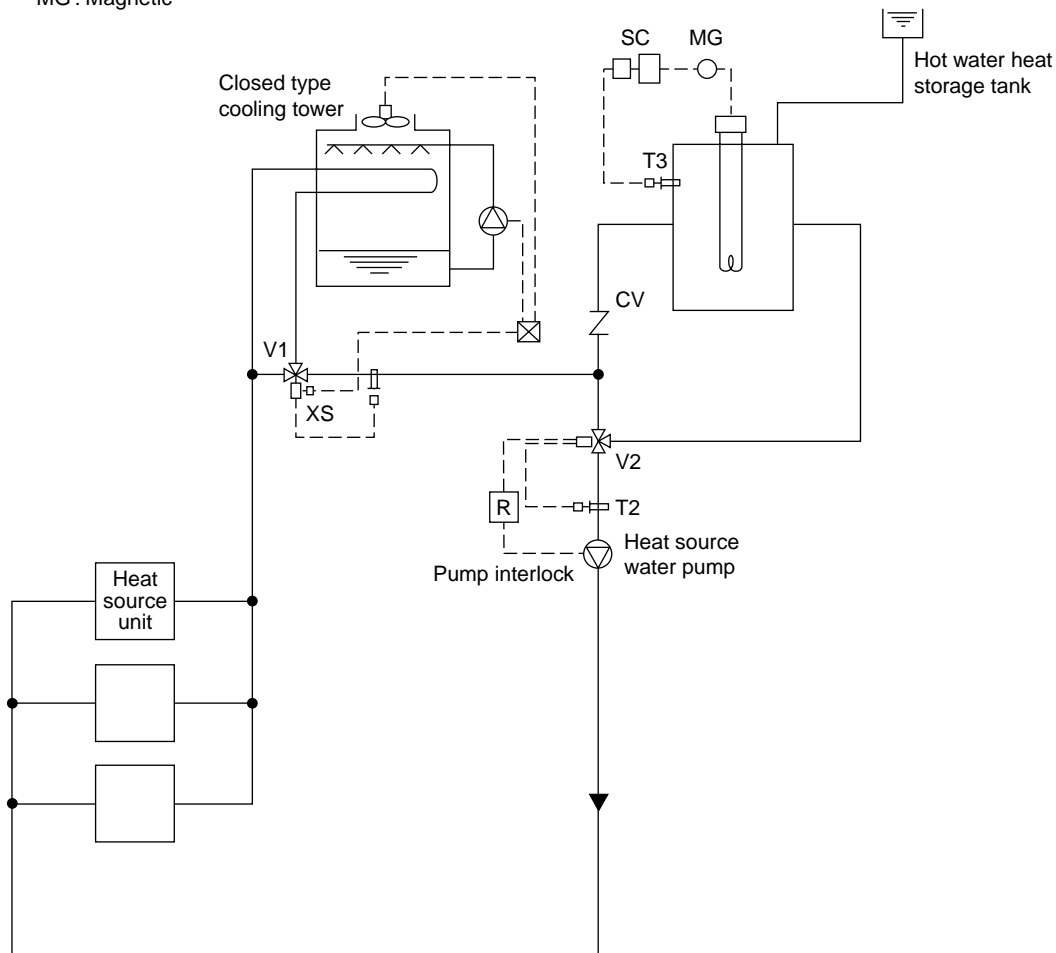

=In the summer, as the circulation water temperature rises exceeding the set temperature of T1, the bypass port of V1 will open to lower the circulation water temperature. In the winter, if the circulation water temperature stays below 25°C, V2 will open/close by the command of T2 to keep the circulation water temperature constant.

The temperature of the hot water inside the heat storage tank will be controlled through the step control of the electric heater by step controller operation following the command of T3.

During the stopping of the heat source water pump, the bypass port of V2 will be closed fully by interlocking thus preventing the high temperature water from entering into the system at the starting of the pump.

The start/stop control of the fan and pump of the closed type cooling tower is applied with the step control of the fan and pump following the command of the auxiliary switch XS of V1, that operates only the fan at the light load while the fan and pump at the maximum load thus controlling water temperature and saving motor power.

Example-3 Combination of closed type cooling tower and boiler

- T1 : Proportional type, insertion system thermostat
- T2 : Proportional type, insertion system thermostat
- T3 : Proportional type, insertion system thermostat
- V1 : Proportional type, motor-driven 3-way valve
- S : Selector switch
- R : Relay
- XS : Auxiliary switch (Duplex switch type)

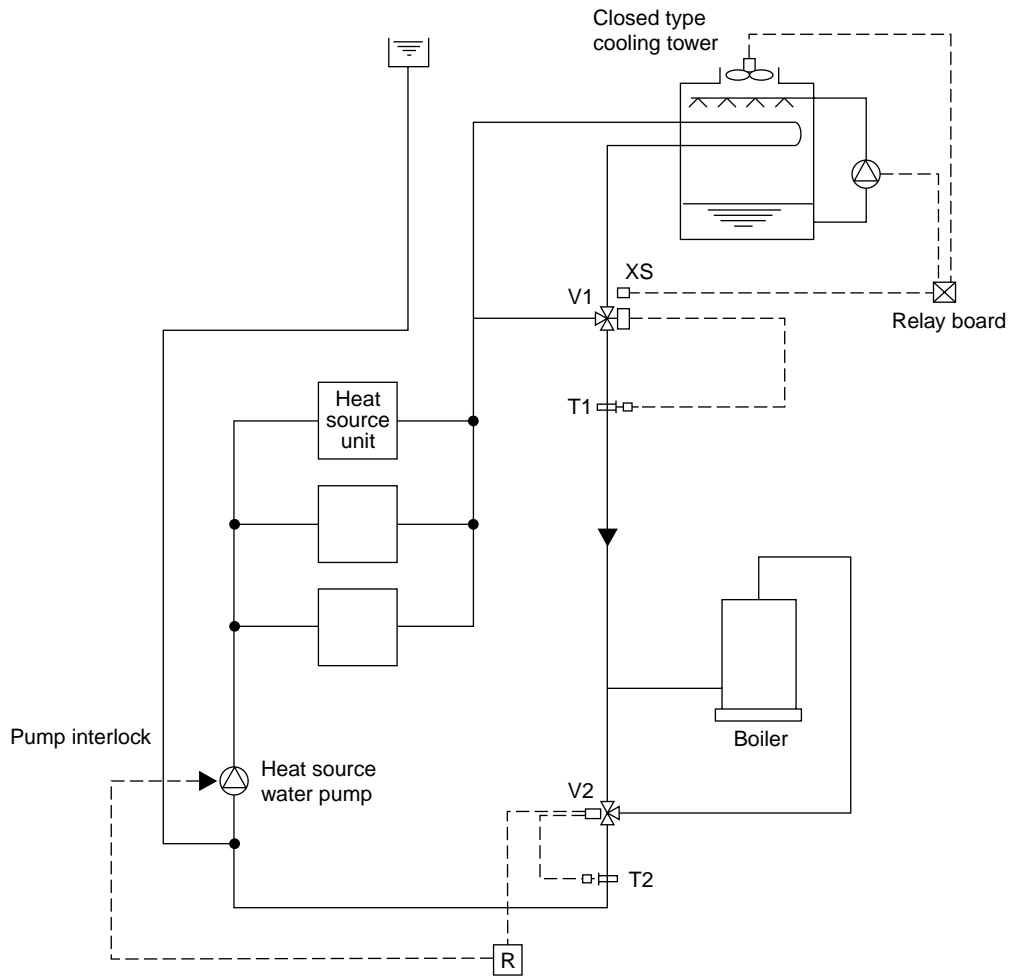

In the summer, as the circulation water temperature rises exceeding the set temperature of T1, the bypass port of V1 will close to lower the circulation water temperature. In the winter, if the circulation water temperature drops below 25°C, V2 will conduct water temperature control to keep the circulation water temperature constant. During the stopping of the heat source water pump, the bypass port of V2 will be closed fully by interlocking. The start/stop control of the fan and pump of the closed type cooling tower is applied with the step control following the command of the auxiliary switch XS of V1, thus controlling water temperature and saving motor power.

WR2(R407C)

Example-4 Combination of closed type cooling tower and heat exchanger (of other heat source)

- T1 : Proportional type, insertion system thermostat
- T2 : Proportional type, insertion system thermostat
- V1 : Proportional type, motor-driven 3-way valve
- V2 : Proportional type, motor-driven 3-way valve
- S : Selector switch
- R : Relay
- XS : Auxiliary switch (Duplex switch type)

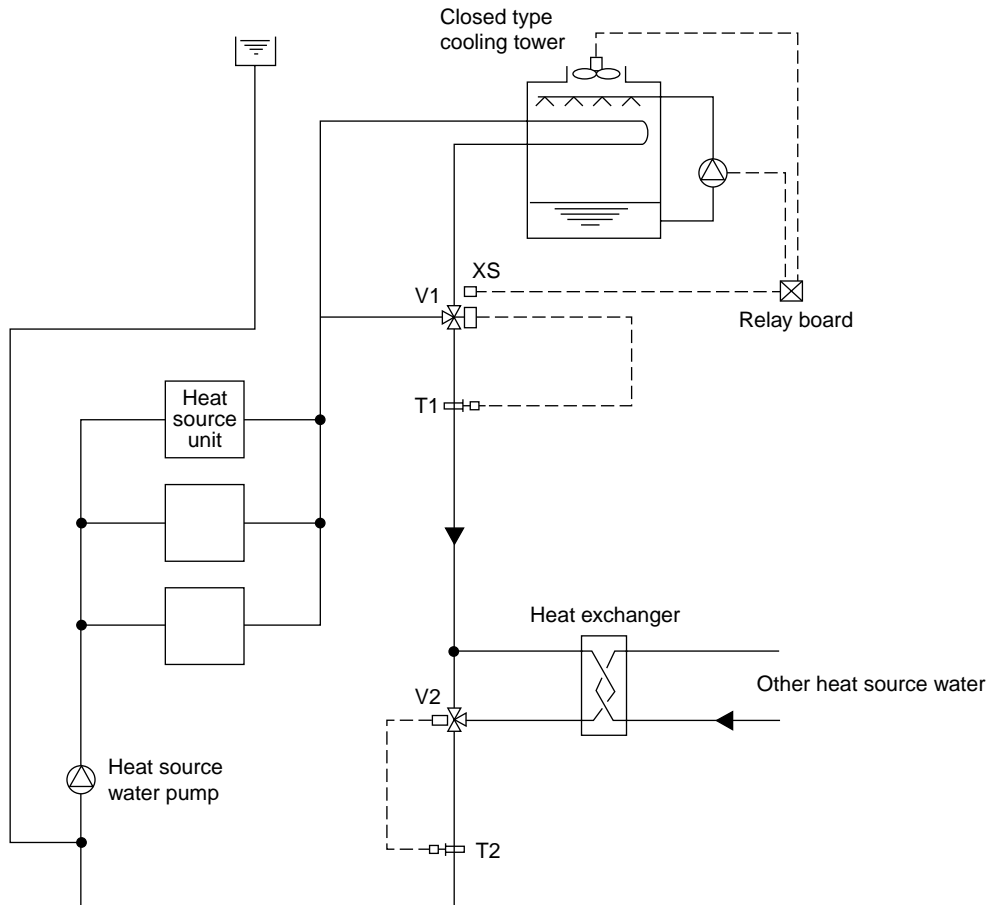

In the summer, as the circulation water temperature rises exceeding the set temperature of T1, the bypass port of V1 will close to lower the circulation water temperature. In the winter, if the circulation water temperature drops below 26°C, V2 will conduct water temperature control to keep the circulation water temperature constant.

During the stopping of the heat source water pump, the bypass port of V2 will be closed fully by interlocking.

The start/stop control of the fan and pump of the closed type cooling tower is applied with the step control following the command of the auxiliary switch XS of V1, thus controlling water temperature and saving motor power.

7) Pump interlock circuit

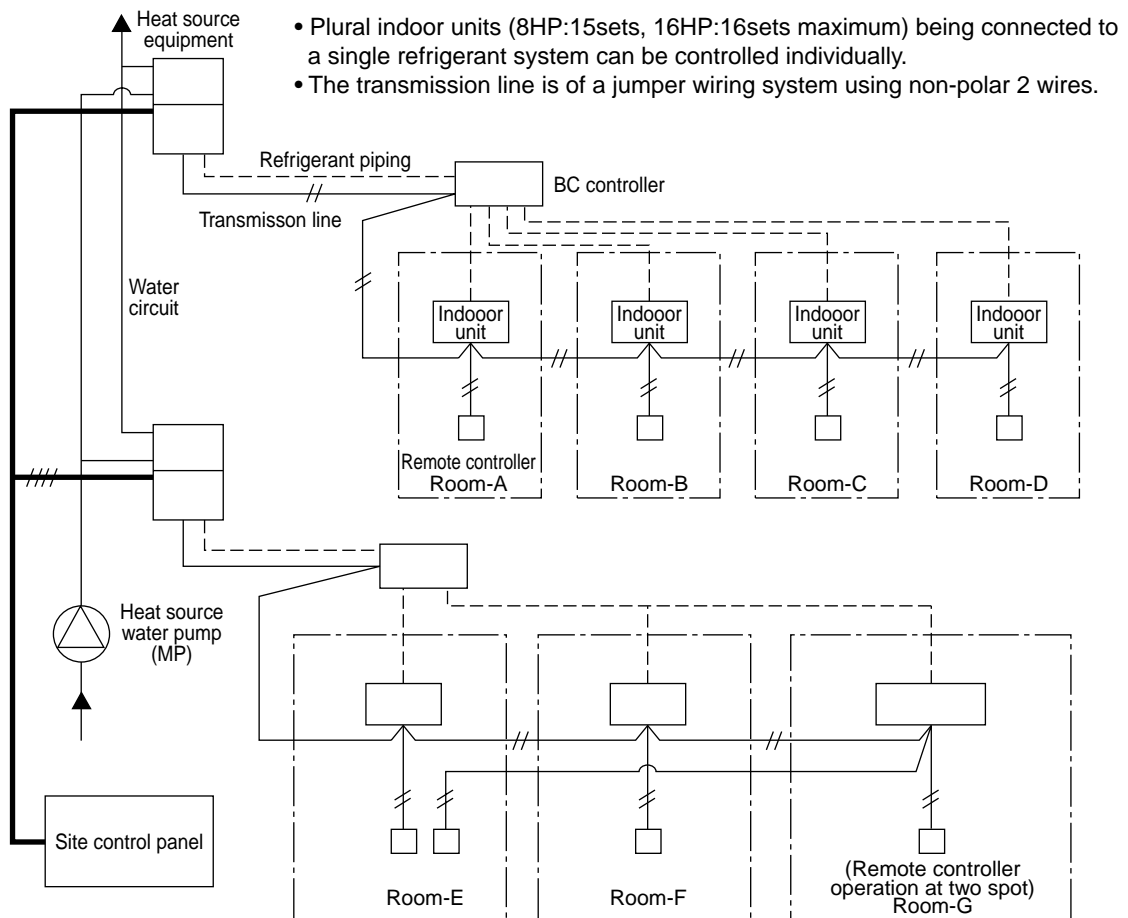

Wiring diagram

This circuit uses the "Terminal block for pump interlock (TB8)" inside the electrical parts box of the heat source equipment. This circuit is for interlocking of the heat source equipment operation and the heat source water pump.

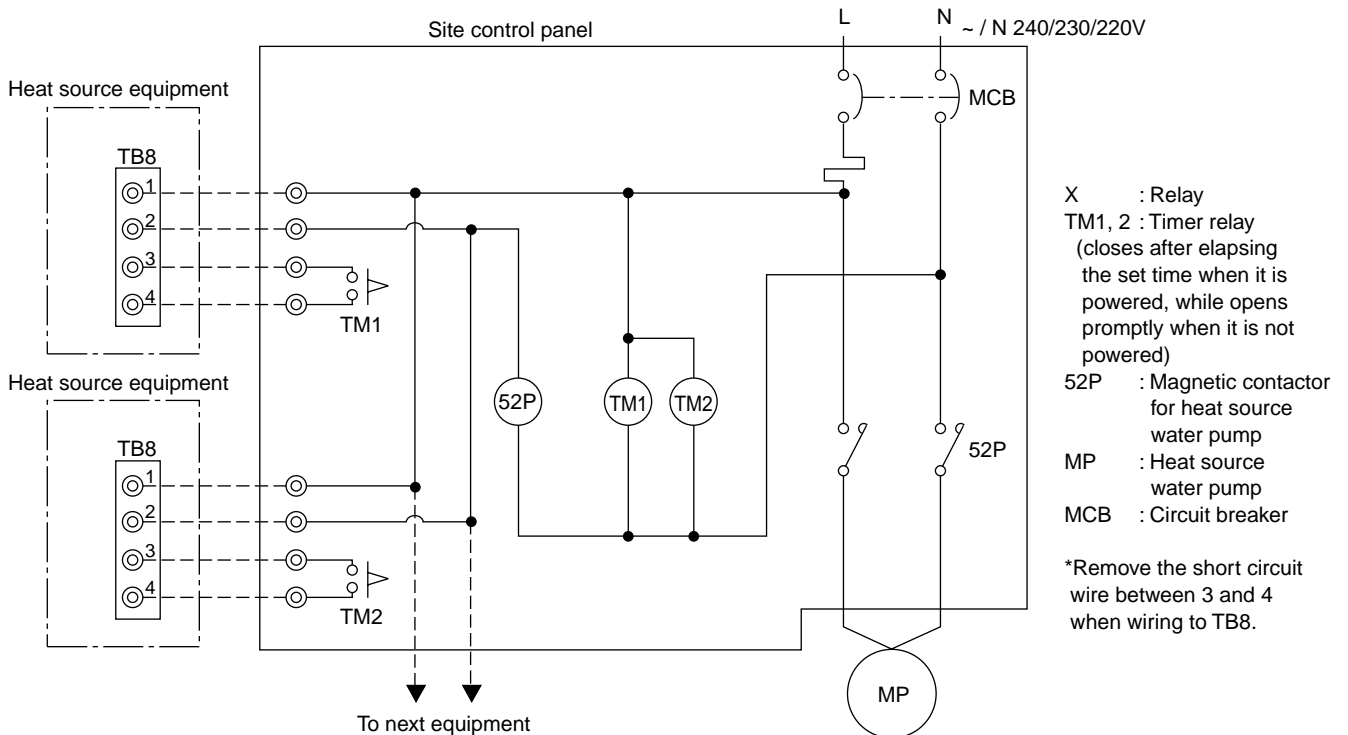

Operation ON signal

Terminal No.	TB8-1, 2
Output	Relay contacts output Rated voltage : L1 - N : 220 ~ 240V Rated load : 1A
Operation	<ul style="list-style-type: none"> • When Dip switch 2-7 is OFF The relay closes during compressor operation. • When DIP switch 2-7 is ON. The relay closes during reception of cooling or the heating operation signal from the controller. (Note : It is output even if the thermostat is OFF (when the compressor is stopped).)

Pump Interlock

Terminal No.	TB8-3, 4
Input	Level signal
Operation	If the circuit between TB8-3 and TB8-4 is open, compressor operation is prohibited.

7-2.WATER PIPING WORK

Although the water piping for the CITY MULTI WR2 system does not differ from that for ordinary air conditioning systems, pay special attention to the items below in conducting the piping work.

1) Items to be observed on installation work

- In order to equalize piping resistance for each unit, adapt the reverse return system.
- Mount a joint and a valve onto the water outlet/inlet of the unit to allow for maintenance, inspection and replacement work. Be sure to mount a strainer at the water inlet piping of the unit. (The strainer is required at the circulation water inlet to protect the heat source unit.)
- * The installation example of the heat source unit is shown right.
- Be sure to provide an air relief opening on the water piping properly, and purge air after feeding water to the piping system.
- Condensate will generate at the low temperature part inside the heat source equipment. Connect drain piping to the drain piping connection located at the bottom of the heat source equipment to discharge it outside the equipment.
- At the center of the header of the heat exchanger water inlet inside the unit, a plug for water discharge is being provided.
Use it for maintenance work or the like.
- Mount a backflow prevention valve and a flexible joint for vibration control onto the pump.
- Provide a sleeve to the penetrating parts of the wall to prevent the piping.
- Fasten the piping with metal fitting, arrange the piping not to expose to cutting or bending force, and pay sufficient care for possible vibration.
- Be careful not to erroneously judge the position of the inlet and outlet of water.
(Lower position : Inlet, Upper position : Outlet)

2) Thermal insulation work

Thermal insulation or antisweating work is not required for the piping inside buildings in the case of the CITY MULTI WR2 system if the operating temperature range of circulation water stays within the temperature near the normal (summer : 30°C, winter : 20°C).

In case of the conditions below, however, thermal insulation is required.

- Use of well water for heat source water
- Outdoor piping portions
- Indoor piping portions where freezing may be caused in winter
- A place where vapor condensation may be generated on piping due to an increase in dry bulb temperature inside the ceiling caused by the entry of fresh outdoor air
- Drain piping portions

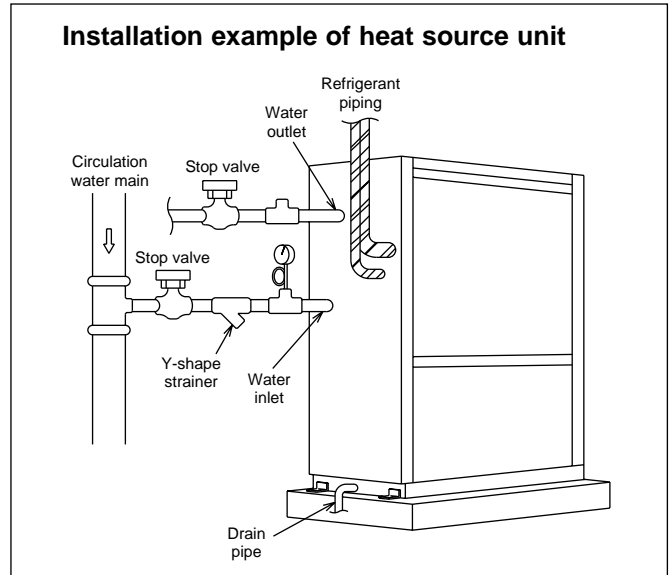

3) Water treatment and water quality control

For the circulation water cooling tower of the CITY MULTI WR2 system, employment of the closed type is recommended to keep water quality. However, in the case that an open type cooling tower is employed or the circulating water quality is inferior, scale will adhere onto the water heat exchanger leading to the decreased heat exchange capacity or the corrosion of the heat exchanger. Be sufficiently careful for water quality control and water treatment at the installation of the circulation water system.

- Removal of impurities inside piping
Be careful not to allow impurities such as welding fragment, remaining sealing material and rust from mixing into the piping during installation work.
- Water treatment

The water quality standards have been established by the industry (Japan Refrigeration, Air Conditioning Industry Association, in case of Japan) for water treatment to be applied.

	Items	Standard values
Standard items	PH(25°C)	7.0 ~ 8.0
	Electric conductivity (25°C)(μs/cm)	300 or less
	Chlorine ion Cl ⁻ (mg/l)	50 or less
	Sulfate ion SO ₄ ²⁻ (mg/l)	50 or less
	M-alkalinity CaCO ₃ (mg/l)	50 or less
	Total hardness CaCO ₃ (mg/l)	70 or less
	Iron Fe (mg/l)	1.0 or less
Reference items Note.1	Sulfur ion S ²⁻ (mg/l)	Not be detected
	Ammonium ion NH ₄ ⁺ (mg/l)	Not be detected
	Silica SiO ₂ (mg/l)	30 or less

Note.1 It is clearly found that the component of the reference items will be hazardous, however, the quantitative relationship between the content and hazard has not been clarified yet. Therefore, they are listed as the reference items.

In order to keep the water quality within such standards, you are kindly requested to conduct bleeding-off by overflow and periodical water quality tests, and use inhibitors to suppress condensation or corrosion. Since piping may be corroded by some kinds of inhibitor, consult an appropriate water treatment expert for proper water treatment.

WR2(R407C)

(4) Pump interlock

Operating the heat source unit without circulation water inside the water piping can cause a trouble. Be sure to provide interlocking for the unit operation and water circuit. Since the terminal block is being provided inside the unit, use it as required.

PUMY-71VM
PUMY-125VMA

CONTENTS

1. Specifications	I -152
2. Capacity Tables	I -154
2-1 Correction by temperature	I -154
2-2 Correction by total indoor	I -156
2-3 Correction by refrigerant piping length	I -157
2-4 Correction at frosting and defrosting	I -158
2-5 Operation limit	I -158
3. Sound Levels	I -159
4. External Dimensions	I -160
5. Electrical Wiring Diagram	I -162
6. Refrigerant Circuit Diagram	I -164
And Thermal Sensor	

S-VM(R22)

1. Specifications

S-VM(R22)

Model name		PUMY-71VM	
		Cooling	Heating
Capacity	kcal/h	7,100	8,000
	kW	8.3	9.3
	BTU/h	28,200	31,800
Power source		~N 220-230-240V 50Hz / 220V 60Hz	
Power input	kW	3.50/3.63	3.65/3.53
Current	A	17.5-16.7-16.0/18.1	18.2-17.4-16.0/17.6
Fan	Type X Quantity	Propeller fan X 2	
	Airflow rate	m ³ /min	95
	Motor output	kW	0.04 X 2
Compressor	Type	Hermetic	
	Motor output	kW	2.6
	Crankcase heater	kW	-
Refrigerant / Lubricant		R22/MS56	
External finish		Steel plate painting with polyester powder <MUNSELL 5Y8/1>	
External dimension	mm	1200(H)X900(W)X320(+30)(D)	
Protection devices	High pressure protection	3.0MPa	
	Compressor / Fan	Internal thermal switch / Internal thermal switch	
	Inverter	Over current protection, Overheat protection	
Refrigerant piping diameter	Liquid / Gas	φ 9.52 / φ 15.88 (Flare)	
Indoor unit	Total capacity	50 ~ 130% of outdoor unit capacity	
	Model / Quantity	Model 20 ~ 80 / 1 ~ 4	
Noise level	* dB<A>	52	
Net weight	kg	93	
Operating temperature range		Indoor:15°CWB ~ 24°CWB Outdoor:-5°CDB ~ 46°CDB	Indoor:15°CDB ~ 27°CDB Outdoor:-15°CWB ~ 15.5°CWB

Note: 1.Cooling/heating capacity indicates the maximum value at operation under the following condition.

Cooling Indoor : 27°CDB/19.5°CWB Outdoor : 35°CDB
Heating Indoor : 21°CDB Outdoor : 7°CDB/6°CWB
 Pipe length : 5m Height difference : 0m

* It is measured in anechoic room.

Model name		PUMY-125VMA	
		Cooling	Heating
Capacity	kcal/h	12,500	14,000
	kW	14.5	16.3
	BTU/h	49,600	55,600
Power source		~N 220-230-240V 50Hz / 220V 60Hz	
Power input	kW	6.57/6.43	6.10/6.03
Current	A	34.9-33.5-32.2/33.6	32.6-31.2-29.9/31.5
Fan	Type X Quantity		Propeller fan X 2
	Airflow rate	m ³ /min	90
	Motor output	kW	0.06 X 2
Compressor	Type		Hermetic
	Motor output	kW	3.5
	Crankcase heater	kW	-
Refrigerant / Lubricant		R22/MS32(N-1)	
External finish		Steel plate painting with polyester powder <MUNSELL 5Y8/1>	
External dimension	mm	1280(H)X1020(W)X350(+30)(D)	
Protection devices	High pressure protection		3.0MPa
	Compressor / Fan		Internal thermal switch / Internal thermal switch
	Inverter		Over current protection, Overheat protection
Refrigerant piping diameter	Liquid / Gas	φ9.52 / φ19.05 (Flare)	
Indoor unit	Total capacity		50 ~ 130% of outdoor unit capacity
	Model / Quantity		Model 20 ~ 125 / 1 ~ 8
Noise level	*	dB<A>	54
Net weight		kg	130
Operating temperature range		Indoor:15°CWB ~ 24°CWB Outdoor:-5°CDB ~ 46°CDB	Indoor:15°CDB ~ 27°CDB Outdoor:-15°CWB ~ 15.5°CWB

Note: 1.Cooling/heating capacity indicates the maximum value at operation under the following condition.

Cooling Indoor : 27°CDB/19.5°CWB Outdoor : 35°CDB
Heating Indoor : 21°CDB Outdoor : 7°CDB/6°CWB
 Pipe length : 5m Height difference : 0m

* It is measured in anechoic room.

2. Capacity Table

2-1. Correction by temperature

Cooling

- Standard Specifications

		PUMY-71	PUMY-125
Capacity	kW	8.3	14.5
Input	kW	3.50 / 3.63	6.57 / 6.43

S-VN(R22)

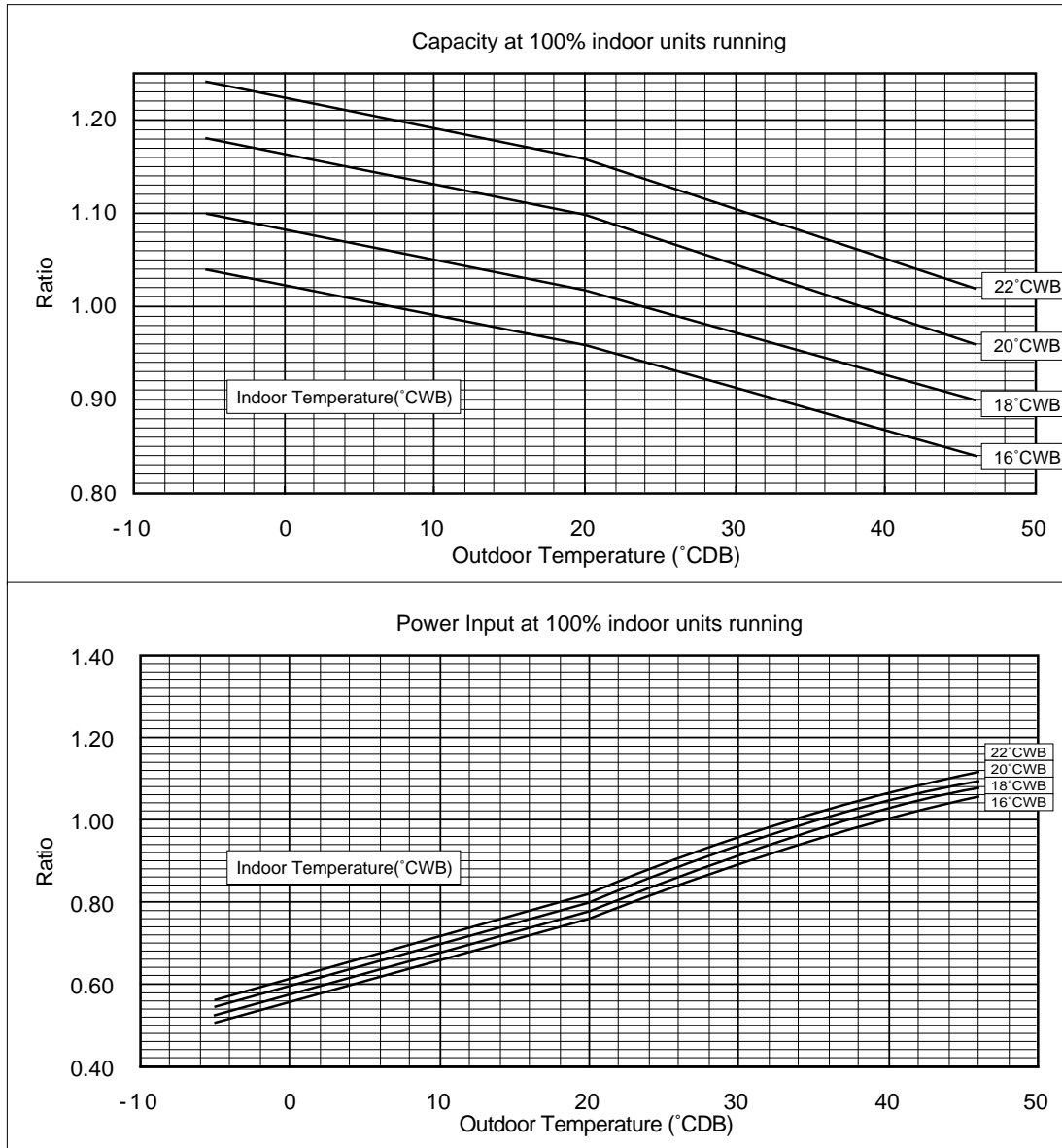

Heating

- Standard Specifications

		PUMY-71	PUMY-125
Capacity	kW	9.3	16.3
Input	kW	3.65/3.53	6.10/6.03

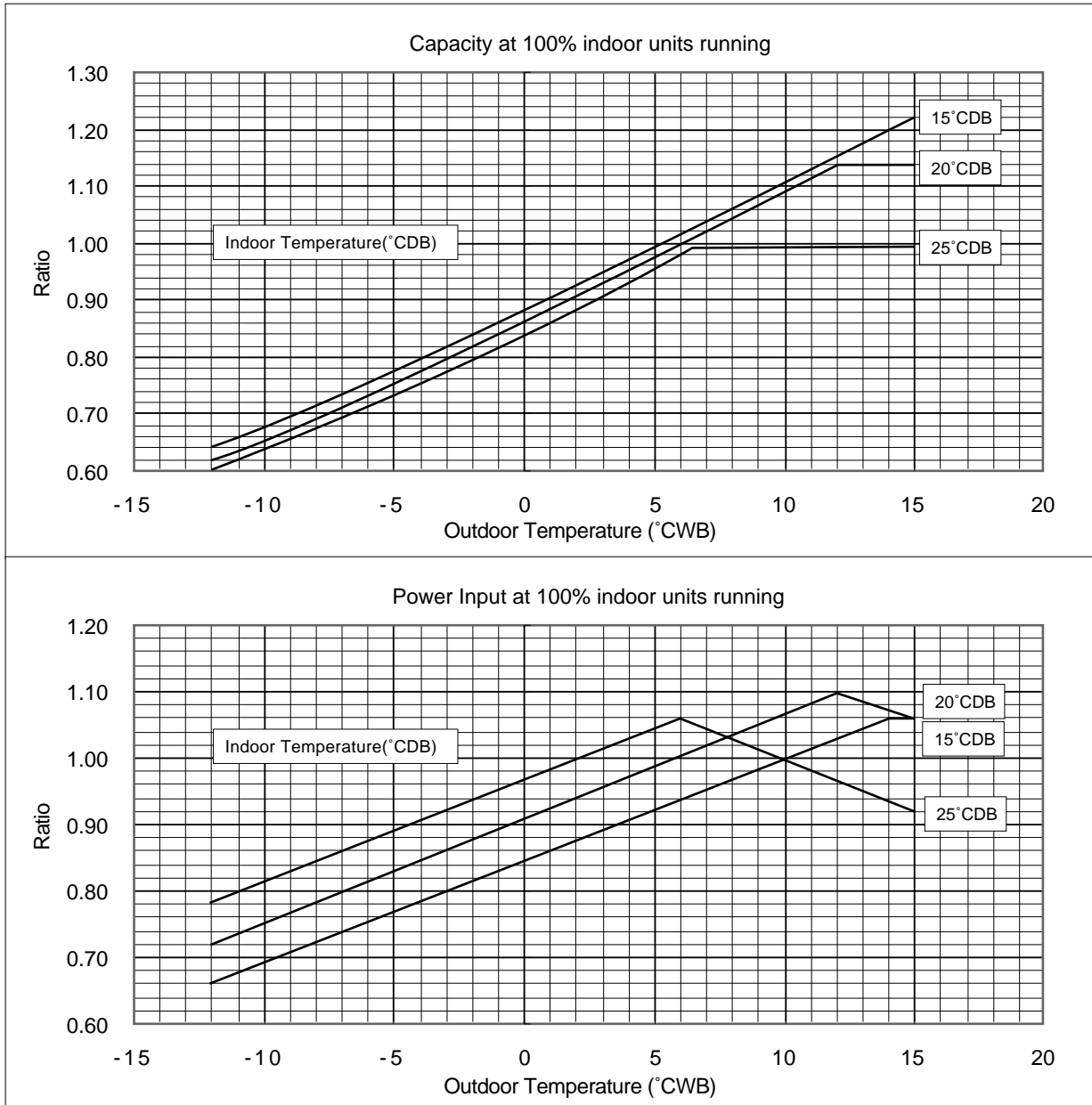

S-VM(R22)

2-2. Correction by total indoor

PUMY-71

1) Capacity

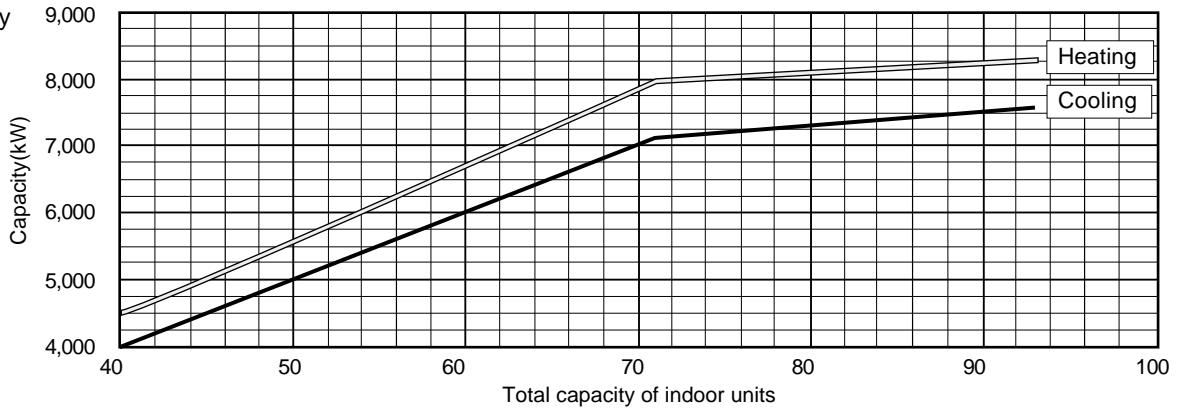

2) Input

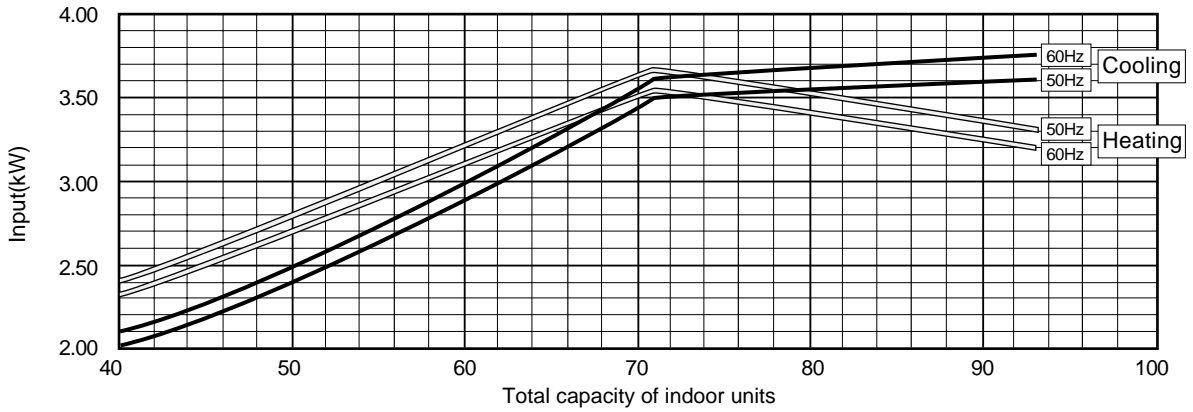

PUMY-125

1) Capacity

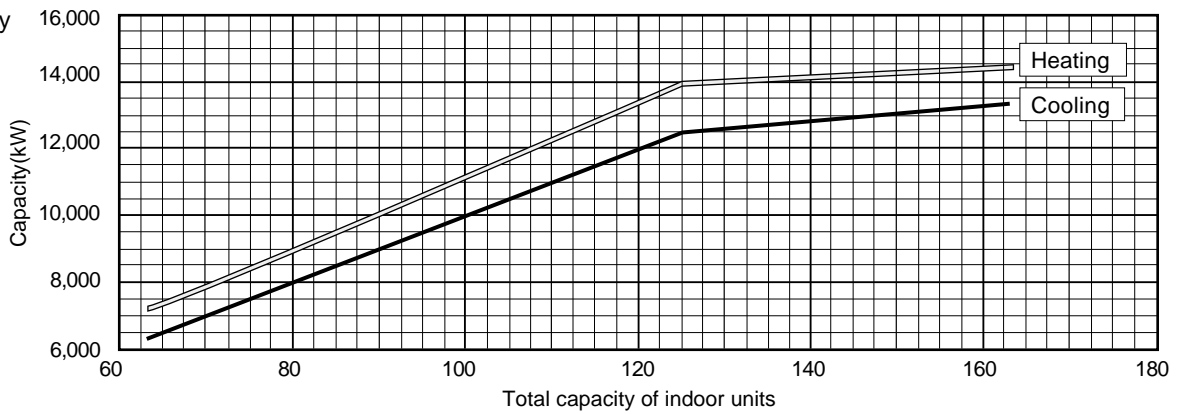

2) Input



2-3. Correction by refrigerant piping length

To obtain a decrease in cooling/heating capacity due to refrigerant piping extension, multiply by the capacity correction factor based on the refrigerant piping equivalent length in the table below.

• Cooling capacity correction

PUMY-71

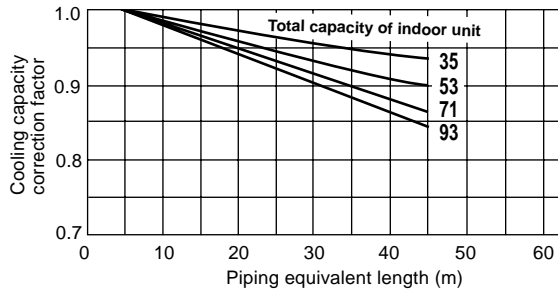

PUMY-125

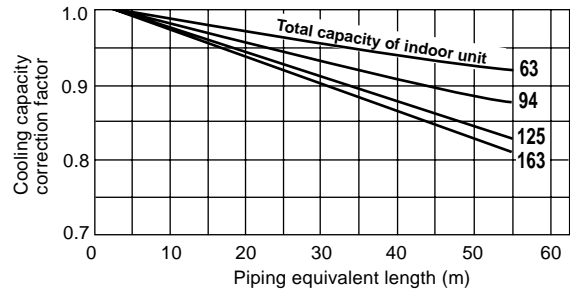

• Heating capacity correction

PUMY-71

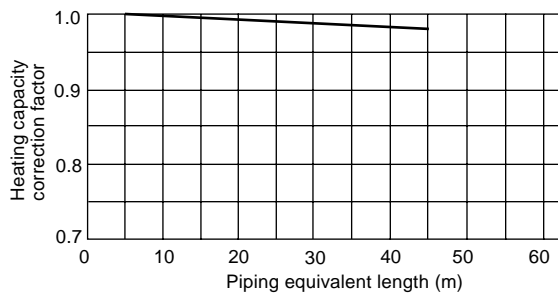

PUMY-125

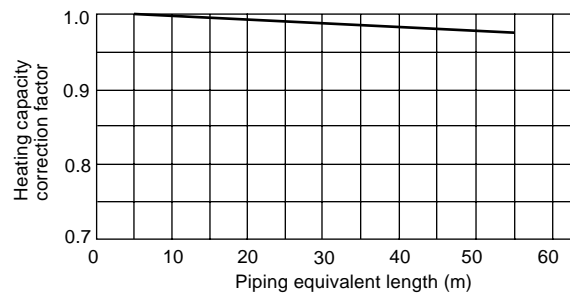

• How to obtain piping equivalent length

① PUMY-71

Equivalent length = (Actual piping length to the farthest indoor unit) + (0.3 × number of bent on the piping)m

② PUMY-125

Equivalent length = (Actual piping length to the farthest indoor unit) + (0.35 × number of bent on the piping)m

2-4. Correction at frosting and defrosting

When a decrease in heating capacity due to frosted and defrosting operations is considered, the value multiplied by the correction factor in the table below represents the heating capacity.

Correction factor table

Outdoor inlet air temp (°CWB)	6	4	2	0	-2	-4	-6	-8	-10
Correction factor	1.0	0.98	0.89	0.88	0.89	0.9	0.95	0.95	0.95

2-5. Operation limit

• Cooling

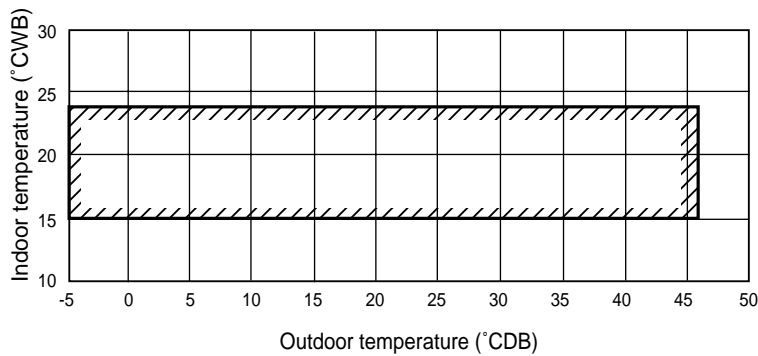

• Heating

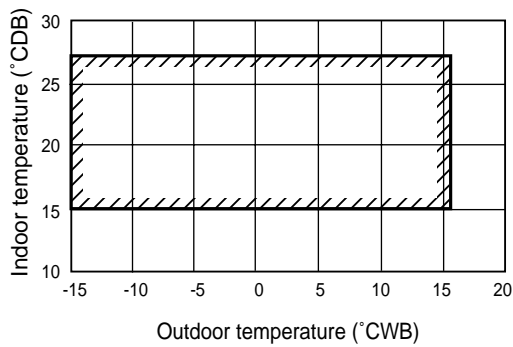

3. Sound Levels

PUMY-71

Measurement condition

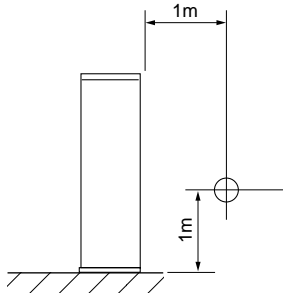

Sound pressure level in anechoic room

57 dB (A)

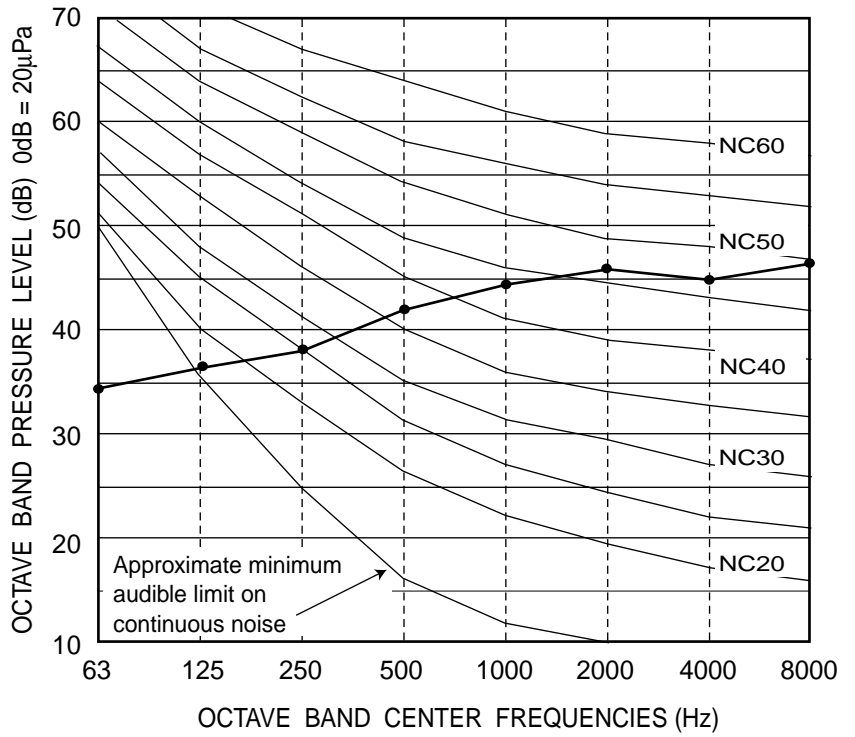

S-VM(R22)

PUMY-125

Measurement condition

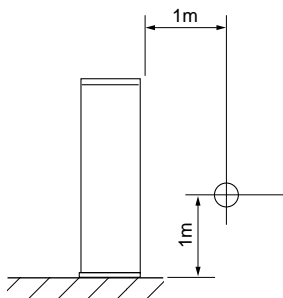

Sound pressure level in anechoic room

58 dB (A)

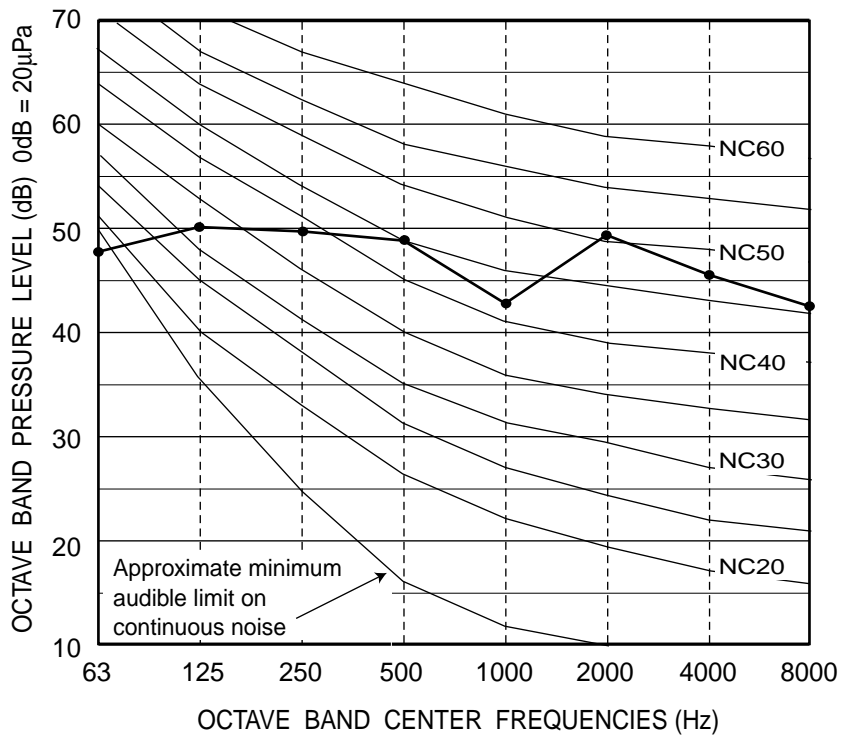

4. External Dimensions

S-VM (R22)

PUMY-71VM

Unit : mm

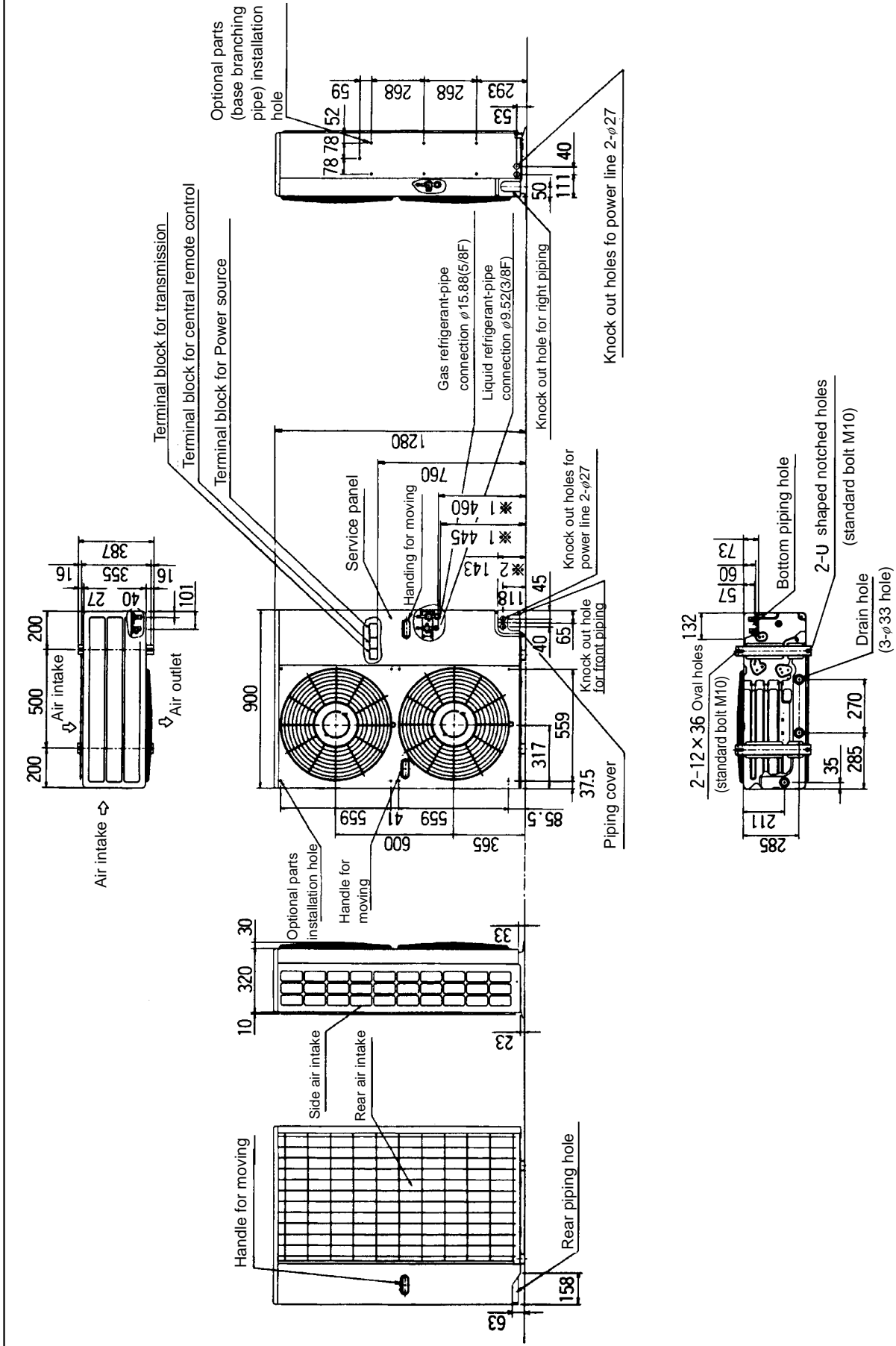

- *1...Indicates the dimensions of the cutoff valve connector.
- *2...Make sure that the panel can be easily removed for maintenance when a piping cover is used for aesthetic reasons.

PUMY-125VMA

Unit : mm

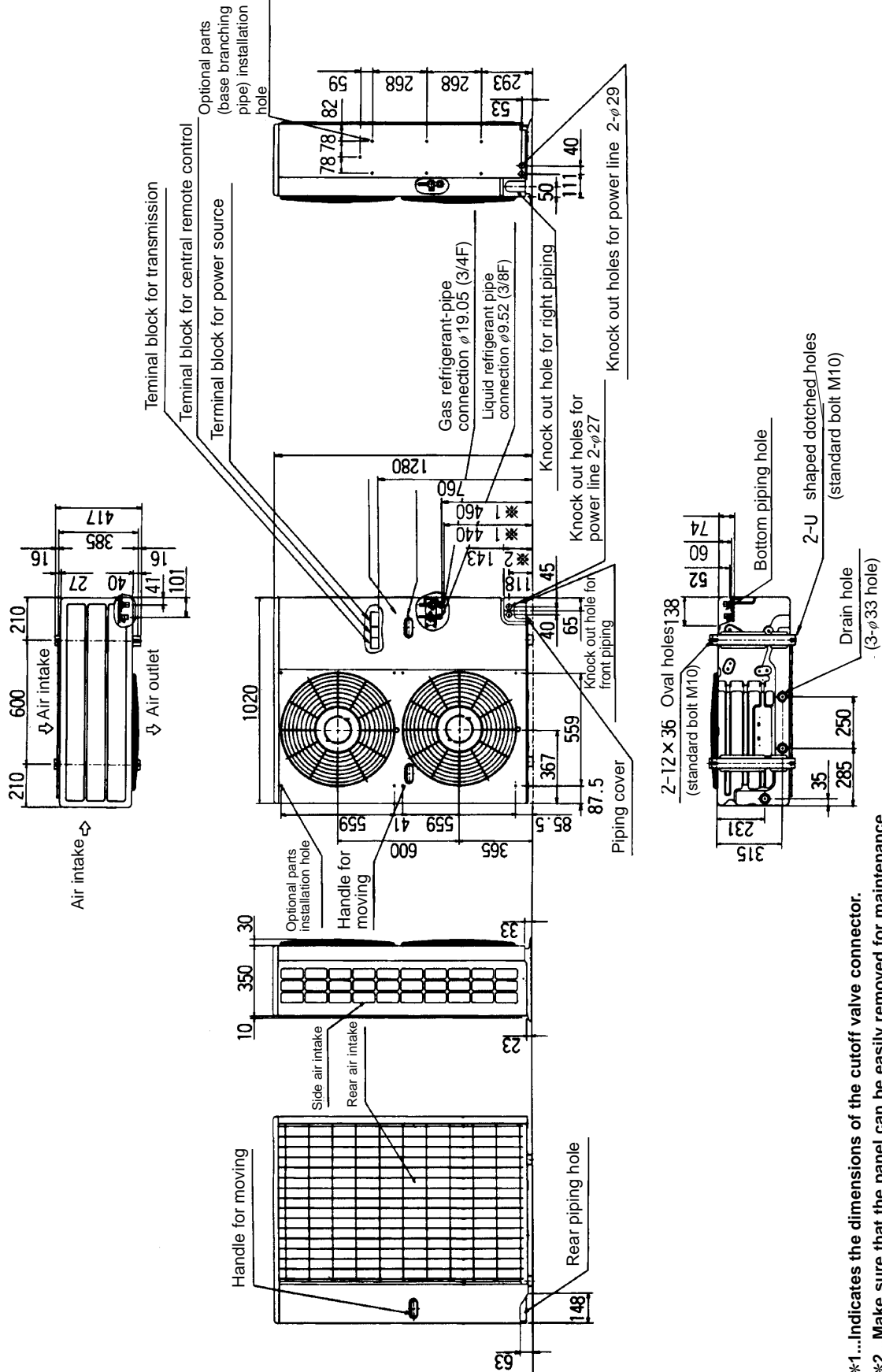

*1...Indicates the dimensions of the cutoff valve connector.
 *2...Make sure that the panel can be easily removed for maintenance when a piping cover is used for aesthetic reasons.



5. Electrical Wiring Diagram

PUMY-71VM

S-VM(R22)

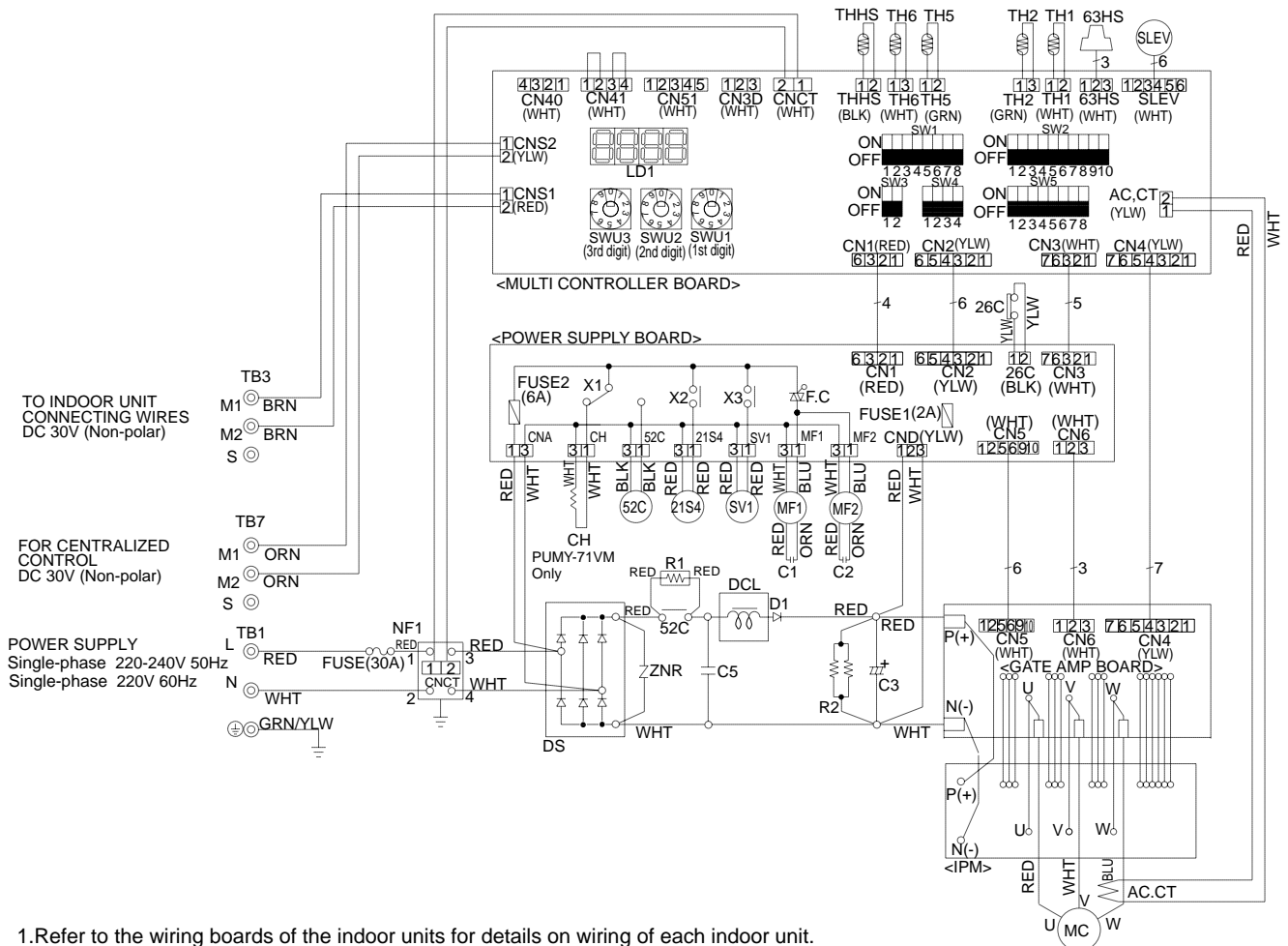

1. Refer to the wiring boards of the indoor units for details on wiring of each indoor unit.
2. The transmission line is two-wire type and has no polarity.
3. Mark ⊙ shows the terminal board, mark □ the connector. Symbols in parentheses () show the colors of connectors.
4. Self-diagnosis function
 The indoor and outdoor units can be diagnosed automatically using the self-diagnosis switch (SW1) and LD1 (LED indication) found on the multi-controller of the outdoor unit.
 LED indication : Set all contacts of SW1 to OFF

<SYMBOL EXPLANATION>

SYMBOL	NAME	SYMBOL	NAME	SYMBOL	NAME
AC,CT	Current detection	F.C	Fan control	TB3	Terminal block <Transmission>
CH	Crankcase heater	FUSE1	Fuse(2A)	TB7	Terminal block <Transmission> (Centralized control)
CNA	Connector <Power supply>	FUSE2	Fuse(6A)	THHS	Thermistor <IPM Radiator panel temperature detection>
CND	Connector <DC Power supply>	FUSE	Fuse(30A)	TH1	Thermistor <Discharge temperature detection>
CNS1	Connector <Multi system>	IPM	Intelligent power module	TH2	Thermistor <Low pressure saturated temperature detection>
CNS2	Connector <Centralized control>	LD1	Digital indication LED <Operation inspection indication>	TH5	Thermistor <Pipe temperature detection, judging defrost>
CN1	Connector <Controller drive control>	MC	Compressor	TH6	Thermistor <Outdoor temperature detection>
CN2	Connector <Power sync signal, protection>	MF1,2	Fan motor (Inner thermostat)	X1	Relay <Crankcase heater, magnetic contactor>
CN3	Connector <Power supply 30V, 12V, 5V>	NF1	Noise filter	X2	Relay <4-way valve>
CN4	Connector <Inverter signal 5V>	R1	Resistor <Rush current protect>	X3	Relay <Solenoid valve>
CN5	Connector <IPM power supply>	R2	Resistor <Discharge>	ZNR	Varistor
CN6	Connector <IPM power supply, trouble output>	SLEV	Expansion valve	21S4	4-Way valve
CN40	Connector <Centralized control power supply>	SV1	Solenoid valve <Hot gas bypass>	26C	Thermal switch <Compressor>
CN41	Connector <For storing jumper connector>	SW1	Switch <Display selection selfdiagnosis>	52C	Magnetic contactor <Inverter main circuit>
CN51	Connector <Compressor drive signal output>	SW2	Switch <Function selection>	63HS	High pressure sensor <Discharge pressure detection>
CN3D	Connector <Demand signal, silent mode input>	SW3	Switch <Test run>		
CNCT	Connector <Current detection>	SW4	Switch <Model selection>		
C1,2	Fan motor capacitor	SW5	Switch <Function selection>		
C3	Capacitor <Smoothing>	SWU1	Switch <Unit address selection, 1st digit>		
C5	Capacitor <Power factor improvement>	SWU2	Switch <Unit address selection, 2nd digit>		
DS	Diode stack	SWU3	Switch <Unit address selection, 3rd digit>		
D1	Diode <Power factor improvement>	TB1	Terminal block <Power supply>		
DCL	Reactor				

PUMY-125VMA

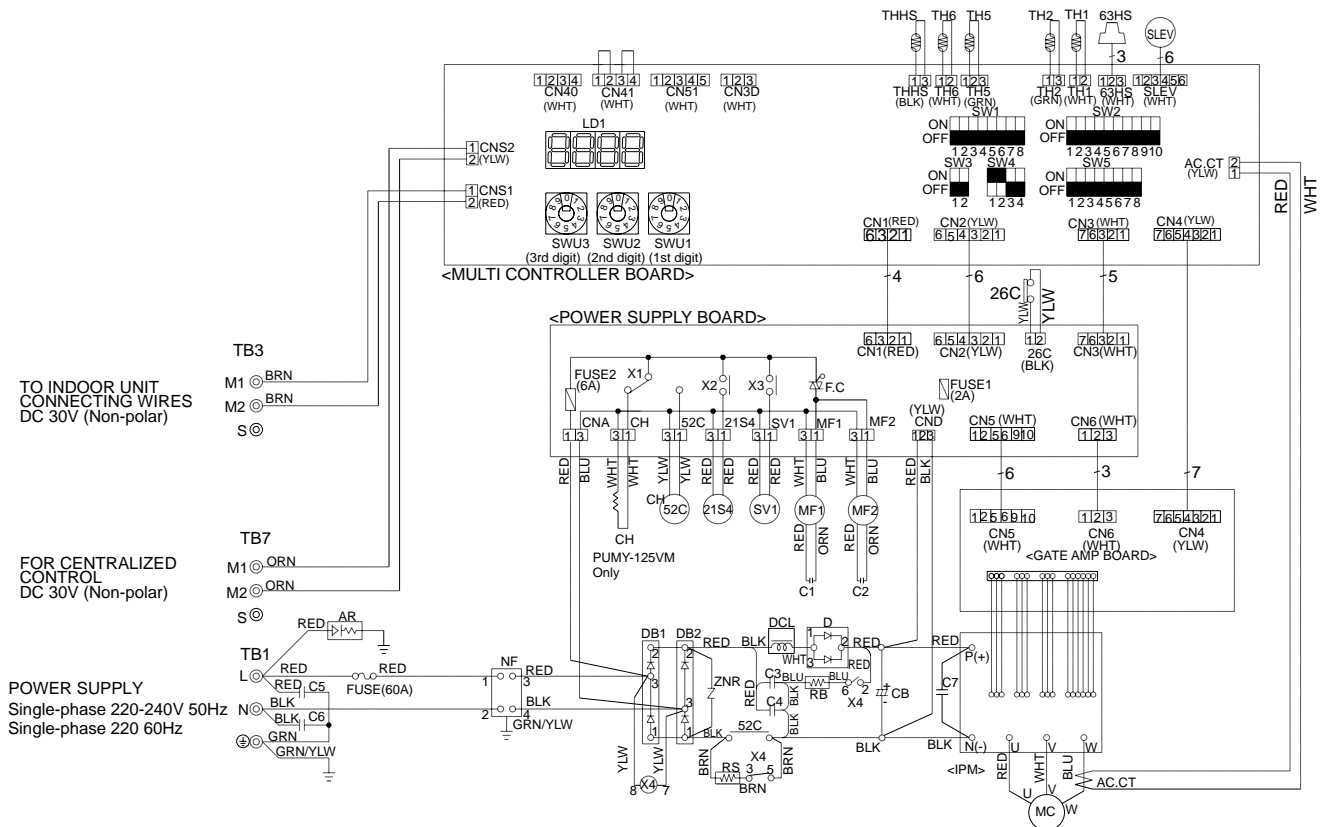

S-VMA(R22)

1. Refer to the wiring boards of the indoor units for details on wiring of each indoor unit.
2. The transmission line is two-wire type and has no polarity
3. Mark \odot shows the terminal board, mark \square the connector. Symbols in parentheses () show the colors of connectors.
4. Self-diagnosis function
The indoor and outdoor units can be diagnosed automatically using the self-diagnosis switch(SW1) and LD1(LED indication) found on the multi-controller of the outdoor unit.
LED indication : Set all contacts of SW1 to OFF.

<SYMBOL EXPLANATION>

SYMBOL	NAME	SYMBOL	NAME	SYMBOL	NAME
AC,CT	Current detection	DCL	Reactor	TB3	Terminal block <Transmission>
AR	Surge absorber	F.C	Fan control	TB7	Terminal block <Transmission> (Centralized control)
CB	Smoothing capacitor	FUSE1	Fuse(2A)	THHS	Thermistor <IPM radiator panel temperature detection>
CH	Crankcase heater	FUSE2	Fuse(6A)	TH1	Thermistor <Discharge temperature detection>
CNA	Connector <Power supply>	IPM	Intelligent power module	TH2	Thermistor <Low pressure saturated temperature detection>
CND	Connector <DC Power supply>	LD1	Digital indication LED <Operation inspection indication>	TH5	Thermistor <Pipe temperature detection, judging defrost>
CNS1	Connector <Multi system>	MC	Compressor	TH6	Thermistor <Outdoor temperature detection>
CNS2	Connector <Centralized control>	MF1,2	Fan motor (Inner thermostat)	X1	Relay <Crankcase heater, magnetic contactor>
CN1	Connector <Controller drive control>	NF	Noise filter	X2	Relay <4-way valve>
CN2	Connector <Power sync signal protection>	RB	Resistor <Discharge>	X3	Relay <Solenoid valve>
CN3	Connector <Power supply 30V, 12V, 5V>	RS	Resistor <Rush current protect>	X4	Relay
CN4	Connector <Inverter signal 5V>	SLEV	Expansion valve	ZNR	Varistor
CN5	Connector <IPM Power supply>	SV1	Solenoid valve <Hot gas bypass>	21S4	4-way valve
CN6	Connector <IPM Power supply, trouble output>	SW1	Switch <Display selection selfdiagnosis>	26C	Thermal switch <Compressor>
CN40	Connector <Centralized control power supply>	SW2	Switch <Function selection>	52C	Magnetic contactor <Inverter main circuit>
CN41	Connector <For storing jumper connector>	SW3	Switch <Test run>	63HS	High pressure sensor <Discharge pressure detection>
CN51	Connector <Compressor drive signal output>	SW4	Switch <Model selection>		
CN3D	Connector <Demand signal, silent mode input>	SW5	Switch <Function selection>		
C1,2	Fan motor capacitor	SWU1	Switch <Unit address selection, 1st digit>		
C3,4	Capacitor <Power factor improvement>	SWU2	Switch <Unit address selection 2nd digit>		
C5,6	Capacitor	SWU3	Switch <Unit address selection 3rd digit>		
C7	Capacitor <Filter>	TB1	Terminal block <Power supply>		
D	Diode <Power factor improvement>				
DB1,DB2	Diode stack				

6. Refrigerant Circuit Diagram And Thermal Sensor

PUMY-71, 125

S-VN (R22)

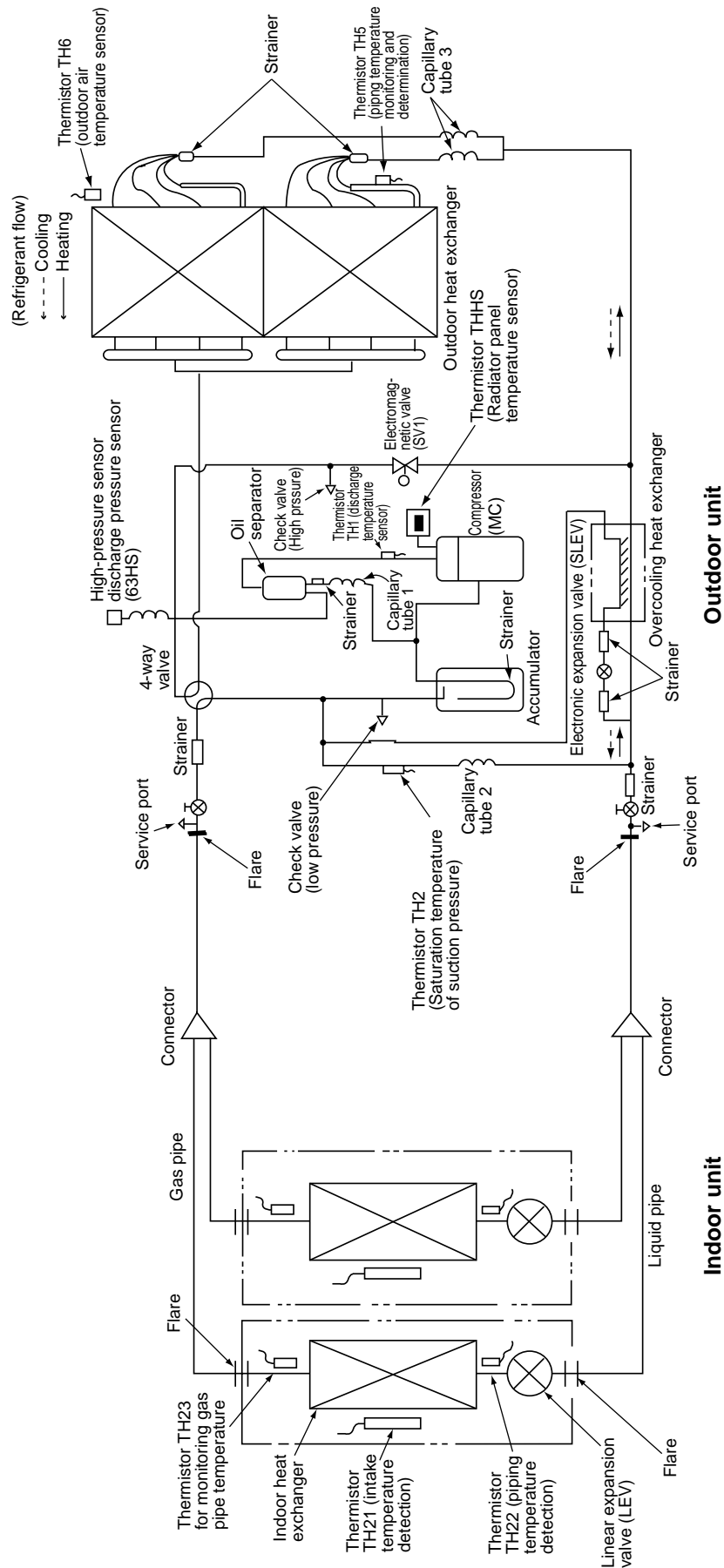

PUMY-125YM
PUMY-125YMA

CONTENTS

1. Specifications	I -166
2. Capacity Tables	I -167
2-1 Correction by temperature	I -167
2-2 Correction by total indoor	I -169
2-3 Correction by refrigerant piping length	I -170
2-4 Correction at frosting and defrosting	I -171
2-5 Operation limit	I -171
3. Sound Levels	I -172
4. External Dimensions	I -173
5. Electrical Wiring Diagram	I -174
6. Refrigerant Circuit Diagram	I -176
And Thermal Sensor	

S-YM(R22)

1. Specifications

Model name			PUMY-125YM PUMY-125YMA	
			Cooling	Heating
Capacity	*1	kW	14.0	16.0
	*2	kcal/h	12,500	—
Power source			3N ~ 380/400/415V 50Hz	
Power input		kW	5.95	5.58
Current		A	9.6/9.1/8.8	9.0/8.6/8.3
Fan	Type X Quantity		Propeller fan X 2	
	Airflow rate	m ³ /min	90	
	Motor output	kW	0.06 X 2	
Compressor	Type		Hermetic	
	Motor output	kW	3.5	
	Crankcase heater	kW	—	
Refrigerant / Lubricant			R22/MS32(N-1)	
External finish			Steel plate painting with polyester powder <MUNSELL 5Y8/1>	
External dimension		mm	1280(H)X1020(W)X350+30(D)	
Protection devices	High pressure protection		3.0MPa	
	Compressor / Fan		Internal thermal switch / Internal thermal switch	
	Inverter		Over current protection , Overheat protection	
Refrigerant piping diameter		Liquid / Gas	φ 9.52 / φ 19.05 (Flare)	
Indoor unit	Total capacity		50 ~ 130% of outdoor unit capacity	
	Model / Quantity		Model 20 ~ 125 / 1 ~ 8	
Noise level		* dB<A>	54	
Net weight		kg	127	
Operating temperature range			Indoor:15°CWB ~ 24°CWB Outdoor:-5°CDB ~ 46°CDB	Indoor:15°CDB ~ 27°CDB Outdoor:-15°CWB ~ 15.5°CWB

Note: 1.Cooling/heating capacity indicates the maximum value at operation under the following condition.

*1 Cooling Indoor : 27°CDB/19°CWB	Outdoor : 35°CDB	*2 Cooling Indoor : 27°CDB/19.5°CWB	Outdoor : 35°CDB
Heating Indoor : 20°CDB	Outdoor : 7°CDB/6°CWB	Pipe length : 5m	Height difference : 0m
Pipe length : 7.5m	Height difference : 0m		

* It is measured in anechoic room.

2. Capacity Tables

2-1. Correction by temperature

Cooling

- Standard Specifications

		PUMY-125YM,YMA
Capacity	kW	14.0
Input	kW	5.95

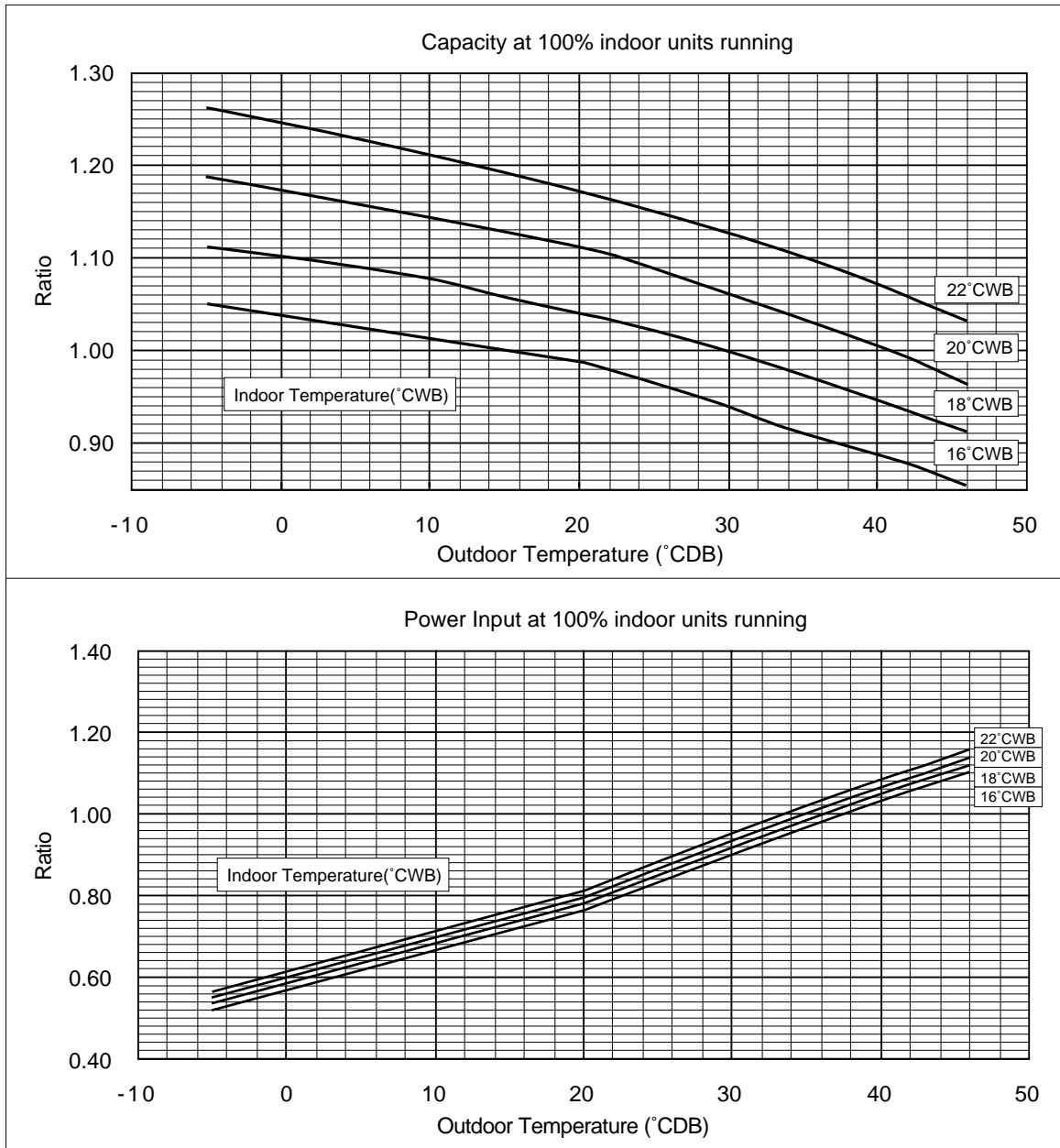

S-YM(R22)

Heating

- Standard Specifications

		PUMY-125YM,YMA
Capacity	kW	16.0
Input	kW	5.58

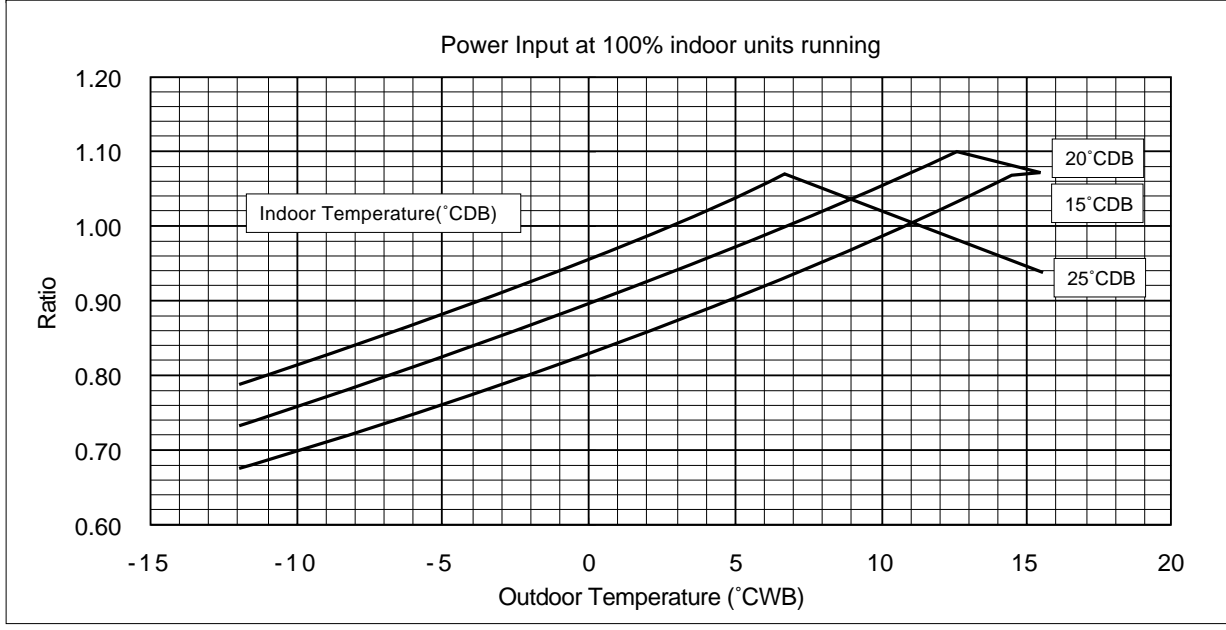
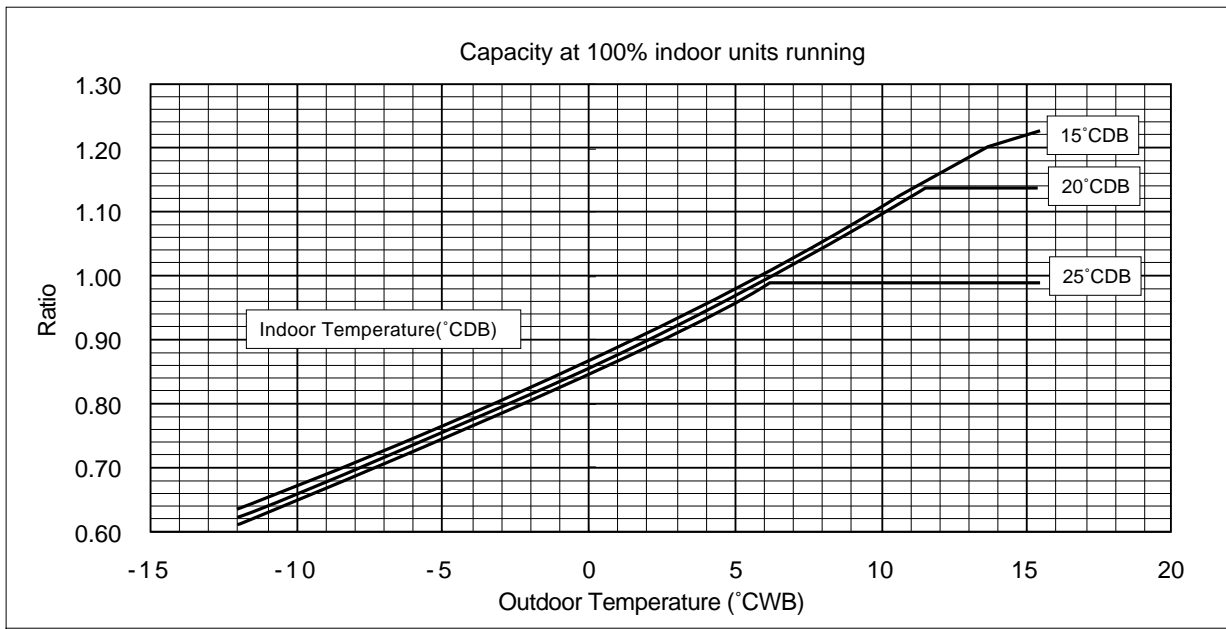

S-YM(R22)

2-2. Correction by total indoor

PUMY-125YM, YMA

1) Capacity

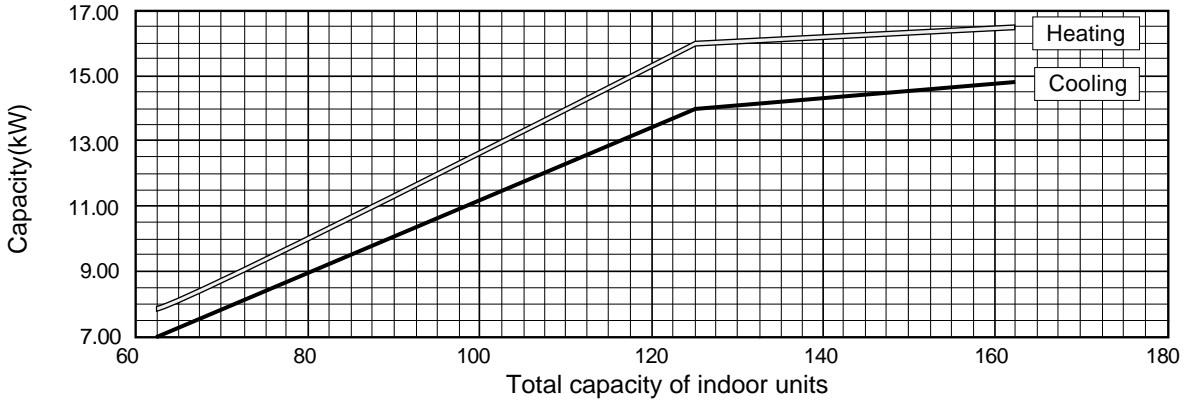

2) Input

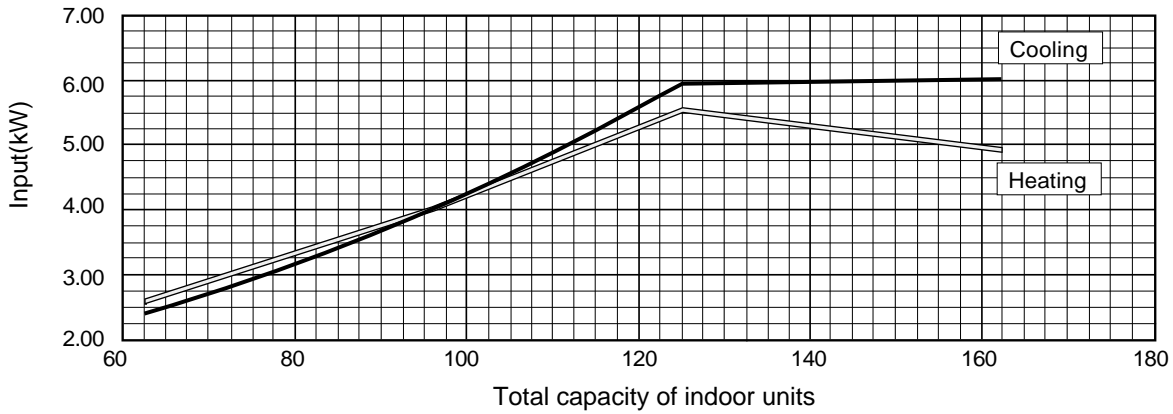

**S-
YM(R22)**

2-3. Correction by refrigerant piping length

To obtain a decrease in cooling/heating capacity due to refrigerant piping extension, multiply by the capacity correction factor based on the refrigerant piping equivalent length in the table below.

- **Cooling capacity correction**

PUMY-125YM,YMA

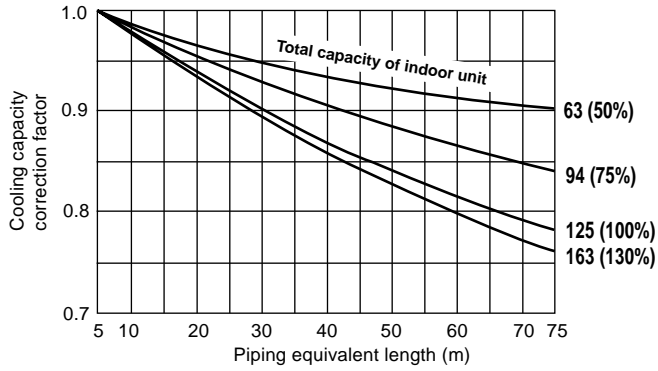

- **Heating capacity correction**

PUMY-125YM

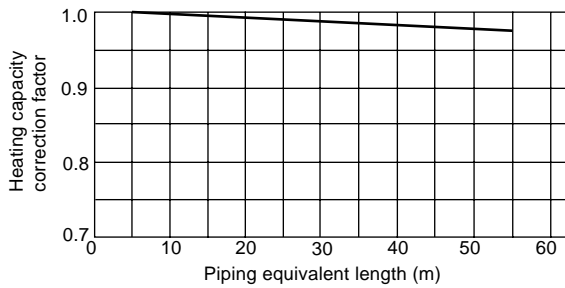

PUMY-125YMA

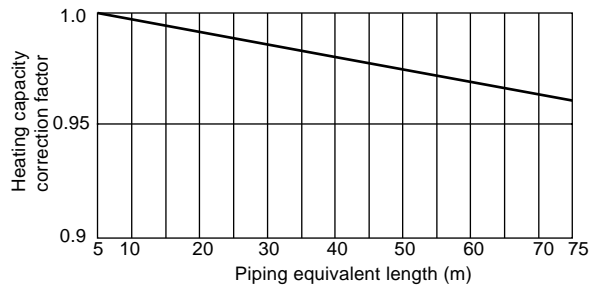

- **How to obtain piping equivalent length**

PUMY-125YM,YMA

Equivalent length = (Actual piping length to the farthest indoor unit) + (0.35 × number of bent on the piping)m

2-4. Correction at frosting and defrosting

When a decrease in heating capacity due to frosted and defrosting operations is considered, the value multiplied by the correction factor in the table below represents the heating capacity.

Correction factor table

Outdoor inlet air temp (°CWB)	6	4	2	0	-2	-4	-6	-8	-10
Correction factor	1.0	0.98	0.89	0.88	0.89	0.9	0.95	0.95	0.95

2-5. Operation limit

• Cooling

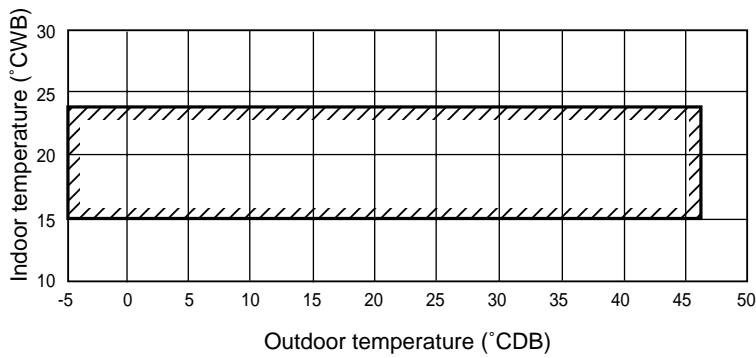

• Heating

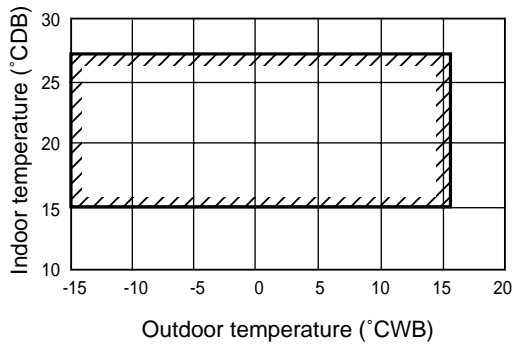

3. Sound Levels

PUMY-125YM,YMA
Measurement condition

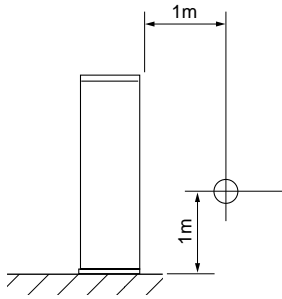

Sound pressure level in anechoic room
57 dB (A)

S-YM(R22)

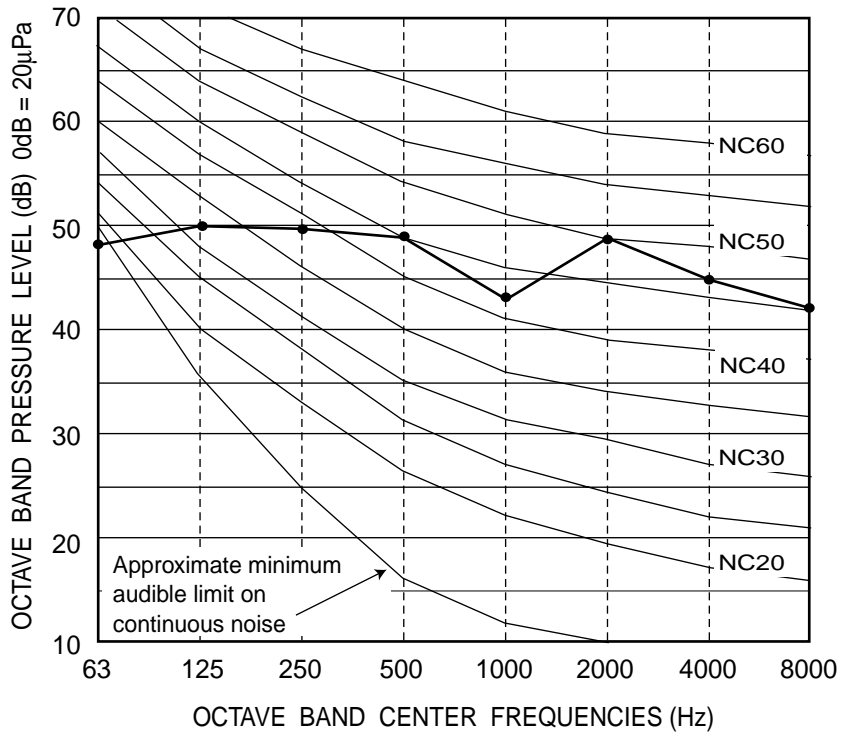

4. External Dimensions

PUMY-125YM,YMA

Unit : mm

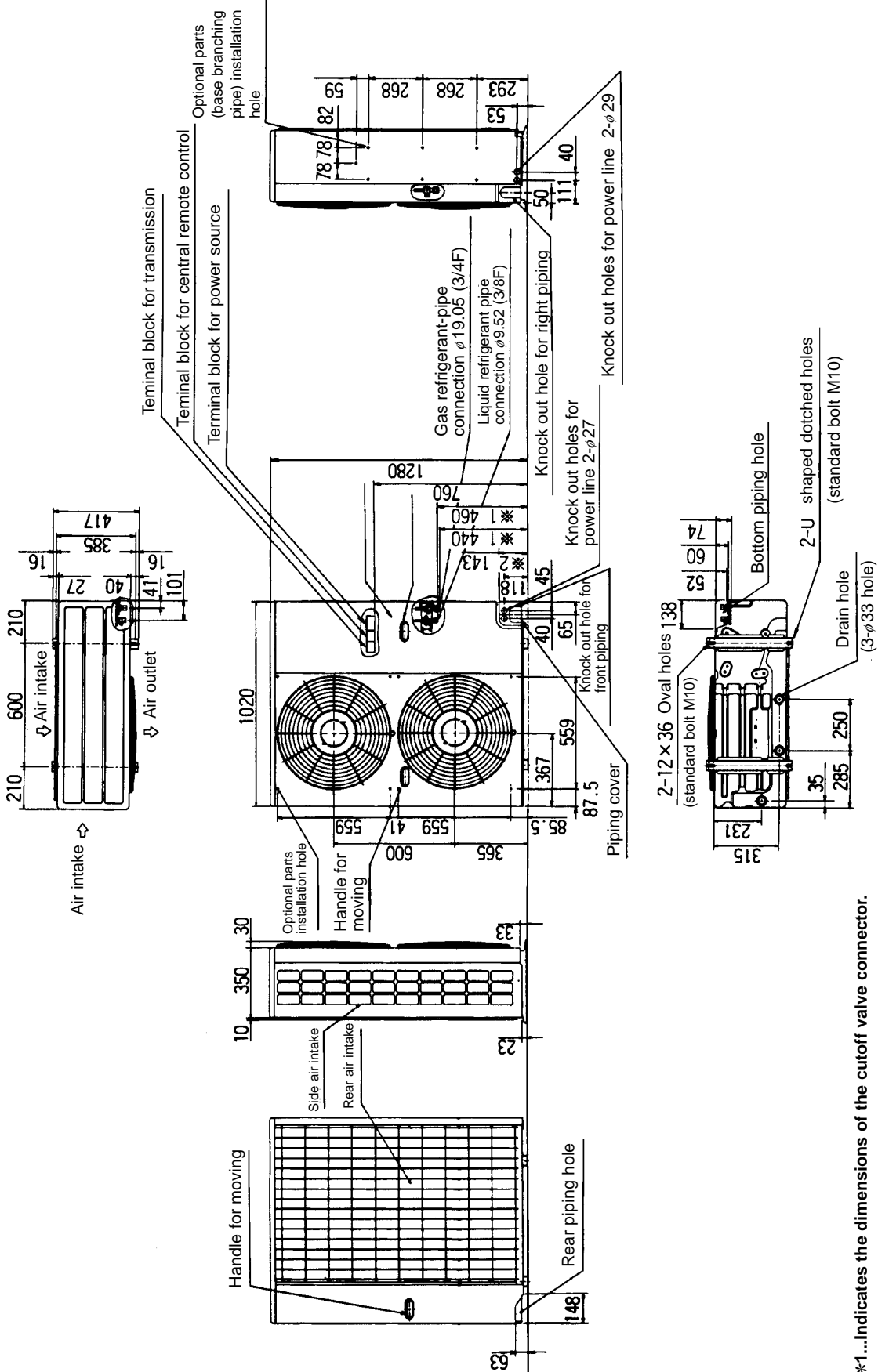

*1...Indicates the dimensions of the cutoff valve connector.
 *2...Make sure that the panel can be easily removed for maintenance when a piping cover is used for aesthetic reasons.



5. Electrical Wiring Diagram

PUMY-125YM

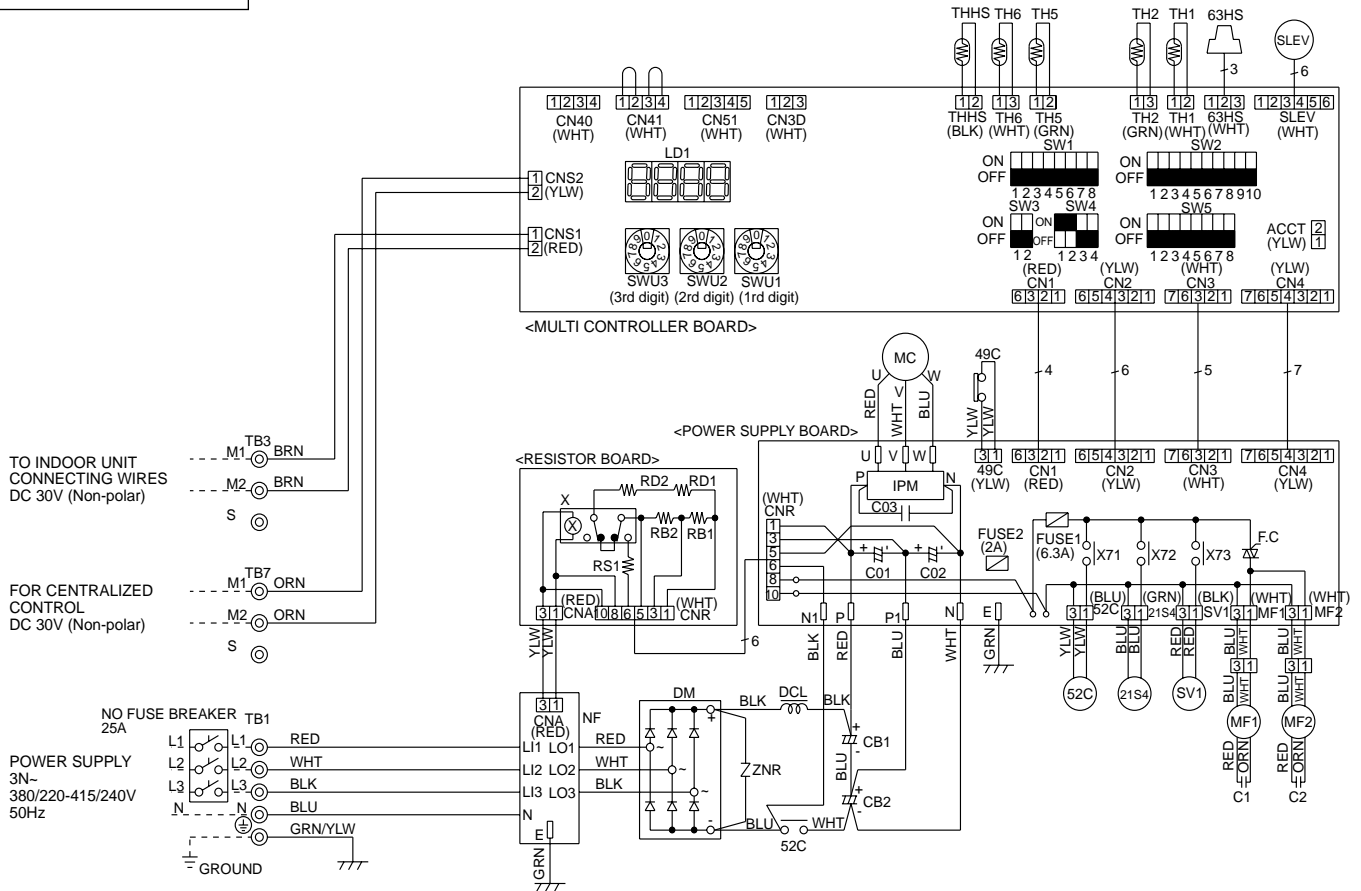

1. Refer to the wiring diagrams of the indoor units for details on wiring of each indoor unit.
2. Symbols used in wiring diagram above are. ⊙: Terminal block, □: Connector, □: Insertion tab.
3. Self-diagnosis function

The indoor and outdoor units can be diagnosed automatically using the self-diagnosis switch (SW1) and LD1 (LED indication) found on the multi-controller of the outdoor unit.

LED indication : Set all contacts of SW1 to OFF .

<SYMBOL EXPLANATION>

SYMBOL	NAME	SYMBOL	NAME	SYMBOL	NAME	SYMBOL	NAME
ACCT	CURRENT DETECTION	C1,C2	FAN MOTOR CAPACITOR	SV1	SOLENOID VALVE <HOT GAS BYPASS>	TH2	THERMISTOR <LOW PRESSURE SATURATED TEMP. DETECTION>
CB1,CB2	SMOOTHING CAPACITOR	DM	DIODE MODULE	SW1	SWITCH <DISPLAY SELECTION>	TH5	THERMISTOR <PIPE TEMP. DETECTION; JUDGING DEFROST>
CNA	CONNECTOR <POWER SUPPLY>	DCL	REACTOR	SW2	SWITCH <FUNCTION SELECTION>	TH6	THERMISTOR <OUTDOOR TEMP. DETECTION>
CNR	CONNECTOR <DISCHARGE CIRCUIT, POWER SUPPLY>	F.C	FAN CONTROL	SW3	SWITCH <TEST RUN>	X	RELAY
CNS1	CONNECTOR <MULTI SYSTEM>	FUSE1	FUSE (6.3A)	SW4	SWITCH <MODEL SELECTION>	X71	RELAY <MAGNETIC CONTACTOR>
CNS2	CONNECTOR <CENTRALIZED CONTROL>	FUSE2	FUSE (2A)	SW5	SWITCH <FUNCTION SELECTION>	X72	RELAY <4-WAY VALVE>
CN1	CONNECTOR <CONTROLLER DRIVE CONTROL>	IPM	INTELLIGENT POWER MODULE	SWU1	SWITCH <UNIT ADDRESS SELECTION, 1ST DIGIT>	X73	RELAY <SOLENOID VALVE>
CN2	CONNECTOR <POWER SYNC SIGNAL PROTECTION>	LD1	DIGITAL INDICATION LED <OPERATION INSPECTION INDICATION>	SWU2	SWITCH <UNIT ADDRESS SELECTION, 2ND DIGIT>	ZNR	VARISTOR
CN3	CONNECTOR <POWER SUPPLY 30V, 12V, 5V>	MC	COMPRESSOR (INNER THERMOSTAT)	SWU3	SWITCH <UNIT ADDRESS SELECTION, 3RD DIGIT>	ZNR	VARISTOR
CN4	CONNECTOR <INVERTER SIGNAL 5V>	MF1, MF2	FAN MOTOR (INNER THERMOSTAT)	TB1	TERMINAL BLOCK <POWER SUPPLY>	21S4	4-WAY VALVE
CN40	CONNECTOR <CENTRALIZED CONTROL POWER SUPPLY>	NF	NOISE FILTER	TB3	TERMINAL BLOCK <TRANSMISSION>	49C	THERMAL SWITCH <COMPRESSOR>
CN41	CONNECTOR <FOR STORING JUMPER CONNECTOR>	RS1	RESISTOR <RUSH CURRENT PROTECT>	TB7	TERMINAL BLOCK <CENTRALIZED CONTROL>	52C	MAGNETIC CONTACTOR
CNS51	CONNECTOR <COMPRESSOR DRIVE SIGNAL OUTPUT>	RB1, RB2	RESISTOR <VOLTAGE BALANCE ADJUSTMENT>	THHS	THERMISTOR <IPM RADIATOR PANEL TEMP. DETECTION>	63HS	HIGH PRESSURE SENSOR <DISCHARGE PRESSURE DETECTION>
CN3D	CONNECTOR <DEMAND SIGNAL/SILENT MODE INPUT>	RD1, RD2	RESISTOR <DISCHARGE>	TH1	THERMISTOR <DISCHARGE TEMP. DETECTION>		
C01, C02	SMOOTHING CAPACITOR	SLEV	EXPANSION VALVE				
C03	CAPACITOR <FILTER>						

PUMY-125YMA

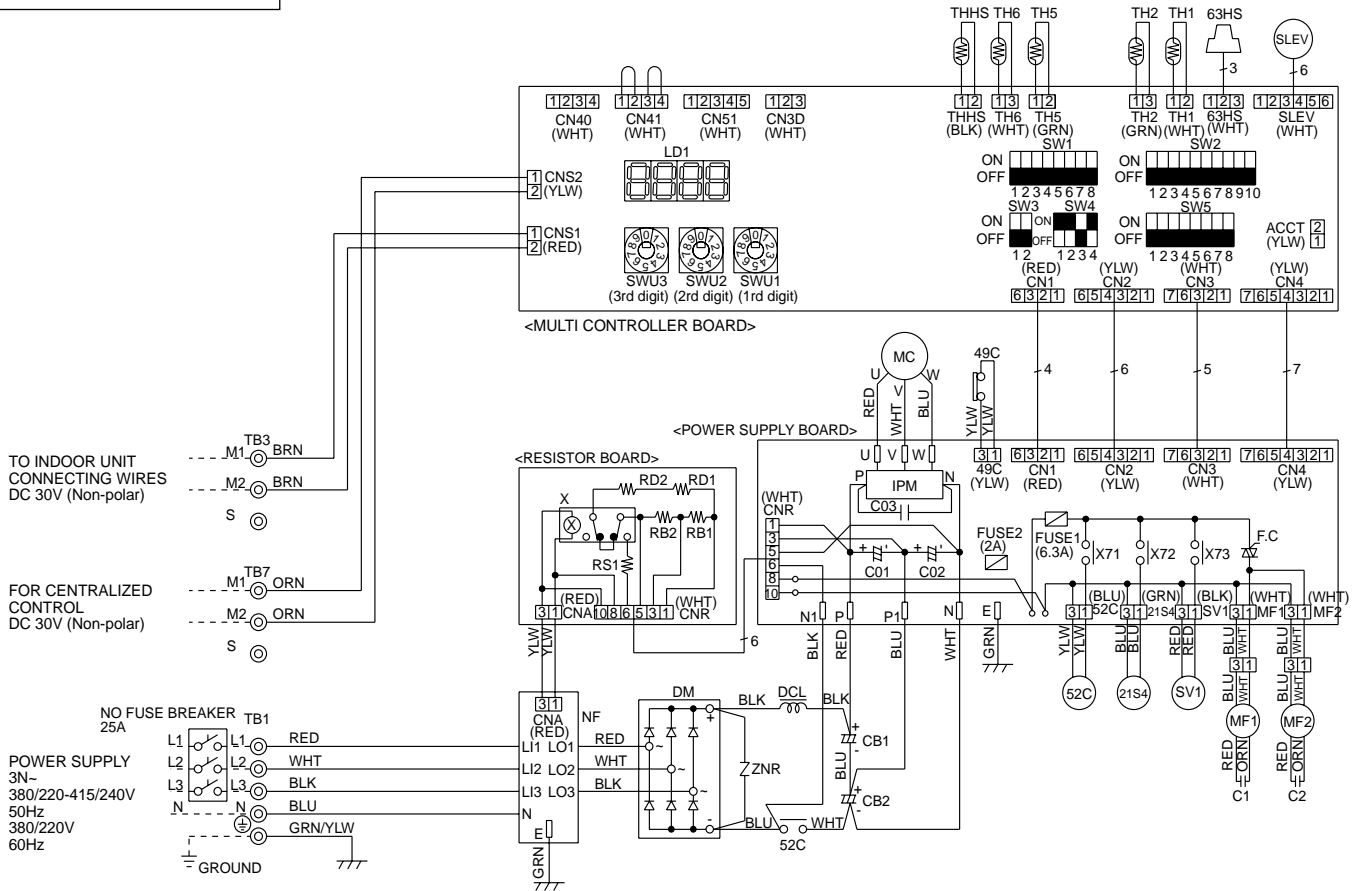

1. Refer to the wiring diagrams of the indoor units for details on wiring of each indoor unit.
2. Symbols used in wiring diagram above are. ⊙: Terminal block, □: Connector, □: Insertion tab.
3. Self-diagnosis function
The indoor and outdoor units can be diagnosed automatically using the self-diagnosis switch (SW1) and LD1 (LED indication) found on the multi-controller of the outdoor unit.
LED indication : Set all contacts of SW1 to OFF .

<SYMBOL EXPLANATION>

SYMBOL	NAME	SYMBOL	NAME	SYMBOL	NAME	SYMBOL	NAME
ACCT	CONNECTOR<CURRENT DETECTION>	C1,C2	FAN MOTOR CAPACITOR	SV1	SOLENOID VALVE <HOT GAS BYPASS>	TH2	THERMISTOR <LOW PRESSURE SATURATED TEMP. DETECTION>
CB1,CB2	SMOOTHING CAPACITOR	DM	DIODE MODULE	SW1	SWITCH <DISPLAY SELECTION>	TH5	THERMISTOR <PIPE TEMP. DETECTION;JUDGING DEFROST>
CNA	CONNECTOR <POWER SUPPLY>	DCL	REACTOR	SW2	SWITCH <FUNCTION SELECTION>	TH6	THERMISTOR <OUTDOOR TEMP. DETECTION>
CNR	CONNECTOR <DISCHARGE CIRCUIT,POWER SUPPLY>	F.C	FAN CONTROL	SW3	SWITCH <TEST RUN>	X	RELAY
CNS1	CONNECTOR <MULTI SYSTEM>	FUSE1	FUSE(6.3A)	SW4	SWITCH <MODEL SELECTION>	X71	RELAY <MAGNETIC CONTACTOR>
CNS2	CONNECTOR <CENTRALIZED CONTROL>	FUSE2	FUSE(2A)	SW5	SWITCH <FUNCTION SELECTION>	X72	RELAY <4-WAY VALVE>
CN1	CONNECTOR <CONTROLLER DRIVE CONTROL>	IPM	INTELLIGENT POWER MODULE	SWU1	SWITCH <UNIT ADDRESS SELECTION,1ST DIGIT>	X73	RELAY <SOLENOID VALVE>
CN2	CONNECTOR <POWER SYNC SIGNAL,PROTECTION>	LD1	DIGITAL INDICATION LED <OPERATION INSPECTION INDICATION>	SWU2	SWITCH <UNIT ADDRESS SELECTION,2ND DIGIT>	ZNR	VARISTOR
CN3	CONNECTOR <POWER SUPPLY 30V,12V,5V>	MC	COMPRESSOR<INNER THERMOSTAT>	SWU3	SWITCH <UNIT ADDRESS SELECTION,3RD DIGIT>	ZNR	VARISTOR
CN4	CONNECTOR <INVERTER SIGNAL 5V>	MF1,MF2	FAN MOTOR<INNER THERMOSTAT>	TB1	TERMINAL BLOCK <POWER SUPPLY>	49C	THERMAL SWITCH <COMPRESSOR>
CN40	CONNECTOR <CENTRALIZED CONTROL,POWER SUPPLY>	NF	NOISE FILTER	TB3	TERMINAL BLOCK <TRANSMISSION>	52C	MAGNETIC CONTACTOR
CN41	CONNECTOR <FOR STORING JUMPER CONNECTOR>	RS1	RESISTOR <RUSH CURRENT PROTECT>	TB7	TERMINAL BLOCK <CENTRALIZED CONTROL>	63HS	HIGH PRESSURE SENSOR <DISCHARGE PRESSURE DETECTION>
CN51	CONNECTOR <COMPRESSOR DRIVE SIGNAL OUTPUT>	RD1,RD2	RESISTOR <DISCHARGE>	THHS	THERMISTOR <IPM RADIATOR PANEL TEMP. DETECTION>		
CN3D	CONNECTOR <DEMAND SIGNAL/SILENT MODE INPUT>	SLEV	EXPANSION VALVE	TH1	THERMISTOR <DISCHARGE TEMP. DETECTION>		
C01,C02	SMOOTHING CAPACITOR						
C03	CAPACITOR <FILTER>						

6. Refrigerant Circuit Diagram And Thermal Sensor

PUMY-125YM,YMA

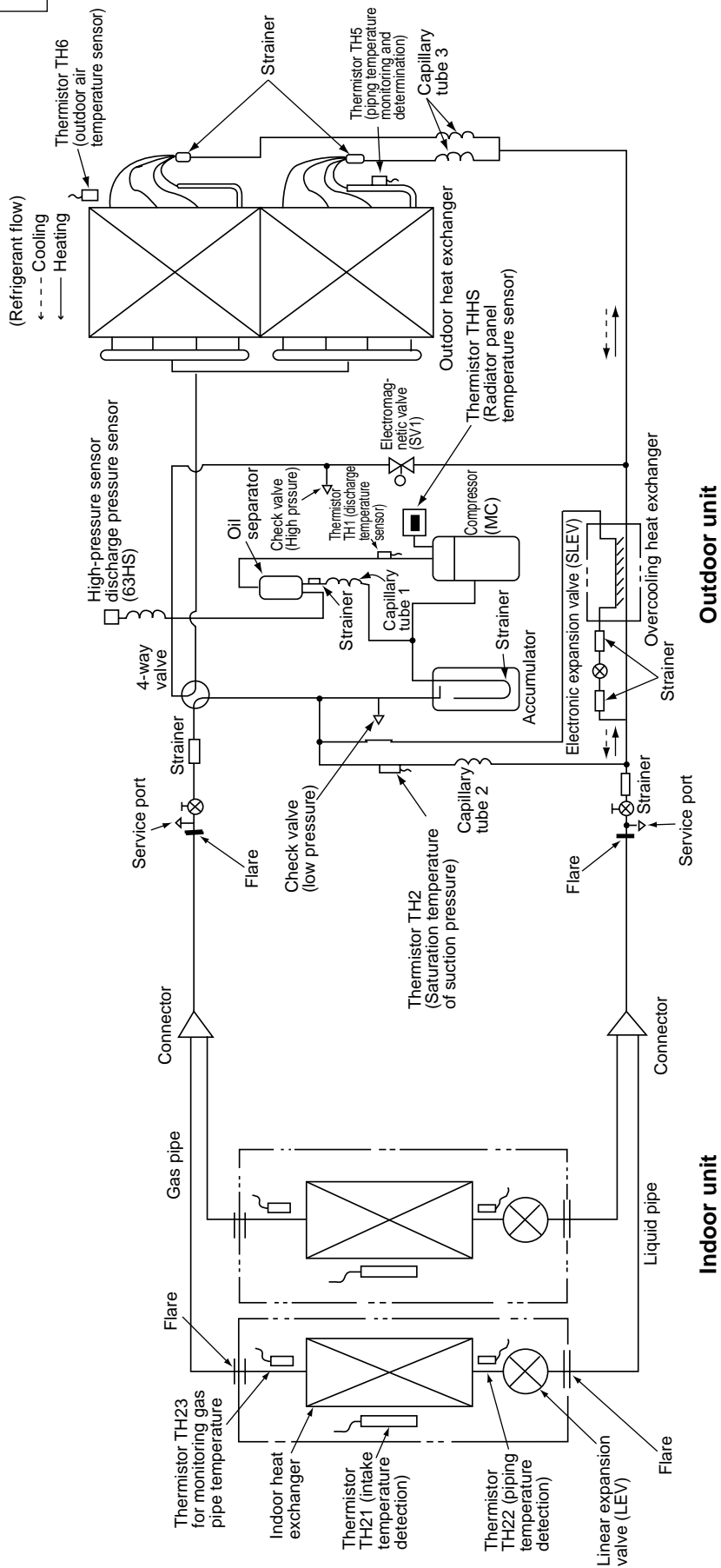

S-YM(R22)

PUHY-200-250-315YEM-A (-BF, -BS)
PUY-200-250-315YEM-A (-BF, -BS)
PUHY-250-315YEMK-A
PUHY-200-250-315YEMC-A (-BS)

CONTENTS

1. Specifications I -178

2. Capacity Tables I -183

 2-1 Correction by temperature I -183

 2-2 Correction by total indoor I -185

 2-3 Correction by refrigerant piping length I -188

 2-4 Correction at frosting and defrosting I -189

 2-5 Operation limit I -189

3. Sound Levels I -190

4. External Dimensions I -192

5. Electrical Wiring Diagram I -193

6. Refrigerant Circuit Diagram I -194
 And Thermal Sensor

Y-8,10,13(R22)

1. Specifications

Model name			PUHY-200YEM-A (-BF, -BS)	
			PUY-200YEM-A (-BF, -BS)	
			Cooling	Heating
Capacity	*1	kW	22.4	25.0
	*2	kcal/h	20,000	—
Power source			3N ~ 380/400/415V 50/60Hz	
Power input		kW	6.19	6.66
Current		A	10.4/9.9/9.5	11.2/10.6/10.2
Fan	Type X Quantity		Propeller fan X 1	
	Airflow rate	m ³ /min	200	
	Motor output	kW	0.38	
Compressor	Type		Hermetic	
	Motor output	kW	5.3	
	Crankcase heater	kW	0.045(240V)	
Refrigerant / Lubricant			R22/MS32 (N-1)	
External finish			Pre-coated galvanized sheets(Powder coating) <MUNSELL 5Y8/1 or similar>	
External dimension		mm	1755(H)X990(W)X840(L)	
Protection devices	High pressure protection		2.94MPa	
	Compressor / Fan		Over current protection / Thermal switch	
	Inverter		AC bus current protection, thermal switch	
Refrigerant piping diameter		Liquid / Gas	φ 12.7 (Flare) / φ 25.4 (Flange)	
Indoor unit	Total capacity		50 ~ 130% of outdoor unit capacity	
	Model / Quantity		Model 20 ~ 250 / 1 ~ 13	
Noise level		* dB<A>	56	
Net weight		kg	219	
Operating temperature range			Indoor:15°CWB ~ 24°CWB Outdoor:-5°CDB ~ 46°CDB (10°CDB ~ 46°CDB with outdoor unit at lower position)	Indoor:15°CDB ~ 27°CDB Outdoor:-15°CWB ~ 15.5°CWB
Matters Deserving Special Mention			A pipe of φ28.58 can be used for the gas pipe	

Note: 1.Cooling/heating capacity indicates the maximum value at operation under the following condition.

*1 **Cooling** Indoor : 27°CDB/19°CWB Outdoor : 35°CDB

Heating Indoor : 20°CDB Outdoor : 7°CDB/6°CWB

Pipe length : 7.5m Height difference : 0m

*2 **Cooling** Indoor : 27°CDB/19.5°CWB Outdoor : 35°CDB

Pipe length : 5m Height difference : 0m

* It is measured in anechoic room.

Model name			PUHY-200YEMC-A (-BS)	
			Cooling	Heating
Capacity	*1	kW	24.6	25.0
Power source			3N ~ 380/400/415V 50/60Hz	
Power input		kW	7.13	6.66
Current		A	12.0/11.4/11.0	11.2/10.6/10.2
Fan	Type X Quantity		Propeller fan X 1	
	Airflow rate	m ³ /min	200	
	Motor output	kW	0.38	
Compressor	Type		Hermetic	
	Motor output	kW	6.0	
	Crankcase heater	kW	0.045(240V)	
Refrigerant / Lubricant			R22/MS32 (N-1)	
External finish			Pre-coated galvanized sheets(Powder coating) <MUNSELL 5Y8/1 or similar>	
External dimension		mm	1755(H)X990(W)X840(L)	
Protection devices	High pressure protection		2.94MPa	
	Compressor / Fan		Over current protection / Thermal switch	
	Inverter		AC bus current protection, thermal switch	
Refrigerant piping diameter		Liquid / Gas	φ 12.7 (Flare) / φ 25.4 (Flange)	
Indoor unit	Total capacity		50 ~ 130% of outdoor unit capacity	
	Model / Quantity		Model 20 ~ 250 / 1 ~ 13	
Noise level	*	dB<A>	56	
Net weight		kg	219	
Operating temperature range			Indoor:15°CWB ~ 24°CWB Outdoor:-5°CDB ~ 46°CDB (10°CDB ~ 46°CDB with outdoor unit at lower position)	Indoor:15°CDB ~ 27°CDB Outdoor:-15°CWB ~ 15.5°CWB
Matters Deserving Special Mention			A pipe of φ28.58 can be used for the gas pipe	

Note: 1.Cooling/heating capacity indicates the maximum value at operation under the following condition.

*1 **Cooling** Indoor : 27°CDB/19°CWB Outdoor : 35°CDB
Heating Indoor : 20°CDB Outdoor : 7°CDB/6°CWB
Pipe length : 7.5m Height difference : 0m

* It is measured in anechoic room.

Y-8,10,13(R22)

Y-8,10,13(R22)

Model name		PUHY-250YEM-A (-BF, -BS), PUY-250YEM-A (-BF, -BS)	
		Cooling	
Capacity	*1	kW	28.0
	*2	kcal/h	25,000
Power source		3N ~ 380/400/415V 50/60Hz	
Power input		kW	8.37
Current		A	14.1/13.4/12.9
Fan	Type X Quantity		Propeller fan X 1
	Airflow rate	m ³ /min	200
	Motor output	kW	0.38
Compressor	Type		Hermetic
	Motor output	kW	6.8
	Crankcase heater	kW	0.045(240V)
Refrigerant / Lubricant		R22/MS32 (N-1)	
External finish		Pre-coated galvanized sheets(Powder coating) <MUNSELL 5Y8/1 or similar>	
External dimension		mm	1755(H)X990(W)X840(L)
Protection devices	High pressure protection		2.94MPa
	Compressor / Fan		Over current protection / Thermal switch
	Inverter		AC bus current protection, thermal switch
Refrigerant piping diameter		Liquid / Gas	φ 12.7 (Flare) / φ 28.58 (Flange)
Indoor unit	Total capacity		50 ~ 130% of outdoor unit capacity
	Model / Quantity		Model 20 ~ 250 / 1 ~ 16
Noise level		* dB<A>	57
Net weight		kg	219
Operating temperature range		Indoor:15°CWB ~ 24°CWB Outdoor:-5°CDB ~ 46°CDB (10°CDB ~ 46°CDB with outdoor unit at lower position)	Indoor:15°CDB ~ 27°CDB Outdoor:-15°CWB~15.5°CWB

Note: 1.Cooling/heating capacity indicates the maximum value at operation under the following condition.

*1 Cooling Indoor : 27°CDB/19°CWB	Outdoor : 35°CDB	*2 Cooling Indoor : 27°CDB/19.5°CWB	Outdoor : 35°CDB
Heating Indoor : 20°CDB	Outdoor : 7°CDB/6°CWB	Pipe length : 5m	Height difference : 0m
Pipe length : 7.5m	Height difference : 0m		

* It is measured in anechoic room.

Model name		PUHY-250YEMK-A	
		Cooling	Heating
Capacity	*1 kW	30.0	31.5
Power source		3N ~ 380/400/415V 50/60Hz	
Power input	kW	11.66	8.77
Current	A	19.6/18.6/18.0	14.8/14.0/13.5
Fan	Type X Quantity	Propeller fan X 1	
	Airflow rate	m ³ /min	200
	Motor output	kW	0.38
Compressor	Type	Hermetic	
	Motor output	kW	7.9
	Crankcase heater	kW	0.045(240V)
Refrigerant / Lubricant		R22/MS32 (N-1)	
External finish		Pre-coated galvanized sheets(Powder coating) <MUNSELL 5Y8/1 or similar>	
External dimension	mm	1755(H)X990(W)X840(L)	
Protection devices	High pressure protection	2.94MPa	
	Compressor / Fan	Over current protection / Thermal switch	
	Inverter	AC bus current protection, thermal switch	
Refrigerant piping diameter	Liquid / Gas	φ 12.7 (Flare) / φ 28.58 (Flange)	
Indoor unit	Total capacity	50 ~ 130% of outdoor unit capacity	
	Model / Quantity	Model 20 ~ 250 / 1 ~ 16	
Noise level	* dB<A>	57	
Net weight	kg	219	
Operating temperature range		Indoor:15°CWB ~ 24°CWB Outdoor:-5°CDB ~ 46°CDB (10°CDB ~ 46°CDB with outdoor unit at lower position)	Indoor:15°CDB ~ 27°CDB Outdoor:-15°CWB~15.5°CWB

Note: 1.Cooling/heating capacity indicates the maximum value at operation under the following condition.

*1 **Cooling** Indoor : 27°CDB/19°CWB Outdoor : 35°CDB
Heating Indoor : 20°CDB Outdoor : 7°CDB/6°CWB
 Pipe length : 7.5m Height difference : 0m

* It is measured in anechoic room.

Model name		PUHY-315YEM-A (-BF, -BS), PUHY-315YEMK-A	
		PUY-315YEM-A (-BF, -BS)	PUHY-315YEMC-A (-BS)
		Cooling	Heating
Capacity Capacity	*1	kW	35.5
	*2	kcal/h	31,500
Power source		3N ~ 380/400/415V 50/60Hz	
Power input		kW	12.05
Current		A	19.9/18.9/18.2
Fan	TypeX Quantity		Propeller fan X 1
	Airflow rate	m ³ /min	200
	Motor output	kW	0.38
Compressor	Type		Hermetic
	Motor output	kW	8.6
	Crankcase heater	kW	0.045(240V)
Refrigerant / Lubricant		R22/MS32 (N-1)	
External finish		Pre-coated galvanized sheets(Powder coating) <MUNSELL 5Y8/1 or similar>	
External dimension		mm	1755(H)X 990(W) X 840(L)
Protection devices	High pressure protection		2.94MPa
	Compressor / Fan		Overcurrent protection / Thermal switch
	Inverter		AC bus current protection, thermal switch
Refrigerant piping diameter		Liquid / Gas	φ 12.7 (Flare) / φ 31.75 (Flange)
Indoor unit	Total capacity		50 ~ 130% of outdoor unit capacity
	Model / Quantity		Model 20 ~ 250 / 1 ~ 16
Noise level	*	dB<A>	60
Net weight		kg	234
Operating temperature range		Indoor:15°CWB ~ 24°CWB Outdoor:-5°CDB ~ 46°CDB (10°CDB~46°CDB with outdoor unit at lower position)	Indoor:15°CDB ~ 27°CDB Outdoor:-15°CWB ~ 15.5°CWB (-12°C(-5°C)WB~10°CWB with indoor unit P25(P20)type only is working)
Matters Deserving Special Mention		A pipe of φ 34.93 can be used for the gas pipe	

Note: 1.Cooling/heating capacity indicates the maximum value at operation under the following condition.

*1 **Cooling** Indoor : 27°CDB/19°CWB Outdoor : 35°CDB *2 **Cooling** Indoor : 27°CDB/19.5°CWB Outdoor : 35°CDB
Heating Indoor : 20°CDB Outdoor : 7°CDB/6°CWB Pipe length : 5m Height difference : 0m
Pipe length : 7.5m Height difference : 0m

* It is measured in anechoic room.

2. Capacity Tables

2-1. Correction by temperature

Cooling

- Standard Specifications

		PU(H)Y-200YEM	PUHY-200YEMC	PU(H)Y-250YEM(C)	PU(H)Y-250YEMK
Capacity	kW	22.4	24.6	28.0	30.0
Input	kW	6.19	7.13	8.37	11.66
		PUHY-315YEM(K,C)			
Capacity	kW	35.5			
Input	kW	12.05			

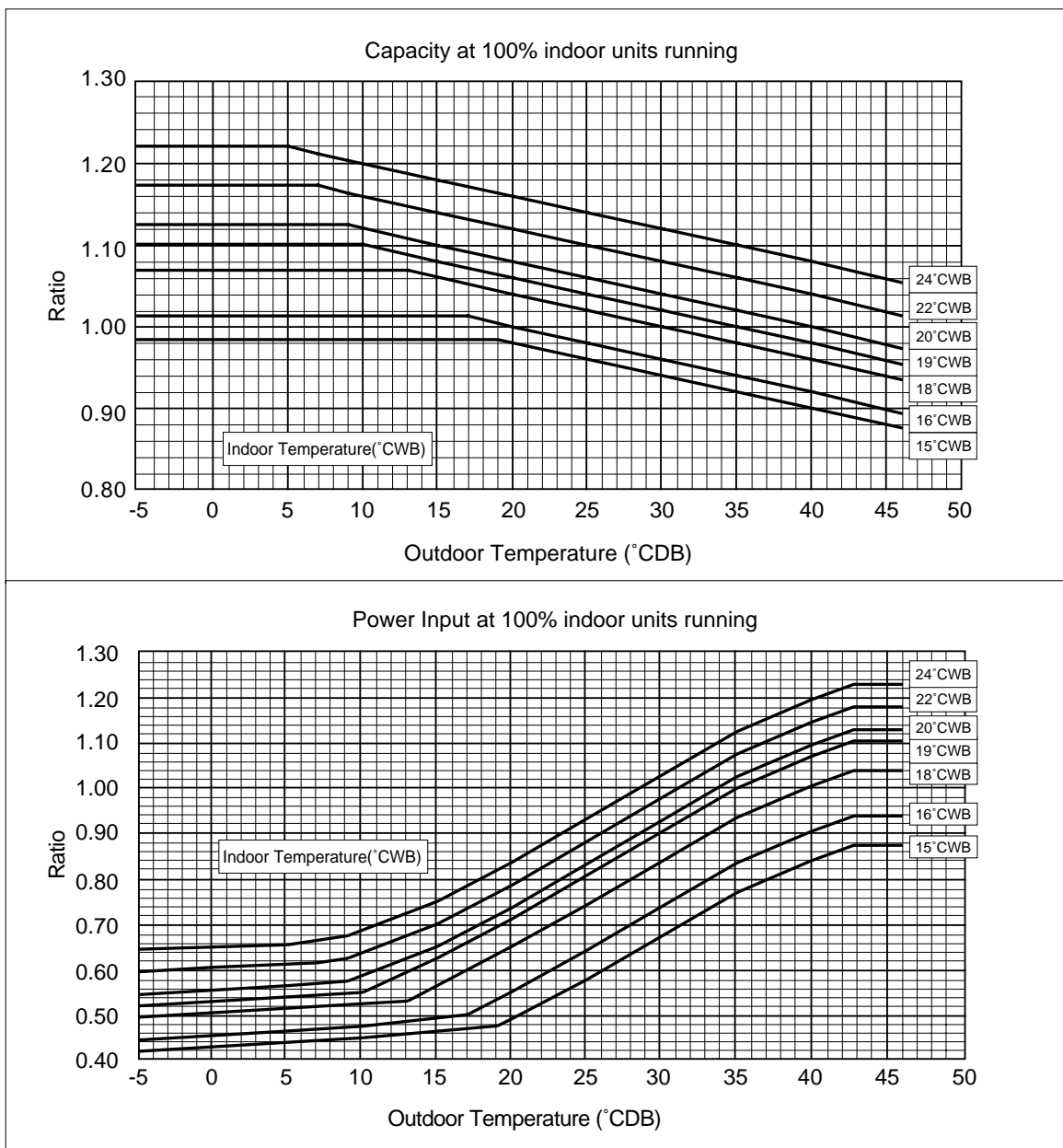

Y-8,10,13(R22)

Heating

- Standard Specifications

		PUHY-200YEM(C)-A	PUHY-250YEM(K,C)-A	PUHY-315YEM(K,C)-A
Capacity	kW	25.0	31.5	40.0
Input	kW	6.66	8.77	10.91

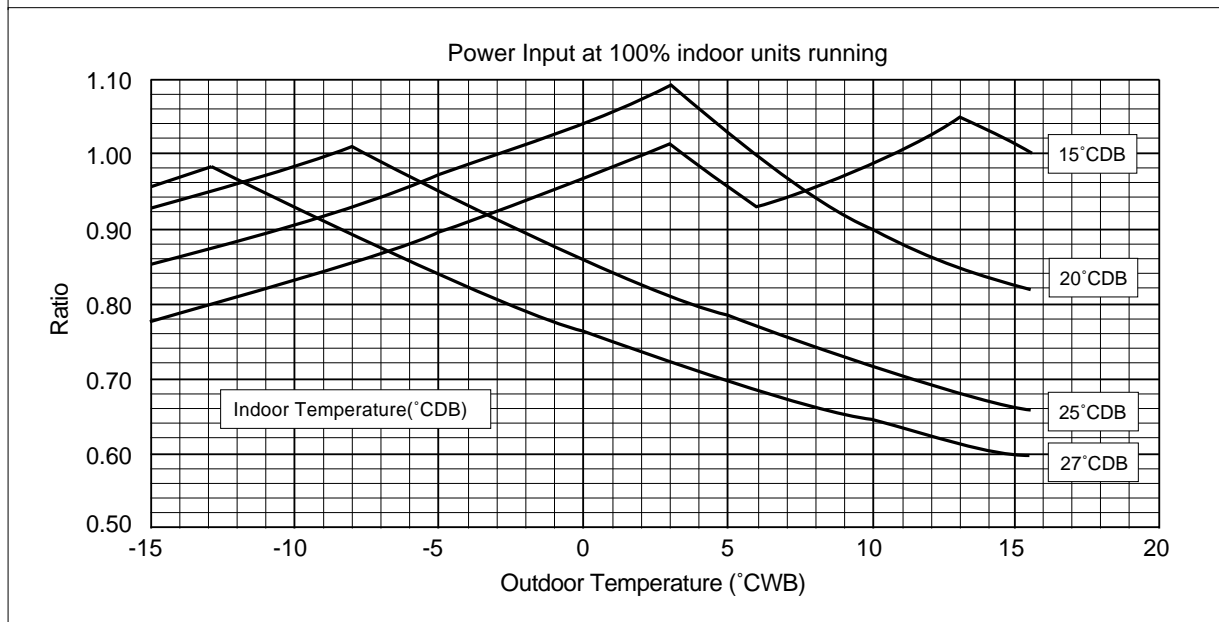
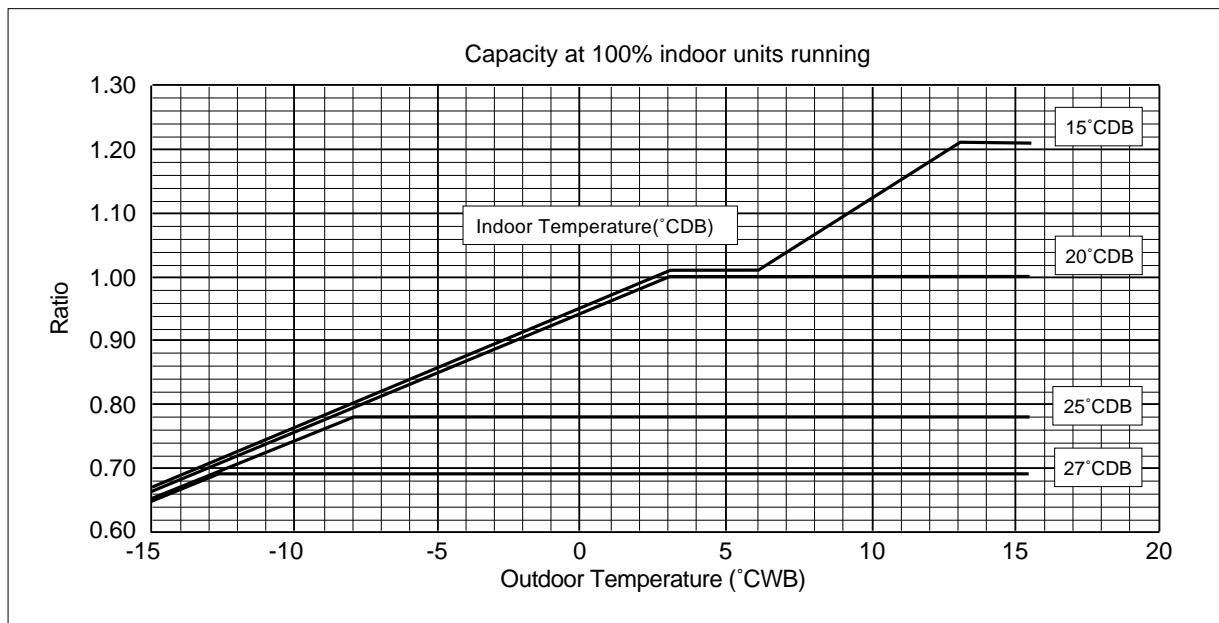

Y-8,10,13(R22)

2-2. Correction by total indoor

PU(H)Y-200YEM-A

1) Capacity

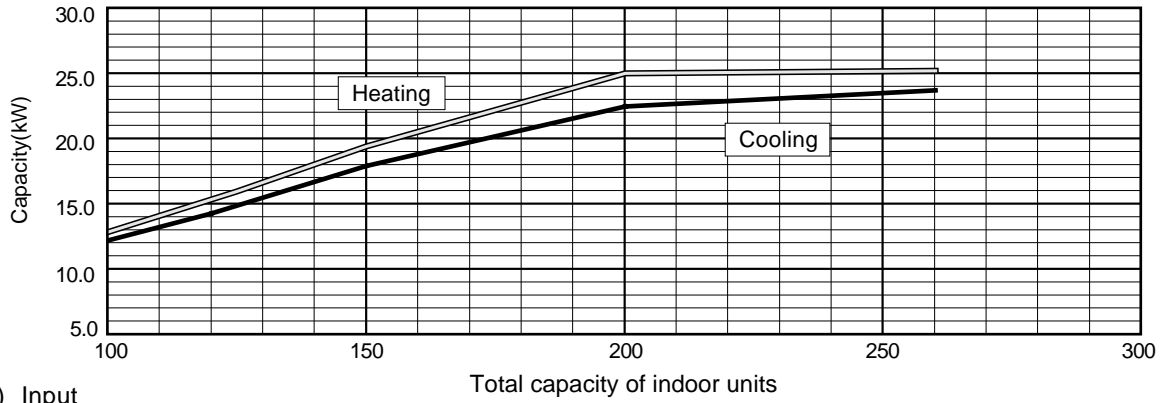

2) Input

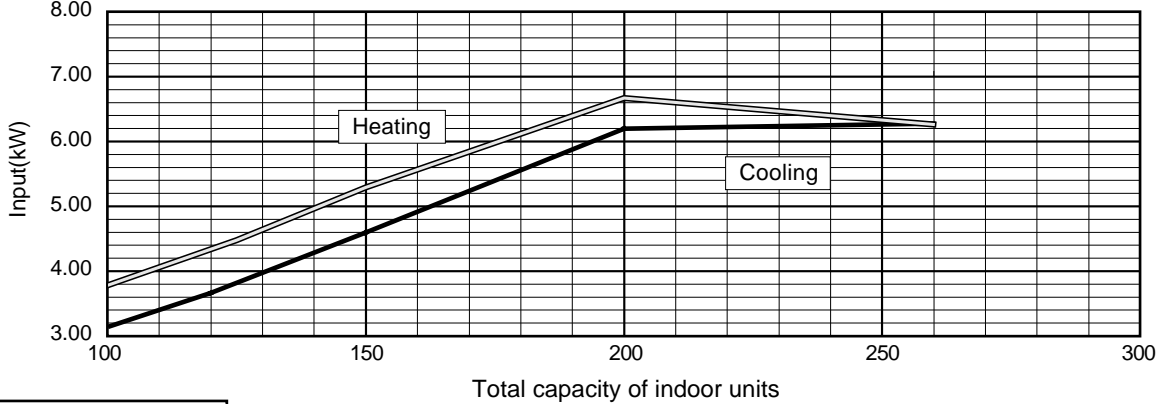

PUHY-200YEMC-A

1) Capacity

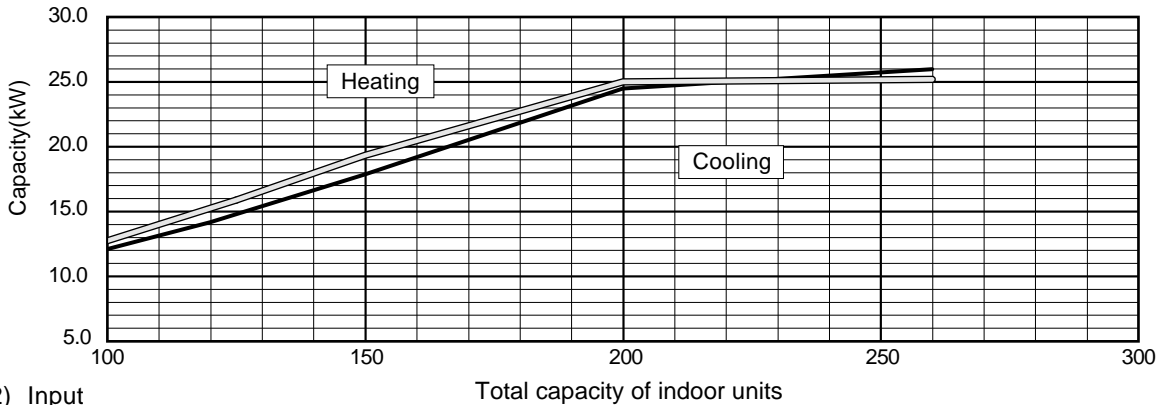

2) Input

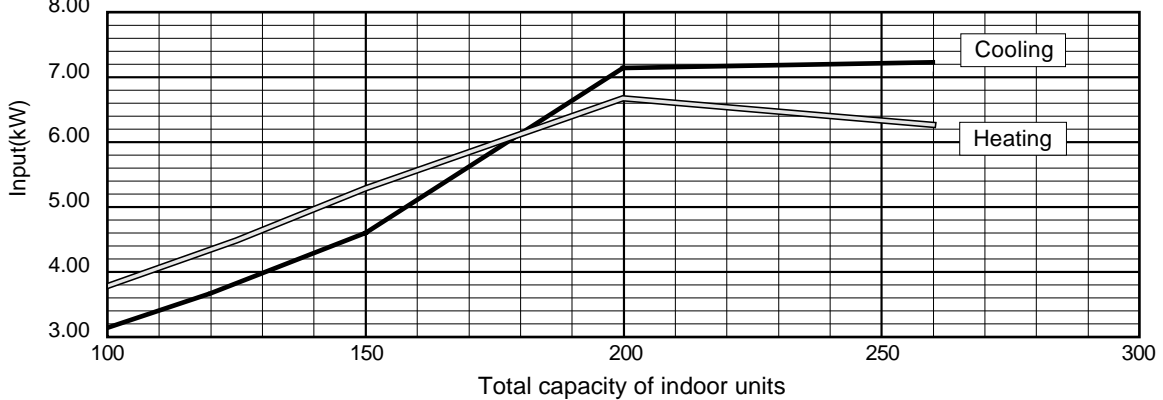

Y-8,10,13(R22)

**PU(H)Y-250YEM-A
PUHY-250YEMC-A**

1) Capacity

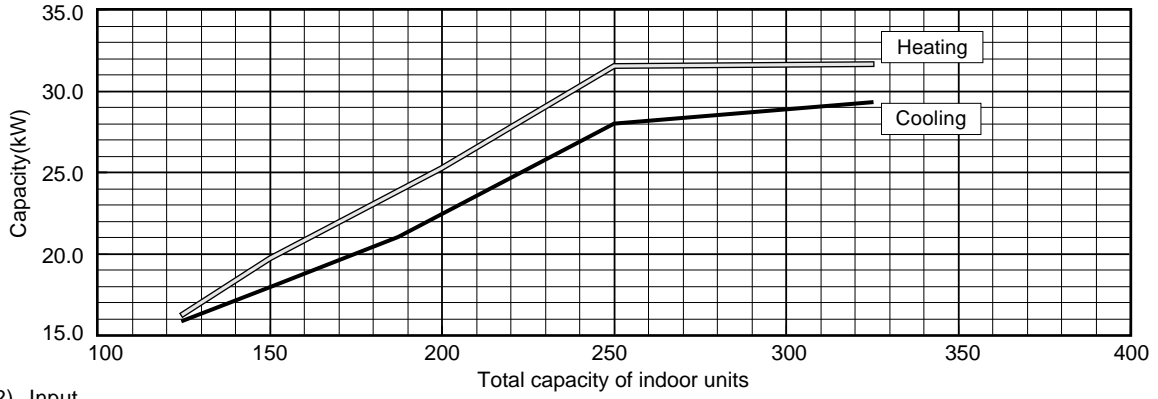

2) Input

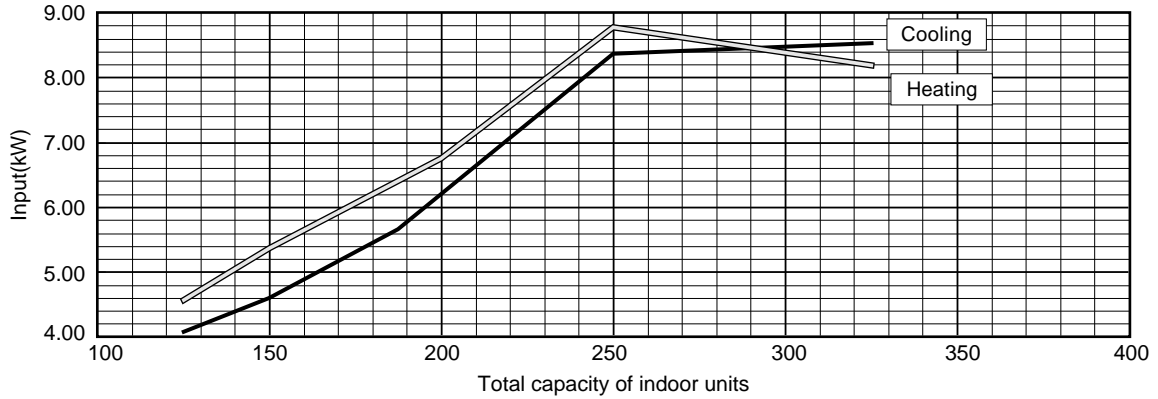

PUHY-250YEMK-A

1) Capacity

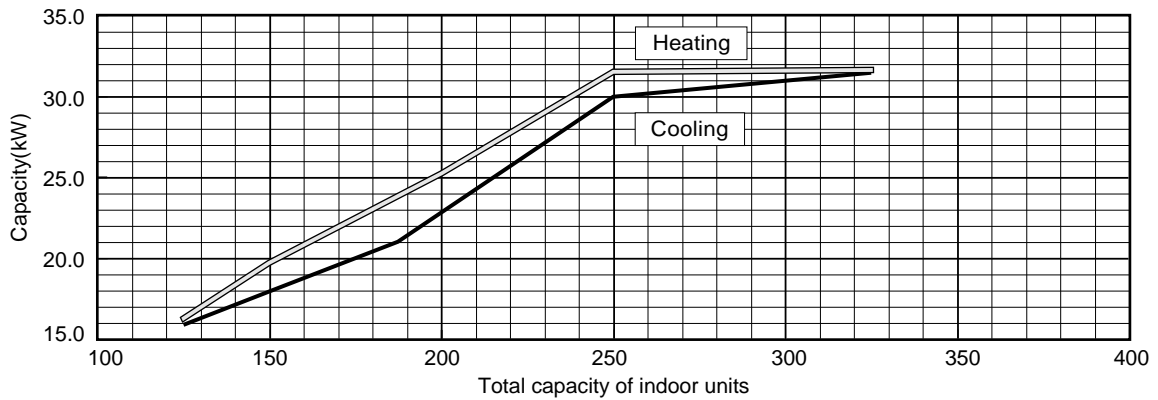

2) Input

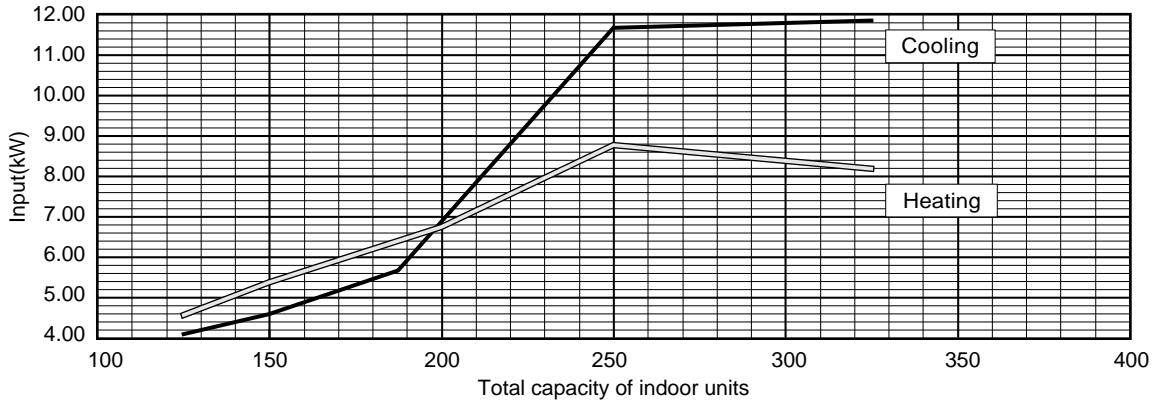

Y-8,10,13(R22)

PU(H)Y-315YEM(K,C)-A

1) Capacity

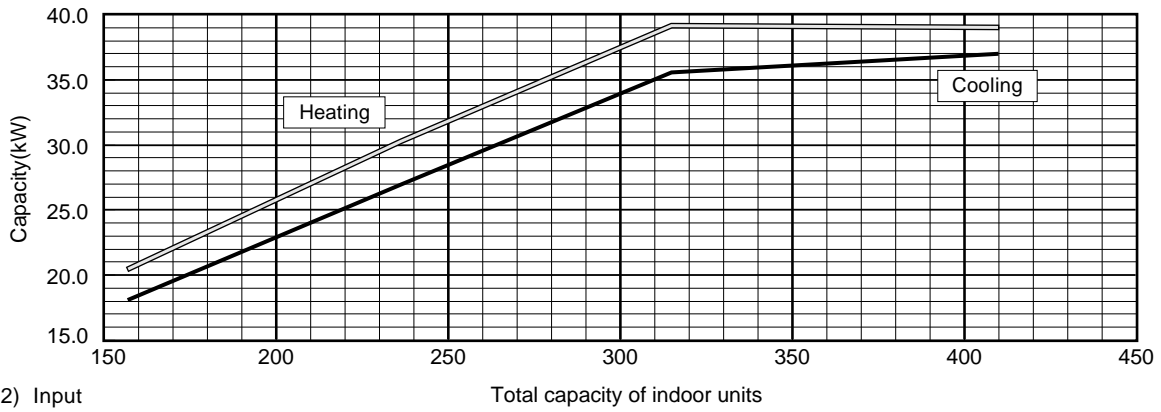

2) Input

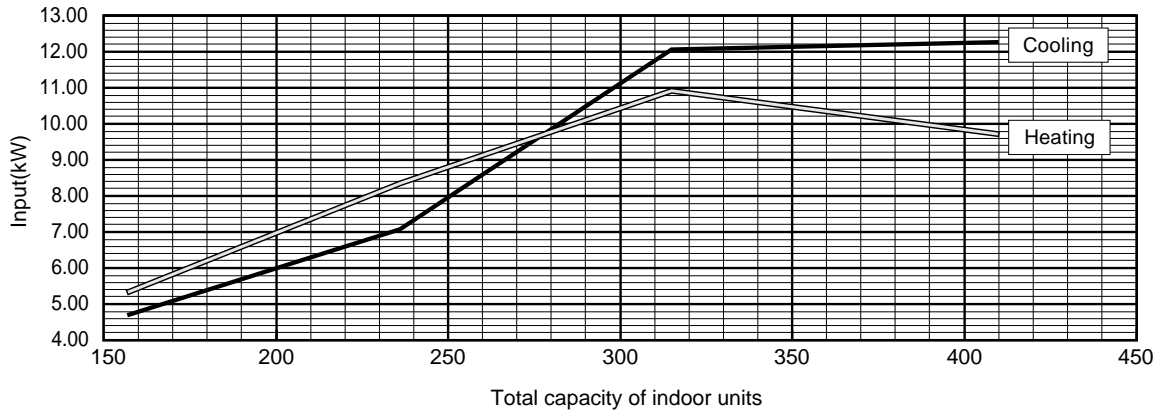

Y-8,10,13(R22)

2-3. Correction by refrigerant piping length

To obtain a decrease in cooling/heating capacity due to refrigerant piping extension, multiply by the capacity correction factor based on the refrigerant piping equivalent length in the table below.

• Cooling capacity correction

PU(H)Y-200YEM(C)-A

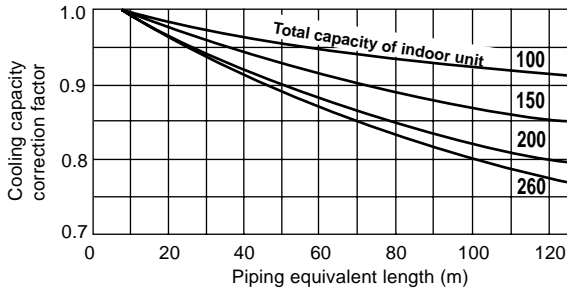

PU(H)Y-250YEM(K,C)-A

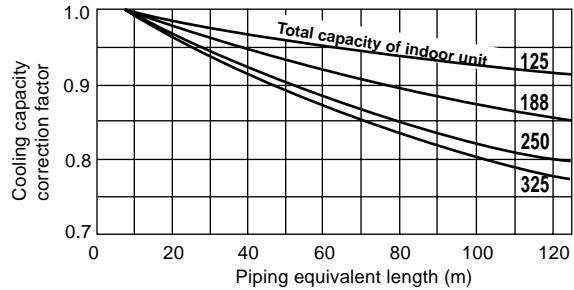

PU(H)Y-315YEM(K,C)-A

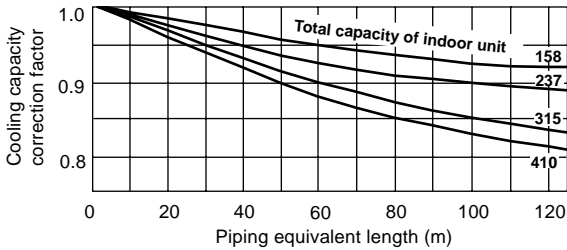

• Heating capacity correction

PUHY-200YEM(C)-A

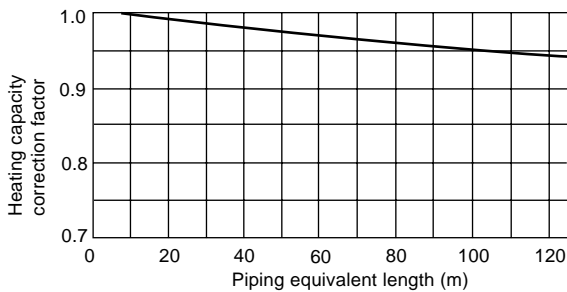

PUHY-250YEM(K,C)-A

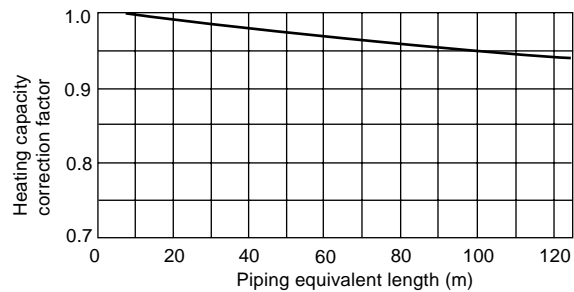

PUHY-315YEM(K,C)-A

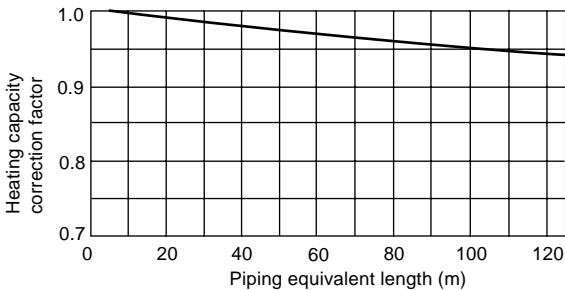

• How to obtain piping equivalent length

① **PU(H)Y-200YEM(C)-A**

Equivalent length = (Actual piping length to the farthest indoor unit) + (0.47 × number of bent on the piping)m

② **PU(H)Y-250YEM(K,C)-A**

Equivalent length = (Actual piping length to the farthest indoor unit) + (0.50 × number of bent on the piping)m

③ **PU(H)Y-315YEM(K,C)-A**

Equivalent length = (Actual piping length to the farthest indoor unit) + (0.70 × number of bent on the piping)m

Y-8,10,13(R22)

2-4. Correction at frosting and defrosting

When a decrease in heating capacity due to frosted and defrosting operations is considered, the value multiplied by the correction factor in the table below represents the heating capacity.

Correction factor table

Outdoor inlet air temp (°CWB)		6	4	2	0	-2	-4	-6	-8	-10
Correction factor	PUHY-200-250	1.0	0.95	0.84	0.83	0.87	0.9	0.95	0.95	0.95
	PUHY-315	1.0	0.93	0.82	0.82	0.86	0.9	0.9	0.95	0.95

2-5. Operation limit

• Cooling

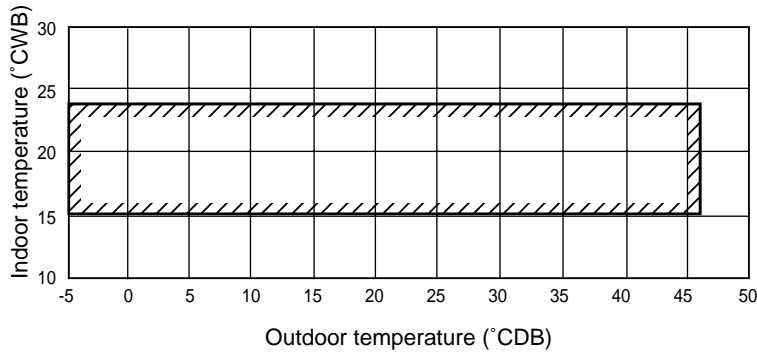

(Outdoor door temperature :10°CDB-46°CDB with outdoor unit at lower position in cooling mode.)

Y-8,10,13(R22)

• Heating

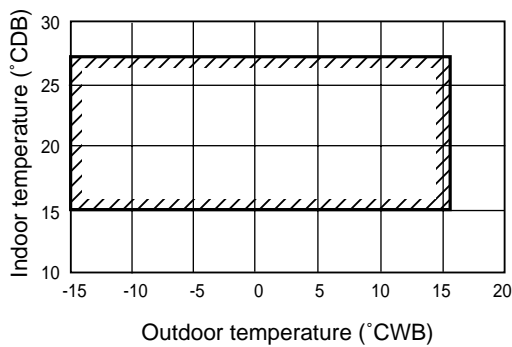

When the indoor P25(P20) type only is working, the outdoor unit [PUHY-315] inlet air temperature becomes -12°C(-5°C)WB-10°CWB.

3. Sound Levels

PU(H)Y-200YEM(C)-A

Measurement condition

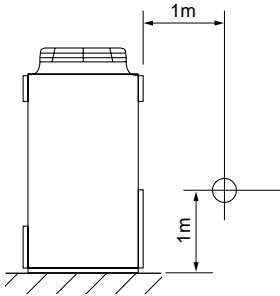

Sound pressure level in anechoic room

56 dB (A)

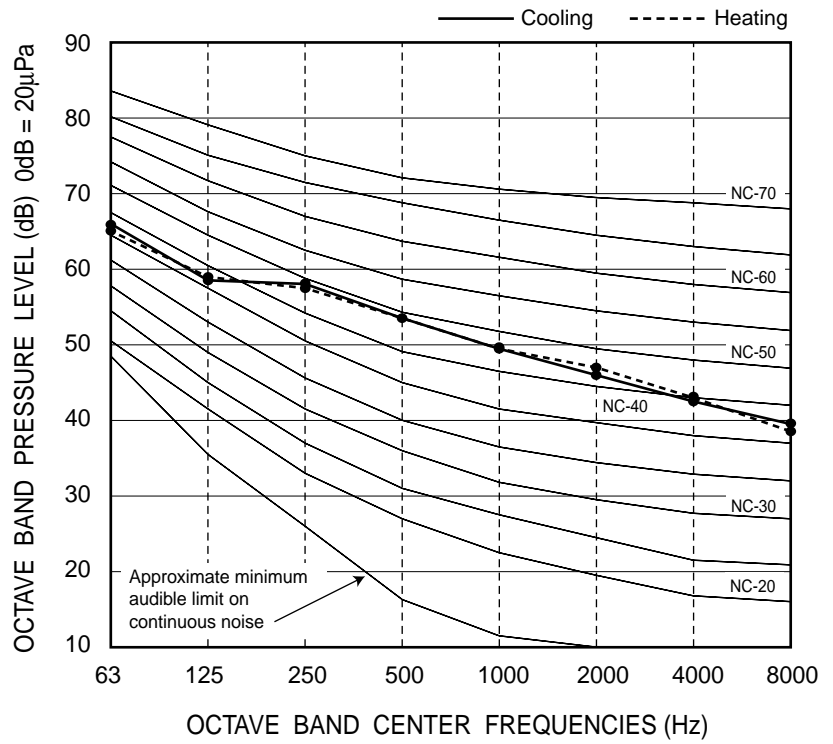

PU(H)Y-250YEM(C)-A

Measurement condition

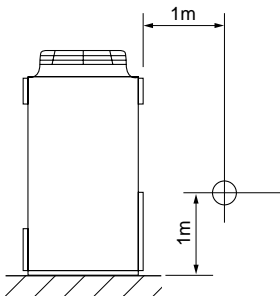

Sound pressure level in anechoic room

57 dB (A)

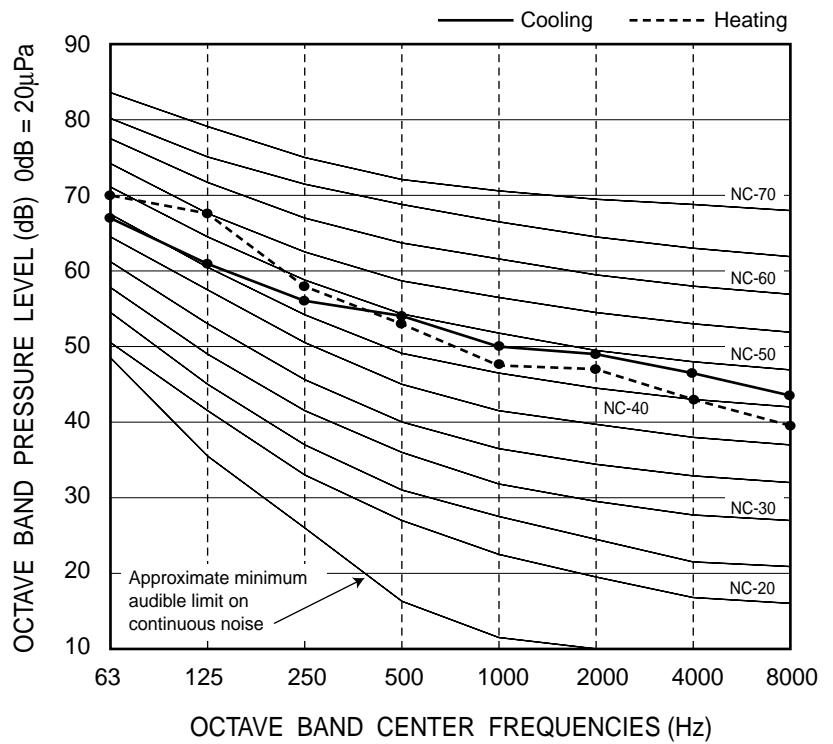

Y-8,10,13(R22)

PU(H)Y-250YEMK-A

Measurement condition

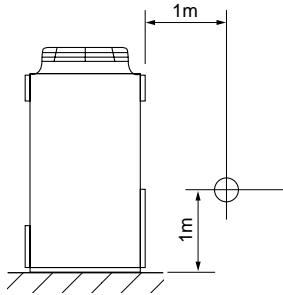

Sound pressure level in anechoic room
57 dB (A)

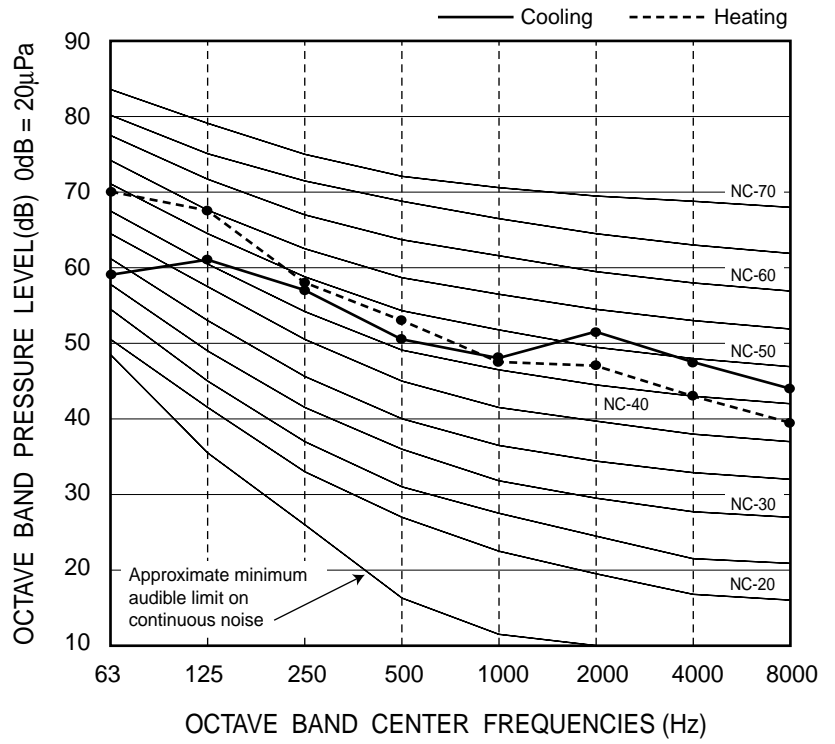

PU(H)Y-315YEM(K,C)-A

Measurement condition

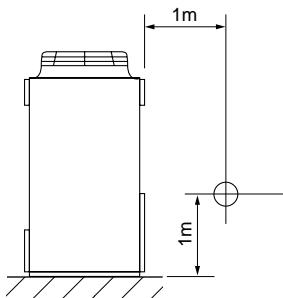

Sound pressure level in anechoic room
60 dB (A)

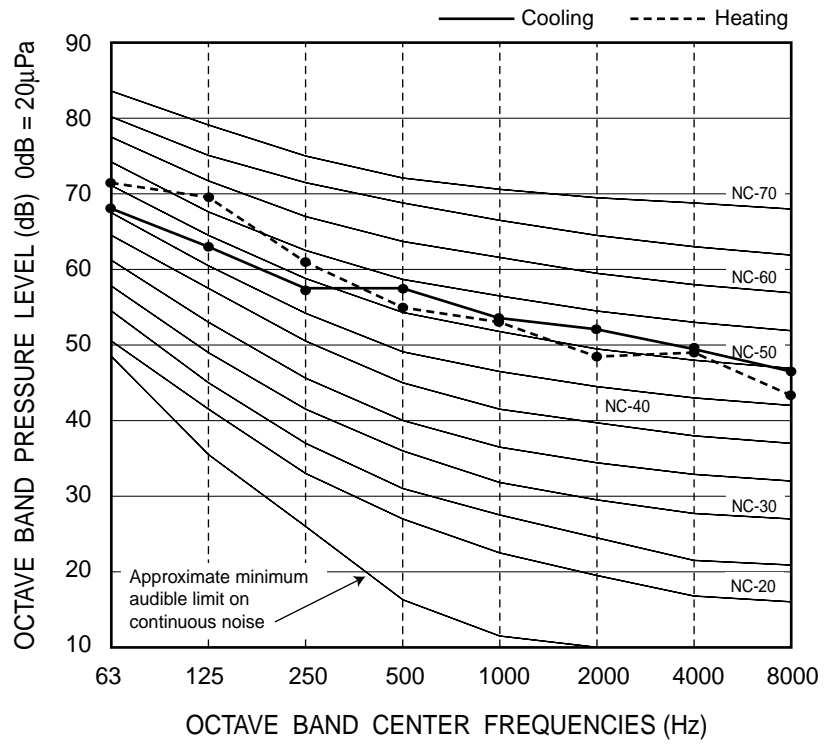

Y-8,10,13(R22)

4. External Dimensions

PU(H)Y-200, 250, 315YEM(K, C)-A(-BF, -BS)

Unit : mm

- <Accessory>
- Refrigerant (gas) conn. pipe.....1pc.
(The connecting pipe is fixed with the unit)
- Packing for conn. pipe1pc.
(Attached near the ball valve)
- Wiring mounting board
- Conduit mounting plate
(Painted the same color as the unit body)
- $\phi 40$1pc.
- $\phi 27$1pc.
- $\phi 33$1pc.
- Tapping screw 4 X 10.....6pcs.

Note 1: Please leave a space under the outdoor unit for the piping. When you connect the piping from the bottom.
(Please be careful not to close the hole of the bottom plate by the basement)

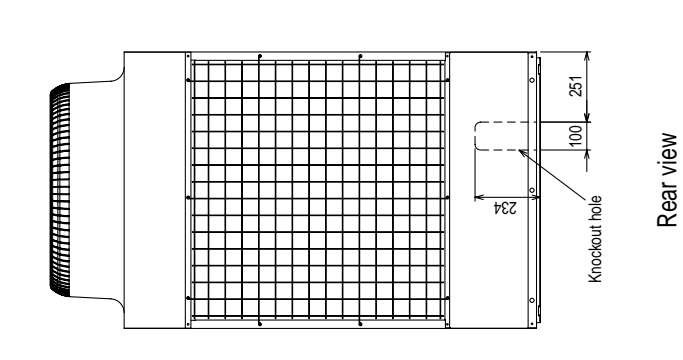
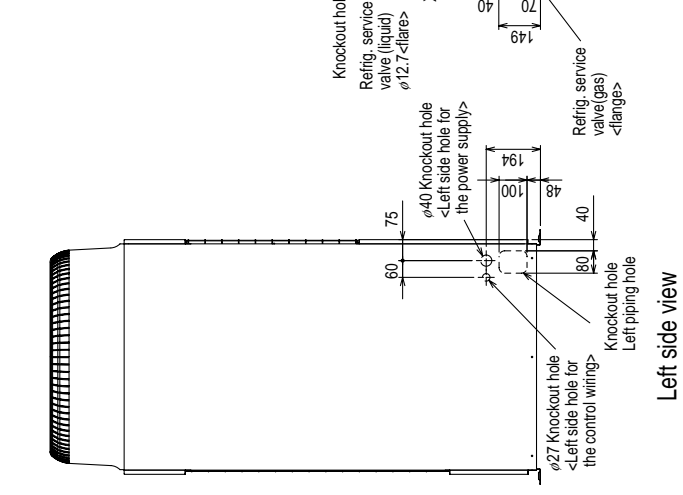
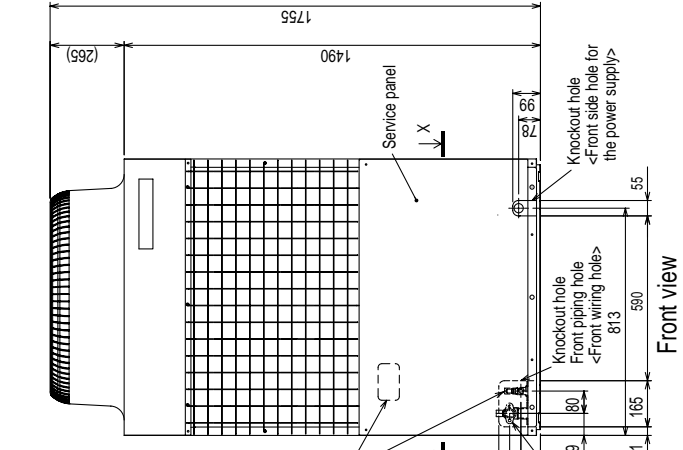
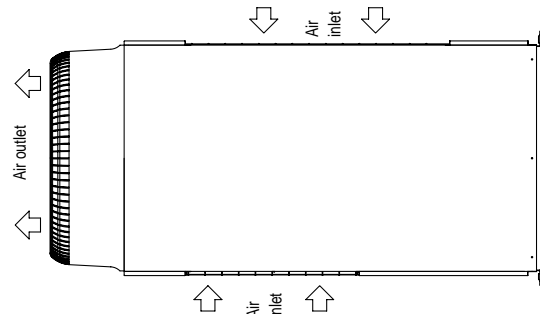
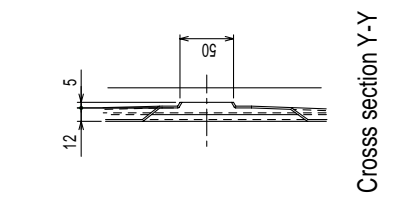
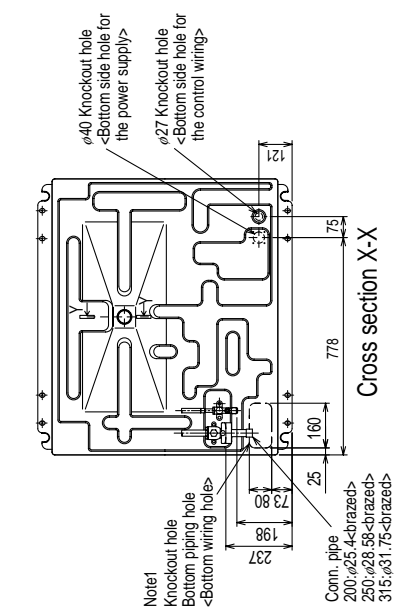
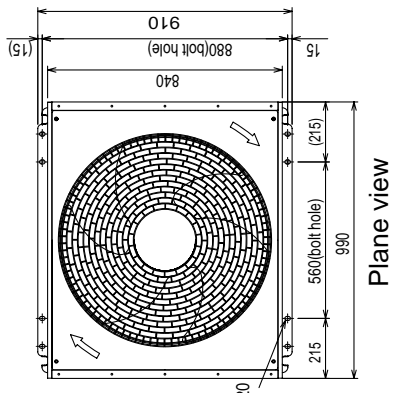

Y-8,10,13(R22)

5. Electrical Wiring Diagram

PU(H)Y-200, 250, 315YEM(K, C)-A(-BF, -BS)

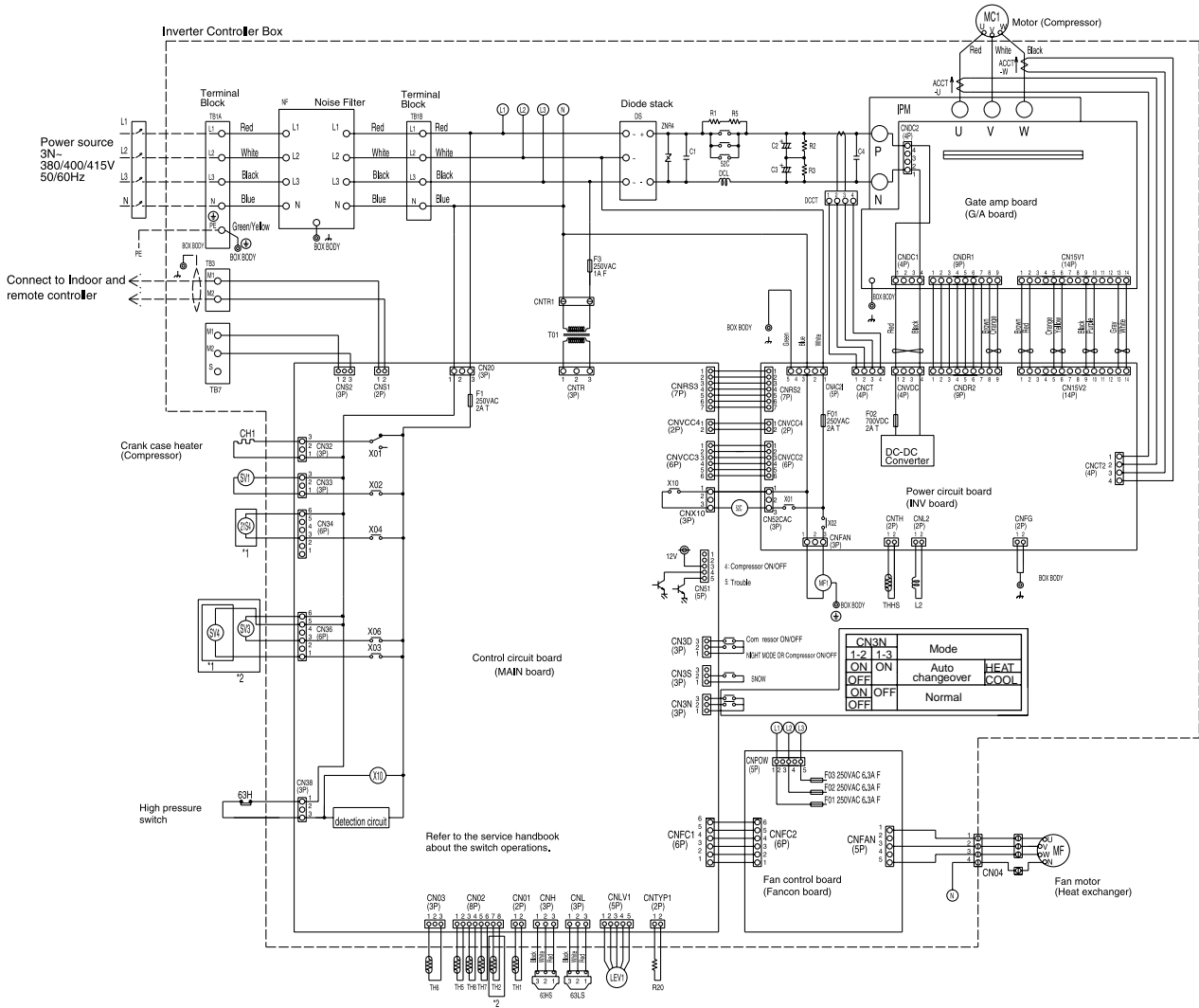

Y-8,10,13(R22)

<DIFFERENCE OF APPLIANCE>

Appliance	N a m e
PUHY-P200/250/315YEM-A	All exists
PUY-P200/250/315YEM-A	*"1" are not existed
PUHY-200/250/315YEM(K,C)-A	*"2" are not existed
PUY-200/250/315YEM(K,C)-A	*"1" and *"2" are not existed

<SYMBOL EXPLANATION>

Symbol	N a m e	Symbol	N a m e	Symbol	N a m e	Symbol	N a m e
DCL	DC reactor (Power factor improvement)	SV3 *2	Solenoid valve (Heat exchanger capacity control)	L2	Choke coil (Transmission)	TH8	Thermistor bypass outlet temp. detect at Sub-cool coil
DCCT	Current Sensor	SV4	Solenoid valve (Discharge-suction bypass)	IPM	Intelligent power module	TH5	Radiator panel temp. detect
ACCT-U,W	Current Sensor	LEV1	Electric expansion valve (Sub-cool coil bypass)	TH1	Thermistor Discharge pipe temp. detect	X1-10	Aux. relay
ZNR4	Varistor	63HS	High pressure sensor	TH2 *2	Saturation evapo. temp. detect	⊕	Earth terminal
52C	Magnetic contactor (Inverter main circuit)	63LS	Low pressure sensor	TH5	Pipe temp. detect		
MF1	Fan motor (Radiator panel)			TH6	OA temp. detect		
21S4 *1	4-way valve			TH7	liquid outlet temp. detect at Sub-cool coil		
SV1	Solenoid valve (Discharge-suction bypass)						

6. Refrigerant Circuit Diagram And Thermal Sensor

PUHY-200, 250, 315YEM(K,C)-A

Y-8,10,13(R22)

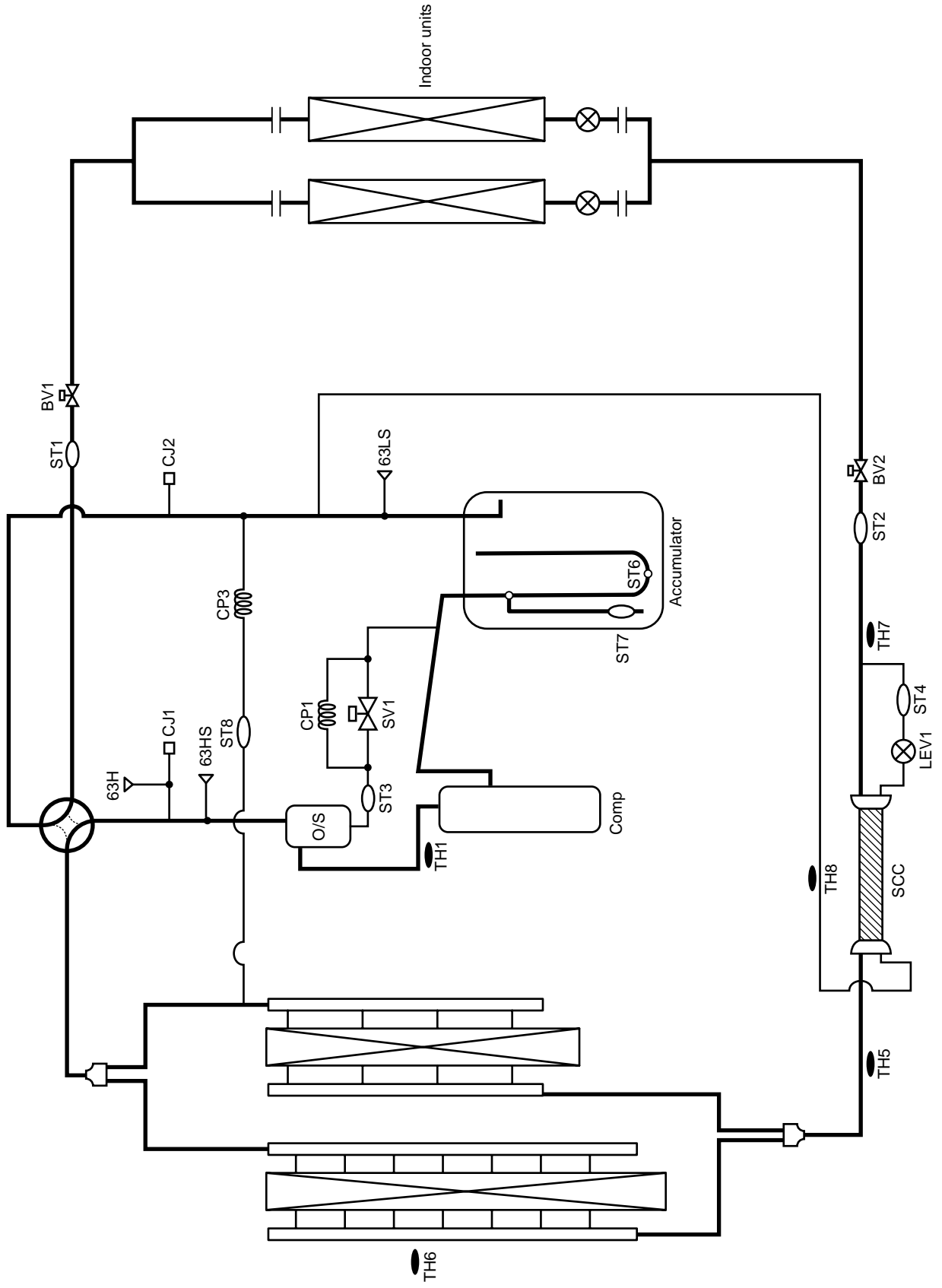

PUY-200, 250, 315YEM-A

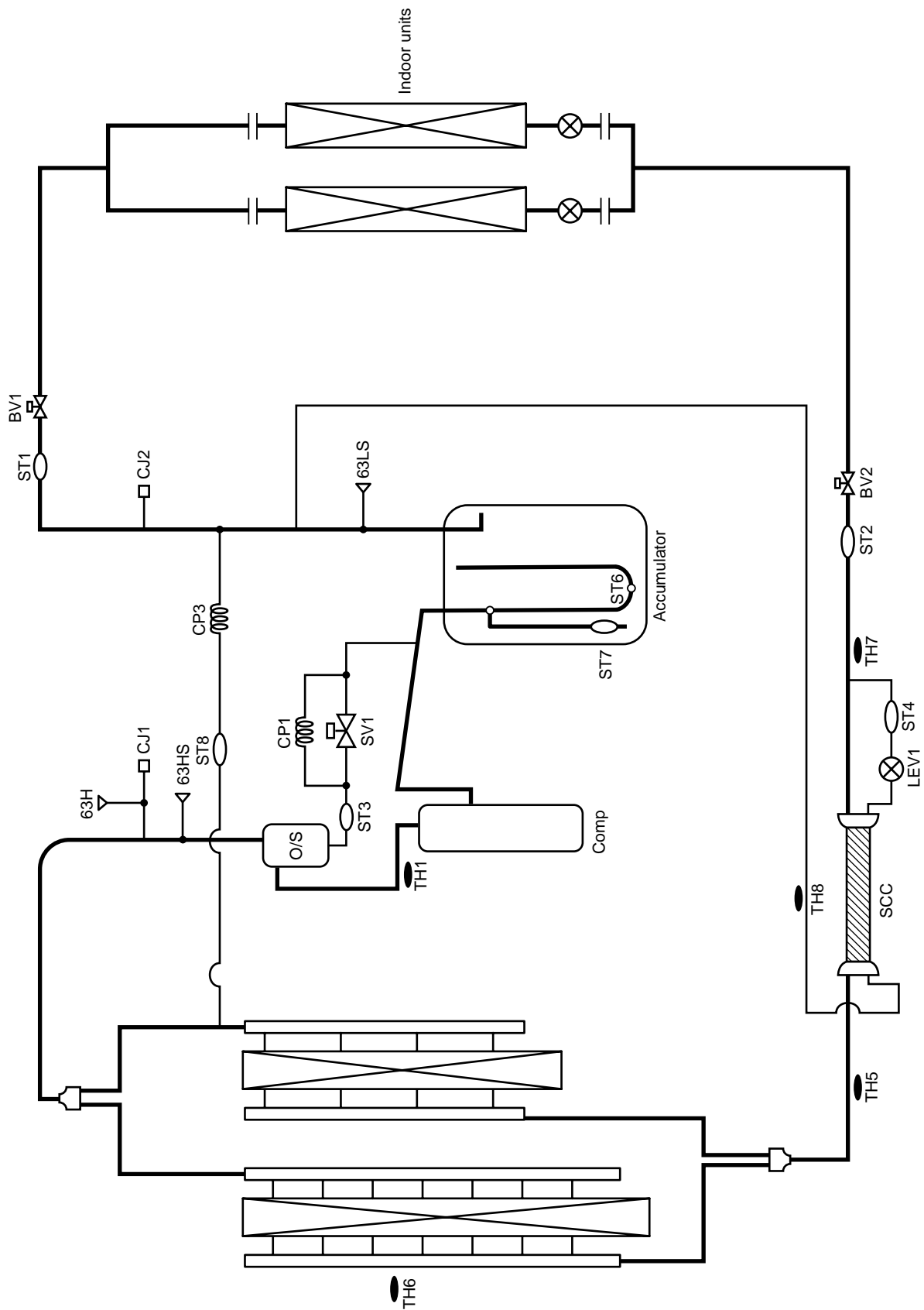

Y-8,10,13(R22)

Y-8,10,13 (R22)

PUHY-200-250-315TEM-A(-BF)

CONTENTS

1. Specifications	I -198
2. Capacity Tables	I -201
2-1 Correction by temperature	I -201
2-2 Correction by total indoor	I -203
2-3 Correction by refrigerant piping length	I -205
2-4 Correction at frosting and defrosting	I -206
2-5 Operation limit	I -206
3. Sound Levels	I -207
4. External Dimensions	I -209
5. Electrical Wiring Diagram	I -210
6. Refrigerant Circuit Diagram	I -211
And Thermal Sensor	

1. Specifications

Model name		PUHY-200TEM-A(-BF)	
		Cooling	Heating
Capacity	*1	kW	22.4
	*2	kcal/h	20,000
Power source		3 ~ 208/220/230V 60Hz	
Power input		kW	6.19
Current		A	19.0/18.0/17.2
Fan	Type X Quantity		Propeller fan X 1
	Airflow rate	m ³ /min	200
	Motor output	kW	0.38
Compressor	Type		Hermetic
	Motor output	kW	5.3
	Crankcase heater	kW	0.045(230V)
Refrigerant / Lubricant		R22/MS32(N-1)	
External finish		Pre-coated galvanized sheets <MUNSELL 5Y8/1 or similar>	
External dimension		mm	1755(H)X990(W)X840(L)
Protection devices	High pressure protection		2.94MPa
	Compressor / Fan		Over current protection / Thermal switch
	Inverter		DC bus current protection, thermal switch
Refrigerant piping diameter		Liquid / Gas	φ 12.7 (Flare) / φ 25.4 (Flange)
Indoor unit	Total capacity		50 ~ 130% of outdoor unit capacity
	Model / Quantity		Model 20 ~ 250 / 1 ~ 13
Noise level	*	dB<A>	56
Net weight		kg	214
Operating temperature range		Indoor:15°CWB ~ 24°CWB Outdoor:-5°CDB ~ 43°CDB (10°CDB ~ 43°CDB with outdoor unit at lower position)	Indoor:15°CDB ~ 27°CDB Outdoor:-15°CWB ~ 15.5°CWB

Note: 1.Cooling/heating capacity indicates the maximum value at operation under the following condition.

*1 Cooling	Indoor : 27°CDB/19°CWB	Outdoor : 35°CDB	*2 Cooling	Indoor : 27°CDB/19.5°CWB	Outdoor : 35°CDB
Heating	Indoor : 20°CDB	Outdoor : 7°CDB/6°CWB		Pipe length : 5m	Height difference : 0m
	Pipe length : 7.5m	Height difference : 0m			

* It is measured in anechoic room.

Model name		PUHY-250TEM-A(-BF)	
		Cooling	Heating
Capacity	*1	kW	28.0
	*2	kcal/h	25,000
Power source		3 ~ 208/220/230V 60Hz	
Power input		kW	8.37
Current		A	25.8/24.4/23.3
Fan	Type X Quantity		Propeller fan X 1
	Airflow rate	m ³ /min	200
	Motor output	kW	0.38
Compressor	Type		Hermetic
	Motor output	kW	6.8
	Crankcase heater	kW	0.045(230V)
Refrigerant / Lubricant		R22/MS32(N-1)	
External finish		Pre-coated galvanized sheets <MUNSELL 5Y8/1 or similar>	
External dimension		mm	1755(H)X990(W)X840(L)
Protection devices	High pressure protection		2.94MPa
	Compressor / Fan		Over current protection / Thermal switch
	Inverter		DC bus current protection, thermal switch
Refrigerant piping diameter		Liquid / Gas	φ 12.7 (Flare) / φ 28.58 (Flange)
Indoor unit	Total capacity		50 ~ 130% of outdoor unit capacity
	Model / Quantity		Model 20 ~ 250 / 1 ~ 16
Noise level	*	dB<A>	57
Net weight		kg	214
Operating temperature range		Indoor:15°CWB ~ 24°CWB Outdoor:-5°CDB ~ 43°CDB (10°CDB ~ 43°CDB with outdoor unit at lower position)	Indoor:15°CDB ~ 27°CDB Outdoor:-15°CWB~15.5°CWB

Note: 1.Cooling/heating capacity indicates the maximum value at operation under the following condition.

*1 Cooling	Indoor : 27°CDB/19°CWB	Outdoor : 35°CDB	*2 Cooling	Indoor : 27°CDB/19.5°CWB	Outdoor : 35°CDB
Heating	Indoor : 20°CDB	Outdoor : 7°CDB/6°CWB	Pipe length : 5m	Height difference : 0m	
	Pipe length : 7.5m	Height difference : 0m			

* It is measured in anechoic room.

TEM-A

Model name			PUHY-315TEM-A(-BF)	
			Cooling	Heating
Capacity	*1	kW	35.5	39.1
	*2	kcal/h	31,500	—
Power source			3N ~ 208/220/230V 60Hz	
Power input		kW	12.05	10.91
Current		A	36.3/34.3/32.8	33.2/31.4/30.0
Fan	TypeX Quantity		Propeller fan X 1	
	Airflow rate		m ³ /min	200
	Motor output		kW	0.38
Compressor	Type		Hermetic	
	Motor output		kW	8.6
	Crankcase heater		kW	0.045(230V)
Refrigerant / Lubricant			R22/MS32(N-1)	
External finish			Pre-coated galvanized sheets <MUNSELL 5Y8/1 or similar>	
External dimension		mm	1755(H)X 990(W) X 840(L)	
Protection devices	High pressure protection		2.94MPa	
	Compressor / Fan		Overcurrent protection / Thermal switch	
	Inverter		AC bus current protection, thermal switch	
Refrigerant piping diameter		Liquid / Gas	φ 12.7 (Flare) / φ 31.75 (Flange)	
Indoor unit	Total capacity		50 ~ 130% of outdoor unit capacity	
	Model / Quantity		Model 20 ~ 250 / 1 ~ 16	
Noise level		* dB<A>	60	
Net weight		kg	229	
Operating temperature range			Indoor:15°CWB ~ 24°CWB Outdoor:-5°CDB ~ 43°CDB (0°CDB~43°CDB with outdoor unit at lower position)	Indoor:15°CDB ~ 27°CDB Outdoor:-15°CWB ~ 15.5°CWB (-12°C(-5°C)WB~10°CWB with indoor unit P25(P20)type only is working.)
Matters Deserving Special Mention			A pipe of φ34.93 can be used for the gas pipe	

Note: 1.Cooling/heating capacity indicates the maximum value at operation under the following condition.

*1 **Cooling** Indoor : 27°CDB/19°CWB Outdoor : 35°CDB

Heating Indoor : 20°CDB Outdoor : 7°CDB/6°CWB
Pipe length : 7.5m Height difference : 0m

*2 **Cooling** Indoor : 27°CDB/19.5°CWB Outdoor : 35°CDB

Pipe length : 5m Height difference : 0m

* It is measured in anechoic room.

2. Capacity Table

2-1. Correction by temperature

Cooling

- Standard Specifications

		PUHY-200	PUHY-250	PUHY-315
Capacity	kW	22.4	28.0	35.5
Input	kW	6.19	8.37	12.05

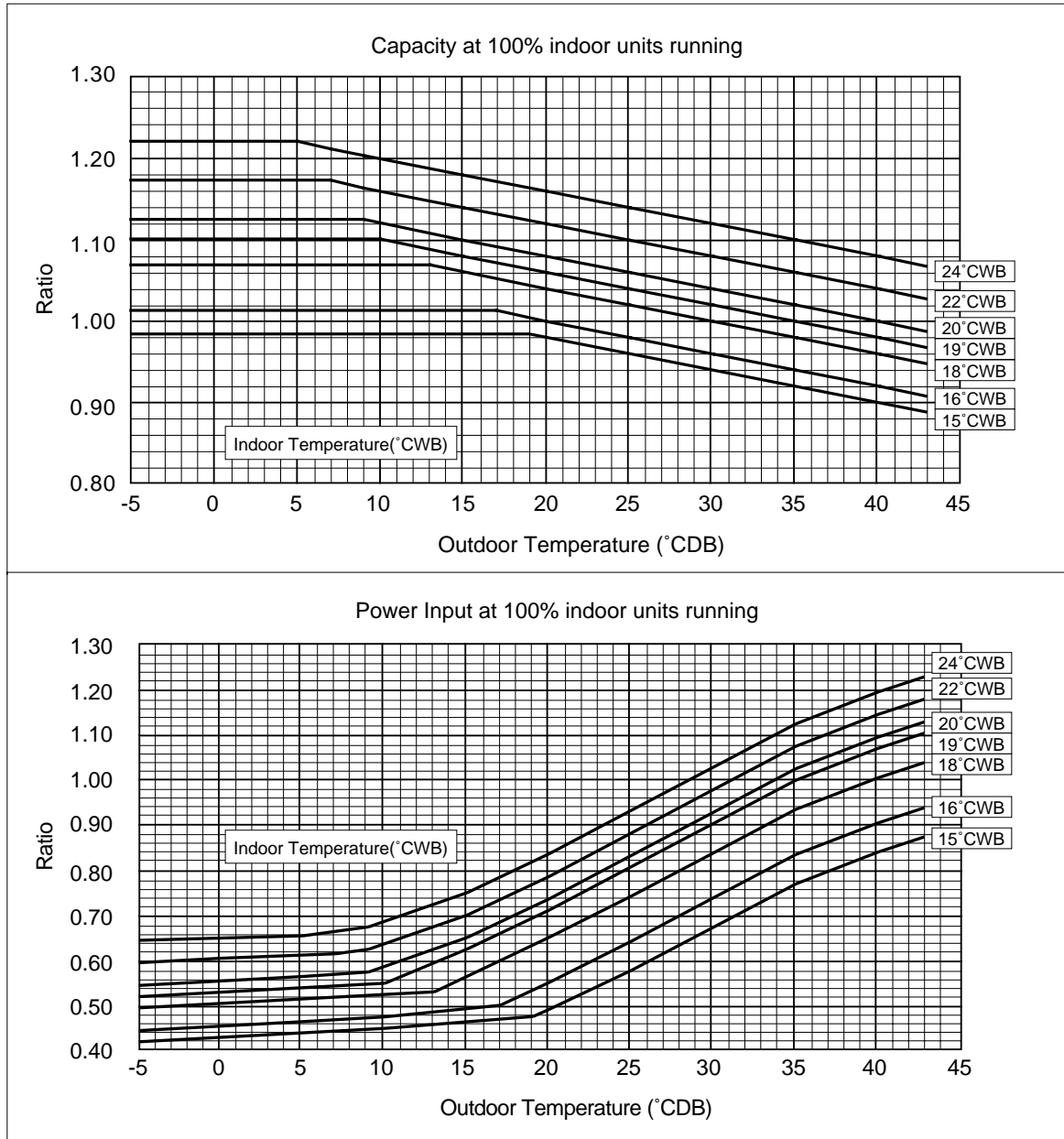

TEM-A

Heating

- Standard Specifications

		PUHY-200	PUHY-250	PUHY-315
Capacity	kW	25.0	31.5	39.1
Input	kW	6.66	8.77	10.91

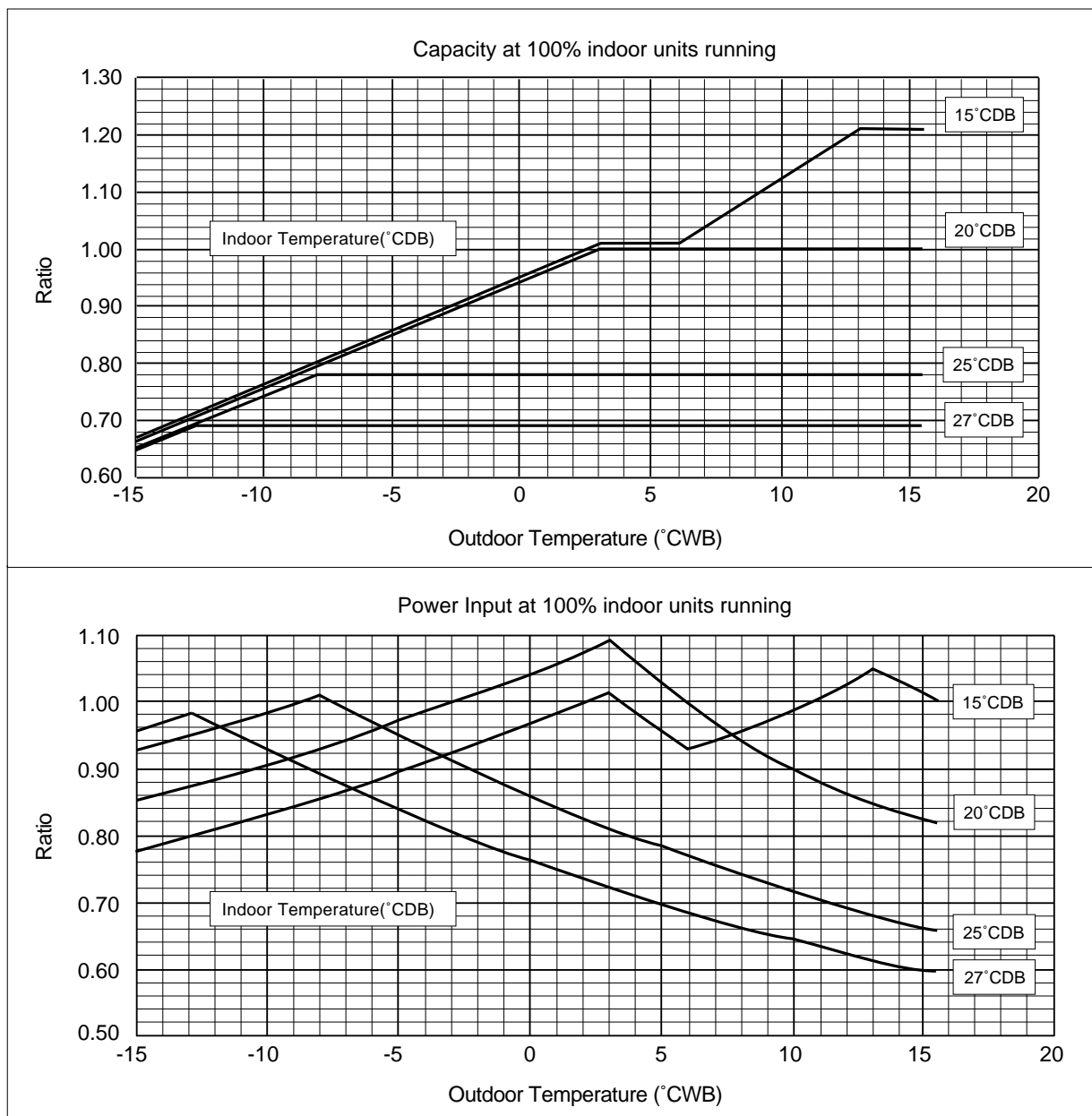

TEM-A

2-2. Correction by total indoor

PUHY-200

1) Capacity

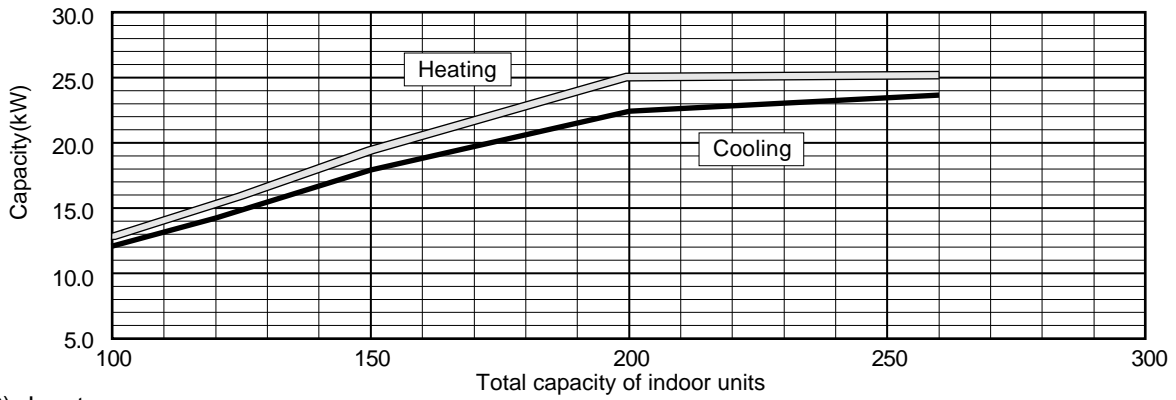

2) Input

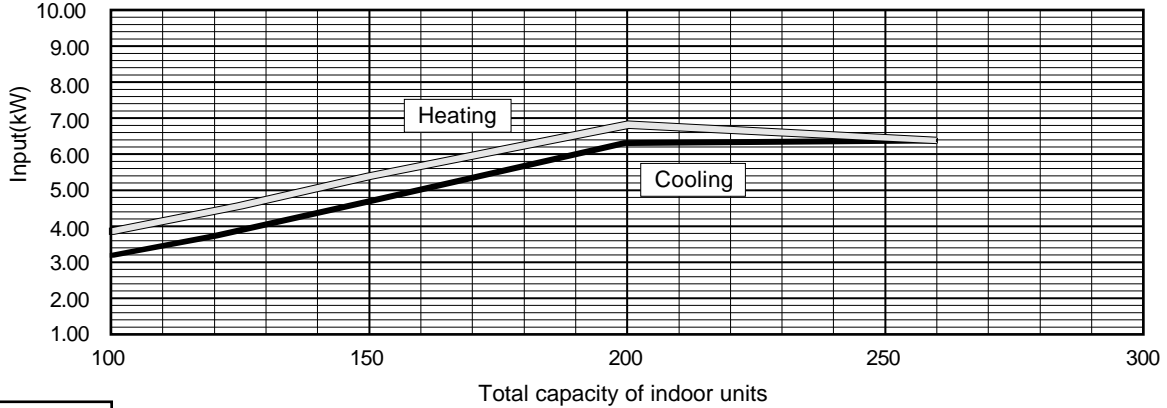

PUHY-250

1) Capacity

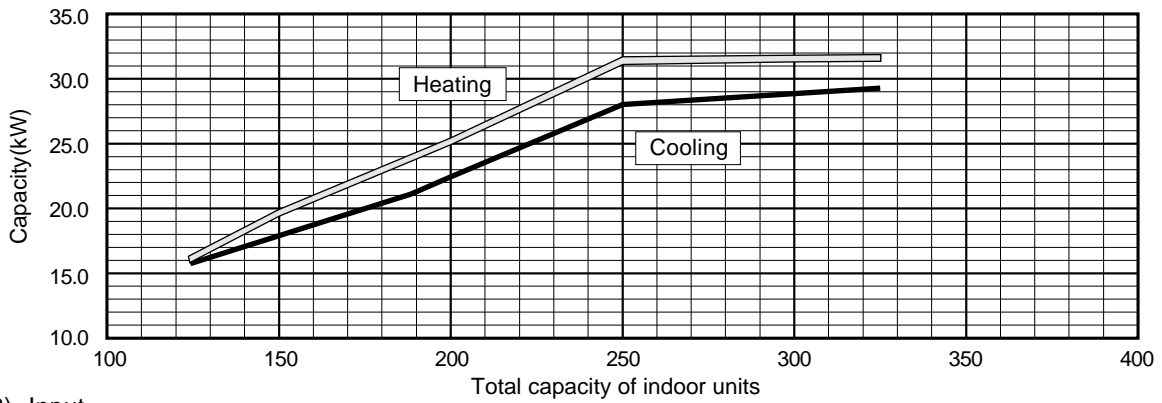

2) Input

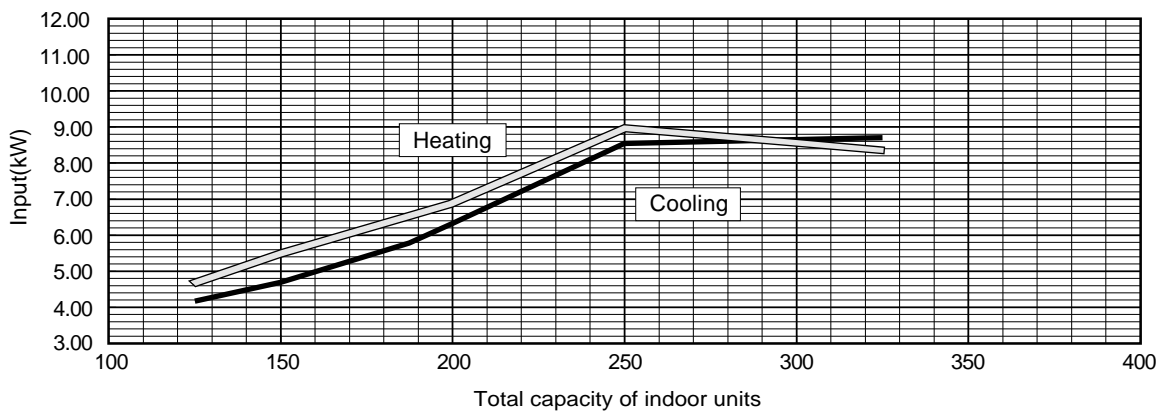

TEM-A

2-2. Correction by total indoor

PUHY-315

1) Capacity

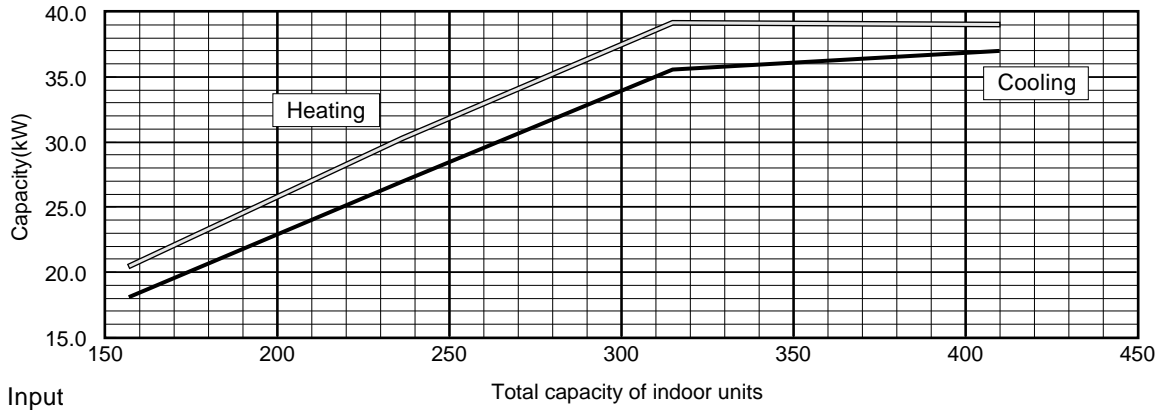

2) Input



2-3. Correction by refrigerant piping length

To obtain a decrease in cooling/heating capacity due to refrigerant piping extension, multiply by the capacity correction factor based on the refrigerant piping equivalent length in the table below.

• Cooling capacity correction

PUHY-200

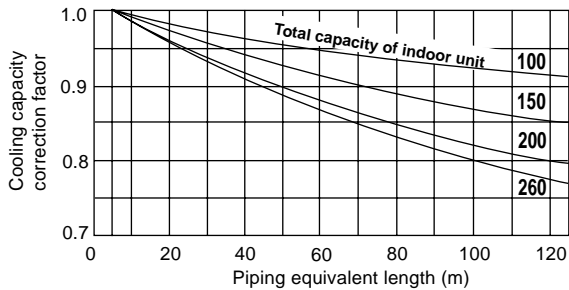

PUHY-250

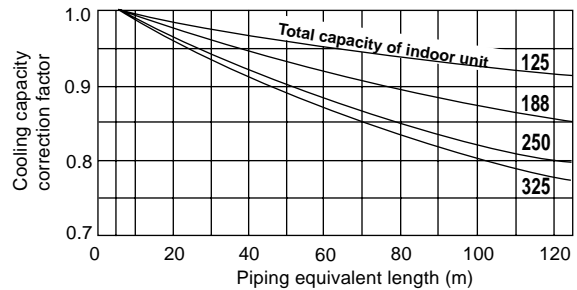

PUHY-315

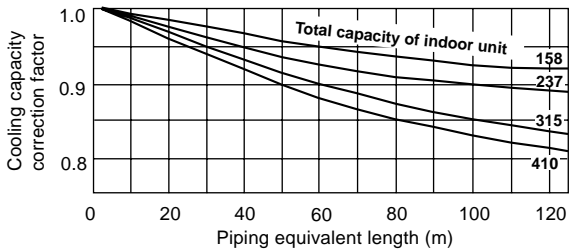

• Heating capacity correction

PUHY-200

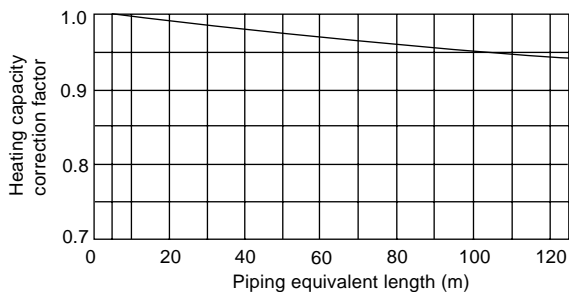

PUHY-250

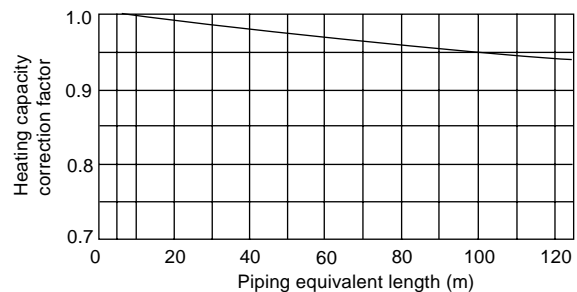

PUHY-315

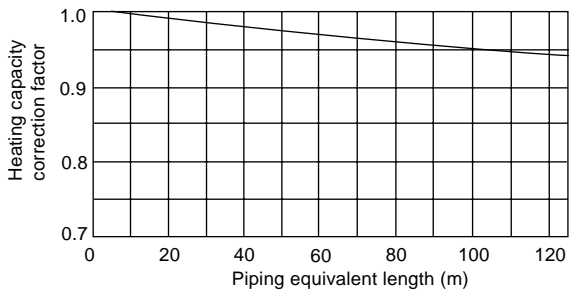

• How to obtain piping equivalent length

① PUHY-200

Equivalent length = (Actual piping length to the farthest indoor unit) + (0.47 × number of bent on the piping)m

② PUHY-250

Equivalent length = (Actual piping length to the farthest indoor unit) + (0.50 × number of bent on the piping)m

③ PUHY-315

Equivalent length = (Actual piping length to the farthest indoor unit) + (0.70 × number of bent on the piping)m

2-4. Correction at frosting and defrosting

When a decrease in heating capacity due to frosted and defrosting operations is considered, the value multiplied by the correction factor in the table below represents the heating capacity.

Correction factor table

Outdoor inlet air temp (°CWB)		6	4	2	0	-2	-4	-6	-8	-10
Correction factor	PUHY-200-250	1.0	0.95	0.84	0.83	0.87	0.9	0.95	0.95	0.95
	PUHY-315	1.0	0.93	0.82	0.82	0.86	0.90	0.90	0.95	0.95

2-5. Operation limit

• Cooling

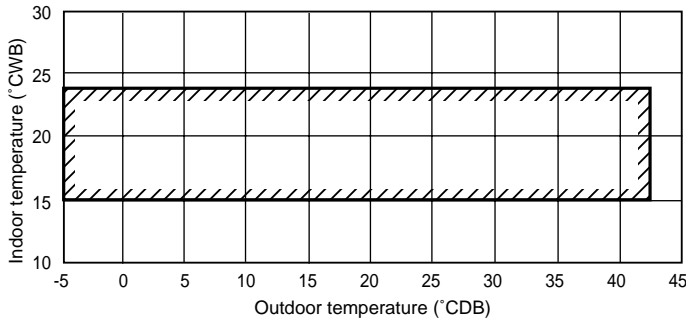

(Outdoor temperature :10°CDB ~ 43°CDB with outdoor unit at lower position in cooling mode.)

• Heating

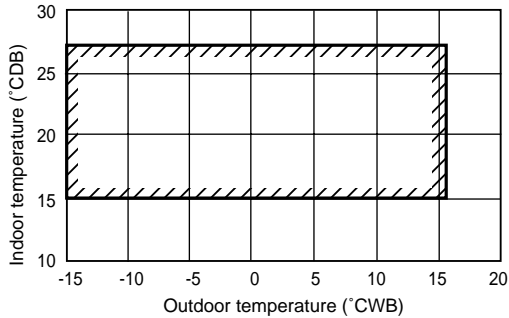

When the indoor P25(P20)type only is working, the outdoor unit [PUHY-315] inlet air temperature becomes -12°C(-5°C)WB~ 10°CWB.

3. Sound Levels

PUHY-200

Measurement condition

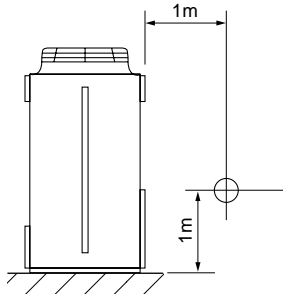

Sound pressure level in anechoic room
56 dB (A)

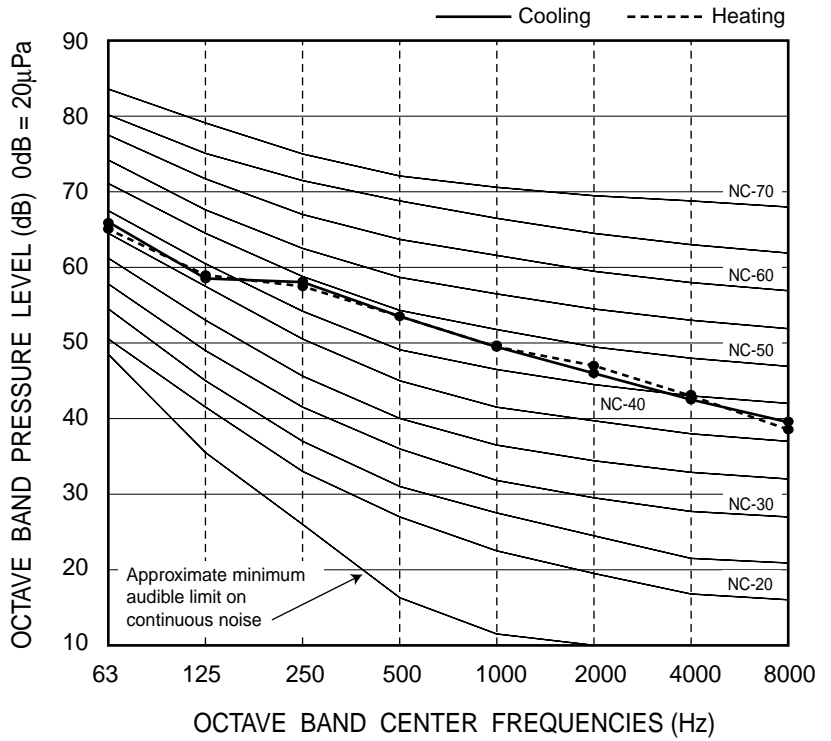

PUHY-250

Measurement condition

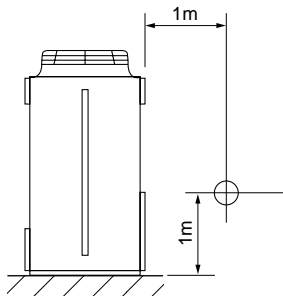

Sound pressure level in anechoic room
57 dB (A)

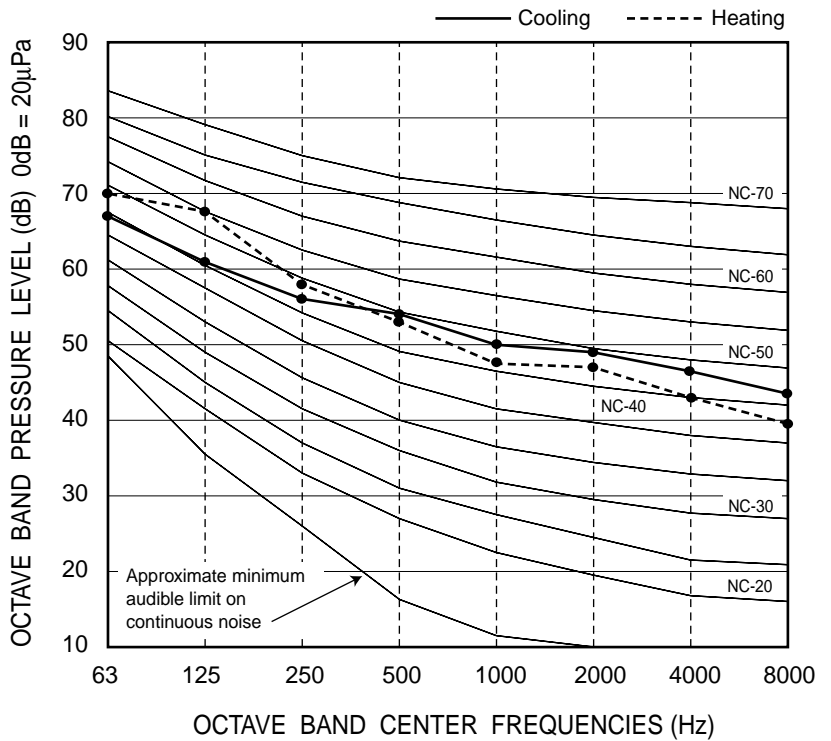

TEM-A

PUHY-315

Measurement condition

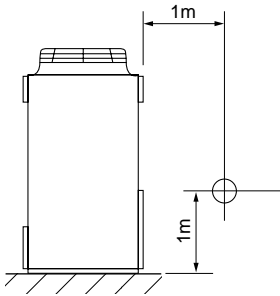

Sound pressure level in anechoic room
60 dB (A)

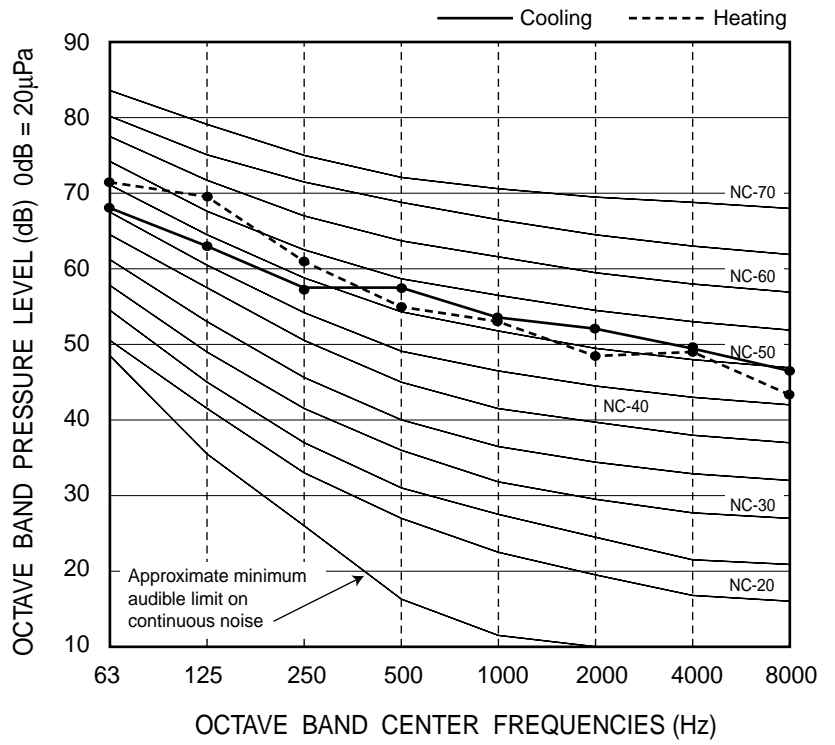

TEM-A

4. External Dimensions

PUHY-200,250,315TEM-A(-BF)

Unit : mm

- <Accessory>
 - Refrigerant (gas) conn. pipe.....1pc.
(The connecting pipe is fixed with the unit)
 - Packing for conn. pipe1pc.
(Attached near the ball valve)
 - Wiring mounting board
 - Conduit mounting plate
(Painted the same color as the unit body)
 - $\phi 40$1pc.
 - $\phi 33$1pc.
 - $\phi 27$1pc.
 - Tapping screw 4 X 10.....6pcs.
- Note 1. Please leave a space under the outdoor unit for the piping. When you connect the piping from the bottom.
(Please be careful not to close the hole of the bottom plate by the basement)

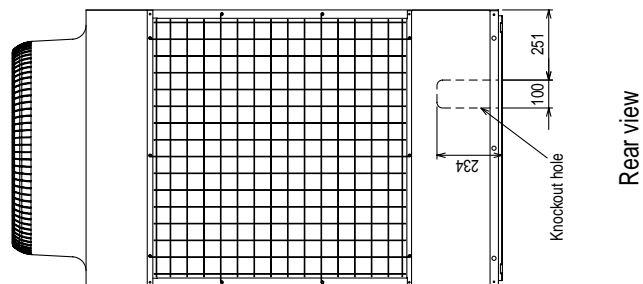
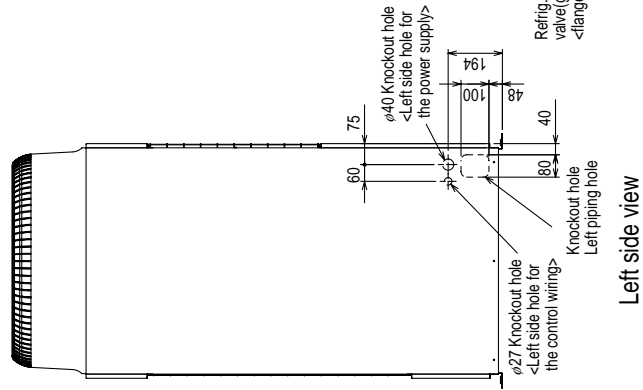
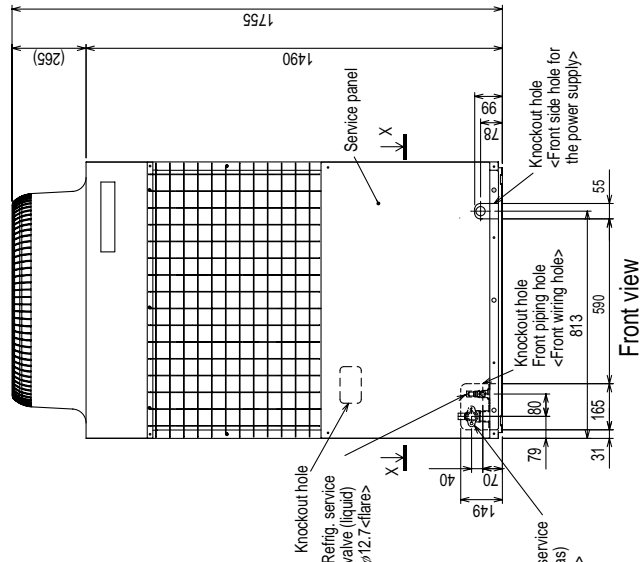
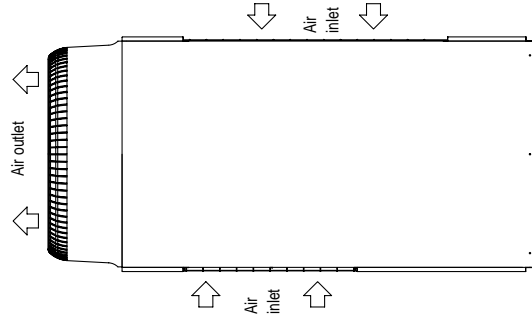
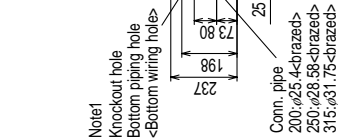
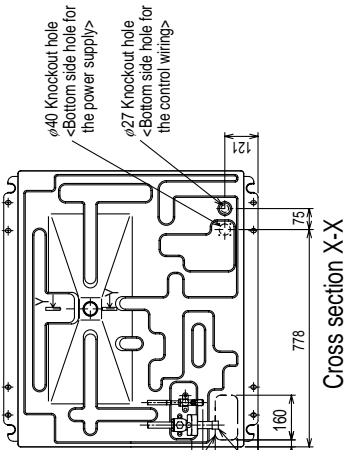
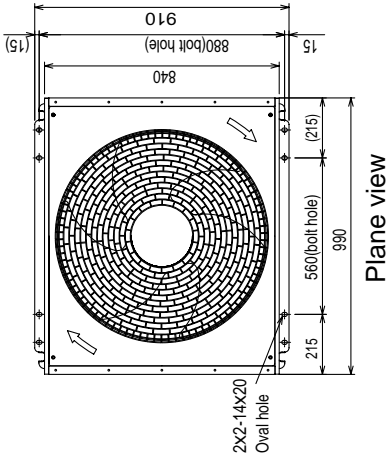

5. Electrical Wiring Diagram

PUHY-200, 250, 315TEM-A(-BF)

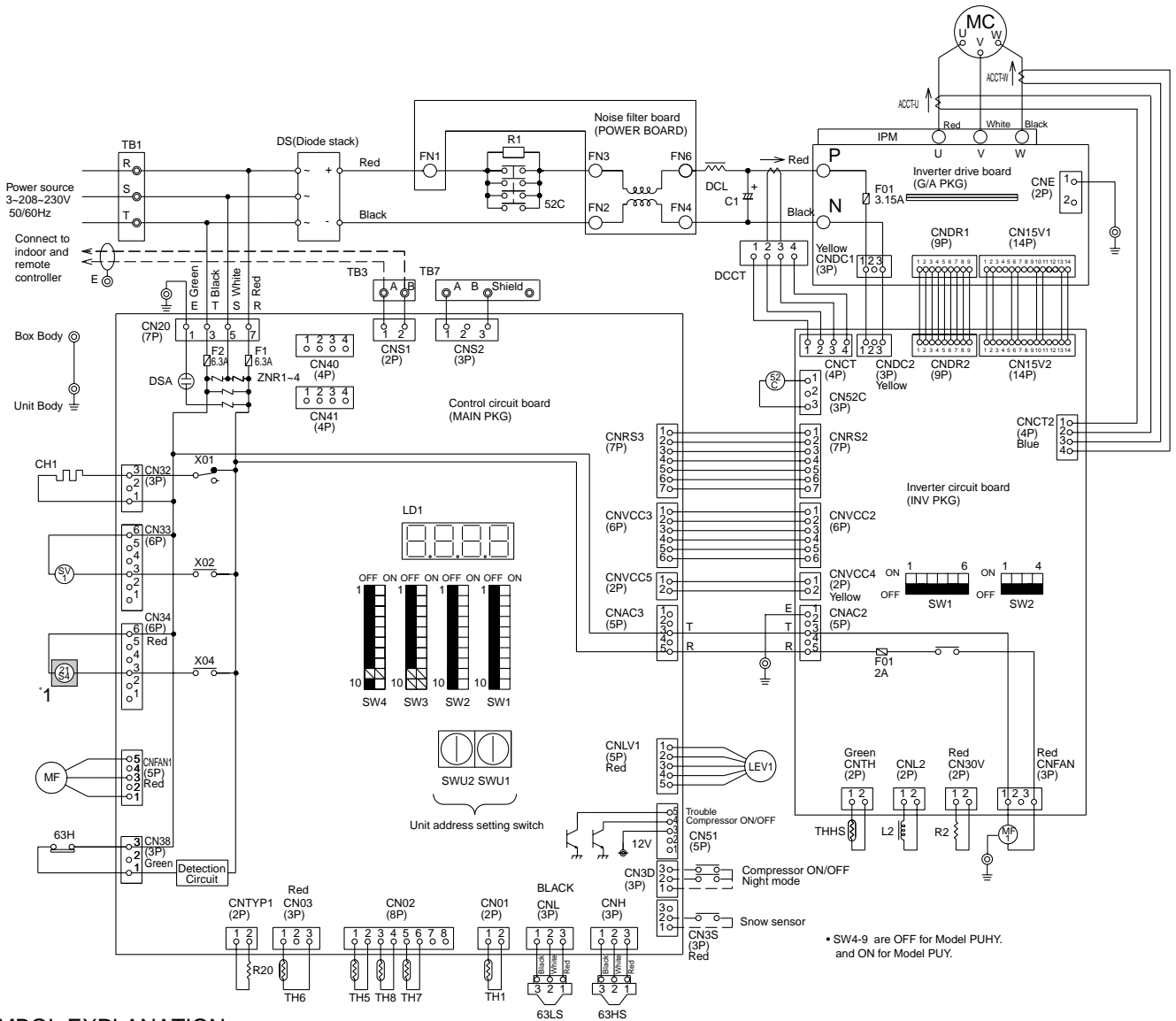

<SYMBOL EXPLANATION>

Symbol	Name	Symbol	Name	Symbol	Name	Symbol	Name	
TB1	Terminal block power source	52C	Magnetic contactor (Inverter main circuit)	TH1	Thermistor	63HS	High pressure sensor	
TB3	Terminal block transmission	MC	Motor Compressor	TH5		pipe temp.detect	LEV1	Electric expansion valve (Sub-cool coil bypass)
TB7	Terminal block transmission centralized control	MF	Motor Fan Heat exchanger	TH6		OA temp.detect	L2	Choke coil(Transmission)
E	Earth terminal	MF1	Motor Fan Radiator panel	TH7		liquid outlet temp. detect at Sub-cool coil	IPM	Itelligent power module
ACCT-U,W	Current Sensor	CH1	Crankcase heater (Compressor)	TH8	bypass outlet temp. detect at Sub-cool coil	X01-04	Axu. Relay	
DCCT	Current Sensor	21S4 '1	4-way valve	THHS	Radiator panel temp.detect	DCL	DC reactor (Power factor improvement)	
R1	Resistor rush current protect	SV1	Solenoid valve (Discharge-suction bypass)			63LS	Low pressure sensor	
R2	Resistor power regulation	63H	High pressure switch			DSA	Surge suppressor	
R20	Resistor	ZNR1-ZNR4	Varistor			F1,F2,F01	Fuse	
C1	Capacitor Smoothing					LD1	LED display	

<Difference of appliance>

Appliance	Difference (not existed)
PUHY-200, 250, 315TEM-A	
PUY-200, 250, 315TEM-A	'1

6. Refrigerant Circuit Diagram And Thermal Sensor

PUHY-200, 250, 315

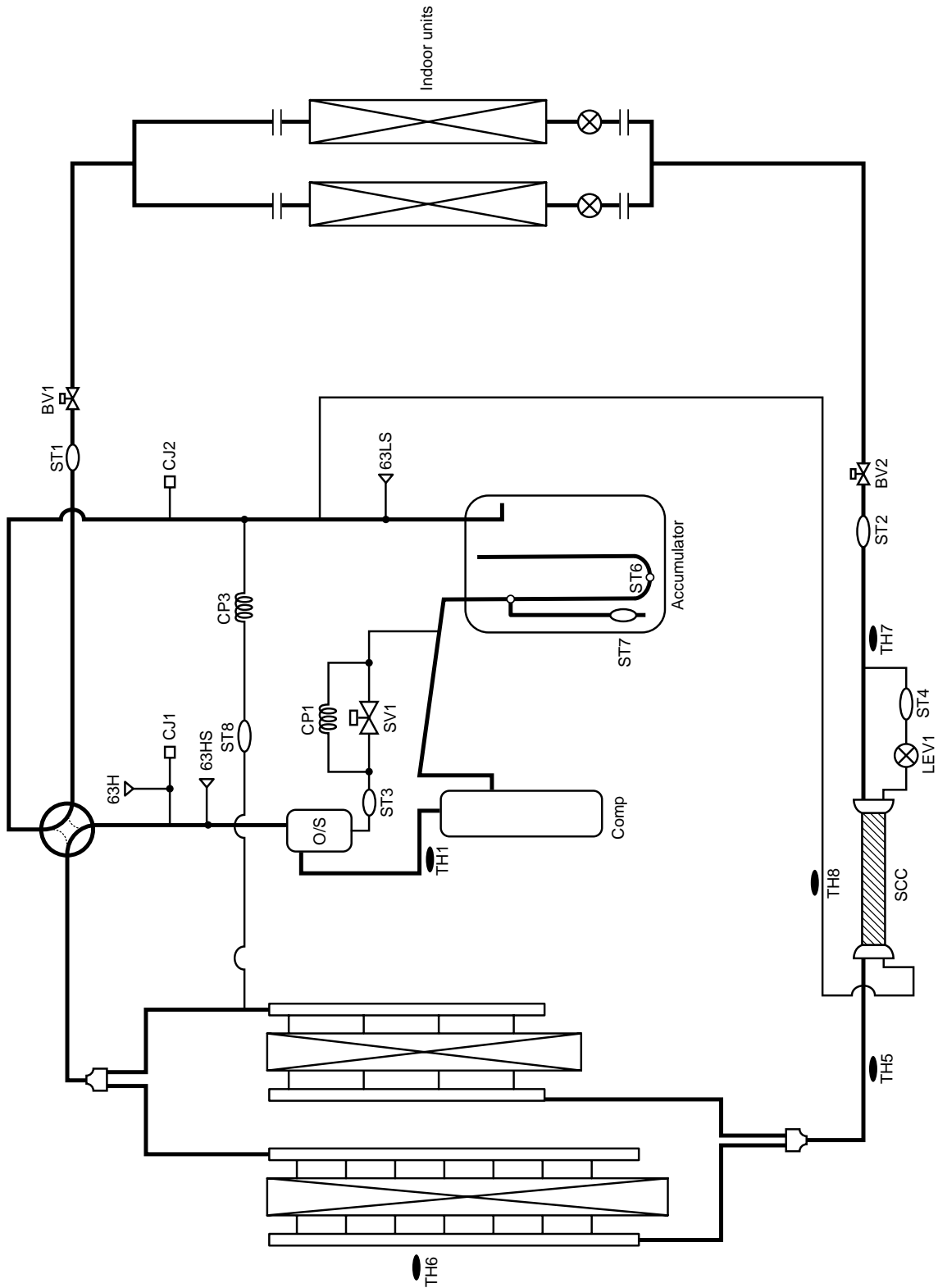

TEM-A

PUHY-400-500YEM-A(-BF, -BS)
PUHY-400-500YEMK-A
PUHY-400-500YEMC-A(-BS)

CONTENTS

1. Specifications	I -214
2. Capacity Tables	I -216
2-1 Correction by temperature	I -216
2-2 Correction by total indoor	I -218
2-3 Correction by refrigerant piping length	I -219
2-4 Correction at frosting and defrosting	I -220
2-5 Operation limit	I -220
3. Sound Levels	I -221
4. External Dimensions	I -222
5. Electrical Wiring Diagram	I -223
6. Refrigerant Circuit Diagram	I -224
And Thermal Sensor	

1. Specifications

Model name		PUHY-400YEM-A (-BF, -BS) PUHY-400YEMK-A PUHY-400YEMC-A(-BS)	
		Cooling	Heating
Capacity	*1	kW	45.0
	*2	kcal/h	40,000
Power source		3N ~ 380/400/415V 50/60Hz	
Power input		kW	15.87
Current		A	26.7/25.4/24.5
Fan	TypeX Quantity		Propeller fan X2
	Airflow rate	m ³ /min	400
	Motor output	kW	0.38 X 2
Compressor	Type		Hermetic
	Motor output	kW	7.5 + 4.5
	Crankcase heater	kW	0.045 + 0.045
Refrigerant / Lubricant		R22/MS32(N-1)	
External finish		Pre-coated galvanized sheets(Powder coating) <MUNSELL 5Y8/1 or similar>	
External dimension		mm	1755(H)X 1990(W) X 840(L)
Protection devices	High pressure protection		2.94MPa
	Compressor / Fan		Overcurrent protection / Thermal switch
	Inverter		AC bus current protection, thermal switch
Refrigerant piping diameter		Liquid / Gas	φ 15.88 (Flare) / φ 34.93 (Flange)
Indoor unit	Total capacity		50 ~ 130% of outdoor unit capacity
	Model / Quantity		Model 25 ~ 250 / 1 ~ 20
Noise level	*	dB<A>	60 / 61
Net weight		kg	432
Operating temperature range		Indoor:15°CWB ~ 24°CWB Outdoor:-5°CDB ~ 46°CDB (10°CDB ~46°CDB with outdoor unit at lower position.)	Indoor:15°CDB ~ 27°CDB Outdoor:-12°CWB ~ 15.5°CWB (-12°CWB~10°CWB with indoor unit 25 type only is working)

Note: 1.Cooling/heating capacity indicates the maximum value at operation under the following condition.

*1 **Cooling** Indoor : 27°CDB/19°CWB Outdoor : 35°CDB

*2 **Cooling** Indoor : 27°CDB/19.5°CWB Outdoor : 35°CDB

Heating Indoor : 20°CDB Outdoor : 7°CDB/6°CWB

Pipe length : 5m Height difference : 0m

Pipe length : 7.5m Height difference : 0m

* It is measured in anechoic room.

Model name			PUHY-500YEM-A (-BF, -BS) PUHY-500YEMK-A PUHY-500YEMC-A(-BS)	
			Cooling	Heating
Capacity	*1	kW	56.0	63.0
	*2	kcal/h	50,000	-
Power source			3N ~ 380/400/415V 50/60Hz	
Power input		kW	18.98	17.92
Current		A	32.0/30.4/29.3	30.2/28.7/27.7
Fan	TypeX Quantity		Propeller fanX 2	
	Airflow rate	m ³ /min	400	
	Motor output	kW	0.38 X 2	
Compressor	Type		Hermetic	
	Motor output	kW	7.5 + 7.5	
	Crankcase heater	kW	0.045 + 0.056	
Refrigerant / Lubricant			R22 / MS32(N-1)	
External finish			Pre-coated galvanized sheets(Powder coating) <MUNSELL 5Y8/1 or similar>	
External dimension		mm	1755(H)X 1990(W) X 840(L)	
Protection devices	High pressure protection		2.94MPa	
	Compressor / Fan		Overcurrent protection / Thermal switch	
	Inverter		AC bus current protection, thermal switch	
Refrigerant piping diameter		Liquid / Gas	φ 15.88 (Flare) / φ 34.93 (Flange)	
Indoor unit	Total capacity		50 ~ 130% of outdoor unit capacity	
	Model / Quantity		Model 25 ~ 250 / 1 ~ 20	
Noise level		* dB<A>	60 / 61	
Net weight		kg	472	
Operating temperature range			Indoor:15°CWB ~ 24°CWB Outdoor:-5°CDB ~ 46°CDB (10°CDB ~46°CDB with outdoor unit at lower position.)	Indoor:15°CDB ~ 27°CDB Outdoor:-12°CWB ~ 15.5°CWB (-12°CWB~10°CWB with indoor unit 25 type only is working)

Note: 1.Cooling/heating capacity indicates the maximum value at operation under the following condition.

*1 **Cooling** Indoor : 27°CDB/19°CWB Outdoor : 35°CDB

Heating Indoor : 20°CDB Outdoor : 7°CDB/6°CWB

Pipe length : 7.5m Height difference : 0m

*2 **Cooling** Indoor : 27°CDB/19.5°CWB Outdoor : 35°CDB

Pipe length : 5m Height difference : 0m

* It is measured in anechoic room.

Big Y(R22)

2. Capacity Tables

2-1. Correction by temperature

Cooling

- Standard Specifications

		PUHY-400	PUHY-500
Capacity	kW	45.0	56.0
Input	kW	15.87	18.98

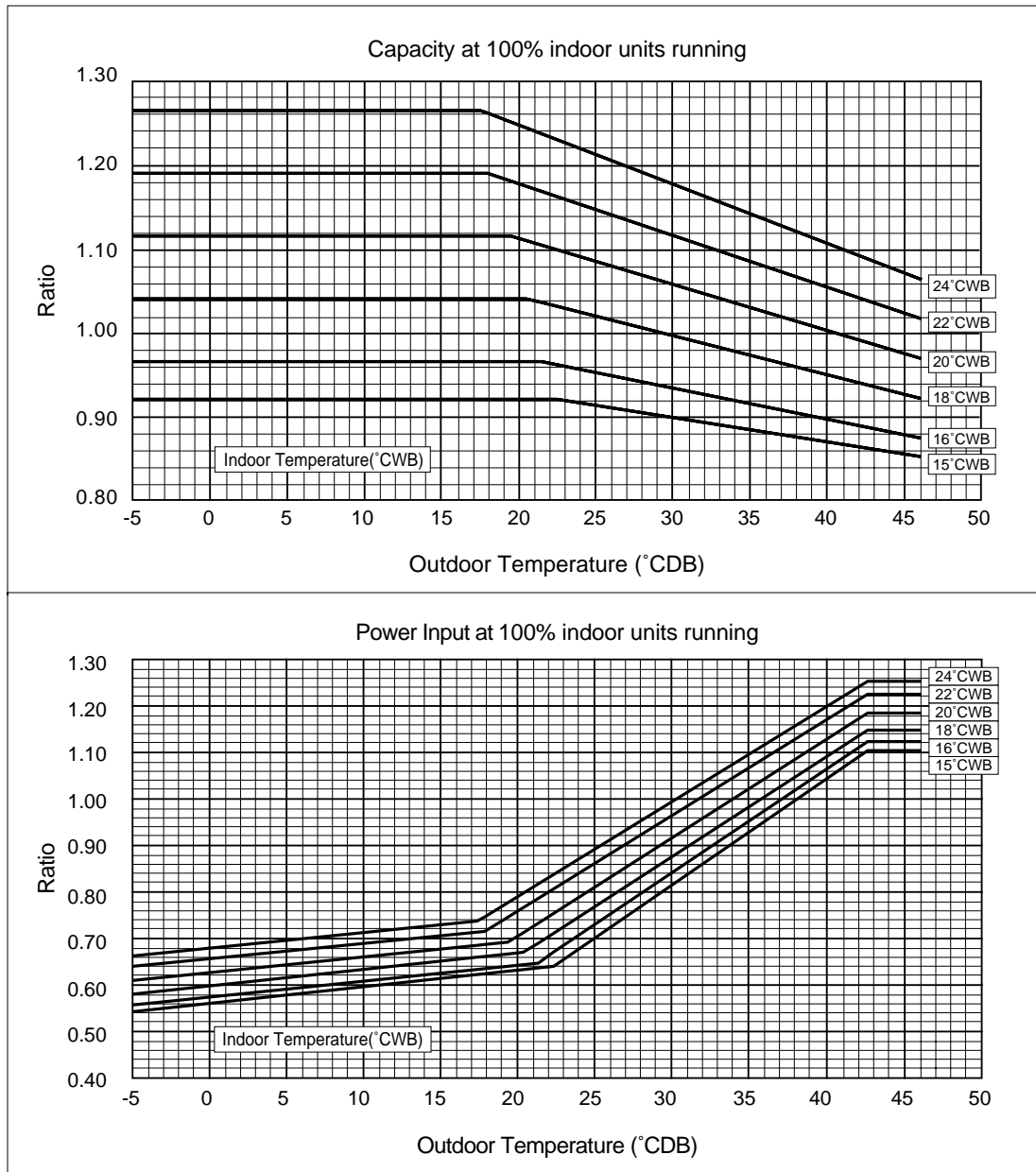

Big Y(R22)

Heating

• Standard Specifications

		PUHY-400	PUHY-500
Capacity	kW	50.0	63.0
Input	kW	14.31	17.92

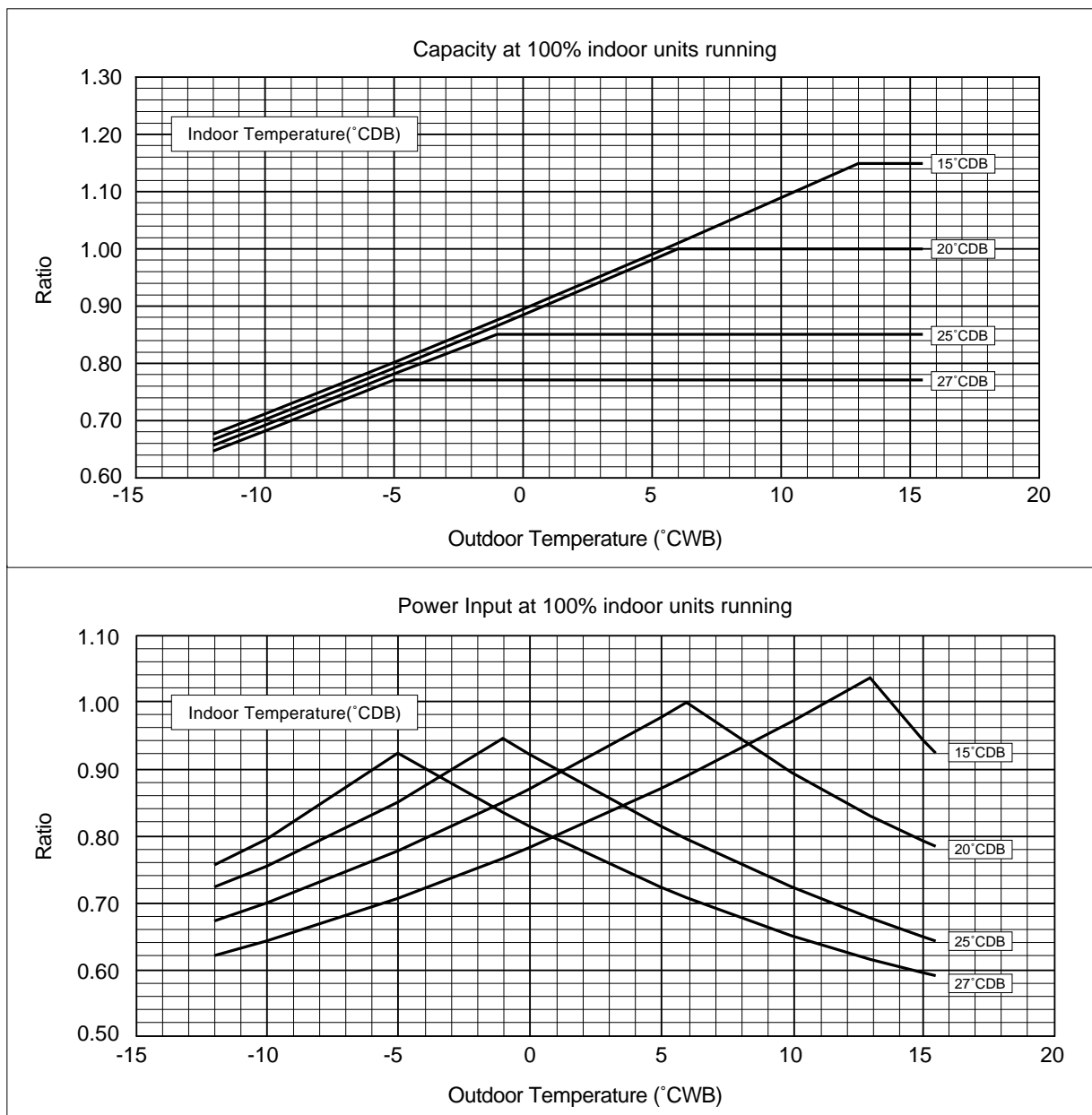

Big Y (R22)

2-2. Correction by total indoor

PUHY-400

1) Capacity

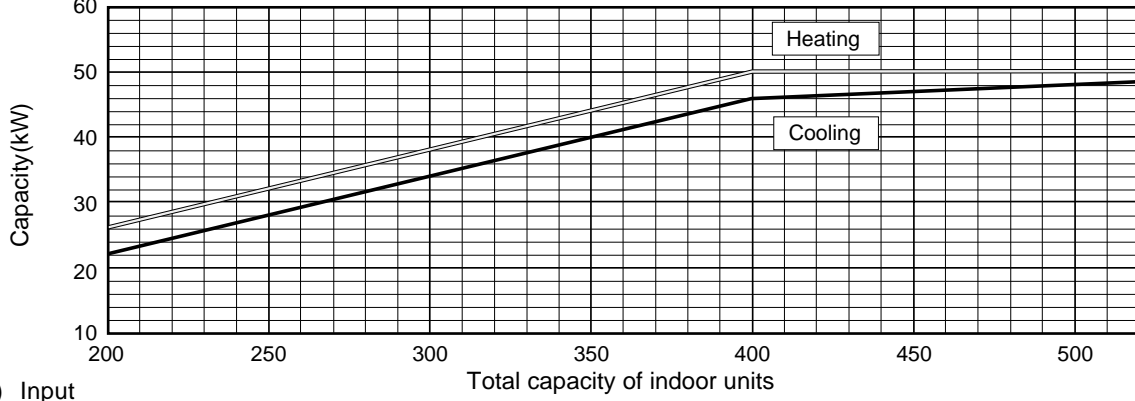

2) Input

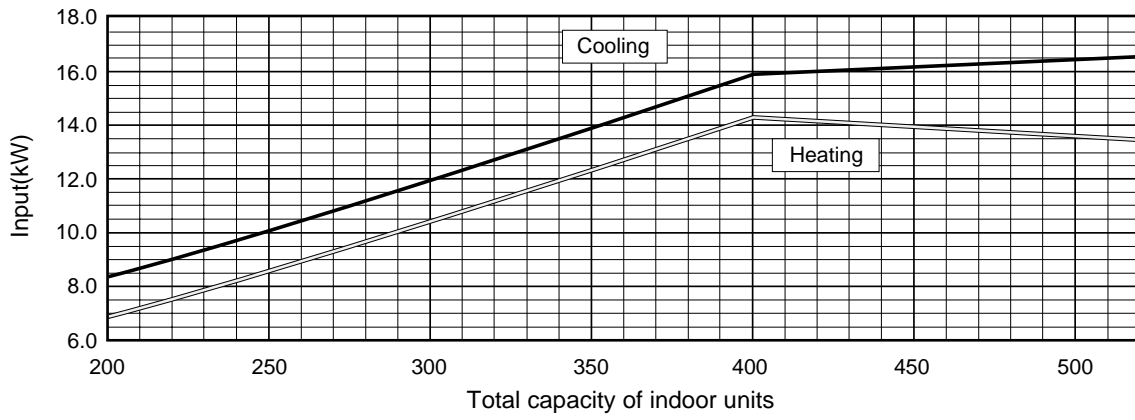

PUHY-500

1) Capacity

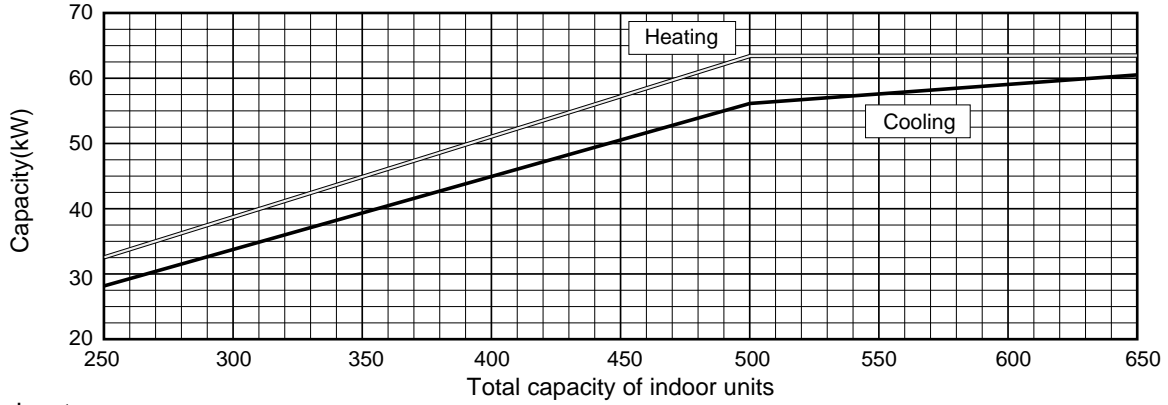

2) Input

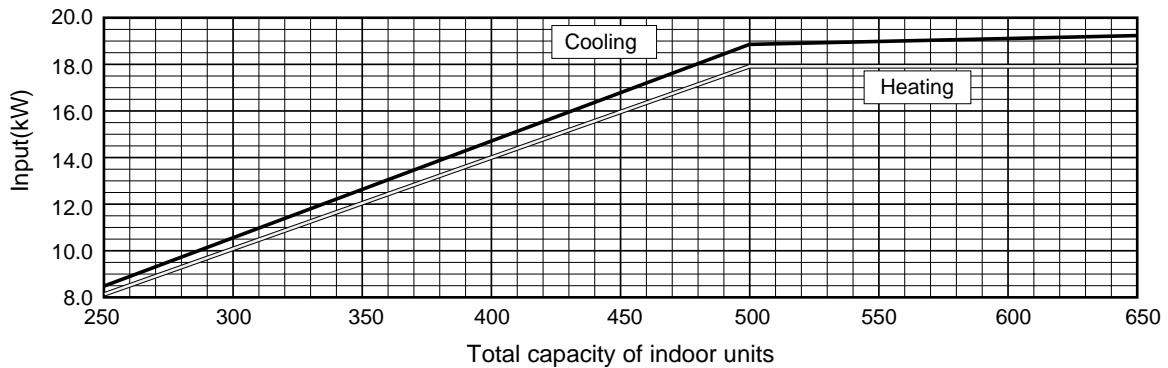

Big Y(R22)

2-3. Correction by refrigerant piping length

To obtain a decrease in cooling/heating capacity due to refrigerant piping extension, multiply by the capacity correction factor based on the refrigerant piping equivalent length in the table below.

• Cooling capacity correction

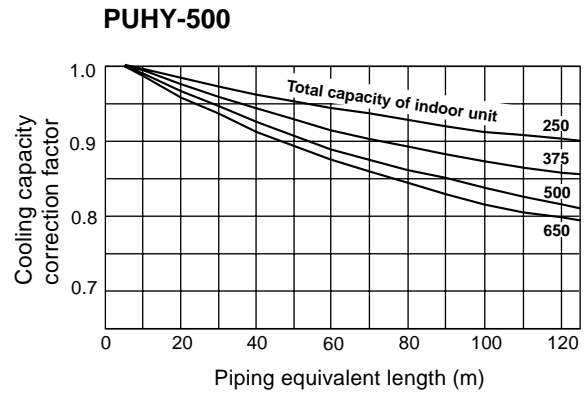
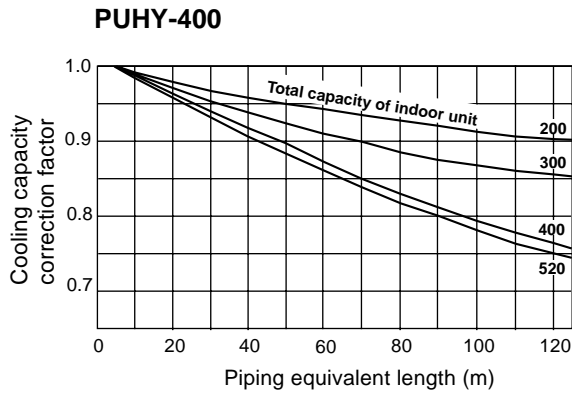

• Heating capacity correction

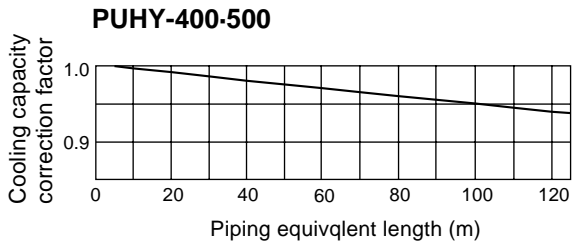

• How to obtain piping equivalent length

- ① **PUHY-400**
Equivalent length = (Actual piping length to the farthest indoor unit) + (0.70 × number of bent on the piping)m
- ② **PUHY-500**
Equivalent length = (Actual piping length to the farthest indoor unit) + (0.80 × number of bent on the piping)m

2-4. Correction at frosting and defrosting

When a decrease in heating capacity due to frosted and defrosting operations is considered, the value multiplied by the correction factor in the table below represents the heating capacity.

Correction factor table

Outdoor inlet air temp (°CWB)	6	4	2	0	-2	-4	-6	-8	-10
Correction factor	1.0	0.98	0.89	0.89	0.90	0.92	0.95	0.95	0.95

2-5. Operation limit

• Cooling

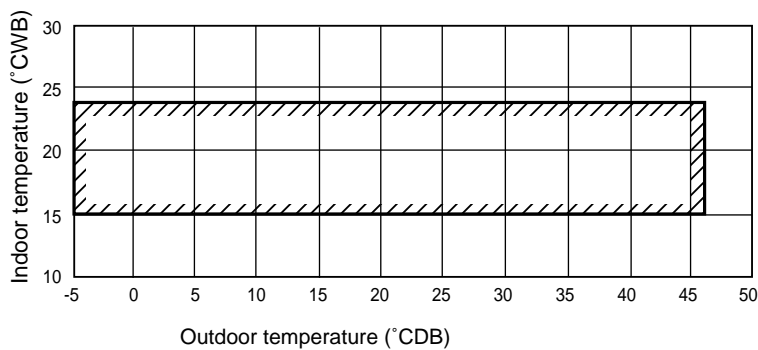

When the indoor unit is located above the outdoor unit for 4m or more, the outdoor unit inlet air temperature becomes 10~46°CDB.

• Heating

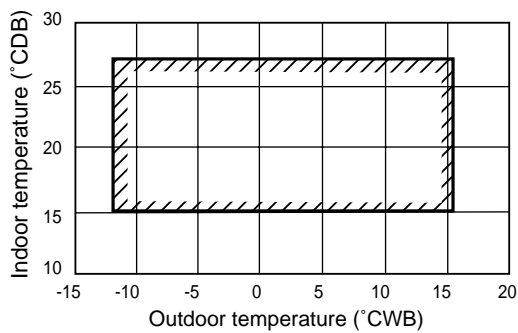

When the indoor unit 25type only is working, the outdoor unit inlet air temperature becomes -12~10°CWB.

3. Sound Levels

PUHY-400

Measurement condition

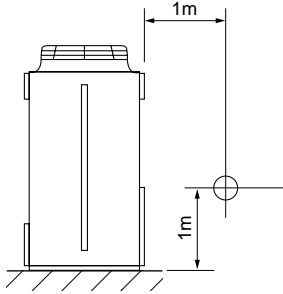

Sound pressure level in anechoic room

60 / 61 dB (A)

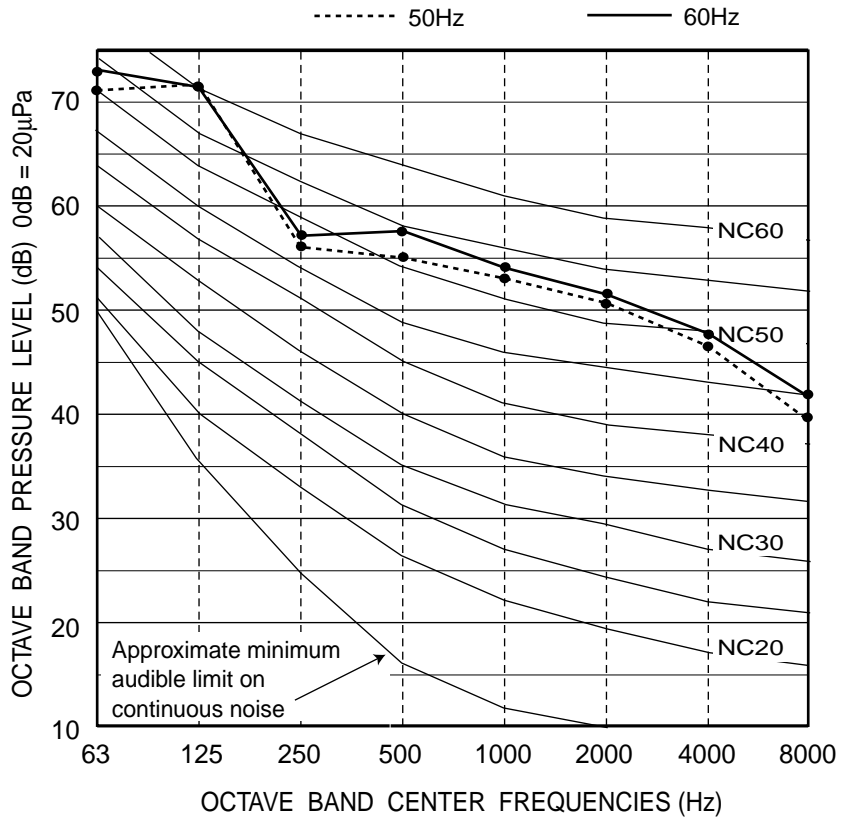

PUHY-500

Measurement condition

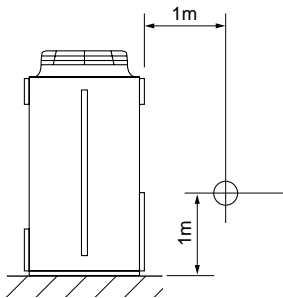

Sound pressure level in anechoic room

60 / 61 dB (A)

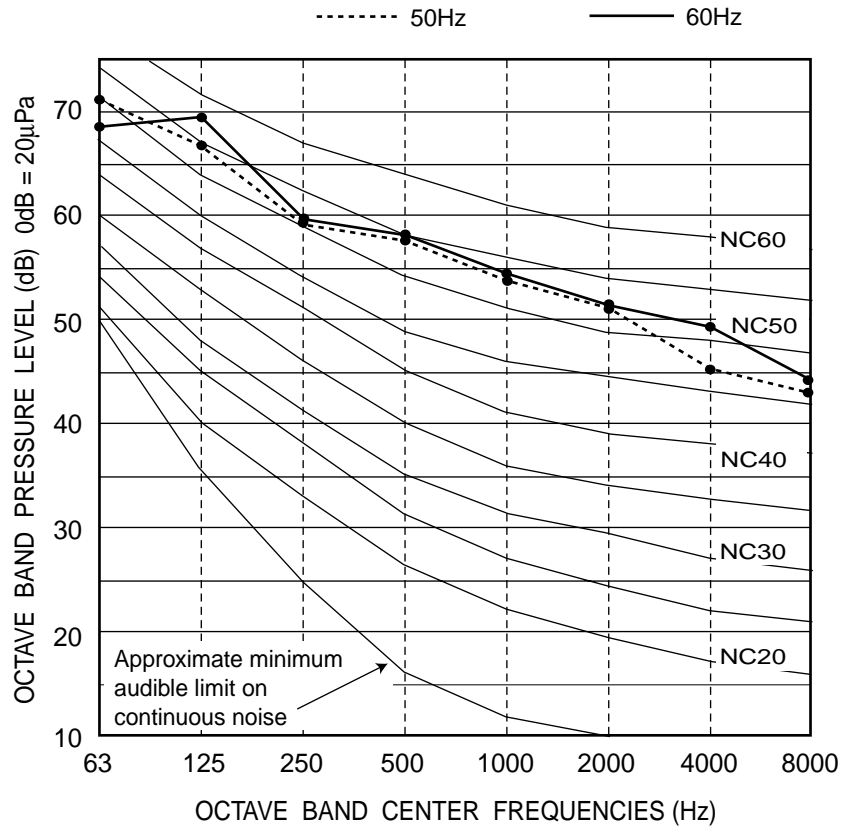

Big Y (R22)

4. External Dimensions

PUHY-400,500YEM(K,C)-A(-BF, BS)

Unit : mm

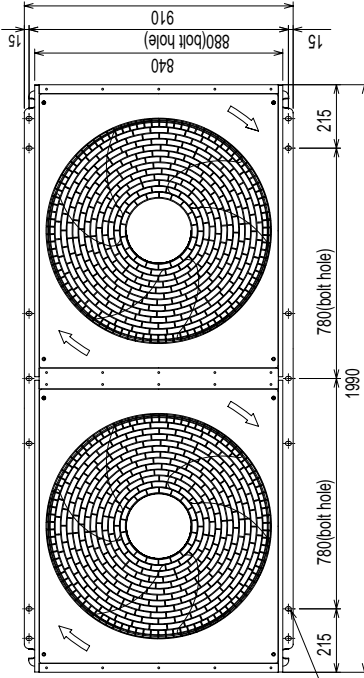

Plane view

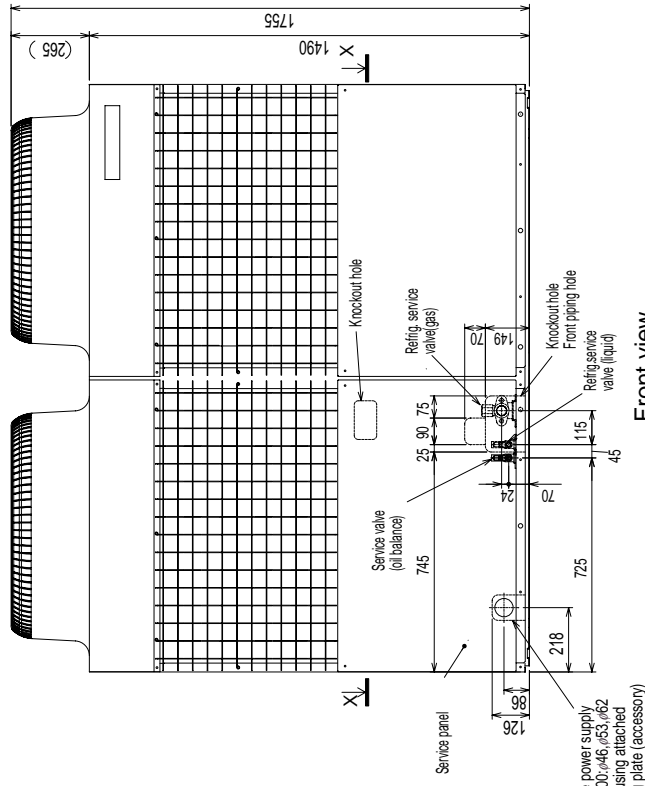

Front view

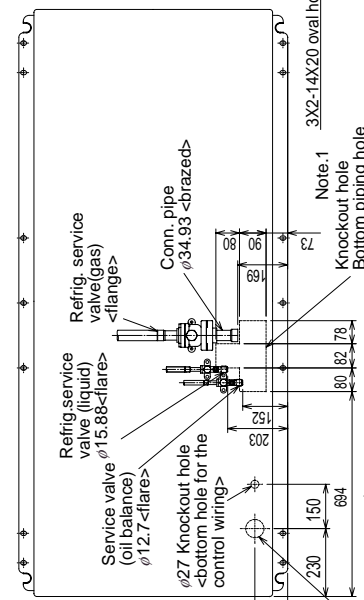

Cross section X-X

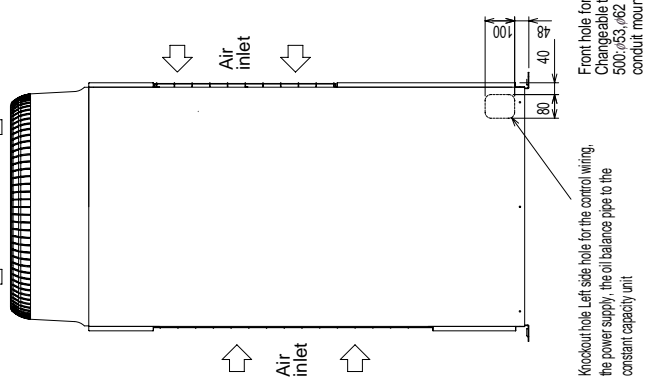

Left side view

- <Accessories>
- Refrigerant (gas) conn. pipe 1pc.
(The connecting pipe has been fixed with the unit)
 - Packing for conn. pipe 1pc.
(Attached near the ball valve)
 - Conduit mounting plate
(Painted the same color as the unit body)
 - Tapping screw 4X10 4pcs.
 - Wiring partition plate 1pc.
- Note1. Please leave a space under the outdoor unit for the piping when you connect the piping from the bottom.
(Please be careful not to close the hole of the bottom plate by the basement)

Bottom hole for the power supply
Changeable to $\phi 40, \phi 46, \phi 53, \phi 62$
500, $\phi 53, \phi 62$ by using attached
conduit mounting plate (accessory)

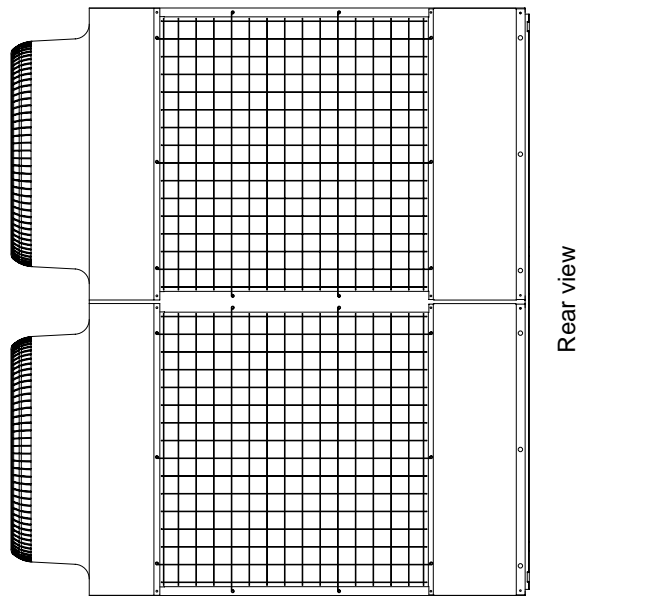

Rear view

Big Y(R22)

5. Electrical Wiring Diagram

PUHY-400-500YEM(K,C)-A(-BF, -BS)

<Symbol explanation>

Symbol	Name	Symbol	Name
DCL	DC reactor (Power factor improvement)	TH11.12	Thermistor
ACCT-UJW	Current Sensor	TH2	Thermistor
ZNR4	Varistor	TH3	Thermistor
52C1	Magnetic contactor (Inverter main circuit)	TH4	Thermistor
52C2	Magnetic contactor (Fan motor)	TH5	Thermistor
52F	Overload relay	TH6	Thermistor
MF1	Fan motor (Radiator panel)	TH7	Thermistor
SV1.22.32.4.6	4-way valve	TH8	Thermistor
SV5.6.7.8	Solenoid valve (Heat exchanger capacity control)	TH9a	Thermistor
SLEV	Electronic expansion valve(Oil return)	TH10a	Thermistor
LEV1	Electronic expansion valve(SC coil)	TH10b	Thermistor
63HS	High pressure sensor	THHS	Thermistor
63LS	Low pressure sensor	LD	Accumulator liquid level detect
L2	Choke coil(Transmission)	CH11.12	Crank case heater(Compressor)
IPM	Intelligent power module	CH2.3	Cord heater
T1-10	Terminal	SSR	Solid state relay
		FB1-5	Ferrite core
			Earth terminal

<Difference of appliance>

Appliance	Name
PUHY-400YEM	1, 2, 3, 4, 5, 6, 7, 8, 9, 10, 11, 12, 13, 14, 15, 16, 17, 18, 19, 20, 21, 22, 23, 24, 25, 26, 27, 28, 29, 30, 31, 32, 33, 34, 35, 36, 37, 38, 39, 40, 41, 42, 43, 44, 45, 46, 47, 48, 49, 50, 51, 52, 53, 54, 55, 56, 57, 58, 59, 60, 61, 62, 63, 64, 65, 66, 67, 68, 69, 70, 71, 72, 73, 74, 75, 76, 77, 78, 79, 80, 81, 82, 83, 84, 85, 86, 87, 88, 89, 90, 91, 92, 93, 94, 95, 96, 97, 98, 99, 100
PUHY-500YEM	1, 2, 3, 4, 5, 6, 7, 8, 9, 10, 11, 12, 13, 14, 15, 16, 17, 18, 19, 20, 21, 22, 23, 24, 25, 26, 27, 28, 29, 30, 31, 32, 33, 34, 35, 36, 37, 38, 39, 40, 41, 42, 43, 44, 45, 46, 47, 48, 49, 50, 51, 52, 53, 54, 55, 56, 57, 58, 59, 60, 61, 62, 63, 64, 65, 66, 67, 68, 69, 70, 71, 72, 73, 74, 75, 76, 77, 78, 79, 80, 81, 82, 83, 84, 85, 86, 87, 88, 89, 90, 91, 92, 93, 94, 95, 96, 97, 98, 99, 100
PUHY-500YEM	1, 2, 3, 4, 5, 6, 7, 8, 9, 10, 11, 12, 13, 14, 15, 16, 17, 18, 19, 20, 21, 22, 23, 24, 25, 26, 27, 28, 29, 30, 31, 32, 33, 34, 35, 36, 37, 38, 39, 40, 41, 42, 43, 44, 45, 46, 47, 48, 49, 50, 51, 52, 53, 54, 55, 56, 57, 58, 59, 60, 61, 62, 63, 64, 65, 66, 67, 68, 69, 70, 71, 72, 73, 74, 75, 76, 77, 78, 79, 80, 81, 82, 83, 84, 85, 86, 87, 88, 89, 90, 91, 92, 93, 94, 95, 96, 97, 98, 99, 100

NOTE: Mark ○ indicates terminal bed
 □ connector
 ⊠ board location connector

<Unit internal layout>

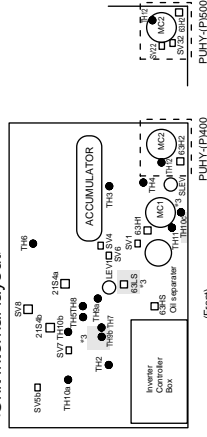

<Controller box internal layout>

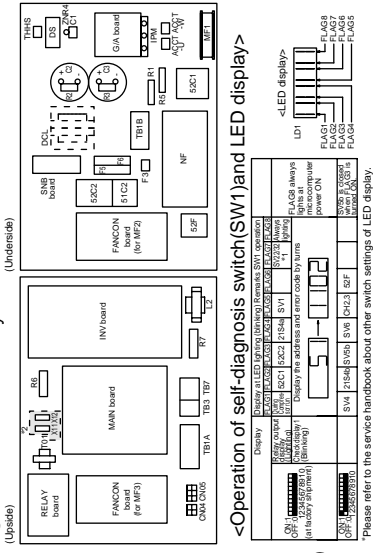

<ELECTRICAL WIRING DIAGRAM>

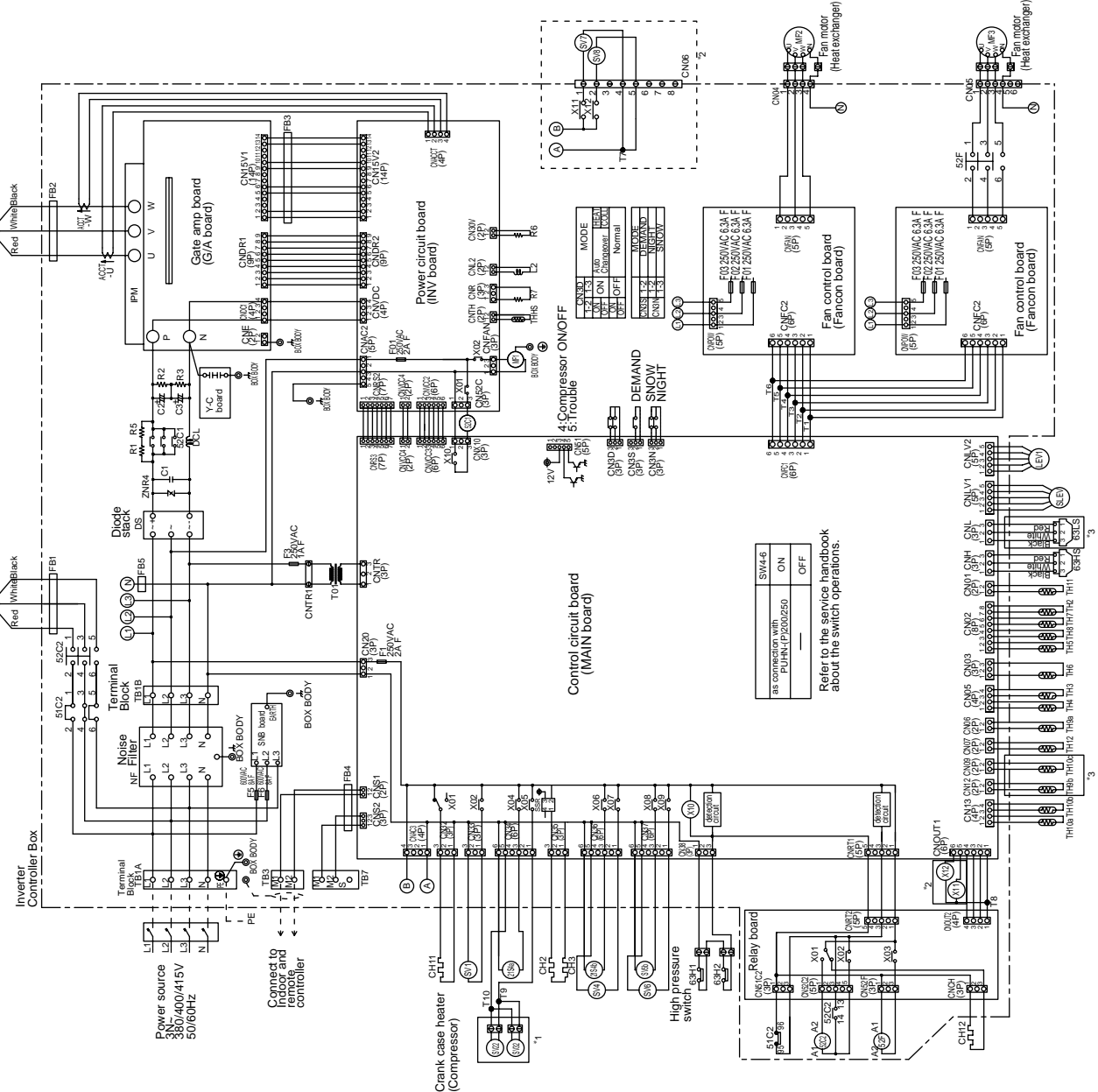

Big Y(R22)

6. Refrigerant Circuit Diagram And Thermal Sensor

* There are SV22,SV32 only for PUHY-500YEM(K,C)-A.

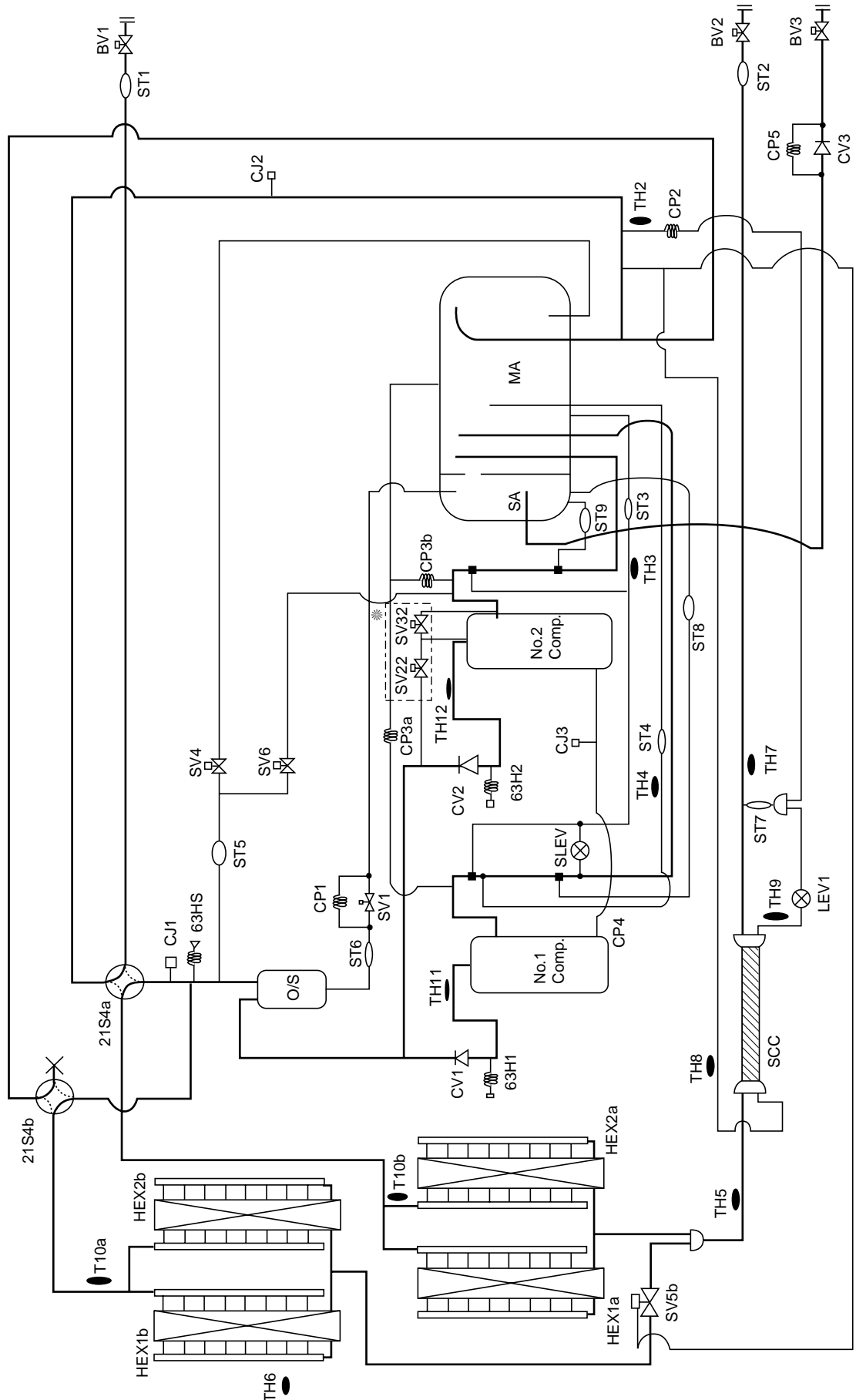

Big Y(R22)

PUHY-600-650-700-750YSEM-A (-BF, -BS)
PUHY-600-650-700-750YSEMK-A
PUHY-600-650-700-750YSEMC-A(-BS)

CONTENTS

1. Specifications	I -226
2. Capacity Tables	I -230
2-1 Correction by temperature	I -230
2-2 Correction by total indoor	I -232
2-3 Correction by refrigerant piping length	I -234
2-4 Correction at frosting and defrosting	I -235
2-5 Operation limit	I -235
3. Sound Levels	I -236
4. External Dimensions	I -238
5. Electrical Wiring Diagram	I -241
6. Refrigerant Circuit Diagram	I -243
And Thermal Sensor	

1. Specifications

This unit consists of a combination of PUHY-400 and PUHN-200.

Model name		PUHY-600YSEM-A(-BF, -BS) PUHY-600YSEMK-A PUHY-600YSEMC-A(-BS)	
		Cooling	Heating
Capacity	*1	kW	67.4
	*2	kcal/h	60,000
Power source		3N ~ 380/400/415V 50/60Hz	
Power input		kW	23.23
Current		A	39.2/37.2/35.9
Refrigerant / Lubricant		R22/MS32(N-1)	
External finish		Pre-coated galvanized sheets(Powder coating) <MUNSELL 5Y8/1 or similar>	
Indoor unit	Total capacity		50 ~ 130% of outdoor unit capacity
	Model / Quantity		Model 20 ~ 250 / 2 ~ 32
Noise level	*	dB<A> (50/60Hz)	61.5 / 62.0
Refrigerant piping diameter (main)		Liquid / Gas	φ 19.05 / φ34.93
Operating temperature range		Indoor:15°CWB ~ 24°CWB Outdoor:-5°CDB ~ 46°CDB (10°CDB~46°CDB with outdoor unit at lower position)	Indoor:15°CDB ~ 27°CDB Outdoor:-15°CWB ~ 15.5°CWB (-12°CWB~10°CWB with indoor unit 20 or 25 type only is working)

Model name		PUHY-400YEM-A(-BF, -BS) PUHY-400YEMK-A PUHY-400YEMC-A(-BS)		PUHN-200YEM-A(-BF, -BS) PUHN-200YEMK-A PUHN-200YEMC-A(-BS)			
Fan	TypeX Quantity		Propeller fan X 2		Propeller fan X 1		
	Airflow rate		m ³ /min	400	200		
	Motor output		kW	0.38 X 2	0.38 X 1		
Compressor	Type		Hermetic				
	Motor output		kW	7.5 + 4.5		5.5	
	Crankcase heater		kW	0.045 + 0.045		0.056	
External dimension			mm	1755(H)X 1990(W) X 840(L)		1755(H)X 990(W) X 840(L)	
Protection devices	High pressure protection		2.94MPa				
	Compressor / Fan		Overcurrent protection / Thermal switch				
	Inverter		AC bus current protection, thermal switch		—		
Refrigerant piping diameter			Liquid / Gas	φ15.88 (Flare) / φ 34.93 (Flange)		φ 12.7 (Flare) / φ 28.58 (Flange)	
Net weight			kg	432		248	

Note: 1.Cooling/heating capacity indicates the maximum value at operation under the following condition.

*1 Cooling	Indoor : 27°CDB/19°CWB	Outdoor : 35°CDB	*2 Cooling	Indoor : 27°CDB/19.5°CWB	Outdoor : 35°CDB
Heating	Indoor : 20°CDB	Outdoor : 7°CDB/6°CWB		Pipe length : 10m	Height difference : 0m
	Pipe length : 12.5m	Height difference : 0m			

* It is measured in anechoic room.

This unit consists of a combination of PUHY-400 and PUHN-250.

Model name		PUHY-650YSEM(-BF, -BS) PUHY-650YSEMK-A PUHY-650YSEMC-A(-BS)	
		Cooling	Heating
Capacity	*1	kW	73.0
	*2	kcal/h	65,000
Power source		3N ~ 380/400/415V 50/60Hz	
Power input		kW	25.06
Current		A	42.2/40.1/38.7
Refrigerant / Lubricant		R22/MS32(N-1)	
External finish		Pre-coated galvanized sheets(Powder coating) <MUNSELL 5Y8/1 or similar>	
Indoor unit	Total capacity		50 ~ 130% of outdoor unit capacity
	Model / Quantity		Model 20 ~ 250 / 2 ~ 32
Noise level	*	dB<A> (50/60Hz)	62.0 / 62.5
Refrigerant piping diameter (main)		Liquid / Gas	φ 19.05 / φ 41.28
Operating temperature range		Indoor:15°CWB ~ 24°CWB Outdoor:-5°CDB ~ 46°CDB (10°CDB~46°CDB with outdoor unit at lower position)	Indoor:15°CDB ~ 27°CDB Outdoor:-15°CWB ~ 15.5°CWB (-12°CWB~10°CWB with indoor unit 20 or 25 type only is working)

Model name		PUHY-400YEM(-BF, -BS) PUHY-400YEMK-A PUHY-400YEMC-A(-BS)		PUHN-250YEM(-BF, -BS) PUHN-250YEMK-A PUHN-250YEMC-A(-BS)		
Fan	TypeX Quantity		Propeller fan X 2		Propeller fan X 1	
	Airflow rate	m³/min	400		200	
	Motor output	kW	0.38 X 2		0.38 X 1	
Compressor	Type		Hermetic			
	Motor output	kW	7.5 + 4.5		7.5	
	Crankcase heater	kW	0.045 + 0.045		0.056	
External dimension		mm	1755(H)X 1990(W) X 840(L)		1755(H)X 990(W) X 840(L)	
Protection devices	High pressure protection		2.94MPa			
	Compressor / Fan		Overcurrent protection / Thermal switch			
	Inverter		AC bus current protection, thermal switch		—	
Refrigerant piping diameter		Liquid / Gas	φ 15.88 (Flare) / φ 34.93 (Flange)		φ 12.7 (Flare) / φ 28.58 (Flange)	
Net weight		kg	432		263	

Note: 1.Cooling/heating capacity indicates the maximum value at operation under the following condition.

*1 **Cooling** Indoor : 27°CDB/19°CWB Outdoor : 35°CDB

*2 **Cooling** Indoor : 27°CDB/19.5°CWB Outdoor : 35°CDB

Heating Indoor : 20°CDB Outdoor : 7°CDB/6°CWB

Pipe length : 10m Height difference : 0m

Pipe length : 12.5m Height difference : 0m

* It is measured in anechoic room.

Super V(R22)

This unit consists of a combination of PUHY-500 and PUHN-200.

Model name			PUHY-700YSEM-A(-BF,-BS) PUHY-700YSEM-K-A PUHY-700YSEMC-A(-BS)	
			Cooling	Heating
Capacity	*1	kW	78.4	88.0
	*2	kcal/h	70,000	—
Power source			3N ~ 380/400/415V 50/60Hz	
Power input		kW	26.87	24.60
Current		A	45.3/43.0/41.5	41.5/39.4/38.0
Refrigerant / Lubricant			R22/MS32(N-1)	
External finish			Pre-coated galvanized sheets(Powder coating) <MUNSELL 5Y8/1 or similar>	
Indoor unit	Total capacity		50 ~ 130% of outdoor unit capacity	
	Model / Quantity		Model 20 ~ 250 / 2 ~ 32	
Noise level	*	dB<A> (50/60Hz)	61.5 / 62.0	
Refrigerant piping diameter (main)		Liquid / Gas	φ 19.05 / φ 41.28	
Operating temperature range			Indoor:15°CWB ~ 24°CWB Outdoor:-5°CDB ~ 46°CDB (10°CDB~46°CDB with outdoor unit at lower position)	Indoor:15°CDB ~ 27°CDB Outdoor:-15°CWB ~ 15.5°CWB (-12°CWB~10°CWB with indoor unit 20 or 25 type only is working)

Model name			PUHY-500YEM-A(-BF,-BS) PUHY-500YEM-K-A PUHY-500YEMC-A(-BS)	PUHN-200YEM-A(-BF,-BS) PUHN-200YEM-K-A PUHN-200YEMC-A(-BS)
Fan	TypeX Quantity		Propeller fan X 2	Propeller fan X 1
	Airflow rate	m ³ /min	400	200
	Motor output	kW	0.38 X 2	0.38 X 1
Compressor	Type		Hermetic	
	Motor output	kW	7.5 + 7.5	5.5
	Crankcase heater	kW	0.045 + 0.056	0.056
External dimension		mm	1755(H)X 1990(W)X 840(L)	1755(H)X 990(W)X 840(L)
Protection devices	High pressure protection		2.94MPa	
	Compressor / Fan		Overcurrent protection / Thermal switch	
	Inverter		AC bus current protection, thermal switch	—
Refrigerant piping diameter		Liquid / Gas	φ 15.88 (Flare) / φ 34.93 (Flange)	φ 12.7 (Flare) / φ 28.58 (Flange)
Net weight		kg	472	248

Note: 1.Cooling/heating capacity indicates the maximum value at operation under the following condition.

*1 **Cooling** Indoor : 27°CDB/19°CWB Outdoor : 35°CDB

*2 **Cooling** Indoor : 27°CDB/19.5°CWB Outdoor : 35°CDB

Heating Indoor : 20°CDB Outdoor : 7°CDB/6°CWB

Pipe length : 10m Height difference : 0m

Pipe length : 12.5m Height difference : 0m

* It is measured in anechoic room.

This unit consists of a combination of PUHY-500 and PUHN-250.

Model name			PUHY-750YSEM-A(-BF, -BS) PUHY-750YSEMK-A PUHY-750YSEMC-A(-BS)	
			Cooling	Heating
Capacity	*1	kW	84.0	94.5
	*2	kcal/h	75,000	—
Power source			3N ~ 380/400/415V 50/60Hz	
Power input		kW	28.69	26.55
Current		A	48.4/46.0/44.3	44.8/42.5/41.0
Refrigerant / Lubricant			R22/MS32(N-1)	
External finish			Pre-coated galvanized sheets(Powder coating) <MUNSELL 5Y8/1 or similar>	
Indoor unit	Total capacity		50 ~ 130% of outdoor unit capacity	
	Model / Quantity		Model 20 ~ 250 / 2 ~ 32	
Noise level	*	dB<A> (50/60Hz)	62.0 / 62.5	
Refrigerant piping diameter (main)		Liquid / Gas	φ 19.05 / φ 41.28	
Operating temperature range			Indoor:15°CWB ~ 24°CWB Outdoor:-5°CDB ~ 46°CDB (10°CDB~46°CDB with outdoor unit at lower position)	Indoor:15°CDB ~ 27°CDB Outdoor:-15°CWB ~ 15.5°CWB (-12°CWB~10°CWB with indoor unit 20 or 25 type only is working)

			PUHY-500YEM-A(-BF, -BS) PUHY-500YEMK-A PUHY-500YEMC-A(-BS)	PUHN-200YEM-A(-BF, -BS) PUHN-250YEMK-A PUHN-250YEMC-A(-BS)
Fan	TypeX Quantity		Propeller fan X 2	Propeller fan X 1
	Airflow rate	m³/min	400	200
	Motor output	kW	0.38 X 2	0.38 X 1
Compressor	Type		Hermetic	
	Motor output	kW	7.5 + 7.5	7.5
	Crankcase heater	kW	0.045 + 0.056	0.056
External dimension		mm	1755(H)X 1990(W)X 840(L)	1755(H)X 990(W)X 840(L)
Protection devices	High pressure protection		2.94MPa	
	Compressor / Fan		Overcurrent protection / Thermal switch	
	Inverter		AC bus current protection, thermal switch	—
Refrigerant piping diameter		Liquid / Gas	φ 15.88 (Flare) / φ 34.93 (Flange)	φ 12.7 (Flare) / φ 28.58 (Flange)
Net weight		kg	472	263

Note: 1.Cooling/heating capacity indicates the maximum value at operation under the following condition.

*1 **Cooling** Indoor : 27°CDB/19°CWB Outdoor : 35°CDB *2 **Cooling** Indoor : 27°CDB/19.5°CWB Outdoor : 35°CDB
Heating Indoor : 20°CDB Outdoor : 7°CDB/6°CWB Pipe length : 10m Height difference : 0m
Pipe length : 12.5m Height difference : 0m

* It is measured in anechoic room.

Super V(R22)

2. Capacity Tables

2-1. Correction by temperature

Cooling

- Standard Specifications (Outdoor 35°CDB/ - Indoor 27°CDB/19°CWB)

		PUHY-600	PUHY-650	PUHY-700	PUHY-750
Capacity	kW	67.4	73.0	78.4	84.0
Input	kW	23.23	25.06	26.87	28.69

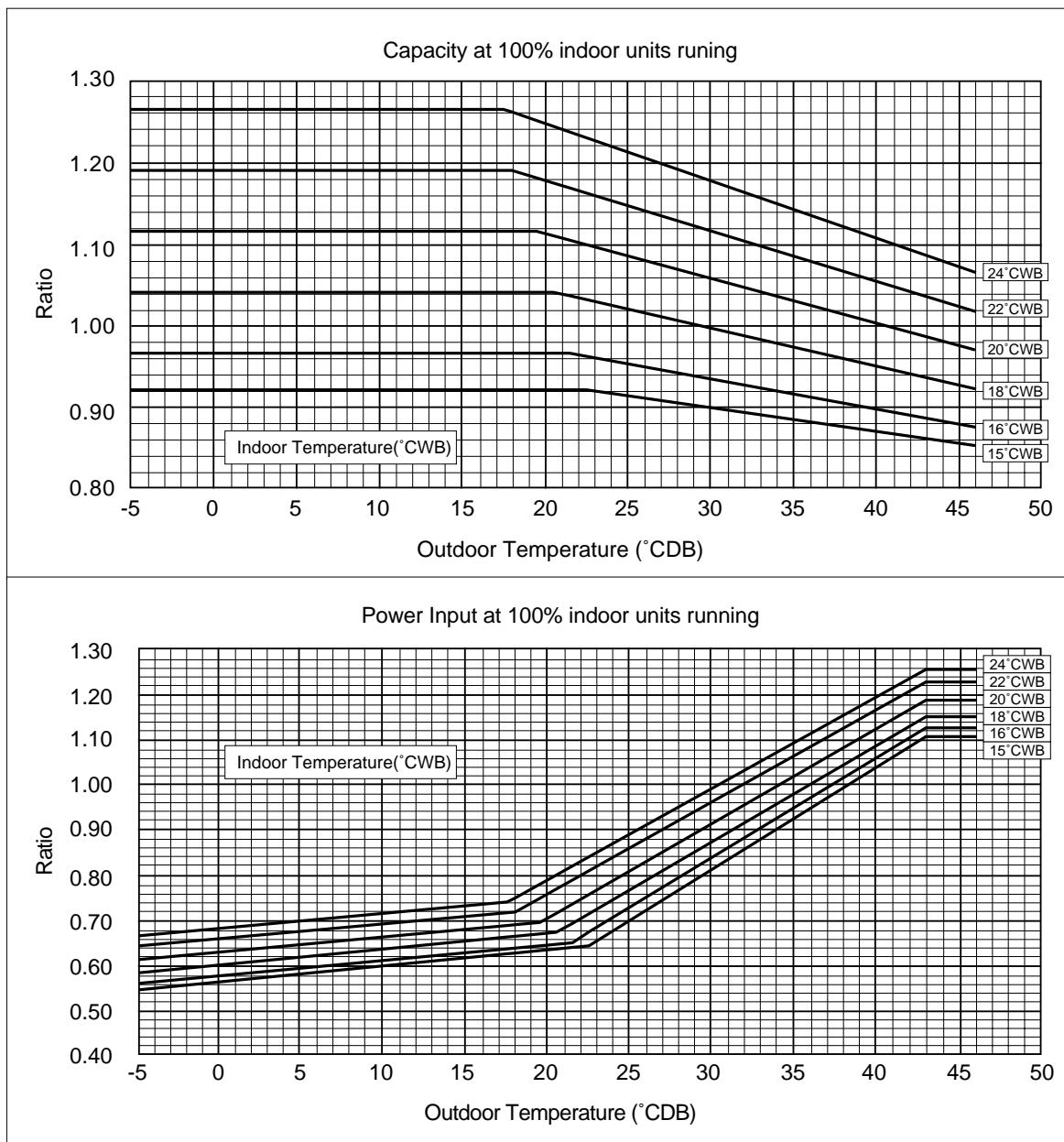

Super Y (R22)

Heating

- Standard Specifications (Outdoor 7°CDB/6°CWB Indoor 20°CDB/ -)

	PUHY-600	PUHY-650	PUHY-700	PUHY-750
Capacity kW	75.0	81.5	88.0	94.5
Input kW	20.80	22.76	24.60	26.55

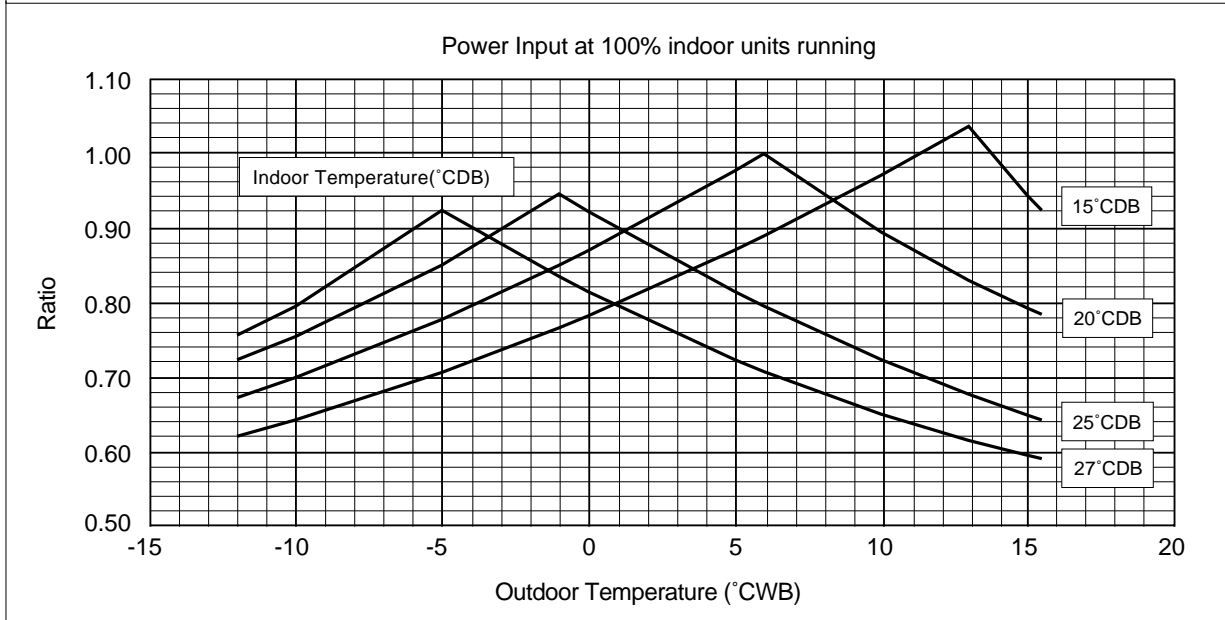
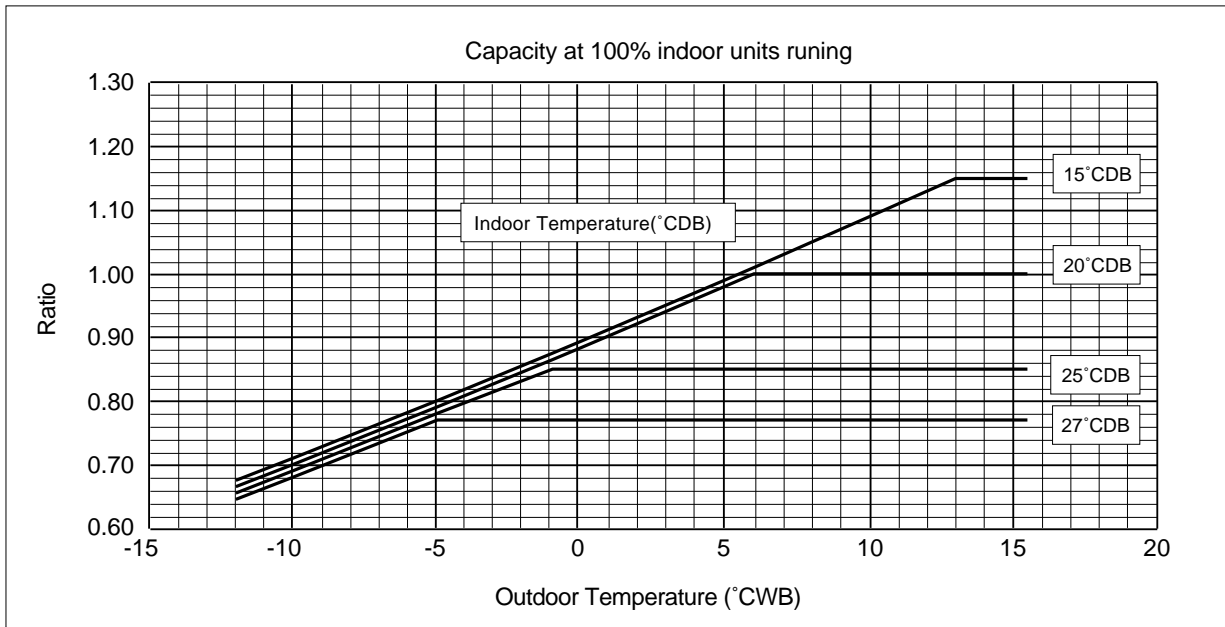

Super V(R22)

2-2. Correction by total indoor

PUHY-600

1) Capacity

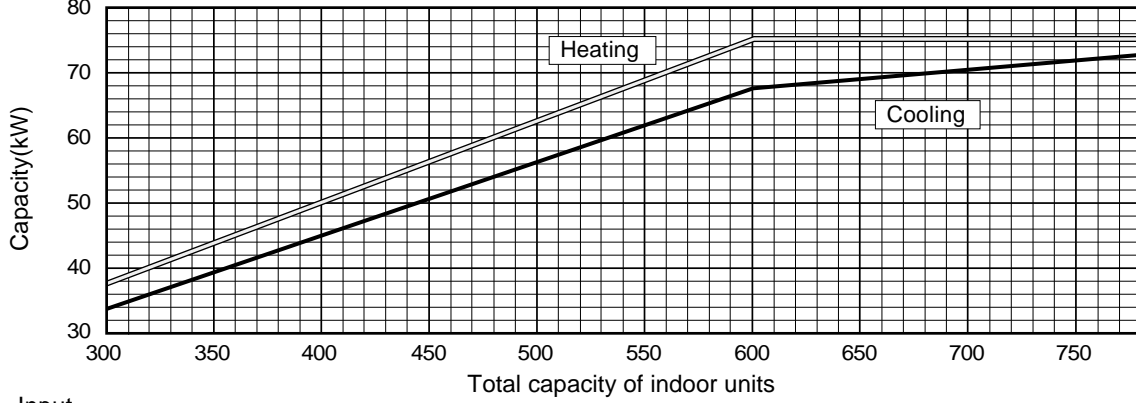

2) Input

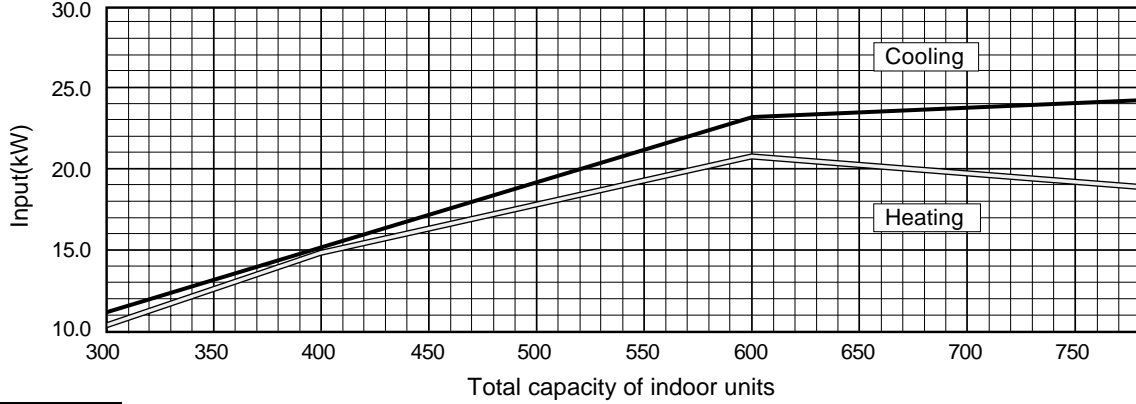

PUHY-650

1) Capacity

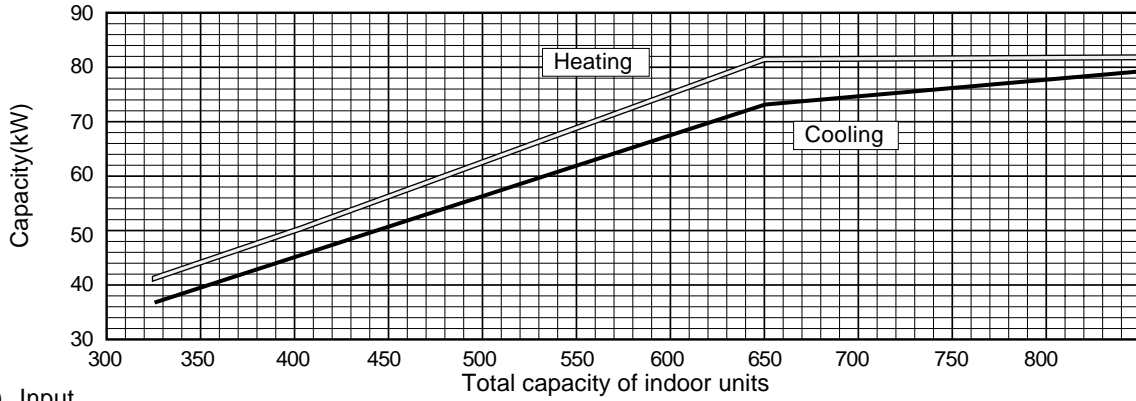

2) Input

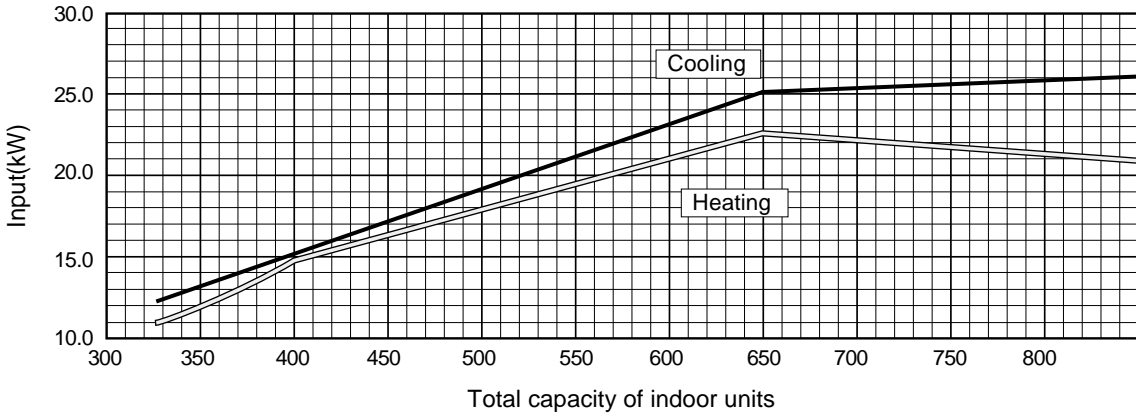

PUHY-700

1) Capacity

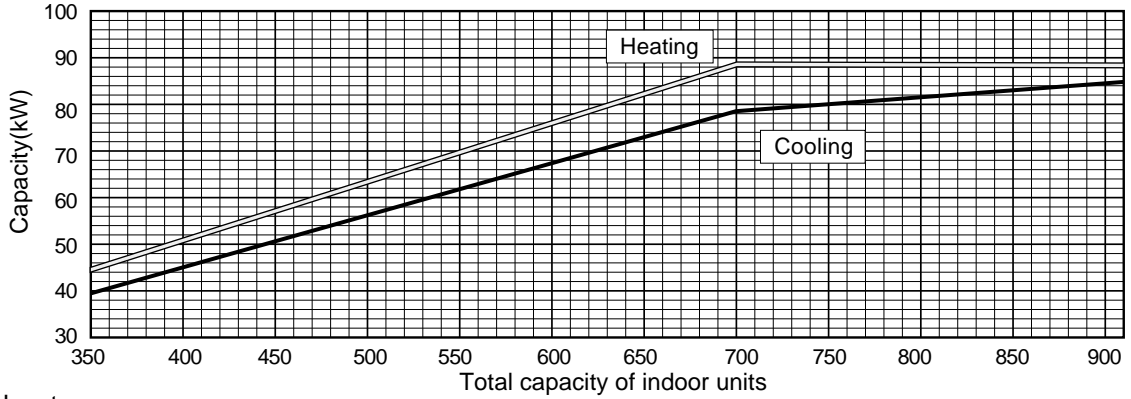

2) Input

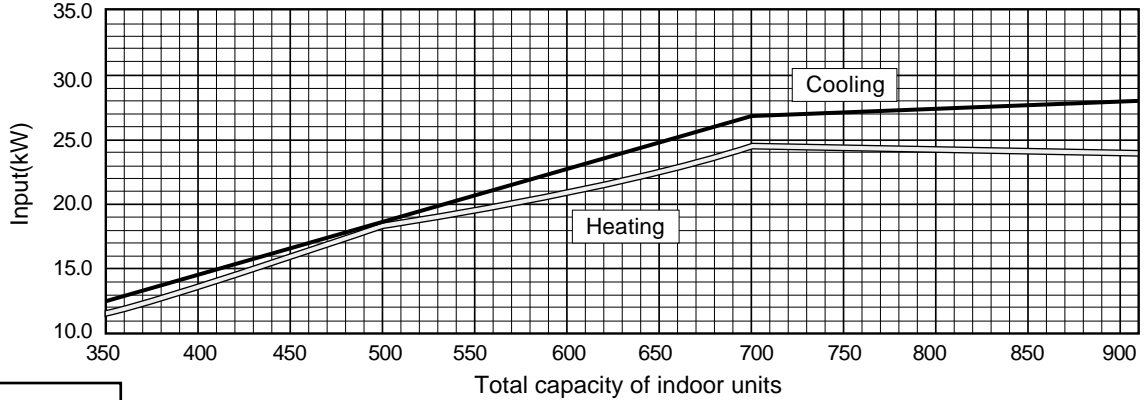

PUHY-750

1) Capacity

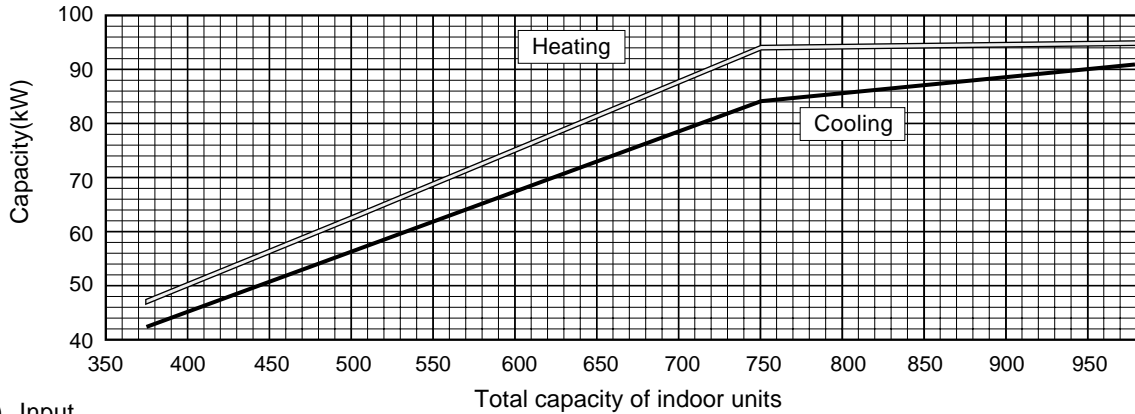

2) Input

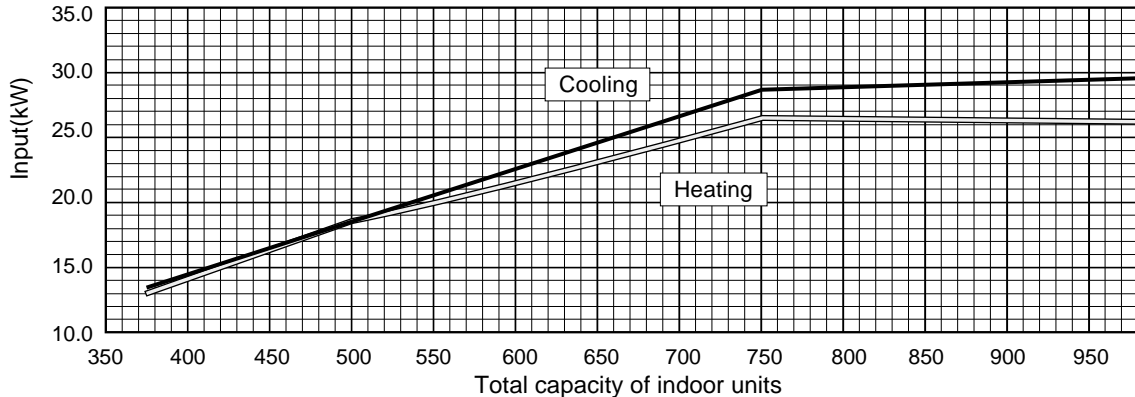

Super V(R22)

2-3. Correction by refrigerant piping length

To obtain a decrease in cooling/heating capacity due to refrigerant piping extension, multiply by the capacity correction factor based on the refrigerant piping equivalent length in the table below.

• Cooling capacity correction

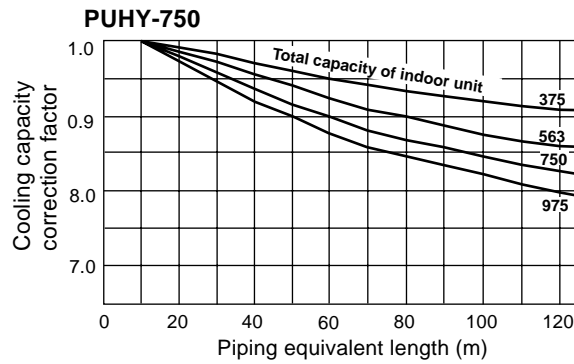
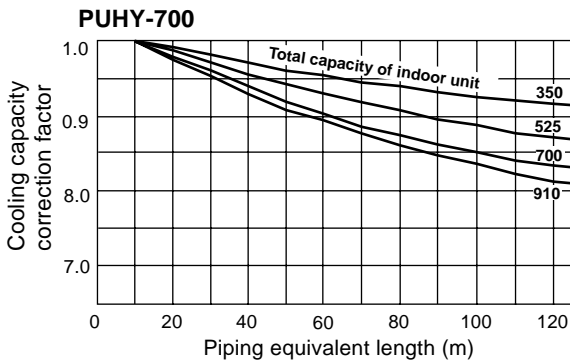
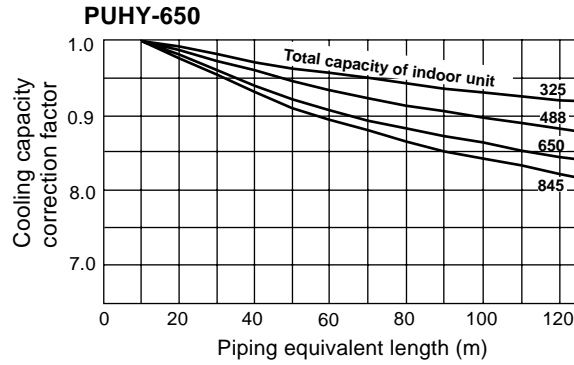
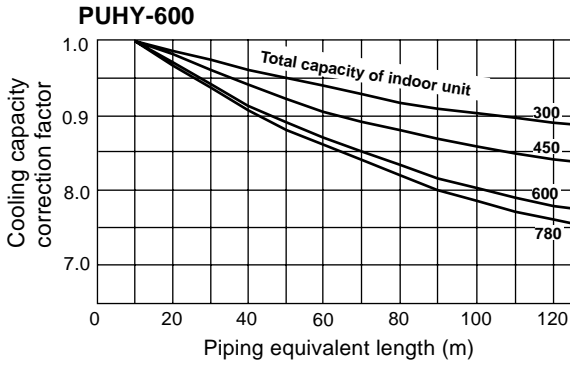

• Heating capacity correction

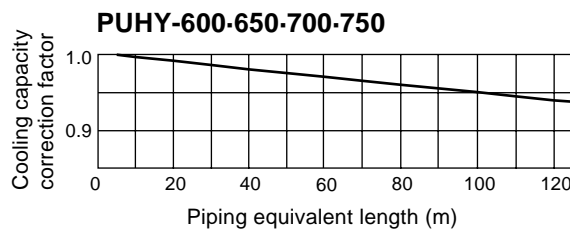

• How to obtain piping equivalent length

① PUHY-600

Equivalent length = (Actual piping length to the farthest indoor unit) + (0.80 × number of bent on the piping)m

② PUHY-650~750

Equivalent length = (Actual piping length to the farthest indoor unit) + (0.95 × number of bent on the piping)m

2-4 Correction at frosting and defrosting

When a decrease in heating capacity due to frosted and defrosting operations is considered, the value multiplied by the correction factor in the table below represents the heating capacity.

Outdoor inlet air temp (°CWB)	6	4	2	0	-2	-4	-6	-8	-10
Correction factor	1.0	0.98	0.89	0.89	0.90	0.92	0.95	0.95	0.95

2-5 Operation limit

• Cooling

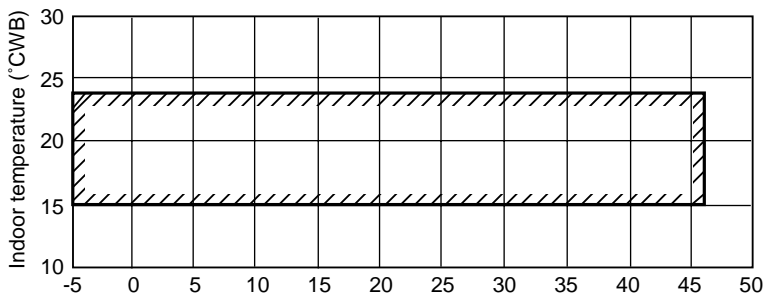

When the indoor unit is located above the outdoor unit for 4m or more, the outdoor unit inlet air temperature becomes 10~46°CDB.

• Heating

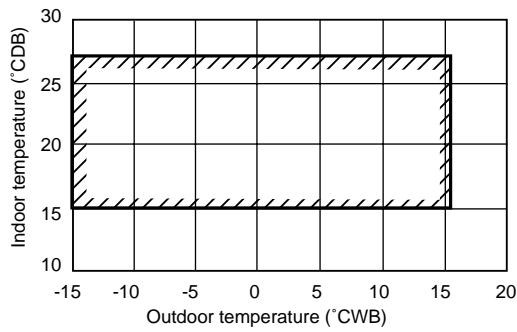

When the indoor unit 20 or 25type only is working, the outdoor unit inlet air temperature becomes -12~10°CWB.

3. Sound Levels

PUHY-600

Measurement condition

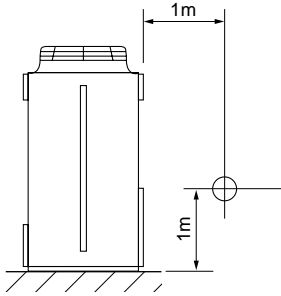

Sound pressure level in anechoic room

61.5 / 62.0 dB (A)

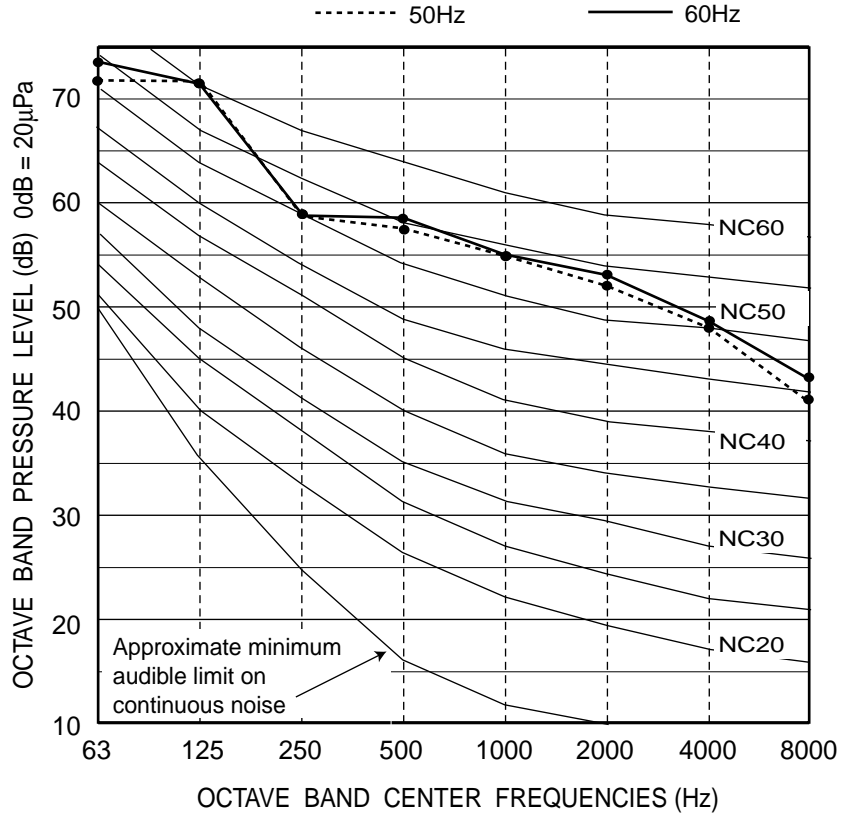

PUHY-650

Measurement condition

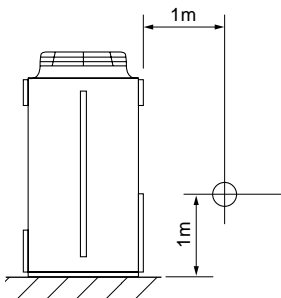

Sound pressure level in anechoic room

62.0 / 62.5 dB (A)

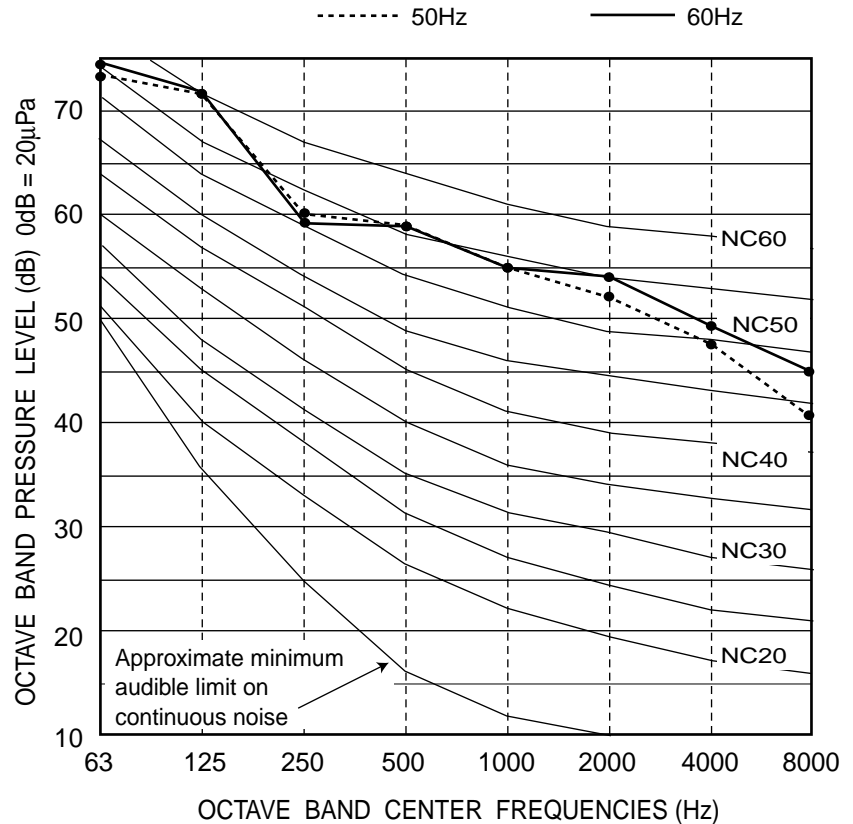

Super Y(R22)

PUHY-700

Measurement condition

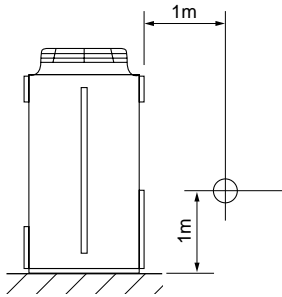

Sound pressure level in anechoic room
61.5 / 62.0 dB (A)

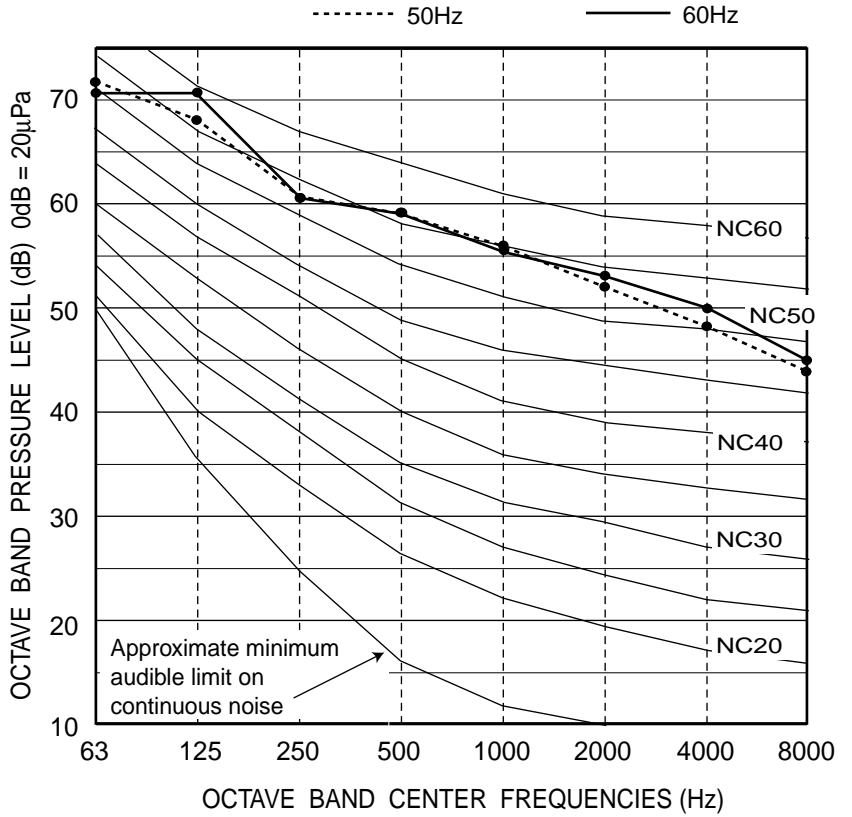

PUHY-750

Measurement condition

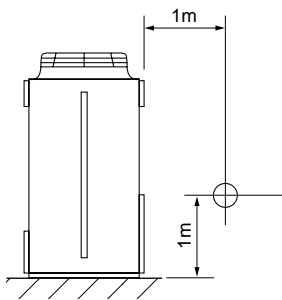

Sound pressure level in anechoic room
62.0 / 62.5 dB (A)

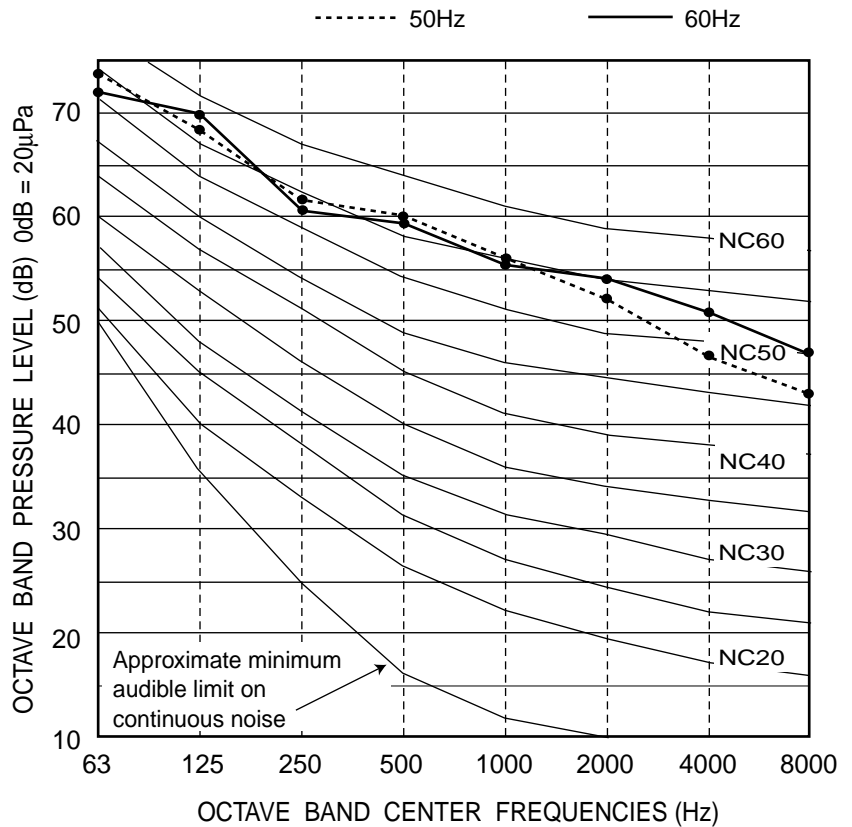

Super V(R22)

4. External Dimensions

PUHY-400,500YEM(-K, -C)-A(-BF, -BS)

Unit : mm

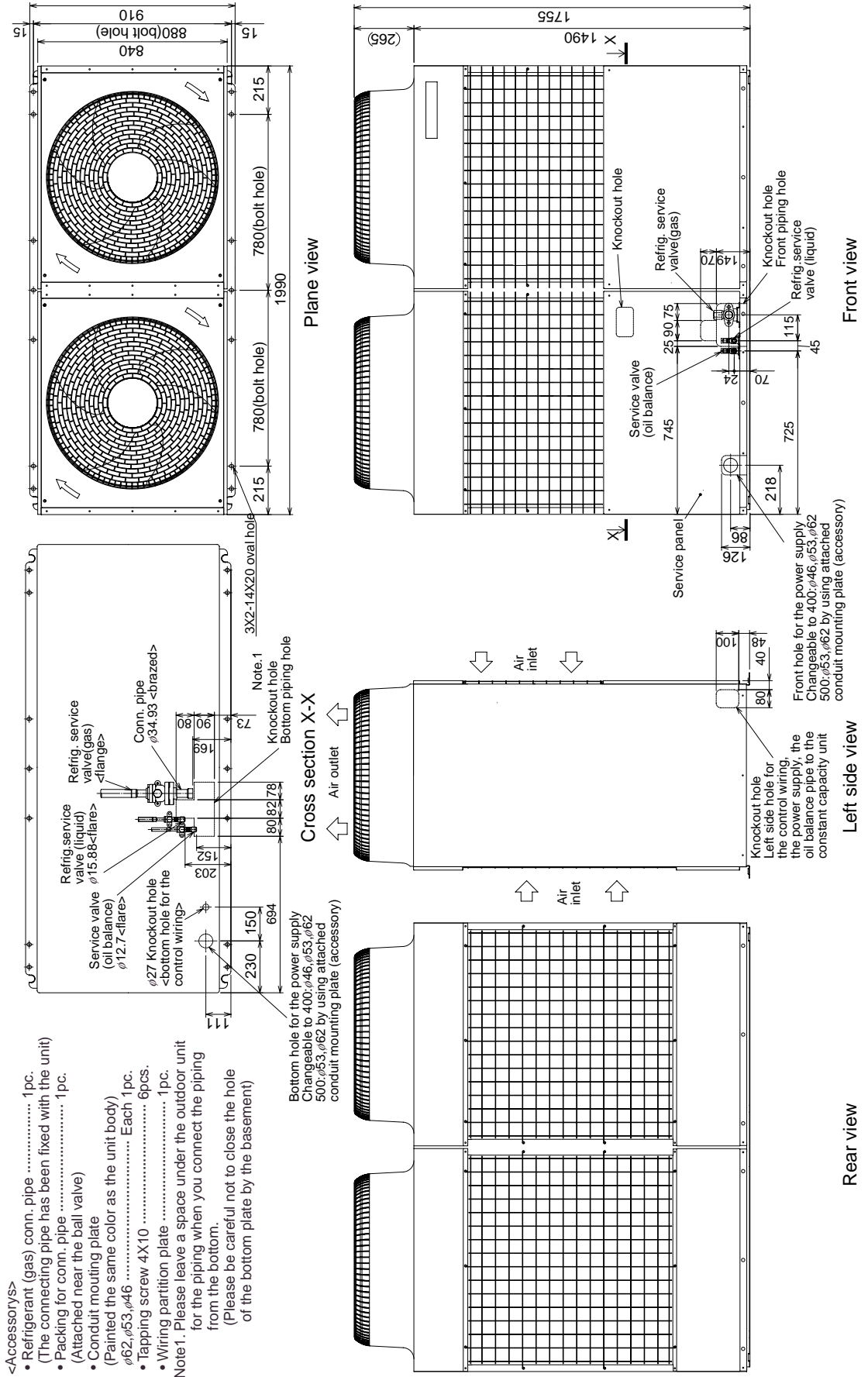

PUHN-200, 250YEM(-K,-C)-A(-BF, -BS)

- <Accessories>
- Refrigerant (gas) conn. pipe.....1pc.
(The connecting pipe has been fixed with the unit)
 - Packing for conn. pipe.....1pc.
(Attached near the ball valve)
 - Conduit mounting plate
(Painted the same color as the unit body)
φ40, φ33, φ27.....Each 1pc.
 - Tapping screw 4X12.....4pcs.
 - Oil balance conn. pipe (to the variable capacity unit
through the right side panel knockout hole).....1pc.
 - Sealing.....2pcs.

Note 1. Please leave a space under the outdoor unit for the piping when you connect the piping from the bottom.
(Please be careful not to close the hole of the bottom plate by the basement)

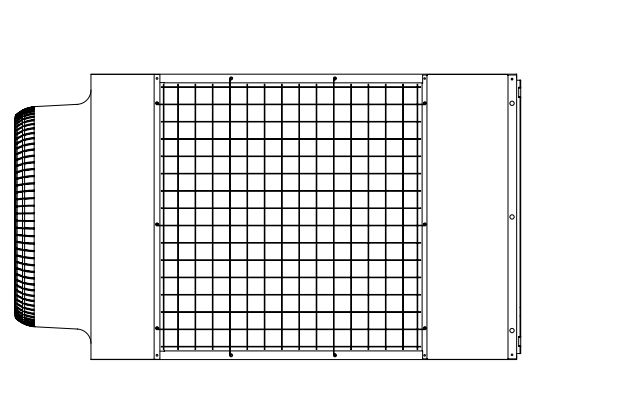
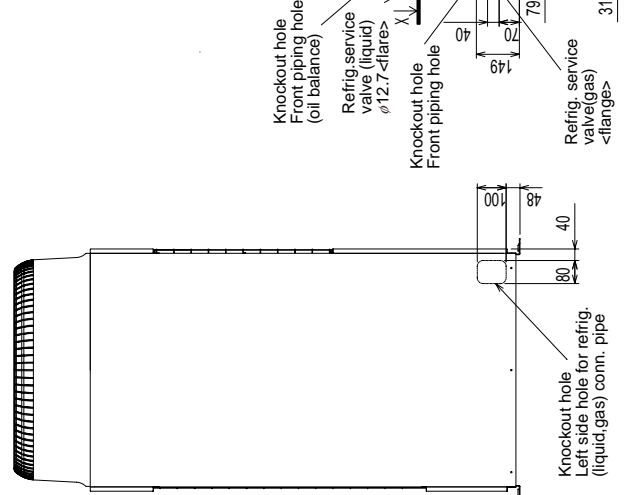
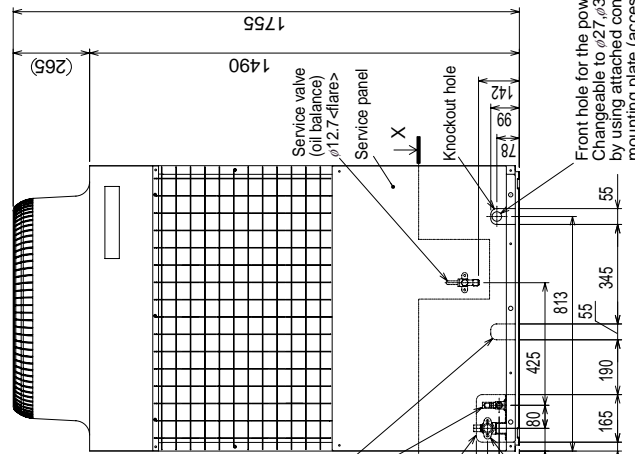
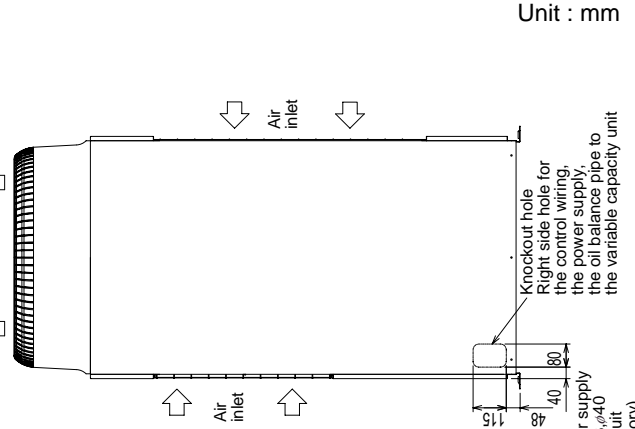
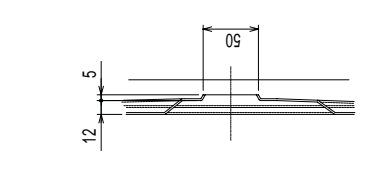
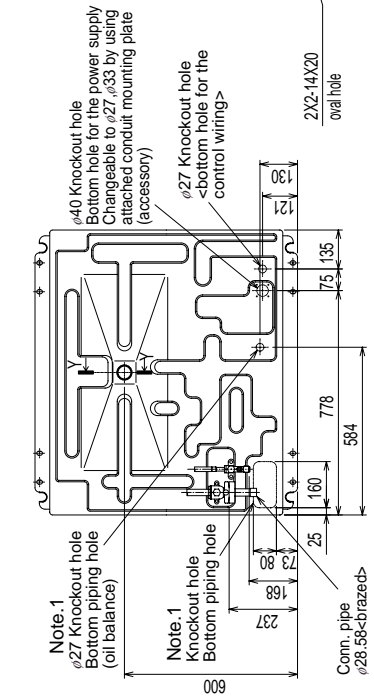
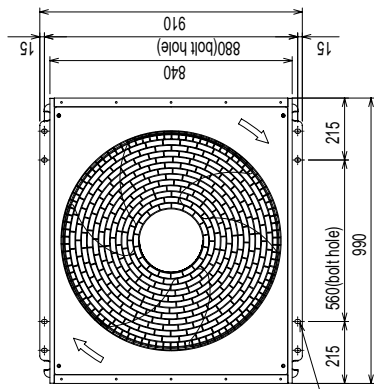

Unit : mm

PUHY-600,650,700,750YSEM-A(-BF, -BS)

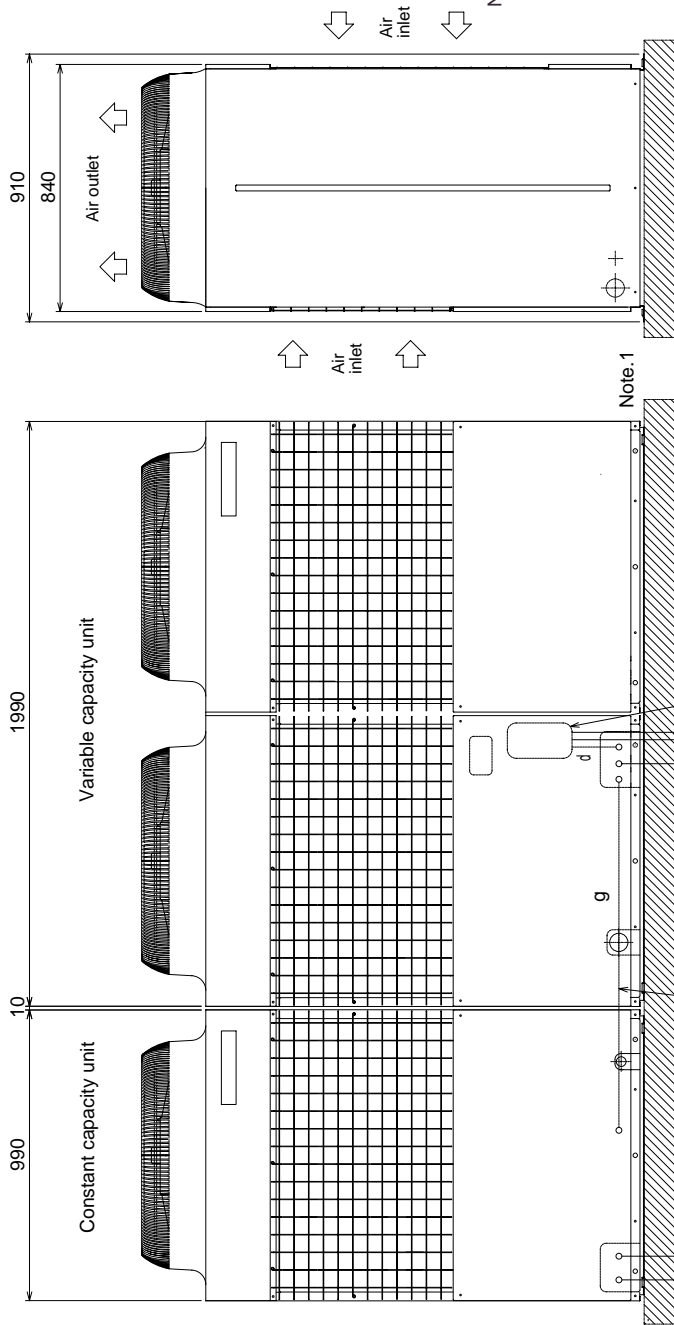

Note 1. Please install the constant capacity unit and the variable capacity unit on a same level stand.
 2. Pipe size is as follows.
 3. Please install the constant capacity unit and the variable capacity unit side by side, the constant capacity unit on the left side and the variable capacity unit on the right side.
 4. Distributor kit(Accessory) is needed to compose PUHY-600~750YSEM-A(-BF,-BS).

Right side view

Front view

	600	650	700	750
Indoor units ~ Distributor	liquid a	gas b	liquid c	gas d
Distributor ~ Variable capacity unit	φ34.93	φ19.05	φ41.28	φ15.88
Distributor ~ Constant capacity unit	φ34.93	φ34.93	φ12.7	φ28.58
Oil balance pipe	φ12.7	φ12.7	φ12.7	φ12.7

*1 This pipe has been fixed.
 *2 The oil balance pipe is usually fixed inside of the unit.
 *3 Accessory

Unit : mm

5. Electrical Wiring Diagram

PUHY-400-500YEM(-K,-C)-A(-BF, -BS)

<Symbol explanation>

Symbol	Name	Symbol	Name
DCL	DC reactor (Power factor improvement)	TH11.12	Thermistor
ACCT-U,W	Current Sensor	TH2	Storage pipe temp. detect
ZNR4	Varistor	TH3	Saturated exp. temp. detect
52C1	Magnetic contactor (Inverter main circuit)	TH4	Accumulator liquid temp. detect
52C2	Magnetic contactor (Overload relay)	TH5	Pipe temp. detect (heat exchanger outlet)
51C2	Overload relay	TH6	OA temp. detect (Liquid exit area)
52F	Magnetic contactor (Fan motor)	TH7	SC coil temp. detect (Bypass exit area)
MF1	Fan motor (Radiator panel)	TH8	SC coil temp. detect (Liquid exit area)
21S4a,4b	4-way valve	TH9a	LEV1 temp. detect (Radiator area)
SV1,2,3,2,3,4,6	Solenoid valve	TH9b	Composition sensor temp.
SV5,6,7,8	Solenoid valve (Heat exchanger capacity control)	TH10a	Gas pipe temp. (Inlet outlet)
SLEV	Electronic expansion valve (Oil return)	TH10c	Compressor shell temp.
LEV1	Electronic expansion valve (SC coil)	THHS	Radiator panel temp. detect
53HS	High pressure sensor	CH11,12	Accumulator liquid level detect
53LS	Low pressure sensor	CH2,3	Crank heater
63H1,2	High pressure switch	SSR	Solid state relay
L2	Choke coil (Transmission)	X1,2,4-12	Aux. relay
IPM	Intelligent power module	FB1-5	Ferrite core
T1-10	Terminal	⊕	Earth terminal

<Difference of appliance>

Model	Signal
PUHY-400YEM	TH1,5,6,7,8,9,10,11,12
PUHY-500YEM	TH1,5,6,7,8,9,10,11,12
PUHY-400YEM-AL	TH1,5,6,7,8,9,10,11,12
PUHY-500YEM-AL	TH1,5,6,7,8,9,10,11,12
PUHY-400YEM-AL	TH1,5,6,7,8,9,10,11,12
PUHY-500YEM-AL	TH1,5,6,7,8,9,10,11,12

NOTE: Mark ⊕ indicates terminal lead
 ⊕ board designation connector

<Unit internal layout>

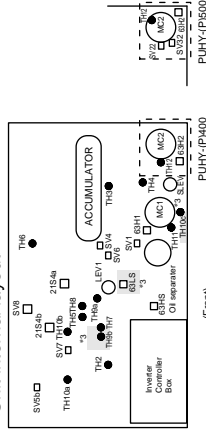

<Controller box internal layout>

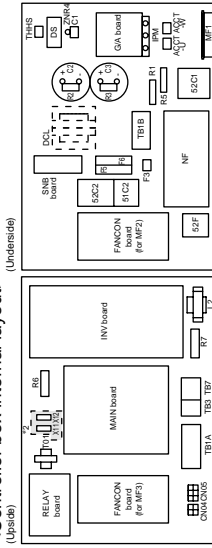

<Operation of self-diagnosis switch (SW) and LED display>

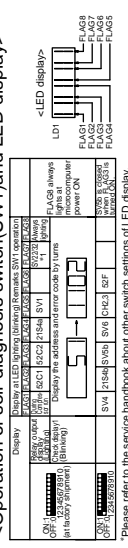

*Please refer to the service handbook about other switch settings of LED display.

<ELECTRICAL WIRING DIAGRAM>

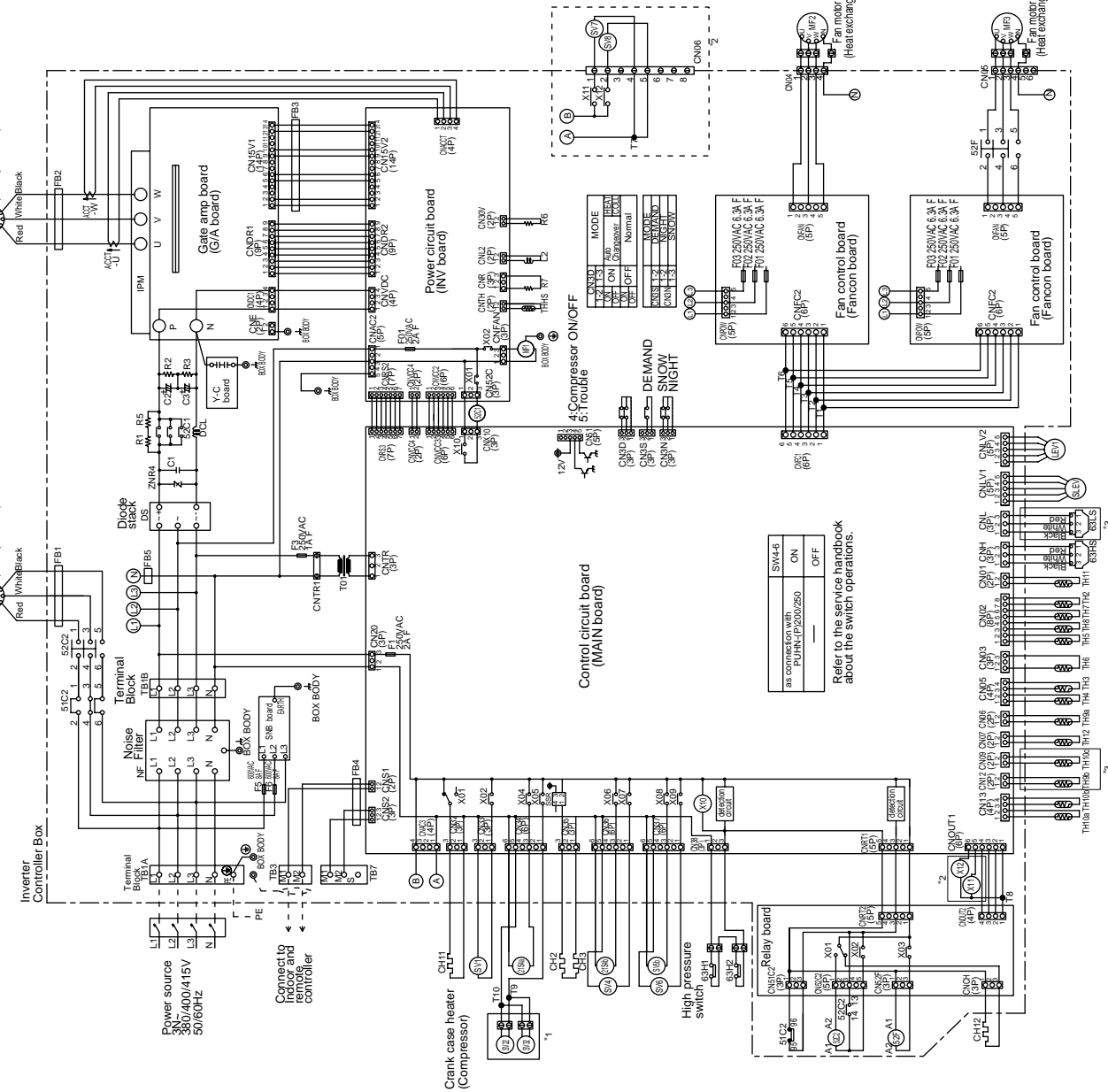

Refer to the service handbook about the switch operations.

Super (R22)

PUHN-200-250YEM(-K,-C)-A(-BF, -BS)

SYMBOL	NAME	SYMBOL	NAME
ZNR01	VARISTOR	TH3	THERMISTER
SSR	SOLID STATE RELAY	TH4	THERMISTER
F1	FUSE(6.3A) <CONT BOARD>	TH5	THERMISTER
F1,F2	FUSE(6A)	TH6	THERMISTER
F3	FUSE(1A)	TH7	THERMISTER
52C1	MAGNET CONTACTOR	TH8	THERMISTER
51C1	OVER CURRENT RELAY	TH9	THERMISTER
MC1	ELECTRIC MOTOR OF COMPRESSOR	TH10a	THERMISTER
MF	FAN MOTOR(HEAT EXCHANGER)	TH10b	THERMISTER
CH1	CRANK CASE HEATER(COMPRESSOR)	LEV1	ELECTRONIC EXPANSION VALVE
CH2,CH3	CORD HEATER	LEV2	ELECTRONIC EXPANSION VALVE
21S4	4-WAY VALVE	X01~X07	RELAY
SV1,SV4	SOLENOID VALVE	SW2,SW3	SWITCH
SV5b	SOLENOID VALVE	SWU1,2	SWITCH
63H	HIGH PRESSURE CUT OUT SWITCH	TB1	POWER SOURCE TERMINAL BLOCK
63LS	LOW SIDE PRESSURE SENSOR	⊕	EARTH TERMINAL
TH11	THERMISTER		

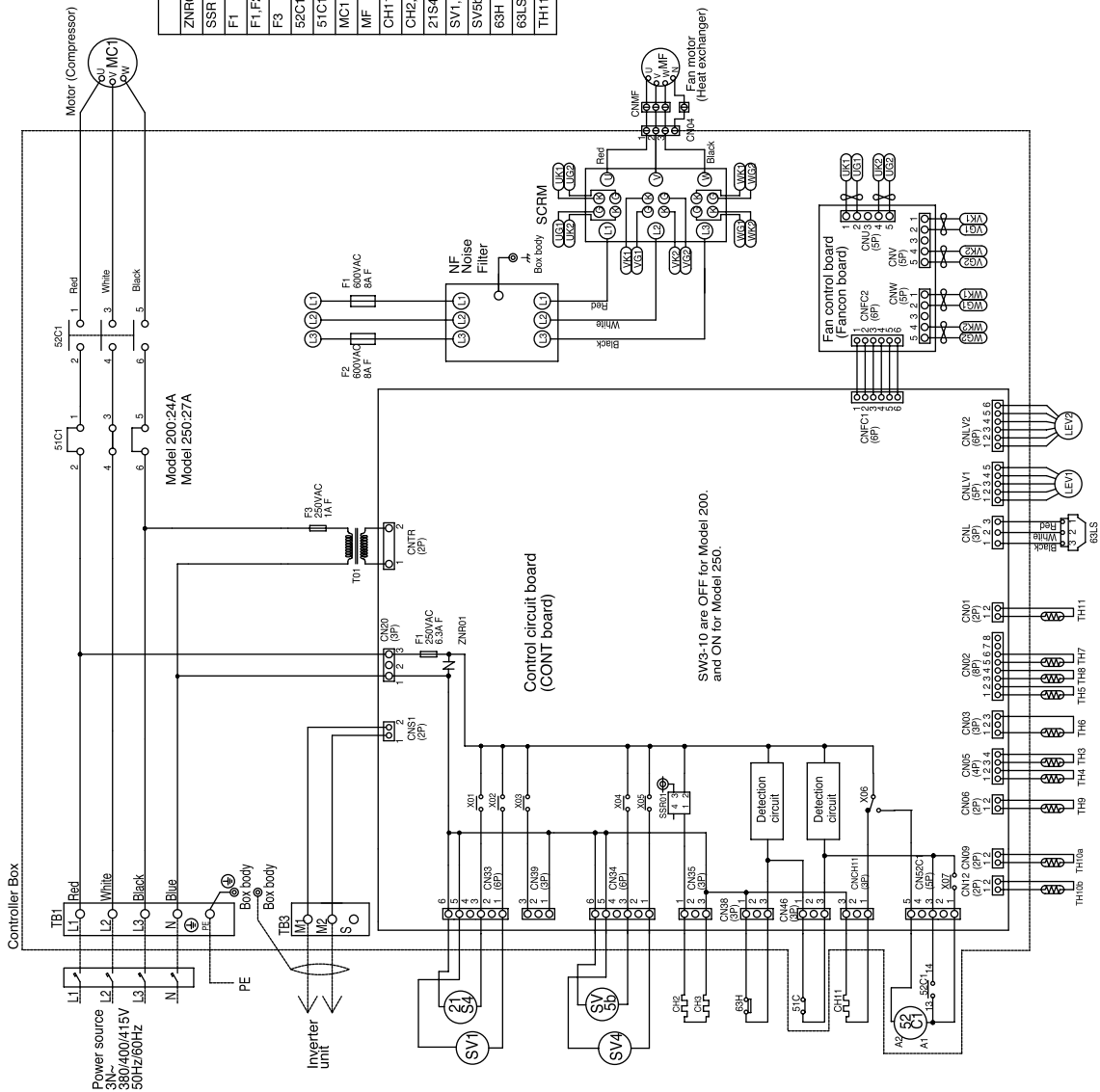

SuperY(R22)

6. Refrigerant Circuit Diagram And Thermal Sensor

* There are SV22,SV32 only for PUHY-700, 750.

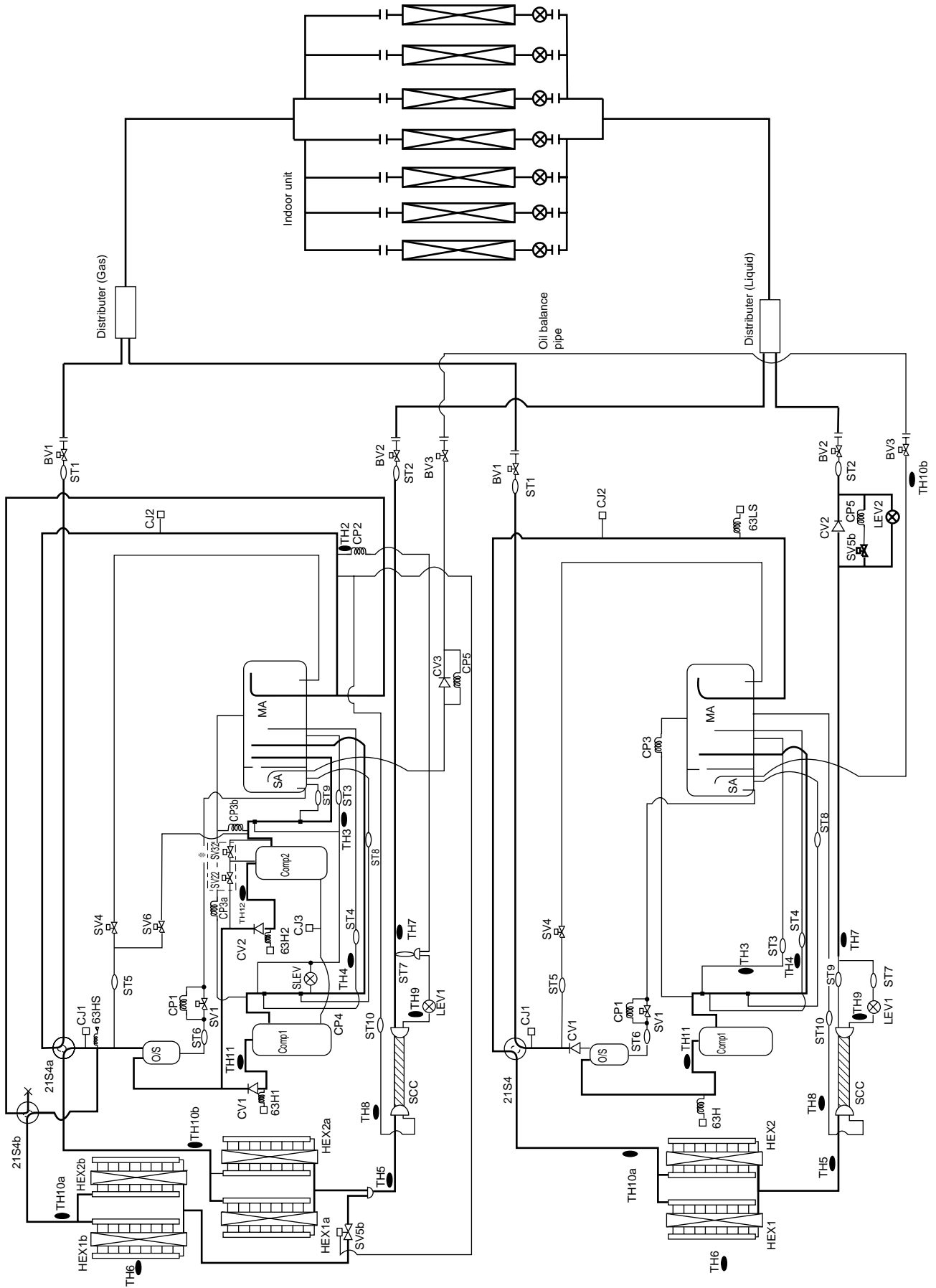

Super V(R22)

PURY-200-250YEMC-A

CONTENTS

1. Specifications	I -246
2. Capacity Tables	I -248
2-1 Correction by temperature	I -248
2-2 Correction by total indoor	I -250
2-3 Correction by refrigerant piping length	I -251
2-4 Correction at frosting and defrosting	I -252
2-5 Operation limit	I -252
3. Sound Levels	I -253
4. External Dimensions	I -254
5. Electrical Wiring Diagram	I -255
6. Refrigerant Circuit Diagram	I -256
And Thermal Sensor	

1. Specifications

Model name		PURY-200YEMC-A	
		Cooling	Heating
Capacity	*1 kW	24.6	25.0
Power source		3N ~ 380/400/415V 50/60Hz	
Power input	kW	9.65	7.66
Current	A	16.2/15.4/14.9	12.9/12.2/11.8
Fan	Type XQuantity	Propeller fan X1	
	Airflow rate	m ³ /min	200
	Motor output	kW	0.38
Compressor	Type	Hermetic	
	Motor output	kW	6.6
	Crankcase heater	kW	0.045(240V)
Refrigerant / Lubricant		R22/MS32(N-1)	
External finish		Pre-coated galvanized sheets <MUNSELL 5Y8/1 or similar>	
External dimension	mm	1755(H) X990(W) X840(L)	
Protection devices	High pressure protection		2.94MPa
	Compressor / Fan		Over current protection / Thermal switch
	Inverter		DC bus current protection, thermal switch
Refrigerant piping diameter	High press. / Low press.	φ 19.05 (Flare) / φ 25.4 (Flange)	
Indoor unit	Total capacity		50 ~ 150% of outdoor unit capacity
	Model / Quantity		Model 20 ~ 250 / 1 ~ 15
Noise level	* dB<A>	56	
Net weight	kg	238	
Operating temperature range		Indoor:15°CWB ~ 24°CWB Outdoor:-5°CDB ~ 43°CDB	Indoor:15°CDB ~ 27°CDB Outdoor:-15°CWB ~ 15.5°CWB
		-5°CDB/-6°CWB ~ 21°CDB/15.5°CWB with cooling/heating mixed operation.	
Matters Deserving Special Mention		A pipe of 28.58 can be used for the low pressure pipe	

Matters Deserving Special Mention A pipe of 28.58 can be used for the low pressure pipe.

Note: 1.Cooling/heating capacity indicates the maximum value at operation under the following condition.

*1 **Cooling** Indoor : 27°CDB/19°CWB Outdoor : 35°CDB
Heating Indoor : 20°CDB Outdoor : 7°CDB/6°CWB
 Pipe length : 7.5m Height difference : 0m

* It is measured in anechoic room.

R2(R22)

Model name			PURY-250YEMC-A	
			Cooling	Heating
Capacity	*1	kW	28.0	31.5
Power source			3N ~ 380/400/415V 50/60Hz	
Power input		kW	10.56	9.74
Current		A	17.8/16.9/16.3	16.4/15.6/15.0
Fan	Type XQuantity		Propeller fan X1	
	Airflow rate	m ³ /min	200	
	Motor output	kW	0.38	
Compressor	Type		Hermetic	
	Motor output	kW	7.5	
	Crankcase heater	kW	0.045(240V)	
Refrigerant / Lubricant			R22/MS32(N-1)	
External finish			Pre-coated galvanized sheets <MUNSELL 5Y8/1 or similar>	
External dimension		mm	1755(H) X990(W) X840(L)	
Protection devices	High pressure protection		2.94MPa	
	Compressor / Fan		Over current protection / Thermal switch	
	Inverter		DC bus current protection, thermal switch	
Refrigerant piping diameter		High press. / Low press.	φ 19.05 (Flare) / φ 28.58 (Flange)	
Indoor unit	Total capacity		50 ~ 150% of outdoor unit capacity	
	Model / Quantity		Model 20 ~ 250 / 1 ~ 16	
Noise level	*	dB<A>	57	
Net weight		kg	240	
Operating temperature range			Indoor:15°CWB ~ 24°CWB Outdoor:-5°CDB ~ 43°CDB	Indoor:15°CDB ~ 27°CDB Outdoor:-15°CWB ~ 15.5°CWB
			-5°CDB/-6°CWB ~ 21°CDB/15.5°CWB with cooling/heating mixed operation.	

Note: 1.Cooling/heating capacity indicates the maximum value at operation under the following condition.

*1 **Cooling** Indoor : 27°CDB/19°CWB Outdoor : 35°CDB
Heating Indoor : 20°CDB Outdoor : 7°CDB/6°CWB
Pipe length : 7.5m Height difference : 0m

* It is measured in anechoic room.

R2(R22)

2. Capacity Tables

2-1. Correction by temperature

Cooling

- Standard Specifications

		PURY-200	PURY-250
Capacity	kW	24.6	28.0
Input	kW	9.65	10.56

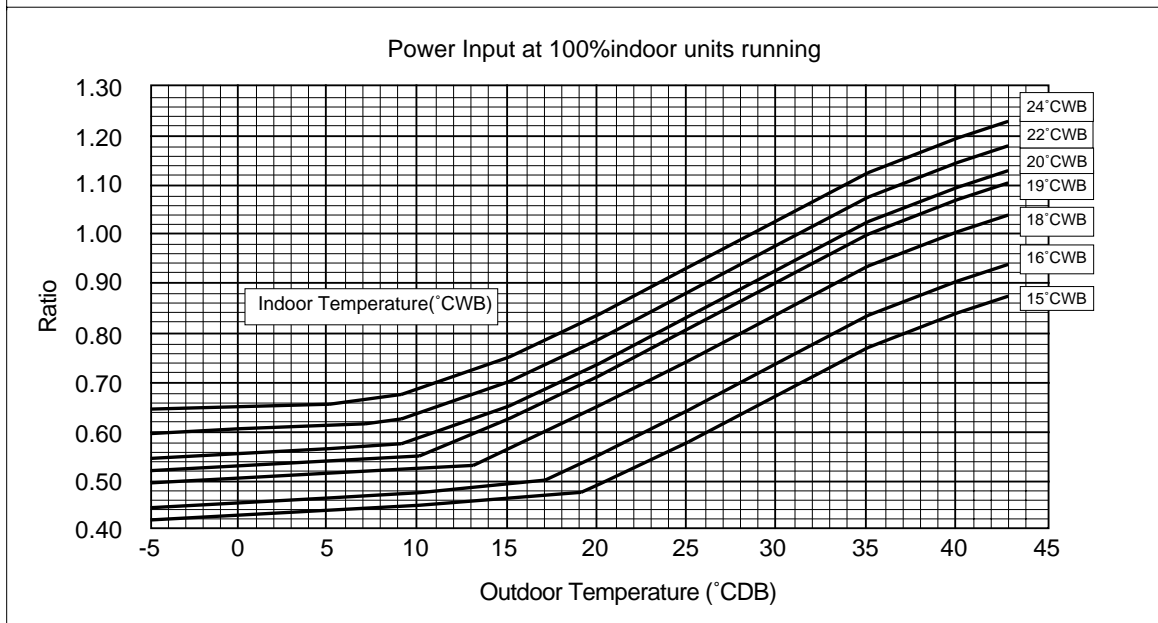
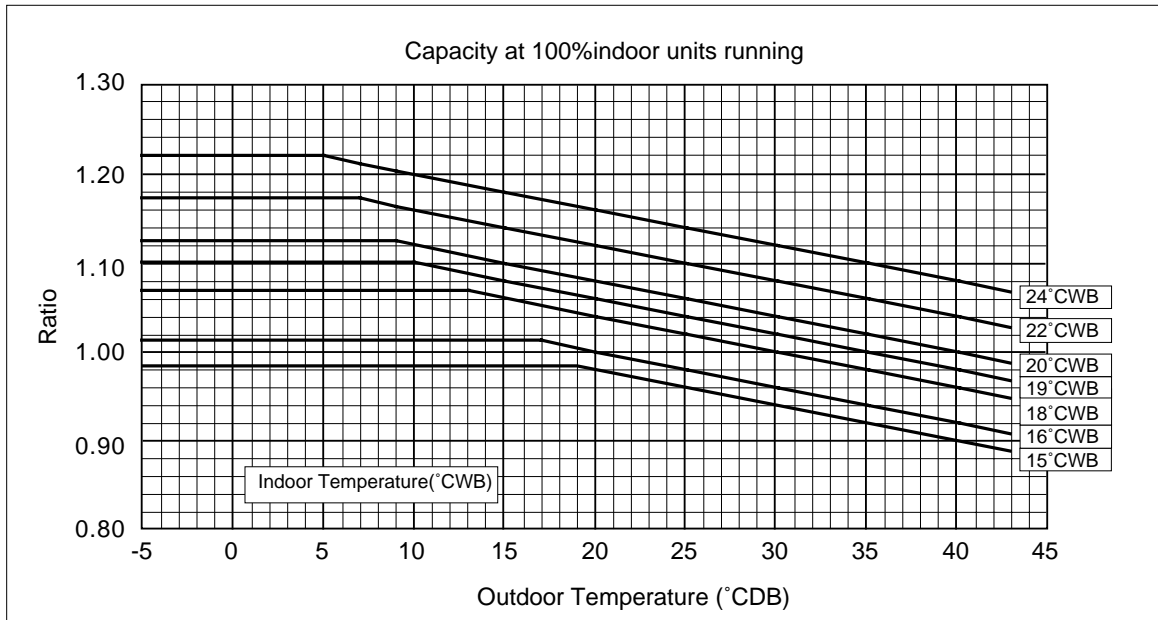

R2(R22)

Heating

- Standard Specifications

		PURY-200	PURY-250
Capacity	kW	25.0	31.5
Input	kW	7.66	9.74

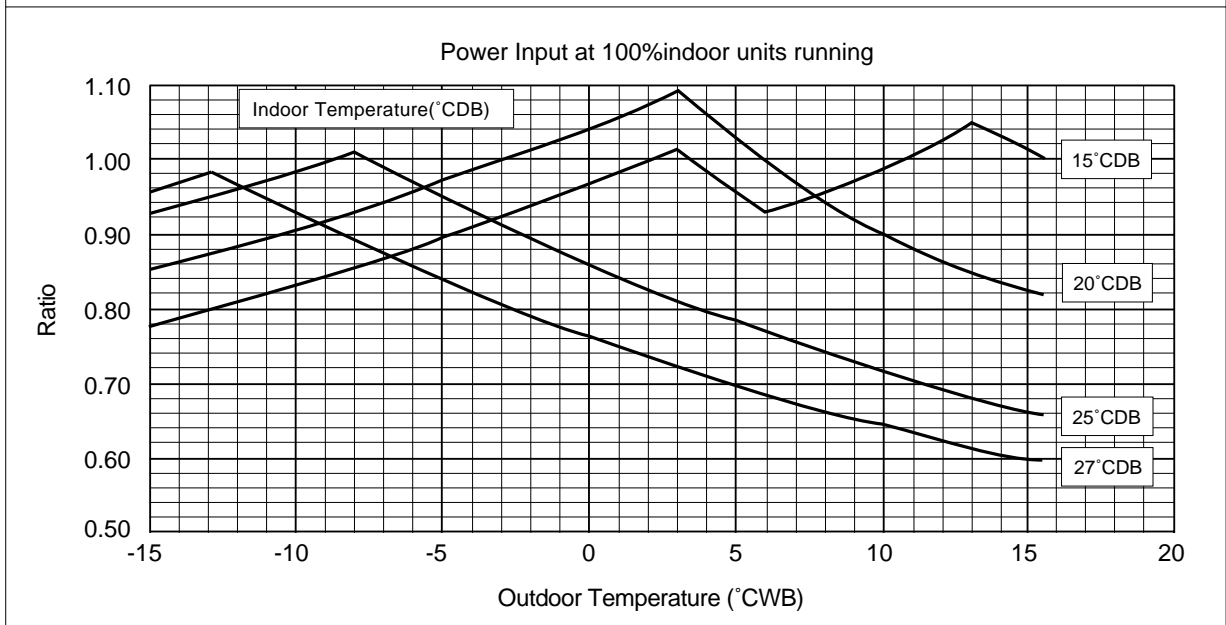
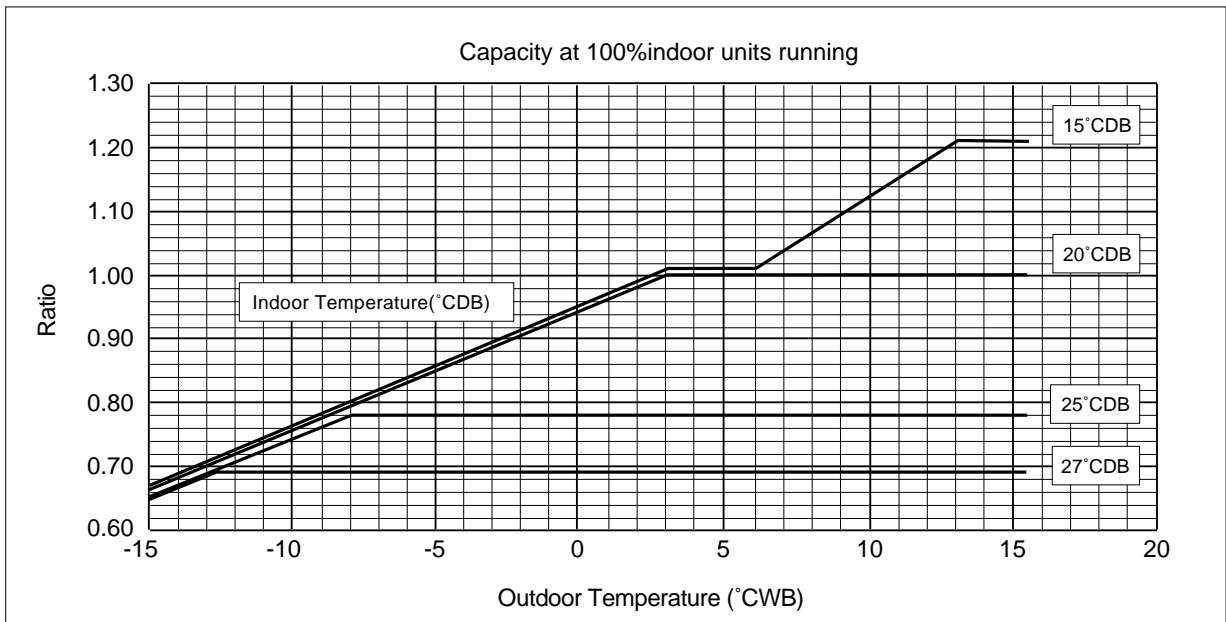

R2(R22)

2-2. Correction by total indoor

PURY-200

1) Capacity

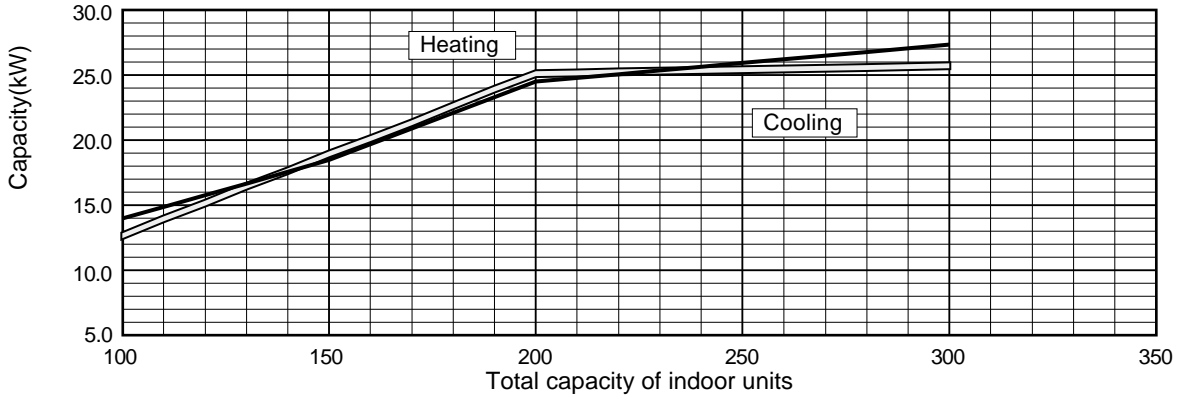

2) Input

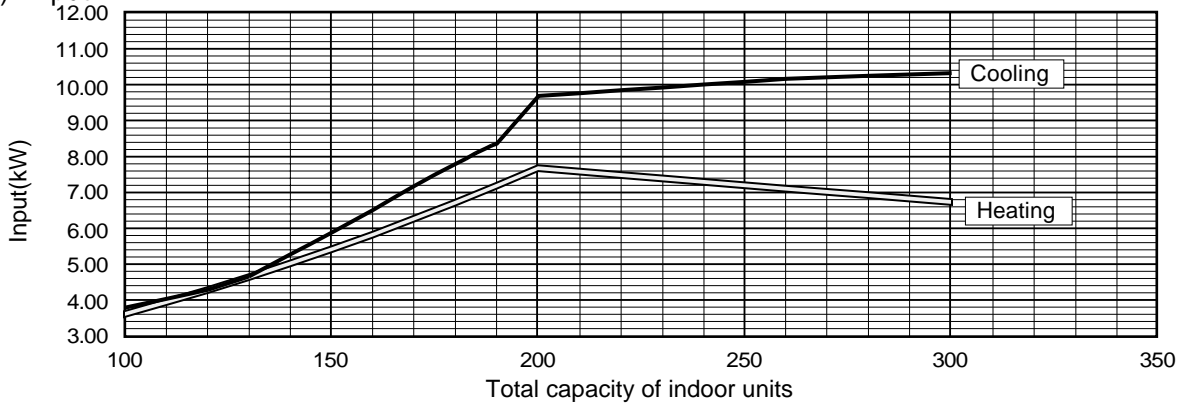

PURY-250

1) Capacity

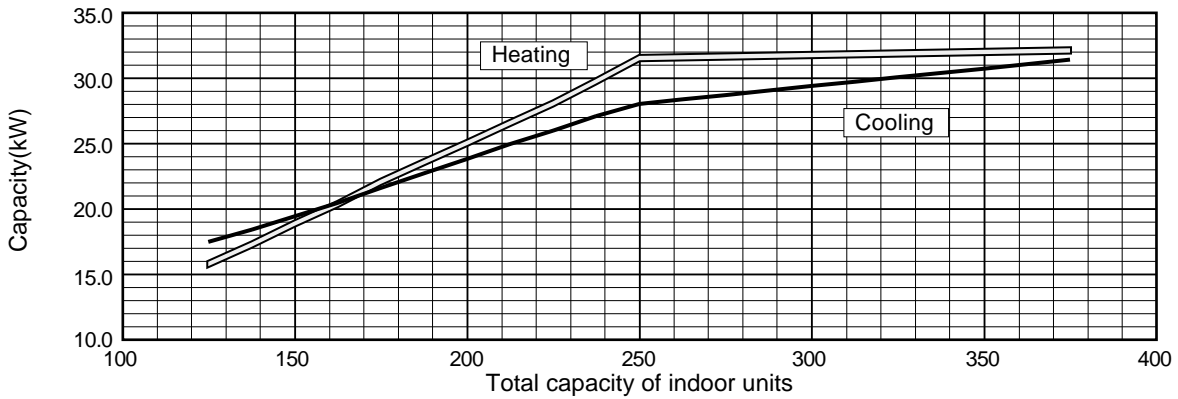

2) Input

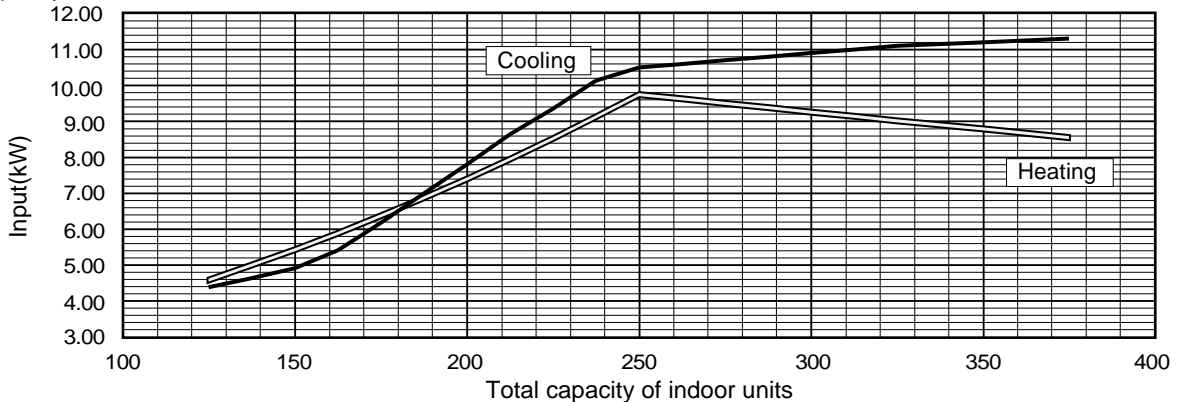

R2(R22)

2-3. Correction by refrigerant piping length

To obtain a decrease in cooling/heating capacity due to refrigerant piping extension, multiply by the capacity correction factor based on the refrigerant piping equivalent length in the table below.

• Cooling capacity correction

PURY-200

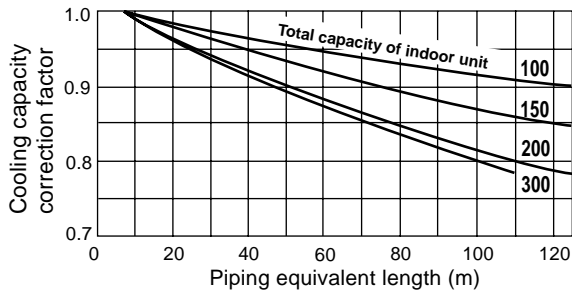

PURY-250

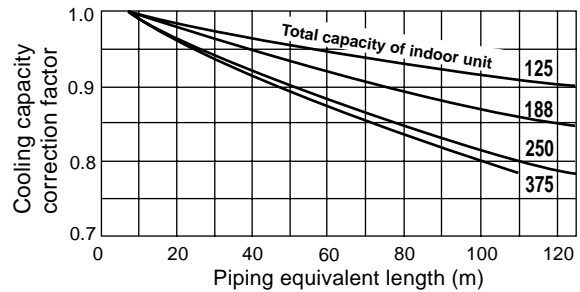

• Heating capacity correction

PURY-200

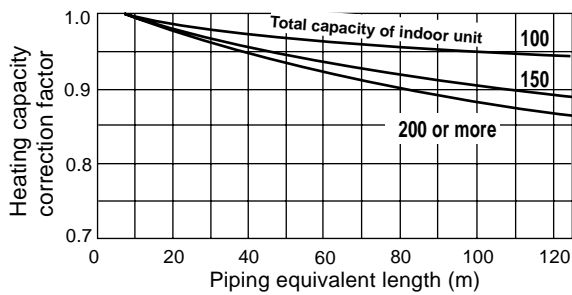

PURY-250

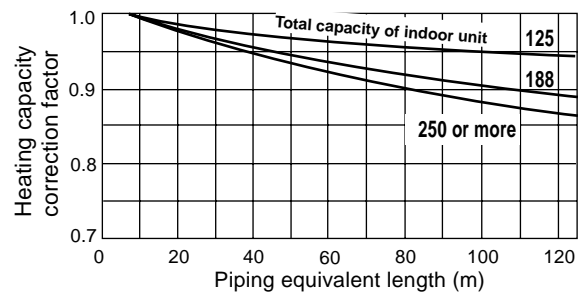

• How to obtain piping equivalent length

① PURY-200

Equivalent length = (Actual piping length to the farthest indoor unit) + (0.47 × number of bent on the piping)m

② PURY-250

Equivalent length = (Actual piping length to the farthest indoor unit) + (0.50 × number of bent on the piping)m

2-4. Correction at frosting and defrosting

When a decrease in heating capacity due to frosted and defrosting operations is considered, the value multiplied by the correction factor in the table below represents the heating capacity.

Correction factor table

Outdoor inlet air temp (°CWB)	6	4	2	0	-2	-4	-6	-8	-10
Correction factor	1.0	0.95	0.84	0.83	0.87	0.9	0.95	0.95	0.95

2-5. Operation limit

• Cooling

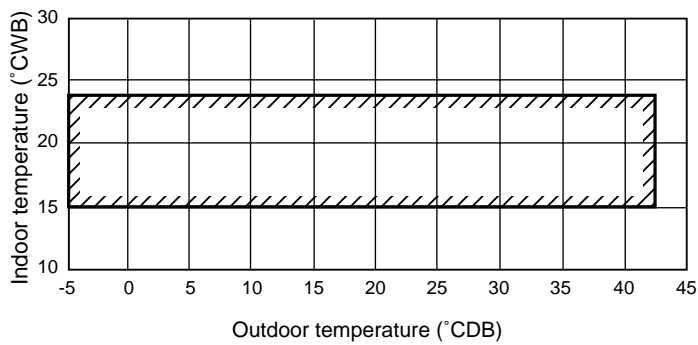

• Heating

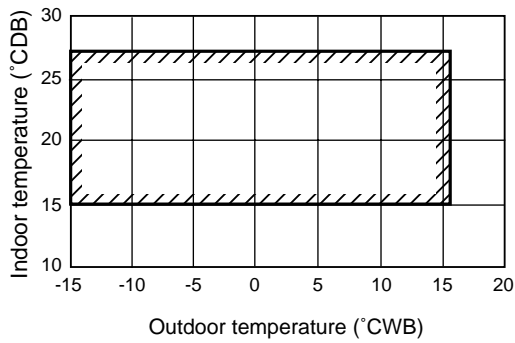

* Outdoor temperature : -5°CDB/-6°CWB ~ 21°CDB/15.5°CWB in cooling/heating mixed mode.

3. Sound Levels

PURY-200

Measurement condition

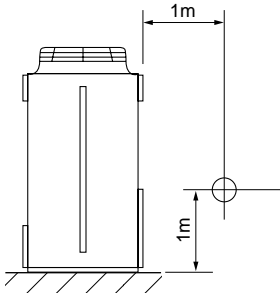

Sound pressure level in anechoic room

56 dB (A)

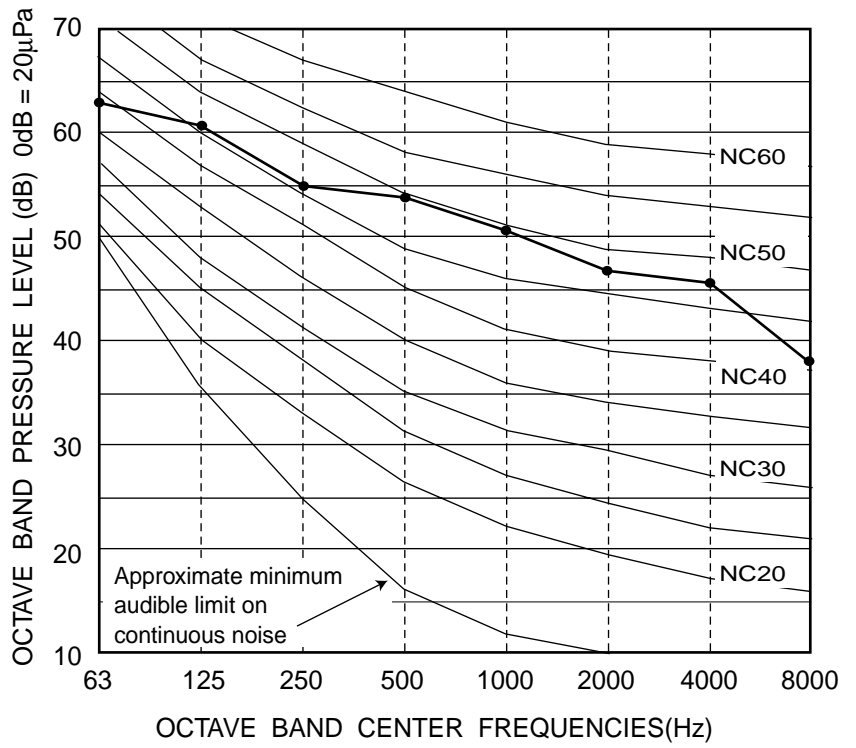

PURY-250

Measurement condition

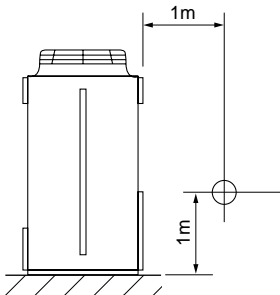

Sound pressure level in anechoic room

57 dB (A)

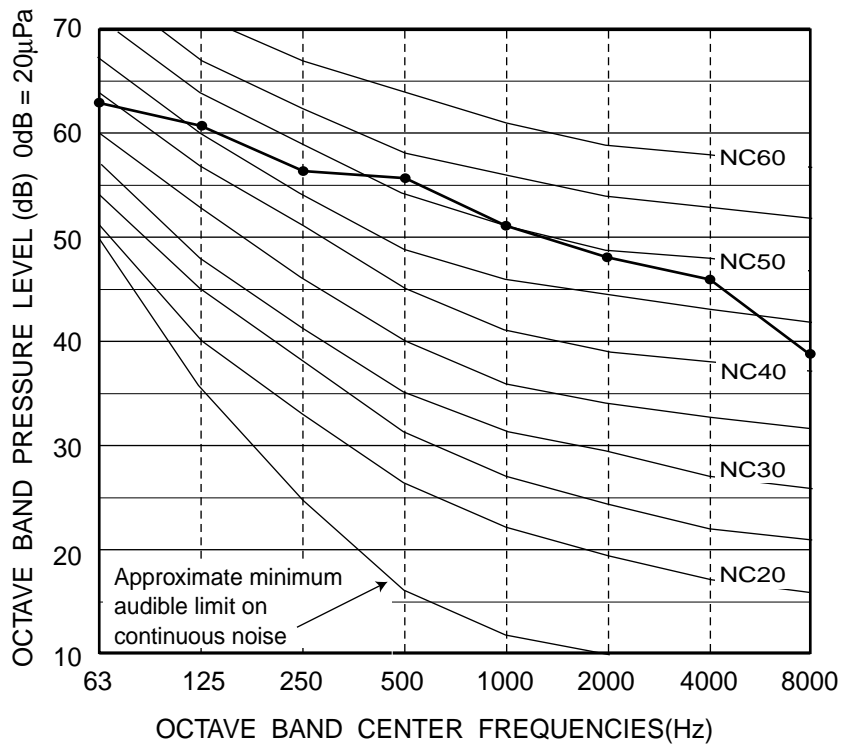

R2(R22)

4. External Dimensions

PURY-200,250YEMC-A

Unit : mm

- <Accessory>
- Refrigerant (gas) conn. pipe 1pc.
(The connecting pipe is fixed with the unit)
 - Packing for conn. pipe 1pc.
(Attached near the ball valve)
 - Wiring mounting board
 - Conduit mounting plate
(Painted the same color as the unit body)
 - $\phi 40$ 1pc.
 - $\phi 33$ 1pc.
 - $\phi 27$ 1pc.
 - Tapping screw 4 X 10 6pcs.
- Note1. Please leave a space under the outdoor unit for the piping. When you connect the piping from the bottom.
(Please be careful not to close the hole of the bottom plate by the basement)

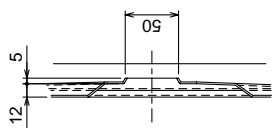
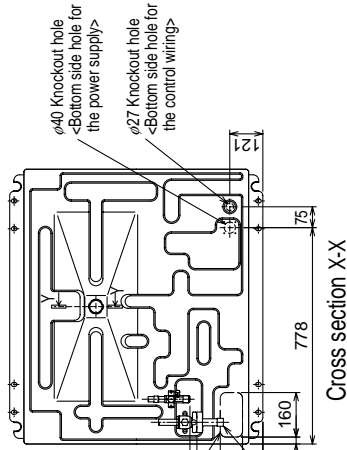
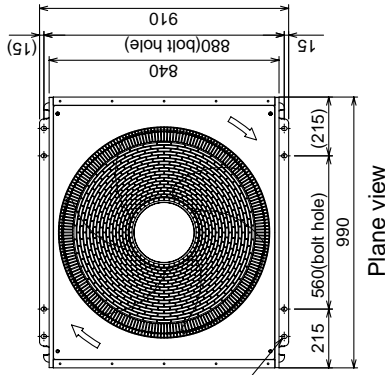

Note1
Knockout hole
Bottom piping hole
<Bottom wiring hole>

Conn. pipe
200 ϕ 25.4-brazed-
28 ϕ 28.58-brazed-

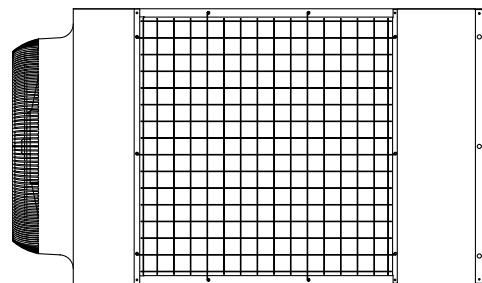
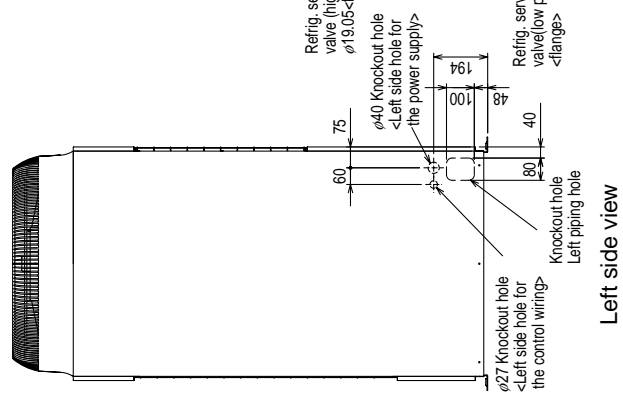
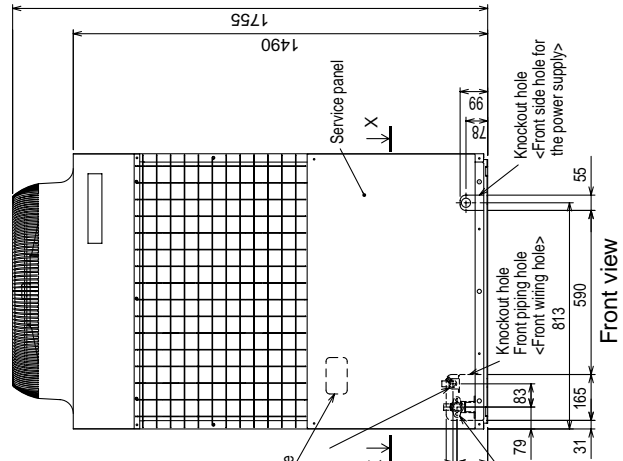
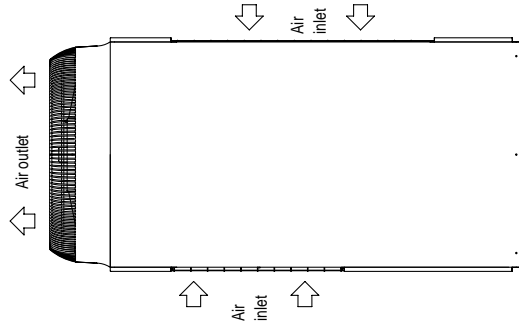

5. Electrical Wiring Diagram

PURY-200, 250YEMC-A

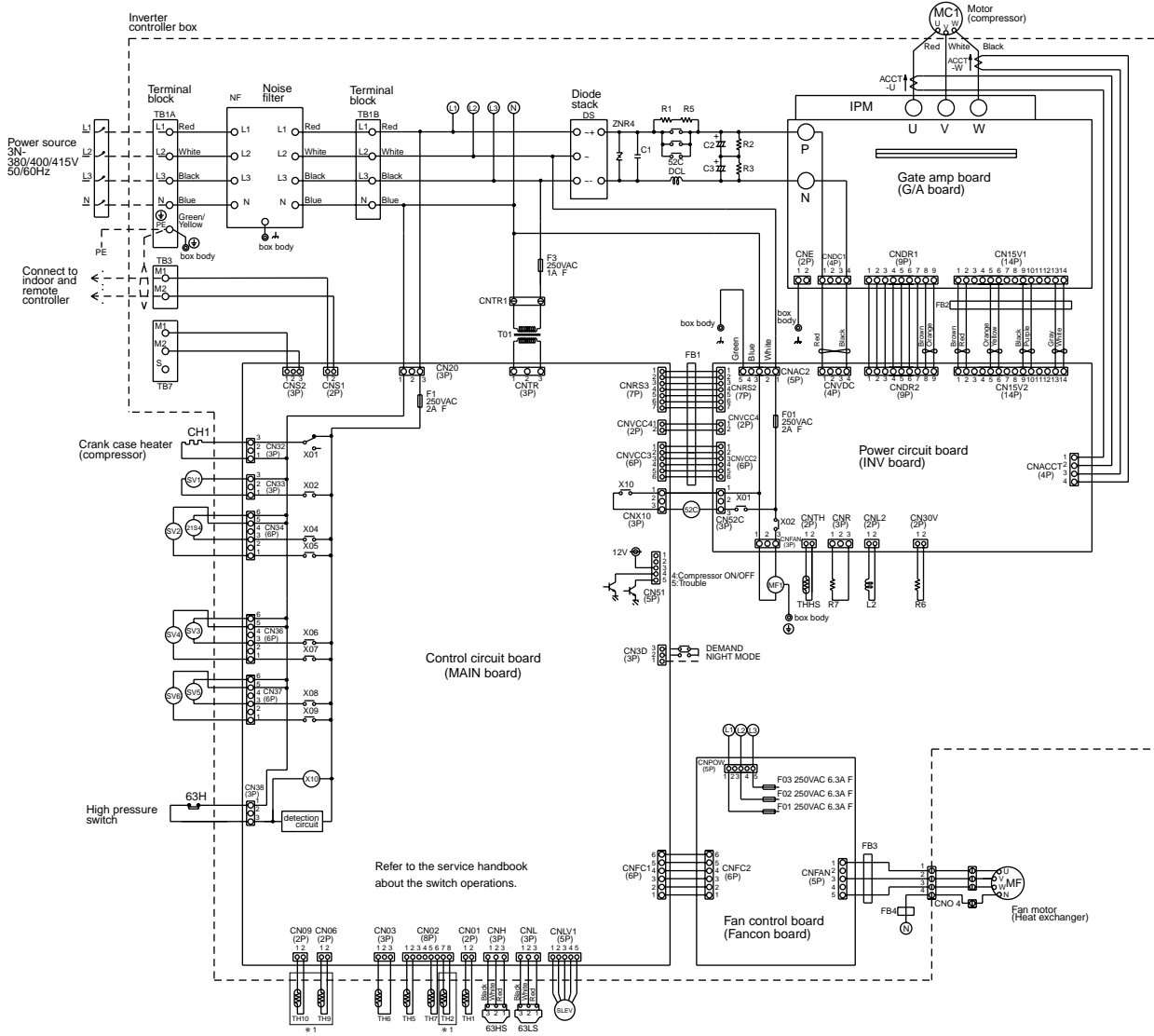

Refer to the service handbook about the switch operations.

Appliance	Name
PURY-P200 / 250	All exists
PURY-200 / 250	*1* are not existed

<SYMBOL EXPLANATION>

Symbol	Name	Symbol	Name	Symbol	Name	Symbol	Name		
DCL	DC reactor (Power factor improvement)	SV1,SV2	Solenoid valve (Discharge-suction bypass)	TH1	Thermistor	Discharge pipe temp. detect	THHS	Thermistor	Radiator panel temp. detect
ACCT-UW	Current Sensor	SV3-SV6	Solenoid valve (Heat exchanger capacity control)	TH2 *1		Saturation evapo. temp. detect	X1,2,4-10	Aux. relay	
ZNR4	Varistor	SLEV	Electronic expansion valve(Oil return)	TH5		Pipe temp. detect	FB1-4	Ferrite core	
52C	Magnetic contactor (Inverter main circuit)	63HS	High pressure sensor	TH6		OA temp. detect	⊕	Earth terminal	
MF1	Fan motor (Radiator panel)	63LS	Low pressure sensor	TH7		Liquid outlet temp. detect at Sub-cool coil			
21S4	4-way valve	L2	Choke coil (Transmission)	TH9 *1		High pressure liquid. temp.			
		IPM	Intelligent power module	TH10 *1		Compressor shell temp.			

R2(R22)

6. Refrigerant Circuit Diagram And Thermal Sensor

PURY-200, 250

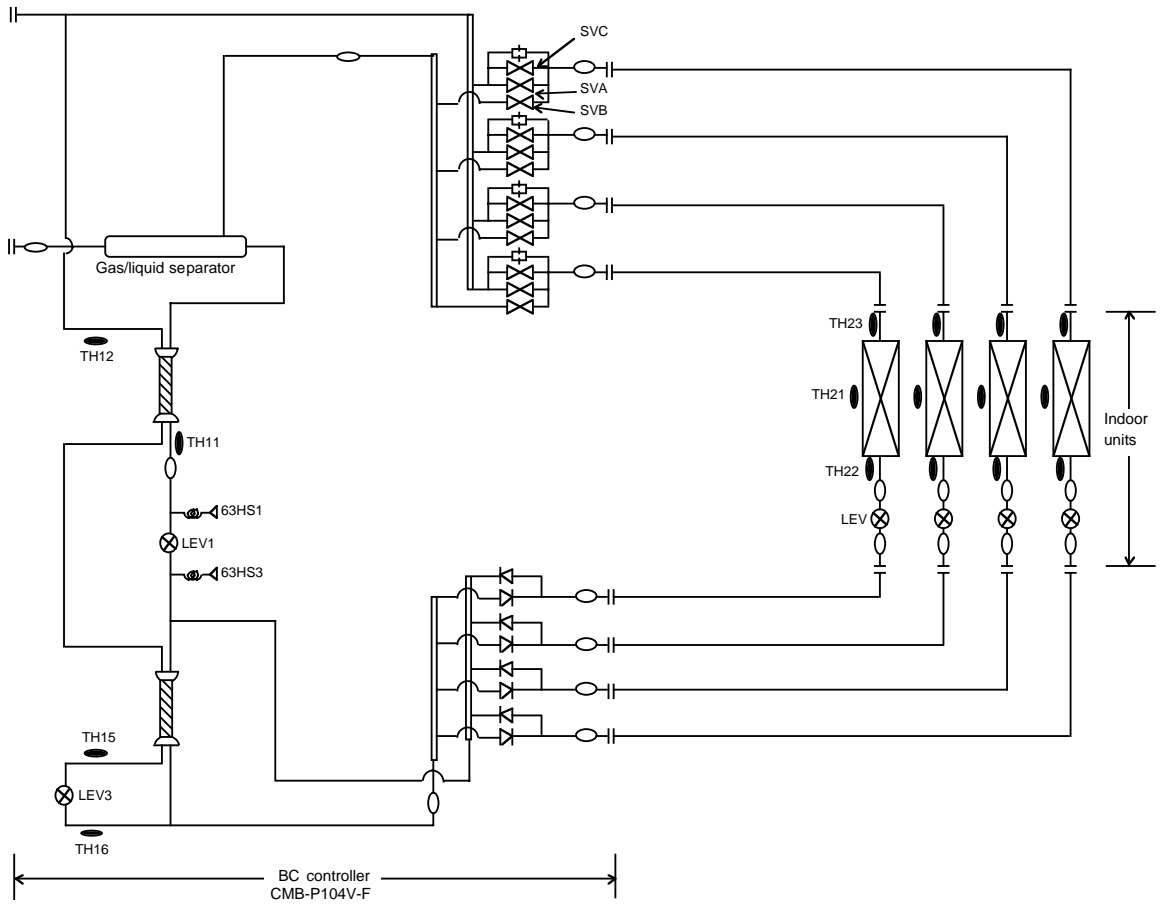
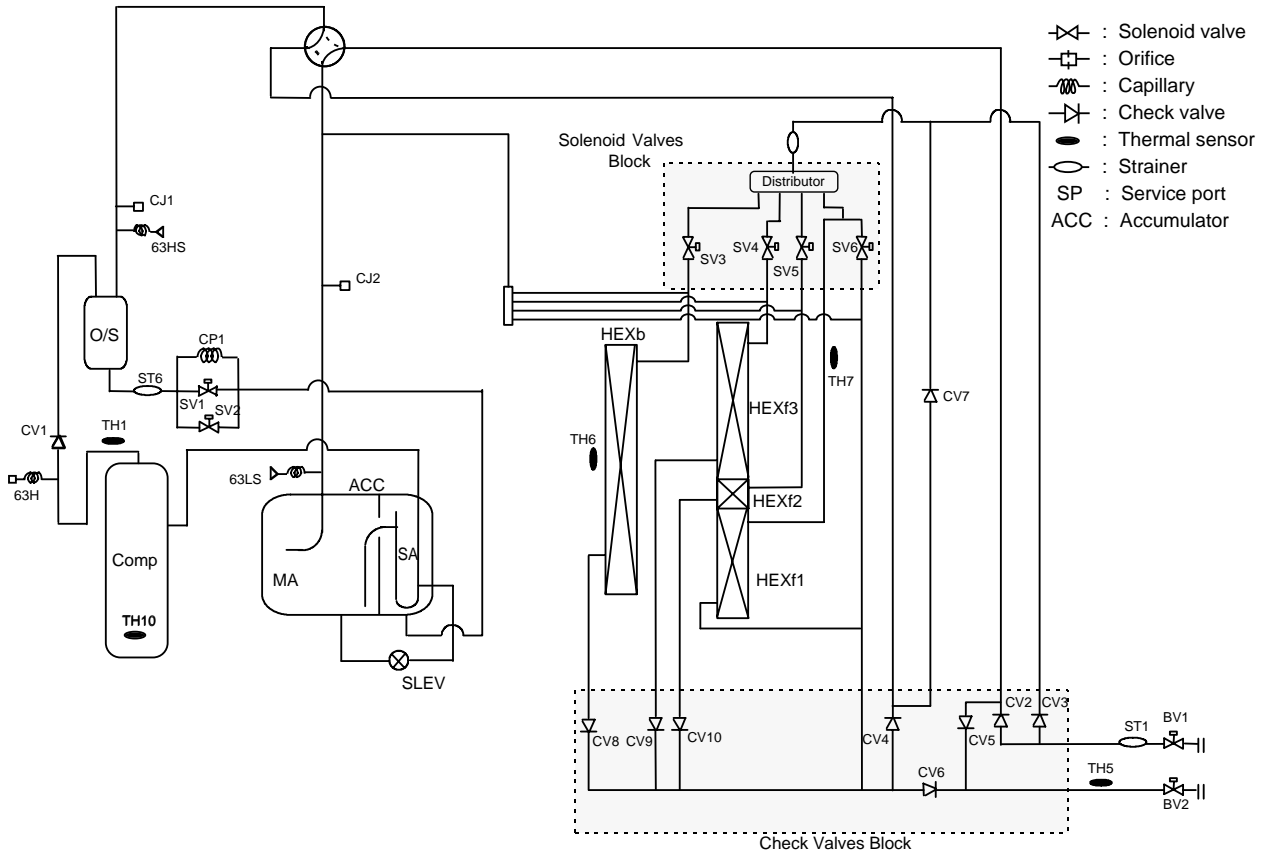

R2(R22)

CITY MULTI INDOOR UNIT

CONTENTS

Introduction		II -2
Ceiling concealed		PEFY-P-VML-A1 II -5
		PEFY-P-VMH-A
		PEFY-P-VMM-A II -35
		PEFY-P-VMH-A-F II -63
Ceiling mounted built-in		PDFY-P-VM-A II -77
Floor standing	Exposed	PFFY-P-VLEM-A II -101
	Concealed	PFFY-P-VLRM-A
Cassette ceiling	1-way flow	PMFY-P-VBM-A II -115
	2-way flow	PLFY-P-VLMD-A II -127
		PLFY-P-VLMD-B
	4-way flow	PLFY-P-VKM-A/VAM-A II -151
Wall mounted		PKFY-P-VAM-A/VGM-A II -169
		PKFY-P-VFM-A II -185
Ceiling suspended		PCFY-P-VGM-A II -195
OA Processing unit	Non-humidifier	GUF-RD2 II -205
	Include humidifier	GUF-RDH2
LOSSNAY		LGH-RX ₃ -E II -213
BC controller (with PURY, PQRY)		CMB-P-V-F II -221
		CMB-P-V-FA
		CMB-P-V-FB

Introduction

CITY MULTI

INDOOR UNITS

Type	Model Name	20	25	32	40	50	63	71	80	100	125	140	200	250
Ceiling concealed	PEFY-P-VML-A1	●	●	●										
	PEFY-P-VMH-A				●	●	●	●	●	●	●	●	●	●
	PEFY-P-VMM-A	●	●	●	●	●	●	●	●	●	●	●		
	PEFY-P-VMH-A-F								●			●		
Ceiling mounted built-in	PDFY-P-VM-A	●	●	●	●	●	●	●	●	●	●			
Floor standing (Exposed)	PFFY-P-VLEM-A	●	●	●	●	●	●							
Floor standing (Concealed)	PFFY-P-VLRM-A	●	●	●	●	●	●							
Cassette ceiling (1-way flow)	PMFY-P-VBM-A	●	●	●	●									
Cassette ceiling (2-way flow)	PLFY-P-VLMD-A								●	●	●			
	PLFY-P-VLMD-B	●	●	●	●	●	●							
Cassette ceiling (4-way flow)	PLFY-P-VKM-A			●	●	●	●							
	PLFY-P-VAM-A								●	●	●			
Wall mounted	PKFY-P-VAM-A	●	●											
	PKFY-P-VGM-A			●	●	●								
	PKFY-P-VFM-A						●			●				
Ceiling suspended	PCFY-P-VGM-A				●		●			●	●			
OA Processing unit (Non humidifier)	GUF-RD2			● (50)			● (100)							
OA Processing unit (Include humidifier)	GUF-RDH2			● (50)			● (100)							

LOSSNAY UNITS

Model Name	25	35	50	80	100	150	200
LGH-RX3-E	●	●	●	●	●	●	●

BC controllers

Model Name	104	105	106	108	1010	1013	1016
CMB-P-V-F	●	●	●	●	●	●	●
CMB-P-V-FA				●	●	●	●
CMB-P-V-FB				●			

Meaning of model name

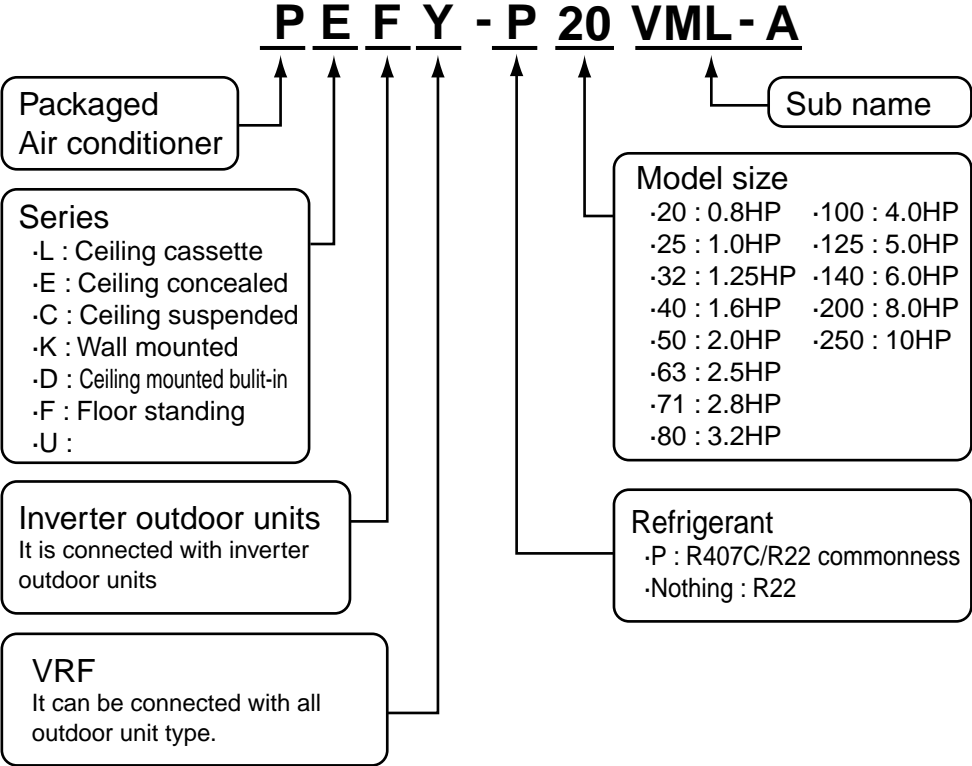

CONTENTS

1. Specifications	II -6
2. Capacity Tables	II -8
2-1 Cooling Capacity(PUMY)	II -8
2-2 Heating Capacity(PUMY)	II -10
2-3 Cooling Capacity(Y/R2-8-10-13HP)	II -11
2-4 Heating Capacity(Y/R2-8-10-13HP)	II -13
2-5 Cooling Capacity(Big Y, Super Y, Big R2)	II -14
2-6 Heating Capacity(Big Y, Super Y, Big R2)	II -16
2-7 Cooling Capacity(WY, WR2)	II -17
2-8 Heating Capacity(WY, WR2)	II -18
3. Sound Levels	II -19
3-1 Noise levels(VML-A1)	II -19
3-2 N/C curves(VML-A1)	II -19
3-3 Fan characteristics curves(VML-A1)	II -19
3-4 Noise levels(VMH-A)	II -20
3-5 N/C curves(VMH-A)	II -20
3-6 Fan characteristics curves(VMH-A)	II -25
4. External Dimensions	II -28
5. Electrical Wiring Diagrams	II -31
6. Options	II -34

1. Specifications

PEFY-P-VML-A1/VMH-A

			PEFY-P20VML-A1	PEFY-P25VML-A1	PEFY-P32VML-A1
Power source			~ 220-240V 50Hz / 60Hz		
Cooling capacity	*1	kW	2.2	2.8	3.6
	*2	kcal/h	2,000	2,500	3,150
Heating capacity	*1	kW	2.5	3.2	4.0
Power consumption (50/60Hz)	Cooling	kW	0.05/0.06		0.07/0.09
	Heating	kW	0.05/0.06		0.07/0.09
Current	Cooling	A	0.24/0.28		0.32/0.42
	Heating	A	0.24/0.28		0.32/0.42
External finish			Galvanizing		
Dimension	Height	mm	225		
	Width	mm	720		
	Depth	mm	550		
Net weight		kg	18		
Heat exchanger			Cross fin (Aluminum plate fin and copper tube)		
Fan	Type		Sirocco fanX 1		
	Airflow rate (Lo-Mid-Hi)		m ³ /min	4.8-5.8-7.9	4.8-5.8-9.5
	External static pressure		Pa	5	
Motor	Type		Single phase induction motor		
	Output		kW	0.023	0.032
Air filter			PP Honeycomb fabric (washable)		
Refrigerant pipe dimension	Gas (Brazing)	mm	ø 12.7		
	Liquid (Brazing)	mm	ø 6.35		
Drain pipe dimension			R1 (External thread)		
Noise level (Lo-Mid-Hi) *5			dB(A)		29-33-36
			30-35-40		

				PEFY-P40VMH-A	PEFY-P50VMH-A	PEFY-P63VMH-A	PEFY-P71VMH-A
Power source				~ 220-240V 50Hz /60Hz			
Cooling capacity	*1	kW	4.5	5.6	7.1	8.0	
	*2	kcal/h	4,000	5,000	6,300	7,100	
Heating capacity	*1	kW	5.0	6.3	8.0	9.0	
Power consumption (50/60Hz)	Cooling	kW	0.19/0.23		0.24/0.30	0.26/0.33	
	Heating	kW	0.19/0.23		0.24/0.30	0.26/0.33	
Current	Cooling	A	0.88/1.06		1.12/1.38	1.20/1.51	
	Heating	A	0.88/1.06		1.12/1.38	1.20/1.51	
External finish				Galvanizing			
Dimension	Height	mm	380				
	Width	mm	750		1000		
	Depth	mm	900				
Net weight		kg	44	45	50		
Heat exchanger				Cross fin (Aluminum plate fin and copper tube)			
Fan	Type			Sirocco fanX 1			
	Airflow rate (Lo-Hi)			m ³ /min	10.0-14.0	13.5-19.0	15.5-22.0
	External static pressure *3	220V	Pa	50/100/200			
230, 240V		Pa	100/150/200				
Motor	Type			Single phase induction motor			
	Output *4			kW	0.08	0.12	0.14
Air filter (option)				Synthetic fiber unwoven cloth filter(long life)			
Refrigerant pipe dimension	Gas (Flare)	mm	ø 12.7	ø 15.88			
	Liquid (Flare)	mm	ø 6.35	ø 9.52			
Drain pipe dimension				32 (1-1/4 inch)			
Noise level (Lo-Hi) *5	220V	dB(A)	27-34		32-38	32-39	
	230, 240V	dB(A)	31-37		36-41	35-41	

Note: *1 Cooling/Heating capacity indicates the maximum value at operation under the following condition.
Cooling : Indoor 27°CDB/19°CWB, Outdoor 35°CDB
Heating : Indoor 20°CDB, Outdoor 7°CDB/6°CWB

*2 Cooling capacity indicates the maximum value at operation under the following condition.
Cooling : Indoor 27°CDB/19.5°CWB, Outdoor 35°CDB (WR2: water 30°C)

*3 The external static pressure is set to 100Pa (at 220V) /150Pa (at 230, 240V) at factory shipment.

*4 The value are that at 240V.

*5 It is measured in anechoic room.

			PEFY-P80VMH-A	PEFY-P100VMH-A	PEFY-P125VMH-A	PEFY-P140VMH-A	
Power source			~ 220-240V 50Hz /60Hz				
Cooling capacity	*1	kW	9.0	11.2	14.0	16.0	
	*2	kcal/h	8,000	10,000	12,500	14,000	
Heating capacity	*1	kW	10.0	12.5	16.0	18.0	
Power consumption (50/60Hz)	Cooling	kW	0.32/0.40	0.48/0.58		0.48/0.59	
	Heating	kW	0.32/0.40	0.48/0.58		0.48/0.59	
Current	Cooling	A	1.47/1.83	2.34/2.66		2.35/2.70	
	Heating	A	1.47/1.83	2.34/2.66		2.35/2.70	
External finish			Galvanizing				
Dimension	Height	mm	380				
	Width	mm	1000	1200			
	Depth	mm	900				
Net weight		kg	50	70			
Heat exchanger			Cross fin (Aluminum plate fin and copper tube)				
Fan	Type		Sirocco fanX 1	Sirocco fanX 2			
	Airflow rate (Lo-Hi)		m ³ /min	18.0-25.0	26.5-38.0		28.0-40.0
	External static pressure *3	220V	Pa	50/100/200			
230, 240V		Pa	100/150/200				
Motor	Type		Single phase induction motor				
	Output	*4 kW	0.18	0.26			
Air filter (option)			Synthetic fiber unwoven cloth filter(long life)				
Refrigerant pipe dimension	Gas (Flare)	mm	ø 15.88	ø 19.05			
	Liquid (Flare)	mm	ø 9.52				
Drain pipe dimension			32 (1-1/4 inch)				
Noise level (Lo-Hi) *7	220V	dB(A)	35-41	34-42			
	230, 240V	dB(A)	38-43	38-44			

			PEFY-P200VMH-A	PEFY-P250VMH-A	
Power source			3N ~ 380-415V 50Hz / 60Hz		
Cooling capacity	*1	kW	22.4	28.0	
	*2	kcal/h	20,000	25,000	
Heating capacity	*1	kW	25.0	31.5	
Power consumption (50/60Hz)	Cooling	kW	0.99/1.14	1.23/1.41	
	Heating	kW	0.99/1.14	1.23/1.41	
Current	Cooling	A	1.62/1.86	2.0/2.3	
	Heating	A	1.62/1.86	2.0/2.3	
External finish			Galvanizing		
Dimension	Height	mm	470		
	Width	mm	1250		
	Depth	mm	1120		
Net weight		kg	100		
Heat exchanger			Cross fin (Aluminum plate fin and copper tube)		
Fan	Type		Sirocco fanX 2		
	Airflow rate		m ³ /min	58.0	72.0
	External static pressure *5	380V	Pa	110/220	
400, 415V		Pa	130/260		
Motor	Type		3-phase induction motor		
	Output	*6 kW	0.76	1.08	
Air filter (option)			Synthetic fiber unwoven cloth filter(long life)		
Refrigerant pipe dimension	Gas (Brazing)	mm	ø 25.4	ø 28.58	
	Liquid (Brazing)	mm	ø 12.7		
Drain pipe dimension			32 (1-1/4 inch)		
Noise level *7	380V	dB(A)	42(110Pa)/45(220Pa)	50(110Pa)/52(220Pa)	
	400, 415V	dB(A)	44(130Pa)/47(260Pa)	52(130Pa)/54(260Pa)	

Note: *1 Cooling/Heating capacity indicates the maximum value at operation under the following condition.
Cooling : Indoor 27°CDB/19°CWB, Outdoor 35°CDB
Heating : Indoor 20°CDB, Outdoor 7°CDB/6°CWB
*2 Cooling capacity indicates the maximum value at operation under the following condition.
Cooling : Indoor 27°CDB/19.5°CWB, Outdoor 35°CDB (WR2: water 30°C)
*3 The external static pressure is set to 100Pa (at 220V) /150Pa (at 230, 240V) at factory shipment.
*4 The value are that at 240V.
*5 The external static pressure is set to 110Pa (at 380V) /130Pa (at 400, 415V) at factory shipment.
*6 The value are that at 415V.
*7 It is measured in anechoic room.

2. Capacity Tables

2-1.Cooling Capacity (In combination with PUMY)

CA :Capacity(kW)
SHC:Sensible Heat Capacity(kW)

PEFY-P-VML-A1,VMH-A

Unit size	Outdoor air temp.	Indoor air temp.							
		23°CDB 16°CWB		25°CDB 18°CWB		28°CDB 20°CWB		30°CDB 22°CWB	
		CA	SHC	CA	SHC	CA	SHC	CA	SHC
20 (2.2)	20.0	2.2	1.8	2.3	1.9	2.4	1.9	2.6	2.0
	22.5	2.1	1.8	2.3	1.9	2.4	1.9	2.6	2.0
	25.0	2.1	1.8	2.3	1.9	2.4	1.9	2.5	2.0
	27.5	2.1	1.8	2.2	1.9	2.4	1.9	2.5	2.0
	30.0	2.1	1.8	2.2	1.9	2.3	1.9	2.5	1.9
	32.5	2.0	1.8	2.2	1.9	2.3	1.9	2.5	1.9
	35.0	2.0	1.8	2.1	1.9	2.3	1.8	2.4	1.9
	37.5	2.0	1.8	2.1	1.9	2.2	1.8	2.4	1.9
	40.0	2.0	1.7	2.1	1.8	2.2	1.8	2.4	1.9
46.0	1.9	1.7	2.0	1.8	2.1	1.8	2.3	1.9	
25 (2.8)	20.0	2.8	2.2	2.9	2.3	3.1	2.3	3.3	2.3
	22.5	2.7	2.2	2.9	2.3	3.1	2.2	3.2	2.3
	25.0	2.7	2.1	2.9	2.3	3.1	2.2	3.2	2.3
	27.5	2.7	2.1	2.8	2.2	3.0	2.2	3.2	2.3
	30.0	2.6	2.1	2.8	2.2	3.0	2.2	3.2	2.3
	32.5	2.6	2.1	2.8	2.2	2.9	2.2	3.1	2.3
	35.0	2.6	2.1	2.7	2.2	2.9	2.2	3.1	2.3
	37.5	2.5	2.1	2.7	2.2	2.9	2.2	3.0	2.2
	40.0	2.5	2.0	2.7	2.2	2.8	2.1	3.0	2.2
46.0	2.4	2.0	2.6	2.1	2.7	2.1	2.9	2.2	
32 (3.6)	20.0	3.6	2.7	3.7	2.8	4.0	2.8	4.2	2.9
	22.5	3.5	2.7	3.7	2.8	4.0	2.8	4.2	2.9
	25.0	3.5	2.7	3.7	2.8	3.9	2.8	4.1	2.9
	27.5	3.4	2.7	3.6	2.8	3.9	2.8	4.1	2.8
	30.0	3.4	2.6	3.6	2.8	3.8	2.7	4.1	2.8
	32.5	3.3	2.6	3.6	2.7	3.8	2.7	4.0	2.8
	35.0	3.3	2.6	3.5	2.7	3.7	2.7	4.0	2.8
	37.5	3.2	2.6	3.5	2.7	3.7	2.7	3.9	2.8
	40.0	3.2	2.5	3.4	2.7	3.6	2.7	3.9	2.7
46.0	3.1	2.5	3.3	2.6	3.5	2.6	3.7	2.7	
40 (4.5)	20.0	4.5	3.3	4.7	3.5	5.0	3.5	5.3	3.6
	22.5	4.4	3.3	4.6	3.5	5.0	3.4	5.2	3.5
	25.0	4.3	3.3	4.6	3.4	4.9	3.4	5.2	3.5
	27.5	4.3	3.3	4.6	3.4	4.9	3.4	5.1	3.5
	30.0	4.2	3.2	4.5	3.4	4.8	3.4	5.1	3.5
	32.5	4.2	3.2	4.4	3.4	4.7	3.3	5.0	3.5
	35.0	4.1	3.2	4.4	3.3	4.7	3.3	5.0	3.4
	37.5	4.1	3.1	4.3	3.3	4.6	3.3	4.9	3.4
	40.0	4.0	3.1	4.3	3.3	4.5	3.3	4.8	3.4
46.0	3.8	3.0	4.1	3.2	4.3	3.2	4.6	3.3	
50 (5.6)	20.0	5.5	3.9	5.8	4.1	6.2	4.1	6.6	4.2
	22.5	5.5	3.9	5.8	4.1	6.2	4.0	6.5	4.1
	25.0	5.4	3.9	5.7	4.0	6.1	4.0	6.4	4.1
	27.5	5.3	3.8	5.7	4.0	6.0	4.0	6.4	4.1
	30.0	5.3	3.8	5.6	4.0	5.9	3.9	6.3	4.1
	32.5	5.2	3.7	5.5	3.9	5.9	3.9	6.2	4.0
	35.0	5.1	3.7	5.5	3.9	5.8	3.9	6.2	4.0
	37.5	5.0	3.7	5.4	3.9	5.7	3.8	6.1	4.0
	40.0	5.0	3.6	5.3	3.8	5.6	3.8	6.0	3.9
46.0	4.8	3.5	5.1	3.7	5.4	3.7	5.8	3.8	
63 (7.1)	20.0	7.0	5.2	7.4	5.4	7.9	5.3	8.3	5.5
	22.5	6.9	5.1	7.3	5.3	7.8	5.3	8.2	5.4
	25.0	6.9	5.1	7.3	5.3	7.7	5.3	8.2	5.4
	27.5	6.8	5.0	7.2	5.3	7.7	5.2	8.1	5.4
	30.0	6.7	5.0	7.1	5.2	7.5	5.2	8.0	5.3
	32.5	6.6	4.9	7.0	5.2	7.5	5.1	7.9	5.3
	35.0	6.5	4.9	6.9	5.1	7.3	5.1	7.8	5.3
	37.5	6.4	4.8	6.8	5.1	7.2	5.0	7.7	5.2
	40.0	6.3	4.8	6.7	5.1	7.2	5.0	7.6	5.2
46.0	6.1	4.7	6.5	4.9	6.9	4.9	7.3	5.1	

PEFY-P-VML-A1/VMH-A

Cooling Capacity (In combination with PUMY)

CA :Capacity(kW)
SHC:Sensible Heat Capacity(kW)

PEFY-P-VML-A1,VMH-A

Unit size	Outdoor air temp.	Indoor air temp.							
		23°CDB 16°CWB		25°CDB 18°CWB		28°CDB 20°CWB		30°CDB 22°CWB	
		°CDB	CA	SHC	CA	SHC	CA	SHC	CA
71 (8.0)	20.0	7.9	5.8	8.3	6.0	8.9	6.0	9.4	6.1
	22.5	7.8	5.7	8.2	6.0	8.8	5.9	9.3	6.1
	25.0	7.7	5.7	8.2	5.9	8.7	5.9	9.2	6.1
	27.5	7.6	5.6	8.1	5.9	8.6	5.8	9.1	6.0
	30.0	7.5	5.6	8.0	5.8	8.5	5.8	9.0	6.0
	32.5	7.4	5.5	7.9	5.8	8.4	5.7	8.9	5.9
	35.0	7.3	5.4	7.8	5.7	8.3	5.7	8.8	5.9
	37.5	7.2	5.4	7.7	5.7	8.2	5.6	8.7	5.8
	40.0	7.1	5.4	7.6	5.6	8.1	5.6	8.6	5.8
	46.0	6.8	5.2	7.3	5.5	7.7	5.4	8.2	5.6
80 (9.0)	20.0	8.9	6.5	9.4	6.8	10.0	6.8	10.6	6.9
	22.5	8.8	6.5	9.3	6.7	9.9	6.7	10.4	6.9
	25.0	8.7	6.4	9.2	6.7	9.8	6.7	10.4	6.8
	27.5	8.6	6.4	9.1	6.7	9.7	6.6	10.3	6.8
	30.0	8.5	6.3	9.0	6.6	9.5	6.5	10.2	6.8
	32.5	8.3	6.2	8.9	6.6	9.5	6.5	10.0	6.7
	35.0	8.2	6.2	8.8	6.5	9.3	6.4	9.9	6.6
	37.5	8.1	6.1	8.6	6.4	9.2	6.4	9.8	6.6
	40.0	8.0	6.1	8.6	6.4	9.1	6.3	9.6	6.5
	46.0	7.7	5.9	8.2	6.2	8.7	6.1	9.3	6.4
100 (11.2)	20.0	11.1	8.7	11.6	9.1	12.5	9.1	13.1	9.3
	22.5	10.9	8.7	11.5	9.1	12.3	9.0	13.0	9.3
	25.0	10.8	8.6	11.5	9.0	12.2	9.0	12.9	9.2
	27.5	10.7	8.5	11.3	9.0	12.1	8.9	12.8	9.2
	30.0	10.5	8.5	11.2	8.9	11.9	8.8	12.6	9.1
	32.5	10.4	8.4	11.1	8.8	11.8	8.8	12.5	9.1
	35.0	10.2	8.3	10.9	8.8	11.6	8.7	12.3	9.0
	37.5	10.1	8.3	10.8	8.7	11.4	8.6	12.2	9.0
	40.0	10.0	8.2	10.6	8.6	11.3	8.6	12.0	8.9
	46.0	9.6	8.0	10.2	8.5	10.8	8.4	11.5	8.7
125 (14.0)	20.0	13.9	10.1	14.6	10.5	15.6	10.5	16.4	10.8
	22.5	13.7	10.0	14.4	10.4	15.4	10.4	16.2	10.7
	25.0	13.5	9.9	14.3	10.4	15.3	10.3	16.1	10.6
	27.5	13.4	9.9	14.2	10.3	15.1	10.2	16.0	10.6
	30.0	13.2	9.8	14.0	10.2	14.9	10.1	15.8	10.5
	32.5	13.0	9.6	13.8	10.2	14.7	10.1	15.6	10.4
	35.0	12.8	9.6	13.7	10.1	14.5	10.0	15.4	10.3
	37.5	12.6	9.5	13.4	10.0	14.3	9.9	15.2	10.2
	40.0	12.5	9.4	13.3	9.9	14.1	9.8	15.0	10.1
	46.0	12.0	9.2	12.8	9.7	13.5	9.5	14.4	9.9

PEFY-P-VML-A1/VMH-A

2-2.Heating Capacity (In combination with PUMY)

PEFY-P-VML-A1,VMH-A

Unit size	Outdoor air temp. °CWB	Indoor air temp.:°CDB		
		15.0	20.0	25.0
		SHC	SHC	SHC
20	-12.0	1.6	1.6	1.5
	-10.0	1.7	1.6	1.6
	-5.0	1.9	1.9	1.9
	0.0	2.2	2.1	2.1
	2.5	2.3	2.3	2.3
	6.0	2.5	2.5	2.5
	7.5	2.6	2.6	2.5
	10.0	2.8	2.7	2.5
	12.5	2.9	2.8	2.5
15.5	3.1	2.8	2.5	
25	-12.0	2.0	2.0	2.0
	-10.0	2.1	2.1	2.1
	-5.0	2.4	2.4	2.4
	0.0	2.8	2.8	2.7
	2.5	3.0	2.9	2.9
	6.0	3.2	3.2	3.2
	7.5	3.3	3.3	3.2
	10.0	3.5	3.5	3.2
	12.5	3.7	3.5	3.2
15.5	3.9	3.5	3.2	
32	-12.0	2.5	2.5	2.5
	-10.0	2.7	2.6	2.6
	-5.0	3.1	3.0	3.0
	0.0	3.5	3.4	3.4
	2.5	3.7	3.7	3.6
	6.0	4.0	4.0	3.9
	7.5	4.2	4.1	4.0
	10.0	4.4	4.4	4.0
	12.5	4.7	4.4	4.0
15.5	4.9	4.4	4.0	
40	-12.0	3.2	3.1	3.1
	-10.0	3.4	3.3	3.2
	-5.0	3.8	3.8	3.7
	0.0	4.3	4.3	4.2
	2.5	4.6	4.6	4.5
	6.0	5.0	5.0	4.9
	7.5	5.2	5.2	5.0
	10.0	5.5	5.5	5.0
	12.5	5.9	5.5	5.0
15.5	6.2	5.5	5.0	
50	-12.0	4.0	3.9	3.9
	-10.0	4.2	4.2	4.1
	-5.0	4.8	4.8	4.7
	0.0	5.5	5.4	5.3
	2.5	5.8	5.8	5.7
	6.0	6.3	6.3	6.2
	7.5	6.6	6.5	6.2
	10.0	7.0	6.9	6.2
	12.5	7.4	7.0	6.2
15.5	7.7	7.0	6.2	
63	-12.0	5.1	5.0	4.9
	-10.0	5.4	5.3	5.2
	-5.0	6.1	6.0	5.9
	0.0	6.9	6.9	6.8
	2.5	7.4	7.3	7.2
	6.0	8.0	8.0	7.9
	7.5	8.3	8.3	7.9
	10.0	8.8	8.8	7.9
	12.5	9.4	8.8	7.9
15.5	9.8	8.8	7.9	

SHC:Sensible Heat Capacity(kW)

Unit size	Outdoor air temp. °CWB	Indoor air temp.:°CDB		
		15.0	20.0	25.0
		SHC	SHC	SHC
71	-12.0	5.7	5.6	5.5
	-10.0	6.0	5.9	5.8
	-5.0	6.9	6.8	6.7
	0.0	7.8	7.7	7.6
	2.5	8.3	8.2	8.1
	6.0	9.1	9.0	8.9
	7.5	9.4	9.3	8.9
	10.0	9.9	9.9	8.9
	12.5	10.5	9.9	8.9
15.5	11.1	9.9	8.9	
80	-12.0	6.4	6.2	6.1
	-10.0	6.7	6.6	6.5
	-5.0	7.6	7.5	7.4
	0.0	8.7	8.6	8.5
	2.5	9.2	9.2	9.0
	6.0	10.1	10.0	9.9
	7.5	10.4	10.4	9.9
	10.0	11.1	11.0	9.9
	12.5	11.7	11.0	9.9
15.5	12.3	11.0	9.9	
100	-12.0	8.0	7.8	7.7
	-10.0	8.4	8.2	8.1
	-5.0	9.6	9.4	9.3
	0.0	10.9	10.7	10.6
	2.5	11.5	11.4	11.3
	6.0	12.6	12.5	12.3
	7.5	13.0	12.9	12.4
	10.0	13.8	13.7	12.4
	12.5	14.6	13.8	12.4
15.5	15.4	13.8	12.4	
125	-12.0	10.2	10.0	9.8
	-10.0	10.7	10.6	10.4
	-5.0	12.2	12.1	11.9
	0.0	13.9	13.8	13.6
	2.5	14.8	14.7	14.5
	6.0	16.1	16.0	15.8
	7.5	16.7	16.6	15.8
	10.0	17.7	17.6	15.8
	12.5	18.7	17.7	15.8
15.5	19.7	17.7	15.8	

2-3.Cooling Capacity (In combination with PU(H)Y,PURY-(P)200-250-315YEM-A, TEM-A)

PEFY-P-VML-A1,VMH-A

CA :Capacity(kW)
SHC:Sensible Heat Capacity(kW)

Unit size	Outdoor air temp.	Indoor air temp.													
		21.5°CDB 15°CWB		23°CDB 16°CWB		25°CDB 18°CWB		27°CDB 19°CWB		28°CDB 20°CWB		30°CDB 22°CWB		32°CDB 24°CWB	
		CA	SHC	CA	SHC	CA	SHC	CA	SHC	CA	SHC	CA	SHC	CA	SHC
20 (2.2)	20.0	2.2	1.8	2.2	1.9	2.3	1.9	2.3	1.9	2.4	2.0	2.5	1.9	2.6	1.9
	22.5	2.1	1.8	2.2	1.9	2.3	1.8	2.3	1.9	2.4	1.9	2.4	1.9	2.5	1.9
	25.0	2.1	1.8	2.2	1.9	2.2	1.8	2.3	1.9	2.3	1.9	2.4	1.9	2.5	1.9
	27.5	2.1	1.8	2.1	1.9	2.2	1.8	2.3	1.9	2.3	1.9	2.4	1.9	2.5	1.8
	30.0	2.1	1.8	2.1	1.9	2.2	1.8	2.2	1.9	2.3	1.9	2.4	1.9	2.5	1.8
	32.5	2.0	1.8	2.1	1.8	2.2	1.8	2.2	1.8	2.3	1.9	2.4	1.9	2.4	1.8
	35.0	2.0	1.8	2.1	1.8	2.2	1.8	2.2	1.8	2.2	1.9	2.3	1.9	2.4	1.8
	37.5	2.0	1.8	2.0	1.8	2.1	1.8	2.2	1.8	2.2	1.9	2.3	1.9	2.4	1.8
	40.0	2.0	1.8	2.0	1.8	2.1	1.8	2.2	1.8	2.2	1.9	2.3	1.8	2.4	1.8
43.0	2.0	1.7	2.0	1.8	2.1	1.8	2.1	1.8	2.2	1.9	2.3	1.8	2.3	1.8	
25 (2.8)	20.0	2.7	2.2	2.8	2.2	2.9	2.2	3.0	2.2	3.0	2.3	3.1	2.2	3.2	2.2
	22.5	2.7	2.2	2.8	2.2	2.9	2.2	2.9	2.2	3.0	2.3	3.1	2.2	3.2	2.2
	25.0	2.7	2.1	2.7	2.2	2.9	2.2	2.9	2.2	3.0	2.3	3.1	2.2	3.2	2.1
	27.5	2.7	2.1	2.7	2.2	2.8	2.1	2.9	2.2	2.9	2.2	3.1	2.2	3.2	2.1
	30.0	2.6	2.1	2.7	2.2	2.8	2.1	2.9	2.2	2.9	2.2	3.0	2.2	3.1	2.1
	32.5	2.6	2.1	2.7	2.2	2.8	2.1	2.8	2.1	2.9	2.2	3.0	2.2	3.1	2.1
	35.0	2.6	2.1	2.6	2.1	2.7	2.1	2.8	2.1	2.9	2.2	3.0	2.2	3.1	2.1
	37.5	2.5	2.1	2.6	2.1	2.7	2.1	2.8	2.1	2.8	2.2	2.9	2.2	3.1	2.1
	40.0	2.5	2.1	2.6	2.1	2.7	2.1	2.7	2.1	2.8	2.2	2.9	2.1	3.0	2.1
43.0	2.5	2.0	2.5	2.1	2.7	2.1	2.7	2.1	2.8	2.2	2.9	2.1	3.0	2.1	
32 (3.6)	20.0	3.5	2.7	3.6	2.8	3.7	2.7	3.8	2.7	3.9	2.8	4.0	2.7	4.2	2.7
	22.5	3.5	2.7	3.6	2.7	3.7	2.7	3.8	2.7	3.9	2.8	4.0	2.7	4.1	2.7
	25.0	3.5	2.7	3.5	2.7	3.7	2.7	3.7	2.7	3.8	2.8	4.0	2.7	4.1	2.6
	27.5	3.4	2.6	3.5	2.7	3.6	2.7	3.7	2.7	3.8	2.8	3.9	2.7	4.1	2.6
	30.0	3.4	2.6	3.5	2.7	3.6	2.6	3.7	2.7	3.7	2.8	3.9	2.7	4.0	2.6
	32.5	3.3	2.6	3.4	2.7	3.6	2.6	3.6	2.7	3.7	2.7	3.9	2.7	4.0	2.6
	35.0	3.3	2.6	3.4	2.7	3.5	2.6	3.6	2.6	3.7	2.7	3.8	2.7	4.0	2.6
	37.5	3.3	2.6	3.3	2.6	3.5	2.6	3.6	2.6	3.6	2.7	3.8	2.7	3.9	2.6
	40.0	3.2	2.6	3.3	2.6	3.5	2.6	3.5	2.6	3.6	2.7	3.7	2.6	3.9	2.6
43.0	3.2	2.5	3.3	2.6	3.4	2.6	3.5	2.6	3.6	2.7	3.7	2.6	3.8	2.6	
40 (4.5)	20.0	4.4	3.3	4.5	3.4	4.7	3.3	4.8	3.4	4.9	3.5	5.0	3.4	5.2	3.3
	22.5	4.4	3.3	4.5	3.4	4.6	3.3	4.7	3.3	4.8	3.4	5.0	3.4	5.2	3.3
	25.0	4.3	3.3	4.4	3.4	4.6	3.3	4.7	3.3	4.8	3.4	5.0	3.3	5.1	3.2
	27.5	4.3	3.3	4.4	3.3	4.5	3.3	4.6	3.3	4.7	3.4	4.9	3.3	5.1	3.2
	30.0	4.2	3.2	4.3	3.3	4.5	3.2	4.6	3.3	4.7	3.4	4.9	3.3	5.0	3.2
	32.5	4.2	3.2	4.3	3.3	4.5	3.2	4.5	3.3	4.6	3.4	4.8	3.3	5.0	3.2
	35.0	4.1	3.2	4.2	3.3	4.4	3.2	4.5	3.2	4.6	3.3	4.8	3.3	5.0	3.2
	37.5	4.1	3.2	4.2	3.2	4.4	3.2	4.5	3.2	4.5	3.3	4.7	3.3	4.9	3.2
	40.0	4.1	3.1	4.1	3.2	4.3	3.2	4.4	3.2	4.5	3.3	4.7	3.2	4.9	3.2
43.0	4.0	3.1	4.1	3.2	4.3	3.1	4.4	3.2	4.4	3.3	4.6	3.2	4.8	3.1	
50 (5.6)	20.0	5.5	3.9	5.6	4.0	5.8	3.9	5.9	3.9	6.0	4.0	6.3	3.9	6.5	3.8
	22.5	5.4	3.9	5.5	3.9	5.8	3.9	5.9	3.9	6.0	4.0	6.2	3.9	6.4	3.8
	25.0	5.4	3.8	5.5	3.9	5.7	3.8	5.8	3.8	5.9	4.0	6.2	3.8	6.4	3.7
	27.5	5.3	3.8	5.4	3.9	5.7	3.8	5.8	3.8	5.9	3.9	6.1	3.8	6.3	3.7
	30.0	5.3	3.8	5.4	3.9	5.6	3.8	5.7	3.8	5.8	3.9	6.0	3.8	6.3	3.7
	32.5	5.2	3.8	5.3	3.8	5.5	3.7	5.7	3.8	5.8	3.9	6.0	3.8	6.2	3.7
	35.0	5.2	3.7	5.3	3.8	5.5	3.7	5.6	3.7	5.7	3.9	5.9	3.8	6.2	3.7
	37.5	5.1	3.7	5.2	3.8	5.4	3.7	5.5	3.7	5.7	3.8	5.9	3.7	6.1	3.6
	40.0	5.0	3.7	5.2	3.8	5.4	3.7	5.5	3.7	5.6	3.8	5.8	3.7	6.0	3.6
43.0	5.0	3.6	5.1	3.7	5.3	3.6	5.4	3.7	5.5	3.8	5.8	3.7	6.0	3.6	
63 (7.1)	20.0	7.0	5.1	7.1	5.2	7.4	5.1	7.5	5.1	7.7	5.3	8.0	5.2	8.2	5.0
	22.5	6.9	5.1	7.0	5.2	7.3	5.1	7.5	5.1	7.6	5.3	7.9	5.1	8.2	5.0
	25.0	6.8	5.0	7.0	5.2	7.2	5.0	7.4	5.1	7.5	5.2	7.8	5.1	8.1	5.0
	27.5	6.7	5.0	6.9	5.1	7.2	5.0	7.3	5.1	7.5	5.2	7.7	5.1	8.0	4.9
	30.0	6.7	5.0	6.8	5.1	7.1	5.0	7.2	5.0	7.4	5.2	7.7	5.0	8.0	4.9
	32.5	6.6	4.9	6.7	5.1	7.0	4.9	7.2	5.0	7.3	5.2	7.6	5.0	7.9	4.9
	35.0	6.5	4.9	6.7	5.0	7.0	4.9	7.1	5.0	7.2	5.1	7.5	5.0	7.8	4.9
	37.5	6.5	4.9	6.6	5.0	6.9	4.9	7.0	4.9	7.2	5.1	7.5	5.0	7.7	4.8
	40.0	6.4	4.8	6.5	5.0	6.8	4.9	7.0	4.9	7.1	5.1	7.4	4.9	7.7	4.8
43.0	6.3	4.8	6.4	4.9	6.7	4.8	6.9	4.9	7.0	5.0	7.3	4.9	7.6	4.8	

PEFY-P-VML-A1/VMH-A

Cooling Capacity (In combination with PU(H)Y,PURY-(P)200-250-315YEM-A, TEM-A)

PEFY-P-VML-A1,VMH-A

CA :Capacity(kW)
SHC:Sensible Heat Capacity(kW)

Unit size	Outdoor air temp.	Indoor air temp.													
		21.5°CDB 15°CWB		23°CDB 16°CWB		25°CDB 18°CWB		27°CDB 19°CWB		28°CDB 20°CWB		30°CDB 22°CWB		32°CDB 24°CWB	
		°CDB	CA	SHC	CA	SHC	CA	SHC	CA	SHC	CA	SHC	CA	SHC	CA
71 (8.0)	20.0	7.8	5.7	8.0	5.8	8.3	5.7	8.5	5.7	8.6	5.9	9.0	5.8	9.3	5.6
	22.5	7.8	5.7	7.9	5.8	8.2	5.7	8.4	5.7	8.6	5.9	8.9	5.7	9.2	5.6
	25.0	7.7	5.6	7.8	5.8	8.2	5.6	8.3	5.7	8.5	5.8	8.8	5.7	9.1	5.5
	27.5	7.6	5.6	7.8	5.7	8.1	5.6	8.2	5.6	8.4	5.8	8.7	5.7	9.0	5.5
	30.0	7.5	5.6	7.7	5.7	8.0	5.6	8.2	5.6	8.3	5.8	8.6	5.6	9.0	5.5
	32.5	7.4	5.5	7.6	5.6	7.9	5.5	8.1	5.6	8.2	5.7	8.6	5.6	8.9	5.4
	35.0	7.4	5.5	7.5	5.6	7.8	5.5	8.0	5.5	8.2	5.7	8.5	5.6	8.8	5.4
	37.5	7.3	5.4	7.4	5.6	7.8	5.5	7.9	5.5	8.1	5.7	8.4	5.5	8.7	5.4
	40.0	7.2	5.4	7.4	5.5	7.7	5.4	7.8	5.5	8.0	5.6	8.3	5.5	8.6	5.4
43.0	7.1	5.4	7.3	5.5	7.6	5.4	7.7	5.4	7.9	5.6	8.2	5.5	8.5	5.3	
80 (9.0)	20.0	8.8	6.5	9.0	6.6	9.4	6.5	9.5	6.5	9.7	6.7	10.1	6.5	10.4	6.3
	22.5	8.7	6.4	8.9	6.6	9.3	6.4	9.5	6.5	9.6	6.7	10.0	6.5	10.4	6.3
	25.0	8.6	6.4	8.8	6.5	9.2	6.4	9.4	6.4	9.5	6.6	9.9	6.4	10.3	6.3
	27.5	8.6	6.3	8.7	6.5	9.1	6.3	9.3	6.4	9.5	6.6	9.8	6.4	10.2	6.2
	30.0	8.5	6.3	8.6	6.4	9.0	6.3	9.2	6.3	9.4	6.5	9.7	6.4	10.1	6.2
	32.5	8.4	6.2	8.6	6.4	8.9	6.2	9.1	6.3	9.3	6.5	9.6	6.3	10.0	6.2
	35.0	8.3	6.2	8.5	6.3	8.8	6.2	9.0	6.3	9.2	6.5	9.5	6.3	9.9	6.1
	37.5	8.2	6.2	8.4	6.3	8.7	6.2	8.9	6.2	9.1	6.4	9.5	6.3	9.8	6.1
	40.0	8.1	6.1	8.3	6.3	8.6	6.1	8.8	6.2	9.0	6.4	9.4	6.2	9.7	6.1
43.0	8.0	6.1	8.2	6.2	8.5	6.1	8.7	6.1	8.9	6.3	9.3	6.2	9.6	6.0	
100 (11.2)	20.0	11.0	8.7	11.2	8.9	11.6	8.7	11.9	8.8	12.1	9.1	12.5	8.9	13.0	8.7
	22.5	10.9	8.6	11.1	8.9	11.5	8.7	11.8	8.8	12.0	9.1	12.4	8.9	12.9	8.6
	25.0	10.8	8.6	11.0	8.8	11.4	8.6	11.6	8.7	11.9	9.0	12.3	8.8	12.8	8.6
	27.5	10.6	8.5	10.9	8.8	11.3	8.6	11.5	8.7	11.8	9.0	12.2	8.8	12.7	8.6
	30.0	10.5	8.5	10.8	8.7	11.2	8.5	11.4	8.6	11.6	9.0	12.1	8.7	12.5	8.5
	32.5	10.4	8.4	10.6	8.6	11.1	8.5	11.3	8.6	11.5	8.9	12.0	8.7	12.4	8.5
	35.0	10.3	8.4	10.5	8.6	11.0	8.4	11.2	8.6	11.4	8.9	11.9	8.7	12.3	8.5
	37.5	10.2	8.3	10.4	8.5	10.9	8.4	11.1	8.5	11.3	8.8	11.8	8.6	12.2	8.4
	40.0	10.1	8.3	10.3	8.5	10.8	8.3	11.0	8.5	11.2	8.8	11.6	8.6	12.1	8.4
43.0	9.9	8.2	10.2	8.4	10.6	8.3	10.8	8.4	11.1	8.7	11.5	8.5	12.0	8.3	
125 (14.0)	20.0	13.7	10.0	14.0	10.2	14.6	10.0	14.8	10.1	15.1	10.4	15.7	10.1	16.2	9.8
	22.5	13.6	10.0	13.9	10.2	14.4	9.9	14.7	10.0	15.0	10.3	15.5	10.0	16.1	9.8
	25.0	13.4	9.9	13.7	10.1	14.3	9.9	14.6	10.0	14.8	10.3	15.4	10.0	16.0	9.7
	27.5	13.3	9.8	13.6	10.0	14.1	9.8	14.4	9.9	14.7	10.2	15.3	9.9	15.8	9.7
	30.0	13.2	9.8	13.4	10.0	14.0	9.8	14.3	9.8	14.6	10.1	15.1	9.9	15.7	9.6
	32.5	13.0	9.7	13.3	9.9	13.9	9.7	14.1	9.8	14.4	10.1	15.0	9.8	15.5	9.6
	35.0	12.9	9.6	13.2	9.8	13.7	9.6	14.0	9.7	14.3	10.0	14.8	9.8	15.4	9.5
	37.5	12.7	9.5	13.0	9.8	13.6	9.6	13.9	9.7	14.1	10.0	14.7	9.7	15.3	9.5
	40.0	12.6	9.5	12.9	9.7	13.4	9.5	13.7	9.6	14.0	9.9	14.6	9.7	15.1	9.4
43.0	12.4	9.4	12.7	9.6	13.3	9.4	13.6	9.5	13.8	9.8	14.4	9.6	15.0	9.4	
140 (16.0)	20.0	15.7	11.5	16.0	11.7	16.6	11.4	17.0	11.5	17.3	11.9	17.9	11.5	18.6	11.2
	22.5	15.5	11.4	15.8	11.6	16.5	11.4	16.8	11.4	17.1	11.8	17.8	11.5	18.4	11.2
	25.0	15.4	11.3	15.7	11.6	16.3	11.3	16.6	11.4	17.0	11.7	17.6	11.4	18.2	11.1
	27.5	15.2	11.2	15.5	11.5	16.2	11.2	16.5	11.3	16.8	11.7	17.4	11.4	18.1	11.0
	30.0	15.0	11.1	15.4	11.4	16.0	11.2	16.3	11.2	16.6	11.6	17.3	11.3	17.9	11.0
	32.5	14.9	11.1	15.2	11.3	15.8	11.1	16.2	11.2	16.5	11.5	17.1	11.2	17.8	10.9
	35.0	14.7	11.0	15.0	11.2	15.7	11.0	16.0	11.1	16.3	11.5	17.0	11.2	17.6	10.9
	37.5	14.6	10.9	14.9	11.2	15.5	10.9	15.8	11.0	16.2	11.4	16.8	11.1	17.4	10.8
	40.0	14.4	10.8	14.7	11.1	15.4	10.9	15.7	11.0	16.0	11.3	16.6	11.1	17.3	10.8
43.0	14.2	10.7	14.5	11.0	15.2	10.8	15.5	10.9	15.8	11.3	16.4	11.0	17.1	10.7	
200 (22.4)	20.0	22.0	16.4	22.4	16.8	23.3	16.4	23.7	16.5	24.2	17.1	25.1	16.6	26.0	16.2
	22.5	21.7	16.3	22.2	16.7	23.1	16.3	23.5	16.5	24.0	17.0	24.9	16.5	25.8	16.1
	25.0	21.5	16.2	22.0	16.6	22.8	16.2	23.3	16.4	23.7	16.9	24.6	16.5	25.5	16.0
	27.5	21.3	16.1	21.7	16.5	22.6	16.1	23.1	16.3	23.5	16.8	24.4	16.4	25.3	15.9
	30.0	21.1	16.0	21.5	16.4	22.4	16.0	22.8	16.2	23.3	16.7	24.2	16.3	25.1	15.9
	32.5	20.8	15.9	21.3	16.3	22.2	15.9	22.6	16.1	23.1	16.6	24.0	16.2	24.9	15.8
	35.0	20.6	15.8	21.1	16.1	22.0	15.8	22.4	16.0	22.8	16.5	23.7	16.1	24.6	15.7
	37.5	20.4	15.6	20.8	16.0	21.7	15.7	22.2	15.9	22.6	16.4	23.5	16.0	24.4	15.6
	40.0	20.2	15.5	20.6	15.9	21.5	15.6	22.0	15.8	22.4	16.3	23.3	16.0	24.2	15.5
43.0	19.9	15.4	20.3	15.8	21.2	15.5	21.7	15.7	22.1	16.2	23.0	15.9	23.9	15.5	
250 (28.0)	20.0	27.4	20.4	28.0	20.9	29.1	20.4	29.7	20.6	30.2	21.2	31.4	20.7	32.5	20.1
	22.5	27.2	20.3	27.7	20.7	28.8	20.3	29.4	20.4	30.0	21.1	31.1	20.5	32.2	20.0
	25.0	26.9	20.1	27.4	20.6	28.6	20.1	29.1	20.3	29.7	21.0	30.8	20.4	31.9	19.9
	27.5	26.6	20.0	27.2	20.5	28.3	20.0	28.8	20.2	29.4	20.9	30.5	20.3	31.6	19.8
	30.0	26.3	19.9	26.9	20.3	28.0	19.9	28.6	20.1	29.1	20.7	30.2	20.2	31.4	19.7
	32.5	26.0	19.7	26.6	20.2	27.7	19.8	28.3	20.0	28.8	20.6	30.0	20.1	31.1	19.6
	35.0	25.8	19.6	26.3	20.1	27.4	19.6	28.0	19.9	28.6	20.5	29.7	20.0	30.8	19.5
	37.5	25.5	19.4	26.0	19.9	27.2	19.5	27.7	19.7	28.3	20.4	29.4	19.9	30.5	19.4
	40.0	25.2	19.3	25.8	19.8	26.9	19.4	27.4	19.6	28.0	20.3	29.1	19.8	30.2	19.3
43.0	24.9	19.2	25.4	19.6	26.5	19.3	27.1	19.5	27.7	20.1	28.8	19.7	29.9	19.2	

2-4.Heating Capacity (In combination with PU(H)Y,PURY-(P)200-250-315YEM-A, TEM-A)

PEFY-P-VML-A1,VMH-A

SHC:Sensible Heat Capacity(kW)

Unit size	Outdoor air temp. °CWB	Indoor air temp.:°CDB			
		15.0	20.0	25.0	27.0
		SHC	SHC	SHC	SHC
20	-15.0	1.7	1.6	1.6	1.6
	-10.0	1.9	1.9	1.9	1.7
	-5.0	2.1	2.1	2.0	1.7
	0.0	2.4	2.4	2.0	1.7
	2.5	2.5	2.5	2.0	1.7
	6.0	2.5	2.5	2.0	1.7
	7.5	2.6	2.5	2.0	1.7
	10.0	2.8	2.5	2.0	1.7
	12.5	3.0	2.5	2.0	1.7
15.5	3.0	2.5	2.0	1.7	
25	-15.0	2.1	2.1	2.1	2.1
	-10.0	2.4	2.4	2.4	2.2
	-5.0	2.7	2.7	2.5	2.2
	0.0	3.1	3.0	2.5	2.2
	2.5	3.2	3.2	2.5	2.2
	6.0	3.2	3.2	2.5	2.2
	7.5	3.4	3.2	2.5	2.2
	10.0	3.6	3.2	2.5	2.2
	12.5	3.8	3.2	2.5	2.2
15.5	3.9	3.2	2.5	2.2	
32	-15.0	2.7	2.6	2.6	2.6
	-10.0	3.1	3.0	3.0	2.8
	-5.0	3.4	3.4	3.1	2.8
	0.0	3.8	3.8	3.1	2.8
	2.5	4.0	4.0	3.1	2.8
	6.0	4.0	4.0	3.1	2.8
	7.5	4.2	4.0	3.1	2.8
	10.0	4.5	4.0	3.1	2.8
	12.5	4.8	4.0	3.1	2.8
15.5	4.8	4.0	3.1	2.8	
40	-15.0	3.3	3.3	3.3	3.3
	-10.0	3.8	3.8	3.7	3.5
	-5.0	4.3	4.2	3.9	3.5
	0.0	4.8	4.7	3.9	3.5
	2.5	5.0	5.0	3.9	3.5
	6.0	5.1	5.0	3.9	3.5
	7.5	5.3	5.0	3.9	3.5
	10.0	5.6	5.0	3.9	3.5
	12.5	6.0	5.0	3.9	3.5
15.5	6.1	5.0	3.9	3.5	
50	-15.0	4.2	4.2	4.1	4.1
	-10.0	4.8	4.8	4.7	4.3
	-5.0	5.4	5.3	4.9	4.3
	0.0	6.0	5.9	4.9	4.3
	2.5	6.3	6.2	4.9	4.3
	6.0	6.4	6.3	4.9	4.3
	7.5	6.6	6.3	4.9	4.3
	10.0	7.1	6.3	4.9	4.3
	12.5	7.5	6.3	4.9	4.3
15.5	7.6	6.3	4.9	4.3	
63	-15.0	5.4	5.3	5.2	5.2
	-10.0	6.1	6.0	6.0	5.5
	-5.0	6.9	6.8	6.2	5.5
	0.0	7.6	7.5	6.2	5.5
	2.5	8.0	7.9	6.2	5.5
	6.0	8.1	8.0	6.2	5.5
	7.5	8.4	8.0	6.2	5.5
	10.0	9.0	8.0	6.2	5.5
	12.5	9.6	8.0	6.2	5.5
15.5	9.7	8.0	6.2	5.5	

Unit size	Outdoor air temp. °CWB	Indoor air temp.:°CDB			
		15.0	20.0	25.0	27.0
		SHC	SHC	SHC	SHC
71	-15.0	6.0	5.9	5.9	5.9
	-10.0	6.9	6.8	6.7	6.2
	-5.0	7.7	7.6	7.0	6.2
	0.0	8.6	8.5	7.0	6.2
	2.5	9.0	8.9	7.0	6.2
	6.0	9.1	9.0	7.0	6.2
	7.5	9.5	9.0	7.0	6.2
	10.0	10.1	9.0	7.0	6.2
	12.5	10.8	9.0	7.0	6.2
15.5	10.9	9.0	7.0	6.2	
80	-15.0	6.7	6.6	6.5	6.5
	-10.0	7.6	7.5	7.4	6.9
	-5.0	8.6	8.5	7.8	6.9
	0.0	9.5	9.4	7.8	6.9
	2.5	10.0	9.9	7.8	6.9
	6.0	10.1	10.0	7.8	6.9
	7.5	10.5	10.0	7.8	6.9
	10.0	11.2	10.0	7.8	6.9
	12.5	12.0	10.0	7.8	6.9
15.5	12.1	10.0	7.8	6.9	
100	-15.0	8.4	8.2	8.2	8.1
	-10.0	9.6	9.4	9.3	8.6
	-5.0	10.7	10.6	9.8	8.6
	0.0	11.9	11.8	9.8	8.6
	2.5	12.5	12.4	9.8	8.6
	6.0	12.6	12.5	9.8	8.6
	7.5	13.2	12.5	9.8	8.6
	10.0	14.1	12.5	9.8	8.6
	12.5	15.0	12.5	9.8	8.6
15.5	15.1	12.5	9.8	8.6	
125	-15.0	10.7	10.6	10.5	10.4
	-10.0	12.2	12.1	11.9	11.0
	-5.0	13.7	13.6	12.5	11.0
	0.0	15.3	15.1	12.5	11.0
	2.5	16.0	15.8	12.5	11.0
	6.0	16.2	16.0	12.5	11.0
	7.5	16.8	16.0	12.5	11.0
	10.0	18.0	16.0	12.5	11.0
	12.5	19.1	16.0	12.5	11.0
15.5	19.4	16.0	12.5	11.0	
140	-15.0	12.1	11.9	11.8	11.7
	-10.0	13.8	13.6	13.4	12.4
	-5.0	15.5	15.3	14.0	12.4
	0.0	17.2	17.0	14.0	12.4
	2.5	18.0	17.8	14.0	12.4
	6.0	18.2	18.0	14.0	12.4
	7.5	19.0	18.0	14.0	12.4
	10.0	20.2	18.0	14.0	12.4
	12.5	21.5	18.0	14.0	12.4
15.5	21.8	18.0	14.0	12.4	
200	-15.0	16.7	16.5	16.4	16.3
	-10.0	19.1	18.9	18.6	17.3
	-5.0	21.5	21.2	19.5	17.3
	0.0	23.8	23.6	19.5	17.3
	2.5	25.0	24.8	19.5	17.3
	6.0	25.3	25.0	19.5	17.3
	7.5	26.3	25.0	19.5	17.3
	10.0	28.1	25.0	19.5	17.3
	12.5	29.9	25.0	19.5	17.3
15.5	30.3	25.0	19.5	17.3	
250	-15.0	21.1	20.8	20.6	20.5
	-10.0	24.1	23.8	23.4	21.7
	-5.0	27.1	26.7	24.6	21.7
	0.0	30.0	29.7	24.6	21.7
	2.5	31.5	31.2	24.6	21.7
	6.0	31.8	31.5	24.6	21.7
	7.5	33.2	31.5	24.6	21.7
	10.0	35.4	31.5	24.6	21.7
	12.5	37.7	31.5	24.6	21.7
15.5	38.1	31.5	24.6	21.7	

PEFY-P-VML-A1/VMH-A

2-5.Cooling Capacity (In combination with Big Y, Super Y, Big R2)

PEFY-P-VML-A1,VMH-A

CA :Capacity(kW)
SHC:Sensible Heat Capacity(kW)

Unit size	Outdoor air temp.	Indoor air temp.											
		21.5°CDB 15°CWB		23°CDB 16°CWB		25°CDB 18°CWB		28°CDB 20°CWB		30°CDB 22°CWB		32°CDB 24°CWB	
		CA	SHC	CA	SHC	CA	SHC	CA	SHC	CA	SHC	CA	SHC
20	20.0	2.0	1.8	2.1	1.9	2.3	1.9	2.4	2.0	2.6	2.0	2.7	1.9
	22.5	2.0	1.8	2.1	1.9	2.3	1.8	2.4	2.0	2.6	1.9	2.7	1.9
	25.0	2.0	1.8	2.1	1.8	2.2	1.8	2.4	2.0	2.5	1.9	2.7	1.9
	27.5	2.0	1.8	2.1	1.8	2.2	1.8	2.4	1.9	2.5	1.9	2.6	1.9
	30.0	2.0	1.8	2.1	1.8	2.2	1.8	2.3	1.9	2.5	1.9	2.6	1.9
	32.5	2.0	1.7	2.0	1.8	2.2	1.8	2.3	1.9	2.4	1.9	2.6	1.9
	35.0	1.9	1.7	2.0	1.8	2.1	1.8	2.3	1.9	2.4	1.9	2.5	1.9
	37.5	1.9	1.7	2.0	1.8	2.1	1.8	2.2	1.9	2.4	1.9	2.5	1.8
	40.0	1.9	1.7	2.0	1.8	2.1	1.8	2.2	1.9	2.3	1.9	2.4	1.8
43.0	1.9	1.7	1.9	1.8	2.1	1.8	2.2	1.9	2.3	1.8	2.4	1.8	
25	20.0	2.6	2.1	2.7	2.2	2.9	2.2	3.1	2.3	3.3	2.3	3.5	2.3
	22.5	2.6	2.1	2.7	2.2	2.9	2.2	3.1	2.3	3.3	2.3	3.4	2.2
	25.0	2.6	2.1	2.7	2.2	2.9	2.2	3.0	2.3	3.2	2.3	3.4	2.2
	27.5	2.5	2.1	2.6	2.2	2.8	2.1	3.0	2.3	3.2	2.2	3.3	2.2
	30.0	2.5	2.1	2.6	2.1	2.8	2.1	3.0	2.3	3.1	2.2	3.3	2.2
	32.5	2.5	2.1	2.6	2.1	2.8	2.1	2.9	2.2	3.1	2.2	3.2	2.2
	35.0	2.5	2.0	2.6	2.1	2.7	2.1	2.9	2.2	3.0	2.2	3.2	2.2
	37.5	2.5	2.0	2.5	2.1	2.7	2.1	2.8	2.2	3.0	2.2	3.1	2.1
	40.0	2.4	2.0	2.5	2.1	2.7	2.1	2.8	2.2	3.0	2.2	3.1	2.1
43.0	2.4	2.0	2.5	2.1	2.6	2.1	2.8	2.2	2.9	2.1	3.0	2.1	
32	20.0	3.3	2.6	3.5	2.7	3.7	2.7	4.0	2.9	4.2	2.8	4.5	2.8
	22.5	3.3	2.6	3.5	2.7	3.7	2.7	4.0	2.8	4.2	2.8	4.4	2.8
	25.0	3.3	2.6	3.4	2.7	3.7	2.7	3.9	2.8	4.1	2.8	4.4	2.7
	27.5	3.3	2.6	3.4	2.7	3.6	2.7	3.9	2.8	4.1	2.8	4.3	2.7
	30.0	3.2	2.6	3.4	2.7	3.6	2.6	3.8	2.8	4.0	2.7	4.2	2.7
	32.5	3.2	2.5	3.3	2.6	3.5	2.6	3.8	2.8	4.0	2.7	4.2	2.7
	35.0	3.2	2.5	3.3	2.6	3.5	2.6	3.7	2.7	3.9	2.7	4.1	2.7
	37.5	3.2	2.5	3.3	2.6	3.5	2.6	3.7	2.7	3.8	2.7	4.0	2.6
	40.0	3.1	2.5	3.2	2.6	3.4	2.6	3.6	2.7	3.8	2.7	4.0	2.6
43.0	3.1	2.5	3.2	2.6	3.4	2.5	3.5	2.7	3.7	2.6	3.9	2.6	
40	20.0	4.1	3.2	4.3	3.3	4.7	3.3	5.0	3.5	5.3	3.5	5.6	3.4
	22.5	4.1	3.2	4.3	3.3	4.6	3.3	4.9	3.5	5.2	3.4	5.5	3.4
	25.0	4.1	3.2	4.3	3.3	4.6	3.3	4.9	3.5	5.2	3.4	5.5	3.4
	27.5	4.1	3.2	4.2	3.3	4.5	3.3	4.8	3.4	5.1	3.4	5.4	3.3
	30.0	4.0	3.1	4.2	3.3	4.5	3.2	4.8	3.4	5.0	3.4	5.3	3.3
	32.5	4.0	3.1	4.2	3.2	4.4	3.2	4.7	3.4	5.0	3.3	5.2	3.3
	35.0	4.0	3.1	4.1	3.2	4.4	3.2	4.6	3.4	4.9	3.3	5.1	3.2
	37.5	3.9	3.1	4.1	3.2	4.3	3.2	4.6	3.3	4.8	3.3	5.1	3.2
	40.0	3.9	3.1	4.0	3.2	4.3	3.1	4.5	3.3	4.7	3.3	5.0	3.2
43.0	3.9	3.1	4.0	3.2	4.2	3.1	4.4	3.3	4.7	3.2	4.9	3.2	
50	20.0	5.2	3.7	5.4	3.9	5.8	3.9	6.2	4.1	6.6	4.0	7.0	4.0
	22.5	5.2	3.7	5.4	3.9	5.8	3.9	6.2	4.1	6.5	4.0	6.9	3.9
	25.0	5.1	3.7	5.3	3.8	5.7	3.8	6.1	4.0	6.4	4.0	6.8	3.9
	27.5	5.1	3.7	5.3	3.8	5.6	3.8	6.0	4.0	6.3	3.9	6.7	3.9
	30.0	5.0	3.7	5.2	3.8	5.6	3.8	5.9	4.0	6.2	3.9	6.6	3.8
	32.5	5.0	3.6	5.2	3.8	5.5	3.7	5.8	3.9	6.2	3.9	6.5	3.8
	35.0	4.9	3.6	5.1	3.7	5.4	3.7	5.8	3.9	6.1	3.8	6.4	3.7
	37.5	4.9	3.6	5.1	3.7	5.4	3.7	5.7	3.9	6.0	3.8	6.3	3.7
	40.0	4.9	3.6	5.0	3.7	5.3	3.6	5.6	3.8	5.9	3.7	6.2	3.7
43.0	4.8	3.6	5.0	3.7	5.2	3.6	5.5	3.8	5.8	3.7	6.1	3.6	
63	20.0	6.5	4.9	6.9	5.1	7.4	5.1	7.9	5.4	8.4	5.3	8.9	5.2
	22.5	6.5	4.9	6.8	5.1	7.3	5.1	7.8	5.4	8.3	5.3	8.7	5.2
	25.0	6.5	4.9	6.8	5.1	7.2	5.0	7.7	5.3	8.1	5.2	8.6	5.1
	27.5	6.4	4.9	6.7	5.0	7.2	5.0	7.6	5.3	8.0	5.2	8.5	5.1
	30.0	6.4	4.8	6.6	5.0	7.1	5.0	7.5	5.2	7.9	5.1	8.4	5.1
	32.5	6.3	4.8	6.6	5.0	7.0	4.9	7.4	5.2	7.8	5.1	8.2	5.0
	35.0	6.3	4.8	6.5	4.9	6.9	4.9	7.3	5.2	7.7	5.1	8.1	5.0
	37.5	6.2	4.8	6.4	4.9	6.8	4.9	7.2	5.1	7.6	5.0	8.0	4.9
	40.0	6.2	4.7	6.4	4.9	6.7	4.8	7.1	5.1	7.5	5.0	7.9	4.9
43.0	6.1	4.7	6.3	4.8	6.6	4.8	7.0	5.0	7.3	4.9	7.7	4.8	

PEFY-P-VML-A1/VMH-A

Cooling Capacity (In combination with Big Y, Super Y, Big R2)

PEFY-P-VML-A1,VMH-A

CA :Capacity(kW)
SHC:Sensible Heat Capacity(kW)

Unit size	Outdoor air temp.	Indoor air temp.												
		21.5°CDB 15°CWB			23°CDB 16°CWB		25°CDB 18°CWB		28°CDB 20°CWB		30°CDB 22°CWB		32°CDB 24°CWB	
		°CDB	CA	SHC	CA	SHC	CA	SHC	CA	SHC	CA	SHC	CA	SHC
71	20.0	7.4	5.5	7.7	5.7	8.3	5.7	8.9	6.0	9.4	5.9	10.0	5.8	
	22.5	7.4	5.5	7.7	5.7	8.2	5.7	8.8	6.0	9.3	5.9	9.8	5.8	
	25.0	7.3	5.5	7.6	5.7	8.2	5.6	8.7	5.9	9.2	5.8	9.7	5.7	
	27.5	7.2	5.4	7.5	5.6	8.1	5.6	8.6	5.9	9.0	5.8	9.6	5.7	
	30.0	7.2	5.4	7.5	5.6	8.0	5.5	8.5	5.8	8.9	5.7	9.4	5.6	
	32.5	7.1	5.4	7.4	5.5	7.9	5.5	8.3	5.8	8.8	5.7	9.3	5.6	
	35.0	7.1	5.3	7.3	5.5	7.8	5.5	8.2	5.7	8.7	5.6	9.1	5.5	
	37.5	7.0	5.3	7.2	5.5	7.7	5.4	8.1	5.7	8.6	5.6	9.0	5.5	
	40.0	7.0	5.3	7.2	5.4	7.6	5.4	8.0	5.7	8.4	5.6	8.9	5.4	
	43.0	6.9	5.2	7.1	5.4	7.5	5.3	7.9	5.6	8.3	5.5	8.7	5.4	
80	20.0	8.3	6.2	8.7	6.5	9.4	6.5	10.0	6.8	10.6	6.7	11.2	6.6	
	22.5	8.3	6.2	8.7	6.4	9.3	6.4	9.9	6.8	10.5	6.7	11.1	6.6	
	25.0	8.2	6.2	8.6	6.4	9.2	6.4	9.8	6.7	10.3	6.6	10.9	6.5	
	27.5	8.1	6.1	8.5	6.4	9.1	6.3	9.6	6.7	10.2	6.6	10.8	6.4	
	30.0	8.1	6.1	8.4	6.3	9.0	6.3	9.5	6.6	10.0	6.5	10.6	6.4	
	32.5	8.0	6.1	8.3	6.3	8.9	6.2	9.4	6.6	9.9	6.4	10.4	6.3	
	35.0	8.0	6.0	8.2	6.2	8.8	6.2	9.3	6.5	9.8	6.4	10.3	6.3	
	37.5	7.9	6.0	8.1	6.2	8.6	6.1	9.1	6.5	9.6	6.3	10.1	6.2	
	40.0	7.8	6.0	8.1	6.2	8.5	6.1	9.0	6.4	9.5	6.3	10.0	6.2	
	43.0	7.7	5.9	8.0	6.1	8.4	6.0	8.9	6.3	9.3	6.2	9.8	6.1	
100	20.0	10.3	8.4	10.8	8.7	11.6	8.7	12.5	9.3	13.2	9.2	14.0	9.0	
	22.5	10.3	8.4	10.8	8.7	11.5	8.7	12.3	9.2	13.0	9.1	13.8	8.9	
	25.0	10.2	8.3	10.7	8.7	11.4	8.6	12.1	9.2	12.8	9.0	13.6	8.9	
	27.5	10.1	8.3	10.6	8.6	11.3	8.6	12.0	9.1	12.7	9.0	13.4	8.8	
	30.0	10.1	8.3	10.5	8.6	11.2	8.5	11.8	9.0	12.5	8.9	13.2	8.7	
	32.5	10.0	8.2	10.3	8.5	11.0	8.5	11.7	9.0	12.3	8.8	13.0	8.7	
	35.0	9.9	8.2	10.2	8.5	10.9	8.4	11.5	8.9	12.1	8.8	12.8	8.6	
	37.5	9.8	8.1	10.1	8.4	10.8	8.3	11.4	8.9	12.0	8.7	12.6	8.5	
	40.0	9.7	8.1	10.0	8.4	10.6	8.3	11.2	8.8	11.8	8.6	12.4	8.5	
	43.0	9.6	8.1	9.9	8.3	10.5	8.2	11.0	8.7	11.6	8.6	12.2	8.4	
125	20.0	12.9	9.6	13.5	10.0	14.6	10.0	15.6	10.6	16.5	10.4	17.5	10.3	
	22.5	12.9	9.6	13.5	10.0	14.4	10.0	15.4	10.5	16.3	10.3	17.2	10.2	
	25.0	12.8	9.6	13.3	9.9	14.3	9.9	15.2	10.4	16.1	10.2	17.0	10.1	
	27.5	12.7	9.5	13.2	9.9	14.1	9.8	15.0	10.3	15.8	10.2	16.7	10.0	
	30.0	12.6	9.5	13.1	9.8	13.9	9.7	14.8	10.2	15.6	10.1	16.5	9.9	
	32.5	12.5	9.4	12.9	9.7	13.8	9.7	14.6	10.2	15.4	10.0	16.2	9.8	
	35.0	12.4	9.4	12.8	9.7	13.6	9.6	14.4	10.1	15.2	9.9	16.0	9.7	
	37.5	12.3	9.3	12.7	9.6	13.5	9.5	14.2	10.0	15.0	9.8	15.7	9.6	
	40.0	12.2	9.3	12.5	9.5	13.3	9.4	14.0	9.9	14.8	9.7	15.5	9.5	
	43.0	12.0	9.2	12.4	9.5	13.1	9.4	13.8	9.8	14.5	9.6	15.2	9.4	
140	20.0	14.7	11.0	15.4	11.4	16.6	11.4	17.8	12.1	18.8	11.9	20.0	11.7	
	22.5	14.7	11.0	15.4	11.4	16.5	11.4	17.6	12.0	18.6	11.8	19.7	11.6	
	25.0	14.6	10.9	15.2	11.3	16.3	11.3	17.4	11.9	18.3	11.7	19.4	11.5	
	27.5	14.5	10.9	15.1	11.3	16.1	11.2	17.1	11.8	18.1	11.6	19.1	11.4	
	30.0	14.4	10.8	14.9	11.2	15.9	11.1	16.9	11.7	17.8	11.5	18.8	11.3	
	32.5	14.3	10.8	14.8	11.1	15.7	11.0	16.7	11.6	17.6	11.4	18.6	11.2	
	35.0	14.1	10.7	14.6	11.1	15.6	11.0	16.5	11.5	17.4	11.3	18.3	11.1	
	37.5	14.0	10.6	14.5	11.0	15.4	10.9	16.2	11.4	17.1	11.2	18.0	11.0	
	40.0	13.9	10.6	14.3	10.9	15.2	10.8	16.0	11.3	16.9	11.1	17.7	10.9	
	43.0	13.8	10.5	14.2	10.8	15.0	10.7	15.8	11.2	16.6	11.0	17.4	10.8	
200	20.0	20.6	15.8	21.6	16.4	23.3	16.4	24.9	17.4	26.4	17.1	28.0	16.9	
	22.5	20.6	15.8	21.5	16.4	23.1	16.3	24.6	17.2	26.0	17.0	27.6	16.7	
	25.0	20.4	15.7	21.3	16.3	22.8	16.2	24.3	17.1	25.7	16.9	27.2	16.6	
	27.5	20.3	15.6	21.1	16.2	22.6	16.1	24.0	17.0	25.3	16.7	26.8	16.4	
	30.0	20.1	15.5	20.9	16.1	22.3	16.0	23.7	16.9	25.0	16.6	26.4	16.3	
	32.5	20.0	15.4	20.7	16.0	22.0	15.9	23.4	16.7	24.6	16.5	26.0	16.2	
	35.0	19.8	15.4	20.5	15.9	21.8	15.7	23.1	16.6	24.3	16.3	25.6	16.0	
	37.5	19.6	15.3	20.3	15.8	21.5	15.6	22.7	16.5	23.9	16.2	25.2	15.9	
	40.0	19.5	15.2	20.1	15.7	21.3	15.5	22.4	16.4	23.6	16.1	24.8	15.8	
	43.0	19.3	15.1	19.8	15.6	21.0	15.4	22.1	16.2	23.2	15.9	24.3	15.6	
250	20.0	25.8	19.6	27.0	20.4	29.1	20.4	31.1	21.6	33.0	21.3	34.9	20.9	
	22.5	25.8	19.6	26.9	20.4	28.9	20.3	30.8	21.4	32.5	21.1	34.4	20.8	
	25.0	25.6	19.5	26.7	20.2	28.5	20.1	30.4	21.3	32.1	20.9	34.0	20.6	
	27.5	25.4	19.4	26.4	20.1	28.2	20.0	30.0	21.1	31.7	20.8	33.5	20.4	
	30.0	25.1	19.3	26.1	20.0	27.9	19.9	29.6	20.9	31.2	20.6	33.0	20.2	
	32.5	24.9	19.2	25.9	19.9	27.6	19.7	29.2	20.8	30.8	20.4	32.5	20.1	
	35.0	24.7	19.1	25.6	19.7	27.2	19.6	28.8	20.6	30.4	20.3	32.0	19.9	
	37.5	24.5	19.0	25.4	19.6	26.9	19.4	28.4	20.5	29.9	20.1	31.5	19.7	
	40.0	24.3	18.9	25.1	19.5	26.6	19.3	28.0	20.3	29.5	20.0	31.0	19.6	
	43.0	24.1	18.8	24.8	19.4	26.2	19.1	27.6	20.1	29.0	19.8	30.4	19.4	

PEFY-P-VML-A1/VMH-A

2-6.Heating Capacity (In combination with Big Y, Super Y, Big R2)

PEFY-P-VML-A1,VMH-A

Unit size	Outdoor air temp. °CWB	Indoor air temp.:°CDB			
		15.0	20.0	25.0	27.0
		SHC	SHC	SHC	SHC
20	-15.0	1.6	1.5	1.5	1.5
	-10.0	1.8	1.8	1.7	1.7
	-5.0	2.0	2.0	2.0	1.9
	0.0	2.2	2.2	2.1	1.9
	2.5	2.4	2.3	2.1	1.9
	6.0	2.5	2.5	2.1	1.9
	7.5	2.6	2.5	2.1	1.9
	10.0	2.7	2.5	2.1	1.9
	12.5	2.9	2.5	2.1	1.9
	15.5	2.9	2.5	2.1	1.9
25	-15.0	2.0	2.0	1.9	1.9
	-10.0	2.3	2.2	2.2	2.2
	-5.0	2.6	2.5	2.5	2.5
	0.0	2.9	2.8	2.7	2.5
	2.5	3.0	3.0	2.7	2.5
	6.0	3.2	3.2	2.7	2.5
	7.5	3.3	3.2	2.7	2.5
	10.0	3.5	3.2	2.7	2.5
	12.5	3.7	3.2	2.7	2.5
	15.5	3.7	3.2	2.7	2.5
32	-15.0	2.5	2.5	2.4	2.4
	-10.0	2.8	2.8	2.8	2.7
	-5.0	3.2	3.2	3.1	3.1
	0.0	3.6	3.5	3.4	3.1
	2.5	3.8	3.7	3.4	3.1
	6.0	4.0	4.0	3.4	3.1
	7.5	4.2	4.0	3.4	3.1
	10.0	4.4	4.0	3.4	3.1
	12.5	4.6	4.0	3.4	3.1
	15.5	4.6	4.0	3.4	3.1
40	-15.0	3.1	3.1	3.0	3.0
	-10.0	3.6	3.5	3.5	3.4
	-5.0	4.0	4.0	3.9	3.9
	0.0	4.5	4.4	4.3	3.9
	2.5	4.7	4.7	4.3	3.9
	6.0	5.0	5.0	4.3	3.9
	7.5	5.2	5.0	4.3	3.9
	10.0	5.4	5.0	4.3	3.9
	12.5	5.7	5.0	4.3	3.9
	15.5	5.8	5.0	4.3	3.9
50	-15.0	3.9	3.9	3.8	3.7
	-10.0	4.5	4.4	4.3	4.3
	-5.0	5.0	5.0	4.9	4.9
	0.0	5.6	5.6	5.4	4.9
	2.5	5.9	5.9	5.4	4.9
	6.0	6.4	6.3	5.4	4.9
	7.5	6.6	6.3	5.4	4.9
	10.0	6.9	6.3	5.4	4.9
	12.5	7.2	6.3	5.4	4.9
	15.5	7.2	6.3	5.4	4.9
63	-15.0	5.0	4.9	4.8	4.7
	-10.0	5.7	5.6	5.5	5.4
	-5.0	6.4	6.3	6.2	6.2
	0.0	7.2	7.1	6.8	6.2
	2.5	7.5	7.5	6.8	6.2
	6.0	8.1	8.0	6.8	6.2
	7.5	8.3	8.0	6.8	6.2
	10.0	8.7	8.0	6.8	6.2
	12.5	9.1	8.0	6.8	6.2
	15.5	9.2	8.0	6.8	6.2

SHC:Sensible Heat Capacity(kW)

Unit size	Outdoor air temp. °CWB	Indoor air temp.:°CDB			
		15.0	20.0	25.0	27.0
		SHC	SHC	SHC	SHC
71	-15.0	5.6	5.5	5.4	5.3
	-10.0	6.4	6.3	6.2	6.1
	-5.0	7.2	7.1	7.0	6.9
	0.0	8.0	8.0	7.7	6.9
	2.5	8.5	8.4	7.7	6.9
	6.0	9.1	9.0	7.7	6.9
	7.5	9.4	9.0	7.7	6.9
	10.0	9.8	9.0	7.7	6.9
	12.5	10.3	9.0	7.7	6.9
	15.5	10.4	9.0	7.7	6.9
80	-15.0	6.2	6.1	6.0	5.9
	-10.0	7.1	7.0	6.9	6.8
	-5.0	8.0	7.9	7.8	7.7
	0.0	8.9	8.8	8.5	7.7
	2.5	9.4	9.3	8.5	7.7
	6.0	10.1	10.0	8.5	7.7
	7.5	10.4	10.0	8.5	7.7
	10.0	10.9	10.0	8.5	7.7
	12.5	11.4	10.0	8.5	7.7
	15.5	11.5	10.0	8.5	7.7
100	-15.0	7.8	7.7	7.5	7.4
	-10.0	8.9	8.8	8.6	8.5
	-5.0	10.0	9.9	9.8	9.6
	0.0	11.2	11.0	10.6	9.6
	2.5	11.8	11.6	10.6	9.6
	6.0	12.6	12.5	10.6	9.6
	7.5	13.0	12.5	10.6	9.6
	10.0	13.6	12.5	10.6	9.6
	12.5	14.3	12.5	10.6	9.6
	15.5	14.4	12.5	10.6	9.6
125	-15.0	10.0	9.8	9.6	9.5
	-10.0	11.4	11.2	11.0	10.9
	-5.0	12.8	12.6	12.5	12.3
	0.0	14.3	14.1	13.6	12.3
	2.5	15.1	14.9	13.6	12.3
	6.0	16.2	16.0	13.6	12.3
	7.5	16.6	16.0	13.6	12.3
	10.0	17.4	16.0	13.6	12.3
	12.5	18.3	16.0	13.6	12.3
	15.5	18.4	16.0	13.6	12.3
140	-15.0	11.2	11.0	10.9	10.7
	-10.0	12.8	12.6	12.4	12.2
	-5.0	14.4	14.2	14.1	13.9
	0.0	16.1	15.9	15.3	13.9
	2.5	17.0	16.8	15.3	13.9
	6.0	18.2	18.0	15.3	13.9
	7.5	18.7	18.0	15.3	13.9
	10.0	19.6	18.0	15.3	13.9
	12.5	20.5	18.0	15.3	13.9
	15.5	20.7	18.0	15.3	13.9
200	-15.0	15.6	15.3	15.1	14.8
	-10.0	17.8	17.5	17.3	17.0
	-5.0	20.0	19.8	19.5	19.3
	0.0	22.3	22.1	21.3	19.3
	2.5	23.5	23.3	21.3	19.3
	6.0	25.2	25.0	21.3	19.3
	7.5	26.0	25.0	21.3	19.3
	10.0	27.2	25.0	21.3	19.3
	12.5	28.5	25.0	21.3	19.3
	15.5	28.8	25.0	21.3	19.3
250	-15.0	19.6	19.3	19.0	18.7
	-10.0	22.4	22.1	21.7	21.4
	-5.0	25.2	24.9	24.6	24.3
	0.0	28.2	27.8	26.8	24.3
	2.5	29.7	29.4	26.8	24.3
	6.0	31.8	31.5	26.8	24.3
	7.5	32.8	31.5	26.8	24.3
	10.0	34.3	31.5	26.8	24.3
	12.5	35.9	31.5	26.8	24.3
	15.5	36.2	31.5	26.8	24.3

2-7.Cooling Capacity (In combination with WY, WR2)

CA :Capacity(kW)
SHC:Sensible Heat Capacity(kW)

PEFY-P-VML-A1,VMH-A

Unit size	Water temp.	Indoor air temp.													
		21.5°CDB 15°CWB		23°CDB 16°CWB		25°CDB 18°CWB		27°CDB 19°CWB		28°CDB 20°CWB		30°CDB 22°CWB		32°CDB 24°CWB	
		°C	CA	SHC	CA	SHC	CA	SHC	CA	SHC	CA	SHC	CA	SHC	CA
20	10	2.1	1.8	2.2	1.9	2.4	1.9	2.4	1.9	2.5	2.0	2.6	2.0	2.8	1.9
	20	2.1	1.8	2.1	1.9	2.3	1.8	2.3	1.9	2.4	2.0	2.5	1.9	2.7	1.9
	30	2.0	1.7	2.0	1.8	2.1	1.8	2.2	1.8	2.3	1.9	2.4	1.9	2.5	1.9
	40	1.7	1.6	1.8	1.7	1.9	1.7	1.9	1.7	2.0	1.8	2.1	1.8	2.2	1.8
	45	1.6	1.6	1.7	1.7	1.8	1.6	1.8	1.7	1.9	1.8	2.0	1.7	2.1	1.7
25	10	2.7	2.2	2.8	2.2	3.0	2.2	3.1	2.3	3.2	2.3	3.3	2.3	3.5	2.3
	20	2.6	2.1	2.7	2.2	2.9	2.2	3.0	2.2	3.1	2.3	3.2	2.3	3.4	2.2
	30	2.5	2.0	2.6	2.1	2.7	2.1	2.8	2.1	2.9	2.2	3.0	2.2	3.2	2.2
	40	2.2	1.9	2.2	2.0	2.4	2.0	2.4	2.0	2.5	2.1	2.6	2.1	2.8	2.0
	45	2.0	1.8	2.1	1.9	2.2	1.9	2.3	1.9	2.4	2.0	2.5	2.0	2.6	2.0
32	10	3.5	2.7	3.6	2.8	3.9	2.8	4.0	2.8	4.1	2.9	4.3	2.9	4.5	2.8
	20	3.4	2.6	3.5	2.7	3.7	2.7	3.8	2.7	3.9	2.8	4.1	2.8	4.4	2.7
	30	3.2	2.5	3.3	2.6	3.5	2.6	3.6	2.6	3.7	2.7	3.9	2.7	4.1	2.7
	40	2.8	2.3	2.9	2.4	3.1	2.4	3.1	2.5	3.2	2.6	3.4	2.5	3.6	2.5
	45	2.6	2.3	2.7	2.4	2.9	2.3	3.0	2.4	3.0	2.5	3.2	2.4	3.4	2.4
40	10	4.4	3.3	4.5	3.4	4.8	3.4	5.0	3.4	5.1	3.6	5.4	3.5	5.7	3.4
	20	4.2	3.2	4.4	3.3	4.6	3.3	4.8	3.4	4.9	3.5	5.2	3.4	5.5	3.4
	30	4.0	3.1	4.1	3.2	4.4	3.2	4.5	3.2	4.6	3.4	4.9	3.3	5.2	3.3
	40	3.5	2.9	3.6	3.0	3.8	2.9	3.9	3.0	4.0	3.1	4.3	3.1	4.5	3.0
	45	3.3	2.8	3.4	2.9	3.6	2.9	3.7	2.9	3.8	3.0	4.0	3.0	4.2	2.9
50	10	5.5	3.9	5.6	4.0	6.0	4.0	6.2	4.0	6.3	4.1	6.7	4.1	7.1	4.0
	20	5.3	3.8	5.4	3.9	5.8	3.9	5.9	3.9	6.1	4.0	6.5	4.0	6.8	3.9
	30	5.0	3.6	5.1	3.7	5.5	3.7	5.6	3.7	5.8	3.9	6.1	3.8	6.4	3.8
	40	4.3	3.3	4.5	3.4	4.7	3.4	4.9	3.4	5.0	3.6	5.3	3.5	5.6	3.5
	45	4.1	3.2	4.2	3.3	4.5	3.3	4.6	3.3	4.7	3.5	5.0	3.4	5.3	3.3
63	10	6.9	5.1	7.2	5.3	7.6	5.2	7.8	5.3	8.0	5.5	8.5	5.4	9.0	5.3
	20	6.7	5.0	6.9	5.1	7.3	5.1	7.5	5.1	7.8	5.3	8.2	5.2	8.6	5.2
	30	6.3	4.8	6.5	4.9	6.9	4.9	7.1	5.0	7.3	5.2	7.7	5.1	8.1	5.0
	40	5.5	4.4	5.7	4.5	6.0	4.5	6.2	4.6	6.4	4.8	6.7	4.7	7.1	4.6
	45	5.2	4.3	5.3	4.4	5.7	4.4	5.8	4.4	6.0	4.6	6.3	4.6	6.7	4.5
71	10	7.8	5.7	8.1	5.9	8.6	5.8	8.8	5.9	9.1	6.1	9.6	6.0	10.1	5.9
	20	7.5	5.6	7.8	5.7	8.3	5.7	8.5	5.7	8.7	6.0	9.2	5.9	9.7	5.8
	30	7.1	5.4	7.3	5.5	7.8	5.5	8.0	5.5	8.2	5.7	8.7	5.7	9.2	5.6
	40	6.2	4.9	6.4	5.1	6.8	5.0	7.0	5.1	7.2	5.3	7.6	5.2	8.0	5.1
	45	5.8	4.7	6.0	4.9	6.4	4.9	6.6	4.9	6.8	5.1	7.1	5.1	7.5	5.0
80	10	8.8	6.5	9.1	6.6	9.6	6.6	9.9	6.7	10.2	6.9	10.8	6.8	11.4	6.7
	20	8.5	6.3	8.7	6.5	9.3	6.4	9.5	6.5	9.8	6.7	10.4	6.6	10.9	6.5
	30	8.0	6.1	8.3	6.2	8.8	6.2	9.0	6.3	9.3	6.5	9.8	6.4	10.3	6.3
	40	6.9	5.6	7.2	5.7	7.6	5.7	7.8	5.8	8.1	6.0	8.5	5.9	9.0	5.8
	45	6.5	5.4	6.8	5.6	7.2	5.5	7.4	5.6	7.6	5.8	8.0	5.7	8.5	5.7
100	10	10.9	8.7	11.3	9.0	12.0	8.9	12.3	9.0	12.7	9.4	13.4	9.2	14.1	9.1
	20	10.5	8.5	10.9	8.8	11.6	8.7	11.9	8.8	12.2	9.2	12.9	9.0	13.6	8.9
	30	9.9	8.2	10.3	8.5	10.9	8.4	11.2	8.6	11.5	8.9	12.2	8.8	12.8	8.6
	40	8.6	7.6	8.9	7.9	9.5	7.8	9.7	8.0	10.0	8.3	10.6	8.2	11.2	8.1
	45	8.1	7.4	8.4	7.7	8.9	7.6	9.2	7.8	9.5	8.1	10.0	8.0	10.5	7.9
125	10	13.7	10.0	14.1	10.3	15.0	10.2	15.4	10.3	15.9	10.7	16.7	10.5	17.7	10.3
	20	13.2	9.8	13.6	10.1	14.5	10.0	14.8	10.1	15.3	10.5	16.1	10.3	17.0	10.1
	30	12.4	9.4	12.8	9.7	13.6	9.6	14.0	9.7	14.4	10.1	15.2	9.9	16.1	9.7
	40	10.8	8.6	11.2	8.9	11.9	8.8	12.2	9.0	12.5	9.3	13.2	9.2	14.0	9.0
	45	10.2	8.3	10.5	8.6	11.2	8.5	11.5	8.7	11.8	9.0	12.5	8.9	13.2	8.8
140	10	15.6	11.4	16.1	11.8	17.1	11.7	17.6	11.8	18.1	12.2	19.1	12.0	20.2	11.8
	20	15.0	11.2	15.6	11.5	16.5	11.4	17.0	11.5	17.5	11.9	18.4	11.8	19.5	11.5
	30	14.2	10.7	14.7	11.1	15.6	11.0	16.0	11.1	16.5	11.5	17.4	11.3	18.4	11.1
	40	12.3	9.8	12.8	10.2	13.6	10.1	13.9	10.3	14.3	10.7	15.1	10.5	16.0	10.3
	45	11.6	9.5	12.0	9.8	12.8	9.8	13.1	9.9	13.5	10.3	14.3	10.2	15.0	10.0
200	10	21.9	16.4	22.6	16.9	24.0	16.7	24.6	16.9	25.4	17.6	26.8	17.3	28.3	17.0
	20	21.1	16.0	21.8	16.5	23.1	16.3	23.7	16.6	24.5	17.2	25.8	16.9	27.2	16.6
	30	19.9	15.4	20.5	15.9	21.8	15.8	22.4	16.0	23.1	16.6	24.3	16.4	25.7	16.1
	40	17.3	14.2	17.9	14.7	19.0	14.5	19.5	14.8	20.1	15.4	21.2	15.2	22.4	14.9
	45	16.3	13.7	16.8	14.2	17.9	14.1	18.4	14.4	18.9	15.0	20.0	14.7	21.1	14.5
250	10	27.3	20.4	28.2	21.0	30.0	20.8	30.8	21.0	31.7	21.8	33.5	21.5	35.3	21.1
	20	26.3	19.9	27.2	20.5	28.9	20.3	29.7	20.6	30.6	21.4	32.3	21.0	34.0	20.6
	30	24.8	19.1	25.7	19.8	27.3	19.6	28.0	19.9	28.8	20.6	30.4	20.3	32.1	20.0
	40	21.6	17.6	22.3	18.2	23.7	18.1	24.4	18.4	25.1	19.1	26.5	18.8	27.9	18.5
	45	20.4	17.0	21.1	17.7	22.4	17.5	23.0	17.8	23.6	18.6	25.0	18.3	26.3	18.0

PEFY-P-VML-A1/VMH-A

2-8.Heating Capacity (In combination with WY, WR2)

PEFY-P-VML-A1,VMH-A

SHC:Sensible Heat Capacity(kW)

Unit size	Water temp. °C	Indoor air temp.:°CDB				
		15	19	20	25	27
		SHC	SHC	SHC	SHC	SHC
20	10	2.2	2.2	2.1	1.7	1.5
	20	2.6	2.6	2.5	2.0	1.8
	30	2.6	2.6	2.5	2.0	1.8
	40	2.7	2.7	2.6	2.1	1.9
	45	2.9	2.9	2.9	2.3	2.1
25	10	2.8	2.8	2.7	2.2	2.0
	20	3.3	3.3	3.2	2.6	2.3
	30	3.3	3.3	3.2	2.6	2.3
	40	3.4	3.4	3.3	2.7	2.4
	45	3.8	3.7	3.6	2.9	2.6
32	10	3.5	3.5	3.4	2.7	2.4
	20	4.1	4.1	4.0	3.2	2.9
	30	4.1	4.1	4.0	3.2	2.9
	40	4.3	4.2	4.2	3.3	3.0
	45	4.7	4.7	4.6	3.6	3.3
40	10	4.4	4.3	4.3	3.4	3.1
	20	5.2	5.1	5.0	4.0	3.6
	30	5.2	5.1	5.0	4.0	3.6
	40	5.4	5.3	5.2	4.2	3.7
	45	5.9	5.8	5.7	4.6	4.1
50	10	5.5	5.5	5.4	4.3	3.9
	20	6.5	6.4	6.3	5.0	4.5
	30	6.5	6.4	6.3	5.0	4.5
	40	6.7	6.7	6.6	5.2	4.7
	45	7.4	7.3	7.2	5.7	5.2
63	10	7.0	6.9	6.8	5.4	4.9
	20	8.2	8.2	8.0	6.4	5.8
	30	8.2	8.2	8.0	6.4	5.8
	40	8.6	8.5	8.3	6.7	6.0
	45	9.4	9.3	9.1	7.3	6.6
71	10	7.9	7.8	7.7	6.1	5.5
	20	9.3	9.2	9.0	7.2	6.5
	30	9.3	9.2	9.0	7.2	6.5
	40	9.6	9.5	9.4	7.5	6.7
	45	10.6	10.5	10.3	8.2	7.4
80	10	8.8	8.7	8.5	6.8	6.1
	20	10.3	10.2	10.0	8.0	7.2
	30	10.3	10.2	10.0	8.0	7.2
	40	10.7	10.6	10.4	8.3	7.5
	45	11.7	11.6	11.4	9.1	8.2
100	10	10.9	10.8	10.6	8.5	7.7
	20	12.9	12.8	12.5	10.0	9.0
	30	12.9	12.8	12.5	10.0	9.0
	40	13.4	13.3	13.0	10.4	9.4
	45	14.7	14.5	14.3	11.4	10.3
125	10	14.0	13.9	13.6	10.9	9.8
	20	16.5	16.3	16.0	12.8	11.5
	30	16.5	16.3	16.0	12.8	11.5
	40	17.1	17.0	16.6	13.3	12.0
	45	18.8	18.6	18.2	14.6	13.1
140	10	15.8	15.6	15.3	12.2	11.0
	20	18.5	18.4	18.0	14.4	13.0
	30	18.5	18.4	18.0	14.4	13.0
	40	19.3	19.1	18.7	15.0	13.5
	45	21.1	20.9	20.5	16.4	14.8
200	10	21.9	21.7	21.3	17.0	15.3
	20	25.8	25.5	25.0	20.0	18.0
	30	25.8	25.5	25.0	20.0	18.0
	40	26.8	26.5	26.0	20.8	18.7
	45	29.4	29.1	28.5	22.8	20.5
250	10	27.6	27.3	26.8	21.4	19.3
	20	32.4	32.1	31.5	25.2	22.7
	30	32.4	32.1	31.5	25.2	22.7
	40	33.7	33.4	32.8	26.2	23.6
	45	37.0	36.6	35.9	28.7	25.9

PEFY-P-VML-A1/VMH-A

3. Sound Levels

3-1. Noise level(VML-A1)

① Rear inlet model1

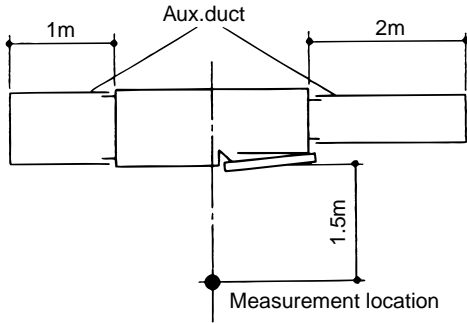

Noise level at anechoic room (Low-Mid-High) Unit : dB(A)

Model	Noise level (A weighted)
PEFY-P20VML-A1 PEFY-P25VML-A1	25-29-36
PEFY-P32VML-A1	25-29-40

PEFY-P-VML-A1/VML-A

3-2. NC curves(VML-A1)

PEFY-P20,25VML-A1
External static pressure : 5Pa
Power source : 220-230-240(V)

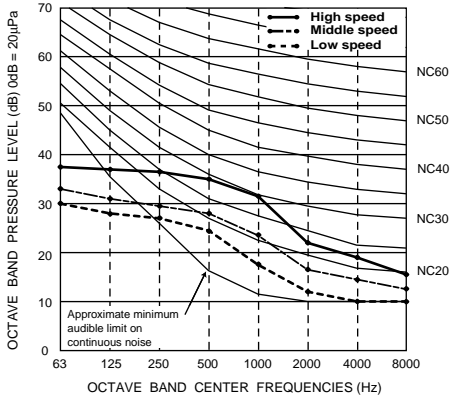

PEFY-P32VML-A1
External static pressure : 5Pa
Power source : 220-230-240(V)

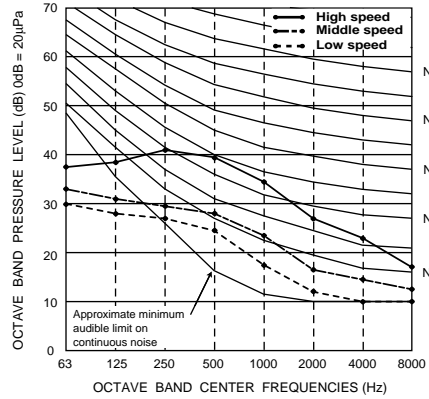

3-3. Fan characteristics curves(VML-A1)

PEFY-P20,25VML-A1
Power source : 220-230-240(V)

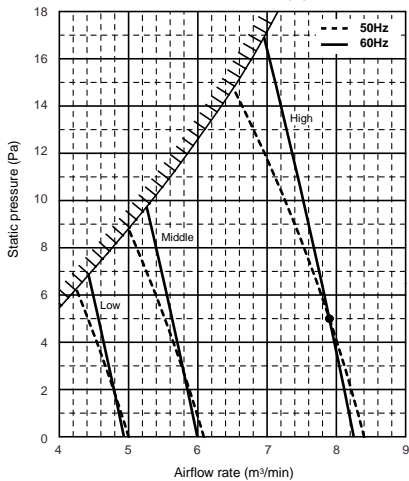

PEFY-P32VML-A1
Power source : 220-230-240(V)

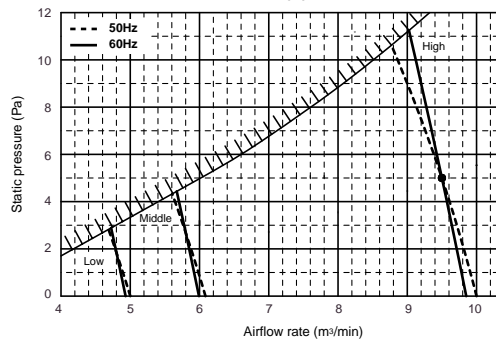

3-4. Noise level(VMH-A)

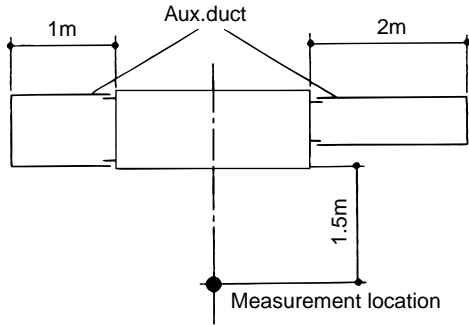

- ※ PEFY-P40~140VMH-A
 Low : 50Pa (at 220V) / 100Pa (at 230, 240V)
 Mid : 100Pa (at 220V) / 150Pa (at 230, 240V)
 High : 200Pa (at 220, 230, 240V)
- ※ PEFY-P200, 250VMH-A
 Low : 110Pa (at 380V) / 130Pa (at 400, 415V)
 High : 220Pa (at 380V) / 260Pa (at 400, 415V)

Noise level at anechoic room (Low-High)

Unit : dB(A)

Model	External static pressure※	External static pressure※		
		Low	Mid	High
PEFY-P40, 50 VMH-A	220V	25-30	27-34	30-40
	230, 240V	30-34	31-37	31-41
PEFY-P63VMH-A	220V	31-36	32-38	36-43
	230, 240V	35-39	36-41	38-44
PEFY-P71VMH-A	220V	30-36	32-39	35-43
	230, 240V	34-39	35-41	37-44
PEFY-P80VMH-A	220V	32-39	35-41	37-43
	230, 240V	37-41	38-43	39-45
PEFY-P100, 125, 140VMH-A	220V	32-40	34-42	36-46
	230, 240V	36-42	38-44	38-47
PEFY-P200VMH-A	380V	42	—	45
	400, 415V	44	—	47
PEFY-P250VMH-A	380V	50	—	52
	400, 415V	52	—	54

3-5. NC curves(VMH-A)

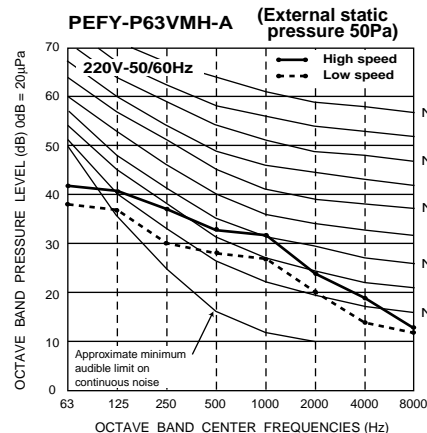
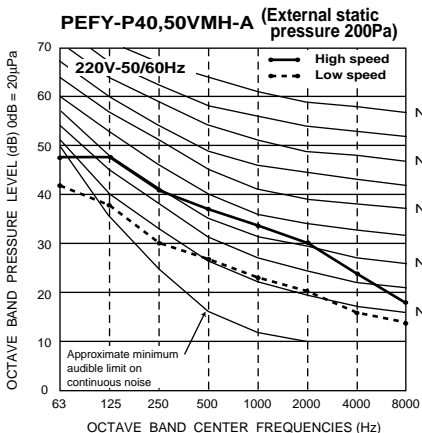
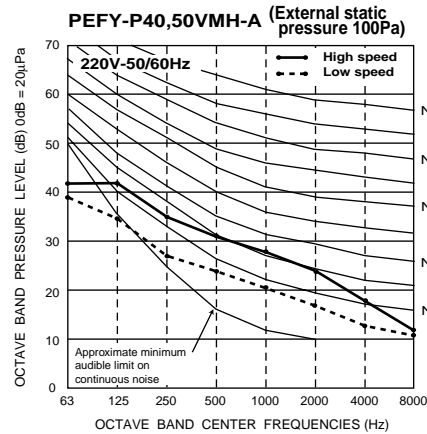
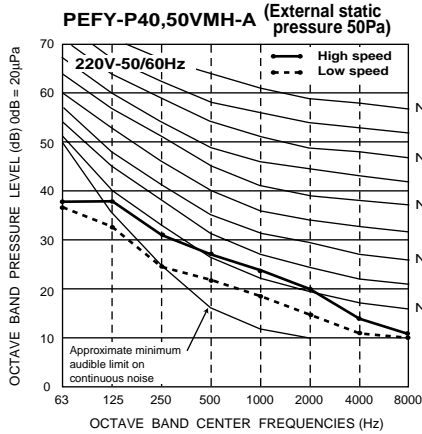

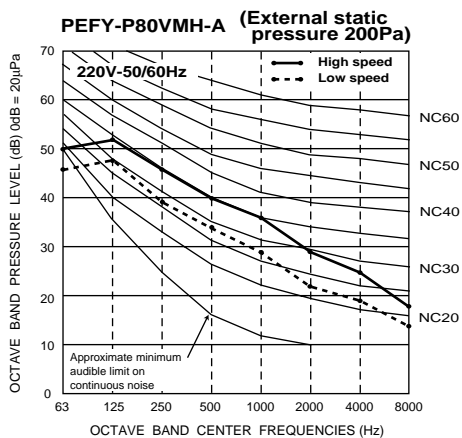
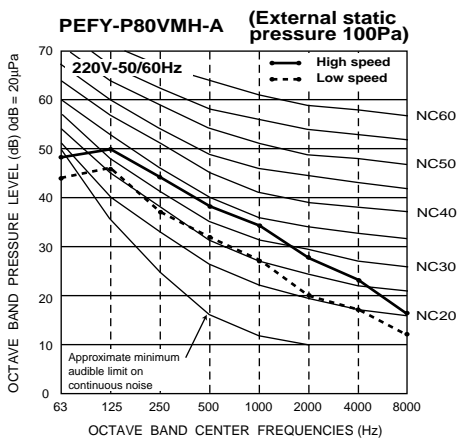
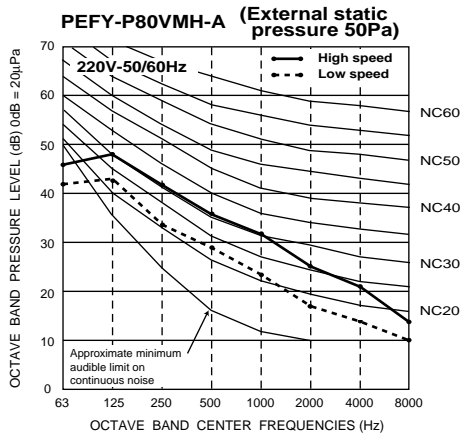
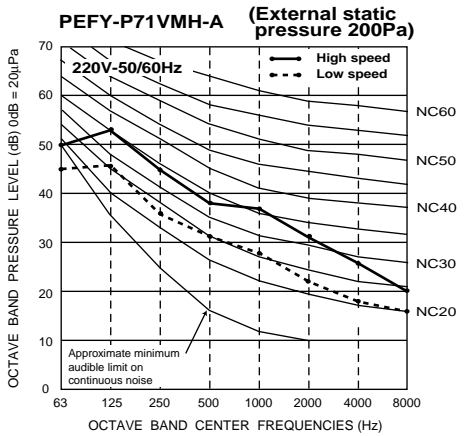
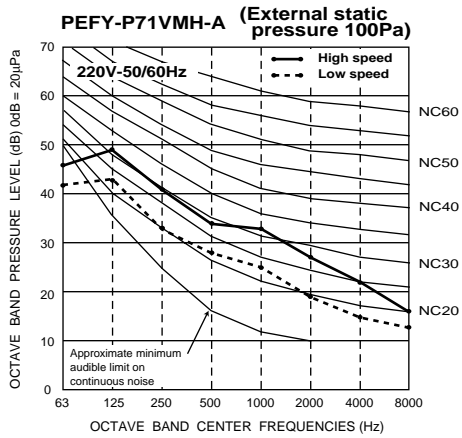
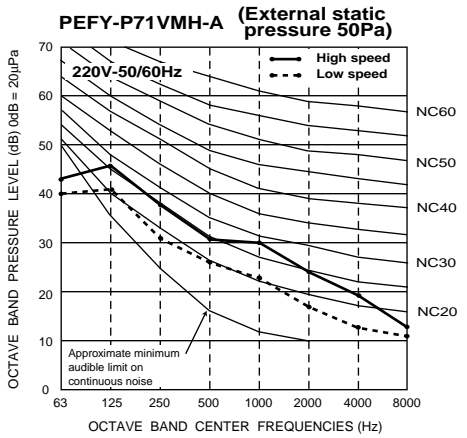
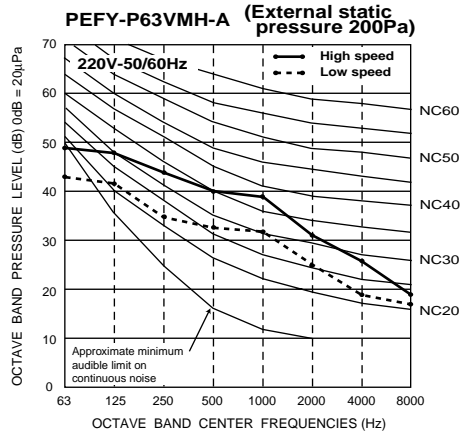
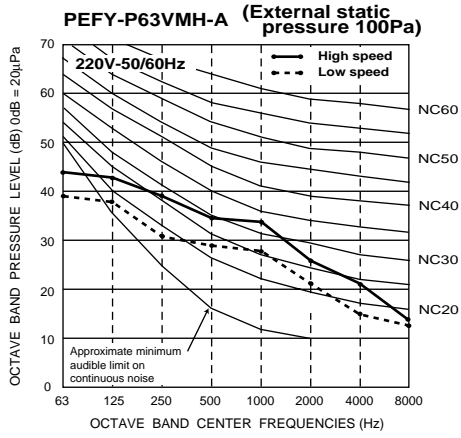

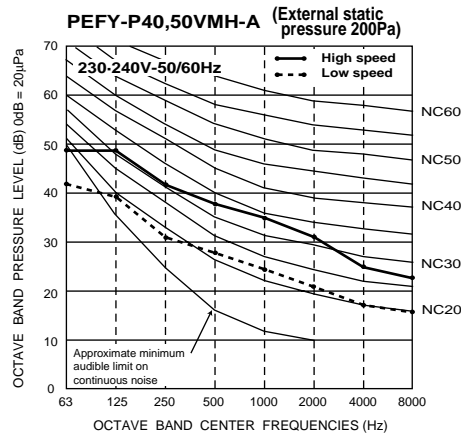
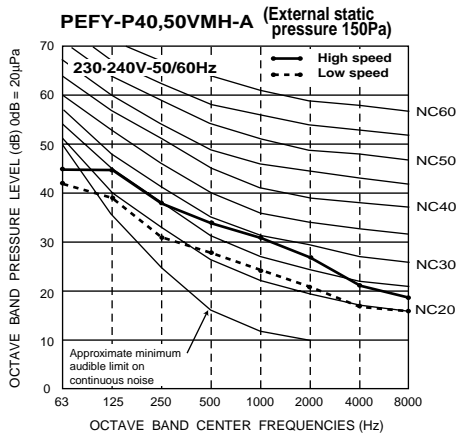
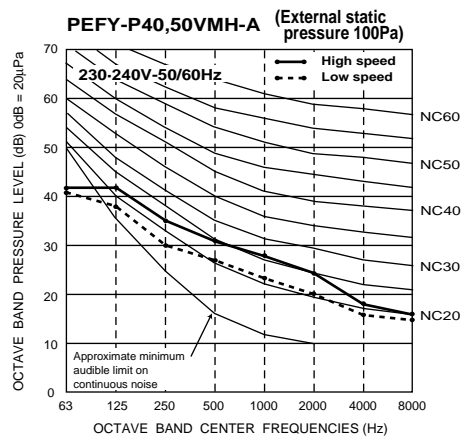
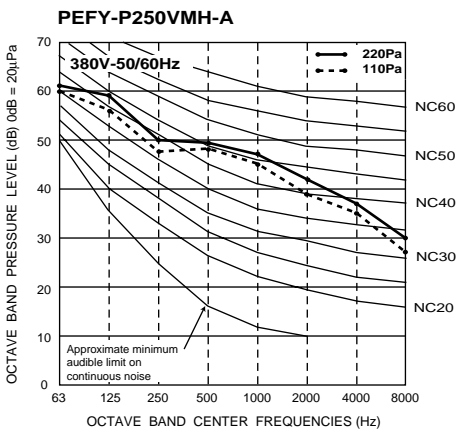
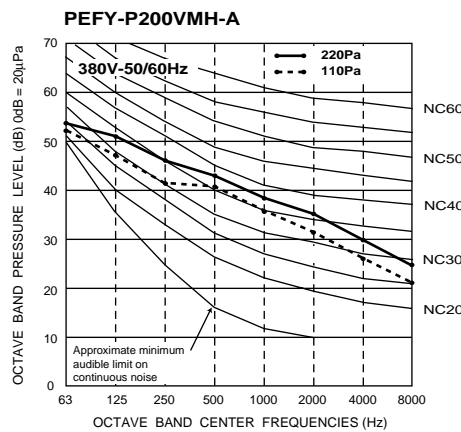
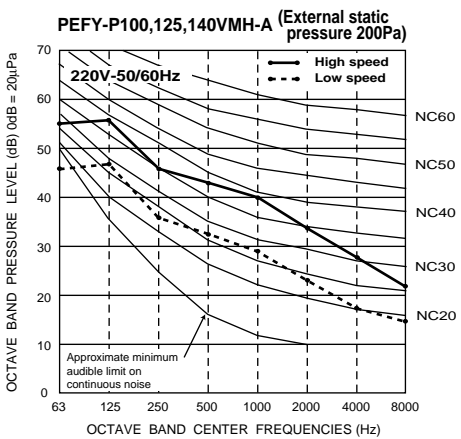
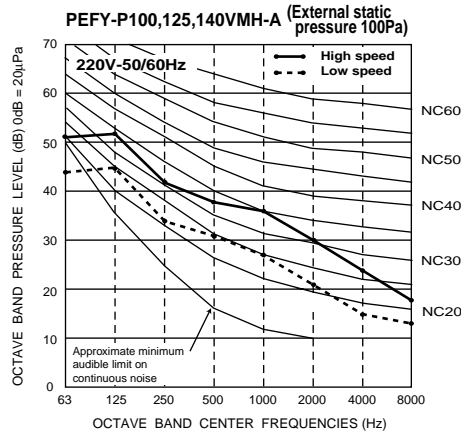
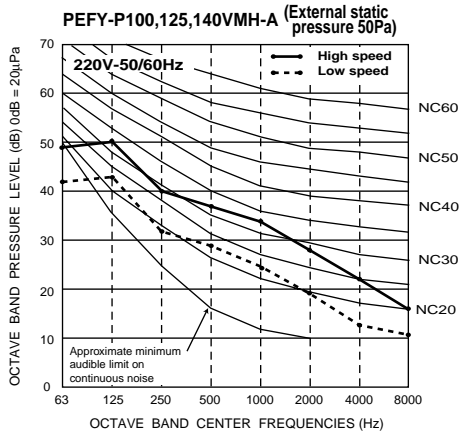

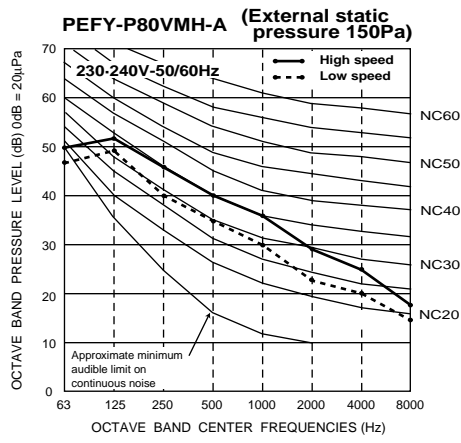
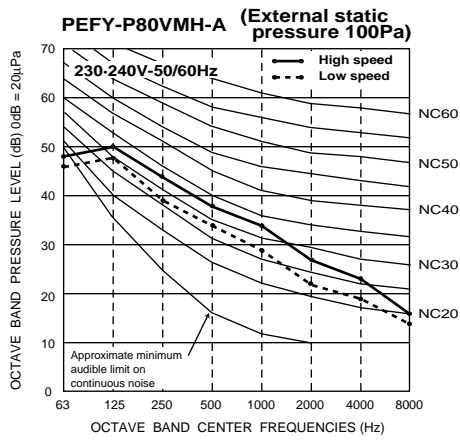
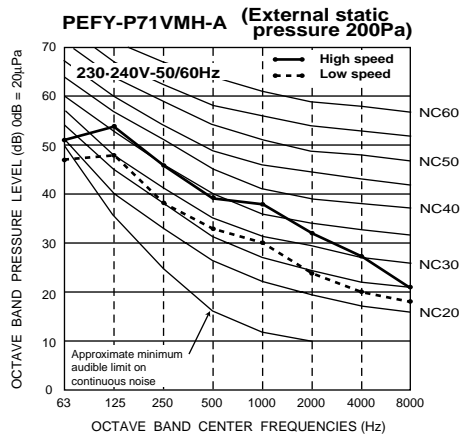
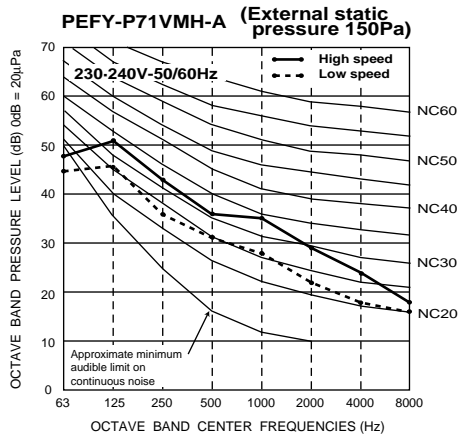
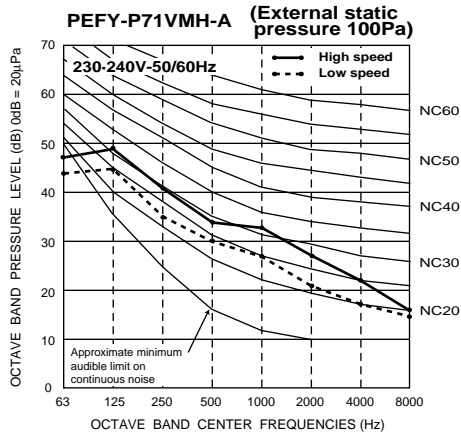
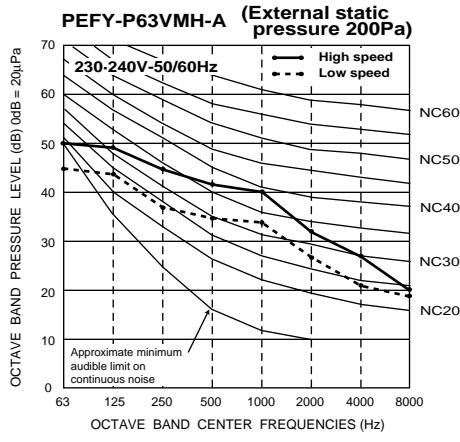
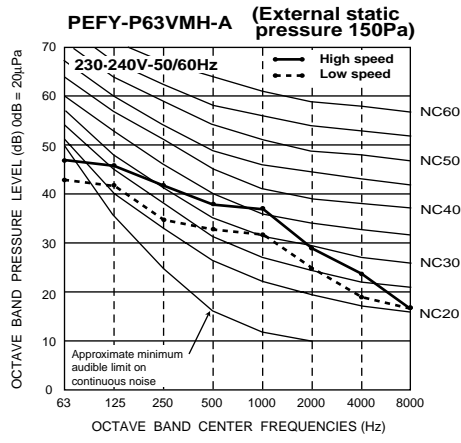
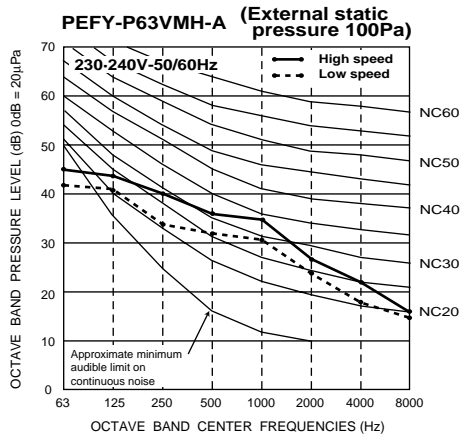

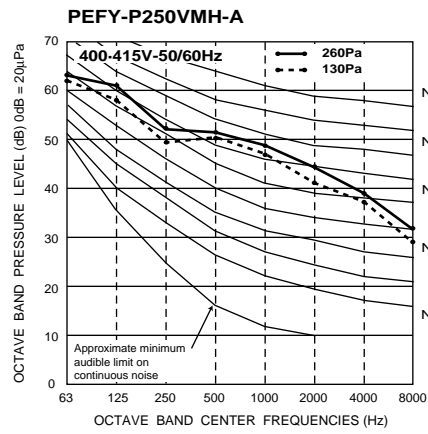
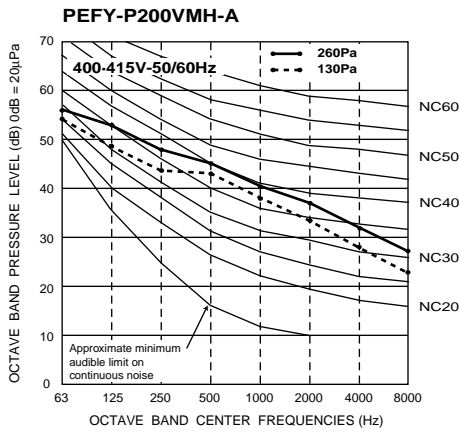
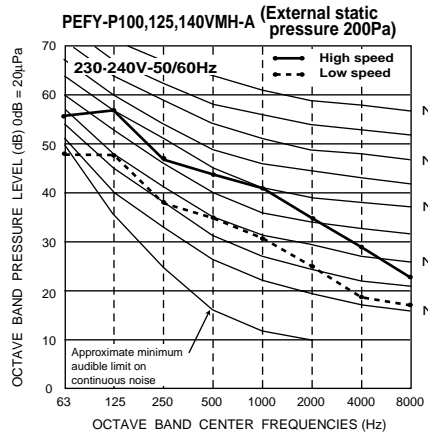
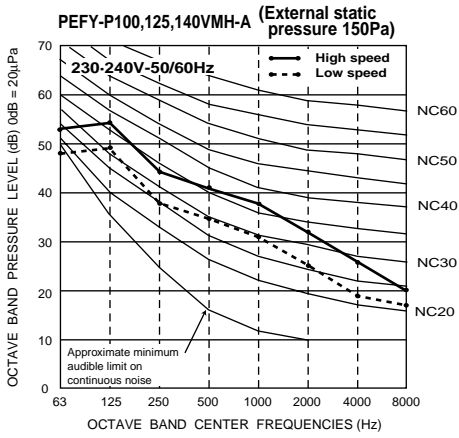
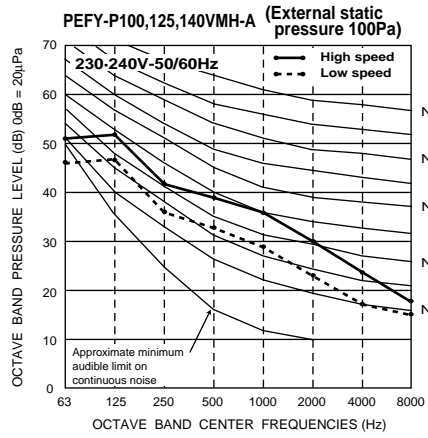
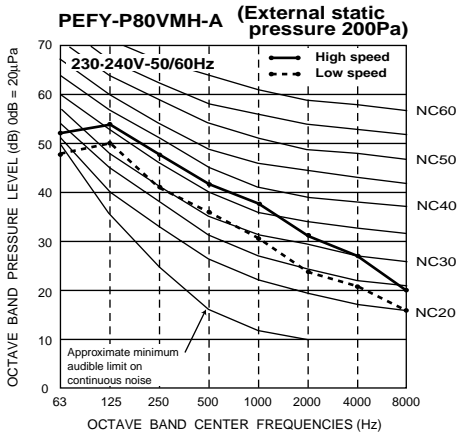

3-6. Fan characteristics curves(VMH-A)

PEFY-P40,50VMH-A
 Suction : Back inlet
 External static pressure : 50,100,200Pa
 Power source : 220(V)

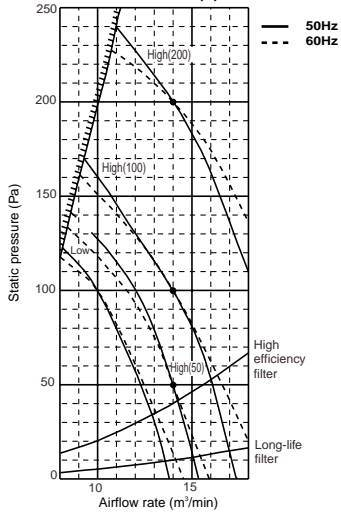

PEFY-P40,50VMH-A
 Suction : Back inlet
 External static pressure : 100,150,200Pa
 Power source : 230,240(V)

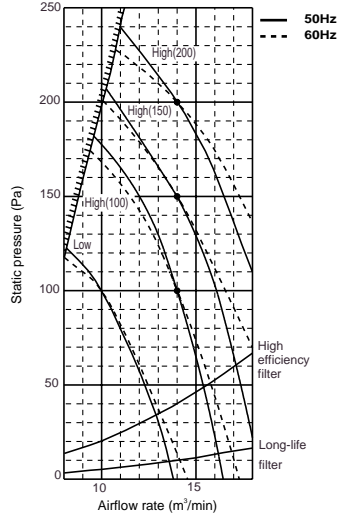

PEFY-P63VMH-A
 Suction : Back inlet
 External static pressure : 50,100,200Pa
 Power source : 220(V)

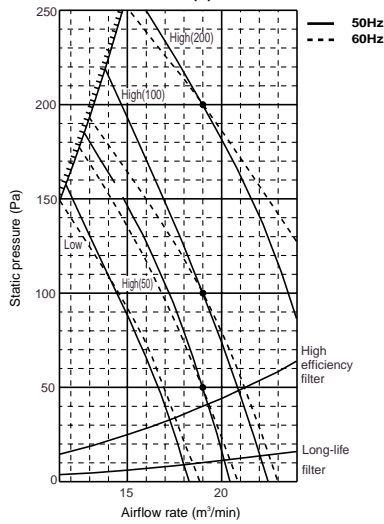

PEFY-P63VMH-A
 Suction : Back inlet
 External static pressure : 100,150,200Pa
 Power source : 230-240(V)

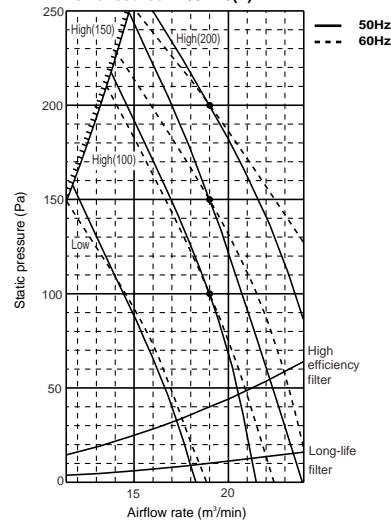

PEFY-P71VMH-A
 Suction : Back inlet
 External static pressure : 50,100,200Pa
 Power source : 220(V)

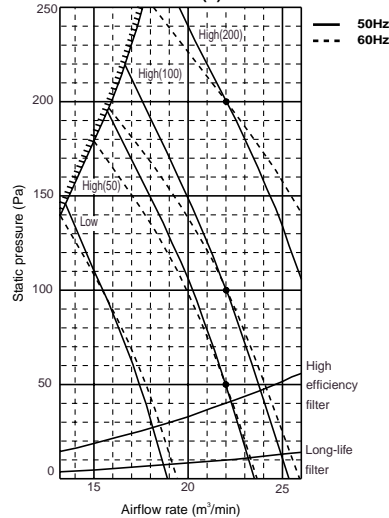

PEFY-P71VMH-A
 Suction : Back inlet
 External static pressure : 100,150,200Pa
 Power source : 230-240(V)

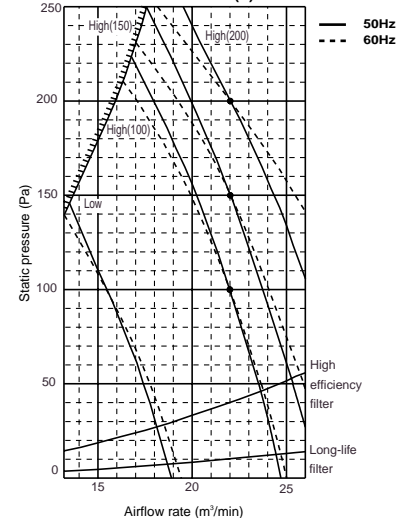

PEFY-P80VMH-A

Suction : Back inlet
External static pressure : 50,100,200Pa
Power source : 220(V)

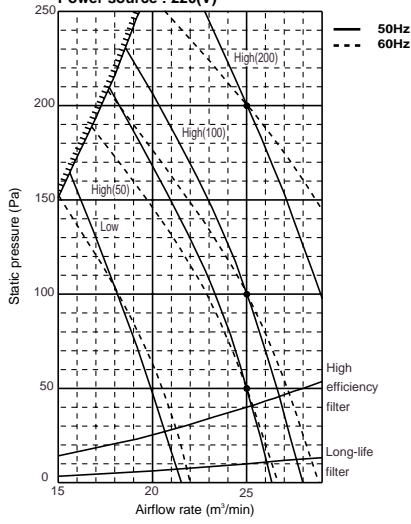

PEFY-P80VMH-A

Suction : Back inlet
External static pressure : 100,150,200Pa
Power source : 230-240(V)

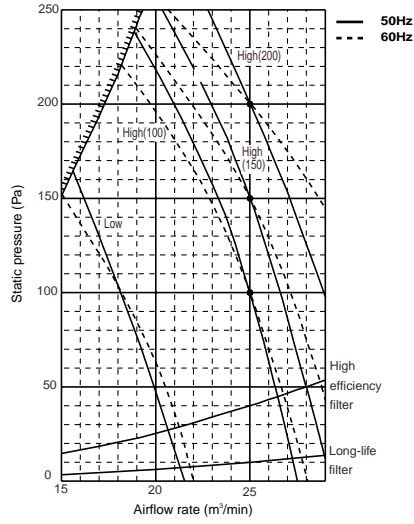

PEFY-P100-125VMH-A

Suction : Back inlet
External static pressure : 50,100,200Pa
Power source : 220(V)

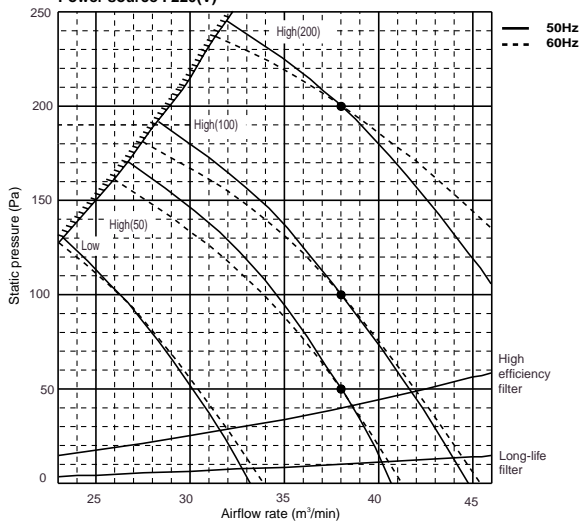

PEFY-P100-125VMH-A

Suction : Back inlet
External static pressure : 100,150,200Pa
Power source : 230-240(V)

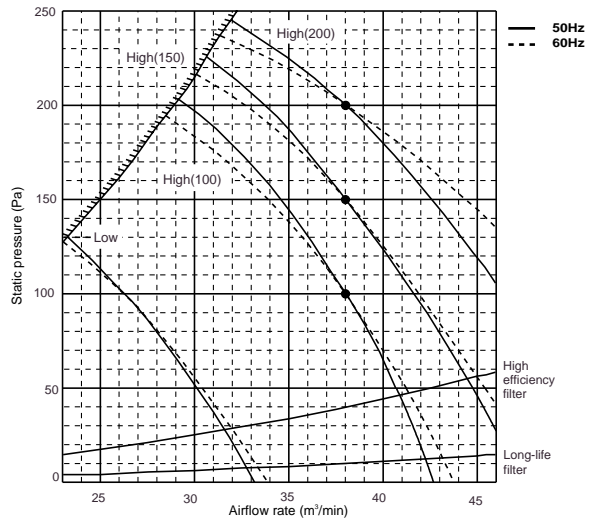

PEFY-P140VMH-A

Suction : Back inlet
External static pressure : 50,100,200Pa
Power source : 220(V)

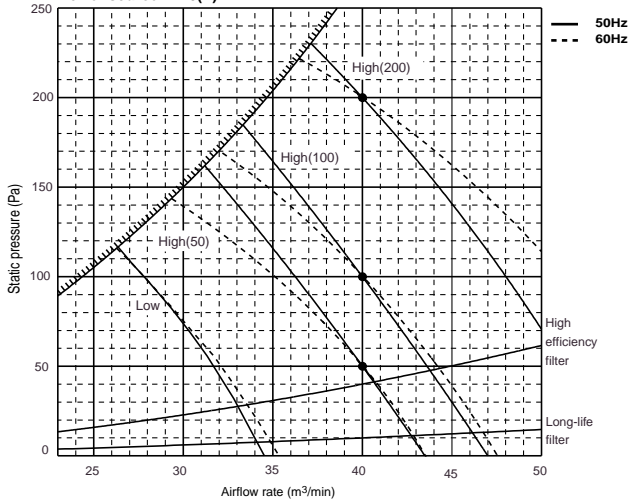

PEFY-P140VMH-A

Suction : Back inlet
External static pressure : 100,150,200Pa
Power source : 230-240(V)

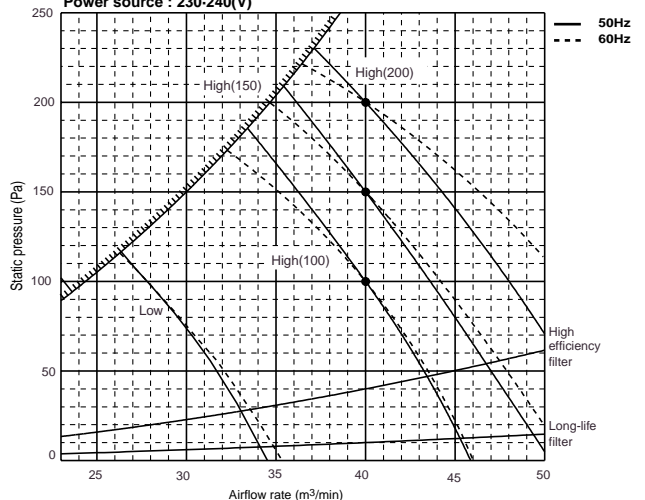

PEFY-P200VMH-A

Suction : Back inlet
 External static pressure : 110,220Pa
 Power source : 380(V)

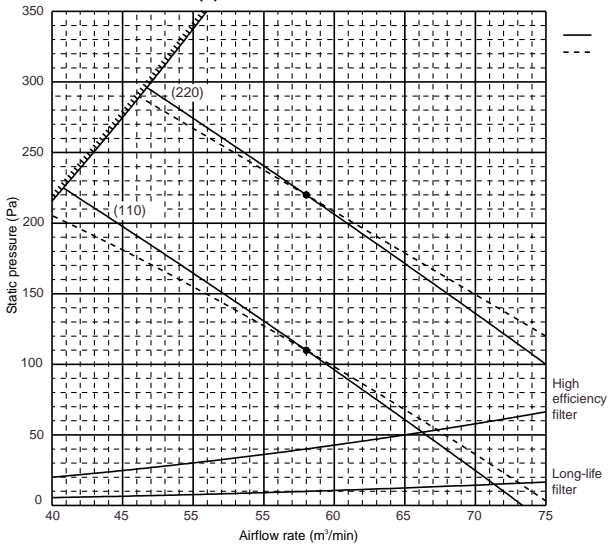

PEFY-P200VMH-A

Suction : Back inlet
 External static pressure : 130,260Pa
 Power source : 400-415(V)

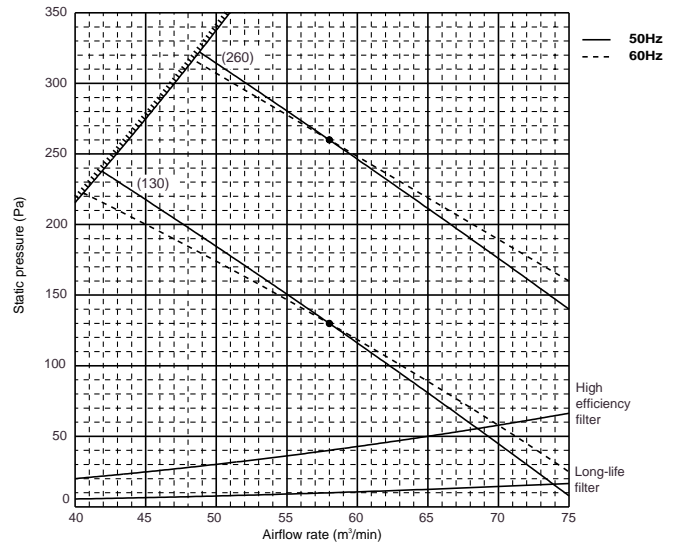

PEFY-P250VMH-A

Suction : Back inlet
 External static pressure : 110,220Pa
 Power source : 380(V)

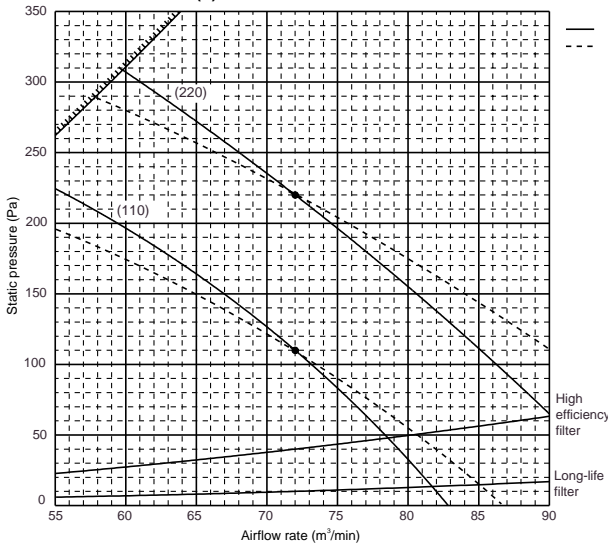

PEFY-P250VMH-A

Suction : Back inlet
 External static pressure : 130,260Pa
 Power source : 400-415(V)

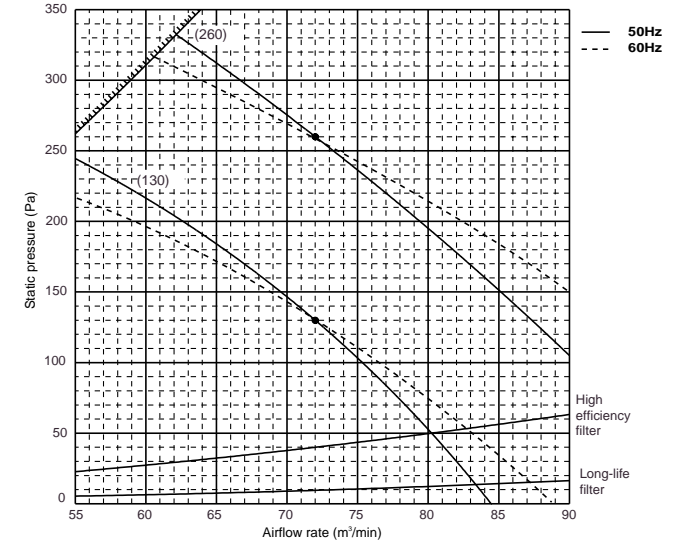

PEFY-P-VML-A1/VMH-A

4. External Dimensions

PEFY-P-
VML-A1/VMH-A

PEFY-P20,25,32VML-A1

Unit : mm

Note : 1. Use M10 screw for the lifting bolt (field supply).
2. Keep the service space for the maintenance from the bottom when the heat exchanger is cleaned.

Refrigerant piping brazing connection (gas ϕ 12.7 copper tube): HP ①
Refrigerant piping brazing connection (liquid ϕ 6.35 copper tube): LP ②
Drain piping connection R1 (External thread) ③

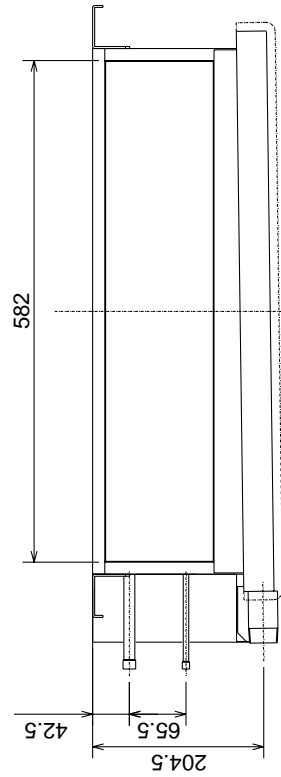
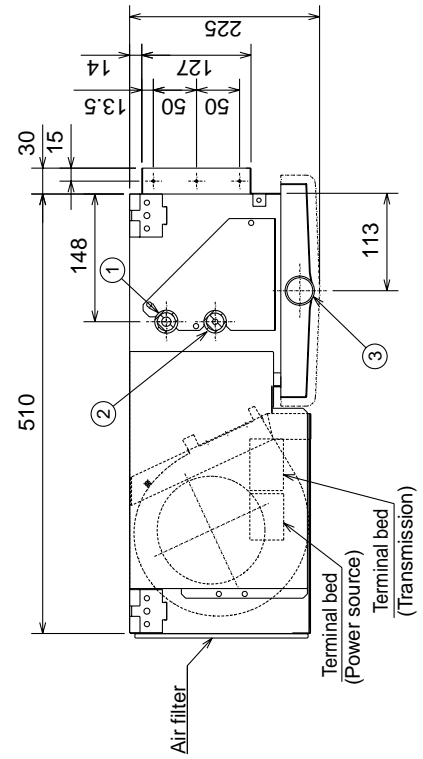
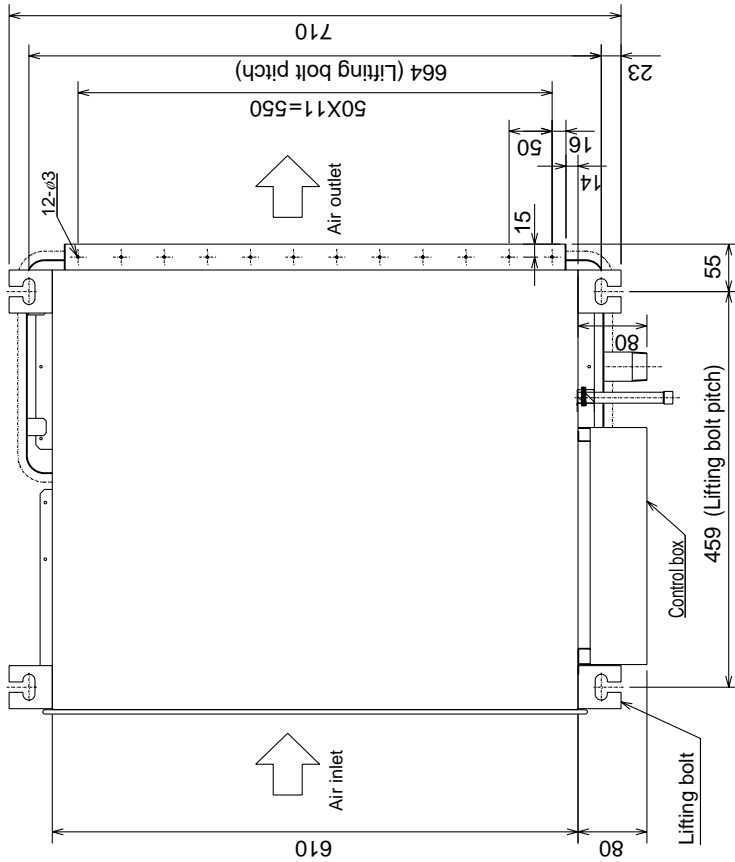

**PEFY-P40,50,63,71,80,
100,125,140VMH-A**

Unit : mm

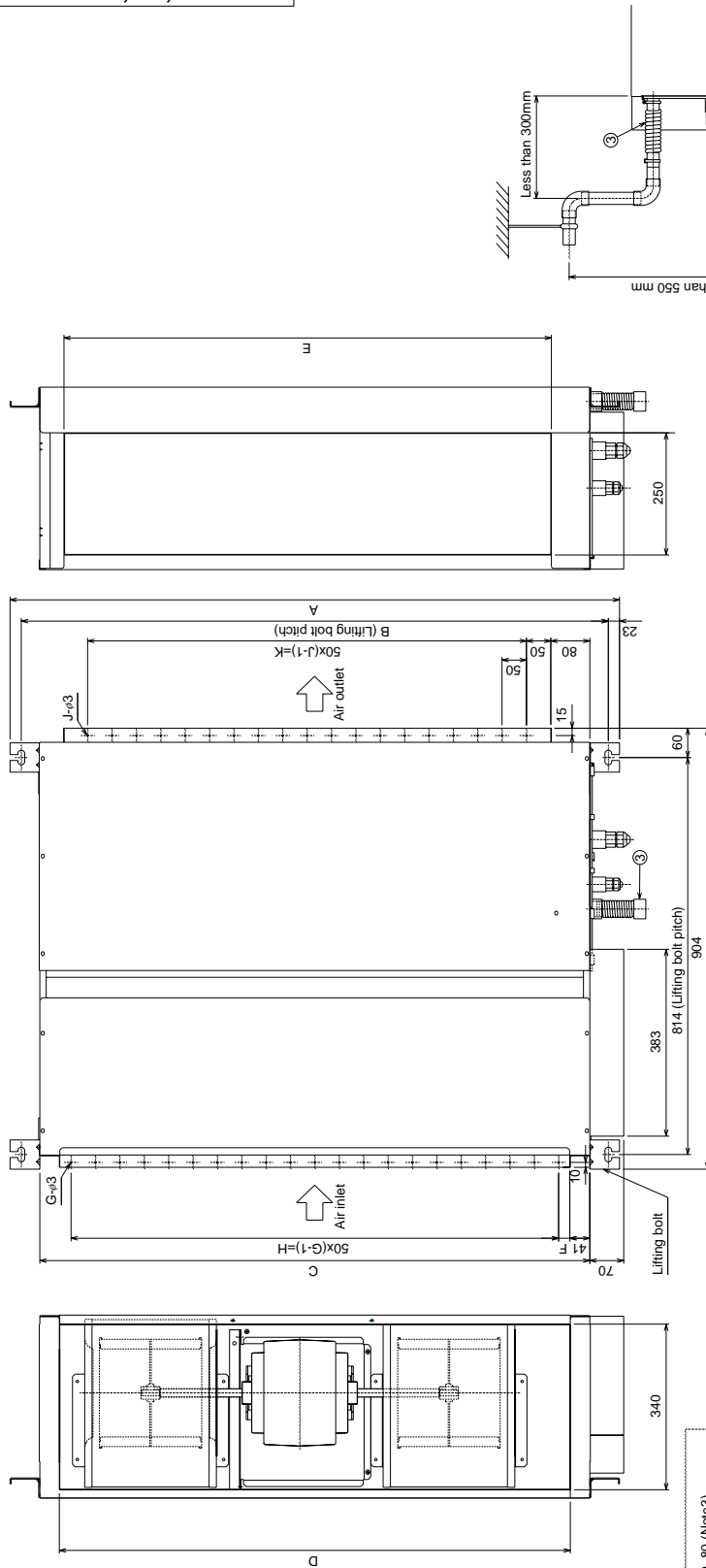

When installing the drain water lifting-up mech(option).

Model	A	B	C	D	E	F	G	H	J	K	M	N
PEFY-P40VMH-A	800	754	680	600	550	50	11	500	10	450	ø12.7	ø6.35
PEFY-P50-63VMH-A	800	754	680	600	550	50	11	500	10	450	ø15.88	ø9.52
PEFY-P71-80VMH-A	1050	1004	930	850	800	25	17	800	15	700	ø15.88	ø9.52
PEFY-P100-125-140VMH-A	1250	1204	1130	1050	1000	25	21	1000	19	900	ø19.05	ø9.52

- Note : 1. Use M10 screw for the lifting bolt (field supply).
 2. Keep the service space for the maintenance from the bottom when the heat exchanger is cleaned.
 3. This chart indicates for PEFY-P100,125,140VMH-A models, which has 2 fans.
 4. PEFY-P40,50,63,71-80 models have 1 fan.
 5. Make sure to install the air filter (field supply) on the air intake side.
 In case field supplied air filter is used, attach it where the filter service is easily done.
 Refrigerant piping flare connection (gas M copper tube): LP ... ①
 Refrigerant piping flare connection (liquid N copper tube): LP ... ②
 Drain hose 52mm(1-1/4inch) <flexible joint 200mm> (accessory) ... ③

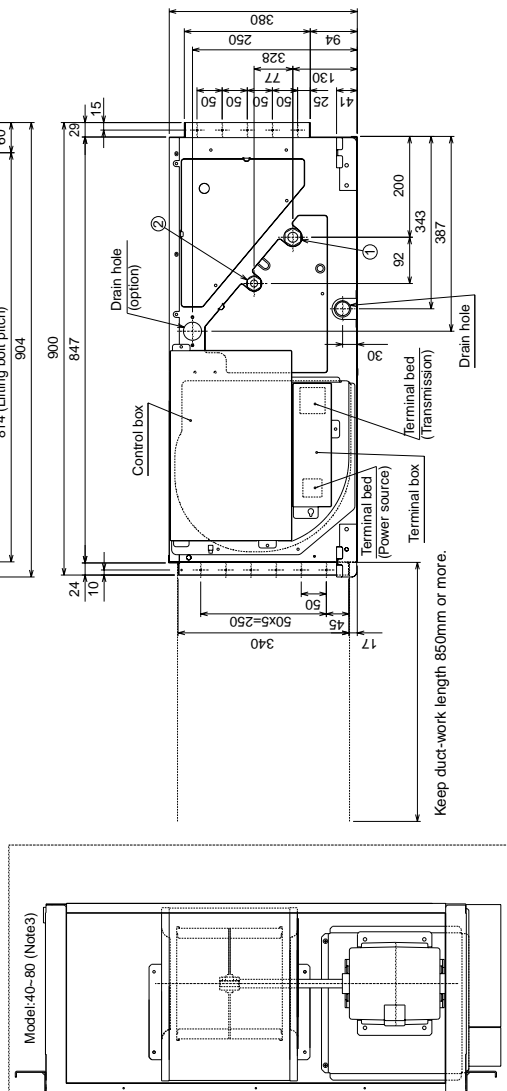

PEFY-P200, 250VMH-A

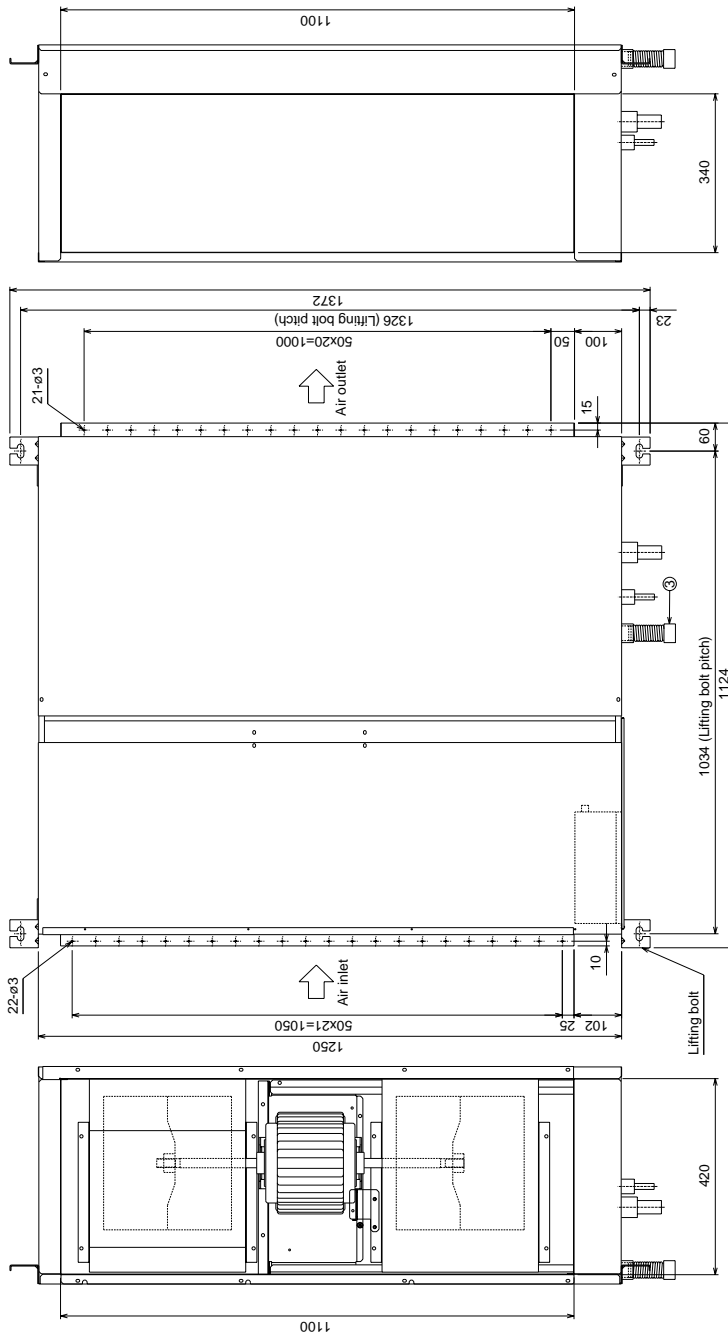

- Note : 1. Use M10 screw for the lifting bolt (field supply).
 2. Keep the service space for the maintenance from the bottom when the heat exchanger is cleaned.
 3. Make sure to install the air filter(field supply) on the air intake side.
 In case field supplied air filter is used, attach it where the filter service is easily done.

Model	A	B
PEFY-P200VMH-A	ø25.4	ø12.7
PEFY-P250VMH-A	ø28.58	ø12.7

Refrigerant piping brazing connection (gas A copper tube): HP
 Refrigerant piping brazing connection (liquid B copper tube): LP
 Drain hose 32mm(1-1/4inch) flexible joint 200mm (accessory).....③

Unit : mm

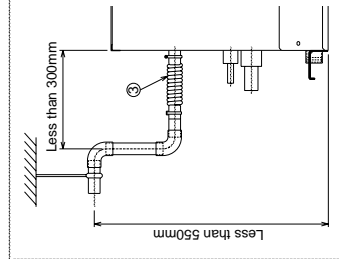

When installing the drain water lifting-up mech(option).

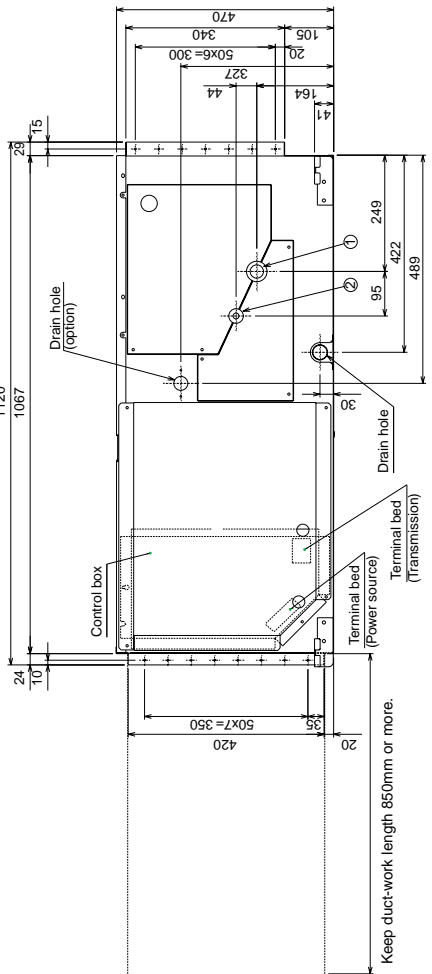

Keep duct-work length 850mm or more.

5. Electrical Wiring Diagrams

PEFY-P20~32VML-A1

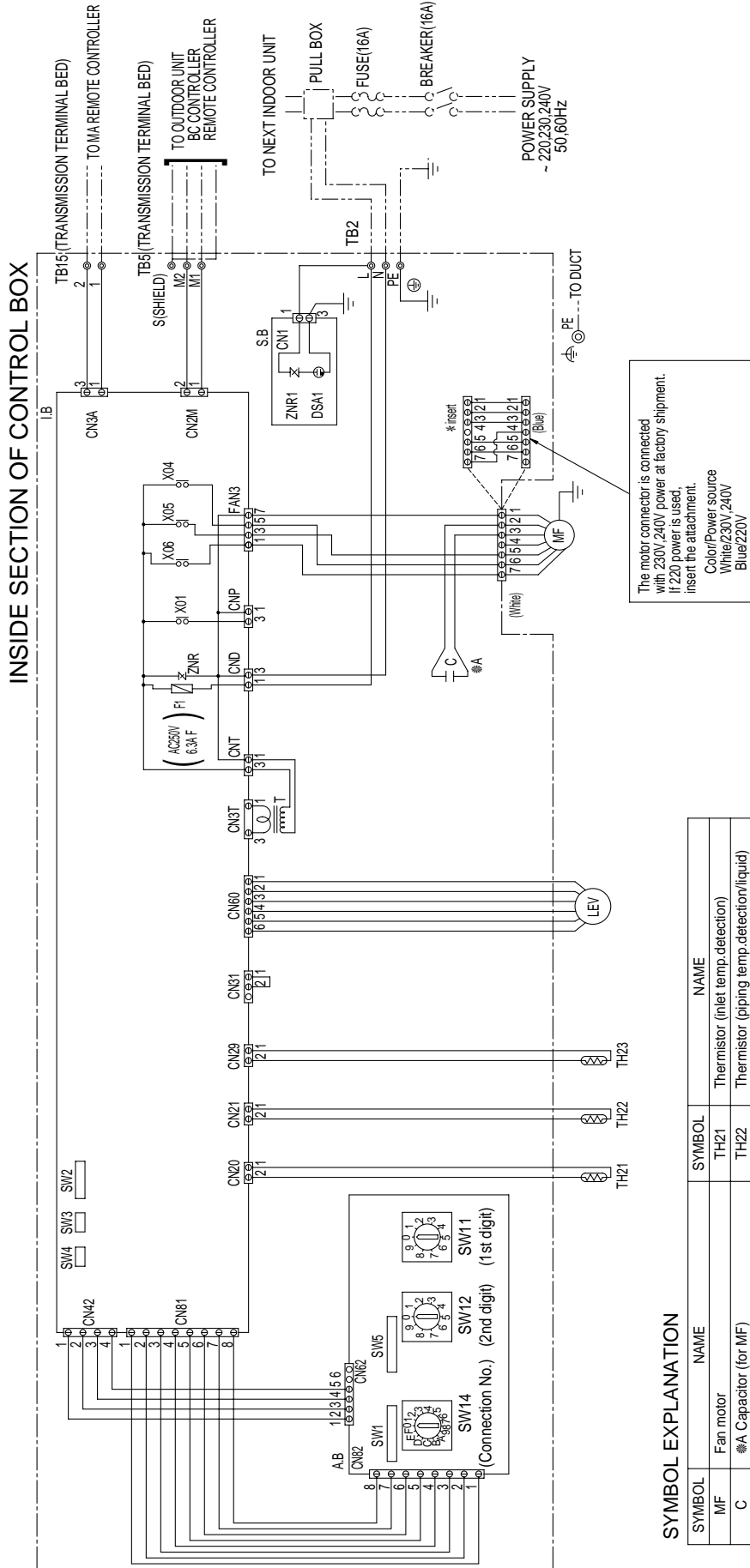

NOTE : 1. The wirings to TB2, TB5 shown in dotted line are field work.
2. Mark ⊕ indicates terminal bed, ⊖ connector, ⊕ board, ⊖ insertion connector or fastening connector of control board.

※A Capacitor
 MODELS 20/25 1.5μF
 MODEL 32 2.0μF

SYMBOL EXPLANATION

SYMBOL	NAME	SYMBOL	NAME
MF	Fan motor	TH21	Thermistor (inlet temp. detection)
C	※A Capacitor (for MF)	TH22	Thermistor (piping temp. detection/liquid)
I.B	Indoor controller board	TH23	Thermistor (piping temp. detection/gas)
A.B	Address board	SW11(A,B)	Switch (1st digit address set)
TB2	Power source terminal bed	SW12(A,B)	Switch (2nd digit address set)
TB5	Transmission terminal bed	SW14(A,B)	Switch (connection No.set)
F1	Fuse AC250V 6.3A.F	SW1(A,B)	Switch(for mode selection)
T	Transformer	SW2(L,B)	Switch(for capacity code)
LEV	Electronic linear expan. valve	SW3(L,B)	Switch(for mode selection)
S.B	Surge absorber board	SW4(L,B)	Switch(for model selection)
X04~X06	Aux.relay	SW5(A,B)	Switch(for voltage selection)



PEFY-P40~140VMH-A

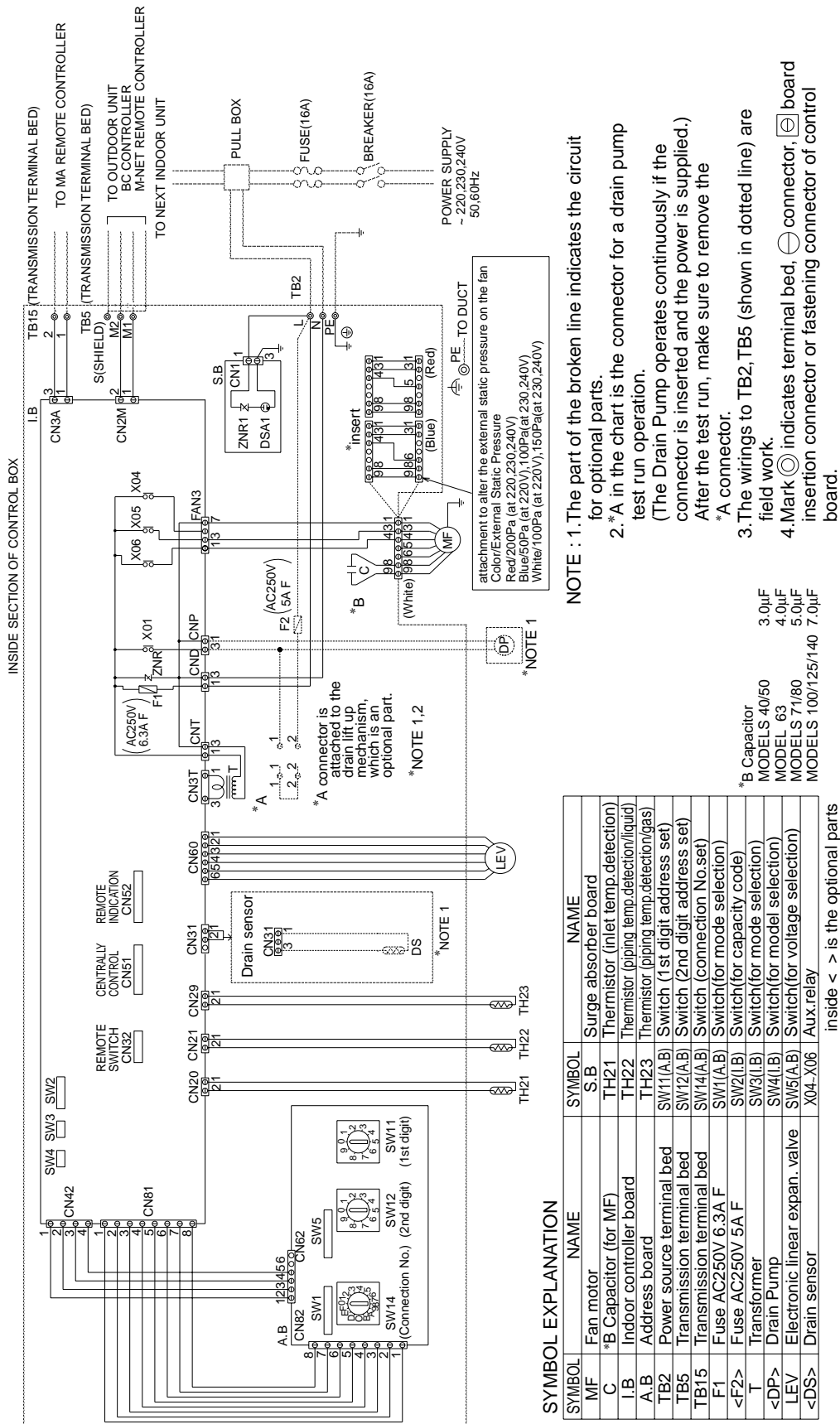

PEFY-P200-250VMH-A

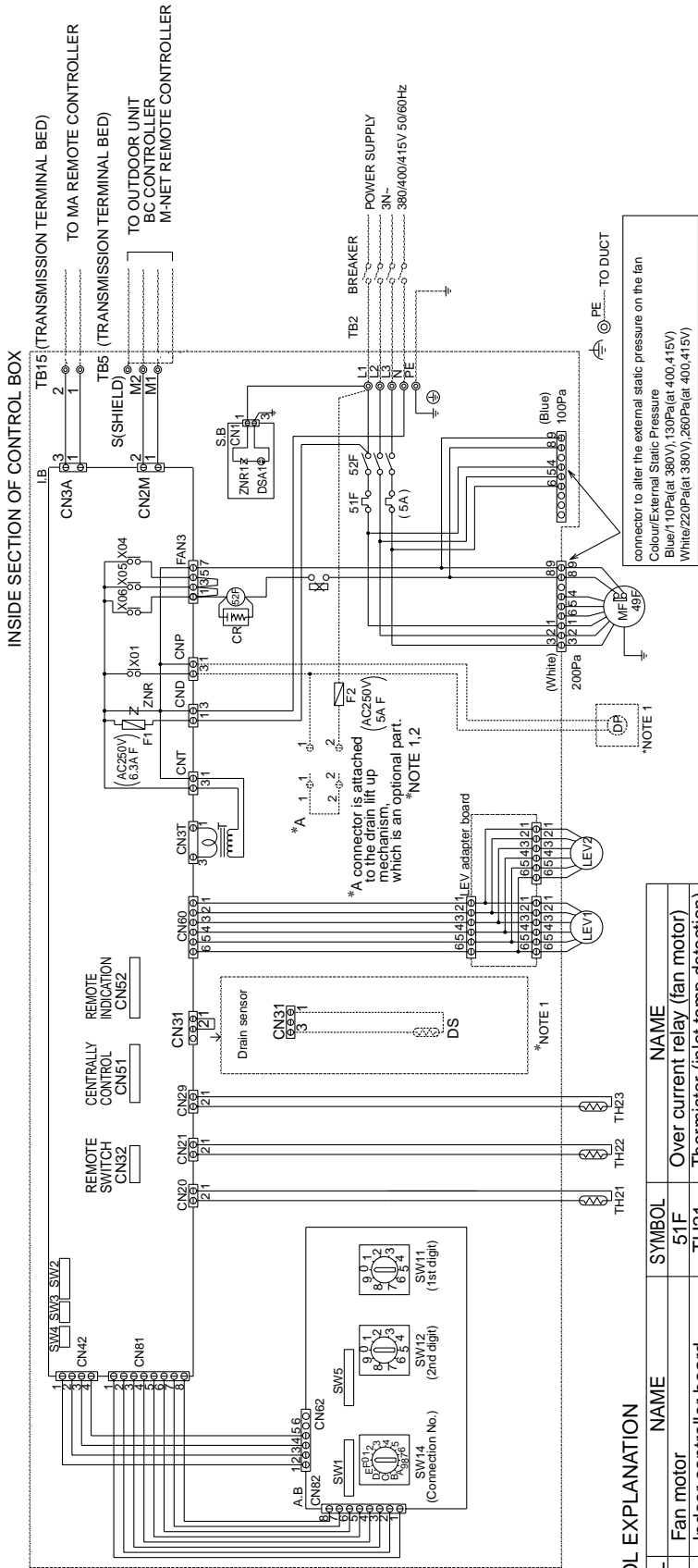

SYMBOL EXPLANATION

SYMBOL	NAME	SYMBOL	NAME
MF	Fan motor	51F	Over current relay (fan motor)
IB	Indoor controller board	TH21	Thermistor (inlet temp.detection)
A.B	Address board	TH22	Thermistor (piping temp.detection/liquid)
TB2	Power source terminal bed	TH23	Thermistor (piping temp.detection/gas)
TB5	Transmission terminal bed	SW11(A.B)	Switch (1st digit address set)
TB15	Transmission terminal bed	SW12(A.B)	Switch (2nd digit address set)
F1	Fuse AC250V 6.3A F	SW14(A.B)	Switch (connection No.set)
<F2>	Fuse AC250V 5A F	SW1(A.B)	Switch(for mode selection)
T	Transformer	SW2(IB)	Switch(for capacity code)
<DP>	Drain Pump	SW3(IB)	Switch(for mode selection)
LEV1,LEV2	Electronic linear expans. valve	SW4(IB)	Switch(for mode selection)
<DS>	Drain sensor	SW5(A.B)	Switch(for voltage selection)
S.B	Surge absorber board	X04-X06	Aux.relay
52F	Contactor (fan motor)	49F	Inner thermostat

inside < > is the optional parts

CAUTION : 1. To protect Fan motor from abnormal current. Over current relays <51F> is installed. Therefore, do not change factory set value of Over current relays.

- NOTE :** 1. The part of the broken line indicates the circuit for optional parts.
 2. *A in the chart is the connector for a drain pump test run operation. (The Drain Pump operates continuously if the connector is inserted and the power is supplied.)
 After the test run, make sure to remove the *A connector.
 3. The wirings to TB2, TB5 shown in dotted line are field work.
 4. Mark ⊕ indicates terminal bed, ⊖ connector, ⊞ board insertion connector or fastening connector of control board.

6. Options

PEY-P-
VML-A1/VMH-A

Description	Model	Applicable capacity
Long life filter	PAC-KE32LAF-F	P20/P25/P32
	PAC-KE86LAF	P40/P50/P63
	PAC-KE88LAF	P71/P80
	PAC-KE89LAF	P100/P125/P140
	PAC-KE85LAF	P200/P250
Filter box	PAC-KE63TB-F	P40/P50/P63
	PAC-KE80TB-F	P71/P80
	PAC-KE140TB-F	P100/P125/P140
	PAC-KE250TB-F	P200/P250
Drain water lift-up kit	PAC-KE04DM-F	P40/P50/P63/P71/P80/P100 P125/P140/P200/P250

CONTENTS

1. Specifications	II -36
2. Capacity Tables	II -38
2-1 Cooling Capacity(PUMY)	II -38
2-2 Heating Capacity(PUMY)	II -40
2-3 Cooling Capacity(Y/R2-8-10-13HP)	II -41
2-4 Heating Capacity(Y/R2-8-10-13HP)	II -43
2-5 Cooling Capacity(Big Y, Super Y, Big R2)	II -44
2-6 Heating Capacity(Big Y, Super Y, Big R2)	II -46
2-7 Cooling Capacity(WY, WR2)	II -47
2-8 Heating Capacity(WY, WR2)	II -48
3. Sound Levels	II -49
3-1 Sound levels(VMM-A)	II -49
3-2 N/C curves(VMM-A)	II -49
3-3 Fan characteristics curves(VMM-A)	II -56
4. External Dimensions	II -58
5. Electrical Wiring Diagrams	II -60
6. Options	II -62

1. Specifications

PEFY-P-VMM-A

			PEFY-P20VMM-A	PEFY-P25VMM-A	PEFY-P32VMM-A	PEFY-P40VMM-A
Power source			~220-240V 50Hz			
Cooling capacity	* 1	kW	2.2	2.8	3.6	4.5
	* 2	kcal/h	2,000	2,500	3,150	4,000
Heating capacity	* 1	kW	2.5	3.2	4.0	5.0
Power consumption (50Hz)	Cooling	kW	0.15		0.17	0.19
	Heating	kW	0.15		0.17	0.19
Current	Cooling	A	0.73		0.81	0.92
	Heating	A	0.73		0.81	0.92
External finish			Galvanizing			
Dimension	Height	mm	295			
	Width	mm	815		935	
	Depth	mm	700			
Net weight		kg	27		33	
Heat exchanger			Cross fin (Aluminum plate fin and copper tube)			
Fan	Type		Sirocco fanX 1			Sirocco fanX 2
	Airflow rate (Lo-Mid-Hi)	m ³ /min	6.0-7.2-8.5		7.5-9.0-10.5	10.0-12.0-14.0
	External static pressure	Pa	30/50/100			
Motor	Type		Single phase induction motor			
	Output	kW	0.075			
Air filter			PP Honeycomb fabric (washable)			
Refrigerant pipe dimension	Gas (Flare)	mm	ø 12.7			
	Liquid (Flare)	mm	ø 6.35			
Drain pipe dimension			R1 (External thread)			
Noise level (Lo-Mid-Hi)	* 3	dB(A)	27-30-32		28-32-35	31-34-37

			PEFY-P50VMM-A	PEFY-P63VMM-A	PEFY-P71VMM-A	PEFY-P80VMM-A
Power source			~220-240V 50Hz			
Cooling capacity	* 1	kW	5.6	7.1	8.0	9.0
	* 2	kcal/h	5,000	6,300	7,100	8,000
Heating capacity	* 1	kW	6.3	8.0	9.0	10.0
Power consumption (50Hz)	Cooling	kW	0.20	0.22	0.25	
	Heating	kW	0.20	0.22	0.25	
Current	Cooling	A	0.98	1.07	1.15	
	Heating	A	0.98	1.07	1.15	
External finish			Galvanizing			
Dimension	Height	mm	295			
	Width	mm	935	1175		
	Depth	mm	700			
Net weight		kg	33	42		
Heat exchanger			Cross fin (Aluminum plate fin and copper tube)			
Fan	Type		Sirocco fanX2			
	Airflow rate (Lo-Hi)	m ³ /min	12.0-14.5-17.0	13.5-16.2-19.0	14.5-18.0-21.0	
	External static pressure	Pa	30/50/100			
Motor	Type		Single phase induction motor			
	Output	kW	0.075	0.078		
Air filter			PP Honeycomb fabric (washable)			
Refrigerant pipe dimension	Gas (Flare)	mm	ø 15.88			
	Liquid (Flare)	mm	ø 9.52			
Drain pipe dimension			R1 (External thread)			
Noise level (Lo-Mid-Hi)	* 3	dB(A)	31-35-38		32-36-39	

Note: * 1 Cooling/Heating capacity indicates the maximum value at operation under the following condition.

Cooling : Indoor 27°CDB/19°CWB, Outdoor 35°CDB

Heating : Indoor 20°CDB, Outdoor 7°CDB/6°CWB

* 2 Cooling capacity indicates the maximum value at operation under the following condition.

Cooling : Indoor 27°CDB/19.5°CWB, Outdoor 35°CDB (WR2: water 30°C)

* 3 It is measured in anechoic room.

			PEFY-P100VMM-A	PEFY-P125VMM-A	PEFY-P140VMM-A
Power source			~220-240V 50Hz		
Cooling capacity	* 1	kW	11.2	14.0	16.0
	* 2	kcal/h	10,000	12,500	14,000
Heating capacity	* 1	kW	12.5	16.0	18.0
Power consumption (50/60Hz)	Cooling	kW	0.29	0.40	0.42
	Heating	kW	0.29	0.40	0.42
Current	Cooling	A	1.34	1.90	1.95
	Heating	A	1.34	1.90	1.95
External finish			Galvanizing		
Dimension	Height	mm	325		
	Width	mm	1415	1715	
	Depth	mm	740		
Net weight		kg	62	65	70
Heat exchanger			Cross fin (Aluminum plate fin and copper tube)		
Fan	Type		Sirocco fanX2		
	Airflow rate (Lo-Hi)	m ³ /min	23.0-33.0	28.0-40.0	29.5-42.0
	External static pressure		Pa		
Motor	Type		Single phase induction motor		
	Output	kW	0.200	0.280	
Air filter			PP Honeycomb fabric (washable)		
Refrigerant pipe dimension	Gas (Flare)	mm	ø 19.05		
	Liquid (Flare)	mm	ø 9.52		
Drain pipe dimension			R1 (External thread)		
Noise level (Lo-Mid-Hi)	* 3	dB(A)	40-44	42-45	42-45

Note: * 1 Cooling/Heating capacity indicates the maximum value at operation under the following condition.
Cooling : Indoor 27°CDB/19°CWB, Outdoor 35°CDB
Heating : Indoor 20°CDB, Outdoor 7°CDB/6°CWB
* 2 Cooling capacity indicates the maximum value at operation under the following condition.
Cooling : Indoor 27°CDB/19.5°CWB, Outdoor 35°CDB (WR2: water 30°C)
* 3 It is measured in anechoic room.

2. Capacity Table

2-1.Cooling Capacity (In combination with PUMY)

CA:Capacity(kW)
SHC:Sensible Heat Capacity(kW)

PEFY-P-VMM-A

Unit size	Outdoor air temp.	Indoor air temp.							
		23°CDB 16°CWB		25°CDB 18°CWB		28°CDB 20°CWB		30°CDB 22°CWB	
		°CDB	CA	SHC	CA	SHC	CA	SHC	CA
20 (2.2)	20.0	2.2	1.8	2.3	1.9	2.4	1.9	2.6	1.9
	22.5	2.1	1.8	2.3	1.9	2.4	1.9	2.6	1.9
	25.0	2.1	1.8	2.3	1.9	2.4	1.8	2.5	1.9
	27.5	2.1	1.8	2.2	1.9	2.4	1.8	2.5	1.9
	30.0	2.1	1.7	2.2	1.8	2.3	1.8	2.5	1.9
	32.5	2.0	1.7	2.2	1.8	2.3	1.8	2.5	1.9
	35.0	2.0	1.7	2.1	1.8	2.3	1.8	2.4	1.9
	37.5	2.0	1.7	2.1	1.8	2.2	1.8	2.4	1.9
	40.0	2.0	1.7	2.1	1.8	2.2	1.8	2.4	1.8
46.0	1.9	1.7	2.0	1.8	2.1	1.7	2.3	1.8	
25 (2.8)	20.0	2.8	2.1	2.9	2.2	3.1	2.2	3.3	2.2
	22.5	2.7	2.1	2.9	2.2	3.1	2.1	3.2	2.2
	25.0	2.7	2.1	2.9	2.1	3.1	2.1	3.2	2.2
	27.5	2.7	2.0	2.8	2.1	3.0	2.1	3.2	2.2
	30.0	2.6	2.0	2.8	2.1	3.0	2.1	3.2	2.2
	32.5	2.6	2.0	2.8	2.1	2.9	2.1	3.1	2.2
	35.0	2.6	2.0	2.7	2.1	2.9	2.1	3.1	2.1
	37.5	2.5	2.0	2.7	2.1	2.9	2.0	3.0	2.1
	40.0	2.5	1.9	2.7	2.1	2.8	2.0	3.0	2.1
46.0	2.4	1.9	2.6	2.0	2.7	2.0	2.9	2.1	
32 (3.6)	20.0	3.6	2.6	3.7	2.7	4.0	2.7	4.2	2.8
	22.5	3.5	2.6	3.7	2.7	4.0	2.7	4.2	2.8
	25.0	3.5	2.6	3.7	2.7	3.9	2.7	4.1	2.8
	27.5	3.4	2.6	3.6	2.7	3.9	2.7	4.1	2.8
	30.0	3.4	2.5	3.6	2.7	3.8	2.6	4.1	2.7
	32.5	3.3	2.5	3.6	2.7	3.8	2.6	4.0	2.7
	35.0	3.3	2.5	3.5	2.6	3.7	2.6	4.0	2.7
	37.5	3.2	2.5	3.5	2.6	3.7	2.6	3.9	2.7
	40.0	3.2	2.5	3.4	2.6	3.6	2.6	3.9	2.6
46.0	3.1	2.4	3.3	2.5	3.5	2.5	3.7	2.6	
40 (4.5)	20.0	4.5	3.4	4.7	3.5	5.0	3.5	5.3	3.6
	22.5	4.4	3.3	4.6	3.5	5.0	3.5	5.2	3.6
	25.0	4.3	3.3	4.6	3.5	4.9	3.5	5.2	3.6
	27.5	4.3	3.3	4.6	3.5	4.9	3.4	5.1	3.5
	30.0	4.2	3.3	4.5	3.4	4.8	3.4	5.1	3.5
	32.5	4.2	3.2	4.4	3.4	4.7	3.4	5.0	3.5
	35.0	4.1	3.2	4.4	3.4	4.7	3.3	5.0	3.5
	37.5	4.1	3.2	4.3	3.4	4.6	3.3	4.9	3.4
	40.0	4.0	3.2	4.3	3.3	4.5	3.3	4.8	3.4
46.0	3.8	3.1	4.1	3.3	4.3	3.2	4.6	3.3	
50 (5.6)	20.0	5.5	4.1	5.8	4.3	6.2	4.3	6.6	4.4
	22.5	5.5	4.1	5.8	4.3	6.2	4.2	6.5	4.4
	25.0	5.4	4.0	5.7	4.2	6.1	4.2	6.4	4.3
	27.5	5.3	4.0	5.7	4.2	6.0	4.2	6.4	4.3
	30.0	5.3	4.0	5.6	4.2	5.9	4.1	6.3	4.3
	32.5	5.2	3.9	5.5	4.1	5.9	4.1	6.2	4.2
	35.0	5.1	3.9	5.5	4.1	5.8	4.1	6.2	4.2
	37.5	5.0	3.9	5.4	4.1	5.7	4.0	6.1	4.2
	40.0	5.0	3.8	5.3	4.0	5.6	4.0	6.0	4.1
46.0	4.8	3.7	5.1	3.9	5.4	3.9	5.8	4.0	
63 (7.1)	20.0	7.0	5.2	7.4	5.4	7.9	5.3	8.3	5.5
	22.5	6.9	5.1	7.3	5.3	7.8	5.3	8.2	5.5
	25.0	6.9	5.1	7.3	5.3	7.7	5.3	8.2	5.4
	27.5	6.8	5.0	7.2	5.3	7.7	5.2	8.1	5.4
	30.0	6.7	5.0	7.1	5.2	7.5	5.2	8.0	5.4
	32.5	6.6	4.9	7.0	5.2	7.5	5.1	7.9	5.3
	35.0	6.5	4.9	6.9	5.1	7.3	5.1	7.8	5.3
	37.5	6.4	4.8	6.8	5.1	7.2	5.0	7.7	5.2
	40.0	6.3	4.8	6.7	5.1	7.2	5.0	7.6	5.2
46.0	6.1	4.7	6.5	4.9	6.9	4.9	7.3	5.1	

PEFY-P-VMM-A

Cooling Capacity (In combination with PUMY)

CA:Capacity(kW)
SHC:Sensible Heat Capacity(kW)

PEFY-P-VMM-A

Unit size	Outdoor air temp.	Indoor air temp.							
		23°CDB 16°CWB		25°CDB 18°CWB		28°CDB 20°CWB		30°CDB 22°CWB	
		°CDB	CA	SHC	CA	SHC	CA	SHC	CA
71 (8.0)	20.0	7.9	5.8	8.3	6.0	8.9	6.0	9.4	6.1
	22.5	7.8	5.7	8.2	6.0	8.8	5.9	9.3	6.1
	25.0	7.7	5.7	8.2	5.9	8.7	5.9	9.2	6.1
	27.5	7.6	5.6	8.1	5.9	8.6	5.9	9.1	6.0
	30.0	7.5	5.6	8.0	5.9	8.5	5.8	9.0	6.0
	32.5	7.4	5.5	7.9	5.8	8.4	5.8	8.9	5.9
	35.0	7.3	5.5	7.8	5.8	8.3	5.7	8.8	5.9
	37.5	7.2	5.4	7.7	5.7	8.2	5.6	8.7	5.9
	40.0	7.1	5.4	7.6	5.7	8.1	5.6	8.6	5.8
46.0	6.8	5.2	7.3	5.5	7.7	5.4	8.2	5.7	
80 (9.0)	20.0	8.9	6.3	9.4	6.5	10.0	6.5	10.6	6.7
	22.5	8.8	6.2	9.3	6.5	9.9	6.5	10.4	6.6
	25.0	8.7	6.2	9.2	6.5	9.8	6.4	10.4	6.6
	27.5	8.6	6.1	9.1	6.4	9.7	6.4	10.3	6.5
	30.0	8.5	6.1	9.0	6.4	9.5	6.3	10.2	6.5
	32.5	8.3	6.0	8.9	6.3	9.5	6.2	10.0	6.4
	35.0	8.2	5.9	8.8	6.2	9.3	6.2	9.9	6.4
	37.5	8.1	5.9	8.6	6.2	9.2	6.1	9.8	6.3
	40.0	8.0	5.8	8.6	6.1	9.1	6.1	9.6	6.3
46.0	7.7	5.7	8.2	6.0	8.7	5.9	9.3	6.1	
100 (11.2)	20.0	11.1	8.5	11.6	8.9	12.5	8.8	13.1	9.1
	22.5	10.9	8.4	11.5	8.8	12.3	8.8	13.0	9.0
	25.0	10.8	8.4	11.5	8.8	12.2	8.7	12.9	9.0
	27.5	10.7	8.3	11.3	8.7	12.1	8.7	12.8	8.9
	30.0	10.5	8.2	11.2	8.7	11.9	8.6	12.6	8.9
	32.5	10.4	8.2	11.1	8.6	11.8	8.5	12.5	8.8
	35.0	10.2	8.1	10.9	8.5	11.6	8.4	12.3	8.8
	37.5	10.1	8.0	10.8	8.5	11.4	8.4	12.2	8.7
	40.0	10.0	8.0	10.6	8.4	11.3	8.3	12.0	8.6
46.0	9.6	7.8	10.2	8.2	10.8	8.1	11.5	8.4	
125 (14.0)	20.0	13.9	10.4	14.6	10.9	15.6	10.8	16.4	11.1
	22.5	13.7	10.3	14.4	10.8	15.4	10.7	16.2	11.1
	25.0	13.5	10.3	14.3	10.8	15.3	10.7	16.1	11.0
	27.5	13.4	10.2	14.2	10.7	15.1	10.6	16.0	10.9
	30.0	13.2	10.1	14.0	10.6	14.9	10.5	15.8	10.9
	32.5	13.0	10.0	13.8	10.5	14.7	10.4	15.6	10.8
	35.0	12.8	9.9	13.7	10.4	14.5	10.3	15.4	10.7
	37.5	12.6	9.8	13.4	10.3	14.3	10.2	15.2	10.6
	40.0	12.5	9.8	13.3	10.3	14.1	10.2	15.0	10.5
46.0	12.0	9.5	12.8	10.0	13.5	9.9	14.4	10.3	
140 (16.0)	20.0	15.8	11.6	16.6	12.1	17.8	12.0	18.8	12.3
	22.5	15.6	11.5	16.5	12.0	17.6	11.9	18.6	12.3
	25.0	15.5	11.4	16.4	11.9	17.4	11.9	18.4	12.2
	27.5	15.3	11.3	16.2	11.9	17.2	11.8	18.2	12.1
	30.0	15.0	11.2	16.0	11.8	17.0	11.6	18.0	12.0
	32.5	14.8	11.1	15.8	11.7	16.8	11.6	17.9	12.0
	35.0	14.6	11.0	15.6	11.6	16.5	11.4	17.6	11.8
	37.5	14.4	10.9	15.4	11.4	16.3	11.3	17.4	11.8
	40.0	14.2	10.8	15.2	11.4	16.1	11.3	17.2	11.6
46.0	13.7	10.5	14.6	11.1	15.4	11.0	16.5	11.4	

PEFY-P-VMM-A

2-2.Heating Capacity (In combination with PUMY)

PEFY-P-VMM-A

Unit size	Outdoor air temp.	Indoor air temp.:°CDB		
		15.0	20.0	25.0
		°CWB	SHC	SHC
20	-12.0	1.6	1.6	1.5
	-10.0	1.7	1.6	1.6
	-5.0	1.9	1.9	1.9
	0.0	2.2	2.1	2.1
	2.5	2.3	2.3	2.3
	6.0	2.5	2.5	2.5
	7.5	2.6	2.6	2.5
	10.0	2.8	2.7	2.5
	12.5	2.9	2.8	2.5
15.5	3.1	2.8	2.5	
25	-12.0	2.0	2.0	2.0
	-10.0	2.1	2.1	2.1
	-5.0	2.4	2.4	2.4
	0.0	2.8	2.8	2.7
	2.5	3.0	2.9	2.9
	6.0	3.2	3.2	3.2
	7.5	3.3	3.3	3.2
	10.0	3.5	3.5	3.2
	12.5	3.7	3.5	3.2
15.5	3.9	3.5	3.2	
32	-12.0	2.5	2.5	2.5
	-10.0	2.7	2.6	2.6
	-5.0	3.1	3.0	3.0
	0.0	3.5	3.4	3.4
	2.5	3.7	3.7	3.6
	6.0	4.0	4.0	3.9
	7.5	4.2	4.1	4.0
	10.0	4.4	4.4	4.0
	12.5	4.7	4.4	4.0
15.5	4.9	4.4	4.0	
40	-12.0	3.2	3.1	3.1
	-10.0	3.4	3.3	3.2
	-5.0	3.8	3.8	3.7
	0.0	4.3	4.3	4.2
	2.5	4.6	4.6	4.5
	6.0	5.0	5.0	4.9
	7.5	5.2	5.2	5.0
	10.0	5.5	5.5	5.0
	12.5	5.9	5.5	5.0
15.5	6.2	5.5	5.0	
50	-12.0	4.0	3.9	3.9
	-10.0	4.2	4.2	4.1
	-5.0	4.8	4.8	4.7
	0.0	5.5	5.4	5.3
	2.5	5.8	5.8	5.7
	6.0	6.3	6.3	6.2
	7.5	6.6	6.5	6.2
	10.0	7.0	6.9	6.2
	12.5	7.4	7.0	6.2
15.5	7.7	7.0	6.2	
63	-12.0	5.1	5.0	4.9
	-10.0	5.4	5.3	5.2
	-5.0	6.1	6.0	5.9
	0.0	6.9	6.9	6.8
	2.5	7.4	7.3	7.2
	6.0	8.0	8.0	7.9
	7.5	8.3	8.3	7.9
	10.0	8.8	8.8	7.9
	12.5	9.4	8.8	7.9
15.5	9.8	8.8	7.9	

SHC:Sensible Heat Capacity(kW)

Unit size	Outdoor air temp.	Indoor air temp.:°CDB		
		15.0	20.0	25.0
		°CWB	SHC	SHC
71	-12.0	5.7	5.6	5.5
	-10.0	6.0	5.9	5.8
	-5.0	6.9	6.8	6.7
	0.0	7.8	7.7	7.6
	2.5	8.3	8.2	8.1
	6.0	9.1	9.0	8.9
	7.5	9.4	9.3	8.9
	10.0	9.9	9.9	8.9
	12.5	10.5	9.9	8.9
15.5	11.1	9.9	8.9	
80	-12.0	6.4	6.2	6.1
	-10.0	6.7	6.6	6.5
	-5.0	7.6	7.5	7.4
	0.0	8.7	8.6	8.5
	2.5	9.2	9.2	9.0
	6.0	10.1	10.0	9.9
	7.5	10.4	10.4	9.9
	10.0	11.1	11.0	9.9
	12.5	11.7	11.0	9.9
15.5	12.3	11.0	9.9	
100	-12.0	8.0	7.8	7.7
	-10.0	8.4	8.2	8.1
	-5.0	9.6	9.4	9.3
	0.0	10.9	10.7	10.6
	2.5	11.5	11.4	11.3
	6.0	12.6	12.5	12.3
	7.5	13.0	12.9	12.4
	10.0	13.8	13.7	12.4
	12.5	14.6	13.8	12.4
15.5	15.4	13.8	12.4	
125	-12.0	10.2	10.0	9.8
	-10.0	10.7	10.6	10.4
	-5.0	12.2	12.1	11.9
	0.0	13.9	13.8	13.6
	2.5	14.8	14.7	14.5
	6.0	16.1	16.0	15.8
	7.5	16.7	16.6	15.8
	10.0	17.7	17.6	15.8
	12.5	18.7	17.7	15.8
15.5	19.7	17.7	15.8	
140	-12.0	11.5	11.2	11.0
	-10.0	12.1	11.9	11.7
	-5.0	13.8	13.6	13.4
	0.0	15.6	15.5	15.3
	2.5	16.6	16.5	16.3
	6.0	18.1	18.0	17.8
	7.5	18.8	18.6	17.8
	10.0	19.9	19.8	17.8
	12.5	21.1	19.9	17.8
15.5	22.1	19.9	17.8	

PEFY-P-VMM-A

2-3.Cooling Capacity (In combination with PU(H)Y, PURY-(P)200-250-315YEM-A, TEM-A)

PEFY-P-VMM-A

CA:Capacity(kW)

SHC:Sensible Heat Capacity(kW)

Unit size	Outdoor air temp.	Indoor air temp.													
		21.5°CDB 15°CWB		23°CDB 16°CWB		25°CDB 18°CWB		27°CDB 19°CWB		28°CDB 20°CWB		30°CDB 22°CWB		32°CDB 24°CWB	
		°CDB	CA	SHC	CA	SHC	CA	SHC	CA	SHC	CA	SHC	CA	SHC	CA
20 (2.2)	20.0	2.2	1.8	2.2	1.8	2.3	1.8	2.3	1.8	2.4	1.9	2.5	1.9	2.6	1.8
	22.5	2.1	1.8	2.2	1.8	2.3	1.8	2.3	1.8	2.4	1.9	2.4	1.8	2.5	1.8
	25.0	2.1	1.8	2.2	1.8	2.2	1.8	2.3	1.8	2.3	1.9	2.4	1.8	2.5	1.8
	27.5	2.1	1.8	2.1	1.8	2.2	1.8	2.3	1.8	2.3	1.9	2.4	1.8	2.5	1.8
	30.0	2.1	1.7	2.1	1.8	2.2	1.8	2.2	1.8	2.3	1.9	2.4	1.8	2.5	1.8
	32.5	2.0	1.7	2.1	1.8	2.2	1.8	2.2	1.8	2.3	1.9	2.4	1.8	2.4	1.8
	35.0	2.0	1.7	2.1	1.8	2.2	1.7	2.2	1.8	2.2	1.8	2.3	1.8	2.4	1.8
	37.5	2.0	1.7	2.0	1.8	2.1	1.7	2.2	1.8	2.2	1.8	2.3	1.8	2.4	1.8
	40.0	2.0	1.7	2.0	1.8	2.1	1.7	2.2	1.8	2.2	1.8	2.3	1.8	2.4	1.8
43.0	2.0	1.7	2.0	1.8	2.1	1.7	2.1	1.8	2.2	1.8	2.3	1.8	2.3	1.7	
25 (2.8)	20.0	2.7	2.1	2.8	2.1	2.9	2.1	3.0	2.1	3.0	2.2	3.1	2.1	3.2	2.0
	22.5	2.7	2.1	2.8	2.1	2.9	2.1	2.9	2.1	3.0	2.1	3.1	2.1	3.2	2.0
	25.0	2.7	2.0	2.7	2.1	2.9	2.0	2.9	2.1	3.0	2.1	3.1	2.1	3.2	2.0
	27.5	2.7	2.0	2.7	2.1	2.8	2.0	2.9	2.1	2.9	2.1	3.1	2.1	3.2	2.0
	30.0	2.6	2.0	2.7	2.1	2.8	2.0	2.9	2.0	2.9	2.1	3.0	2.1	3.1	2.0
	32.5	2.6	2.0	2.7	2.1	2.8	2.0	2.8	2.0	2.9	2.1	3.0	2.0	3.1	2.0
	35.0	2.6	2.0	2.6	2.0	2.7	2.0	2.8	2.0	2.9	2.1	3.0	2.0	3.1	2.0
	37.5	2.5	2.0	2.6	2.0	2.7	2.0	2.8	2.0	2.8	2.1	2.9	2.0	3.1	2.0
	40.0	2.5	2.0	2.6	2.0	2.7	2.0	2.7	2.0	2.8	2.1	2.9	2.0	3.0	2.0
43.0	2.5	1.9	2.5	2.0	2.7	2.0	2.7	2.0	2.8	2.1	2.9	2.0	3.0	2.0	
32 (3.6)	20.0	3.5	2.6	3.6	2.7	3.7	2.6	3.8	2.6	3.9	2.7	4.0	2.6	4.2	2.6
	22.5	3.5	2.6	3.6	2.7	3.7	2.6	3.8	2.6	3.9	2.7	4.0	2.6	4.1	2.6
	25.0	3.5	2.6	3.5	2.6	3.7	2.6	3.7	2.6	3.8	2.7	4.0	2.6	4.1	2.5
	27.5	3.4	2.6	3.5	2.6	3.6	2.6	3.7	2.6	3.8	2.7	3.9	2.6	4.1	2.5
	30.0	3.4	2.5	3.5	2.6	3.6	2.5	3.7	2.6	3.7	2.7	3.9	2.6	4.0	2.5
	32.5	3.3	2.5	3.4	2.6	3.6	2.5	3.6	2.6	3.7	2.6	3.9	2.6	4.0	2.5
	35.0	3.3	2.5	3.4	2.6	3.5	2.5	3.6	2.5	3.7	2.6	3.8	2.6	4.0	2.5
	37.5	3.3	2.5	3.3	2.6	3.5	2.5	3.6	2.5	3.6	2.6	3.8	2.5	3.9	2.5
	40.0	3.2	2.5	3.3	2.5	3.5	2.5	3.5	2.5	3.6	2.6	3.7	2.5	3.9	2.5
43.0	3.2	2.5	3.3	2.5	3.4	2.5	3.5	2.5	3.6	2.6	3.7	2.5	3.8	2.5	
40 (4.5)	20.0	4.4	3.4	4.5	3.4	4.7	3.4	4.8	3.4	4.9	3.5	5.0	3.4	5.2	3.3
	22.5	4.4	3.3	4.5	3.4	4.6	3.3	4.7	3.4	4.8	3.5	5.0	3.4	5.2	3.3
	25.0	4.3	3.3	4.4	3.4	4.6	3.3	4.7	3.4	4.8	3.5	5.0	3.4	5.1	3.3
	27.5	4.3	3.3	4.4	3.4	4.5	3.3	4.6	3.3	4.7	3.4	4.9	3.4	5.1	3.3
	30.0	4.2	3.3	4.3	3.4	4.5	3.3	4.6	3.3	4.7	3.4	4.9	3.3	5.0	3.3
	32.5	4.2	3.2	4.3	3.3	4.5	3.3	4.5	3.3	4.6	3.4	4.8	3.3	5.0	3.2
	35.0	4.1	3.2	4.2	3.3	4.4	3.2	4.5	3.3	4.6	3.4	4.8	3.3	5.0	3.2
	37.5	4.1	3.2	4.2	3.3	4.4	3.2	4.5	3.3	4.5	3.4	4.7	3.3	4.9	3.2
	40.0	4.1	3.2	4.1	3.3	4.3	3.2	4.4	3.2	4.5	3.4	4.7	3.3	4.9	3.2
43.0	4.0	3.2	4.1	3.2	4.3	3.2	4.4	3.2	4.4	3.3	4.6	3.3	4.8	3.2	
50 (5.6)	20.0	5.5	4.1	5.6	4.2	5.8	4.1	5.9	4.1	6.0	4.2	6.3	4.1	6.5	4.0
	22.5	5.4	4.1	5.5	4.1	5.8	4.1	5.9	4.1	6.0	4.2	6.2	4.1	6.4	4.0
	25.0	5.4	4.0	5.5	4.1	5.7	4.0	5.8	4.1	5.9	4.2	6.2	4.1	6.4	4.0
	27.5	5.3	4.0	5.4	4.1	5.7	4.0	5.8	4.0	5.9	4.2	6.1	4.1	6.3	4.0
	30.0	5.3	4.0	5.4	4.1	5.6	4.0	5.7	4.0	5.8	4.1	6.0	4.0	6.3	3.9
	32.5	5.2	3.9	5.3	4.0	5.5	4.0	5.7	4.0	5.8	4.1	6.0	4.0	6.2	3.9
	35.0	5.2	3.9	5.3	4.0	5.5	3.9	5.6	4.0	5.7	4.1	5.9	4.0	6.2	3.9
	37.5	5.1	3.9	5.2	4.0	5.4	3.9	5.5	3.9	5.7	4.1	5.9	4.0	6.1	3.9
	40.0	5.0	3.9	5.2	4.0	5.4	3.9	5.5	3.9	5.6	4.1	5.8	4.0	6.0	3.9
43.0	5.0	3.8	5.1	3.9	5.3	3.9	5.4	3.9	5.5	4.0	5.8	3.9	6.0	3.8	
63 (7.1)	20.0	7.0	5.1	7.1	5.2	7.4	5.1	7.5	5.1	7.7	5.3	8.0	5.2	8.2	5.0
	22.5	6.9	5.1	7.0	5.2	7.3	5.1	7.5	5.1	7.6	5.3	7.9	5.1	8.2	5.0
	25.0	6.8	5.0	7.0	5.2	7.2	5.0	7.4	5.1	7.5	5.2	7.8	5.1	8.1	5.0
	27.5	6.7	5.0	6.9	5.1	7.2	5.0	7.3	5.1	7.5	5.2	7.7	5.1	8.0	4.9
	30.0	6.7	5.0	6.8	5.1	7.1	5.0	7.2	5.0	7.4	5.2	7.7	5.1	8.0	4.9
	32.5	6.6	4.9	6.7	5.1	7.0	5.0	7.2	5.0	7.3	5.2	7.6	5.0	7.9	4.9
	35.0	6.5	4.9	6.7	5.0	7.0	4.9	7.1	5.0	7.2	5.1	7.5	5.0	7.8	4.9
	37.5	6.5	4.9	6.6	5.0	6.9	4.9	7.0	4.9	7.2	5.1	7.5	5.0	7.7	4.8
	40.0	6.4	4.8	6.5	5.0	6.8	4.9	7.0	4.9	7.1	5.1	7.4	4.9	7.7	4.8
43.0	6.3	4.8	6.4	4.9	6.7	4.8	6.9	4.9	7.0	5.0	7.3	4.9	7.6	4.8	

PEFY-P-VMM-A

Cooling Capacity (In combination with PU(H)Y, PURY-(P)200-250-315YEM-A, TEM-A)

PEFY-P-VMM-A

CA:Capacity(kW)

SHC:Sensible Heat Capacity(kW)

Unit size	Outdoor air temp.	Indoor air temp.													
		21.5°CDB 15°CWB		23°CDB 16°CWB		25°CDB 18°CWB		27°CDB 19°CWB		28°CDB 20°CWB		30°CDB 22°CWB		32°CDB 24°CWB	
		°CDB	CA	SHC	CA	SHC	CA	SHC	CA	SHC	CA	SHC	CA	SHC	CA
71 (8.0)	20.0	7.8	5.7	8.0	5.9	8.3	5.7	8.5	5.8	8.6	5.9	9.0	5.8	9.3	5.6
	22.5	7.8	5.7	7.9	5.8	8.2	5.7	8.4	5.7	8.6	5.9	8.9	5.7	9.2	5.6
	25.0	7.7	5.7	7.8	5.8	8.2	5.6	8.3	5.7	8.5	5.9	8.8	5.7	9.1	5.6
	27.5	7.6	5.6	7.8	5.7	8.1	5.6	8.2	5.7	8.4	5.8	8.7	5.7	9.0	5.5
	30.0	7.5	5.6	7.7	5.7	8.0	5.6	8.2	5.6	8.3	5.8	8.6	5.7	9.0	5.5
	32.5	7.4	5.5	7.6	5.7	7.9	5.5	8.1	5.6	8.2	5.8	8.6	5.6	8.9	5.5
	35.0	7.4	5.5	7.5	5.6	7.8	5.5	8.0	5.6	8.2	5.7	8.5	5.6	8.8	5.4
	37.5	7.3	5.5	7.4	5.6	7.8	5.5	7.9	5.5	8.1	5.7	8.4	5.6	8.7	5.4
	40.0	7.2	5.4	7.4	5.5	7.7	5.4	7.8	5.5	8.0	5.7	8.3	5.5	8.6	5.4
43.0	7.1	5.4	7.3	5.5	7.6	5.4	7.7	5.4	7.9	5.6	8.2	5.5	8.5	5.3	
80 (9.0)	20.0	8.8	6.2	9.0	6.4	9.4	6.2	9.5	6.2	9.7	6.4	10.1	6.2	10.4	6.0
	22.5	8.7	6.2	8.9	6.3	9.3	6.2	9.5	6.2	9.6	6.4	10.0	6.2	10.4	6.0
	25.0	8.6	6.1	8.8	6.3	9.2	6.1	9.4	6.1	9.5	6.3	9.9	6.1	10.3	6.0
	27.5	8.6	6.1	8.7	6.2	9.1	6.1	9.3	6.1	9.5	6.3	9.8	6.1	10.2	5.9
	30.0	8.5	6.1	8.6	6.2	9.0	6.0	9.2	6.1	9.4	6.2	9.7	6.1	10.1	5.9
	32.5	8.4	6.0	8.6	6.1	8.9	6.0	9.1	6.0	9.3	6.2	9.6	6.0	10.0	5.9
	35.0	8.3	6.0	8.5	6.1	8.8	5.9	9.0	6.0	9.2	6.2	9.5	6.0	9.9	5.8
	37.5	8.2	5.9	8.4	6.0	8.7	5.9	8.9	5.9	9.1	6.1	9.5	6.0	9.8	5.8
	40.0	8.1	5.9	8.3	6.0	8.6	5.9	8.8	5.9	9.0	6.1	9.4	5.9	9.7	5.8
43.0	8.0	5.8	8.2	5.9	8.5	5.8	8.7	5.9	8.9	6.0	9.3	5.9	9.6	5.7	
100 (11.2)	20.0	11.0	8.5	11.2	8.7	11.6	8.5	11.9	8.6	12.1	8.9	12.5	8.6	13.0	8.4
	22.5	10.9	8.4	11.1	8.6	11.5	8.4	11.8	8.5	12.0	8.8	12.4	8.6	12.9	8.4
	25.0	10.8	8.3	11.0	8.6	11.4	8.4	11.6	8.5	11.9	8.8	12.3	8.5	12.8	8.3
	27.5	10.6	8.3	10.9	8.5	11.3	8.3	11.5	8.4	11.8	8.7	12.2	8.5	12.7	8.3
	30.0	10.5	8.2	10.8	8.5	11.2	8.3	11.4	8.4	11.6	8.7	12.1	8.5	12.5	8.2
	32.5	10.4	8.2	10.6	8.4	11.1	8.2	11.3	8.3	11.5	8.6	12.0	8.4	12.4	8.2
	35.0	10.3	8.1	10.5	8.4	11.0	8.2	11.2	8.3	11.4	8.6	11.9	8.4	12.3	8.2
	37.5	10.2	8.1	10.4	8.3	10.9	8.1	11.1	8.2	11.3	8.5	11.8	8.3	12.2	8.1
	40.0	10.1	8.0	10.3	8.2	10.8	8.1	11.0	8.2	11.2	8.5	11.6	8.3	12.1	8.1
43.0	9.9	8.0	10.2	8.2	10.6	8.0	10.8	8.2	11.1	8.4	11.5	8.3	12.0	8.1	
125 (14.0)	20.0	13.7	10.4	14.0	10.6	14.6	10.4	14.8	10.5	15.1	10.8	15.7	10.5	16.2	10.2
	22.5	13.6	10.3	13.9	10.5	14.4	10.3	14.7	10.4	15.0	10.7	15.5	10.5	16.1	10.2
	25.0	13.4	10.2	13.7	10.5	14.3	10.2	14.6	10.3	14.8	10.7	15.4	10.4	16.0	10.1
	27.5	13.3	10.2	13.6	10.4	14.1	10.2	14.4	10.3	14.7	10.6	15.3	10.4	15.8	10.1
	30.0	13.2	10.1	13.4	10.3	14.0	10.1	14.3	10.2	14.6	10.6	15.1	10.3	15.7	10.0
	32.5	13.0	10.0	13.3	10.3	13.9	10.1	14.1	10.2	14.4	10.5	15.0	10.3	15.5	10.0
	35.0	12.9	10.0	13.2	10.2	13.7	10.0	14.0	10.1	14.3	10.5	14.8	10.2	15.4	9.9
	37.5	12.7	9.9	13.0	10.1	13.6	9.9	13.9	10.1	14.1	10.4	14.7	10.2	15.3	9.9
	40.0	12.6	9.8	12.9	10.1	13.4	9.9	13.7	10.0	14.0	10.3	14.6	10.1	15.1	9.9
43.0	12.4	9.7	12.7	10.0	13.3	9.8	13.6	9.9	13.8	10.3	14.4	10.0	15.0	9.8	
140 (16.0)	20.0	15.7	11.5	16.0	11.8	16.6	11.5	17.0	11.6	17.3	11.9	17.9	11.6	18.6	11.3
	22.5	15.5	11.4	15.8	11.7	16.5	11.4	16.8	11.5	17.1	11.9	17.8	11.5	18.4	11.2
	25.0	15.4	11.4	15.7	11.6	16.3	11.3	16.6	11.4	17.0	11.8	17.6	11.5	18.2	11.2
	27.5	15.2	11.3	15.5	11.5	16.2	11.3	16.5	11.4	16.8	11.7	17.4	11.4	18.1	11.1
	30.0	15.0	11.2	15.4	11.4	16.0	11.2	16.3	11.3	16.6	11.7	17.3	11.4	17.9	11.0
	32.5	14.9	11.1	15.2	11.4	15.8	11.1	16.2	11.2	16.5	11.6	17.1	11.3	17.8	11.0
	35.0	14.7	11.0	15.0	11.3	15.7	11.1	16.0	11.2	16.3	11.5	17.0	11.2	17.6	10.9
	37.5	14.6	11.0	14.9	11.2	15.5	11.0	15.8	11.1	16.2	11.5	16.8	11.2	17.4	10.9
	40.0	14.4	10.9	14.7	11.1	15.4	10.9	15.7	11.0	16.0	11.4	16.6	11.1	17.3	10.8
43.0	14.2	10.8	14.5	11.1	15.2	10.8	15.5	10.9	15.8	11.3	16.4	11.0	17.1	10.8	

PEFY-P-VMM-A

2-4.Heating Capacity (In combination with PU(H)Y, PURY-(P)200-250-315YEM-A, TEM-A)

PEFY-P-VMM-A

SHC:Sensible Heat Capacity(kW)

Unit size	Outdoor air temp. °CWB	Indoor air temp.:°CDB			
		15.0	20.0	25.0	27.0
		SHC	SHC	SHC	SHC
20	-15.0	1.7	1.6	1.6	1.6
	-10.0	1.9	1.9	1.9	1.7
	-5.0	2.1	2.1	2.0	1.7
	0.0	2.4	2.4	2.0	1.7
	2.5	2.5	2.5	2.0	1.7
	6.0	2.5	2.5	2.0	1.7
	7.5	2.6	2.5	2.0	1.7
	10.0	2.8	2.5	2.0	1.7
	12.5	3.0	2.5	2.0	1.7
15.5	3.0	2.5	2.0	1.7	
25	-15.0	2.1	2.1	2.1	2.1
	-10.0	2.4	2.4	2.4	2.2
	-5.0	2.7	2.7	2.5	2.2
	0.0	3.1	3.0	2.5	2.2
	2.5	3.2	3.2	2.5	2.2
	6.0	3.2	3.2	2.5	2.2
	7.5	3.4	3.2	2.5	2.2
	10.0	3.6	3.2	2.5	2.2
	12.5	3.8	3.2	2.5	2.2
15.5	3.9	3.2	2.5	2.2	
32	-15.0	2.7	2.6	2.6	2.6
	-10.0	3.1	3.0	3.0	2.8
	-5.0	3.4	3.4	3.1	2.8
	0.0	3.8	3.8	3.1	2.8
	2.5	4.0	4.0	3.1	2.8
	6.0	4.0	4.0	3.1	2.8
	7.5	4.2	4.0	3.1	2.8
	10.0	4.5	4.0	3.1	2.8
	12.5	4.8	4.0	3.1	2.8
15.5	4.8	4.0	3.1	2.8	
40	-15.0	3.3	3.3	3.3	3.3
	-10.0	3.8	3.8	3.7	3.5
	-5.0	4.3	4.2	3.9	3.5
	0.0	4.8	4.7	3.9	3.5
	2.5	5.0	5.0	3.9	3.5
	6.0	5.1	5.0	3.9	3.5
	7.5	5.3	5.0	3.9	3.5
	10.0	5.6	5.0	3.9	3.5
	12.5	6.0	5.0	3.9	3.5
15.5	6.1	5.0	3.9	3.5	
50	-15.0	4.2	4.2	4.1	4.1
	-10.0	4.8	4.8	4.7	4.3
	-5.0	5.4	5.3	4.9	4.3
	0.0	6.0	5.9	4.9	4.3
	2.5	6.3	6.2	4.9	4.3
	6.0	6.4	6.3	4.9	4.3
	7.5	6.6	6.3	4.9	4.3
	10.0	7.1	6.3	4.9	4.3
	12.5	7.5	6.3	4.9	4.3
15.5	7.6	6.3	4.9	4.3	
63	-15.0	5.4	5.3	5.2	5.2
	-10.0	6.1	6.0	6.0	5.5
	-5.0	6.9	6.8	6.2	5.5
	0.0	7.6	7.5	6.2	5.5
	2.5	8.0	7.9	6.2	5.5
	6.0	8.1	8.0	6.2	5.5
	7.5	8.4	8.0	6.2	5.5
	10.0	9.0	8.0	6.2	5.5
	12.5	9.6	8.0	6.2	5.5
15.5	9.7	8.0	6.2	5.5	

Unit size	Outdoor air temp. °CWB	Indoor air temp.:°CDB			
		15.0	20.0	25.0	27.0
		SHC	SHC	SHC	SHC
71	-15.0	6.0	5.9	5.9	5.9
	-10.0	6.9	6.8	6.7	6.2
	-5.0	7.7	7.6	7.0	6.2
	0.0	8.6	8.5	7.0	6.2
	2.5	9.0	8.9	7.0	6.2
	6.0	9.1	9.0	7.0	6.2
	7.5	9.5	9.0	7.0	6.2
	10.0	10.1	9.0	7.0	6.2
	12.5	10.8	9.0	7.0	6.2
15.5	10.9	9.0	7.0	6.2	
80	-15.0	6.7	6.6	6.5	6.5
	-10.0	7.6	7.5	7.4	6.9
	-5.0	8.6	8.5	7.8	6.9
	0.0	9.5	9.4	7.8	6.9
	2.5	10.0	9.9	7.8	6.9
	6.0	10.1	10.0	7.8	6.9
	7.5	10.5	10.0	7.8	6.9
	10.0	11.2	10.0	7.8	6.9
	12.5	12.0	10.0	7.8	6.9
15.5	12.1	10.0	7.8	6.9	
100	-15.0	8.4	8.2	8.2	8.1
	-10.0	9.6	9.4	9.3	8.6
	-5.0	10.7	10.6	9.8	8.6
	0.0	11.9	11.8	9.8	8.6
	2.5	12.5	12.4	9.8	8.6
	6.0	12.6	12.5	9.8	8.6
	7.5	13.2	12.5	9.8	8.6
	10.0	14.1	12.5	9.8	8.6
	12.5	15.0	12.5	9.8	8.6
15.5	15.1	12.5	9.8	8.6	
125	-15.0	10.7	10.6	10.5	10.4
	-10.0	12.2	12.1	11.9	11.0
	-5.0	13.7	13.6	12.5	11.0
	0.0	15.3	15.1	12.5	11.0
	2.5	16.0	15.8	12.5	11.0
	6.0	16.2	16.0	12.5	11.0
	7.5	16.8	16.0	12.5	11.0
	10.0	18.0	16.0	12.5	11.0
	12.5	19.1	16.0	12.5	11.0
15.5	19.4	16.0	12.5	11.0	
140	-15.0	12.1	11.9	11.8	11.7
	-10.0	13.8	13.6	13.4	12.4
	-5.0	15.5	15.3	14.0	12.4
	0.0	17.2	17.0	14.0	12.4
	2.5	18.0	17.8	14.0	12.4
	6.0	18.2	18.0	14.0	12.4
	7.5	19.0	18.0	14.0	12.4
	10.0	20.2	18.0	14.0	12.4
	12.5	21.5	18.0	14.0	12.4
15.5	21.8	18.0	14.0	12.4	

PEFY-P-VMM-A

2-5.Cooling Capacity (In combination with Big Y, Super Y, Big R2)

PEFY-P-VMM-A

CA:Capacity(kW)
SHC:Sensible Heat Capacity(kW)

Unit size	Outdoor air temp.	Indoor air temp.											
		21.5°CDB 15°CWB		23°CDB 16°CWB		25°CDB 18°CWB		28°CDB 20°CWB		30°CDB 22°CWB		32°CDB 24°CWB	
		°CDB	CA	SHC	CA	SHC	CA	SHC	CA	SHC	CA	SHC	CA
20	20.0	2.0	1.7	2.1	1.8	2.3	1.8	2.4	1.9	2.6	1.9	2.7	1.9
	22.5	2.0	1.7	2.1	1.8	2.3	1.8	2.4	1.9	2.6	1.9	2.7	1.9
	25.0	2.0	1.7	2.1	1.8	2.2	1.8	2.4	1.9	2.5	1.9	2.7	1.8
	27.5	2.0	1.7	2.1	1.8	2.2	1.8	2.4	1.9	2.5	1.9	2.6	1.8
	30.0	2.0	1.7	2.1	1.8	2.2	1.8	2.3	1.9	2.5	1.9	2.6	1.8
	32.5	2.0	1.7	2.0	1.8	2.2	1.8	2.3	1.9	2.4	1.8	2.6	1.8
	35.0	1.9	1.7	2.0	1.8	2.1	1.7	2.3	1.9	2.4	1.8	2.5	1.8
	37.5	1.9	1.7	2.0	1.8	2.1	1.7	2.2	1.8	2.4	1.8	2.5	1.8
	40.0	1.9	1.7	2.0	1.7	2.1	1.7	2.2	1.8	2.3	1.8	2.4	1.8
43.0	1.9	1.7	1.9	1.7	2.1	1.7	2.2	1.8	2.3	1.8	2.4	1.8	
25	20.0	2.6	2.0	2.7	2.1	2.9	2.1	3.1	2.2	3.3	2.2	3.5	2.1
	22.5	2.6	2.0	2.7	2.1	2.9	2.1	3.1	2.2	3.3	2.1	3.4	2.1
	25.0	2.6	2.0	2.7	2.1	2.9	2.0	3.0	2.2	3.2	2.1	3.4	2.1
	27.5	2.5	2.0	2.6	2.0	2.8	2.0	3.0	2.1	3.2	2.1	3.3	2.1
	30.0	2.5	2.0	2.6	2.0	2.8	2.0	3.0	2.1	3.1	2.1	3.3	2.1
	32.5	2.5	2.0	2.6	2.0	2.8	2.0	2.9	2.1	3.1	2.1	3.2	2.0
	35.0	2.5	1.9	2.6	2.0	2.7	2.0	2.9	2.1	3.0	2.1	3.2	2.0
	37.5	2.5	1.9	2.5	2.0	2.7	2.0	2.8	2.1	3.0	2.0	3.1	2.0
	40.0	2.4	1.9	2.5	2.0	2.7	2.0	2.8	2.1	3.0	2.0	3.1	2.0
43.0	2.4	1.9	2.5	2.0	2.6	1.9	2.8	2.1	2.9	2.0	3.0	2.0	
32	20.0	3.3	2.5	3.5	2.6	3.7	2.6	4.0	2.8	4.2	2.7	4.5	2.7
	22.5	3.3	2.5	3.5	2.6	3.7	2.6	4.0	2.7	4.2	2.7	4.4	2.7
	25.0	3.3	2.5	3.4	2.6	3.7	2.6	3.9	2.7	4.1	2.7	4.4	2.6
	27.5	3.3	2.5	3.4	2.6	3.6	2.6	3.9	2.7	4.1	2.7	4.3	2.6
	30.0	3.2	2.5	3.4	2.6	3.6	2.5	3.8	2.7	4.0	2.6	4.2	2.6
	32.5	3.2	2.5	3.3	2.5	3.5	2.5	3.8	2.7	4.0	2.6	4.2	2.6
	35.0	3.2	2.4	3.3	2.5	3.5	2.5	3.7	2.6	3.9	2.6	4.1	2.5
	37.5	3.2	2.4	3.3	2.5	3.5	2.5	3.7	2.6	3.8	2.6	4.0	2.5
	40.0	3.1	2.4	3.2	2.5	3.4	2.5	3.6	2.6	3.8	2.6	4.0	2.5
43.0	3.1	2.4	3.2	2.5	3.4	2.4	3.5	2.6	3.7	2.5	3.9	2.5	
40	20.0	4.1	3.2	4.3	3.4	4.7	3.4	5.0	3.6	5.3	3.5	5.6	3.5
	22.5	4.1	3.2	4.3	3.4	4.6	3.3	4.9	3.5	5.2	3.5	5.5	3.4
	25.0	4.1	3.2	4.3	3.3	4.6	3.3	4.9	3.5	5.2	3.5	5.5	3.4
	27.5	4.1	3.2	4.2	3.3	4.5	3.3	4.8	3.5	5.1	3.4	5.4	3.4
	30.0	4.0	3.2	4.2	3.3	4.5	3.3	4.8	3.5	5.0	3.4	5.3	3.3
	32.5	4.0	3.2	4.2	3.3	4.4	3.3	4.7	3.4	5.0	3.4	5.2	3.3
	35.0	4.0	3.1	4.1	3.3	4.4	3.2	4.6	3.4	4.9	3.4	5.1	3.3
	37.5	3.9	3.1	4.1	3.2	4.3	3.2	4.6	3.4	4.8	3.3	5.1	3.3
	40.0	3.9	3.1	4.0	3.2	4.3	3.2	4.5	3.4	4.7	3.3	5.0	3.2
43.0	3.9	3.1	4.0	3.2	4.2	3.2	4.4	3.3	4.7	3.3	4.9	3.2	
50	20.0	5.2	3.9	5.4	4.1	5.8	4.1	6.2	4.3	6.6	4.3	7.0	4.2
	22.5	5.2	3.9	5.4	4.1	5.8	4.1	6.2	4.3	6.5	4.2	6.9	4.2
	25.0	5.1	3.9	5.3	4.0	5.7	4.0	6.1	4.3	6.4	4.2	6.8	4.1
	27.5	5.1	3.9	5.3	4.0	5.6	4.0	6.0	4.2	6.3	4.2	6.7	4.1
	30.0	5.0	3.9	5.2	4.0	5.6	4.0	5.9	4.2	6.2	4.1	6.6	4.1
	32.5	5.0	3.8	5.2	4.0	5.5	3.9	5.8	4.2	6.2	4.1	6.5	4.0
	35.0	4.9	3.8	5.1	3.9	5.4	3.9	5.8	4.1	6.1	4.1	6.4	4.0
	37.5	4.9	3.8	5.1	3.9	5.4	3.9	5.7	4.1	6.0	4.0	6.3	3.9
	40.0	4.9	3.8	5.0	3.9	5.3	3.9	5.6	4.1	5.9	4.0	6.2	3.9
43.0	4.8	3.8	5.0	3.9	5.2	3.8	5.5	4.0	5.8	4.0	6.1	3.9	
63	20.0	6.5	4.9	6.9	5.1	7.4	5.1	7.9	5.4	8.4	5.3	8.9	5.2
	22.5	6.5	4.9	6.8	5.1	7.3	5.1	7.8	5.4	8.3	5.3	8.7	5.2
	25.0	6.5	4.9	6.8	5.1	7.2	5.0	7.7	5.3	8.1	5.2	8.6	5.2
	27.5	6.4	4.9	6.7	5.0	7.2	5.0	7.6	5.3	8.0	5.2	8.5	5.1
	30.0	6.4	4.8	6.6	5.0	7.1	5.0	7.5	5.2	7.9	5.2	8.4	5.1
	32.5	6.3	4.8	6.6	5.0	7.0	4.9	7.4	5.2	7.8	5.1	8.2	5.0
	35.0	6.3	4.8	6.5	4.9	6.9	4.9	7.3	5.2	7.7	5.1	8.1	5.0
	37.5	6.2	4.8	6.4	4.9	6.8	4.9	7.2	5.1	7.6	5.0	8.0	4.9
	40.0	6.2	4.7	6.4	4.9	6.7	4.8	7.1	5.1	7.5	5.0	7.9	4.9
43.0	6.1	4.7	6.3	4.8	6.6	4.8	7.0	5.0	7.3	4.9	7.7	4.8	

PEFY-P-VMM-A

Cooling Capacity (In combination with Big Y, Super Y, Big R2)

CA:Capacity(kW)
SHC:Sensible Heat Capacity(kW)

PEFY-P-VMM-A

Unit size	Outdoor air temp.	Indoor air temp.											
		21.5°CDB 15°CWB		23°CDB 16°CWB		25°CDB 18°CWB		28°CDB 20°CWB		30°CDB 22°CWB		32°CDB 24°CWB	
		°CDB	CA	SHC	CA	SHC	CA	SHC	CA	SHC	CA	SHC	CA
71	20.0	7.4	5.5	7.7	5.7	8.3	5.7	8.9	6.0	9.4	6.0	10.0	5.9
	22.5	7.4	5.5	7.7	5.7	8.2	5.7	8.8	6.0	9.3	5.9	9.8	5.8
	25.0	7.3	5.5	7.6	5.7	8.2	5.6	8.7	6.0	9.2	5.9	9.7	5.8
	27.5	7.2	5.4	7.5	5.6	8.1	5.6	8.6	5.9	9.0	5.8	9.6	5.7
	30.0	7.2	5.4	7.5	5.6	8.0	5.6	8.5	5.9	8.9	5.8	9.4	5.7
	32.5	7.1	5.4	7.4	5.6	7.9	5.5	8.3	5.8	8.8	5.7	9.3	5.6
	35.0	7.1	5.4	7.3	5.5	7.8	5.5	8.2	5.8	8.7	5.7	9.1	5.6
	37.5	7.0	5.3	7.2	5.5	7.7	5.4	8.1	5.7	8.6	5.6	9.0	5.5
	40.0	7.0	5.3	7.2	5.5	7.6	5.4	8.0	5.7	8.4	5.6	8.9	5.5
43.0	6.9	5.3	7.1	5.4	7.5	5.3	7.9	5.6	8.3	5.5	8.7	5.4	
80	20.0	8.3	6.0	8.7	6.2	9.4	6.2	10.0	6.5	10.6	6.4	11.2	6.3
	22.5	8.3	6.0	8.7	6.2	9.3	6.2	9.9	6.5	10.5	6.4	11.1	6.3
	25.0	8.2	5.9	8.6	6.1	9.2	6.1	9.8	6.4	10.3	6.3	10.9	6.2
	27.5	8.1	5.9	8.5	6.1	9.1	6.1	9.6	6.4	10.2	6.3	10.8	6.1
	30.0	8.1	5.9	8.4	6.1	9.0	6.0	9.5	6.3	10.0	6.2	10.6	6.1
	32.5	8.0	5.8	8.3	6.0	8.9	6.0	9.4	6.3	9.9	6.1	10.4	6.0
	35.0	8.0	5.8	8.2	6.0	8.8	5.9	9.3	6.2	9.8	6.1	10.3	6.0
	37.5	7.9	5.8	8.1	5.9	8.6	5.9	9.1	6.1	9.6	6.0	10.1	5.9
	40.0	7.8	5.7	8.1	5.9	8.5	5.8	9.0	6.1	9.5	6.0	10.0	5.9
43.0	7.7	5.7	8.0	5.8	8.4	5.8	8.9	6.0	9.3	5.9	9.8	5.8	
100	20.0	10.3	8.1	10.8	8.5	11.6	8.5	12.5	9.0	13.2	8.9	14.0	8.7
	22.5	10.3	8.1	10.8	8.5	11.5	8.4	12.3	8.9	13.0	8.8	13.8	8.7
	25.0	10.2	8.1	10.7	8.4	11.4	8.4	12.1	8.9	12.8	8.7	13.6	8.6
	27.5	10.1	8.1	10.6	8.4	11.3	8.3	12.0	8.8	12.7	8.7	13.4	8.5
	30.0	10.1	8.0	10.5	8.3	11.2	8.3	11.8	8.8	12.5	8.6	13.2	8.5
	32.5	10.0	8.0	10.3	8.3	11.0	8.2	11.7	8.7	12.3	8.6	13.0	8.4
	35.0	9.9	7.9	10.2	8.2	10.9	8.2	11.5	8.6	12.1	8.5	12.8	8.3
	37.5	9.8	7.9	10.1	8.2	10.8	8.1	11.4	8.6	12.0	8.4	12.6	8.3
	40.0	9.7	7.9	10.0	8.1	10.6	8.0	11.2	8.5	11.8	8.4	12.4	8.2
43.0	9.6	7.8	9.9	8.1	10.5	8.0	11.0	8.4	11.6	8.3	12.2	8.1	
125	20.0	12.9	10.0	13.5	10.4	14.6	10.4	15.6	11.0	16.5	10.8	17.5	10.7
	22.5	12.9	10.0	13.5	10.4	14.4	10.3	15.4	10.9	16.3	10.8	17.2	10.6
	25.0	12.8	9.9	13.3	10.3	14.3	10.2	15.2	10.8	16.1	10.7	17.0	10.5
	27.5	12.7	9.9	13.2	10.2	14.1	10.2	15.0	10.8	15.8	10.6	16.7	10.4
	30.0	12.6	9.8	13.1	10.2	13.9	10.1	14.8	10.7	15.6	10.5	16.5	10.3
	32.5	12.5	9.8	12.9	10.1	13.8	10.0	14.6	10.6	15.4	10.4	16.2	10.2
	35.0	12.4	9.7	12.8	10.0	13.6	10.0	14.4	10.5	15.2	10.3	16.0	10.2
	37.5	12.3	9.7	12.7	10.0	13.5	9.9	14.2	10.4	15.0	10.3	15.7	10.1
	40.0	12.2	9.6	12.5	9.9	13.3	9.8	14.0	10.4	14.8	10.2	15.5	10.0
43.0	12.0	9.6	12.4	9.9	13.1	9.7	13.8	10.3	14.5	10.1	15.2	9.9	
140	20.0	14.7	11.0	15.4	11.5	16.6	11.5	17.8	12.1	18.8	12.0	20.0	11.8
	22.5	14.7	11.0	15.4	11.5	16.5	11.4	17.6	12.1	18.6	11.9	19.7	11.7
	25.0	14.6	11.0	15.2	11.4	16.3	11.3	17.4	12.0	18.3	11.8	19.4	11.6
	27.5	14.5	10.9	15.1	11.3	16.1	11.3	17.1	11.9	18.1	11.7	19.1	11.5
	30.0	14.4	10.9	14.9	11.2	15.9	11.2	16.9	11.8	17.8	11.6	18.8	11.4
	32.5	14.3	10.8	14.8	11.2	15.7	11.1	16.7	11.7	17.6	11.5	18.6	11.3
	35.0	14.1	10.8	14.6	11.1	15.6	11.0	16.5	11.6	17.4	11.4	18.3	11.2
	37.5	14.0	10.7	14.5	11.0	15.4	10.9	16.2	11.5	17.1	11.3	18.0	11.1
	40.0	13.9	10.6	14.3	11.0	15.2	10.8	16.0	11.4	16.9	11.2	17.7	11.0
43.0	13.8	10.6	14.2	10.9	15.0	10.7	15.8	11.3	16.6	11.1	17.4	10.9	

PEFY-P-VMM-A

2-6.Heating Capacity (In combination with Big Y, Super Y, Big R2)

PEFY-P-VMM-A

SHC:Sensible Heat Capacity(kW)

PEFY-P-VMM-A

Unit size	Outdoor air temp.	Indoor air temp.:°CDB			
		15	21	25	27
		°CWB	SHC	SHC	SHC
20	-15.0	1.6	1.5	1.5	1.5
	-10.0	1.8	1.8	1.7	1.7
	-5.0	2.0	2.0	2.0	1.9
	0.0	2.2	2.2	2.1	1.9
	2.5	2.4	2.3	2.1	1.9
	6.0	2.5	2.5	2.1	1.9
	7.5	2.6	2.5	2.1	1.9
	10.0	2.7	2.5	2.1	1.9
	12.5	2.9	2.5	2.1	1.9
15.5	2.9	2.5	2.1	1.9	
25	-15.0	2.0	2.0	1.9	1.9
	-10.0	2.3	2.2	2.2	2.2
	-5.0	2.6	2.5	2.5	2.5
	0.0	2.9	2.8	2.7	2.5
	2.5	3.0	3.0	2.7	2.5
	6.0	3.2	3.2	2.7	2.5
	7.5	3.3	3.2	2.7	2.5
	10.0	3.5	3.2	2.7	2.5
	12.5	3.7	3.2	2.7	2.5
15.5	3.7	3.2	2.7	2.5	
32	-15.0	2.5	2.5	2.4	2.4
	-10.0	2.8	2.8	2.8	2.7
	-5.0	3.2	3.2	3.1	3.1
	0.0	3.6	3.5	3.4	3.1
	2.5	3.8	3.7	3.4	3.1
	6.0	4.0	4.0	3.4	3.1
	7.5	4.2	4.0	3.4	3.1
	10.0	4.4	4.0	3.4	3.1
	12.5	4.6	4.0	3.4	3.1
15.5	4.6	4.0	3.4	3.1	
40	-15.0	3.1	3.1	3.0	3.0
	-10.0	3.6	3.5	3.5	3.4
	-5.0	4.0	4.0	3.9	3.9
	0.0	4.5	4.4	4.3	3.9
	2.5	4.7	4.7	4.3	3.9
	6.0	5.0	5.0	4.3	3.9
	7.5	5.2	5.0	4.3	3.9
	10.0	5.4	5.0	4.3	3.9
	12.5	5.7	5.0	4.3	3.9
15.5	5.8	5.0	4.3	3.9	
50	-15.0	3.9	3.9	3.8	3.7
	-10.0	4.5	4.4	4.3	4.3
	-5.0	5.0	5.0	4.9	4.9
	0.0	5.6	5.6	5.4	4.9
	2.5	5.9	5.9	5.4	4.9
	6.0	6.4	6.3	5.4	4.9
	7.5	6.6	6.3	5.4	4.9
	10.0	6.9	6.3	5.4	4.9
	12.5	7.2	6.3	5.4	4.9
15.5	7.2	6.3	5.4	4.9	
63	-15.0	5.0	4.9	4.8	4.7
	-10.0	5.7	5.6	5.5	5.4
	-5.0	6.4	6.3	6.2	6.2
	0.0	7.2	7.1	6.8	6.2
	2.5	7.5	7.5	6.8	6.2
	6.0	8.1	8.0	6.8	6.2
	7.5	8.3	8.0	6.8	6.2
	10.0	8.7	8.0	6.8	6.2
	12.5	9.1	8.0	6.8	6.2
15.5	9.2	8.0	6.8	6.2	

Unit size	Outdoor air temp.	Indoor air temp.:°CDB			
		15	21	25	27
		°CWB	SHC	SHC	SHC
71	-15.0	5.6	5.5	5.4	5.3
	-10.0	6.4	6.3	6.2	6.1
	-5.0	7.2	7.1	7.0	6.9
	0.0	8.0	8.0	7.7	6.9
	2.5	8.5	8.4	7.7	6.9
	6.0	9.1	9.0	7.7	6.9
	7.5	9.4	9.0	7.7	6.9
	10.0	9.8	9.0	7.7	6.9
	12.5	10.3	9.0	7.7	6.9
15.5	10.4	9.0	7.7	6.9	
80	-15.0	6.2	6.1	6.0	5.9
	-10.0	7.1	7.0	6.9	6.8
	-5.0	8.0	7.9	7.8	7.7
	0.0	8.9	8.8	8.5	7.7
	2.5	9.4	9.3	8.5	7.7
	6.0	10.1	10.0	8.5	7.7
	7.5	10.4	10.0	8.5	7.7
	10.0	10.9	10.0	8.5	7.7
	12.5	11.4	10.0	8.5	7.7
15.5	11.5	10.0	8.5	7.7	
100	-15.0	7.8	7.7	7.5	7.4
	-10.0	8.9	8.8	8.6	8.5
	-5.0	10.0	9.9	9.8	9.6
	0.0	11.2	11.0	10.6	9.6
	2.5	11.8	11.6	10.6	9.6
	6.0	12.6	12.5	10.6	9.6
	7.5	13.0	12.5	10.6	9.6
	10.0	13.6	12.5	10.6	9.6
	12.5	14.3	12.5	10.6	9.6
15.5	14.4	12.5	10.6	9.6	
125	-15.0	10.0	9.8	9.6	9.5
	-10.0	11.4	11.2	11.0	10.9
	-5.0	12.8	12.6	12.5	12.3
	0.0	14.3	14.1	13.6	12.3
	2.5	15.1	14.9	13.6	12.3
	6.0	16.2	16.0	13.6	12.3
	7.5	16.6	16.0	13.6	12.3
	10.0	17.4	16.0	13.6	12.3
	12.5	18.3	16.0	13.6	12.3
15.5	18.4	16.0	13.6	12.3	
140	-15.0	11.2	11.0	10.9	10.7
	-10.0	12.8	12.6	12.4	12.2
	-5.0	14.4	14.2	14.1	13.9
	0.0	16.1	15.9	15.3	13.9
	2.5	17.0	16.8	15.3	13.9
	6.0	18.2	18.0	15.3	13.9
	7.5	18.7	18.0	15.3	13.9
	10.0	19.6	18.0	15.3	13.9
	12.5	20.5	18.0	15.3	13.9
15.5	20.7	18.0	15.3	13.9	

2-7.Cooling Capacity (In combination with WY, WR2)

CA:Capacity(kW)

SHC:Sensible Heat Capacity(kW)

PEFY-P-VMM-A

Unit size	Water temp.	Indoor air temp.													
		21.5°CDB 15°CWB		23°CDB 16°CWB		25°CDB 18°CWB		27°CDB 19°CWB		28°CDB 20°CWB		30°CDB 22°CWB		32°CDB 24°CWB	
		°C	CA	SHC	CA	SHC	CA	SHC	CA	SHC	CA	SHC	CA	SHC	CA
20	10	2.1	1.8	2.2	1.9	2.4	1.8	2.4	1.9	2.5	1.9	2.6	1.9	2.8	1.9
	20	2.1	1.8	2.1	1.8	2.3	1.8	2.3	1.8	2.4	1.9	2.5	1.9	2.7	1.9
	30	2.0	1.7	2.0	1.8	2.1	1.7	2.2	1.8	2.3	1.9	2.4	1.8	2.5	1.8
	40	1.7	1.6	1.8	1.6	1.9	1.6	1.9	1.7	2.0	1.7	2.1	1.7	2.2	1.7
	45	1.6	1.5	1.7	1.6	1.8	1.6	1.8	1.6	1.9	1.7	2.0	1.7	2.1	1.7
25	10	2.4	1.9	2.5	2.0	2.7	2.0	2.8	2.0	2.8	2.1	3.0	2.0	3.2	2.0
	20	2.4	1.9	2.4	1.9	2.6	1.9	2.7	2.0	2.7	2.0	2.9	2.0	3.0	2.0
	30	2.2	1.8	2.3	1.9	2.4	1.9	2.5	1.9	2.6	2.0	2.7	1.9	2.9	1.9
	40	1.9	1.7	2.0	1.8	2.1	1.7	2.2	1.8	2.2	1.8	2.4	1.8	2.5	1.8
	45	1.8	1.6	1.9	1.7	2.0	1.7	2.1	1.7	2.1	1.8	2.2	1.8	2.4	1.7
32	10	3.5	2.6	3.6	2.7	3.9	2.7	4.0	2.7	4.1	2.8	4.3	2.7	4.5	2.7
	20	3.4	2.5	3.5	2.6	3.7	2.6	3.8	2.6	3.9	2.7	4.1	2.7	4.4	2.6
	30	3.2	2.5	3.3	2.5	3.5	2.5	3.6	2.5	3.7	2.6	3.9	2.6	4.1	2.6
	40	2.8	2.3	2.9	2.3	3.1	2.3	3.1	2.4	3.2	2.4	3.4	2.4	3.6	2.4
	45	2.6	2.2	2.7	2.3	2.9	2.2	3.0	2.3	3.0	2.4	3.2	2.3	3.4	2.3
40	10	4.4	3.3	4.5	3.5	4.8	3.4	5.0	3.5	5.1	3.6	5.4	3.5	5.7	3.5
	20	4.2	3.3	4.4	3.4	4.6	3.3	4.8	3.4	4.9	3.5	5.2	3.5	5.5	3.4
	30	4.0	3.2	4.1	3.3	4.4	3.2	4.5	3.3	4.6	3.4	4.9	3.4	5.2	3.3
	40	3.5	2.9	3.6	3.0	3.8	3.0	3.9	3.0	4.0	3.2	4.3	3.1	4.5	3.1
	45	3.3	2.8	3.4	2.9	3.6	2.9	3.7	3.0	3.8	3.1	4.0	3.0	4.2	3.0
50	10	5.5	4.1	5.6	4.2	6.0	4.2	6.2	4.2	6.3	4.4	6.7	4.3	7.1	4.2
	20	5.3	4.0	5.4	4.1	5.8	4.1	5.9	4.1	6.1	4.3	6.5	4.2	6.8	4.1
	30	5.0	3.8	5.1	4.0	5.5	3.9	5.6	4.0	5.8	4.1	6.1	4.1	6.4	4.0
	40	4.3	3.5	4.5	3.6	4.7	3.6	4.9	3.7	5.0	3.8	5.3	3.8	5.6	3.7
	45	4.1	3.4	4.2	3.5	4.5	3.5	4.6	3.6	4.7	3.7	5.0	3.7	5.3	3.6
63	10	6.9	5.1	7.2	5.3	7.6	5.2	7.8	5.3	8.0	5.5	8.5	5.4	9.0	5.3
	20	6.7	5.0	6.9	5.1	7.3	5.1	7.5	5.1	7.8	5.3	8.2	5.3	8.6	5.2
	30	6.3	4.8	6.5	4.9	6.9	4.9	7.1	5.0	7.3	5.2	7.7	5.1	8.1	5.0
	40	5.5	4.4	5.7	4.6	6.0	4.5	6.2	4.6	6.4	4.8	6.7	4.7	7.1	4.6
	45	5.2	4.3	5.3	4.4	5.7	4.4	5.8	4.4	6.0	4.6	6.3	4.6	6.7	4.5
71	10	7.8	5.7	8.1	5.9	8.6	5.8	8.8	5.9	9.1	6.1	9.6	6.0	10.1	5.9
	20	7.5	5.6	7.8	5.7	8.3	5.7	8.5	5.8	8.7	6.0	9.2	5.9	9.7	5.8
	30	7.1	5.4	7.3	5.5	7.8	5.5	8.0	5.6	8.2	5.8	8.7	5.7	9.2	5.6
	40	6.2	4.9	6.4	5.1	6.8	5.0	7.0	5.1	7.2	5.3	7.6	5.2	8.0	5.2
	45	5.8	4.8	6.0	4.9	6.4	4.9	6.6	5.0	6.8	5.2	7.1	5.1	7.5	5.0
80	10	8.8	6.2	9.1	6.4	9.6	6.3	9.9	6.4	10.2	6.6	10.8	6.5	11.4	6.4
	20	8.5	6.1	8.7	6.2	9.3	6.2	9.5	6.2	9.8	6.4	10.4	6.3	10.9	6.2
	30	8.0	5.8	8.3	6.0	8.8	5.9	9.0	6.0	9.3	6.2	9.8	6.1	10.3	6.0
	40	6.9	5.3	7.2	5.5	7.6	5.4	7.8	5.5	8.1	5.7	8.5	5.6	9.0	5.5
	45	6.5	5.1	6.8	5.3	7.2	5.2	7.4	5.3	7.6	5.5	8.0	5.4	8.5	5.3
100	10	10.9	8.4	11.3	8.7	12.0	8.6	12.3	8.8	12.7	9.1	13.4	9.0	14.1	8.8
	20	10.5	8.2	10.9	8.5	11.6	8.4	11.9	8.6	12.2	8.9	12.9	8.8	13.6	8.6
	30	9.9	8.0	10.3	8.2	10.9	8.2	11.2	8.3	11.5	8.6	12.2	8.5	12.8	8.4
	40	8.6	7.4	8.9	7.6	9.5	7.6	9.7	7.7	10.0	8.0	10.6	7.9	11.2	7.8
	45	8.1	7.1	8.4	7.4	8.9	7.3	9.2	7.5	9.5	7.8	10.0	7.7	10.5	7.6
125	10	13.7	10.3	14.1	10.7	15.0	10.6	15.4	10.7	15.9	11.1	16.7	10.9	17.7	10.7
	20	13.2	10.1	13.6	10.4	14.5	10.3	14.8	10.5	15.3	10.9	16.1	10.7	17.0	10.5
	30	12.4	9.7	12.8	10.1	13.6	10.0	14.0	10.1	14.4	10.5	15.2	10.4	16.1	10.2
	40	10.8	9.0	11.2	9.3	11.9	9.2	12.2	9.4	12.5	9.8	13.2	9.6	14.0	9.5
	45	10.2	8.7	10.5	9.0	11.2	8.9	11.5	9.1	11.8	9.5	12.5	9.4	13.2	9.2
140	10	15.6	11.5	16.1	11.8	17.1	11.7	17.6	11.8	18.1	12.3	19.1	12.1	20.2	11.9
	20	15.0	11.2	15.6	11.5	16.5	11.4	17.0	11.6	17.5	12.0	18.4	11.8	19.5	11.6
	30	14.2	10.8	14.7	11.1	15.6	11.0	16.0	11.2	16.5	11.6	17.4	11.4	18.4	11.2
	40	12.3	9.9	12.8	10.2	13.6	10.1	13.9	10.3	14.3	10.7	15.1	10.6	16.0	10.4
	45	11.6	9.6	12.0	9.9	12.8	9.8	13.1	10.0	13.5	10.4	14.3	10.2	15.0	10.1

PEFY-P-VMM-A

2-8.Heating Capacity (In combination with WY, WR2)

PEFY-P-VMM-A

SHC:Sensible Heat Capacity(kW)

Unit size	Water temp. °C	Indoor air temp.:°CDB				
		15 SHC(kW)	19 SHC(kW)	20 SHC(kW)	25 SHC(kW)	27 SHC(kW)
20	10	2.2	2.2	2.1	1.7	1.5
	20	2.6	2.6	2.5	2.0	1.8
	30	2.6	2.6	2.5	2.0	1.8
	40	2.7	2.7	2.6	2.1	1.9
	45	2.9	2.9	2.9	2.3	2.1
25	10	2.8	2.8	2.7	2.2	2.0
	20	3.3	3.3	3.2	2.6	2.3
	30	3.3	3.3	3.2	2.6	2.3
	40	3.4	3.4	3.3	2.7	2.4
	45	3.8	3.7	3.6	2.9	2.6
32	10	3.5	3.5	3.4	2.7	2.4
	20	4.1	4.1	4.0	3.2	2.9
	30	4.1	4.1	4.0	3.2	2.9
	40	4.3	4.2	4.2	3.3	3.0
	45	4.7	4.7	4.6	3.6	3.3
40	10	4.4	4.3	4.3	3.4	3.1
	20	5.2	5.1	5.0	4.0	3.6
	30	5.2	5.1	5.0	4.0	3.6
	40	5.4	5.3	5.2	4.2	3.7
	45	5.9	5.8	5.7	4.6	4.1
50	10	5.5	5.5	5.4	4.3	3.9
	20	6.5	6.4	6.3	5.0	4.5
	30	6.5	6.4	6.3	5.0	4.5
	40	6.7	6.7	6.6	5.2	4.7
	45	7.4	7.3	7.2	5.7	5.2
63	10	7.0	6.9	6.8	5.4	4.9
	20	8.2	8.2	8.0	6.4	5.8
	30	8.2	8.2	8.0	6.4	5.8
	40	8.6	8.5	8.3	6.7	6.0
	45	9.4	9.3	9.1	7.3	6.6
71	10	7.9	7.8	7.7	6.1	5.5
	20	9.3	9.2	9.0	7.2	6.5
	30	9.3	9.2	9.0	7.2	6.5
	40	9.6	9.5	9.4	7.5	6.7
	45	10.6	10.5	10.3	8.2	7.4
80	10	8.8	8.7	8.5	6.8	6.1
	20	10.3	10.2	10.0	8.0	7.2
	30	10.3	10.2	10.0	8.0	7.2
	40	10.7	10.6	10.4	8.3	7.5
	45	11.7	11.6	11.4	9.1	8.2
100	10	10.9	10.8	10.6	8.5	7.7
	20	12.9	12.8	12.5	10.0	9.0
	30	12.9	12.8	12.5	10.0	9.0
	40	13.4	13.3	13.0	10.4	9.4
	45	14.7	14.5	14.3	11.4	10.3
125	10	14.0	13.9	13.6	10.9	9.8
	20	16.5	16.3	16.0	12.8	11.5
	30	16.5	16.3	16.0	12.8	11.5
	40	17.1	17.0	16.6	13.3	12.0
	45	18.8	18.6	18.2	14.6	13.1
140	10	15.8	15.6	15.3	12.2	11.0
	20	18.5	18.4	18.0	14.4	13.0
	30	18.5	18.4	18.0	14.4	13.0
	40	19.3	19.1	18.7	15.0	13.5
	45	21.1	20.9	20.5	16.4	14.8

PEFY-P-VMM-A

3. Sound Levels

3-1. Noise level(VMM-A)

Ceiling concealed (VMM-A series)

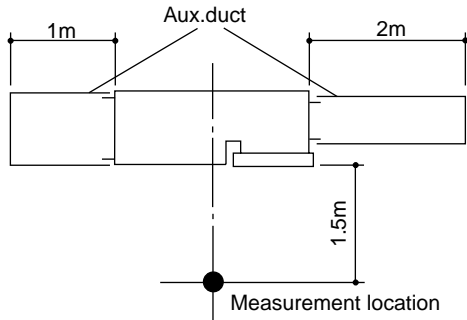

Noise level at anechoic room (Low-Middle-High)

Unit : dB(A)

Model	External static pressure*		
	Low	Mid	High
PEFY-P20VMM-A PEFY-P25VMM-A	23-28-31	27-30-32	29-34-39
PEFY-P32VMM-A	26-30-33	28-32-35	32-36-39
PEFY-P40VMM-A	29-32-35	31-34-37	33-37-41
PEFY-P50VMM-A	29-34-37	31-35-38	34-38-41
PEFY-P63VMM-A	30-34-37	31-35-38	34-38-41
PEFY-P71VMM-A PEFY-P80VMM-A	31-34-37	32-36-39	35-39-42
PEFY-P100VMM-A	40-44	-	43-47
PEFY-P125VMM-A	42-45	-	44-47
PEFY-P140VMM-A	42-45	-	44-47

- * PEFY-P20~80VMM-A
Low : 30Pa Mid : 50Pa High : 100Pa
- * PEFY-P100~140VMM-A
Low : 50Pa High : 130Pa

3-2. NC curves(VMM-A)

1) Back inlet

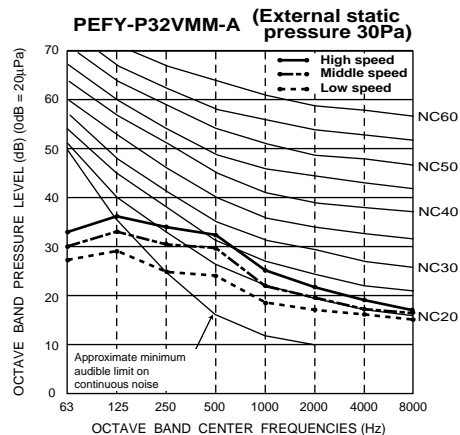
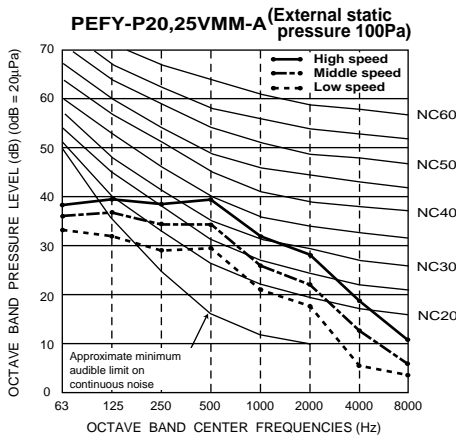
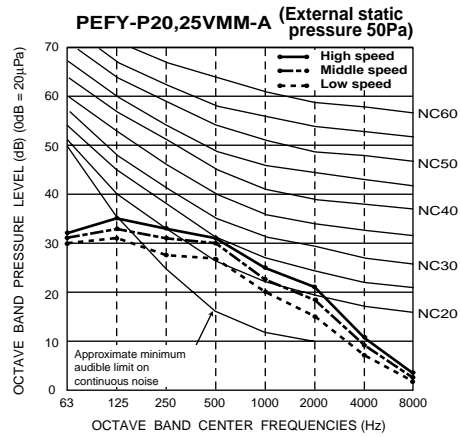
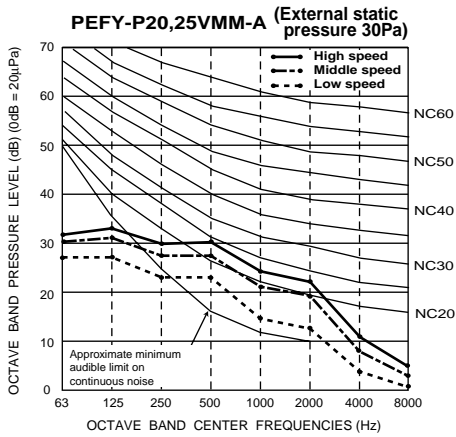

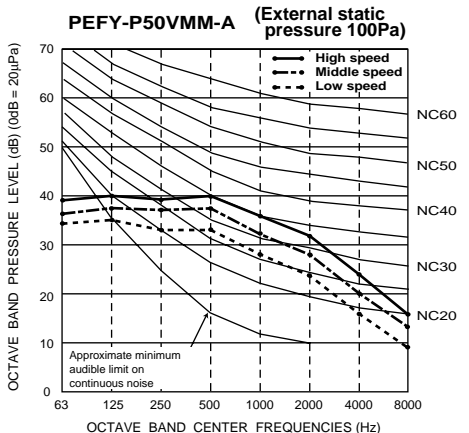
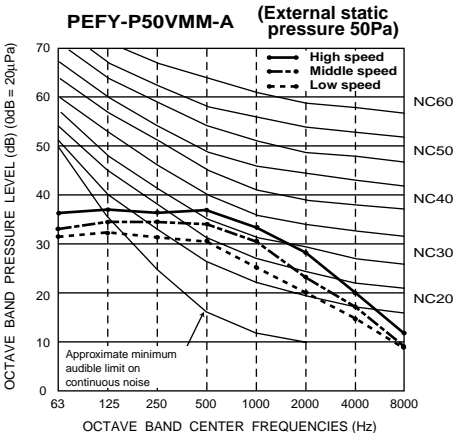
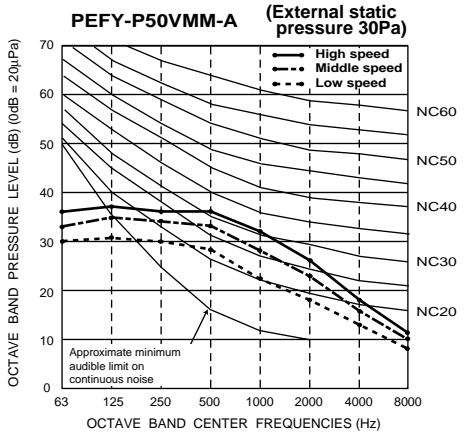
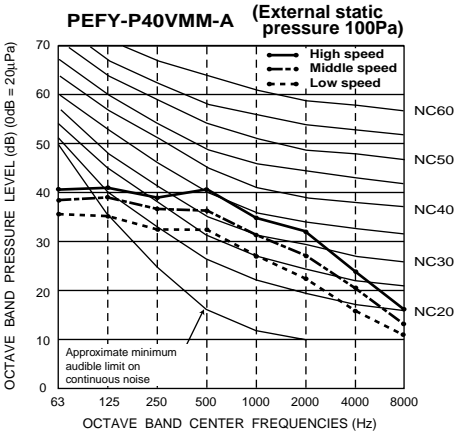
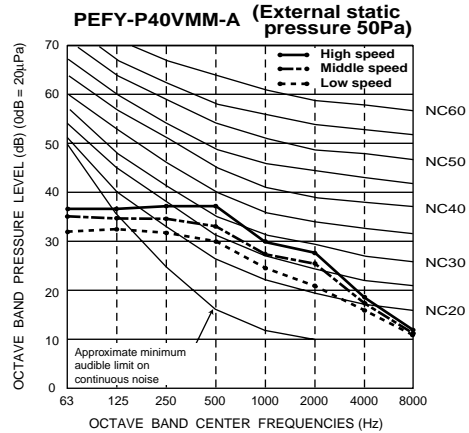
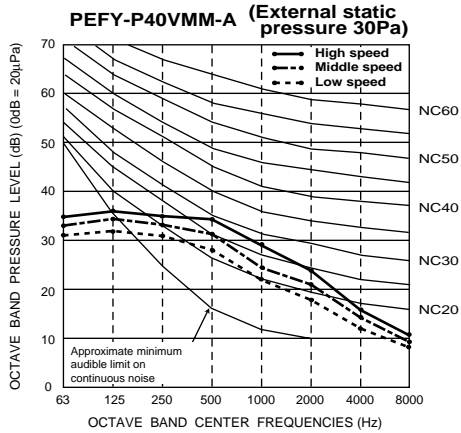
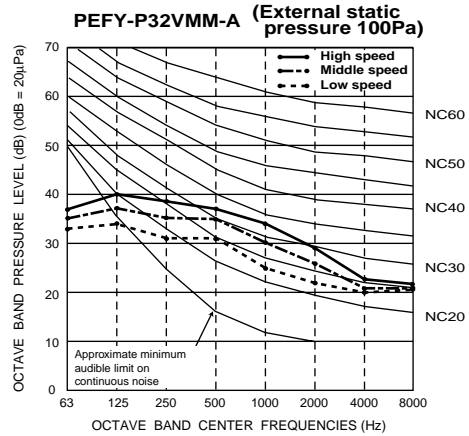
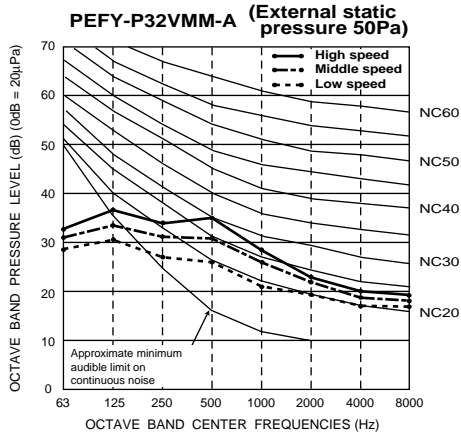

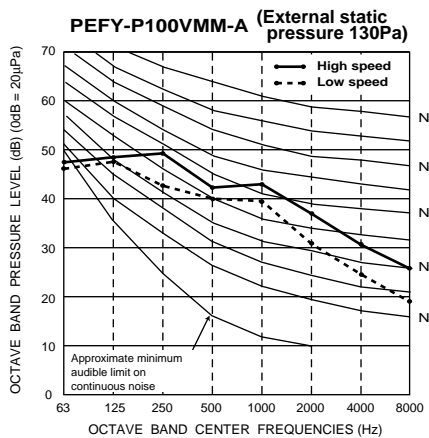
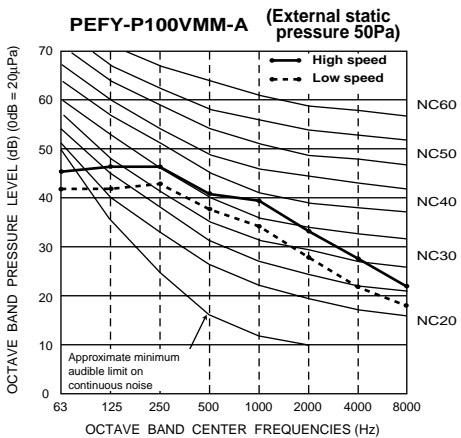
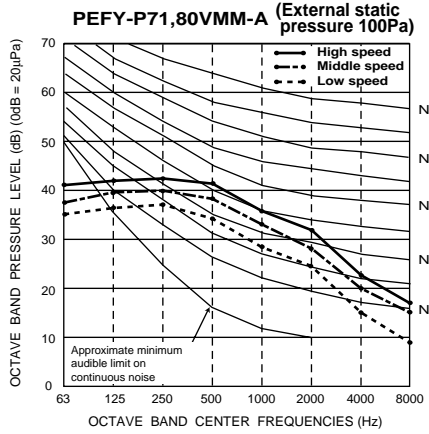
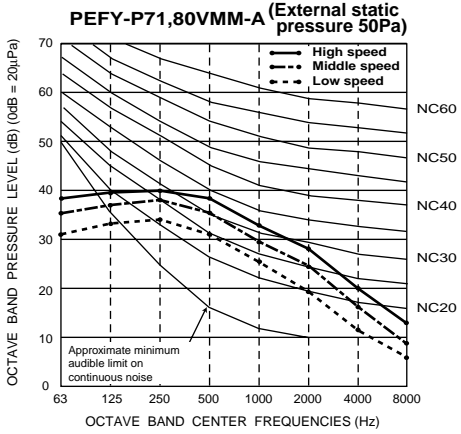
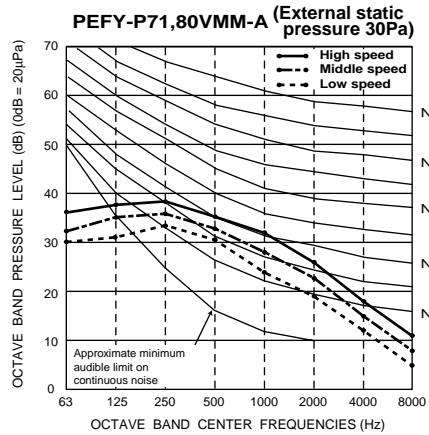
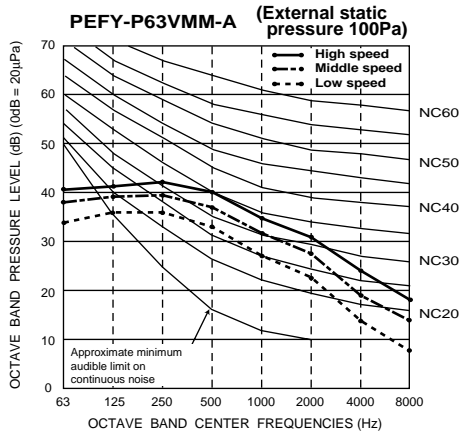
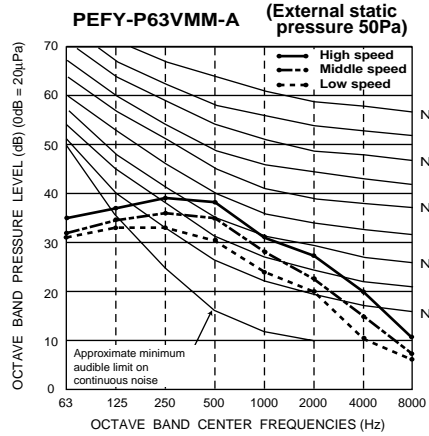
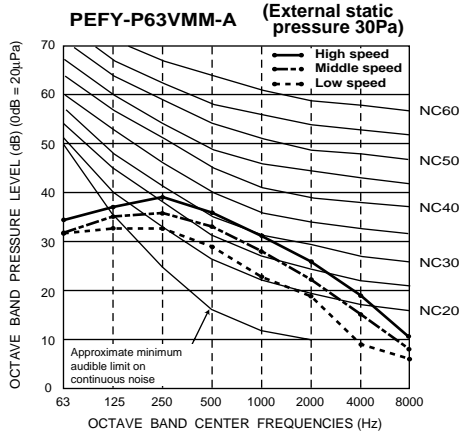

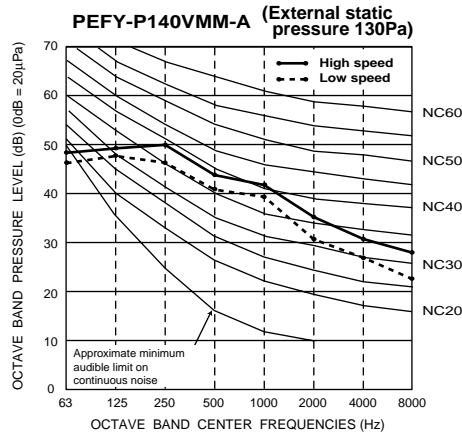
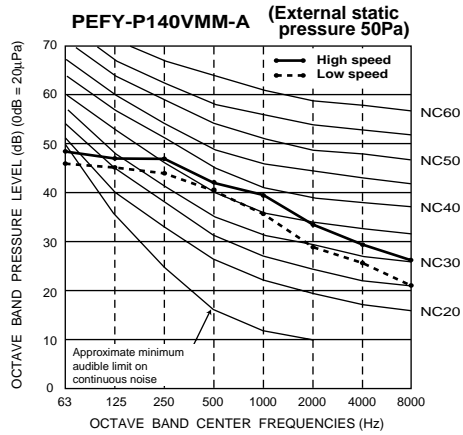
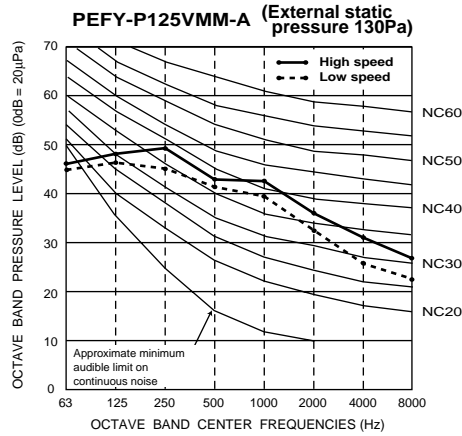
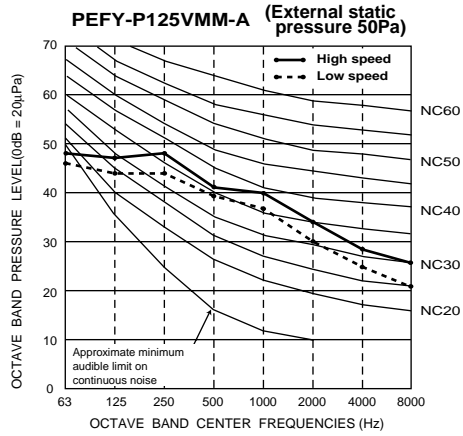

2) Bottom inlet

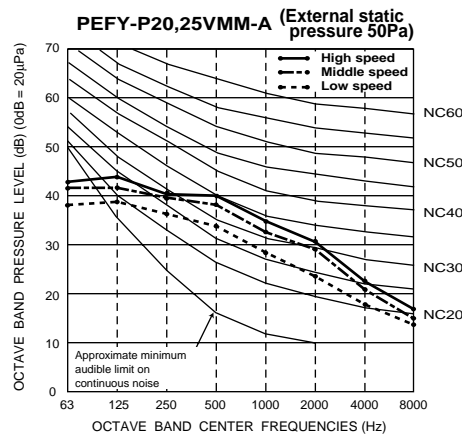
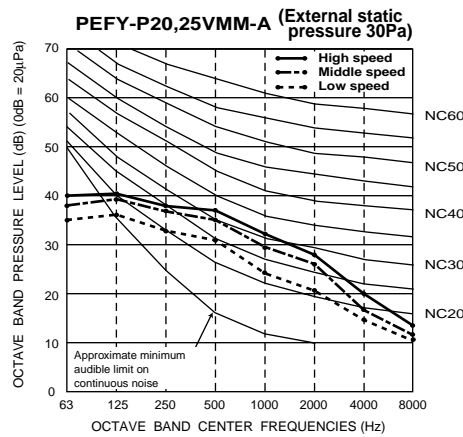

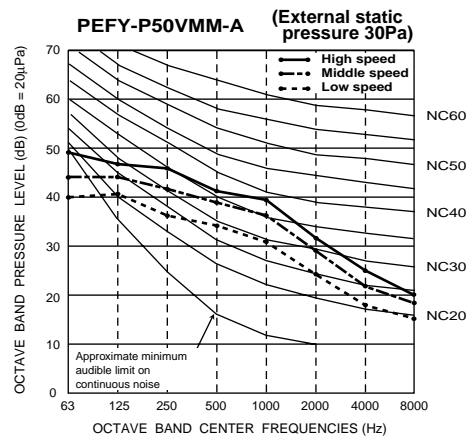
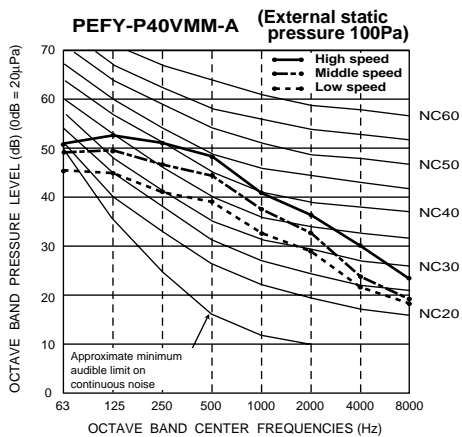
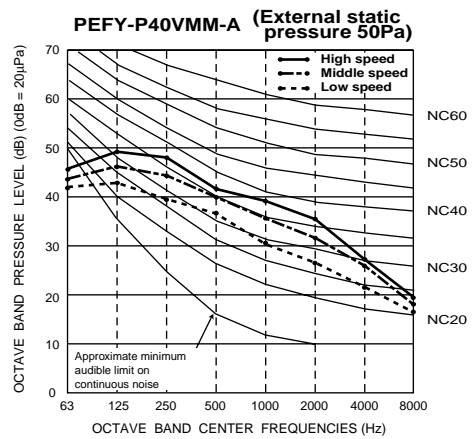
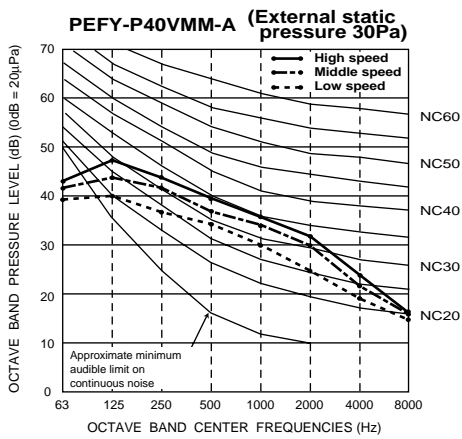
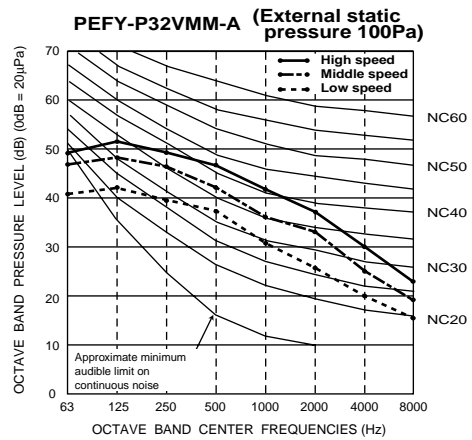
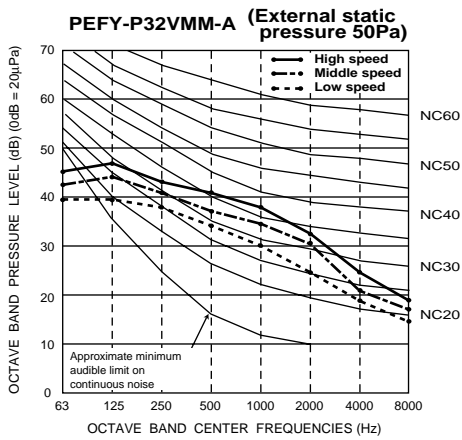
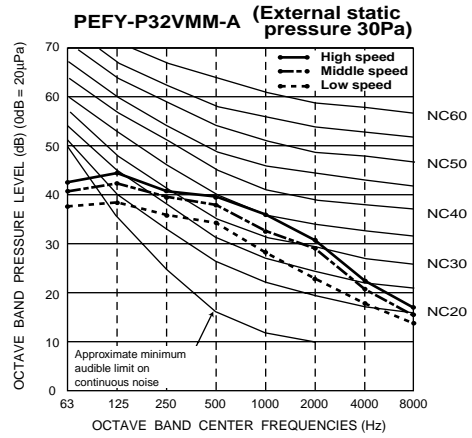
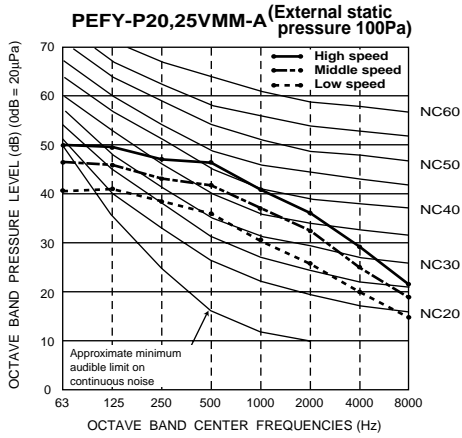

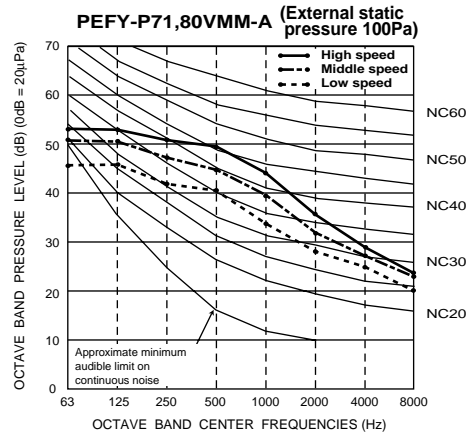
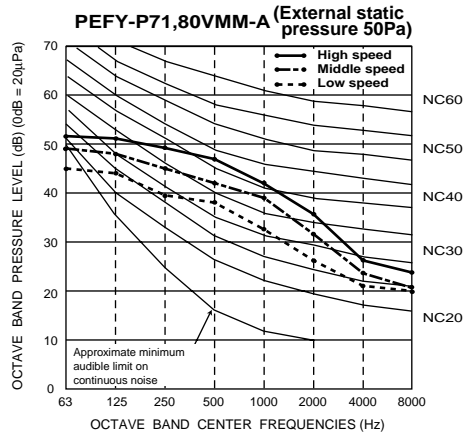
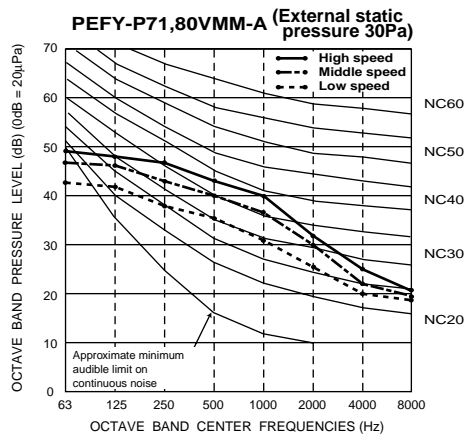
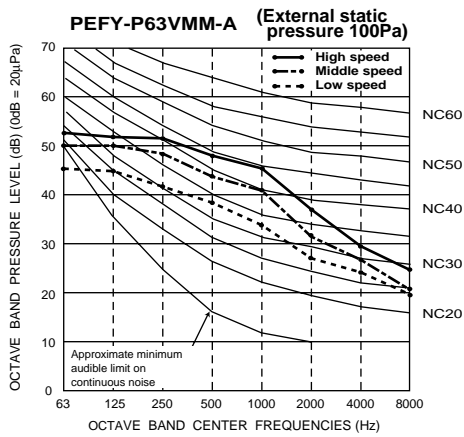
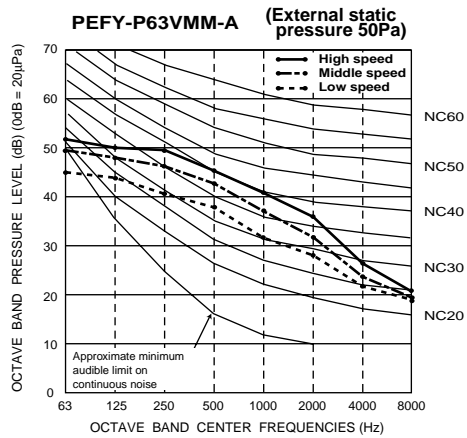
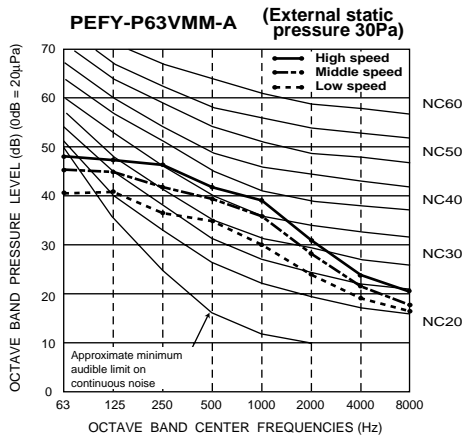
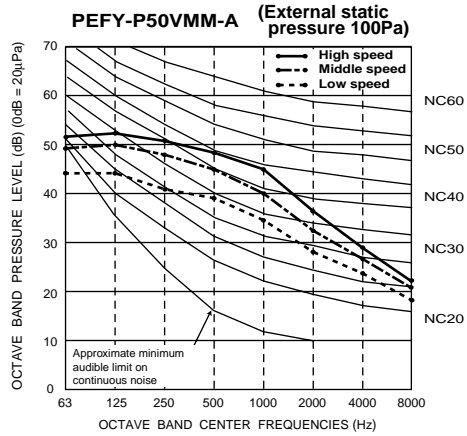
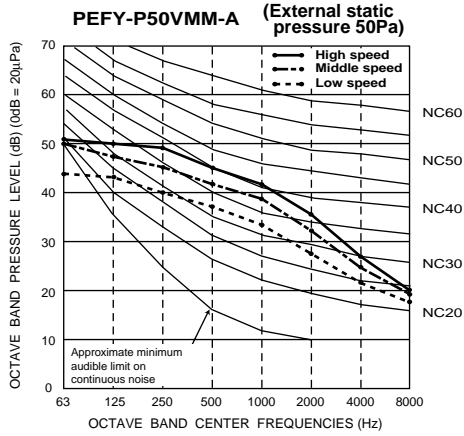

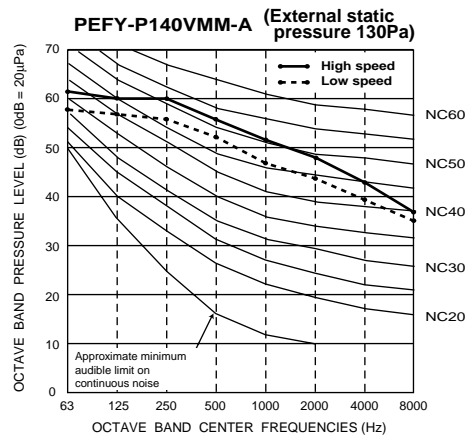
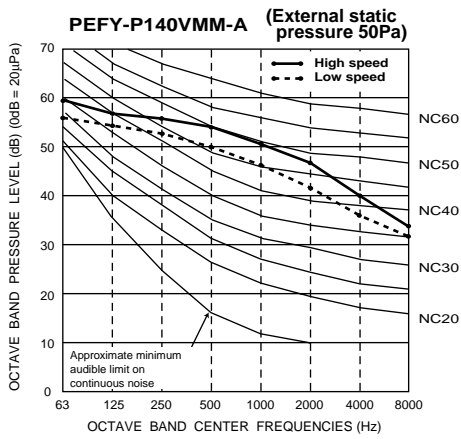
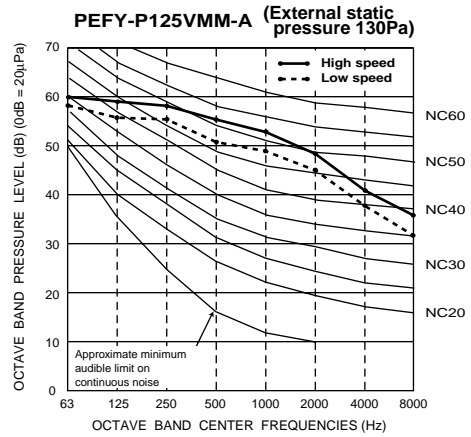
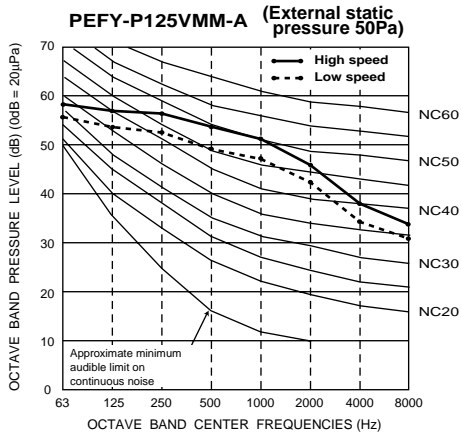
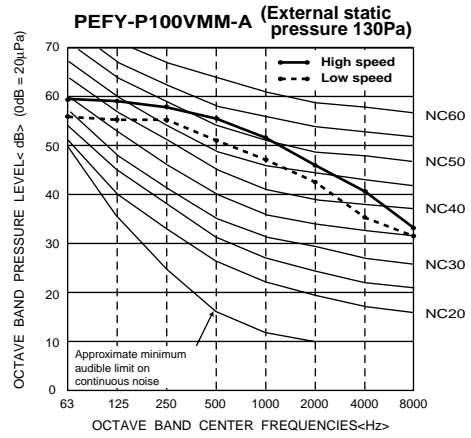
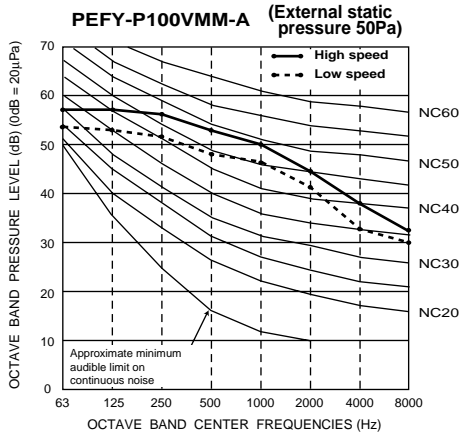

3-3. Fan characteristics curves(VMM-A)

PEFY-P-VMM-A

PEFY-P20,25VMM-A

External static pressure : 30,50,100Pa
Power source : 220-240(V)

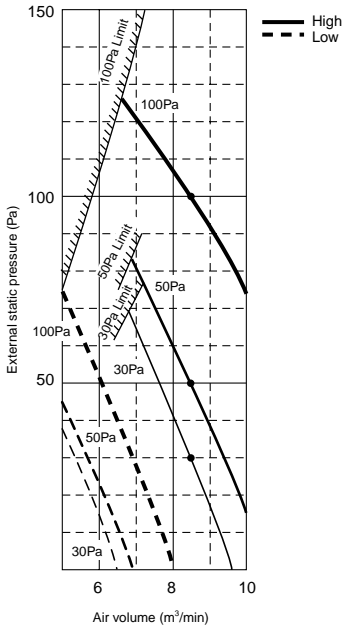

PEFY-P32VMM-A

External static pressure : 30,50,100Pa
Power source : 220-240(V)

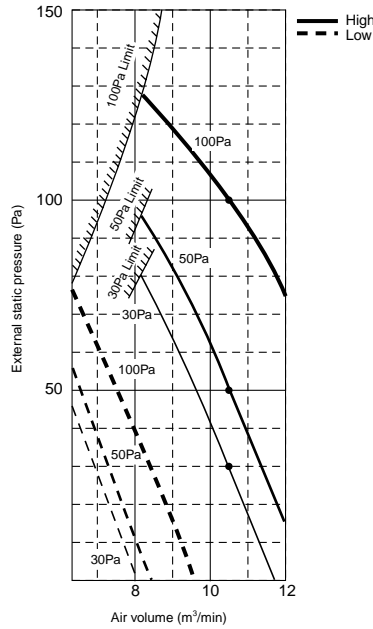

PEFY-P40VMM-A

External static pressure : 30,50,100Pa
Power source : 220-240(V)

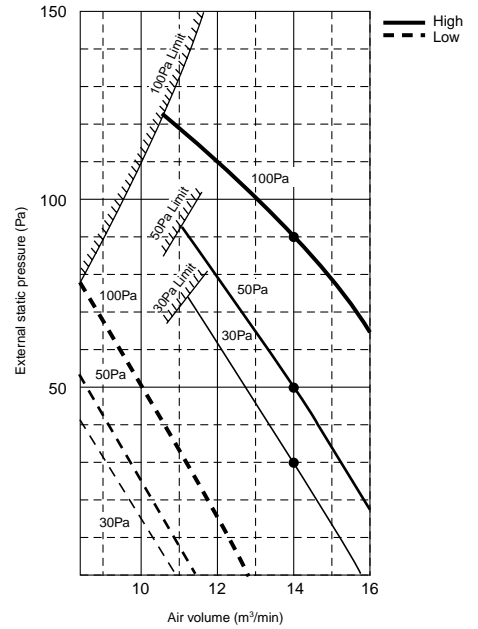

PEFY-P50VMM-A

External static pressure : 30,50,100Pa
Power source : 220-240(V)

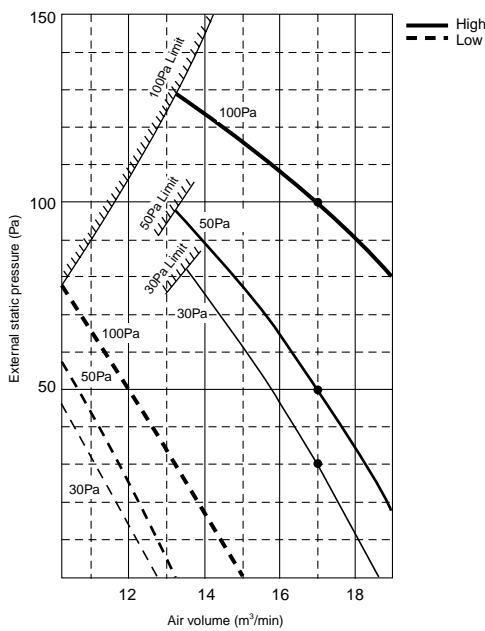

PEFY-P63VMM-A

External static pressure : 30,50,100Pa
Power source : 220-240(V)

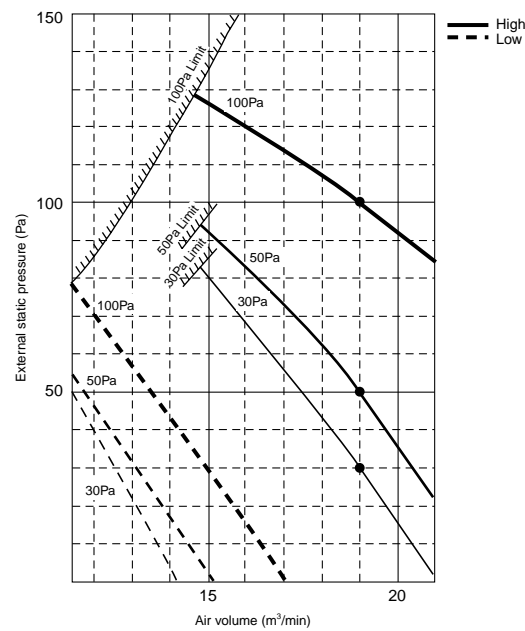

PEFY-P71,80VMM-A

External static pressure : 30,50,100Pa
Power source : 220-240(V)

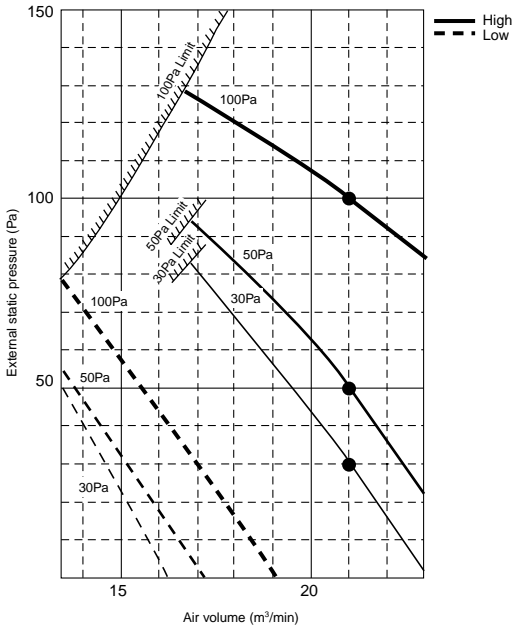

PEFY-P100VMM-A

External static pressure : 50,130Pa
Power source : 220-240(V)

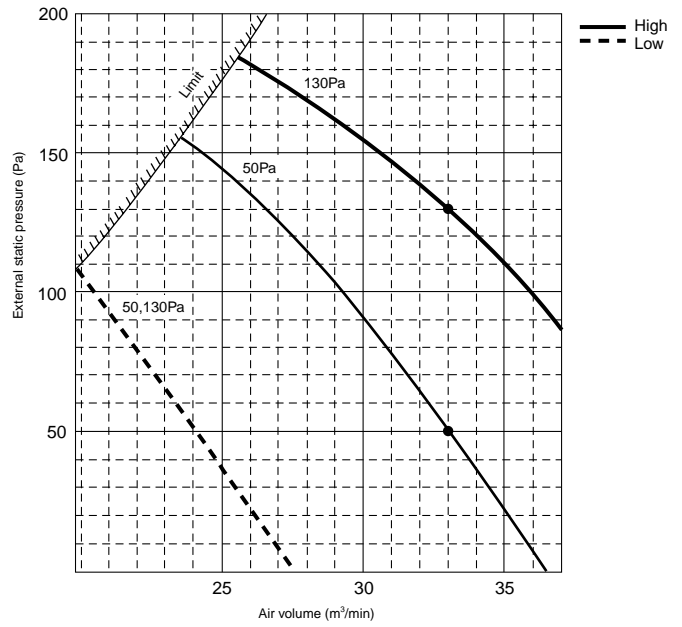

PEFY-P125VMM-A

External static pressure : 50,130Pa
Power source : 220-240(V)

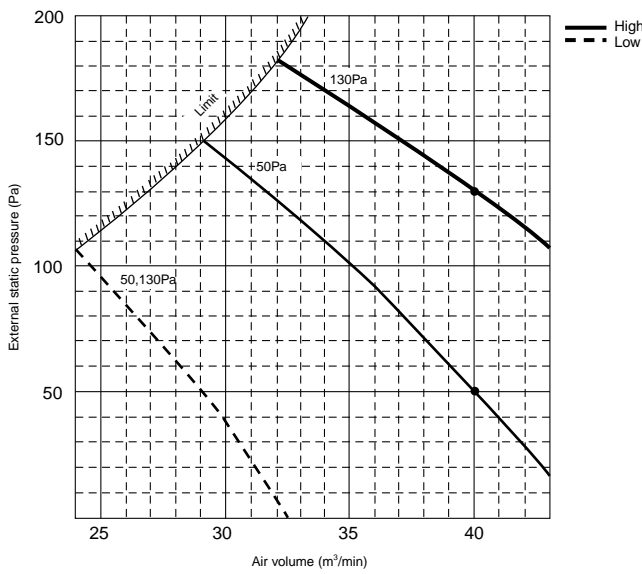

PEFY-P140VMM-A

External static pressure : 50,130Pa
Power source : 220-240(V)

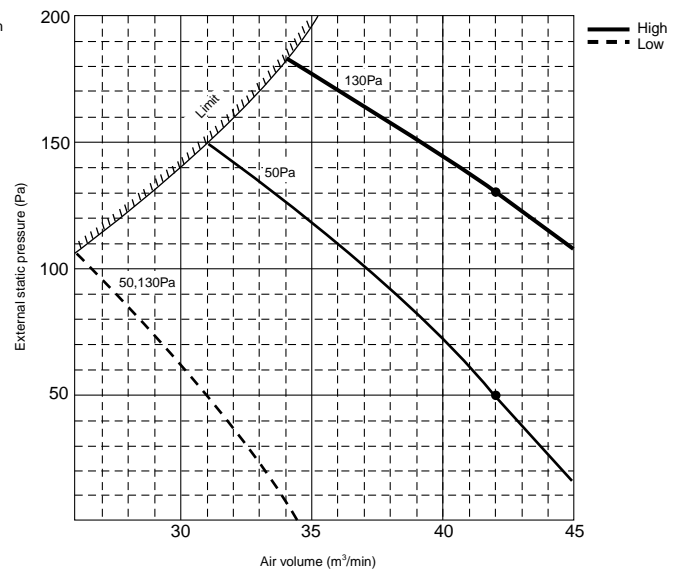

PEFY-P100,125,140VMM-A

Unit : mm

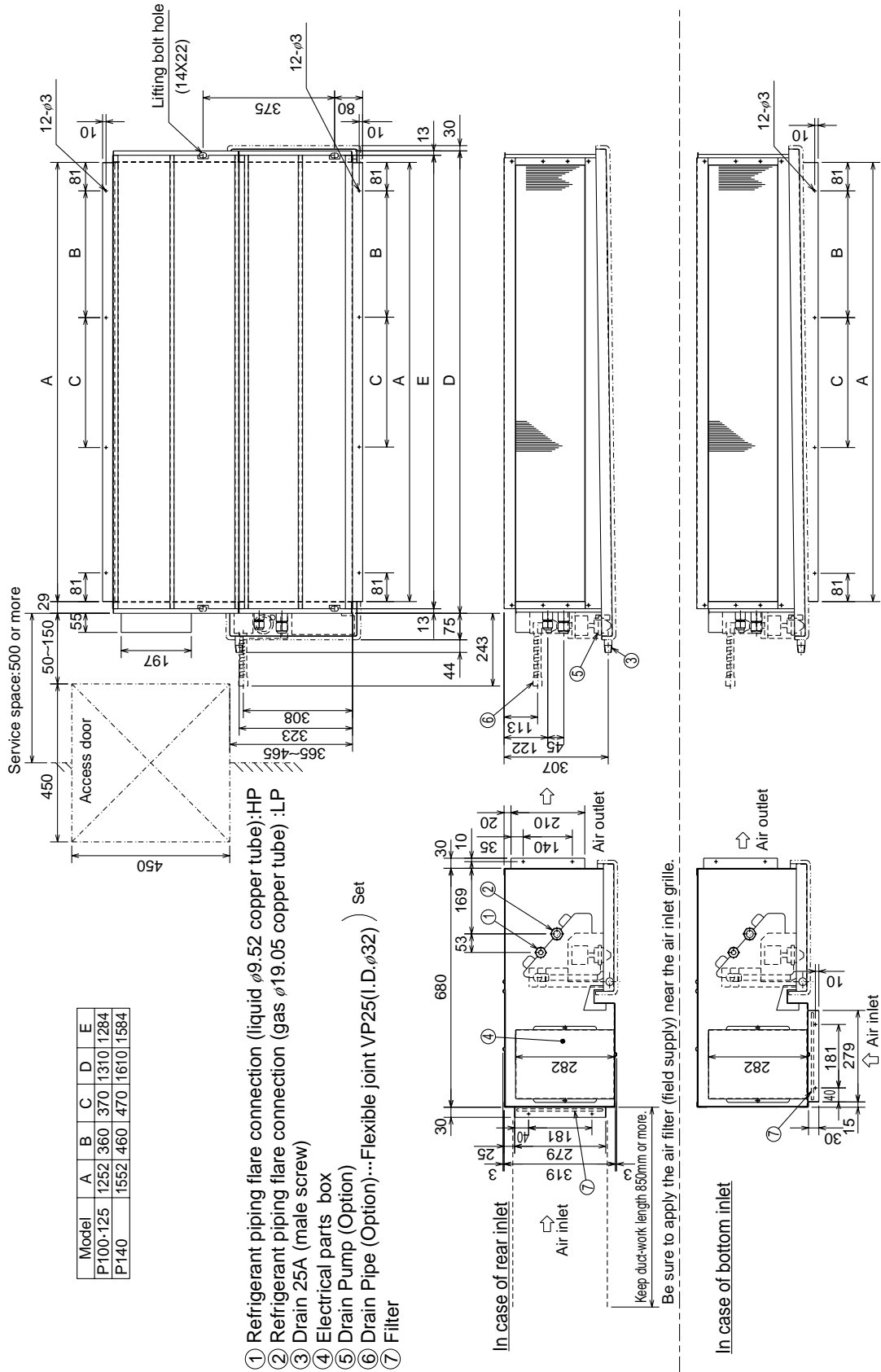

5. Electrical Wiring Diagrams

PEFY-P20~80VMM-A

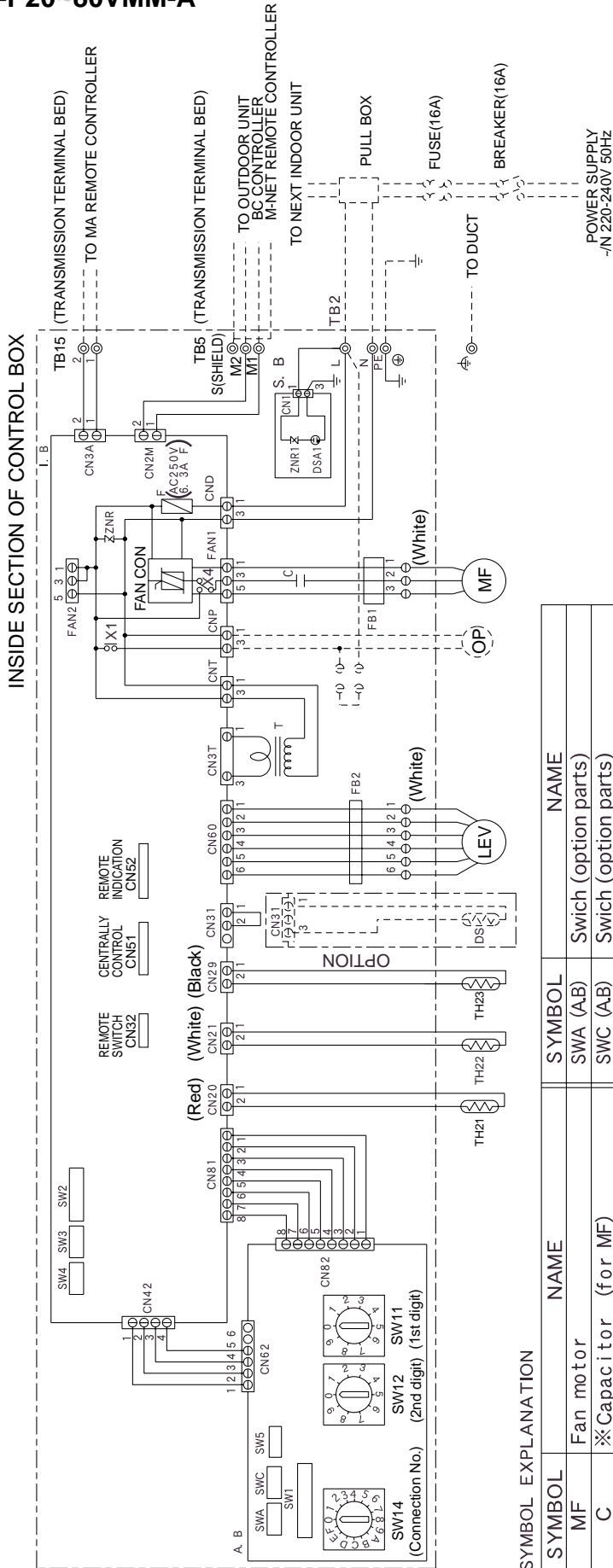

NOTE: 1. TB2, TB5 shown in dotted line are field work.
2. Mark ⊙ indicates terminal bed, ⊕ connector, ⊞ board insertion connector or fastening connector of control board.

※ Capacitor
 MODELS 20/25/32 6 μF
 MODELS 40/50 8 μF
 MODELS 63/71/80 6 μF

SYMBOL EXPLANATION

SYMBOL	NAME	SYMBOL	NAME
MF	Fan motor	SWA (A.B)	Switch (option parts)
C	※Capacitor (for MF)	SWC (A.B)	Switch (option parts)
I.B	Indoor controller board	SW1 1 (A.B)	Switch (1st digit address set)
A.B	Address board	SW1 2 (A.B)	Switch (2nd digit address set)
TB2	Power source terminal bed	SW1 4 (A.B)	Switch (connection No.set)
TB5	Transmission terminal bed	SW1 (A.B)	Switch(for mode selection)
TB15	Transmission terminal bed	SW2 (I.B)	Switch(for capacity code)
F	Fuse AC250V 6.3AF	SW3 (I.B)	Switch(for mode selection)
T	Transformer	SW4 (I.B)	Switch(for model selection)
LEV	Electronic linear expan. valve	SW5 (A.B)	Switch(for voltage selection)
TH21	Thermistor (inlet temp.detection)	FB1,2	Ferrite core
TH22	Thermistor (piping temp.detection/liquid)	S.B	Surge absorber board
TH23	Thermistor (piping temp.detection/gas)	DP	Drainpump
		DS	Drainsensor

PEFY-P100~140VMM-A

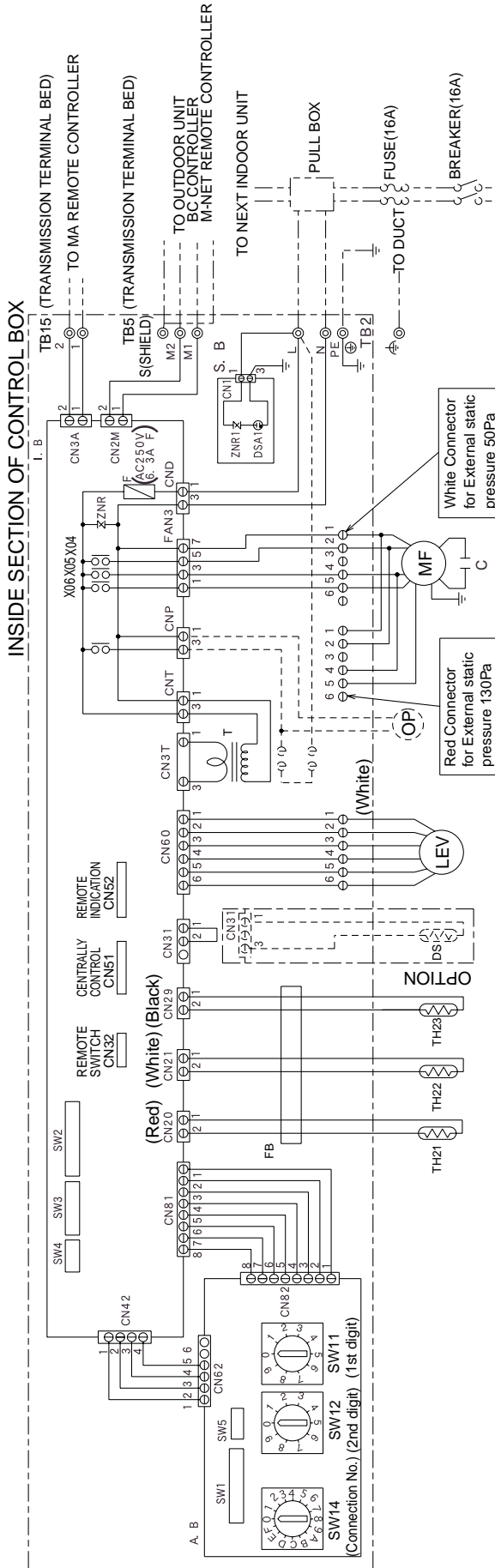

SYMBOL EXPLANATION

SYMBOL	NAME	SYMBOL	NAME
MF	Fan motor	TH22	Thermistor (piping temp.detection/liquid)
C	Capacitor (for MF)	TH23	Thermistor (piping temp.detection/gas)
I.B	Indoor controller board	SW1 1 (A.B)	Switch (1st digit address set)
AB	Address board	SW1 2 (A.B)	Switch (2nd digit address set)
TB2	Power source terminal bed	SW1 4 (A.B)	Switch (connection No.set)
TB15	Transmission terminal bed	SW1 (A.B)	Switch(for mode selection)
TB5	Transmission terminal bed	SW2 (I.B)	Switch(for capacity code)
F	Fuse AC250V 6.3A F	SW3 (I.B)	Switch(for mode selection)
T	Transformer	SW4 (I.B)	Switch(for model selection)
LEV	Electronic linear expans. valve	SW5 (A.B)	Switch(for voltage selection)
S.B	Surge absorber board	X04~06	Aux relay
FB	Ferrite core	DP	Drainpump
TH21	Thermistor (inlet temp.detection)	DS	Drain sensor

NOTE:1.TB2,TB5 shown in dotted line are field work.

2.Mark indicates terminal bed, connector, board insertion connector or fastening connector of control board.

※Capacitor
MODELS 100/125/140 8μF

6. Options

Description	Model	Applicable capacity
Circular duct flange	PAC-KE32EDF-F	P20/P25/P32
	PAC-KE50EDF-F	P40/P50
	PAC-KE80EDF-F	P63/P71/P80
	PAC-KE125EDF-F	P100/P125
	PAC-KE140EDF-F	P140
Drain water lift-up kit	PAC-KE03DM-F	P20/P25/P32/P40/P50/P63/P71 P80/P100/P125/P140

PEFY-P-VM-M-A

CONTENTS

1. Specifications II -64

2. Capacity Tables II -65

 2-1 Cooling Capacity II -65

 2-2 Cooling outlet air temp. II -65

 2-3 Heating Capacity II -66

 2-4 Heating outlet air temp. II -66

3. Sound Levels II -67

 3-1 Noise levels(VMH-A-F) II -67

 3-2 N/C curves(VMH-A-F) II -67

 3-3 Fan characteristics curves(VMH-A-F) II -71

4. External Dimensions II -73

5. Electrical Wiring Diagrams II -74

6. Options II -75



1. Specifications

				PEFY-P80VMH-A-F	PEFY-P140VMH-A-F	
Power source				~ 220-240V 50Hz / ~ 208-230V 60Hz		
Cooling capacity	* 1	kW	9.0		16.0	
	* 2	kcal/h	8,000		14,000	
Heating capacity	* 1	kW	8.5		15.1	
Power consumption (50/60Hz)	Cooling	kW	0.16/0.21		0.29/0.33	
	Heating	kW	0.16/0.21		0.29/0.33	
Current	Cooling	A	0.67/0.91		1.24/1.48	
	Heating	A	0.67/0.91		1.24/1.48	
External finish				Galvanizing		
Dimension	Height	mm	380			
	Width	mm	1000	1200		
	Depth	mm	900			
Net weight		kg	50	70		
Heat exchanger				Cross fin (Aluminum plate fin and copper tube)		
Fan	Type		Sirocco fan X 1		Sirocco fan X 2	
	Airflow rate	m ³ /min	9.0		18.0	
	External static pressure (Low/Mid/High)	208V	Pa	35/85/170		35/85/170
		220V	Pa	40/115/190		50/115/190
		230V	Pa	50/130/210		60/130/220
240V		Pa	80/170/220		100/170/240	
Motor	Type		Single phase induction motor			
	Output	* 3	kW	0.09	0.14	
Air filter (option)				Synthetic fiber unwoven cloth filter(long life)		
Refrigerant pipe dimension	Gas (Flare)	mm	ø 15.88		ø 19.05	
	Liquid (Flare)	mm	ø 9.52			
Drain pipe dimension				32 (1-1/4 inch)		
Noise level	* 4	208, 220V	dB(A)	27/38/43		
		230, 240V	dB(A)	33/43/45		

- Note: * 1 Cooling/Heating capacity indicates the maximum value at operation under the following condition.
Cooling : Indoor 33°CDB/28°CWB, Outdoor 33°CDB
Heating : Indoor 0°CDB/-2.9°CWB, Outdoor 0°CDB/-2.9°CWB
* 2 Cooling capacity indicates the maximum value at operation under the following condition.
Cooling : Indoor 27°CDB/19.5°CWB, Outdoor 35°CDB (WR2: water 30°C)
* 3 The value are that at 220V.
* 4 It is measured in anechoic room.

- The cooling and heating capacities are the maximum capacities that were obtained by operating in the above air conditions and with a refrigerant pipe of about 7.5m.
- The actual capacity characteristics vary with the combination of indoor and outdoor units. See the technical information.
- The operating noise is the data that was obtained by measuring it 1.5m from the bottom of the unit in an anechoic room. (Noise meter A-scale value)
- The figure of Electrical characteristic indicates at 220V.
- When the 100% fresh air indoor units are connected, the maximum connectable indoor units to 1 outdoor unit are as follows.

Heatpump models	Coolling only
110%(100% in case of heating below-5deg)	110%

- Operational temp range is cooling : from 21degDB/15.5degWB to 43degDB/35degWB.
Heating : from -10degDB to 20degDB
*Thermo off (Fan) operation automatically starts either when temperature is lower than 21degDB in cooling mode or when the temperature exceeds 20degDB in heating mode.
- As the room temp is sensed by the thermo in the remote controller or the one in the room, be sure to use either remote controller or room thermo.
- Autochangeover function or Dry mode is Not available .Fan mode operation during the thermo off in Cooling/Heating mode.
- The fan would temporary stops either with R2/WR2 system or in defrost.
- In any case, the wir flow rate should be kept lower than 110% of the above chart.Please see “ Fan curves “ for the details.
- When this unit is used as sole A/C system, be careful about the dew in air outlet grilles in cooling mode.
- Air filter must be installed in the air intake side.The filter should be attached where easy maintenance is possible in case of usage of field supply filters.
- Long life filter cannot be used with Hi-efficiency filter together.

2. Capacity Tables

2-1.Cooling Capacity

CA :Capacity(kW)
SHC:Sensible Heat Capacity(kW)

PEFY-P80VMH-A-F

Outdoor air temp.	°CWB																	
	15		17		20		23		26		28		30		32		35	
	CA	SHC	CA	SHC	CA	SHC	CA	SHC	CA	SHC	CA	SHC	CA	SHC	CA	SHC	CA	SHC
21	4.4	3.0	5.3	2.9	-	-	-	-	-	-	-	-	-	-	-	-	-	-
23	4.4	3.4	5.3	3.3	6.5	3.0	-	-	-	-	-	-	-	-	-	-	-	-
25	4.4	3.8	5.2	3.7	6.4	3.4	-	-	-	-	-	-	-	-	-	-	-	-
27	-	-	5.2	4.0	6.4	3.7	7.5	3.3	-	-	-	-	-	-	-	-	-	-
29	-	-	-	-	6.4	4.1	7.5	3.7	8.5	3.2	-	-	-	-	-	-	-	-
31	-	-	-	-	6.3	4.5	7.4	4.0	8.4	3.5	9.1	3.1	-	-	-	-	-	-
33	-	-	-	-	-	-	7.3	4.4	8.3	3.8	9.0	3.5	9.6	3.0	-	-	-	-
35	-	-	-	-	-	-	7.2	4.7	8.2	4.2	8.9	3.8	9.5	3.3	-	-	-	-
37	-	-	-	-	-	-	-	-	8.1	4.5	8.8	4.1	9.4	3.7	9.9	3.2	-	-
40	-	-	-	-	-	-	-	-	8.0	5.0	8.6	4.6	9.1	4.1	9.7	3.7	10.5	2.9

PEFY-P140VMH-A-F

Outdoor air temp.	°CWB																	
	15		17		20		23		26		28		30		32		35	
	CA	SHC	CA	SHC	CA	SHC	CA	SHC	CA	SHC	CA	SHC	CA	SHC	CA	SHC	CA	SHC
21	7.8	5.6	9.4	5.3	-	-	-	-	-	-	-	-	-	-	-	-	-	-
23	7.8	6.3	9.3	6.0	11.5	5.4	-	-	-	-	-	-	-	-	-	-	-	-
25	7.8	7.1	9.3	6.8	11.5	6.1	-	-	-	-	-	-	-	-	-	-	-	-
27	-	-	9.3	7.5	11.4	6.8	13.4	6.0	-	-	-	-	-	-	-	-	-	-
29	-	-	-	-	11.3	7.5	13.3	6.7	15.2	5.6	-	-	-	-	-	-	-	-
31	-	-	-	-	11.2	8.2	13.2	7.3	15.0	6.3	16.2	5.5	-	-	-	-	-	-
33	-	-	-	-	-	-	13.0	8.0	14.8	7.0	16.0	6.2	17.1	5.3	-	-	-	-
35	-	-	-	-	-	-	12.9	8.7	14.6	7.6	15.8	6.8	16.9	6.0	-	-	-	-
37	-	-	-	-	-	-	-	-	14.5	8.3	15.6	7.5	16.6	6.6	17.7	5.7	-	-
40	-	-	-	-	-	-	-	-	14.2	9.3	15.2	8.5	16.3	7.6	17.3	6.7	18.7	5.3

There are times when the cooling capacity is lowered to protect the compressor in cases where the external temperature exceeds 40°C

PEFY-P-VMH-A-F

2-2.Cooling outlet air temp.

CA :Capacity(kW)
SHC:Sensible Heat Capacity(kW)

PEFY-P80VMH-A-F

Outdoor air temp.	°CWB																	
	15		17		20		23		26		28		30		32		35	
	°CDB	°CWB	°CDB	°CWB	°CDB	°CWB	°CDB	°CWB	°CDB	°CWB	°CDB	°CWB	°CDB	°CWB	°CDB	°CWB	°CDB	°CWB
21	5.1	5.0	5.6	5.6	-	-	-	-	-	-	-	-	-	-	-	-	-	-
23	5.1	5.0	5.7	5.6	7.0	7.0	-	-	-	-	-	-	-	-	-	-	-	-
25	5.1	5.0	5.7	5.7	7.1	7.1	-	-	-	-	-	-	-	-	-	-	-	-
27	-	-	5.8	5.7	7.2	7.2	9.2	9.2	-	-	-	-	-	-	-	-	-	-
29	-	-	-	-	7.4	7.3	9.4	9.4	12.0	12.0	-	-	-	-	-	-	-	-
31	-	-	-	-	7.5	7.4	9.6	9.6	12.2	12.2	14.2	14.2	-	-	-	-	-	-
33	-	-	-	-	-	-	9.8	9.7	12.4	12.4	14.4	14.4	16.6	16.6	-	-	-	-
35	-	-	-	-	-	-	10.0	9.9	12.6	12.6	14.6	14.6	16.8	16.8	-	-	-	-
37	-	-	-	-	-	-	-	-	12.8	12.8	14.9	14.8	17.1	17.1	19.5	19.5	-	-
40	-	-	-	-	-	-	-	-	13.2	13.1	15.3	15.2	17.5	17.4	19.9	19.8	23.7	23.7

PEFY-P140VMH-A-F

Outdoor air temp.	°CWB																	
	15		17		20		23		26		28		30		32		35	
	°CDB	°CWB	°CDB	°CWB	°CDB	°CWB	°CDB	°CWB	°CDB	°CWB	°CDB	°CWB	°CDB	°CWB	°CDB	°CWB	°CDB	°CWB
21	6.3	6.3	7.1	7.0	-	-	-	-	-	-	-	-	-	-	-	-	-	-
23	6.3	6.3	7.1	7.1	8.7	8.7	-	-	-	-	-	-	-	-	-	-	-	-
25	6.4	6.3	7.2	7.1	8.8	8.8	-	-	-	-	-	-	-	-	-	-	-	-
27	-	-	7.2	7.1	8.9	8.9	11.1	11.1	-	-	-	-	-	-	-	-	-	-
29	-	-	-	-	9.0	9.0	11.2	11.2	13.9	13.9	-	-	-	-	-	-	-	-
31	-	-	-	-	9.1	9.0	11.4	11.3	14.0	14.0	16.1	16.1	-	-	-	-	-	-
33	-	-	-	-	-	-	11.5	11.5	14.2	14.2	16.2	16.2	18.4	18.4	-	-	-	-
35	-	-	-	-	-	-	11.7	11.6	14.4	14.4	16.4	16.4	18.6	18.6	-	-	-	-
37	-	-	-	-	-	-	-	-	14.6	14.5	16.7	16.6	18.8	18.8	21.2	21.1	-	-
40	-	-	-	-	-	-	-	-	14.9	14.8	17.0	16.9	19.2	19.1	21.5	21.5	25.2	25.2

2-3.Heating Capacity

PEFY-P80VMH-A-F

SHC:Sensible Heat Capacity(kW)

Outdoor air temp.	°CWB								
°CDB	-9	-5	-2.9	0	2	4	6	10	14
	SHC	SHC	SHC	SHC	SHC	SHC	SHC	SHC	SHC
-8	8.2	-	-	-	-	-	-	-	-
-3	-	9.1	-	-	-	-	-	-	-
0	-	-	8.5	-	-	-	-	-	-
3	-	-	-	7.9	7.9	-	-	-	-
7	-	-	-	-	7.1	7.1	7.1	-	-
11	-	-	-	-	-	-	6.3	6.3	-
15	-	-	-	-	-	-	-	5.5	5.5
18	-	-	-	-	-	-	-	5.0	5.0
20	-	-	-	-	-	-	-	-	4.6

PEFY-P140VMH-A-F

Outdoor air temp.	°CWB								
°CDB	-9	-5	-2.9	0	2	4	6	10	14
	SHC	SHC	SHC	SHC	SHC	SHC	SHC	SHC	SHC
-8	14.6	-	-	-	-	-	-	-	-
-3	-	16.2	-	-	-	-	-	-	-
0	-	-	15.1	-	-	-	-	-	-
3	-	-	-	14.0	14.0	-	-	-	-
7	-	-	-	-	12.6	12.6	12.6	-	-
11	-	-	-	-	-	-	11.2	11.2	-
15	-	-	-	-	-	-	-	9.8	9.8
18	-	-	-	-	-	-	-	8.8	8.8
20	-	-	-	-	-	-	-	-	8.1

2-4.Heating outlet air temp.

PEFY-P80VMH-A-F

SHC:Sensible Heat Capacity(kW)

Outdoor air temp.	°CWB								
°CDB	-9	-5	-2.9	0	2	4	6	10	14
	°CDB	°CDB	°CDB	°CDB	°CDB	°CDB	°CDB	°CDB	°CDB
-8	40.6	-	-	-	-	-	-	-	-
-3	-	53.1	-	-	-	-	-	-	-
0	-	-	51.9	-	-	-	-	-	-
3	-	-	-	51.3	51.8	-	-	-	-
7	-	-	-	-	50.5	50.5	50.9	-	-
11	-	-	-	-	-	-	49.6	50.1	-
15	-	-	-	-	-	-	-	48.8	49.2
18	-	-	-	-	-	-	-	48.2	48.2
20	-	-	-	-	-	-	-	-	47.8

PEFY-P140VMH-A-F

Outdoor air temp.	°CWB								
°CDB	-9	-5	-2.9	0	2	4	6	10	14
	°CDB	°CDB	°CDB	°CDB	°CDB	°CDB	°CDB	°CDB	°CDB
-8	34.7	-	-	-	-	-	-	-	-
-3	-	45.8	-	-	-	-	-	-	-
0	-	-	45.6	-	-	-	-	-	-
3	-	-	-	45.4	45.4	-	-	-	-
7	-	-	-	-	45.2	45.2	45.2	-	-
11	-	-	-	-	-	-	45.0	45.0	-
15	-	-	-	-	-	-	-	44.7	45.1
18	-	-	-	-	-	-	-	44.6	44.6
20	-	-	-	-	-	-	-	-	44.4

3. Sound Levels

3-1. Noise level(VMH-A-F)

Ceiling concealed (VMH-A series)

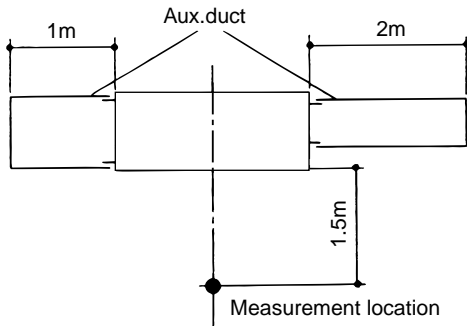

Noise level at anechoic room

Unit : dB(A)

Model		External static pressure		
		Low	Mid	High
PEFY-P80 VMH-A-F	208,220V	27	38	43
	230,240V	33	43	45
PEFY-P140 VMH-A-F	208,220V	28	38	43
	230,240V	34	43	45

Model		Power source	208	220	230	240
PEFY-P80VMH-A-F	50Hz	Low	-	40	50	80
		Mid	-	115	130	170
		High	-	190	210	220
	60Hz	Low	35	40	50	-
		Mid	85	115	130	
		High	170	190	210	
PEFY-P140VMH-A-F	50Hz	Low	-	50	60	100
		Mid	-	115	130	170
		High	-	119	220	240
	60Hz	Low	35	50	60	-
		Mid	85	115	130	
		High	170	190	220	

PEFY-P-VMH-A-F

3-2. NC curves(VMH-A-F)

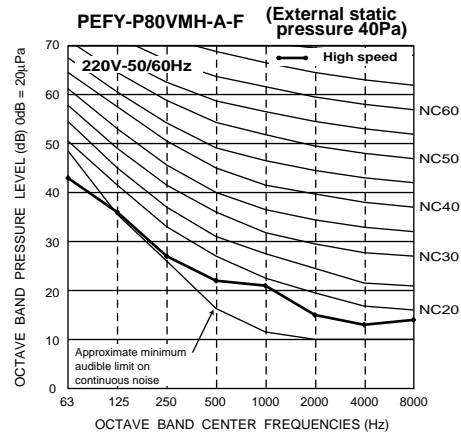
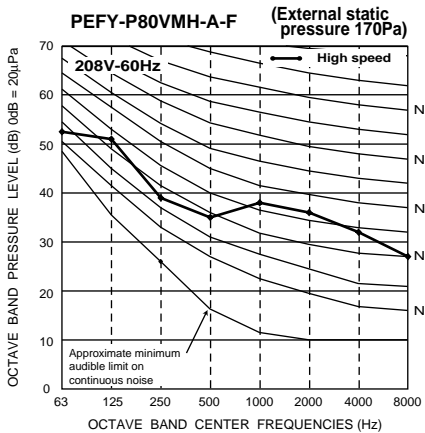
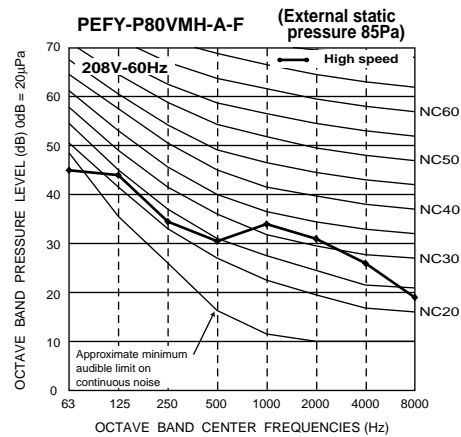
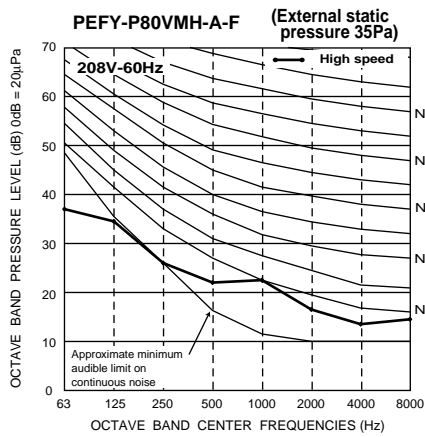

**PEFY-P-
VMH-A-F**

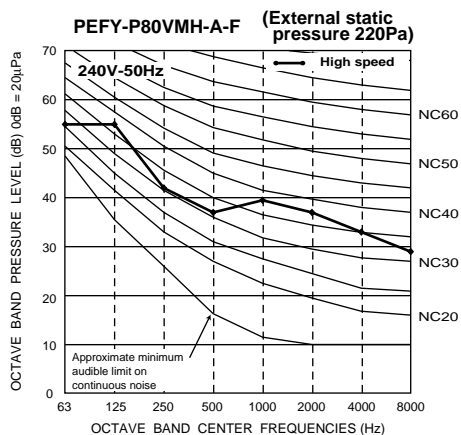
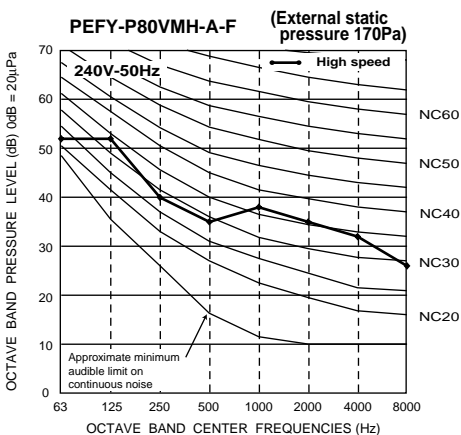
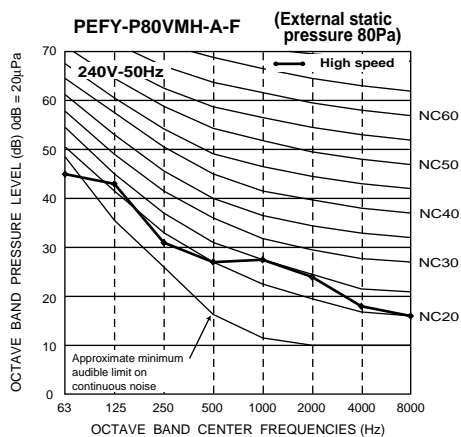
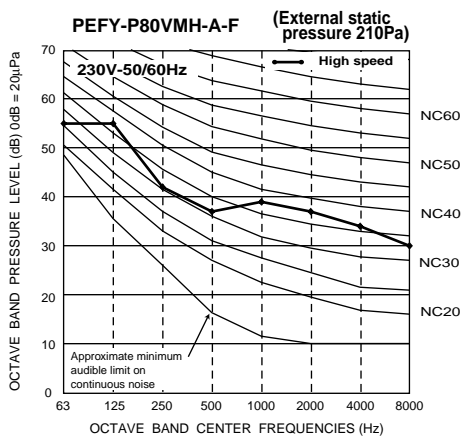
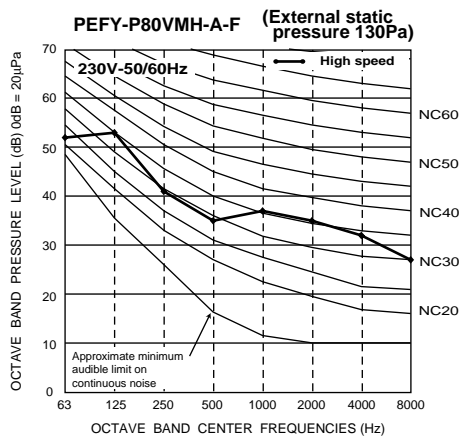
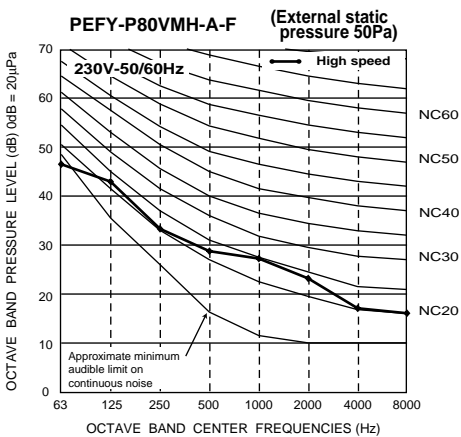
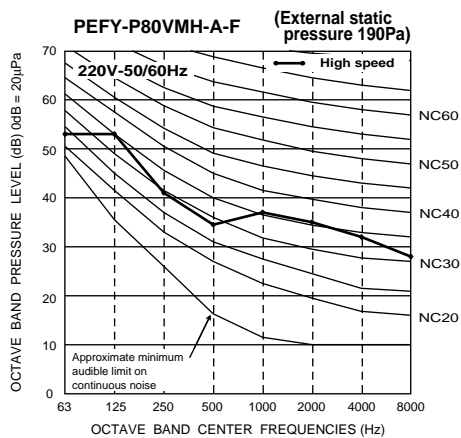
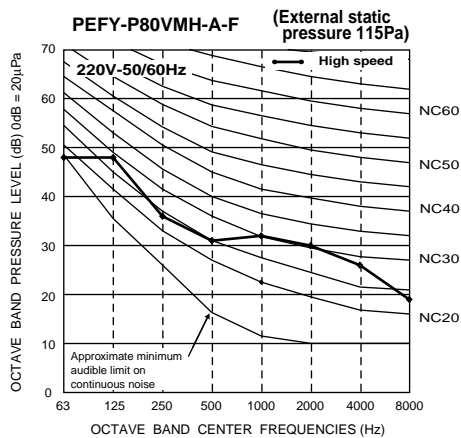

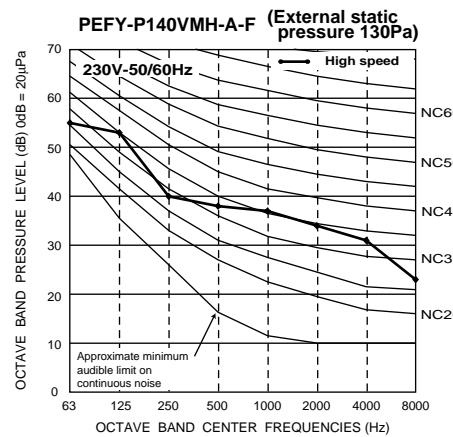
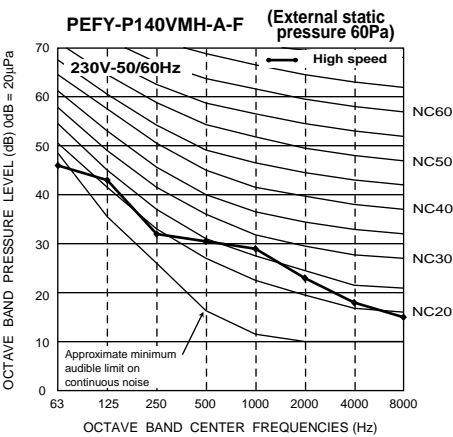
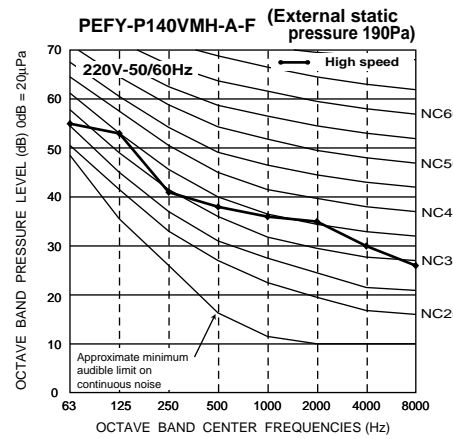
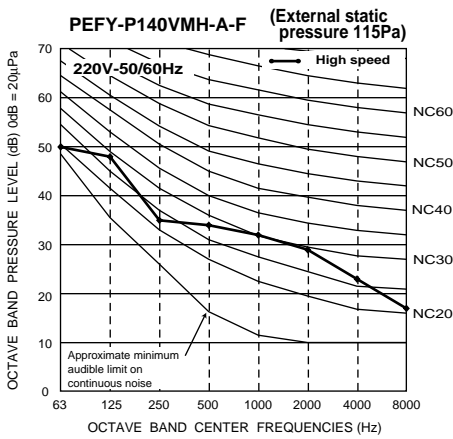
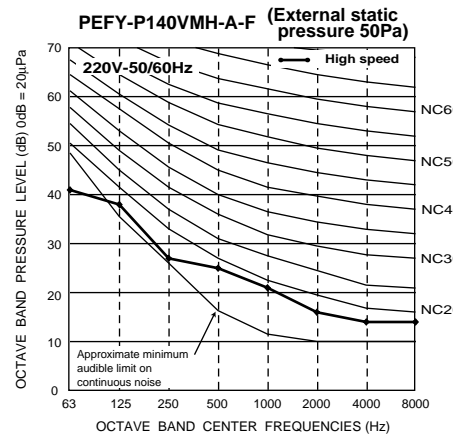
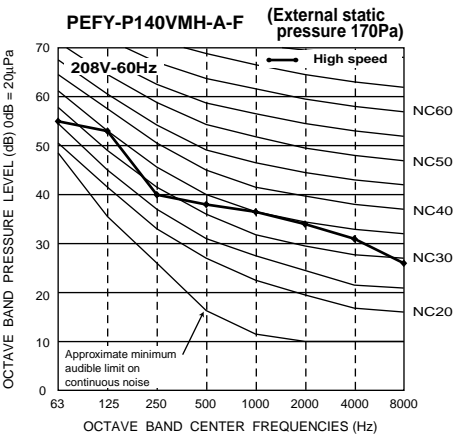
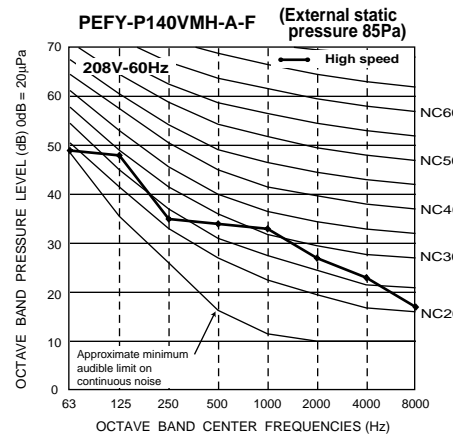
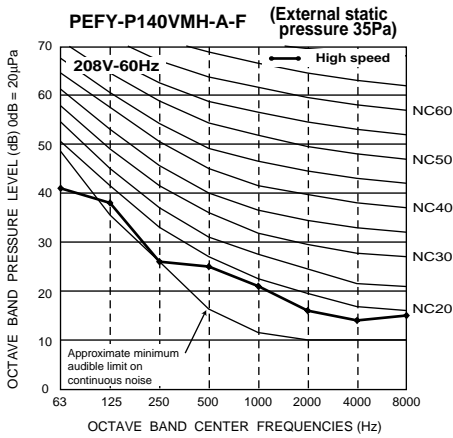

**PEFY-P-
VMH-A-F**

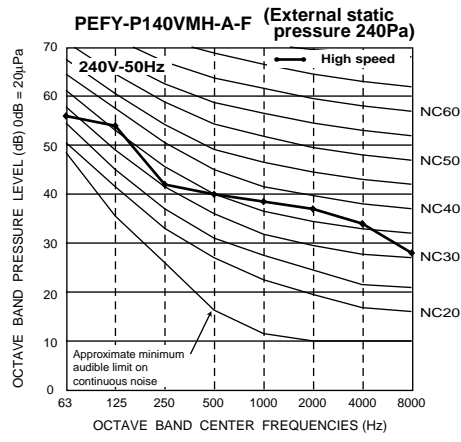
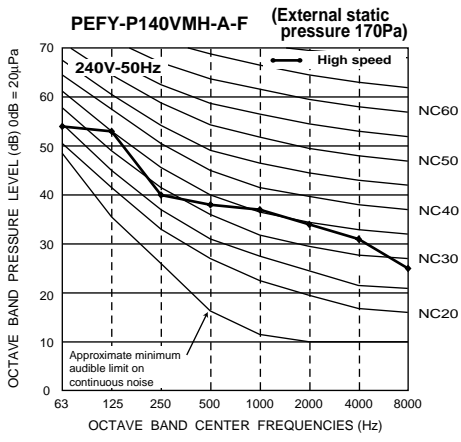
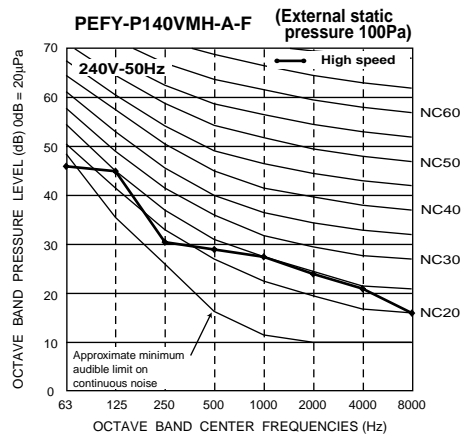
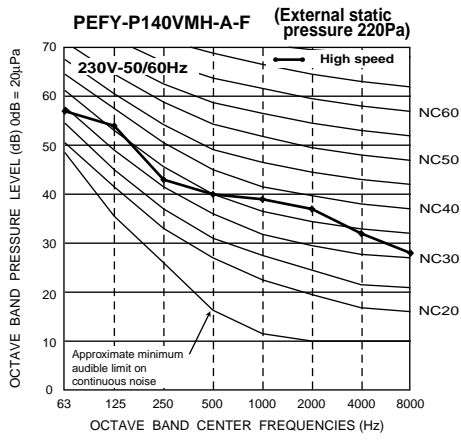

3-3. Fan characteristics curves(VMH-A-F)

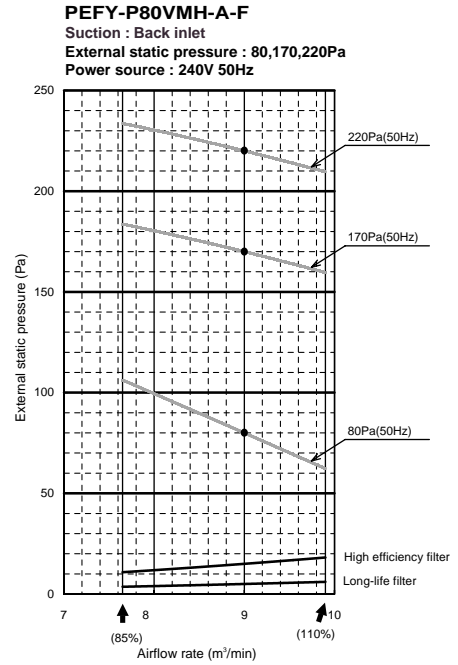
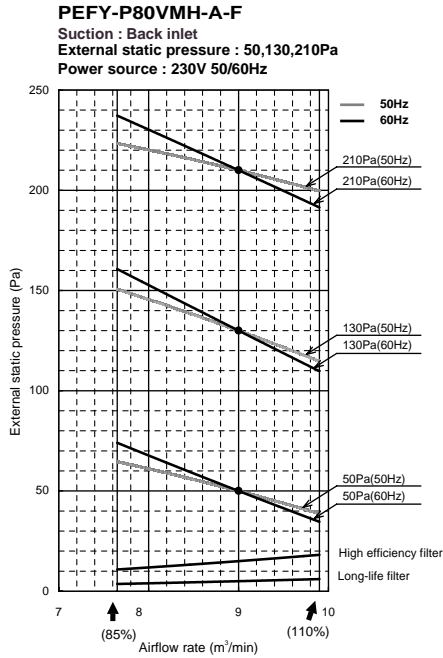
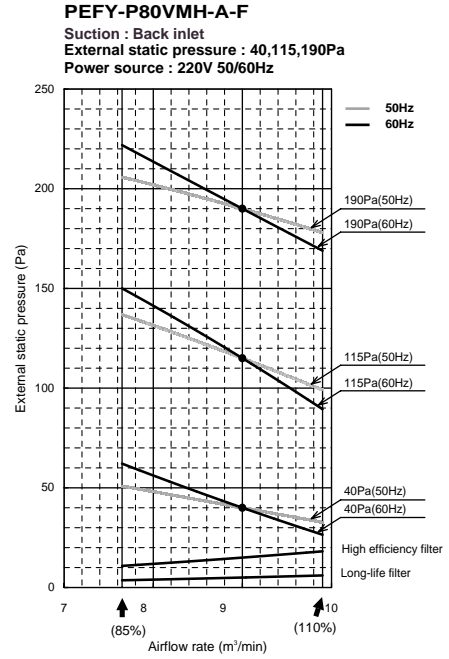
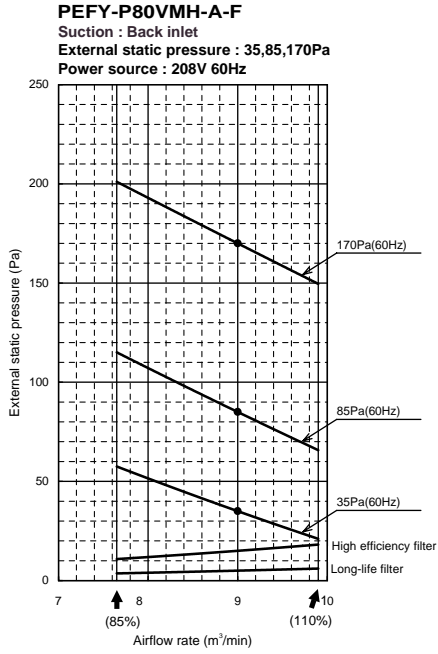

**PEFY-P-
VMH-A-F**

PEFY-P140VMH-A-F

Suction : Back inlet
 External static pressure : 35,85,170Pa
 Power source : 208V 60Hz

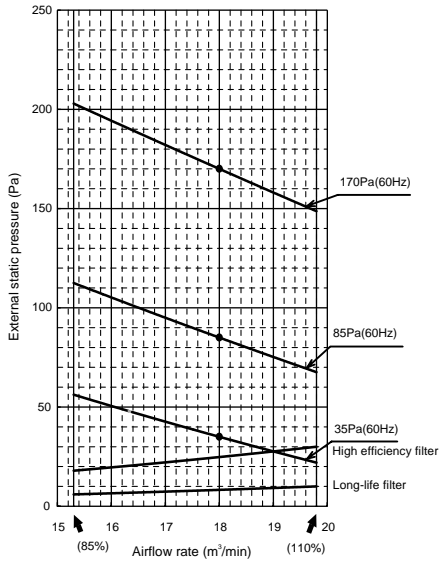

PEFY-P140VMH-A-F

Suction : Back inlet
 External static pressure : 50,115,190Pa
 Power source : 220V 50/60Hz

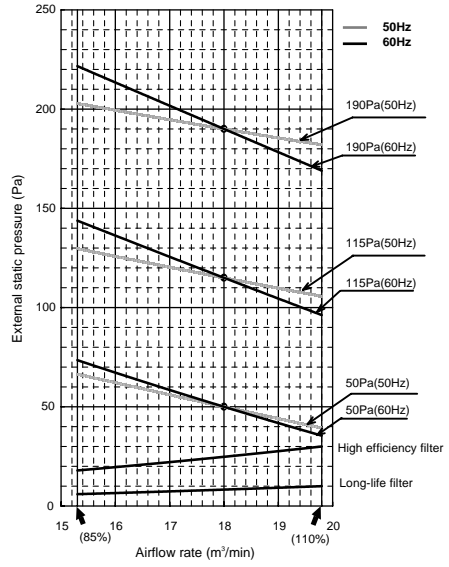

PEFY-P140VMH-A-F

Suction : Back inlet
 External static pressure : 60,130,220Pa
 Power source : 230V 50/60Hz

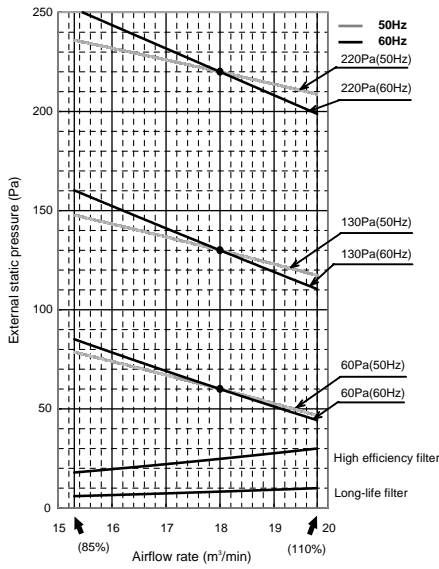

PEFY-P140VMH-A-F

Suction : Back inlet
 External static pressure : 100,170,240Pa
 Power source : 240V 50Hz

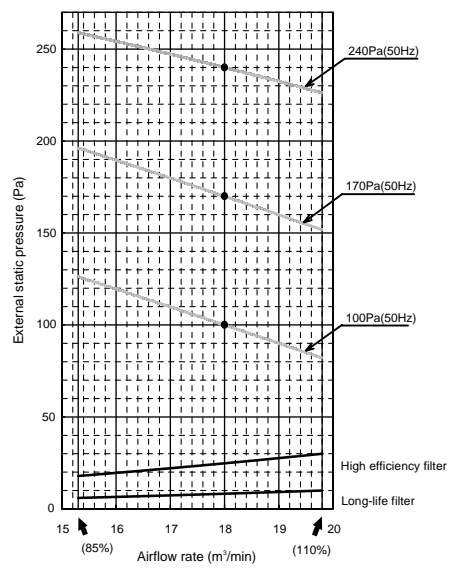

4. External Dimensions

PEFY-P80,140VMH-A-F

Required space for service and maintenance

Make the access door at the appointed position properly for service maintenance.

When installing the drain water lifting-up mech(option).

Model:80(Note3)

Keep duct-work length 850mm or more.

Note

- Use M10 screw for the lifting bolt (field supply).
- Keep the service space for the maintenance from the bottom when the heat exchanger is cleaned.
- This chart indicates for PEFY-P140VMH-A-F models, which have 2 fans.
- Make sure to install the air filter(field supply) on the air intake side.

In case field supplied air filter is used, attach it where the filter service is easily done.

- Refrigerant piping flare connection (gas M copper tube):LP
- Refrigerant piping flare connection (liquid N copper tube):HP
- Drain hose 32mm(1-1/4inch) <flexible joint 200mm> (accessory)

Model	A	B	C	D	E	F	G	H	J	K	L	M	N
PEFY-P80VMH-A-F	1050	1004	930	850	800	25	17	800	15	700	1030	#15.88	#9.52
PEFY-P140VMH-A-F	1250	1204	1130	1050	1000	25	21	1000	19	900	1230	#19.05	#9.52



5. Electrical Wiring Diagrams

PEFY-P80,140VMH-A-F

**PEFY-P-
VMH-A-F**

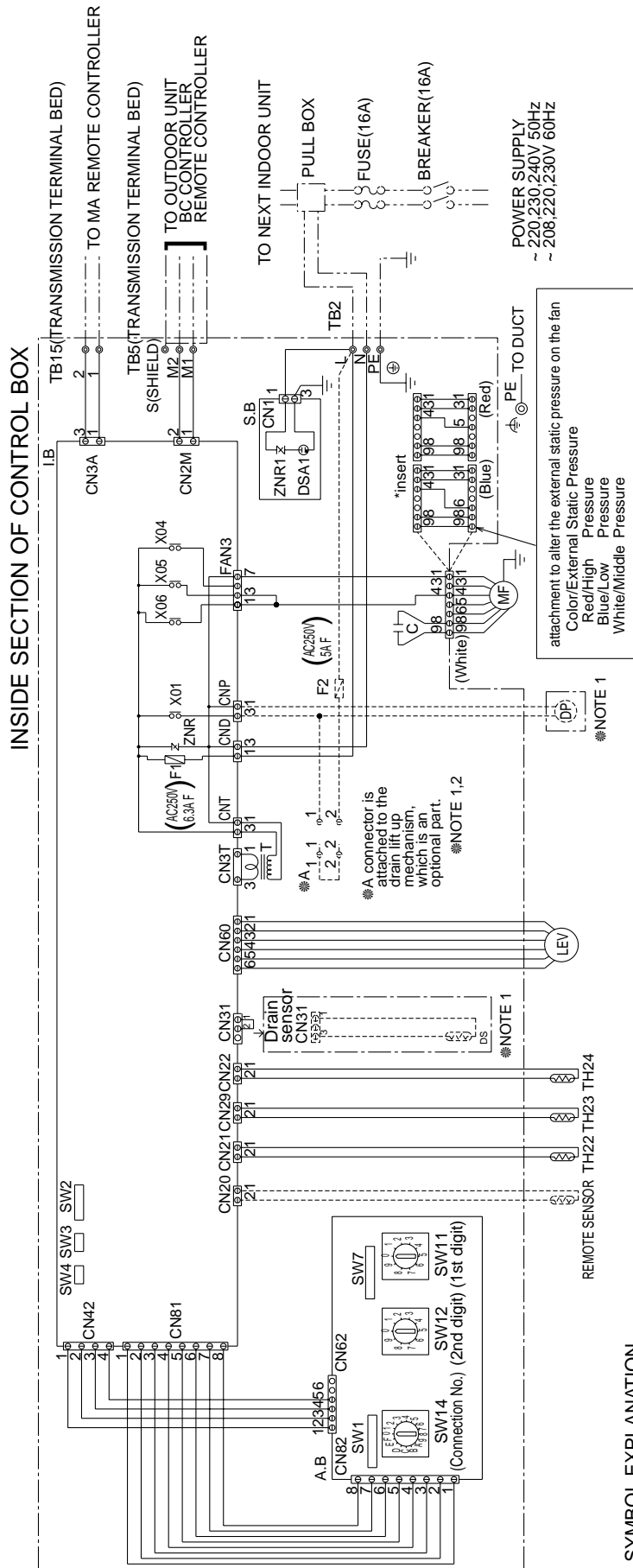

SYMBOL EXPLANATION

SYMBOL	NAME	SYMBOL	NAME
MF	Fan motor	CN20	Connector (remote sensor)
C	#B Capacitor (for MF)	TH22	Thermistor (piping temp.detection/liquid)
LB	Indoor controller board	TH23	Thermistor (piping temp.detection/gas)
<DS>	Drain sensor	TH24	Thermistor (outdoor air temp.detection)
AB	Address board	SW11(A,B)	Switch (1st digit address set)
TB2	Power source terminal bed	SW12(A,B)	Switch (2nd digit address set)
TB5	Transmission terminal bed	SW14(A,B)	Switch (connection No.set)
TB15	Transmission terminal bed	SW1(A,B)	Switch (for mode selection)
F1	Fuse AC250V 6.3A F	SW2(LB)	Switch(for capacity code)
<F2>	Fuse AC250V 5A F	SW3(LB)	Switch(for mode selection)
T	Transformer	SW4(LB)	Switch(for model selection)
<DP>	Drain Pump	SW7(A,B)	Switch(for model selection)
LEV	Electronic linear expans. valve	X04 ~ X06	Aux.relay
S.B	Surge absorber board		

Inside < > is the optional parts.

- NOTE : 1.** The part of the broken line indicates the circuit for optional parts.
- 2. #A** in the chart is the connector for a drain pump test run operation. (The Drain Pump operates continuously if the connector is inserted and the power is supplied.) After the test run, make sure to remove the #A connector.
- 3.** The wirings to TB2, TB5 (shown in dotted line) are field work.
- 4.** Mark ⊕ indicates terminal bed, ⊖ connector, ⊕ insertion connector or fastening connector of control board.

6. Options

Description	Model	Applicable capacity
Long life filter	PAC-KE88LAF	P80
	PAC-KE89LAF	P140
Filter box	PAC-KE80TBA-F	P80
	PAC-KE140TBA-F	P140
Drain water lift-up kit	PAC-KE04DM-F	P80/P140

CONTENTS

1. Specifications	II -78
2. Capacity Tables	II -79
2-1 Cooling Capacity(PUMY)	II -79
2-2 Heating Capacity(PUMY)	II -81
2-3 Cooling Capacity(Y/R2-8·10·13HP)	II -82
2-4 Heating Capacity(Y/R2-8·10·13HP)	II -84
2-5 Cooling Capacity(Big Y, Super Y, Big R2)	II -85
2-6 Heating Capacity(Big Y, Super Y, Big R2)	II -87
2-7 Cooling Capacity(WY, WR2)	II -88
2-8 Heating Capacity(WY, WR2)	II -89
3. Sound Levels	II -90
3-1 Noise levels	II -90
3-2 N/C curves	II -90
3-3 Fan characteristics curves	II -94
4. External Dimensions	II -95
5. Electrical Wiring Diagrams	II -97
6. Option	II -99

1. Specifications

			PDFY-P20VM-A	PDFY-P25VM-A	PDFY-P32VM-A	PDFY-P40VM-A	PDFY-P50VM-A
Power source			~ 220-240V 50Hz / ~ 220V 60Hz				
Cooling capacity	* 1	kW	2.2	2.8	3.6	4.5	5.6
	* 2	kcal/h	2,000	2,500	3,150	4,000	5,000
Heating capacity		kW	2.5	3.2	4.0	5.0	6.3
Power consumption (50/60Hz)	Cooling	kW	0.11/0.12			0.13/0.15	
	Heating	kW	0.11/0.12			0.13/0.15	
Current	Cooling	A	0.53/0.58			0.60/0.71	
	Heating	A	0.53/0.58			0.60/0.71	
External finish			Galvanizing				
Dimension	Height	mm	295				
	Width	mm	710			960	
	Depth	mm	735				
Net weight		kg	25.5	27	32	34	
Heat exchanger			Cross fin (Aluminum plate fin and copper tube)				
Fan	Type		Sirocco fanX 1			Sirocco fanX 2	
	Airflow rate (Lo-Mid2-Mid1-Hi)	m³/min	6.0-6.5-7.5-8.5			10.0-11.0-12.5-14.0	
	External static pressure * 3	Pa	30/50/100				
Motor	Type		Single phase induction motor				
	Output * 4	kW	0.075(at 240V)				
Air filter * 5			Synthetic fiber unwoven cloth filter(long life)				
Refrigerant pipe dimension	Gas (Flare)	mm	ø 12.7				ø 15.88
	Liquid (Flare)	mm	ø 6.35				ø 9.52
Drain pipe dimension			Outer diameter 32(VP-25)				
Noise level (Lo-Mid2-Mid1-Hi) * 7		dB(A)	28-30-33-36			34-36-37-39	

			PDFY-P63VM-A	PDFY-P71VM-A	PDFY-P80VM-A	PDFY-P100VM-A	PDFY-P125VM-A
Power source			~ 220-240V 50Hz / ~ 220V 60Hz				
Cooling capacity	* 1	kW	7.1	8.0	9.0	11.2	14.0
	* 2	kcal/h	6,300	7,100	8,000	10,000	12,500
Heating capacity		kW	8.0	9.0	10.0	12.5	16.0
Power consumption	Cooling	kW	0.14/0.17	0.15/0.18	0.17/0.21	0.27-0.31/0.29	0.33-0.38/0.39
	Heating	kW	0.14/0.17	0.15/0.18	0.17/0.21	0.27-0.31/0.29	0.33-0.38/0.39
Current	Cooling	A	0.68/0.82	0.72/0.88	0.82/1.01	1.28-1.34/1.36	1.55-1.63/1.84
	Heating	A	0.68/0.82	0.72/0.88	0.82/1.01	1.28-1.34/1.36	1.55-1.63/1.84
External finish			Galvanizing				
Dimension	Height	mm	295			335	
	Width	mm	1160			1510	
	Depth	mm	735			775	
Net weight		kg	39			52	
Heat exchanger			Cross fin (Aluminum plate fin and copper tube)				
Fan	Type		Sirocco fanX 2				
	Airflow rate (Lo-Mid2-Mid1-Hi)	m³/min	12.5-14.0-16.0-18.0	13.5-15.5-17.5-19.5	14.5-16.5-18.5-21.0	19.5-28.0 (Lo-Hi)	24.0-34.0 (Lo-Hi)
	External static pressure * 3	Pa	30/50/100			50/100/130	
Motor	Type		Single phase induction motor				
	Output * 4	kW	0.078(at 240V)			0.140(at 240V)	0.190(at 240V)
Air filter * 5			Synthetic fiber unwoven cloth filter(long life)				
Refrigerant pipe dimension	Gas (Flare)	mm	ø 15.88				ø 19.05
	Liquid (Flare)	mm	ø 9.52				
Drain pipe dimension			Outer diameter 32(VP-25)				
Noise level (Lo-Mid2-Mid1-Hi) * 7		dB(A)	30-34-36-39	32-35-37-40	34-37-40-42	34-42(37-44)*6	40-45(42-46)*6

Note: * 1 Cooling/Heating capacity indicates the maximum value at operation under the following condition.

Cooling : Indoor 27 °CDB/19 °CWB, Outdoor 35 °CDB

Heating : Indoor 20 °CDB, Outdoor 7 °CDB/6 °CWB

* 2 Cooling capacity indicates the maximum value at operation under the following condition.

Cooling : Indoor 27 °CDB/19.5 °CWB, Outdoor 35 °CDB (WR2: water 30 °C)

* 3 The external static pressure is set to 50Pa at factory shipment.

* 4 The value for Models 20-80 are that at the external static pressure of 100Pa, while the value for Models 100-125 are that at the external static pressure of 130Pa.

* 5 Be sure to apply the air filter near the air inlet grille, and make the air inlet ductwork length 850mm or more.

* 6 The figure in () indicates noise level at 240V/50Hz.

* 7 It is measured in anechoic room.

2. Capacity Tables

2-1.Cooling Capacity (In combination with PUMY)

CA:Capacity(kW)
SHC:Sensible Heat Capacity(kW)

PDFY-P-VM-A

Unit size	Outdoor air temp.	Indoor air temp.							
		23°CDB 16°CWB		25°CDB 18°CWB		28°CDB 20°CWB		30°CDB 22°CWB	
		°CDB	CA	SHC	CA	SHC	CA	SHC	CA
20 (2.2)	20.0	2.2	1.8	2.3	1.9	2.4	1.9	2.6	1.9
	22.5	2.1	1.8	2.3	1.9	2.4	1.9	2.6	1.9
	25.0	2.1	1.8	2.3	1.9	2.4	1.8	2.5	1.9
	27.5	2.1	1.8	2.2	1.9	2.4	1.8	2.5	1.9
	30.0	2.1	1.7	2.2	1.8	2.3	1.8	2.5	1.9
	32.5	2.0	1.7	2.2	1.8	2.3	1.8	2.5	1.9
	35.0	2.0	1.7	2.1	1.8	2.3	1.8	2.4	1.9
	37.5	2.0	1.7	2.1	1.8	2.2	1.8	2.4	1.9
	40.0	2.0	1.7	2.1	1.8	2.2	1.8	2.4	1.8
46.0	1.9	1.7	2.0	1.8	2.1	1.7	2.3	1.8	
25 (2.8)	20.0	2.8	2.1	2.9	2.2	3.1	2.2	3.3	2.2
	22.5	2.7	2.1	2.9	2.2	3.1	2.1	3.2	2.2
	25.0	2.7	2.1	2.9	2.1	3.1	2.1	3.2	2.2
	27.5	2.7	2.0	2.8	2.1	3.0	2.1	3.2	2.2
	30.0	2.6	2.0	2.8	2.1	3.0	2.1	3.2	2.2
	32.5	2.6	2.0	2.8	2.1	2.9	2.1	3.1	2.2
	35.0	2.6	2.0	2.7	2.1	2.9	2.1	3.1	2.1
	37.5	2.5	2.0	2.7	2.1	2.9	2.0	3.0	2.1
	40.0	2.5	1.9	2.7	2.1	2.8	2.0	3.0	2.1
46.0	2.4	1.9	2.6	2.0	2.7	2.0	2.9	2.1	
32 (3.6)	20.0	3.6	2.5	3.7	2.6	4.0	2.6	4.2	2.7
	22.5	3.5	2.5	3.7	2.6	4.0	2.6	4.2	2.7
	25.0	3.5	2.5	3.7	2.6	3.9	2.6	4.1	2.7
	27.5	3.4	2.5	3.6	2.6	3.9	2.6	4.1	2.6
	30.0	3.4	2.4	3.6	2.6	3.8	2.5	4.1	2.6
	32.5	3.3	2.4	3.6	2.5	3.8	2.5	4.0	2.6
	35.0	3.3	2.4	3.5	2.5	3.7	2.5	4.0	2.6
	37.5	3.2	2.4	3.5	2.5	3.7	2.5	3.9	2.6
	40.0	3.2	2.4	3.4	2.5	3.6	2.5	3.9	2.5
46.0	3.1	2.3	3.3	2.4	3.5	2.4	3.7	2.5	
40 (4.5)	20.0	4.5	3.3	4.7	3.4	5.0	3.4	5.3	3.5
	22.5	4.4	3.3	4.6	3.4	5.0	3.4	5.2	3.5
	25.0	4.3	3.2	4.6	3.4	4.9	3.4	5.2	3.5
	27.5	4.3	3.2	4.6	3.4	4.9	3.3	5.1	3.4
	30.0	4.2	3.2	4.5	3.3	4.8	3.3	5.1	3.4
	32.5	4.2	3.1	4.4	3.3	4.7	3.3	5.0	3.4
	35.0	4.1	3.1	4.4	3.3	4.7	3.2	5.0	3.4
	37.5	4.1	3.1	4.3	3.2	4.6	3.2	4.9	3.3
	40.0	4.0	3.1	4.3	3.2	4.5	3.2	4.8	3.3
46.0	3.8	3.0	4.1	3.2	4.3	3.1	4.6	3.2	
50 (5.6)	20.0	5.5	4.1	5.8	4.2	6.2	4.2	6.6	4.3
	22.5	5.5	4.0	5.8	4.2	6.2	4.2	6.5	4.3
	25.0	5.4	4.0	5.7	4.2	6.1	4.1	6.4	4.3
	27.5	5.3	4.0	5.7	4.1	6.0	4.1	6.4	4.2
	30.0	5.3	3.9	5.6	4.1	5.9	4.1	6.3	4.2
	32.5	5.2	3.9	5.5	4.1	5.9	4.0	6.2	4.2
	35.0	5.1	3.8	5.5	4.0	5.8	4.0	6.2	4.1
	37.5	5.0	3.8	5.4	4.0	5.7	4.0	6.1	4.1
	40.0	5.0	3.8	5.3	4.0	5.6	3.9	6.0	4.1
46.0	4.8	3.7	5.1	3.9	5.4	3.8	5.8	4.0	
63 (7.1)	20.0	7.0	5.1	7.4	5.3	7.9	5.3	8.3	5.4
	22.5	6.9	5.0	7.3	5.3	7.8	5.2	8.2	5.4
	25.0	6.9	5.0	7.3	5.2	7.7	5.2	8.2	5.3
	27.5	6.8	5.0	7.2	5.2	7.7	5.2	8.1	5.3
	30.0	6.7	4.9	7.1	5.2	7.5	5.1	8.0	5.3
	32.5	6.6	4.9	7.0	5.1	7.5	5.1	7.9	5.2
	35.0	6.5	4.8	6.9	5.1	7.3	5.0	7.8	5.2
	37.5	6.4	4.8	6.8	5.0	7.2	5.0	7.7	5.2
	40.0	6.3	4.7	6.7	5.0	7.2	4.9	7.6	5.1
46.0	6.1	4.6	6.5	4.9	6.9	4.8	7.3	5.0	

PDFY-P-VM-A

Cooling Capacity (In combination with PUMY)

CA:Capacity(kW)
SHC:Sensible Heat Capacity(kW)

PDFY-P-VM-A

Unit size	Outdoor air temp.	Indoor air temp.							
		23°CDB 16°CWB		25°CDB 18°CWB		28°CDB 20°CWB		30°CDB 22°CWB	
		°CDB	CA	SHC	CA	SHC	CA	SHC	CA
71 (8.0)	20.0	7.9	5.8	8.3	6.0	8.9	6.0	9.4	6.1
	22.5	7.8	5.7	8.2	5.9	8.8	5.9	9.3	6.1
	25.0	7.7	5.7	8.2	5.9	8.7	5.9	9.2	6.0
	27.5	7.6	5.6	8.1	5.9	8.6	5.8	9.1	6.0
	30.0	7.5	5.6	8.0	5.8	8.5	5.8	9.0	6.0
	32.5	7.4	5.5	7.9	5.8	8.4	5.7	8.9	5.9
	35.0	7.3	5.4	7.8	5.7	8.3	5.7	8.8	5.9
	37.5	7.2	5.4	7.7	5.7	8.2	5.6	8.7	5.8
	40.0	7.1	5.4	7.6	5.6	8.1	5.6	8.6	5.8
46.0	6.8	5.2	7.3	5.5	7.7	5.4	8.2	5.6	
80 (9.0)	20.0	8.9	6.3	9.4	6.6	10.0	6.5	10.6	6.7
	22.5	8.8	6.2	9.3	6.5	9.9	6.5	10.4	6.6
	25.0	8.7	6.2	9.2	6.5	9.8	6.4	10.4	6.6
	27.5	8.6	6.1	9.1	6.4	9.7	6.4	10.3	6.6
	30.0	8.5	6.1	9.0	6.4	9.5	6.3	10.2	6.5
	32.5	8.3	6.0	8.9	6.3	9.5	6.3	10.0	6.5
	35.0	8.2	5.9	8.8	6.3	9.3	6.2	9.9	6.4
	37.5	8.1	5.9	8.6	6.2	9.2	6.1	9.8	6.4
	40.0	8.0	5.8	8.6	6.1	9.1	6.1	9.6	6.3
46.0	7.7	5.7	8.2	6.0	8.7	5.9	9.3	6.1	
100 (11.2)	20.0	11.1	7.9	11.6	8.2	12.5	8.2	13.1	8.4
	22.5	10.9	7.8	11.5	8.2	12.3	8.1	13.0	8.3
	25.0	10.8	7.8	11.5	8.1	12.2	8.1	12.9	8.3
	27.5	10.7	7.7	11.3	8.1	12.1	8.0	12.8	8.2
	30.0	10.5	7.6	11.2	8.0	11.9	7.9	12.6	8.2
	32.5	10.4	7.5	11.1	7.9	11.8	7.9	12.5	8.1
	35.0	10.2	7.5	10.9	7.9	11.6	7.8	12.3	8.0
	37.5	10.1	7.4	10.8	7.8	11.4	7.7	12.2	8.0
	40.0	10.0	7.3	10.6	7.7	11.3	7.7	12.0	7.9
46.0	9.6	7.1	10.2	7.5	10.8	7.4	11.5	7.7	
125 (14.0)	20.0	13.9	10.0	14.6	10.4	15.6	10.4	16.4	10.7
	22.5	13.7	9.9	14.4	10.4	15.4	10.3	16.2	10.6
	25.0	13.5	9.8	14.3	10.3	15.3	10.2	16.1	10.5
	27.5	13.4	9.8	14.2	10.2	15.1	10.2	16.0	10.5
	30.0	13.2	9.7	14.0	10.1	14.9	10.0	15.8	10.4
	32.5	13.0	9.6	13.8	10.1	14.7	10.0	15.6	10.3
	35.0	12.8	9.5	13.7	10.0	14.5	9.9	15.4	10.2
	37.5	12.6	9.4	13.4	9.9	14.3	9.8	15.2	10.1
	40.0	12.5	9.3	13.3	9.8	14.1	9.7	15.0	10.0
46.0	12.0	9.1	12.8	9.6	13.5	9.4	14.4	9.8	

PDFY-P-VM-A

2-2.Heating Capacity (In combination with PUMY)

PDFY-P-VM-A

Unit size	Outdoor air temp. °CWB	Indoor air temp.:°CDB		
		15.0	20.0	25.0
		SHC	SHC	SHC
20	-12.0	1.6	1.6	1.5
	-10.0	1.7	1.6	1.6
	-5.0	1.9	1.9	1.9
	0.0	2.2	2.1	2.1
	2.5	2.3	2.3	2.3
	6.0	2.5	2.5	2.5
	7.5	2.6	2.6	2.5
	10.0	2.8	2.7	2.5
	12.5	2.9	2.8	2.5
15.5	3.1	2.8	2.5	
25	-12.0	2.0	2.0	2.0
	-10.0	2.1	2.1	2.1
	-5.0	2.4	2.4	2.4
	0.0	2.8	2.8	2.7
	2.5	3.0	2.9	2.9
	6.0	3.2	3.2	3.2
	7.5	3.3	3.3	3.2
	10.0	3.5	3.5	3.2
	12.5	3.7	3.5	3.2
15.5	3.9	3.5	3.2	
32	-12.0	2.5	2.5	2.5
	-10.0	2.7	2.6	2.6
	-5.0	3.1	3.0	3.0
	0.0	3.5	3.4	3.4
	2.5	3.7	3.7	3.6
	6.0	4.0	4.0	3.9
	7.5	4.2	4.1	4.0
	10.0	4.4	4.4	4.0
	12.5	4.7	4.4	4.0
15.5	4.9	4.4	4.0	
40	-12.0	3.2	3.1	3.1
	-10.0	3.4	3.3	3.2
	-5.0	3.8	3.8	3.7
	0.0	4.3	4.3	4.2
	2.5	4.6	4.6	4.5
	6.0	5.0	5.0	4.9
	7.5	5.2	5.2	5.0
	10.0	5.5	5.5	5.0
	12.5	5.9	5.5	5.0
15.5	6.2	5.5	5.0	
50	-12.0	4.0	3.9	3.9
	-10.0	4.2	4.2	4.1
	-5.0	4.8	4.8	4.7
	0.0	5.5	5.4	5.3
	2.5	5.8	5.8	5.7
	6.0	6.3	6.3	6.2
	7.5	6.6	6.5	6.2
	10.0	7.0	6.9	6.2
	12.5	7.4	7.0	6.2
15.5	7.7	7.0	6.2	

SHC:Sensible Heat Capacity(kW)

Unit size	Outdoor air temp. °CWB	Indoor air temp.:°CDB		
		15.0	20.0	25.0
		SHC	SHC	SHC
63	-12.0	5.1	5.0	4.9
	-10.0	5.4	5.3	5.2
	-5.0	6.1	6.0	5.9
	0.0	6.9	6.9	6.8
	2.5	7.4	7.3	7.2
	6.0	8.0	8.0	7.9
	7.5	8.3	8.3	7.9
	10.0	8.8	8.8	7.9
	12.5	9.4	8.8	7.9
15.5	9.8	8.8	7.9	
71	-12.0	5.7	5.6	5.5
	-10.0	6.0	5.9	5.8
	-5.0	6.9	6.8	6.7
	0.0	7.8	7.7	7.6
	2.5	8.3	8.2	8.1
	6.0	9.1	9.0	8.9
	7.5	9.4	9.3	8.9
	10.0	9.9	9.9	8.9
	12.5	10.5	9.9	8.9
15.5	11.1	9.9	8.9	
80	-12.0	6.4	6.2	6.1
	-10.0	6.7	6.6	6.5
	-5.0	7.6	7.5	7.4
	0.0	8.7	8.6	8.5
	2.5	9.2	9.2	9.0
	6.0	10.1	10.0	9.9
	7.5	10.4	10.4	9.9
	10.0	11.1	11.0	9.9
	12.5	11.7	11.0	9.9
15.5	12.3	11.0	9.9	
100	-12.0	8.0	7.8	7.7
	-10.0	8.4	8.2	8.1
	-5.0	9.6	9.4	9.3
	0.0	10.9	10.7	10.6
	2.5	11.5	11.4	11.3
	6.0	12.6	12.5	12.3
	7.5	13.0	12.9	12.4
	10.0	13.8	13.7	12.4
	12.5	14.6	13.8	12.4
15.5	15.4	13.8	12.4	
125	-12.0	10.2	10.0	9.8
	-10.0	10.7	10.6	10.4
	-5.0	12.2	12.1	11.9
	0.0	13.9	13.8	13.6
	2.5	14.8	14.7	14.5
	6.0	16.1	16.0	15.8
	7.5	16.7	16.6	15.8
	10.0	17.7	17.6	15.8
	12.5	18.7	17.7	15.8
15.5	19.7	17.7	15.8	

2-3.Cooling Capacity (In combination with PU(H)Y, PURY-(P)200-250-315YEM-A, TEM-A)

CA:Capacity(kW)
SHC:Sensible Heat Capacity(kW)

PDFY-P-VM-A

Unit size	Outdoor air temp.	Indoor air temp.													
		21.5°CDB 15°CWB		23°CDB 16°CWB		25°CDB 18°CWB		27°CDB 19°CWB		28°CDB 20°CWB		30°CDB 22°CWB		32°CDB 24°CWB	
		°CDB	CA	SHC	CA	SHC	CA	SHC	CA	SHC	CA	SHC	CA	SHC	CA
20 (2.2)	20.0	2.2	1.8	2.2	1.8	2.3	1.8	2.3	1.8	2.4	1.9	2.5	1.9	2.6	1.8
	22.5	2.1	1.8	2.2	1.8	2.3	1.8	2.3	1.8	2.4	1.9	2.4	1.8	2.5	1.8
	25.0	2.1	1.8	2.2	1.8	2.2	1.8	2.3	1.8	2.3	1.9	2.4	1.8	2.5	1.8
	27.5	2.1	1.8	2.1	1.8	2.2	1.8	2.3	1.8	2.3	1.9	2.4	1.8	2.5	1.8
	30.0	2.1	1.7	2.1	1.8	2.2	1.8	2.2	1.8	2.3	1.9	2.4	1.8	2.5	1.8
	32.5	2.0	1.7	2.1	1.8	2.2	1.8	2.2	1.8	2.3	1.9	2.4	1.8	2.4	1.8
	35.0	2.0	1.7	2.1	1.8	2.2	1.7	2.2	1.8	2.2	1.8	2.3	1.8	2.4	1.8
	37.5	2.0	1.7	2.0	1.8	2.1	1.7	2.2	1.8	2.2	1.8	2.3	1.8	2.4	1.8
	40.0	2.0	1.7	2.0	1.8	2.1	1.7	2.2	1.8	2.2	1.8	2.3	1.8	2.4	1.8
43.0	2.0	1.7	2.0	1.8	2.1	1.7	2.1	1.8	2.2	1.8	2.3	1.8	2.3	1.7	
25 (2.8)	20.0	2.7	2.1	2.8	2.1	2.9	2.1	3.0	2.1	3.0	2.2	3.1	2.1	3.2	2.0
	22.5	2.7	2.1	2.8	2.1	2.9	2.1	2.9	2.1	3.0	2.1	3.1	2.1	3.2	2.0
	25.0	2.7	2.0	2.7	2.1	2.9	2.0	2.9	2.1	3.0	2.1	3.1	2.1	3.2	2.0
	27.5	2.7	2.0	2.7	2.1	2.8	2.0	2.9	2.1	2.9	2.1	3.1	2.1	3.2	2.0
	30.0	2.6	2.0	2.7	2.1	2.8	2.0	2.9	2.0	2.9	2.1	3.0	2.1	3.1	2.0
	32.5	2.6	2.0	2.7	2.1	2.8	2.0	2.8	2.0	2.9	2.1	3.0	2.0	3.1	2.0
	35.0	2.6	2.0	2.6	2.0	2.7	2.0	2.8	2.0	2.9	2.1	3.0	2.0	3.1	2.0
	37.5	2.5	2.0	2.6	2.0	2.7	2.0	2.8	2.0	2.8	2.1	2.9	2.0	3.1	2.0
	40.0	2.5	2.0	2.6	2.0	2.7	2.0	2.7	2.0	2.8	2.1	2.9	2.0	3.0	2.0
43.0	2.5	1.9	2.5	2.0	2.7	2.0	2.7	2.0	2.8	2.1	2.9	2.0	3.0	2.0	
32 (3.6)	20.0	3.5	2.5	3.6	2.6	3.7	2.5	3.8	2.5	3.9	2.6	4.0	2.5	4.2	2.4
	22.5	3.5	2.5	3.6	2.5	3.7	2.5	3.8	2.5	3.9	2.6	4.0	2.5	4.1	2.4
	25.0	3.5	2.5	3.5	2.5	3.7	2.5	3.7	2.5	3.8	2.6	4.0	2.5	4.1	2.4
	27.5	3.4	2.5	3.5	2.5	3.6	2.5	3.7	2.5	3.8	2.5	3.9	2.5	4.1	2.4
	30.0	3.4	2.4	3.5	2.5	3.6	2.4	3.7	2.5	3.7	2.5	3.9	2.5	4.0	2.4
	32.5	3.3	2.4	3.4	2.5	3.6	2.4	3.6	2.4	3.7	2.5	3.9	2.4	4.0	2.4
	35.0	3.3	2.4	3.4	2.5	3.5	2.4	3.6	2.4	3.7	2.5	3.8	2.4	4.0	2.4
	37.5	3.3	2.4	3.3	2.4	3.5	2.4	3.6	2.4	3.6	2.5	3.8	2.4	3.9	2.4
	40.0	3.2	2.4	3.3	2.4	3.5	2.4	3.5	2.4	3.6	2.5	3.7	2.4	3.9	2.3
43.0	3.2	2.4	3.3	2.4	3.4	2.4	3.5	2.4	3.6	2.4	3.7	2.4	3.8	2.3	
40 (4.5)	20.0	4.4	3.3	4.5	3.3	4.7	3.3	4.8	3.3	4.9	3.4	5.0	3.3	5.2	3.2
	22.5	4.4	3.2	4.5	3.3	4.6	3.2	4.7	3.3	4.8	3.4	5.0	3.3	5.2	3.2
	25.0	4.3	3.2	4.4	3.3	4.6	3.2	4.7	3.2	4.8	3.3	5.0	3.3	5.1	3.2
	27.5	4.3	3.2	4.4	3.3	4.5	3.2	4.6	3.2	4.7	3.3	4.9	3.2	5.1	3.2
	30.0	4.2	3.2	4.3	3.2	4.5	3.2	4.6	3.2	4.7	3.3	4.9	3.2	5.0	3.1
	32.5	4.2	3.2	4.3	3.2	4.5	3.2	4.5	3.2	4.6	3.3	4.8	3.2	5.0	3.1
	35.0	4.1	3.1	4.2	3.2	4.4	3.1	4.5	3.2	4.6	3.3	4.8	3.2	5.0	3.1
	37.5	4.1	3.1	4.2	3.2	4.4	3.1	4.5	3.2	4.5	3.3	4.7	3.2	4.9	3.1
	40.0	4.1	3.1	4.1	3.2	4.3	3.1	4.4	3.1	4.5	3.2	4.7	3.2	4.9	3.1
43.0	4.0	3.1	4.1	3.1	4.3	3.1	4.4	3.1	4.4	3.2	4.6	3.1	4.8	3.1	
50 (5.6)	20.0	5.5	4.0	5.6	4.1	5.8	4.0	5.9	4.0	6.0	4.2	6.3	4.1	6.5	3.9
	22.5	5.4	4.0	5.5	4.1	5.8	4.0	5.9	4.0	6.0	4.1	6.2	4.0	6.4	3.9
	25.0	5.4	4.0	5.5	4.1	5.7	4.0	5.8	4.0	5.9	4.1	6.2	4.0	6.4	3.9
	27.5	5.3	3.9	5.4	4.0	5.7	3.9	5.8	4.0	5.9	4.1	6.1	4.0	6.3	3.9
	30.0	5.3	3.9	5.4	4.0	5.6	3.9	5.7	4.0	5.8	4.1	6.0	4.0	6.3	3.9
	32.5	5.2	3.9	5.3	4.0	5.5	3.9	5.7	3.9	5.8	4.1	6.0	4.0	6.2	3.8
	35.0	5.2	3.9	5.3	4.0	5.5	3.9	5.6	3.9	5.7	4.0	5.9	3.9	6.2	3.8
	37.5	5.1	3.8	5.2	3.9	5.4	3.8	5.5	3.9	5.7	4.0	5.9	3.9	6.1	3.8
	40.0	5.0	3.8	5.2	3.9	5.4	3.8	5.5	3.9	5.6	4.0	5.8	3.9	6.0	3.8
43.0	5.0	3.8	5.1	3.9	5.3	3.8	5.4	3.8	5.5	4.0	5.8	3.9	6.0	3.8	
63 (7.1)	20.0	7.0	5.1	7.1	5.2	7.4	5.0	7.5	5.1	7.7	5.2	8.0	5.1	8.2	4.9
	22.5	6.9	5.0	7.0	5.1	7.3	5.0	7.5	5.0	7.6	5.2	7.9	5.1	8.2	4.9
	25.0	6.8	5.0	7.0	5.1	7.2	5.0	7.4	5.0	7.5	5.2	7.8	5.0	8.1	4.9
	27.5	6.7	4.9	6.9	5.1	7.2	4.9	7.3	5.0	7.5	5.1	7.7	5.0	8.0	4.9
	30.0	6.7	4.9	6.8	5.0	7.1	4.9	7.2	4.9	7.4	5.1	7.7	5.0	8.0	4.8
	32.5	6.6	4.9	6.7	5.0	7.0	4.9	7.2	4.9	7.3	5.1	7.6	4.9	7.9	4.8
	35.0	6.5	4.8	6.7	4.9	7.0	4.8	7.1	4.9	7.2	5.0	7.5	4.9	7.8	4.8
	37.5	6.5	4.8	6.6	4.9	6.9	4.8	7.0	4.9	7.2	5.0	7.5	4.9	7.7	4.8
	40.0	6.4	4.8	6.5	4.9	6.8	4.8	7.0	4.8	7.1	5.0	7.4	4.9	7.7	4.7
43.0	6.3	4.7	6.4	4.8	6.7	4.7	6.9	4.8	7.0	4.9	7.3	4.8	7.6	4.7	

PDFY-P-VM-A

Cooling Capacity (In combination with PU(H)Y, PURY-(P)200-250-315YEM-A, TEM-A)

CA:Capacity(kW)
SHC:Sensible Heat Capacity(kW)

PDFY-P-VM-A

Unit size	Outdoor air temp.	Indoor air temp.													
		21.5°CDB 15°CWB		23°CDB 16°CWB		25°CDB 18°CWB		27°CDB 19°CWB		28°CDB 20°CWB		30°CDB 22°CWB		32°CDB 24°CWB	
		°CDB	CA	SHC	CA	SHC	CA	SHC	CA	SHC	CA	SHC	CA	SHC	CA
71 (8.0)	20.0	7.8	5.7	8.0	5.8	8.3	5.7	8.5	5.7	8.6	5.9	9.0	5.7	9.3	5.6
	22.5	7.8	5.7	7.9	5.8	8.2	5.7	8.4	5.7	8.6	5.9	8.9	5.7	9.2	5.5
	25.0	7.7	5.6	7.8	5.8	8.2	5.6	8.3	5.7	8.5	5.8	8.8	5.7	9.1	5.5
	27.5	7.6	5.6	7.8	5.7	8.1	5.6	8.2	5.6	8.4	5.8	8.7	5.7	9.0	5.5
	30.0	7.5	5.6	7.7	5.7	8.0	5.5	8.2	5.6	8.3	5.8	8.6	5.6	9.0	5.5
	32.5	7.4	5.5	7.6	5.6	7.9	5.5	8.1	5.6	8.2	5.7	8.6	5.6	8.9	5.4
	35.0	7.4	5.5	7.5	5.6	7.8	5.5	8.0	5.5	8.2	5.7	8.5	5.6	8.8	5.4
	37.5	7.3	5.4	7.4	5.6	7.8	5.4	7.9	5.5	8.1	5.7	8.4	5.5	8.7	5.4
	40.0	7.2	5.4	7.4	5.5	7.7	5.4	7.8	5.5	8.0	5.6	8.3	5.5	8.6	5.4
43.0	7.1	5.3	7.3	5.5	7.6	5.4	7.7	5.4	7.9	5.6	8.2	5.5	8.5	5.3	
80 (9.0)	20.0	8.8	6.3	9.0	6.4	9.4	6.2	9.5	6.2	9.7	6.4	10.1	6.2	10.4	6.1
	22.5	8.7	6.2	8.9	6.3	9.3	6.2	9.5	6.2	9.6	6.4	10.0	6.2	10.4	6.0
	25.0	8.6	6.2	8.8	6.3	9.2	6.1	9.4	6.2	9.5	6.3	9.9	6.2	10.3	6.0
	27.5	8.6	6.1	8.7	6.2	9.1	6.1	9.3	6.1	9.5	6.3	9.8	6.1	10.2	6.0
	30.0	8.5	6.1	8.6	6.2	9.0	6.1	9.2	6.1	9.4	6.3	9.7	6.1	10.1	5.9
	32.5	8.4	6.0	8.6	6.1	8.9	6.0	9.1	6.0	9.3	6.2	9.6	6.1	10.0	5.9
	35.0	8.3	6.0	8.5	6.1	8.8	6.0	9.0	6.0	9.2	6.2	9.5	6.0	9.9	5.9
	37.5	8.2	5.9	8.4	6.1	8.7	5.9	8.9	6.0	9.1	6.2	9.5	6.0	9.8	5.8
	40.0	8.1	5.9	8.3	6.0	8.6	5.9	8.8	5.9	9.0	6.1	9.4	6.0	9.7	5.8
43.0	8.0	5.8	8.2	6.0	8.5	5.8	8.7	5.9	8.9	6.1	9.3	5.9	9.6	5.8	
100 (11.2)	20.0	11.0	7.9	11.2	8.0	11.6	7.8	11.9	7.8	12.1	8.1	12.5	7.9	13.0	7.6
	22.5	10.9	7.8	11.1	8.0	11.5	7.8	11.8	7.8	12.0	8.0	12.4	7.8	12.9	7.6
	25.0	10.8	7.7	11.0	7.9	11.4	7.7	11.6	7.8	11.9	8.0	12.3	7.8	12.8	7.5
	27.5	10.6	7.7	10.9	7.8	11.3	7.7	11.5	7.7	11.8	7.9	12.2	7.7	12.7	7.5
	30.0	10.5	7.6	10.8	7.8	11.2	7.6	11.4	7.7	11.6	7.9	12.1	7.7	12.5	7.5
	32.5	10.4	7.6	10.6	7.7	11.1	7.6	11.3	7.6	11.5	7.8	12.0	7.6	12.4	7.4
	35.0	10.3	7.5	10.5	7.7	11.0	7.5	11.2	7.6	11.4	7.8	11.9	7.6	12.3	7.4
	37.5	10.2	7.5	10.4	7.6	10.9	7.5	11.1	7.5	11.3	7.7	11.8	7.5	12.2	7.3
	40.0	10.1	7.4	10.3	7.6	10.8	7.4	11.0	7.5	11.2	7.7	11.6	7.5	12.1	7.3
43.0	9.9	7.3	10.2	7.5	10.6	7.3	10.8	7.4	11.1	7.6	11.5	7.5	12.0	7.3	
125 (14.0)	20.0	13.7	9.9	14.0	10.1	14.6	9.9	14.8	10.0	15.1	10.3	15.7	10.0	16.2	9.7
	22.5	13.6	9.9	13.9	10.1	14.4	9.8	14.7	9.9	15.0	10.2	15.5	9.9	16.1	9.6
	25.0	13.4	9.8	13.7	10.0	14.3	9.8	14.6	9.8	14.8	10.1	15.4	9.9	16.0	9.6
	27.5	13.3	9.7	13.6	9.9	14.1	9.7	14.4	9.8	14.7	10.1	15.3	9.8	15.8	9.5
	30.0	13.2	9.7	13.4	9.9	14.0	9.7	14.3	9.7	14.6	10.0	15.1	9.8	15.7	9.5
	32.5	13.0	9.6	13.3	9.8	13.9	9.6	14.1	9.7	14.4	10.0	15.0	9.7	15.5	9.4
	35.0	12.9	9.5	13.2	9.7	13.7	9.5	14.0	9.6	14.3	9.9	14.8	9.7	15.4	9.4
	37.5	12.7	9.5	13.0	9.7	13.6	9.5	13.9	9.5	14.1	9.9	14.7	9.6	15.3	9.4
	40.0	12.6	9.4	12.9	9.6	13.4	9.4	13.7	9.5	14.0	9.8	14.6	9.6	15.1	9.3
43.0	12.4	9.3	12.7	9.5	13.3	9.3	13.6	9.4	13.8	9.7	14.4	9.5	15.0	9.2	

PDFY-P-VM-A

2-4.Heating Capacity (In combination with PU(H)Y, PURY-(P)200-250-315YEM-A, TEM-A)

PDFY-P-VM-A

Unit size	Outdoor air temp. °CWB	Indoor air temp.:°CDB			
		15.0	20.0	25.0	27.0
		SHC	SHC	SHC	SHC
20	-15.0	1.7	1.6	1.6	1.6
	-10.0	1.9	1.9	1.9	1.7
	-5.0	2.1	2.1	2.0	1.7
	0.0	2.4	2.4	2.0	1.7
	2.5	2.5	2.5	2.0	1.7
	6.0	2.5	2.5	2.0	1.7
	7.5	2.6	2.5	2.0	1.7
	10.0	2.8	2.5	2.0	1.7
	12.5	3.0	2.5	2.0	1.7
	15.5	3.0	2.5	2.0	1.7
25	-15.0	2.1	2.1	2.1	2.1
	-10.0	2.4	2.4	2.4	2.2
	-5.0	2.7	2.7	2.5	2.2
	0.0	3.1	3.0	2.5	2.2
	2.5	3.2	3.2	2.5	2.2
	6.0	3.2	3.2	2.5	2.2
	7.5	3.4	3.2	2.5	2.2
	10.0	3.6	3.2	2.5	2.2
	12.5	3.8	3.2	2.5	2.2
	15.5	3.9	3.2	2.5	2.2
32	-15.0	2.7	2.6	2.6	2.6
	-10.0	3.1	3.0	3.0	2.8
	-5.0	3.4	3.4	3.1	2.8
	0.0	3.8	3.8	3.1	2.8
	2.5	4.0	4.0	3.1	2.8
	6.0	4.0	4.0	3.1	2.8
	7.5	4.2	4.0	3.1	2.8
	10.0	4.5	4.0	3.1	2.8
	12.5	4.8	4.0	3.1	2.8
	15.5	4.8	4.0	3.1	2.8
40	-15.0	3.3	3.3	3.3	3.3
	-10.0	3.8	3.8	3.7	3.5
	-5.0	4.3	4.2	3.9	3.5
	0.0	4.8	4.7	3.9	3.5
	2.5	5.0	5.0	3.9	3.5
	6.0	5.1	5.0	3.9	3.5
	7.5	5.3	5.0	3.9	3.5
	10.0	5.6	5.0	3.9	3.5
	12.5	6.0	5.0	3.9	3.5
	15.5	6.1	5.0	3.9	3.5
50	-15.0	4.2	4.2	4.1	4.1
	-10.0	4.8	4.8	4.7	4.3
	-5.0	5.4	5.3	4.9	4.3
	0.0	6.0	5.9	4.9	4.3
	2.5	6.3	6.2	4.9	4.3
	6.0	6.4	6.3	4.9	4.3
	7.5	6.6	6.3	4.9	4.3
	10.0	7.1	6.3	4.9	4.3
	12.5	7.5	6.3	4.9	4.3
	15.5	7.6	6.3	4.9	4.3

SHC:Sensible Heat Capacity(kW)

Unit size	Outdoor air temp. °CWB	Indoor air temp.:°CDB			
		15.0	20.0	25.0	27.0
		SHC	SHC	SHC	SHC
63	-15.0	5.4	5.3	5.2	5.2
	-10.0	6.1	6.0	6.0	5.5
	-5.0	6.9	6.8	6.2	5.5
	0.0	7.6	7.5	6.2	5.5
	2.5	8.0	7.9	6.2	5.5
	6.0	8.1	8.0	6.2	5.5
	7.5	8.4	8.0	6.2	5.5
	10.0	9.0	8.0	6.2	5.5
	12.5	9.6	8.0	6.2	5.5
	15.5	9.7	8.0	6.2	5.5
71	-15.0	6.0	5.9	5.9	5.9
	-10.0	6.9	6.8	6.7	6.2
	-5.0	7.7	7.6	7.0	6.2
	0.0	8.6	8.5	7.0	6.2
	2.5	9.0	8.9	7.0	6.2
	6.0	9.1	9.0	7.0	6.2
	7.5	9.5	9.0	7.0	6.2
	10.0	10.1	9.0	7.0	6.2
	12.5	10.8	9.0	7.0	6.2
	15.5	10.9	9.0	7.0	6.2
80	-15.0	6.7	6.6	6.5	6.5
	-10.0	7.6	7.5	7.4	6.9
	-5.0	8.6	8.5	7.8	6.9
	0.0	9.5	9.4	7.8	6.9
	2.5	10.0	9.9	7.8	6.9
	6.0	10.1	10.0	7.8	6.9
	7.5	10.5	10.0	7.8	6.9
	10.0	11.2	10.0	7.8	6.9
	12.5	12.0	10.0	7.8	6.9
	15.5	12.1	10.0	7.8	6.9
100	-15.0	8.4	8.2	8.2	8.1
	-10.0	9.6	9.4	9.3	8.6
	-5.0	10.7	10.6	9.8	8.6
	0.0	11.9	11.8	9.8	8.6
	2.5	12.5	12.4	9.8	8.6
	6.0	12.6	12.5	9.8	8.6
	7.5	13.2	12.5	9.8	8.6
	10.0	14.1	12.5	9.8	8.6
	12.5	15.0	12.5	9.8	8.6
	15.5	15.1	12.5	9.8	8.6
125	-15.0	10.7	10.6	10.5	10.4
	-10.0	12.2	12.1	11.9	11.0
	-5.0	13.7	13.6	12.5	11.0
	0.0	15.3	15.1	12.5	11.0
	2.5	16.0	15.8	12.5	11.0
	6.0	16.2	16.0	12.5	11.0
	7.5	16.8	16.0	12.5	11.0
	10.0	18.0	16.0	12.5	11.0
	12.5	19.1	16.0	12.5	11.0
	15.5	19.4	16.0	12.5	11.0

PDFY-P-VM-A

2-5.Cooling Capacity (In combination with Big Y, Super Y, Big R2)

PDFY-P-VM-A

CA:Capacity(kW)
SHC:Sensible Heat Capacity(kW)

Unit size	Outdoor air temp.	Indoor air temp.											
		21.5°CDB 15°CWB		23°CDB 16°CWB		25°CDB 18°CWB		28°CDB 20°CWB		30°CDB 22°CWB		32°CDB 24°CWB	
		°CDB	CA	SHC	CA	SHC	CA	SHC	CA	SHC	CA	SHC	CA
20	20.0	2.0	1.7	2.1	1.8	2.3	1.8	2.4	1.9	2.6	1.9	2.7	1.9
	22.5	2.0	1.7	2.1	1.8	2.3	1.8	2.4	1.9	2.6	1.9	2.7	1.9
	25.0	2.0	1.7	2.1	1.8	2.2	1.8	2.4	1.9	2.5	1.9	2.7	1.8
	27.5	2.0	1.7	2.1	1.8	2.2	1.8	2.4	1.9	2.5	1.9	2.6	1.8
	30.0	2.0	1.7	2.1	1.8	2.2	1.8	2.3	1.9	2.5	1.9	2.6	1.8
	32.5	2.0	1.7	2.0	1.8	2.2	1.8	2.3	1.9	2.4	1.8	2.6	1.8
	35.0	1.9	1.7	2.0	1.8	2.1	1.7	2.3	1.9	2.4	1.8	2.5	1.8
	37.5	1.9	1.7	2.0	1.8	2.1	1.7	2.2	1.8	2.4	1.8	2.5	1.8
	40.0	1.9	1.7	2.0	1.7	2.1	1.7	2.2	1.8	2.3	1.8	2.4	1.8
43.0	1.9	1.7	1.9	1.7	2.1	1.7	2.2	1.8	2.3	1.8	2.4	1.8	
25	20.0	2.6	2.0	2.7	2.1	2.9	2.1	3.1	2.2	3.3	2.2	3.5	2.1
	22.5	2.6	2.0	2.7	2.1	2.9	2.1	3.1	2.2	3.3	2.1	3.4	2.1
	25.0	2.6	2.0	2.7	2.1	2.9	2.0	3.0	2.2	3.2	2.1	3.4	2.1
	27.5	2.5	2.0	2.6	2.0	2.8	2.0	3.0	2.1	3.2	2.1	3.3	2.1
	30.0	2.5	2.0	2.6	2.0	2.8	2.0	3.0	2.1	3.1	2.1	3.3	2.1
	32.5	2.5	2.0	2.6	2.0	2.8	2.0	2.9	2.1	3.1	2.1	3.2	2.0
	35.0	2.5	1.9	2.6	2.0	2.7	2.0	2.9	2.1	3.0	2.1	3.2	2.0
	37.5	2.5	1.9	2.5	2.0	2.7	2.0	2.8	2.1	3.0	2.0	3.1	2.0
	40.0	2.4	1.9	2.5	2.0	2.7	2.0	2.8	2.1	3.0	2.0	3.1	2.0
43.0	2.4	1.9	2.5	2.0	2.6	1.9	2.8	2.1	2.9	2.0	3.0	2.0	
32	20.0	3.3	2.4	3.5	2.5	3.7	2.5	4.0	2.6	4.2	2.6	4.5	2.6
	22.5	3.3	2.4	3.5	2.5	3.7	2.5	4.0	2.6	4.2	2.6	4.4	2.5
	25.0	3.3	2.4	3.4	2.5	3.7	2.5	3.9	2.6	4.1	2.6	4.4	2.5
	27.5	3.3	2.4	3.4	2.5	3.6	2.5	3.9	2.6	4.1	2.5	4.3	2.5
	30.0	3.2	2.4	3.4	2.5	3.6	2.4	3.8	2.6	4.0	2.5	4.2	2.5
	32.5	3.2	2.4	3.3	2.4	3.5	2.4	3.8	2.5	4.0	2.5	4.2	2.4
	35.0	3.2	2.3	3.3	2.4	3.5	2.4	3.7	2.5	3.9	2.5	4.1	2.4
	37.5	3.2	2.3	3.3	2.4	3.5	2.4	3.7	2.5	3.8	2.4	4.0	2.4
	40.0	3.1	2.3	3.2	2.4	3.4	2.4	3.6	2.5	3.8	2.4	4.0	2.4
43.0	3.1	2.3	3.2	2.4	3.4	2.3	3.5	2.4	3.7	2.4	3.9	2.3	
40	20.0	4.1	3.1	4.3	3.3	4.7	3.3	5.0	3.4	5.3	3.4	5.6	3.3
	22.5	4.1	3.1	4.3	3.3	4.6	3.2	4.9	3.4	5.2	3.4	5.5	3.3
	25.0	4.1	3.1	4.3	3.2	4.6	3.2	4.9	3.4	5.2	3.3	5.5	3.3
	27.5	4.1	3.1	4.2	3.2	4.5	3.2	4.8	3.4	5.1	3.3	5.4	3.3
	30.0	4.0	3.1	4.2	3.2	4.5	3.2	4.8	3.3	5.0	3.3	5.3	3.2
	32.5	4.0	3.1	4.2	3.2	4.4	3.1	4.7	3.3	5.0	3.3	5.2	3.2
	35.0	4.0	3.1	4.1	3.2	4.4	3.1	4.6	3.3	4.9	3.2	5.1	3.2
	37.5	3.9	3.0	4.1	3.1	4.3	3.1	4.6	3.3	4.8	3.2	5.1	3.1
	40.0	3.9	3.0	4.0	3.1	4.3	3.1	4.5	3.2	4.7	3.2	5.0	3.1
43.0	3.9	3.0	4.0	3.1	4.2	3.1	4.4	3.2	4.7	3.2	4.9	3.1	
50	20.0	5.2	3.9	5.4	4.0	5.8	4.0	6.2	4.3	6.6	4.2	7.0	4.1
	22.5	5.2	3.9	5.4	4.0	5.8	4.0	6.2	4.2	6.5	4.2	6.9	4.1
	25.0	5.1	3.8	5.3	4.0	5.7	4.0	6.1	4.2	6.4	4.1	6.8	4.1
	27.5	5.1	3.8	5.3	4.0	5.6	3.9	6.0	4.2	6.3	4.1	6.7	4.0
	30.0	5.0	3.8	5.2	3.9	5.6	3.9	5.9	4.1	6.2	4.1	6.6	4.0
	32.5	5.0	3.8	5.2	3.9	5.5	3.9	5.8	4.1	6.2	4.0	6.5	3.9
	35.0	4.9	3.8	5.1	3.9	5.4	3.9	5.8	4.1	6.1	4.0	6.4	3.9
	37.5	4.9	3.7	5.1	3.9	5.4	3.8	5.7	4.0	6.0	4.0	6.3	3.9
	40.0	4.9	3.7	5.0	3.8	5.3	3.8	5.6	4.0	5.9	3.9	6.2	3.8
43.0	4.8	3.7	5.0	3.8	5.2	3.8	5.5	4.0	5.8	3.9	6.1	3.8	
63	20.0	6.5	4.8	6.9	5.0	7.4	5.0	7.9	5.3	8.4	5.2	8.9	5.2
	22.5	6.5	4.8	6.8	5.0	7.3	5.0	7.8	5.3	8.3	5.2	8.7	5.1
	25.0	6.5	4.8	6.8	5.0	7.2	5.0	7.7	5.2	8.1	5.2	8.6	5.1
	27.5	6.4	4.8	6.7	5.0	7.2	4.9	7.6	5.2	8.0	5.1	8.5	5.0
	30.0	6.4	4.8	6.6	4.9	7.1	4.9	7.5	5.2	7.9	5.1	8.4	5.0
	32.5	6.3	4.7	6.6	4.9	7.0	4.9	7.4	5.1	7.8	5.0	8.2	4.9
	35.0	6.3	4.7	6.5	4.9	6.9	4.8	7.3	5.1	7.7	5.0	8.1	4.9
	37.5	6.2	4.7	6.4	4.8	6.8	4.8	7.2	5.0	7.6	4.9	8.0	4.8
	40.0	6.2	4.7	6.4	4.8	6.7	4.7	7.1	5.0	7.5	4.9	7.9	4.8
43.0	6.1	4.6	6.3	4.8	6.6	4.7	7.0	4.9	7.3	4.8	7.7	4.7	

PDFY-P-VM-A

Cooling Capacity (In combination with Big Y, Super Y, Big R2)

PDFY-P-VM-A

CA:Capacity(kW)
SHC:Sensible Heat Capacity(kW)

Unit size	Outdoor air temp.	Indoor air temp.											
		21.5°CDB 15°CWB		23°CDB 16°CWB		25°CDB 18°CWB		28°CDB 20°CWB		30°CDB 22°CWB		32°CDB 24°CWB	
		°CDB	CA	SHC	CA	SHC	CA	SHC	CA	SHC	CA	SHC	CA
71	20.0	7.4	5.5	7.7	5.7	8.3	5.7	8.9	6.0	9.4	5.9	10.0	5.8
	22.5	7.4	5.5	7.7	5.7	8.2	5.7	8.8	6.0	9.3	5.9	9.8	5.8
	25.0	7.3	5.4	7.6	5.6	8.2	5.6	8.7	5.9	9.2	5.8	9.7	5.7
	27.5	7.2	5.4	7.5	5.6	8.1	5.6	8.6	5.9	9.0	5.8	9.6	5.7
	30.0	7.2	5.4	7.5	5.6	8.0	5.5	8.5	5.8	8.9	5.7	9.4	5.6
	32.5	7.1	5.4	7.4	5.5	7.9	5.5	8.3	5.8	8.8	5.7	9.3	5.6
	35.0	7.1	5.3	7.3	5.5	7.8	5.5	8.2	5.7	8.7	5.6	9.1	5.5
	37.5	7.0	5.3	7.2	5.5	7.7	5.4	8.1	5.7	8.6	5.6	9.0	5.5
	40.0	7.0	5.3	7.2	5.4	7.6	5.4	8.0	5.6	8.4	5.5	8.9	5.4
	43.0	6.9	5.2	7.1	5.4	7.5	5.3	7.9	5.6	8.3	5.5	8.7	5.4
80	20.0	8.3	6.0	8.7	6.2	9.4	6.2	10.0	6.6	10.6	6.5	11.2	6.4
	22.5	8.3	6.0	8.7	6.2	9.3	6.2	9.9	6.5	10.5	6.4	11.1	6.3
	25.0	8.2	6.0	8.6	6.2	9.2	6.1	9.8	6.4	10.3	6.3	10.9	6.2
	27.5	8.1	5.9	8.5	6.1	9.1	6.1	9.6	6.4	10.2	6.3	10.8	6.2
	30.0	8.1	5.9	8.4	6.1	9.0	6.0	9.5	6.3	10.0	6.2	10.6	6.1
	32.5	8.0	5.9	8.3	6.0	8.9	6.0	9.4	6.3	9.9	6.2	10.4	6.1
	35.0	8.0	5.8	8.2	6.0	8.8	5.9	9.3	6.2	9.8	6.1	10.3	6.0
	37.5	7.9	5.8	8.1	6.0	8.6	5.9	9.1	6.2	9.6	6.1	10.1	5.9
	40.0	7.8	5.8	8.1	5.9	8.5	5.8	9.0	6.1	9.5	6.0	10.0	5.9
	43.0	7.7	5.7	8.0	5.9	8.4	5.8	8.9	6.1	9.3	5.9	9.8	5.8
100	20.0	10.3	7.5	10.8	7.8	11.6	7.8	12.5	8.2	13.2	8.1	14.0	8.0
	22.5	10.3	7.5	10.8	7.8	11.5	7.8	12.3	8.2	13.0	8.1	13.8	7.9
	25.0	10.2	7.5	10.7	7.7	11.4	7.7	12.1	8.1	12.8	8.0	13.6	7.8
	27.5	10.1	7.4	10.6	7.7	11.3	7.7	12.0	8.0	12.7	7.9	13.4	7.8
	30.0	10.1	7.4	10.5	7.6	11.2	7.6	11.8	8.0	12.5	7.8	13.2	7.7
	32.5	10.0	7.4	10.3	7.6	11.0	7.5	11.7	7.9	12.3	7.8	13.0	7.6
	35.0	9.9	7.3	10.2	7.5	10.9	7.5	11.5	7.8	12.1	7.7	12.8	7.6
	37.5	9.8	7.3	10.1	7.5	10.8	7.4	11.4	7.8	12.0	7.6	12.6	7.5
	40.0	9.7	7.2	10.0	7.4	10.6	7.4	11.2	7.7	11.8	7.6	12.4	7.4
	43.0	9.6	7.2	9.9	7.4	10.5	7.3	11.0	7.6	11.6	7.5	12.2	7.3
125	20.0	12.9	9.5	13.5	9.9	14.6	9.9	15.6	10.5	16.5	10.3	17.5	10.2
	22.5	12.9	9.5	13.5	9.9	14.4	9.9	15.4	10.4	16.3	10.2	17.2	10.1
	25.0	12.8	9.5	13.3	9.8	14.3	9.8	15.2	10.3	16.1	10.1	17.0	10.0
	27.5	12.7	9.4	13.2	9.8	14.1	9.7	15.0	10.2	15.8	10.1	16.7	9.9
	30.0	12.6	9.4	13.1	9.7	13.9	9.6	14.8	10.1	15.6	10.0	16.5	9.8
	32.5	12.5	9.3	12.9	9.6	13.8	9.6	14.6	10.1	15.4	9.9	16.2	9.7
	35.0	12.4	9.3	12.8	9.6	13.6	9.5	14.4	10.0	15.2	9.8	16.0	9.6
	37.5	12.3	9.2	12.7	9.5	13.5	9.4	14.2	9.9	15.0	9.7	15.7	9.5
	40.0	12.2	9.2	12.5	9.4	13.3	9.3	14.0	9.8	14.8	9.6	15.5	9.4
	43.0	12.0	9.1	12.4	9.4	13.1	9.3	13.8	9.7	14.5	9.5	15.2	9.3

PDFY-P-VM-A

2-6.Heating Capacity (In combination with Big Y, Super Y, Big R2)

PDFY-P-VM-A

Unit size	Outdoor air temp. °CWB	Indoor air temp.:°CDB			
		15	21	25	27
		SHC	SHC	SHC	SHC
20	-15.0	1.6	1.5	1.5	1.5
	-10.0	1.8	1.8	1.7	1.7
	-5.0	2.0	2.0	2.0	1.9
	0.0	2.2	2.2	2.1	1.9
	2.5	2.4	2.3	2.1	1.9
	6.0	2.5	2.5	2.1	1.9
	7.5	2.6	2.5	2.1	1.9
	10.0	2.7	2.5	2.1	1.9
	12.5	2.9	2.5	2.1	1.9
	15.5	2.9	2.5	2.1	1.9
25	-15.0	2.0	2.0	1.9	1.9
	-10.0	2.3	2.2	2.2	2.2
	-5.0	2.6	2.5	2.5	2.5
	0.0	2.9	2.8	2.7	2.5
	2.5	3.0	3.0	2.7	2.5
	6.0	3.2	3.2	2.7	2.5
	7.5	3.3	3.2	2.7	2.5
	10.0	3.5	3.2	2.7	2.5
	12.5	3.7	3.2	2.7	2.5
	15.5	3.7	3.2	2.7	2.5
32	-15.0	2.5	2.5	2.4	2.4
	-10.0	2.8	2.8	2.8	2.7
	-5.0	3.2	3.2	3.1	3.1
	0.0	3.6	3.5	3.4	3.1
	2.5	3.8	3.7	3.4	3.1
	6.0	4.0	4.0	3.4	3.1
	7.5	4.2	4.0	3.4	3.1
	10.0	4.4	4.0	3.4	3.1
	12.5	4.6	4.0	3.4	3.1
	15.5	4.6	4.0	3.4	3.1
40	-15.0	3.1	3.1	3.0	3.0
	-10.0	3.6	3.5	3.5	3.4
	-5.0	4.0	4.0	3.9	3.9
	0.0	4.5	4.4	4.3	3.9
	2.5	4.7	4.7	4.3	3.9
	6.0	5.0	5.0	4.3	3.9
	7.5	5.2	5.0	4.3	3.9
	10.0	5.4	5.0	4.3	3.9
	12.5	5.7	5.0	4.3	3.9
	15.5	5.8	5.0	4.3	3.9
50	-15.0	3.9	3.9	3.8	3.7
	-10.0	4.5	4.4	4.3	4.3
	-5.0	5.0	5.0	4.9	4.9
	0.0	5.6	5.6	5.4	4.9
	2.5	5.9	5.9	5.4	4.9
	6.0	6.4	6.3	5.4	4.9
	7.5	6.6	6.3	5.4	4.9
	10.0	6.9	6.3	5.4	4.9
	12.5	7.2	6.3	5.4	4.9
	15.5	7.2	6.3	5.4	4.9

SHC:Sensible Heat Capacity(kW)

Unit size	Outdoor air temp. °CWB	Indoor air temp.:°CDB			
		15	21	25	27
		SHC	SHC	SHC	SHC
63	-15.0	5.0	4.9	4.8	4.7
	-10.0	5.7	5.6	5.5	5.4
	-5.0	6.4	6.3	6.2	6.2
	0.0	7.2	7.1	6.8	6.2
	2.5	7.5	7.5	6.8	6.2
	6.0	8.1	8.0	6.8	6.2
	7.5	8.3	8.0	6.8	6.2
	10.0	8.7	8.0	6.8	6.2
	12.5	9.1	8.0	6.8	6.2
	15.5	9.2	8.0	6.8	6.2
71	-15.0	5.6	5.5	5.4	5.3
	-10.0	6.4	6.3	6.2	6.1
	-5.0	7.2	7.1	7.0	6.9
	0.0	8.0	8.0	7.7	6.9
	2.5	8.5	8.4	7.7	6.9
	6.0	9.1	9.0	7.7	6.9
	7.5	9.4	9.0	7.7	6.9
	10.0	9.8	9.0	7.7	6.9
	12.5	10.3	9.0	7.7	6.9
	15.5	10.4	9.0	7.7	6.9
80	-15.0	6.2	6.1	6.0	5.9
	-10.0	7.1	7.0	6.9	6.8
	-5.0	8.0	7.9	7.8	7.7
	0.0	8.9	8.8	8.5	7.7
	2.5	9.4	9.3	8.5	7.7
	6.0	10.1	10.0	8.5	7.7
	7.5	10.4	10.0	8.5	7.7
	10.0	10.9	10.0	8.5	7.7
	12.5	11.4	10.0	8.5	7.7
	15.5	11.5	10.0	8.5	7.7
100	-15.0	7.8	7.7	7.5	7.4
	-10.0	8.9	8.8	8.6	8.5
	-5.0	10.0	9.9	9.8	9.6
	0.0	11.2	11.0	10.6	9.6
	2.5	11.8	11.6	10.6	9.6
	6.0	12.6	12.5	10.6	9.6
	7.5	13.0	12.5	10.6	9.6
	10.0	13.6	12.5	10.6	9.6
	12.5	14.3	12.5	10.6	9.6
	15.5	14.4	12.5	10.6	9.6
125	-15.0	10.0	9.8	9.6	9.5
	-10.0	11.4	11.2	11.0	10.9
	-5.0	12.8	12.6	12.5	12.3
	0.0	14.3	14.1	13.6	12.3
	2.5	15.1	14.9	13.6	12.3
	6.0	16.2	16.0	13.6	12.3
	7.5	16.6	16.0	13.6	12.3
	10.0	17.4	16.0	13.6	12.3
	12.5	18.3	16.0	13.6	12.3
	15.5	18.4	16.0	13.6	12.3

PDFY-P-VM-A

2-7.Cooling Capacity (In combination with WY, WR2)

CA:Capacity(kW)
SHC:Sensible Heat Capacity(kW)

PDFY-P-VM-A

Unit size	Water temp.	Indoor air temp.													
		21.5°CDB 15°CWB		23°CDB 16°CWB		25°CDB 18°CWB		27°CDB 19°CWB		28°CDB 20°CWB		30°CDB 22°CWB		32°CDB 24°CWB	
		°C	CA	SHC	CA	SHC	CA	SHC	CA	SHC	CA	SHC	CA	SHC	CA
20	10	2.1	1.8	2.2	1.9	2.4	1.8	2.4	1.9	2.5	1.9	2.6	1.9	2.8	1.9
	20	2.1	1.8	2.1	1.8	2.3	1.8	2.3	1.8	2.4	1.9	2.5	1.9	2.7	1.9
	30	2.0	1.7	2.0	1.8	2.1	1.7	2.2	1.8	2.3	1.9	2.4	1.8	2.5	1.8
	40	1.7	1.6	1.8	1.6	1.9	1.6	1.9	1.7	2.0	1.7	2.1	1.7	2.2	1.7
	45	1.6	1.5	1.7	1.6	1.8	1.6	1.8	1.6	1.9	1.7	2.0	1.7	2.1	1.7
25	10	2.7	2.1	2.8	2.1	3.0	2.1	3.1	2.1	3.2	2.2	3.3	2.2	3.5	2.1
	20	2.6	2.0	2.7	2.1	2.9	2.1	3.0	2.1	3.1	2.2	3.2	2.1	3.4	2.1
	30	2.5	1.9	2.6	2.0	2.7	2.0	2.8	2.0	2.9	2.1	3.0	2.1	3.2	2.0
	40	2.2	1.8	2.2	1.9	2.4	1.8	2.4	1.9	2.5	2.0	2.6	1.9	2.8	1.9
	45	2.0	1.7	2.1	1.8	2.2	1.8	2.3	1.8	2.4	1.9	2.5	1.9	2.6	1.8
32	10	3.5	2.5	3.6	2.6	3.9	2.6	4.0	2.6	4.1	2.7	4.3	2.6	4.5	2.6
	20	3.4	2.4	3.5	2.5	3.7	2.5	3.8	2.5	3.9	2.6	4.1	2.6	4.4	2.5
	30	3.2	2.4	3.3	2.4	3.5	2.4	3.6	2.4	3.7	2.5	3.9	2.5	4.1	2.4
	40	2.8	2.1	2.9	2.2	3.1	2.2	3.1	2.2	3.2	2.3	3.4	2.3	3.6	2.2
	45	2.6	2.1	2.7	2.1	2.9	2.1	3.0	2.2	3.0	2.2	3.2	2.2	3.4	2.2
40	10	4.4	3.3	4.5	3.4	4.8	3.3	5.0	3.4	5.1	3.5	5.4	3.4	5.7	3.4
	20	4.2	3.2	4.4	3.3	4.6	3.2	4.8	3.3	4.9	3.4	5.2	3.4	5.5	3.3
	30	4.0	3.1	4.1	3.2	4.4	3.1	4.5	3.2	4.6	3.3	4.9	3.2	5.2	3.2
	40	3.5	2.8	3.6	2.9	3.8	2.9	3.9	2.9	4.0	3.1	4.3	3.0	4.5	3.0
	45	3.3	2.7	3.4	2.8	3.6	2.8	3.7	2.8	3.8	3.0	4.0	2.9	4.2	2.9
50	10	5.5	4.0	5.6	4.1	6.0	4.1	6.2	4.1	6.3	4.3	6.7	4.2	7.1	4.2
	20	5.3	3.9	5.4	4.0	5.8	4.0	5.9	4.0	6.1	4.2	6.5	4.1	6.8	4.1
	30	5.0	3.8	5.1	3.9	5.5	3.9	5.6	3.9	5.8	4.1	6.1	4.0	6.4	3.9
	40	4.3	3.5	4.5	3.6	4.7	3.5	4.9	3.6	5.0	3.8	5.3	3.7	5.6	3.6
	45	4.1	3.3	4.2	3.5	4.5	3.4	4.6	3.5	4.7	3.6	5.0	3.6	5.3	3.5
63	10	6.9	5.0	7.2	5.2	7.6	5.1	7.8	5.2	8.0	5.4	8.5	5.3	9.0	5.2
	20	6.7	4.9	6.9	5.1	7.3	5.0	7.5	5.1	7.8	5.3	8.2	5.2	8.6	5.1
	30	6.3	4.7	6.5	4.9	6.9	4.8	7.1	4.9	7.3	5.1	7.7	5.0	8.1	4.9
	40	5.5	4.3	5.7	4.5	6.0	4.4	6.2	4.5	6.4	4.7	6.7	4.6	7.1	4.5
	45	5.2	4.2	5.3	4.3	5.7	4.3	5.8	4.4	6.0	4.5	6.3	4.5	6.7	4.4
71	10	7.8	5.7	8.1	5.9	8.6	5.8	8.8	5.9	9.1	6.1	9.6	6.0	10.1	5.9
	20	7.5	5.6	7.8	5.7	8.3	5.7	8.5	5.7	8.7	5.9	9.2	5.8	9.7	5.7
	30	7.1	5.3	7.3	5.5	7.8	5.5	8.0	5.5	8.2	5.7	8.7	5.6	9.2	5.5
	40	6.2	4.9	6.4	5.1	6.8	5.0	7.0	5.1	7.2	5.3	7.6	5.2	8.0	5.1
	45	5.8	4.7	6.0	4.9	6.4	4.8	6.6	4.9	6.8	5.1	7.1	5.1	7.5	5.0
80	10	8.8	6.2	9.1	6.4	9.6	6.4	9.9	6.4	10.2	6.6	10.8	6.5	11.4	6.4
	20	8.5	6.1	8.7	6.3	9.3	6.2	9.5	6.2	9.8	6.5	10.4	6.4	10.9	6.2
	30	8.0	5.8	8.3	6.0	8.8	5.9	9.0	6.0	9.3	6.2	9.8	6.1	10.3	6.0
	40	6.9	5.3	7.2	5.5	7.6	5.4	7.8	5.5	8.1	5.7	8.5	5.6	9.0	5.5
	45	6.5	5.1	6.8	5.3	7.2	5.2	7.4	5.3	7.6	5.5	8.0	5.4	8.5	5.4
100	10	10.9	7.8	11.3	8.1	12.0	8.0	12.3	8.1	12.7	8.3	13.4	8.2	14.1	8.0
	20	10.5	7.6	10.9	7.9	11.6	7.8	11.9	7.9	12.2	8.1	12.9	8.0	13.6	7.9
	30	9.9	7.3	10.3	7.6	10.9	7.5	11.2	7.6	11.5	7.8	12.2	7.7	12.8	7.6
	40	8.6	6.7	8.9	6.9	9.5	6.8	9.7	6.9	10.0	7.2	10.6	7.1	11.2	7.0
	45	8.1	6.5	8.4	6.7	8.9	6.6	9.2	6.7	9.5	7.0	10.0	6.9	10.5	6.8
125	10	13.7	9.9	14.1	10.2	15.0	10.1	15.4	10.2	15.9	10.6	16.7	10.4	17.7	10.2
	20	13.2	9.7	13.6	10.0	14.5	9.9	14.8	10.0	15.3	10.3	16.1	10.2	17.0	10.0
	30	12.4	9.3	12.8	9.6	13.6	9.5	14.0	9.6	14.4	10.0	15.2	9.8	16.1	9.6
	40	10.8	8.5	11.2	8.8	11.9	8.7	12.2	8.9	12.5	9.2	13.2	9.1	14.0	8.9
	45	10.2	8.2	10.5	8.5	11.2	8.4	11.5	8.6	11.8	8.9	12.5	8.8	13.2	8.6

PDFY-P-VM-A

2-8.Heatling Capacity (In combination with WY, WR2)

PDFY-P-VM-A

SHC:Sensible Heat Capacity(kW)

Unit size	Water temp. °C	Indoor air temp.:°CDB				
		15	19	20	25	27
		SHC	SHC	SHC	SHC	SHC
20	10	2.2	2.2	2.1	1.7	1.5
	20	2.6	2.6	2.5	2.0	1.8
	30	2.6	2.6	2.5	2.0	1.8
	40	2.7	2.7	2.6	2.1	1.9
	45	2.9	2.9	2.9	2.3	2.1
25	10	2.8	2.8	2.7	2.2	2.0
	20	3.3	3.3	3.2	2.6	2.3
	30	3.3	3.3	3.2	2.6	2.3
	40	3.4	3.4	3.3	2.7	2.4
	45	3.8	3.7	3.6	2.9	2.6
32	10	3.5	3.5	3.4	2.7	2.4
	20	4.1	4.1	4.0	3.2	2.9
	30	4.1	4.1	4.0	3.2	2.9
	40	4.3	4.2	4.2	3.3	3.0
	45	4.7	4.7	4.6	3.6	3.3
40	10	4.4	4.3	4.3	3.4	3.1
	20	5.2	5.1	5.0	4.0	3.6
	30	5.2	5.1	5.0	4.0	3.6
	40	5.4	5.3	5.2	4.2	3.7
	45	5.9	5.8	5.7	4.6	4.1
50	10	5.5	5.5	5.4	4.3	3.9
	20	6.5	6.4	6.3	5.0	4.5
	30	6.5	6.4	6.3	5.0	4.5
	40	6.7	6.7	6.6	5.2	4.7
	45	7.4	7.3	7.2	5.7	5.2
63	10	7.0	6.9	6.8	5.4	4.9
	20	8.2	8.2	8.0	6.4	5.8
	30	8.2	8.2	8.0	6.4	5.8
	40	8.6	8.5	8.3	6.7	6.0
	45	9.4	9.3	9.1	7.3	6.6
71	10	7.9	7.8	7.7	6.1	5.5
	20	9.3	9.2	9.0	7.2	6.5
	30	9.3	9.2	9.0	7.2	6.5
	40	9.6	9.5	9.4	7.5	6.7
	45	10.6	10.5	10.3	8.2	7.4
80	10	8.8	8.7	8.5	6.8	6.1
	20	10.3	10.2	10.0	8.0	7.2
	30	10.3	10.2	10.0	8.0	7.2
	40	10.7	10.6	10.4	8.3	7.5
	45	11.7	11.6	11.4	9.1	8.2
100	10	10.9	10.8	10.6	8.5	7.7
	20	12.9	12.8	12.5	10.0	9.0
	30	12.9	12.8	12.5	10.0	9.0
	40	13.4	13.3	13.0	10.4	9.4
	45	14.7	14.5	14.3	11.4	10.3
125	10	14.0	13.9	13.6	10.9	9.8
	20	16.5	16.3	16.0	12.8	11.5
	30	16.5	16.3	16.0	12.8	11.5
	40	17.1	17.0	16.6	13.3	12.0
	45	18.8	18.6	18.2	14.6	13.1

PDFY-P-VM-A

3. Sound Levels

3-1. Noise level

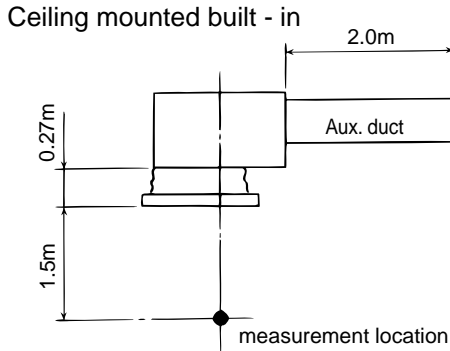

※ PDFY-P20~80VM-A
 Low : 30Pa Mid : 50Pa High : 100Pa
 PDFY-P100, 125VM-A
 Low : 50Pa Mid : 100Pa High : 130Pa

Noise level at anechoic room
 (Low-Middle2-Middle1-High)

Unit : dB(A)

Model	External static pressure※		
	Low	Mid	High
PDFY-P20VM-A PDFY-P25VM-A PDFY-P32VM-A	26-28-31-33	28-30-33-36	31-35-39-41
PDFY-P40VM-A PDFY-P50VM-A	35-35.5-36-37	34-36-37-39	37-39-40-41
PDFY-P63VM-A	28-31-34-37	30-34-36-39	33-37-40-42
PDFY-P71VM-A	30-33-35-38	32-35-37-40	35-38-41-43
PDFY-P80VM-A	31-34-37-39	34-37-40-42	35-39-42-44
PDFY-P100VM-A	34-42(37-44)	36-44(38-45)	38-45(39-46)
PDFY-P125VM-A	40-45(42-46)	42-46(43-47)	42-46(44-47)

3-2. NC curves

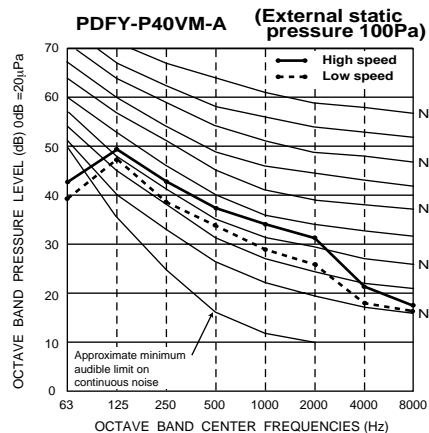
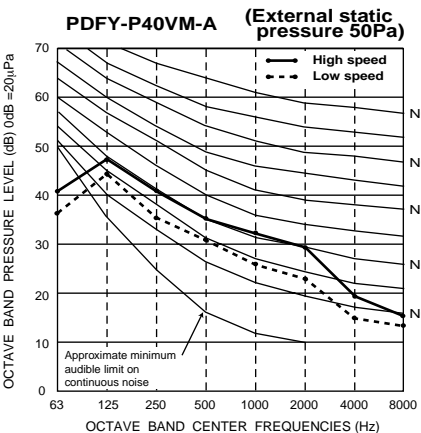
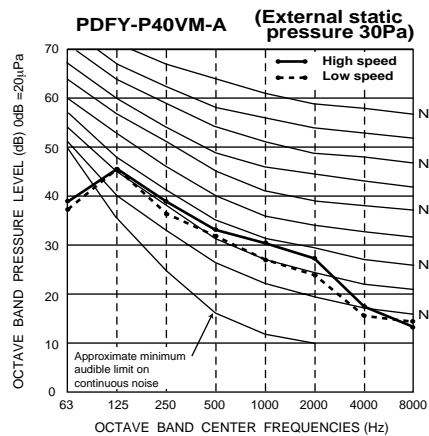
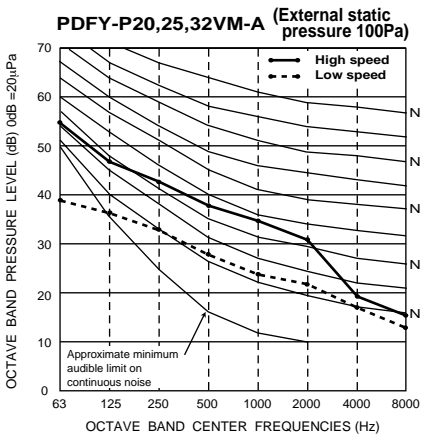
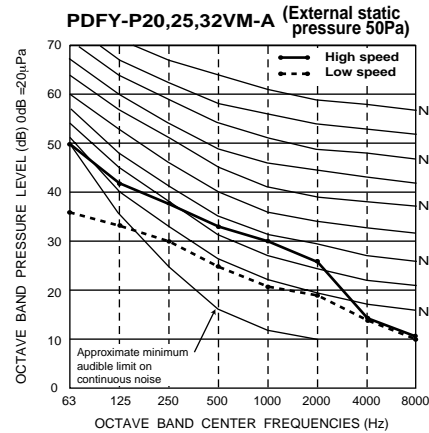
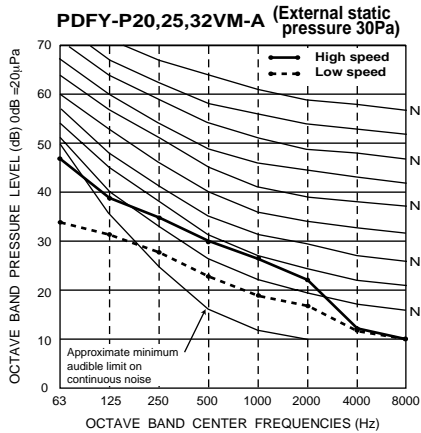

PDFY-P-VM-A

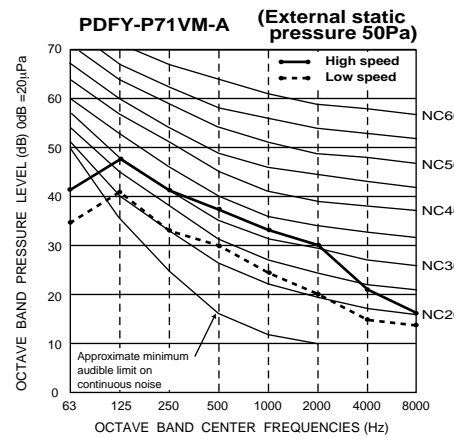
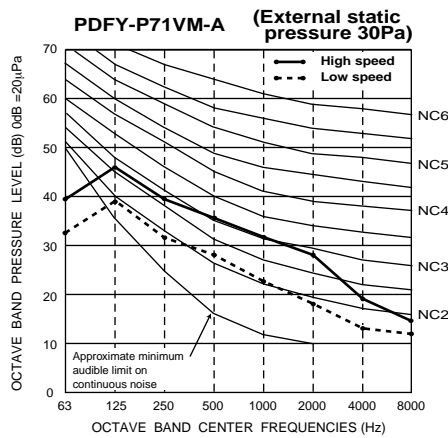
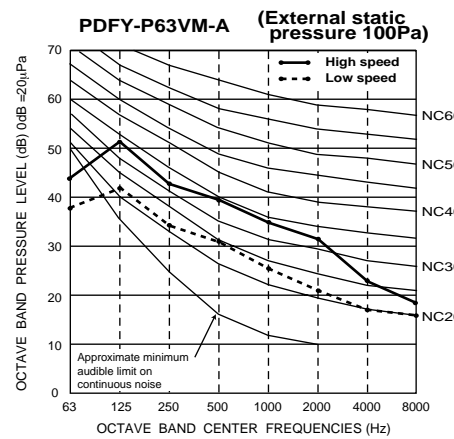
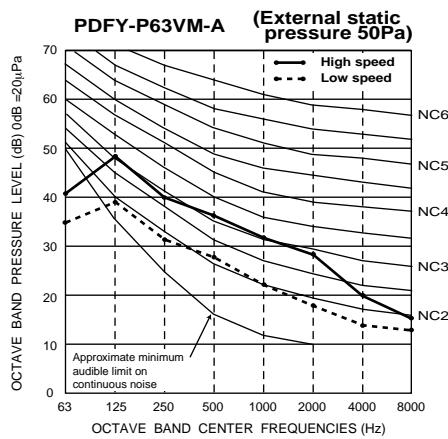
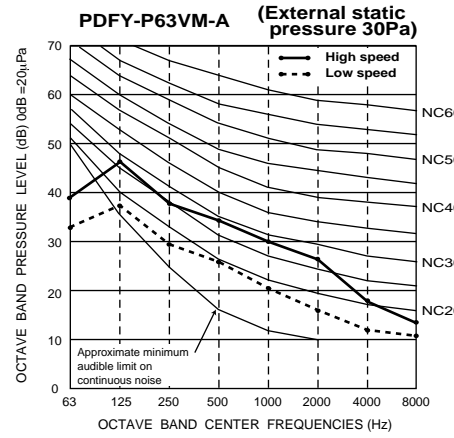
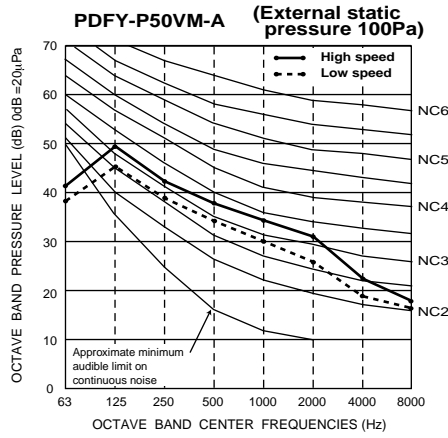
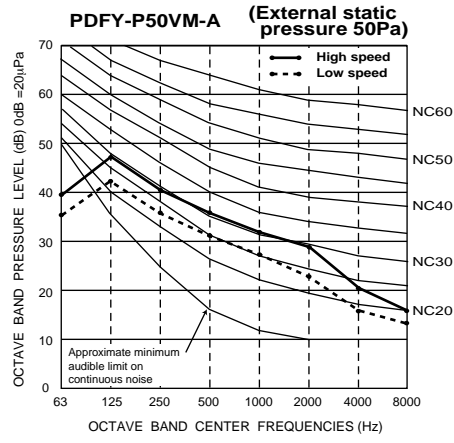
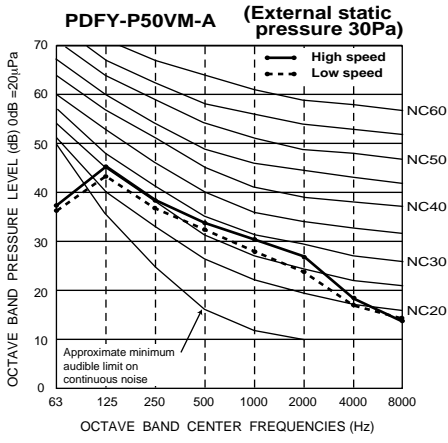

PDFY-P-VM-A

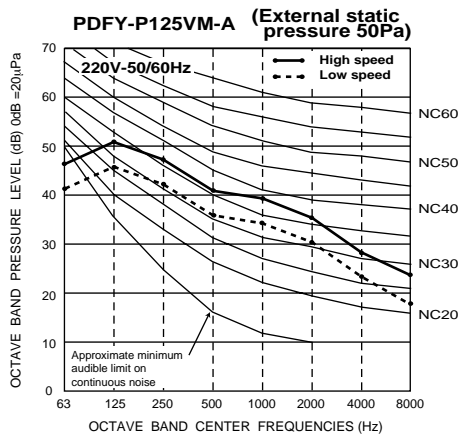
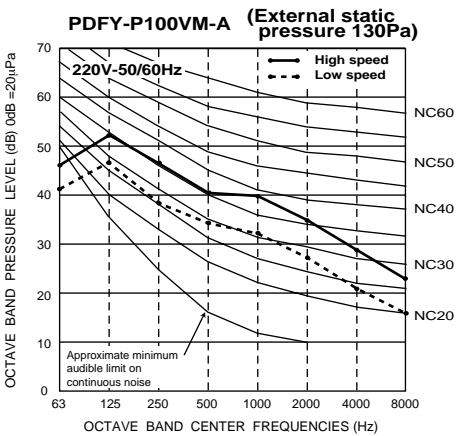
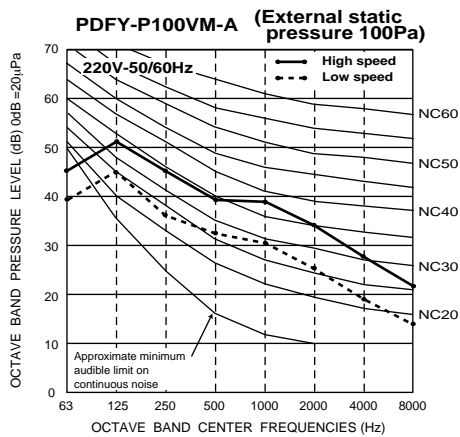
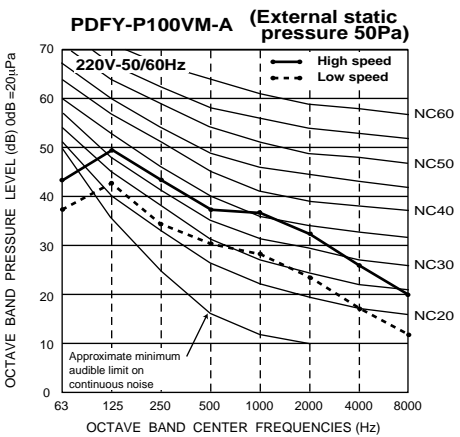
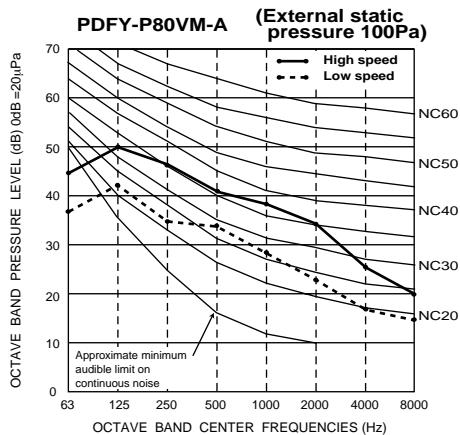
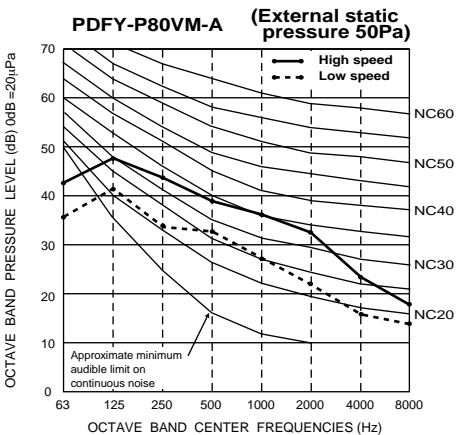
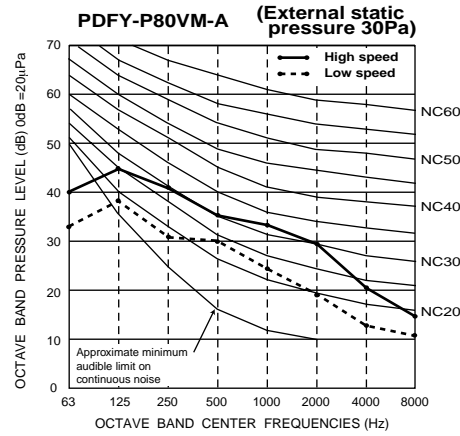
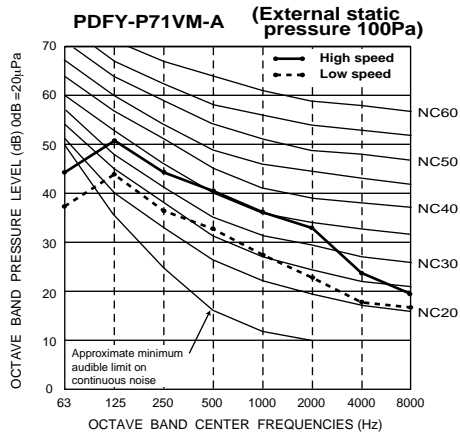

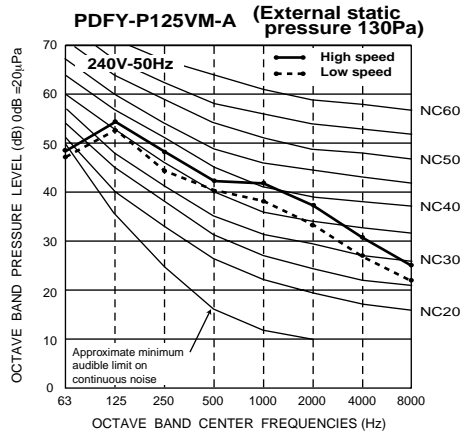
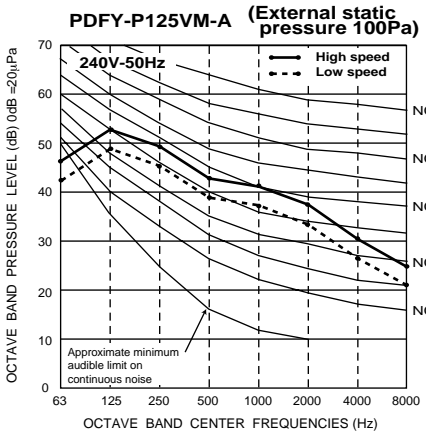
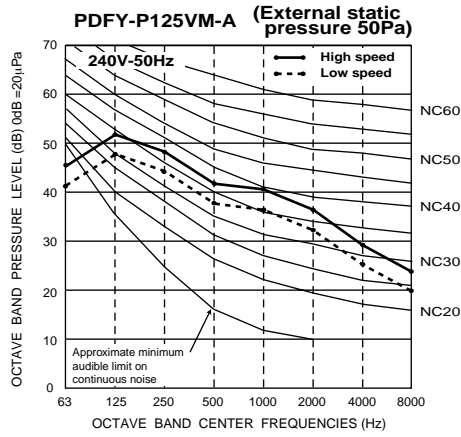
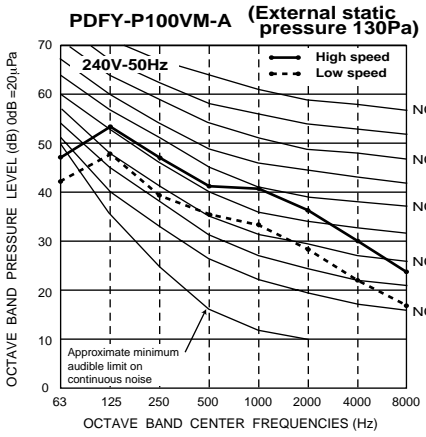
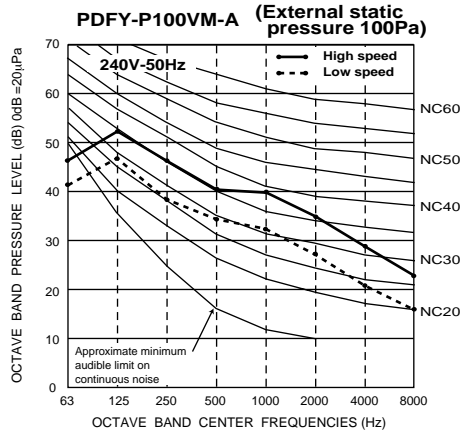
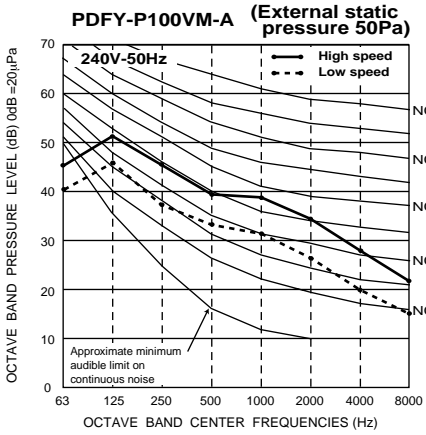
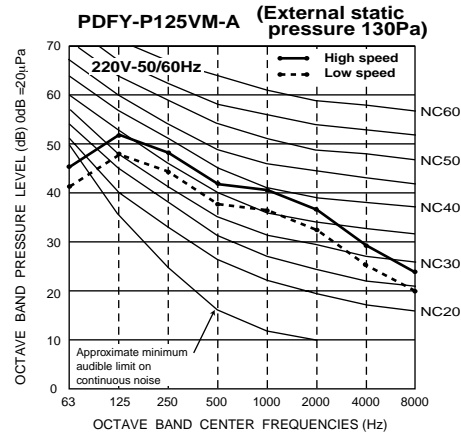
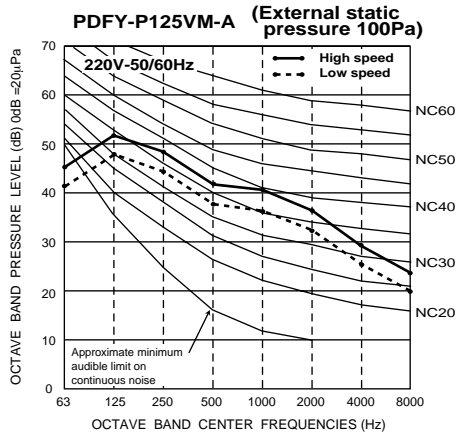

PDFY-P-VM-A

3-3. Fan characteristics curves

PDFY-P20,25,32VM-A
(External static pressure 30,50,100Pa)

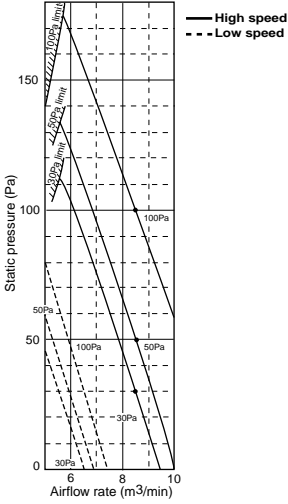

PDFY-P40,50VM-A
(External static pressure 30,50,100Pa)

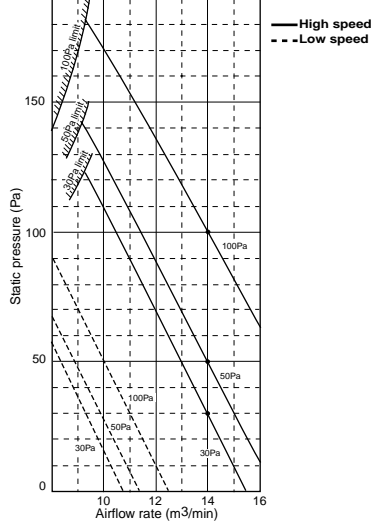

PDFY-P63VM-A
(External static pressure 30,50,100Pa)

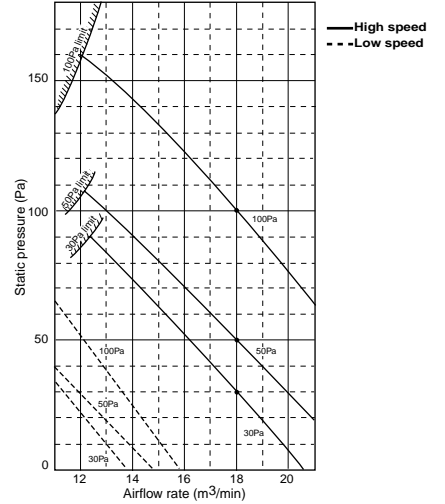

PDFY-P71VM-A
(External static pressure 30,50,100Pa)

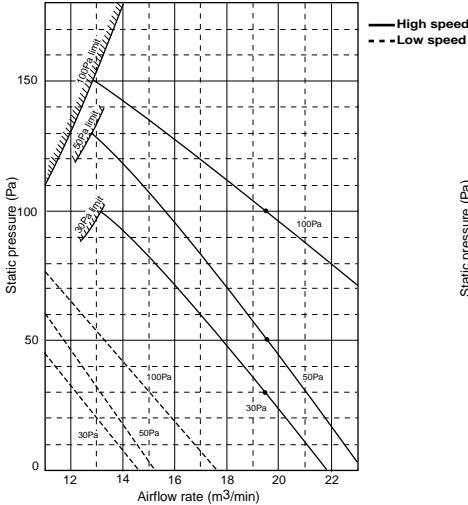

PDFY-P80VM-A
(External static pressure 30,50,100Pa)

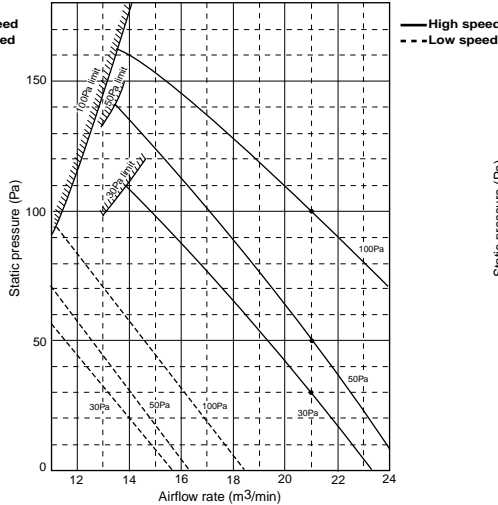

PDFY-P100VM-A
(External static pressure 50,100,130Pa) 50Hz

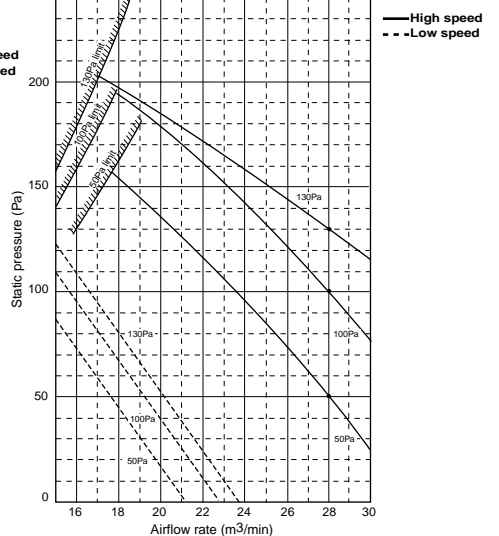

PDFY-P100VM-A
(External static pressure 50,100,130Pa) 60Hz

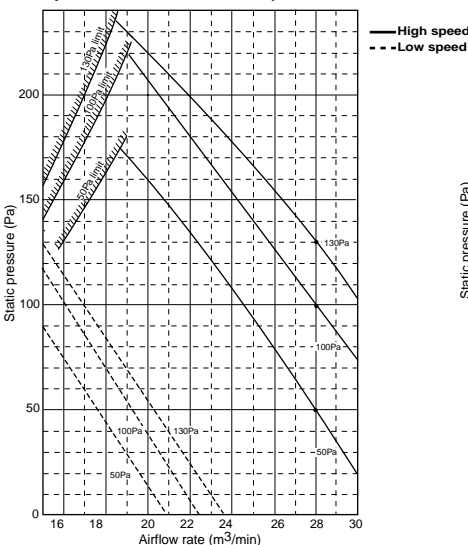

PDFY-P125VM-A
(External static pressure 50,100,130Pa) 50Hz

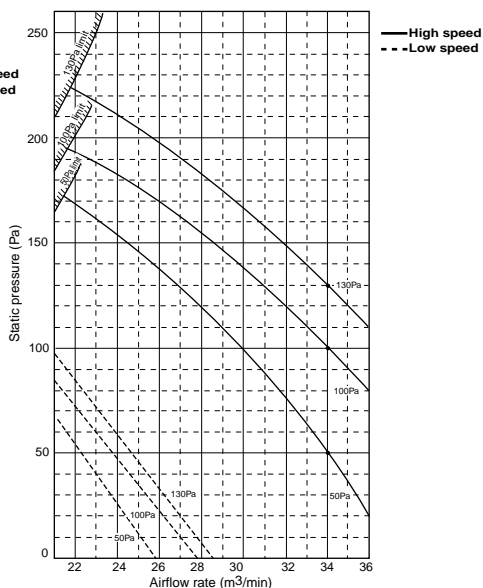

PDFY-P125VM-A
(External static pressure 50,100,130Pa) 60Hz

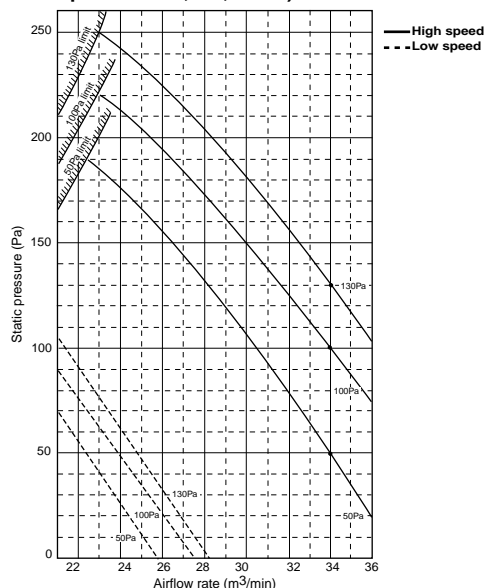

PDFY-P-VM-A

4. External Dimensions

PDFY-P20,25,32,40,50,
63,71,80VM-A

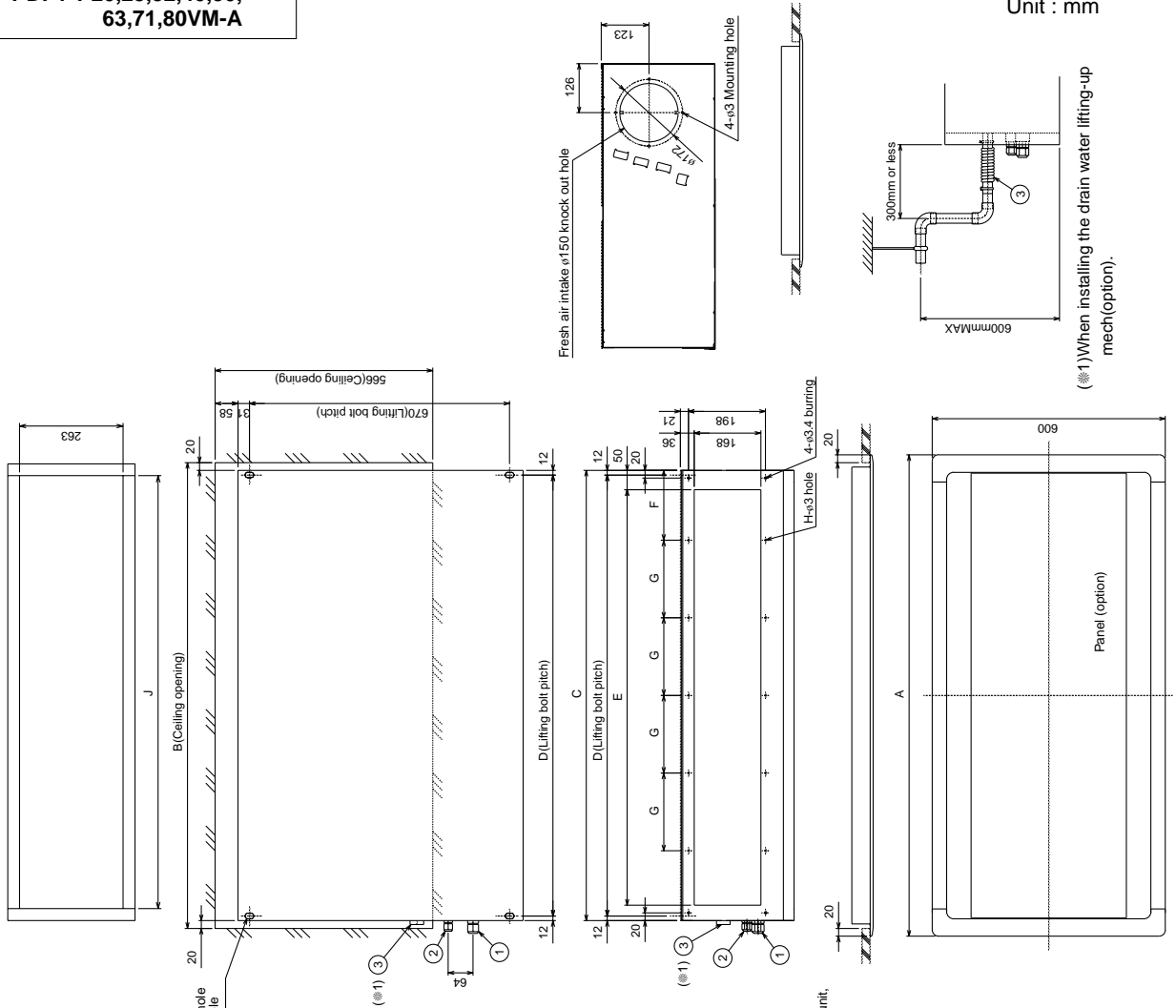

Unit : mm

(※1)When installing the drain water lifting-up mech(option).

Note:1. Use M10 screw for the lifting bolt (field supply).

- Model 20~40
- Gas pipe : LP $\phi 12.7$ (1)
- Liquid pipe : HP $\phi 6.35$ (2)
- Model 50~60
- Gas pipe : LP $\phi 15.88$ (1)
- Liquid pipe : HP $\phi 9.5$ (2)
- Drain hose VP-25 <flexible joint 200mm> (accessory)... (3)

MODEL	A	B	C	D	E	F	G	H	J
PDFY-P20-25-32VM-A	790	750	710	686	620	155	200	6	650
PDFY-P40-50VM-A	1040	1000	960	936	870	180	200	8	900
PDFY-P63-71-80VM-A	1240	1200	1160	1136	1070	180	200	10	1100

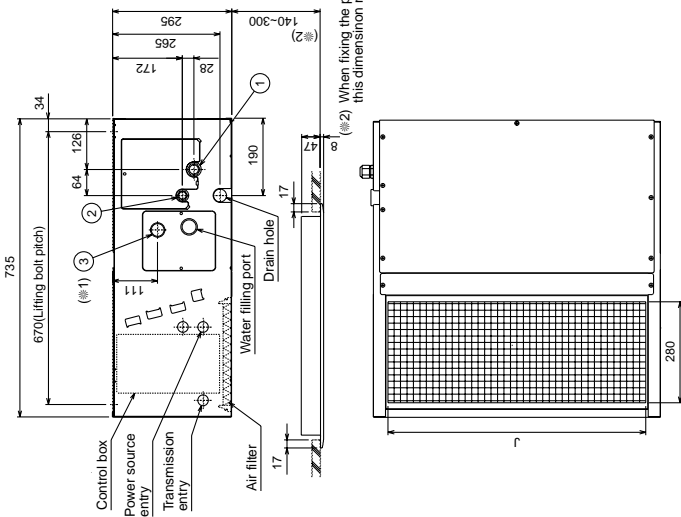

(※2) When fixing the panel to indoor unit, this dimension may be 50-65.

PDFY-P-VN-A

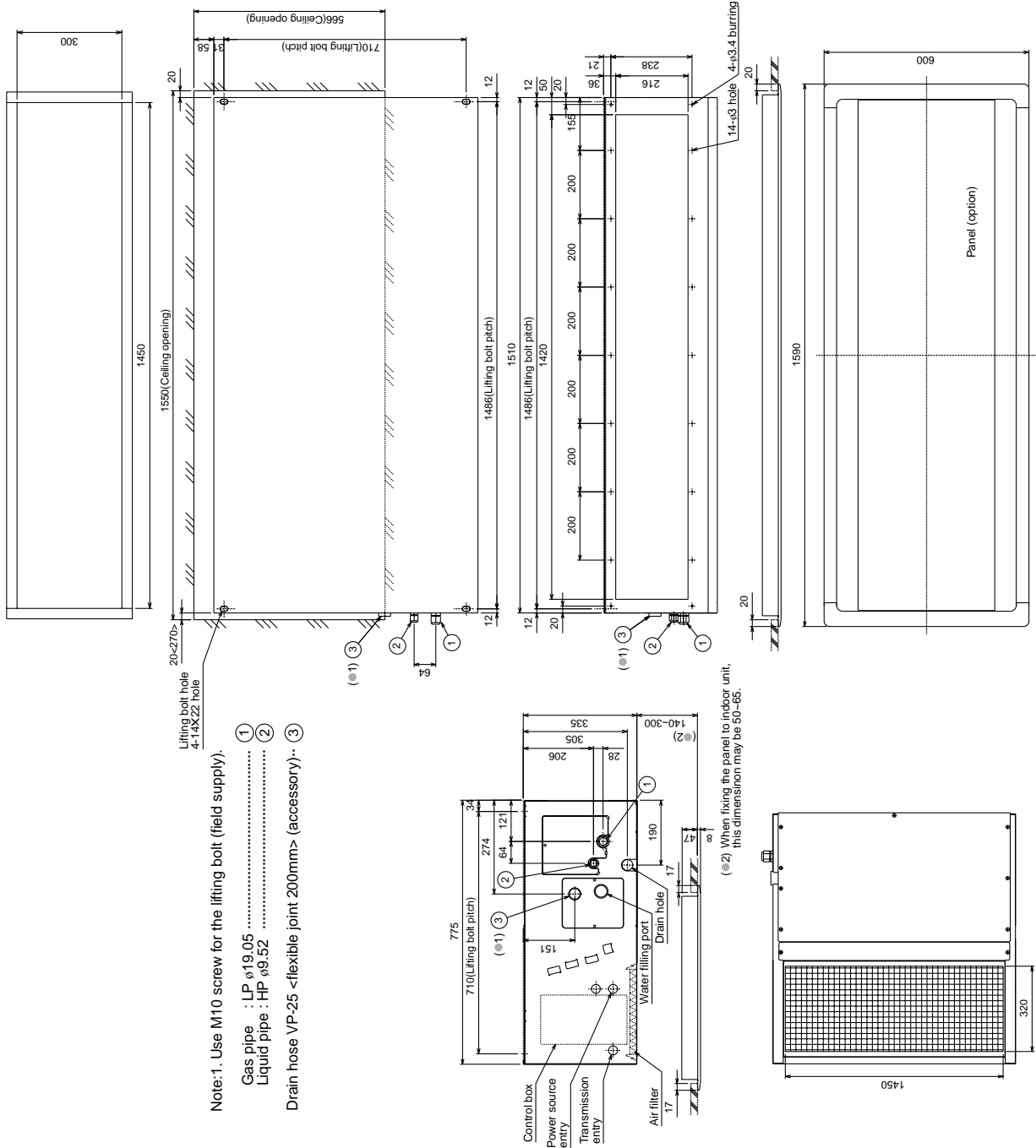

Note: 1. Use M10 screw for the lifting bolt (field supply).

- ① Gas pipe : LP φ19.05
- ② Liquid pipe : HP φ9.52
- ③ Drain hose VP-25 <flexible joint 200mm> (accessory)

(※2) When fixing the panel to indoor unit, this dimension may be 50-65.

(※1) When installing the drain water lifting-up mech(option).

5. Electrical Wiring Diagrams

PDFY-P20~P80VM-A

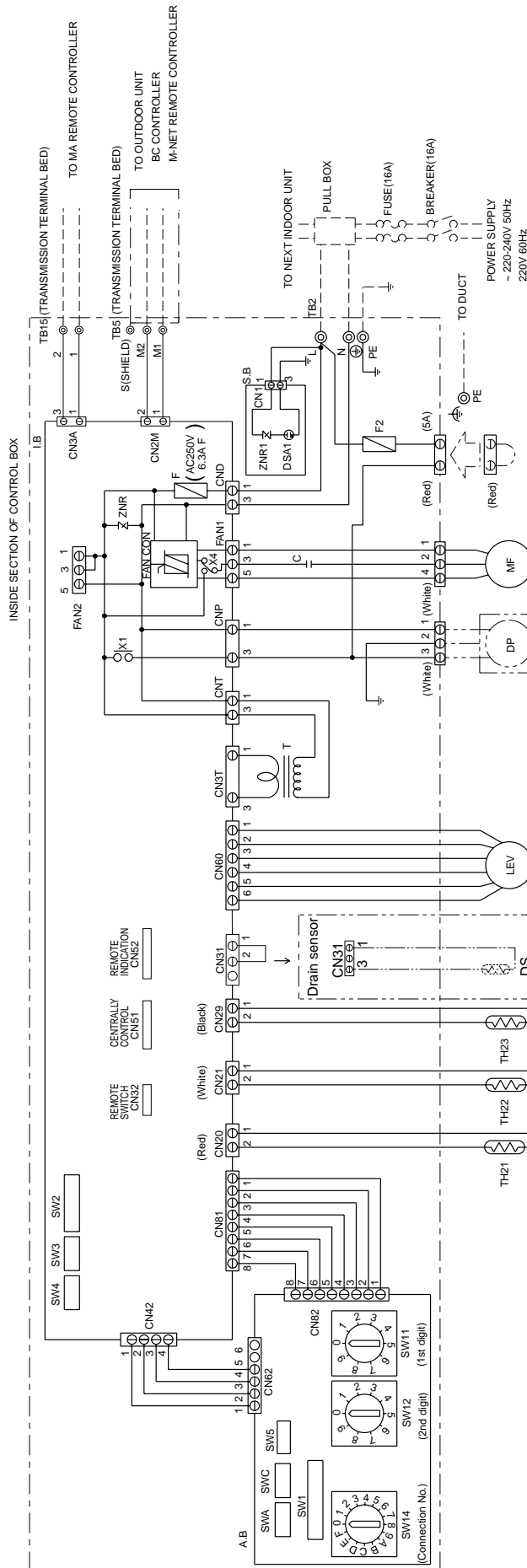

For test of pumpout (after confirm drain pump out, take this connector off.)

- NOTE: 1. TB2, TB5 shown in dotted line are field work.
 2. Mark indicates terminal bed, connector, board insertion connector or fastening connector of control board.
 3. - - - - - : optional parts

SYMBOL EXPLANATION

SYMBOL	NAME	SYMBOL	NAME
MF	Fan motor	TH22	Thermistor (piping temp.detection/liquid)
C	* Capacitor (for MF)	TH23	Thermistor (piping temp.detection/gas)
I.B	Indoor controller board	SWA(A.B)	Switch (option parts)
A.B	Address board	SWC(A.B)	Switch (option parts)
TB2	Power source terminal bed	SW11(A.B)	Switch (1st digit address set)
TB5	Transmission terminal bed	SW12(A.B)	Switch (2nd digit address set)
TB15	Transmission terminal bed	SW14(A.B)	Switch (connection No.set)
F	Fuse AC250V 6.3A F	SW1(A.B)	Switch(for mode selection)
<F2>	Fuse AC250V 5A F	SW2(I.B)	Switch(for capacity code)
T	Transformer	SW3(I.B)	Switch(for mode selection)
<DP>	Drain pump	SW4(I.B)	Switch(for model selection)
<DS>	Drain sensor	SW5(A.B)	Switch(for voltage selection)
LEV	Electronic linear expan. valve	X1.X4	Aux.relay
TH21	Thermistor (inlet temp.detection)	S.B	Surge absorber board

Inside < > is the optional parts.

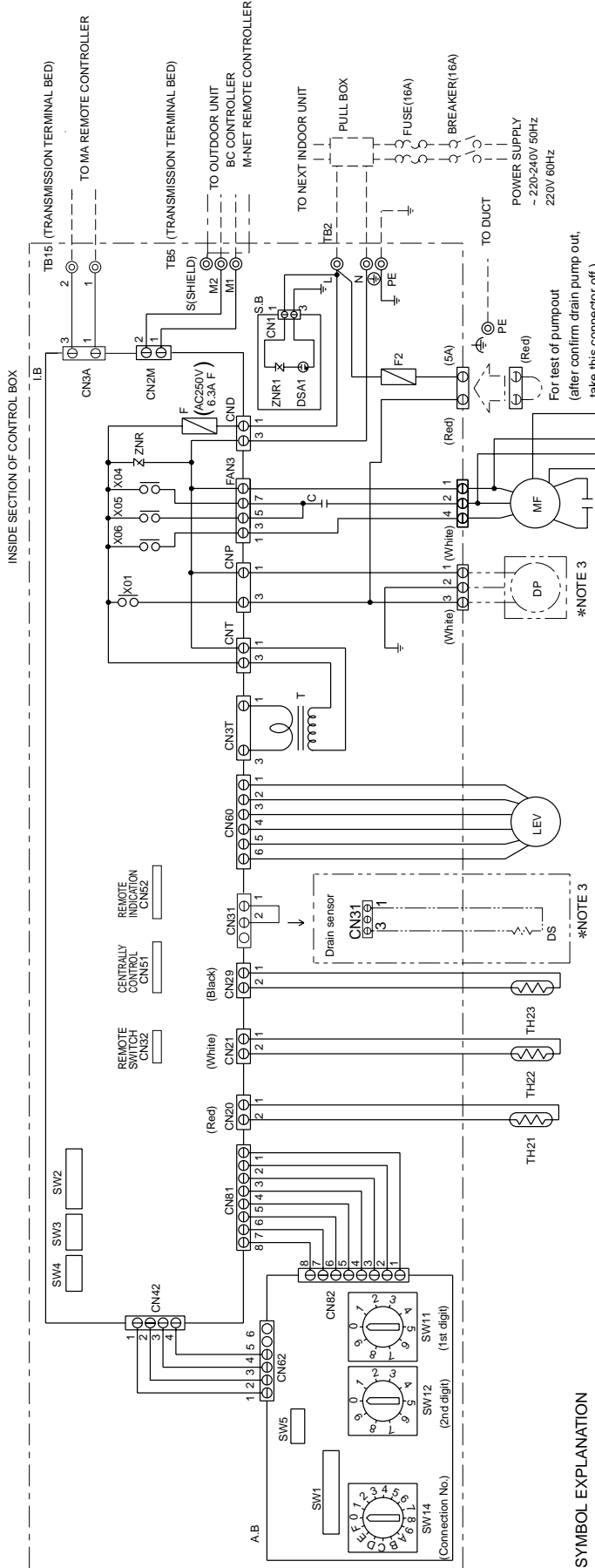

SYMBOL EXPLANATION

SYMBOL	NAME	SYMBOL	NAME
MF	Fan motor	TH22	Thermistor (piping temp.detection/liquid)
C	* Capacitor (for MF)	TH23	Thermistor (piping temp.detection/gas)
I.B	Indoor controller board	SWA(A.B)	Switch (option parts)
A.B	Address board	SWC(A.B)	Switch (option parts)
TB2	Power source terminal bed	SW11(A.B)	Switch (1st digit address set)
TB5	Transmission terminal bed	SW12(A.B)	Switch (2nd digit address set)
TB15	Transmission terminal bed	SW14(A.B)	Switch (connection No.set)
F	Fuse AC250V 6.3A F	SW1(A.B)	Switch(for mode selection)
<F2>	Fuse AC250V 5A F	SW2(I.B)	Switch(for capacity code)
T	Transformer	SW3(I.B)	Switch(for mode selection)
<DP>	Drain pump	SW4(I.B)	Switch(for model selection)
<DS>	Drain sensor	SW5(A.B)	Switch(for voltage selection)
LEV	Electronic linear expans. valve	X01, X04 ~ X06	Aux.relay
TH21	Thermistor (inlet temp.detection)	S.B	Surge absorber board

*The following external static pressure indicate using fore-sided duct flange.

Connector color
 White... In case of used 50Pa.
 Red ... In case of used 100Pa or 70Pa included <h.e.f>.
 Blue ... In case of used 130Pa or 100Pa included <h.e.f>.
 (<h.e.f>:high efficiency filter)

- NOTE:1.TB2,TB5 shown in dotted line are field work.
 2.Mark ⊙ indicates terminal bed, ⊞ connector, ⊠ board insertion connector or fastening connector of control board.
 3. --- : optional parts

*Capacitor
 MODELS 100 5.0μF
 MODELS 125 8.0μF

Inside < > is the optional parts.

6. Option

Description	Model	Applicable capacity
Drain water lift-up kit	PAC-KD02DM-F	P20/P25/P32/P40/P50 P63/P71/P80/P100/P125
Square duct flange	PAC-KD32KDF-F	P20/P25/P32
	PAC-KD50KDF-F	P40/P50
	PAC-KD80KDF-F	P63/P71/P80
	PAC-KD125KDF-F	P100/P125
Circular duct flange	PAC-KD32EDF-F	P20/P25/P32
	PAC-KD50EDF-F	P40/P50
	PAC-KD80EDF-F	P63/P71/P80
	PAC-KD125EDF-F	P100/P125
Filter box for rear suction	PAC-KD80RTB	P20/P25/P32
	PAC-KD81RTB	P40/P50
	PAC-KD83RTB	P63/P71/P80
	PAC-KD84RTB	P100/P125
Canvas duct for bottom suction	PAC-KD90DF	P20/P25/P32
	PAC-KD91DF	P40/P50
	PAC-KD93DF	P63/P71/P80
	PAC-KD94DF	P100/P125
Filter box for bottom suction	PAC-KD70TB	P20/P25/P32
	PAC-KD71TB	P40/P50
	PAC-KD73TB	P63/P71/P80
	PAC-KD74TB	P100/P125
High efficiency filter 65%	PAC-KD30AF	P20/P25/P32
	PAC-KD31AF	P40/P50
	PAC-KD33AF	P63/P71/P80
	PAC-KD34AF	P100/P125
High efficiency filter 90%	PAC-KD40AF	P20/P25/P32
	PAC-KD41AF	P40/P50
	PAC-KD43AF	P63/P71/P80
	PAC-KD44AF	P100/P125
Maintenance panel with air intake	CMP-J36DSW	P20/P25/P32
	CMP-J56DSW	P40/P50
	CMP-J90DSW	P63/P71/P80
	CMP-J160DSW	P100/P125

Floor standing(Exposed)
Floor standing(Concealed)

PFFY-P-VLEM-A
PFFY-P-VLRM-A

CONTENTS

1. Specifications	II -102
2. Capacity Tables	II -103
2-1 Cooling Capacity(PUMY)	II -103
2-2 Heating Capacity(PUMY)	II -104
2-3 Cooling Capacity(Y/R2-8·10·13HP)	II -105
2-4 Heating Capacity(Y/R2-8·10·13HP)	II -106
2-5 Cooling Capacity(Big Y, Super Y, Big R2)	II -107
2-6 Heating Capacity(Big Y, Super Y, Big R2)	II -108
2-7 Cooling Capacity(WY, WR2)	II -109
2-8 Heating Capacity(WY, WR2)	II -109
3. Sound Levels	II -110
3-1 Noise levels	II -110
3-2 N/C curves	II -110
4. External Dimensions	II -111
5. Electrical Wiring Diagram	II -113
6. Temperature/Airflow distribution	II -114

PFFY-P-
VLEM-A/VLRM-A

1. Specifications

			PFFY-P20VLEM-A	PFFY-P25VLEM-A	PFFY-P32VLEM-A	PFFY-P40VLEM-A	PFFY-P50VLEM-A	PFFY-P63VLEM-A
Power source			~ 220-240V 50Hz / ~ 208-230V 60Hz					
Cooling capacity	*1	kW	2.2	2.8	3.6	4.5	5.6	7.1
	*2	kcal/h	2,000	2,500	3,150	4,000	5,000	6,300
Heating capacity	*1	kW	2.5	3.2	4.0	5.0	6.3	8.0
Power consumption	Cooling	kW	0.04 / 0.06		0.06 / 0.07	0.065 / 0.075	0.085 / 0.09	0.1 / 0.11
	Heating	kW	0.04 / 0.06		0.06 / 0.07	0.065 / 0.075	0.085 / 0.09	0.1 / 0.11
Current	Cooling	A	0.19 / 0.25		0.29 / 0.30	0.32 / 0.33	0.40 / 0.41	0.46 / 0.47
	Heating	A	0.19 / 0.25		0.29 / 0.30	0.32 / 0.33	0.40 / 0.41	0.46 / 0.47
External finish(Munsel No.)			Acrylic paint (5Y 8/1)					
Dimension	Height	mm	630					
	Width	mm	1,050		1,170		1,410	
	Depth	mm	220					
Net weight		kg	23	25	26	30	32	
Heat exchanger			Cross fin (Aluminum plate fin and copper tube)					
Fan	Type		Sirocco fanX 1			Sirocco fanX 2		
	Airflow rate (Low-High)	*3	5.5-6.5		7.0-9.0	9.0-11.0	12.0-14.0	12.0-15.5
	External static pressure	Pa	0					
Motor	Type		Single phase induction motor					
	Output	kW	0.02	0.03	0.035	0.045		
Air filter			PP Honeycomb fabric (washable)					
Refrigerant pipe dimension	Gas (Flare)	mm	ø 12.7				ø 15.88	
	Liquid (Flare)	mm	ø 6.35				ø 9.52	
Drain pipe dimension			Accessory hose ø 27 (top end : ø 20)					
Noise level (Low-High)		*3 *4 *5	34-40		35-40	38-43		40-46

			PFFY-P20VLRM-A	PFFY-P25VLRM-A	PFFY-P32VLRM-A	PFFY-P40VLRM-A	PFFY-P50VLRM-A	PFFY-P63VLRM-A
Power source			~ 220-240V 50Hz / ~ 208-230V 60Hz					
Cooling capacity	*1	kW	2.2	2.8	3.6	4.5	5.6	7.1
	*2	kcal/h	2,000	2,500	3,150	4,000	5,000	6,300
Heating capacity	*1	kW	2.5	3.2	4.0	5.0	6.3	8.0
Power consumption	Cooling	kW	0.04 / 0.06		0.06 / 0.07	0.065 / 0.075	0.085 / 0.09	0.1 / 0.11
	Heating	kW	0.04 / 0.06		0.06 / 0.07	0.065 / 0.075	0.085 / 0.09	0.1 / 0.11
Current	Cooling	A	0.19 / 0.25		0.29 / 0.30	0.32 / 0.33	0.40 / 0.41	0.46 / 0.47
	Heating	A	0.19 / 0.25		0.29 / 0.30	0.32 / 0.33	0.40 / 0.41	0.46 / 0.47
External finish(Munsel No.)			Galvanizing					
Dimension	Height	mm	639					
	Width	mm	886		1,006		1,246	
	Depth	mm	220					
Net weight		kg	18.5	20	21	25	27	
Heat exchanger			Cross fin (Aluminum plate fin and copper tube)					
Fan	Type		Sirocco fanX 1			Sirocco fanX 2		
	Airflow rate (Low-High)	*3	5.5-6.5		7.0-9.0	9.0-11.0	12.0-14.0	12.0-15.5
	External static pressure	Pa	0					
Motor	Type		Single phase induction motor					
	Output	kW	0.02	0.03	0.035	0.045		
Air filter			PP Honeycomb fabric (washable)					
Refrigerant pipe dimension	Gas (Flare)	mm	ø 12.7				ø 15.88	
	Liquid (Flare)	mm	ø 6.35				ø 9.52	
Drain pipe dimension			Accessory hose ø 27 (top end : ø 20)					
Noise level (Low-High)		*3 *4 *5	34-40		35-40	38-43		40-46

Note: *1 Cooling/Heating capacity indicates the maximum value at operation under the following condition.

Cooling : Indoor 27°CDB/19°CWB, Outdoor 35°CDB

Heating : Indoor 20°CDB, Outdoor 7°CDB/6°CWB

*2 Cooling capacity indicates the maximum value at operation under the following condition.

Cooling : Indoor 27°CDB/19.5°CWB, Outdoor 35°CDB (WR2: water 30°C)

*3 Air flow rate/noise level are in (Low-High)

*4 Measured point : 1mX1m, Power supply : AC240V/50Hz

•1dB(A) lower at AC230V/50Hz

•2dB(A) lower at AC220V/50Hz

•3dB(A) lower at 1.5mX1.5m point

*5 It is measured in anechoic room.

2. Capacity Tables

2-1.Cooling Capacity (In combination with PUMY)

CA:Capacity(kW)
SHC:Sensible Heat Capacity(kW)

PFFY-P-VLEM-AVLRM-A

Unit size	Outdoor air temp.	Indoor air temp.							
		23°CDB 16°CWB		25°CDB 18°CWB		28°CDB 20°CWB		30°CDB 22°CWB	
		CA	SHC	CA	SHC	CA	SHC	CA	SHC
20 (2.2)	20.0	2.2	1.9	2.3	2.0	2.4	2.0	2.6	2.1
	22.5	2.1	1.9	2.3	2.0	2.4	2.0	2.6	2.1
	25.0	2.1	1.9	2.3	2.0	2.4	2.0	2.5	2.0
	27.5	2.1	1.9	2.2	2.0	2.4	2.0	2.5	2.0
	30.0	2.1	1.9	2.2	2.0	2.3	1.9	2.5	2.0
	32.5	2.0	1.9	2.2	2.0	2.3	1.9	2.5	2.0
	35.0	2.0	1.8	2.1	1.9	2.3	1.9	2.4	2.0
	37.5	2.0	1.8	2.1	1.9	2.2	1.9	2.4	2.0
	40.0	2.0	1.8	2.1	1.9	2.2	1.9	2.4	2.0
46.0	1.9	1.8	2.0	1.9	2.1	1.9	2.3	1.9	
25 (2.8)	20.0	2.8	2.2	2.9	2.3	3.1	2.3	3.3	2.3
	22.5	2.7	2.2	2.9	2.3	3.1	2.3	3.2	2.3
	25.0	2.7	2.2	2.9	2.3	3.1	2.2	3.2	2.3
	27.5	2.7	2.1	2.8	2.3	3.0	2.2	3.2	2.3
	30.0	2.6	2.1	2.8	2.2	3.0	2.2	3.2	2.3
	32.5	2.6	2.1	2.8	2.2	2.9	2.2	3.1	2.3
	35.0	2.6	2.1	2.7	2.2	2.9	2.2	3.1	2.3
	37.5	2.5	2.1	2.7	2.2	2.9	2.2	3.0	2.2
	40.0	2.5	2.1	2.7	2.2	2.8	2.1	3.0	2.2
46.0	2.4	2.0	2.6	2.1	2.7	2.1	2.9	2.2	
32 (3.6)	20.0	3.6	2.6	3.7	2.7	4.0	2.6	4.2	2.7
	22.5	3.5	2.5	3.7	2.6	4.0	2.6	4.2	2.7
	25.0	3.5	2.5	3.7	2.6	3.9	2.6	4.1	2.7
	27.5	3.4	2.5	3.6	2.6	3.9	2.6	4.1	2.7
	30.0	3.4	2.5	3.6	2.6	3.8	2.6	4.1	2.6
	32.5	3.3	2.4	3.6	2.6	3.8	2.5	4.0	2.6
	35.0	3.3	2.4	3.5	2.5	3.7	2.5	4.0	2.6
	37.5	3.2	2.4	3.5	2.5	3.7	2.5	3.9	2.6
	40.0	3.2	2.4	3.4	2.5	3.6	2.5	3.9	2.6
46.0	3.1	2.3	3.3	2.4	3.5	2.4	3.7	2.5	
40 (4.5)	20.0	4.5	3.2	4.7	3.3	5.0	3.3	5.3	3.4
	22.5	4.4	3.2	4.6	3.3	5.0	3.3	5.2	3.4
	25.0	4.3	3.1	4.6	3.3	4.9	3.3	5.2	3.4
	27.5	4.3	3.1	4.6	3.3	4.9	3.2	5.1	3.3
	30.0	4.2	3.1	4.5	3.2	4.8	3.2	5.1	3.3
	32.5	4.2	3.1	4.4	3.2	4.7	3.2	5.0	3.3
	35.0	4.1	3.0	4.4	3.2	4.7	3.2	5.0	3.3
	37.5	4.1	3.0	4.3	3.2	4.6	3.1	4.9	3.2
	40.0	4.0	3.0	4.3	3.1	4.5	3.1	4.8	3.2
46.0	3.8	2.9	4.1	3.1	4.3	3.0	4.6	3.1	
50 (5.6)	20.0	5.5	4.0	5.8	4.2	6.2	4.2	6.6	4.3
	22.5	5.5	4.0	5.8	4.2	6.2	4.2	6.5	4.3
	25.0	5.4	4.0	5.7	4.2	6.1	4.1	6.4	4.2
	27.5	5.3	3.9	5.7	4.1	6.0	4.1	6.4	4.2
	30.0	5.3	3.9	5.6	4.1	5.9	4.1	6.3	4.2
	32.5	5.2	3.9	5.5	4.1	5.9	4.0	6.2	4.2
	35.0	5.1	3.8	5.5	4.0	5.8	4.0	6.2	4.1
	37.5	5.0	3.8	5.4	4.0	5.7	4.0	6.1	4.1
	40.0	5.0	3.8	5.3	4.0	5.6	3.9	6.0	4.1
46.0	4.8	3.7	5.1	3.9	5.4	3.8	5.8	4.0	
63 (7.1)	20.0	7.0	5.0	7.4	5.2	7.9	5.2	8.3	5.3
	22.5	6.9	5.0	7.3	5.2	7.8	5.2	8.2	5.3
	25.0	6.9	4.9	7.3	5.2	7.7	5.1	8.2	5.3
	27.5	6.8	4.9	7.2	5.1	7.7	5.1	8.1	5.2
	30.0	6.7	4.8	7.1	5.1	7.5	5.0	8.0	5.2
	32.5	6.6	4.8	7.0	5.0	7.5	5.0	7.9	5.1
	35.0	6.5	4.7	6.9	5.0	7.3	4.9	7.8	5.1
	37.5	6.4	4.7	6.8	4.9	7.2	4.9	7.7	5.1
	40.0	6.3	4.6	6.7	4.9	7.2	4.8	7.6	5.0
46.0	6.1	4.5	6.5	4.8	6.9	4.7	7.3	4.9	

PFFY-P-VLEM-AVLRM-A

2-2.Heating Capacity (In combination with PUMY)

PFFY-P-VLEM-A,VLRM-A

SHC:Sensible Heat Capacity(kW)

Unit size	Outdoor air temp. °CWB	Indoor air temp.:°CDB		
		15.0	20.0	25.0
		SHC	SHC	SHC
20	-12.0	1.6	1.6	1.5
	-10.0	1.7	1.6	1.6
	-5.0	1.9	1.9	1.9
	0.0	2.2	2.1	2.1
	2.5	2.3	2.3	2.3
	6.0	2.5	2.5	2.5
	7.5	2.6	2.6	2.5
	10.0	2.8	2.7	2.5
	12.5	2.9	2.8	2.5
15.5	3.1	2.8	2.5	
25	-12.0	2.0	2.0	2.0
	-10.0	2.1	2.1	2.1
	-5.0	2.4	2.4	2.4
	0.0	2.8	2.8	2.7
	2.5	3.0	2.9	2.9
	6.0	3.2	3.2	3.2
	7.5	3.3	3.3	3.2
	10.0	3.5	3.5	3.2
	12.5	3.7	3.5	3.2
15.5	3.9	3.5	3.2	
32	-12.0	2.5	2.5	2.5
	-10.0	2.7	2.6	2.6
	-5.0	3.1	3.0	3.0
	0.0	3.5	3.4	3.4
	2.5	3.7	3.7	3.6
	6.0	4.0	4.0	3.9
	7.5	4.2	4.1	4.0
	10.0	4.4	4.4	4.0
	12.5	4.7	4.4	4.0
15.5	4.9	4.4	4.0	

Unit size	Outdoor air temp. °CWB	Indoor air temp.:°CDB		
		15.0	20.0	25.0
		SHC	SHC	SHC
40	-12.0	3.2	3.1	3.1
	-10.0	3.4	3.3	3.2
	-5.0	3.8	3.8	3.7
	0.0	4.3	4.3	4.2
	2.5	4.6	4.6	4.5
	6.0	5.0	5.0	4.9
	7.5	5.2	5.2	5.0
	10.0	5.5	5.5	5.0
	12.5	5.9	5.5	5.0
15.5	6.2	5.5	5.0	
50	-12.0	4.0	3.9	3.9
	-10.0	4.2	4.2	4.1
	-5.0	4.8	4.8	4.7
	0.0	5.5	5.4	5.3
	2.5	5.8	5.8	5.7
	6.0	6.3	6.3	6.2
	7.5	6.6	6.5	6.2
	10.0	7.0	6.9	6.2
	12.5	7.4	7.0	6.2
15.5	7.7	7.0	6.2	
63	-12.0	5.1	5.0	4.9
	-10.0	5.4	5.3	5.2
	-5.0	6.1	6.0	5.9
	0.0	6.9	6.9	6.8
	2.5	7.4	7.3	7.2
	6.0	8.0	8.0	7.9
	7.5	8.3	8.3	7.9
	10.0	8.8	8.8	7.9
	12.5	9.4	8.8	7.9
15.5	9.8	8.8	7.9	

PFFY-P-VLEM-A/VLRM-A

2-3.Cooling Capacity (In combination with PU(H)Y, PURY-(P)200-250-315YEM-A, TEM-A)

PFFY-P-VLEM-A,VLRM-A

CA:Capacity(kW)

SHC:Sensible Heat Capacity(kW)

Unit size	Outdoor air temp.	Indoor air temp.													
		21.5°CDB 15°CWB		23°CDB 16°CWB		25°CDB 18°CWB		27°CDB 19°CWB		28°CDB 20°CWB		30°CDB 22°CWB		32°CDB 24°CWB	
		°CDB	CA	SHC	CA	SHC	CA	SHC	CA	SHC	CA	SHC	CA	SHC	CA
20 (2.2)	20.0	2.2	1.9	2.2	2.0	2.3	1.9	2.3	2.0	2.4	2.0	2.5	2.0	2.6	2.0
	22.5	2.1	1.9	2.2	2.0	2.3	1.9	2.3	2.0	2.4	2.0	2.4	2.0	2.5	1.9
	25.0	2.1	1.9	2.2	1.9	2.2	1.9	2.3	2.0	2.3	2.0	2.4	2.0	2.5	1.9
	27.5	2.1	1.9	2.1	1.9	2.2	1.9	2.3	1.9	2.3	2.0	2.4	2.0	2.5	1.9
	30.0	2.1	1.9	2.1	1.9	2.2	1.9	2.2	1.9	2.3	2.0	2.4	2.0	2.5	1.9
	32.5	2.0	1.9	2.1	1.9	2.2	1.9	2.2	1.9	2.3	2.0	2.4	2.0	2.4	1.9
	35.0	2.0	1.8	2.1	1.9	2.2	1.9	2.2	1.9	2.2	2.0	2.3	2.0	2.4	1.9
	37.5	2.0	1.8	2.0	1.9	2.1	1.9	2.2	1.9	2.2	2.0	2.3	1.9	2.4	1.9
	40.0	2.0	1.8	2.0	1.9	2.1	1.9	2.2	1.9	2.2	2.0	2.3	1.9	2.4	1.9
43.0	2.0	1.8	2.0	1.9	2.1	1.8	2.1	1.9	2.2	2.0	2.3	1.9	2.3	1.9	
25 (2.8)	20.0	2.7	2.2	2.8	2.2	2.9	2.2	3.0	2.2	3.0	2.3	3.1	2.2	3.2	2.2
	22.5	2.7	2.2	2.8	2.2	2.9	2.2	2.9	2.2	3.0	2.3	3.1	2.2	3.2	2.2
	25.0	2.7	2.2	2.7	2.2	2.9	2.2	2.9	2.2	3.0	2.3	3.1	2.2	3.2	2.2
	27.5	2.7	2.1	2.7	2.2	2.8	2.2	2.9	2.2	2.9	2.3	3.1	2.2	3.2	2.2
	30.0	2.6	2.1	2.7	2.2	2.8	2.1	2.9	2.2	2.9	2.2	3.0	2.2	3.1	2.1
	32.5	2.6	2.1	2.7	2.2	2.8	2.1	2.8	2.2	2.9	2.2	3.0	2.2	3.1	2.1
	35.0	2.6	2.1	2.6	2.2	2.7	2.1	2.8	2.2	2.9	2.2	3.0	2.2	3.1	2.1
	37.5	2.5	2.1	2.6	2.1	2.7	2.1	2.8	2.1	2.8	2.2	2.9	2.2	3.1	2.1
	40.0	2.5	2.1	2.6	2.1	2.7	2.1	2.7	2.1	2.8	2.2	2.9	2.2	3.0	2.1
43.0	2.5	2.1	2.5	2.1	2.7	2.1	2.7	2.1	2.8	2.2	2.9	2.1	3.0	2.1	
32 (3.6)	20.0	3.5	2.5	3.6	2.6	3.7	2.5	3.8	2.5	3.9	2.6	4.0	2.5	4.2	2.5
	22.5	3.5	2.5	3.6	2.6	3.7	2.5	3.8	2.5	3.9	2.6	4.0	2.5	4.1	2.4
	25.0	3.5	2.5	3.5	2.5	3.7	2.5	3.7	2.5	3.8	2.6	4.0	2.5	4.1	2.4
	27.5	3.4	2.5	3.5	2.5	3.6	2.5	3.7	2.5	3.8	2.6	3.9	2.5	4.1	2.4
	30.0	3.4	2.5	3.5	2.5	3.6	2.5	3.7	2.5	3.7	2.5	3.9	2.5	4.0	2.4
	32.5	3.3	2.4	3.4	2.5	3.6	2.4	3.6	2.5	3.7	2.5	3.9	2.5	4.0	2.4
	35.0	3.3	2.4	3.4	2.5	3.5	2.4	3.6	2.4	3.7	2.5	3.8	2.5	4.0	2.4
	37.5	3.3	2.4	3.3	2.5	3.5	2.4	3.6	2.4	3.6	2.5	3.8	2.4	3.9	2.4
	40.0	3.2	2.4	3.3	2.4	3.5	2.4	3.5	2.4	3.6	2.5	3.7	2.4	3.9	2.4
43.0	3.2	2.4	3.3	2.4	3.4	2.4	3.5	2.4	3.6	2.5	3.7	2.4	3.8	2.3	
40 (4.5)	20.0	4.4	3.2	4.5	3.2	4.7	3.2	4.8	3.2	4.9	3.3	5.0	3.2	5.2	3.1
	22.5	4.4	3.2	4.5	3.2	4.6	3.1	4.7	3.2	4.8	3.3	5.0	3.2	5.2	3.1
	25.0	4.3	3.1	4.4	3.2	4.6	3.1	4.7	3.1	4.8	3.2	5.0	3.2	5.1	3.1
	27.5	4.3	3.1	4.4	3.2	4.5	3.1	4.6	3.1	4.7	3.2	4.9	3.1	5.1	3.0
	30.0	4.2	3.1	4.3	3.2	4.5	3.1	4.6	3.1	4.7	3.2	4.9	3.1	5.0	3.0
	32.5	4.2	3.1	4.3	3.1	4.5	3.1	4.5	3.1	4.6	3.2	4.8	3.1	5.0	3.0
	35.0	4.1	3.0	4.2	3.1	4.4	3.0	4.5	3.1	4.6	3.2	4.8	3.1	5.0	3.0
	37.5	4.1	3.0	4.2	3.1	4.4	3.0	4.5	3.0	4.5	3.1	4.7	3.1	4.9	3.0
	40.0	4.1	3.0	4.1	3.1	4.3	3.0	4.4	3.0	4.5	3.1	4.7	3.0	4.9	3.0
43.0	4.0	3.0	4.1	3.0	4.3	3.0	4.4	3.0	4.4	3.1	4.6	3.0	4.8	2.9	
50 (5.6)	20.0	5.5	4.0	5.6	4.1	5.8	4.0	5.9	4.0	6.0	4.2	6.3	4.0	6.5	3.9
	22.5	5.4	4.0	5.5	4.1	5.8	4.0	5.9	4.0	6.0	4.1	6.2	4.0	6.4	3.9
	25.0	5.4	4.0	5.5	4.0	5.7	4.0	5.8	4.0	5.9	4.1	6.2	4.0	6.4	3.9
	27.5	5.3	3.9	5.4	4.0	5.7	3.9	5.8	4.0	5.9	4.1	6.1	4.0	6.3	3.9
	30.0	5.3	3.9	5.4	4.0	5.6	3.9	5.7	3.9	5.8	4.1	6.0	4.0	6.3	3.8
	32.5	5.2	3.9	5.3	4.0	5.5	3.9	5.7	3.9	5.8	4.0	6.0	3.9	6.2	3.8
	35.0	5.2	3.8	5.3	3.9	5.5	3.9	5.6	3.9	5.7	4.0	5.9	3.9	6.2	3.8
	37.5	5.1	3.8	5.2	3.9	5.4	3.8	5.5	3.9	5.7	4.0	5.9	3.9	6.1	3.8
	40.0	5.0	3.8	5.2	3.9	5.4	3.8	5.5	3.8	5.6	4.0	5.8	3.9	6.0	3.8
43.0	5.0	3.8	5.1	3.8	5.3	3.8	5.4	3.8	5.5	3.9	5.8	3.8	6.0	3.7	
63 (7.1)	20.0	7.0	5.0	7.1	5.1	7.4	5.0	7.5	5.0	7.7	5.1	8.0	5.0	8.2	4.8
	22.5	6.9	4.9	7.0	5.0	7.3	4.9	7.5	4.9	7.6	5.1	7.9	4.9	8.2	4.8
	25.0	6.8	4.9	7.0	5.0	7.2	4.9	7.4	4.9	7.5	5.1	7.8	4.9	8.1	4.8
	27.5	6.7	4.9	6.9	5.0	7.2	4.9	7.3	4.9	7.5	5.0	7.7	4.9	8.0	4.7
	30.0	6.7	4.8	6.8	4.9	7.1	4.8	7.2	4.8	7.4	5.0	7.7	4.9	8.0	4.7
	32.5	6.6	4.8	6.7	4.9	7.0	4.8	7.2	4.8	7.3	5.0	7.6	4.8	7.9	4.7
	35.0	6.5	4.8	6.7	4.9	7.0	4.8	7.1	4.8	7.2	4.9	7.5	4.8	7.8	4.7
	37.5	6.5	4.7	6.6	4.8	6.9	4.7	7.0	4.8	7.2	4.9	7.5	4.8	7.7	4.6
	40.0	6.4	4.7	6.5	4.8	6.8	4.7	7.0	4.7	7.1	4.9	7.4	4.8	7.7	4.6
43.0	6.3	4.6	6.4	4.7	6.7	4.7	6.9	4.7	7.0	4.8	7.3	4.7	7.6	4.6	

PFFY-P-VLEM-A-VLRM-A

2-4.Heating Capacity (In combination with PU(H)Y, PURY-(P)200-250-315YEM-A, TEM-A)

PFFY-P-VLEM-A,VLRM-A

SHC:Sensible Heat Capacity(kW)

Unit size	Outdoor air temp.	Indoor air temp.:°CDB			
		15.0	20.0	25.0	27.0
		°CWB	SHC	SHC	SHC
20	-15.0	1.7	1.6	1.6	1.6
	-10.0	1.9	1.9	1.9	1.7
	-5.0	2.1	2.1	2.0	1.7
	0.0	2.4	2.4	2.0	1.7
	2.5	2.5	2.5	2.0	1.7
	6.0	2.5	2.5	2.0	1.7
	7.5	2.6	2.5	2.0	1.7
	10.0	2.8	2.5	2.0	1.7
	12.5	3.0	2.5	2.0	1.7
15.5	3.0	2.5	2.0	1.7	
25	-15.0	2.1	2.1	2.1	2.1
	-10.0	2.4	2.4	2.4	2.2
	-5.0	2.7	2.7	2.5	2.2
	0.0	3.1	3.0	2.5	2.2
	2.5	3.2	3.2	2.5	2.2
	6.0	3.2	3.2	2.5	2.2
	7.5	3.4	3.2	2.5	2.2
	10.0	3.6	3.2	2.5	2.2
	12.5	3.8	3.2	2.5	2.2
15.5	3.9	3.2	2.5	2.2	
32	-15.0	2.7	2.6	2.6	2.6
	-10.0	3.1	3.0	3.0	2.8
	-5.0	3.4	3.4	3.1	2.8
	0.0	3.8	3.8	3.1	2.8
	2.5	4.0	4.0	3.1	2.8
	6.0	4.0	4.0	3.1	2.8
	7.5	4.2	4.0	3.1	2.8
	10.0	4.5	4.0	3.1	2.8
	12.5	4.8	4.0	3.1	2.8
15.5	4.8	4.0	3.1	2.8	

Unit size	Outdoor air temp.	Indoor air temp.:°CDB			
		15.0	20.0	25.0	27.0
		°CWB	SHC	SHC	SHC
40	-15.0	3.3	3.3	3.3	3.3
	-10.0	3.8	3.8	3.7	3.5
	-5.0	4.3	4.2	3.9	3.5
	0.0	4.8	4.7	3.9	3.5
	2.5	5.0	5.0	3.9	3.5
	6.0	5.1	5.0	3.9	3.5
	7.5	5.3	5.0	3.9	3.5
	10.0	5.6	5.0	3.9	3.5
	12.5	6.0	5.0	3.9	3.5
15.5	6.1	5.0	3.9	3.5	
50	-15.0	4.2	4.2	4.1	4.1
	-10.0	4.8	4.8	4.7	4.3
	-5.0	5.4	5.3	4.9	4.3
	0.0	6.0	5.9	4.9	4.3
	2.5	6.3	6.2	4.9	4.3
	6.0	6.4	6.3	4.9	4.3
	7.5	6.6	6.3	4.9	4.3
	10.0	7.1	6.3	4.9	4.3
	12.5	7.5	6.3	4.9	4.3
15.5	7.6	6.3	4.9	4.3	
63	-15.0	5.4	5.3	5.2	5.2
	-10.0	6.1	6.0	6.0	5.5
	-5.0	6.9	6.8	6.2	5.5
	0.0	7.6	7.5	6.2	5.5
	2.5	8.0	7.9	6.2	5.5
	6.0	8.1	8.0	6.2	5.5
	7.5	8.4	8.0	6.2	5.5
	10.0	9.0	8.0	6.2	5.5
	12.5	9.6	8.0	6.2	5.5
15.5	9.7	8.0	6.2	5.5	

PFFY-P-VLEM-A/VLRM-A

2-5.Cooling Capacity (In combination with Big Y, Super Y, Big R2)

PFFY-P-VLEM-A, VLRM-A

CA:Capacity(kW)
SHC:Sensible Heat Capacity(kW)

Unit size	Outdoor air temp.	Indoor air temp.											
		21.5°CDB 15°CWB		23°CDB 16°CWB		25°CDB 18°CWB		28°CDB 20°CWB		30°CDB 22°CWB		32°CDB 24°CWB	
		°CDB	CA	SHC	CA	SHC	CA	SHC	CA	SHC	CA	SHC	CA
20	20.0	2.0	1.8	2.1	1.9	2.3	1.9	2.4	2.1	2.6	2.0	2.7	2.0
	22.5	2.0	1.8	2.1	1.9	2.3	1.9	2.4	2.1	2.6	2.0	2.7	2.0
	25.0	2.0	1.8	2.1	1.9	2.2	1.9	2.4	2.0	2.5	2.0	2.7	2.0
	27.5	2.0	1.8	2.1	1.9	2.2	1.9	2.4	2.0	2.5	2.0	2.6	2.0
	30.0	2.0	1.8	2.1	1.9	2.2	1.9	2.3	2.0	2.5	2.0	2.6	2.0
	32.5	2.0	1.8	2.0	1.9	2.2	1.9	2.3	2.0	2.4	2.0	2.6	2.0
	35.0	1.9	1.8	2.0	1.9	2.1	1.9	2.3	2.0	2.4	2.0	2.5	1.9
	37.5	1.9	1.8	2.0	1.9	2.1	1.9	2.2	2.0	2.4	2.0	2.5	1.9
	40.0	1.9	1.8	2.0	1.9	2.1	1.8	2.2	2.0	2.3	2.0	2.4	1.9
43.0	1.9	1.8	1.9	1.9	2.1	1.8	2.2	2.0	2.3	1.9	2.4	1.9	
25	20.0	2.6	2.1	2.7	2.2	2.9	2.2	3.1	2.3	3.3	2.3	3.5	2.3
	22.5	2.6	2.1	2.7	2.2	2.9	2.2	3.1	2.3	3.3	2.3	3.4	2.2
	25.0	2.6	2.1	2.7	2.2	2.9	2.2	3.0	2.3	3.2	2.3	3.4	2.2
	27.5	2.5	2.1	2.6	2.2	2.8	2.2	3.0	2.3	3.2	2.3	3.3	2.2
	30.0	2.5	2.1	2.6	2.2	2.8	2.1	3.0	2.3	3.1	2.2	3.3	2.2
	32.5	2.5	2.1	2.6	2.1	2.8	2.1	2.9	2.3	3.1	2.2	3.2	2.2
	35.0	2.5	2.1	2.6	2.1	2.7	2.1	2.9	2.2	3.0	2.2	3.2	2.2
	37.5	2.5	2.0	2.5	2.1	2.7	2.1	2.8	2.2	3.0	2.2	3.1	2.1
	40.0	2.4	2.0	2.5	2.1	2.7	2.1	2.8	2.2	3.0	2.2	3.1	2.1
43.0	2.4	2.0	2.5	2.1	2.6	2.1	2.8	2.2	2.9	2.2	3.0	2.1	
32	20.0	3.3	2.4	3.5	2.5	3.7	2.5	4.0	2.7	4.2	2.6	4.5	2.6
	22.5	3.3	2.4	3.5	2.5	3.7	2.5	4.0	2.6	4.2	2.6	4.4	2.6
	25.0	3.3	2.4	3.4	2.5	3.7	2.5	3.9	2.6	4.1	2.6	4.4	2.5
	27.5	3.3	2.4	3.4	2.5	3.6	2.5	3.9	2.6	4.1	2.6	4.3	2.5
	30.0	3.2	2.4	3.4	2.5	3.6	2.5	3.8	2.6	4.0	2.5	4.2	2.5
	32.5	3.2	2.4	3.3	2.4	3.5	2.4	3.8	2.6	4.0	2.5	4.2	2.5
	35.0	3.2	2.4	3.3	2.4	3.5	2.4	3.7	2.5	3.9	2.5	4.1	2.4
	37.5	3.2	2.3	3.3	2.4	3.5	2.4	3.7	2.5	3.8	2.5	4.0	2.4
	40.0	3.1	2.3	3.2	2.4	3.4	2.4	3.6	2.5	3.8	2.4	4.0	2.4
43.0	3.1	2.3	3.2	2.4	3.4	2.4	3.5	2.5	3.7	2.4	3.9	2.4	
40	20.0	4.1	3.0	4.3	3.2	4.7	3.2	5.0	3.3	5.3	3.3	5.6	3.2
	22.5	4.1	3.0	4.3	3.2	4.6	3.2	4.9	3.3	5.2	3.3	5.5	3.2
	25.0	4.1	3.0	4.3	3.1	4.6	3.1	4.9	3.3	5.2	3.2	5.5	3.2
	27.5	4.1	3.0	4.2	3.1	4.5	3.1	4.8	3.3	5.1	3.2	5.4	3.2
	30.0	4.0	3.0	4.2	3.1	4.5	3.1	4.8	3.2	5.0	3.2	5.3	3.1
	32.5	4.0	3.0	4.2	3.1	4.4	3.1	4.7	3.2	5.0	3.2	5.2	3.1
	35.0	4.0	3.0	4.1	3.1	4.4	3.0	4.6	3.2	4.9	3.1	5.1	3.1
	37.5	3.9	2.9	4.1	3.0	4.3	3.0	4.6	3.2	4.8	3.1	5.1	3.0
	40.0	3.9	2.9	4.0	3.0	4.3	3.0	4.5	3.1	4.7	3.1	5.0	3.0
43.0	3.9	2.9	4.0	3.0	4.2	3.0	4.4	3.1	4.7	3.0	4.9	3.0	
50	20.0	5.2	3.8	5.4	4.0	5.8	4.0	6.2	4.2	6.6	4.2	7.0	4.1
	22.5	5.2	3.8	5.4	4.0	5.8	4.0	6.2	4.2	6.5	4.1	6.9	4.1
	25.0	5.1	3.8	5.3	4.0	5.7	4.0	6.1	4.2	6.4	4.1	6.8	4.0
	27.5	5.1	3.8	5.3	3.9	5.6	3.9	6.0	4.1	6.3	4.1	6.7	4.0
	30.0	5.0	3.8	5.2	3.9	5.6	3.9	5.9	4.1	6.2	4.0	6.6	4.0
	32.5	5.0	3.8	5.2	3.9	5.5	3.9	5.8	4.1	6.2	4.0	6.5	3.9
	35.0	4.9	3.7	5.1	3.9	5.4	3.8	5.8	4.0	6.1	4.0	6.4	3.9
	37.5	4.9	3.7	5.1	3.8	5.4	3.8	5.7	4.0	6.0	3.9	6.3	3.9
	40.0	4.9	3.7	5.0	3.8	5.3	3.8	5.6	4.0	5.9	3.9	6.2	3.8
43.0	4.8	3.7	5.0	3.8	5.2	3.7	5.5	3.9	5.8	3.9	6.1	3.8	
63	20.0	6.5	4.8	6.9	4.9	7.4	5.0	7.9	5.2	8.4	5.1	8.9	5.1
	22.5	6.5	4.8	6.8	4.9	7.3	4.9	7.8	5.2	8.3	5.1	8.7	5.0
	25.0	6.5	4.7	6.8	4.9	7.2	4.9	7.7	5.1	8.1	5.1	8.6	5.0
	27.5	6.4	4.7	6.7	4.9	7.2	4.8	7.6	5.1	8.0	5.0	8.5	4.9
	30.0	6.4	4.7	6.6	4.8	7.1	4.8	7.5	5.0	7.9	5.0	8.4	4.9
	32.5	6.3	4.7	6.6	4.8	7.0	4.8	7.4	5.0	7.8	4.9	8.2	4.8
	35.0	6.3	4.6	6.5	4.8	6.9	4.7	7.3	5.0	7.7	4.9	8.1	4.8
	37.5	6.2	4.6	6.4	4.7	6.8	4.7	7.2	4.9	7.6	4.8	8.0	4.7
	40.0	6.2	4.6	6.4	4.7	6.7	4.7	7.1	4.9	7.5	4.8	7.9	4.7
43.0	6.1	4.5	6.3	4.7	6.6	4.6	7.0	4.8	7.3	4.7	7.7	4.6	

PFFY-P-VLEM-A

2-6.Heating Capacity (In combination with Big Y, Super Y, Big R2)

PFFY-P-VLEM-A,VLRM-A

Unit size	Outdoor air temp. °CWB	Indoor air temp.:°CDB			
		15	21	25	27
		SHC	SHC	SHC	SHC
20	-15.0	1.6	1.5	1.5	1.5
	-10.0	1.8	1.8	1.7	1.7
	-5.0	2.0	2.0	2.0	1.9
	0.0	2.2	2.2	2.1	1.9
	2.5	2.4	2.3	2.1	1.9
	6.0	2.5	2.5	2.1	1.9
	7.5	2.6	2.5	2.1	1.9
	10.0	2.7	2.5	2.1	1.9
	12.5	2.9	2.5	2.1	1.9
	15.5	2.9	2.5	2.1	1.9
25	-15.0	2.0	2.0	1.9	1.9
	-10.0	2.3	2.2	2.2	2.2
	-5.0	2.6	2.5	2.5	2.5
	0.0	2.9	2.8	2.7	2.5
	2.5	3.0	3.0	2.7	2.5
	6.0	3.2	3.2	2.7	2.5
	7.5	3.3	3.2	2.7	2.5
	10.0	3.5	3.2	2.7	2.5
	12.5	3.7	3.2	2.7	2.5
	15.5	3.7	3.2	2.7	2.5
32	-15.0	2.5	2.5	2.4	2.4
	-10.0	2.8	2.8	2.8	2.7
	-5.0	3.2	3.2	3.1	3.1
	0.0	3.6	3.5	3.4	3.1
	2.5	3.8	3.7	3.4	3.1
	6.0	4.0	4.0	3.4	3.1
	7.5	4.2	4.0	3.4	3.1
	10.0	4.4	4.0	3.4	3.1
	12.5	4.6	4.0	3.4	3.1
	15.5	4.6	4.0	3.4	3.1

SHC:Sensible Heat Capacity(KW)

Unit size	Outdoor air temp. °CWB	Indoor air temp.:°CDB			
		15	21	25	27
		SHC	SHC	SHC	SHC
40	-15.0	3.1	3.1	3.0	3.0
	-10.0	3.6	3.5	3.5	3.4
	-5.0	4.0	4.0	3.9	3.9
	0.0	4.5	4.4	4.3	3.9
	2.5	4.7	4.7	4.3	3.9
	6.0	5.0	5.0	4.3	3.9
	7.5	5.2	5.0	4.3	3.9
	10.0	5.4	5.0	4.3	3.9
	12.5	5.7	5.0	4.3	3.9
	15.5	5.8	5.0	4.3	3.9
50	-15.0	3.9	3.9	3.8	3.7
	-10.0	4.5	4.4	4.3	4.3
	-5.0	5.0	5.0	4.9	4.9
	0.0	5.6	5.6	5.4	4.9
	2.5	5.9	5.9	5.4	4.9
	6.0	6.4	6.3	5.4	4.9
	7.5	6.6	6.3	5.4	4.9
	10.0	6.9	6.3	5.4	4.9
	12.5	7.2	6.3	5.4	4.9
	15.5	7.2	6.3	5.4	4.9
63	-15.0	5.0	4.9	4.8	4.7
	-10.0	5.7	5.6	5.5	5.4
	-5.0	6.4	6.3	6.2	6.2
	0.0	7.2	7.1	6.8	6.2
	2.5	7.5	7.5	6.8	6.2
	6.0	8.1	8.0	6.8	6.2
	7.5	8.3	8.0	6.8	6.2
	10.0	8.7	8.0	6.8	6.2
	12.5	9.1	8.0	6.8	6.2
	15.5	9.2	8.0	6.8	6.2

2-7.Cooling Capacity (In combination with WY, WR2)

CA:Capacity(kW)
SHC:Sensible Heat Capacity(kW)

PFFY-P-VLEM-A,VLRM-A

Unit size	Water temp.	Indoor air temp.													
		21.5°CDB 15°CWB		23°CDB 16°CWB		25°CDB 18°CWB		27°CDB 19°CWB		28°CDB 20°CWB		30°CDB 22°CWB		32°CDB 24°CWB	
	°C	CA	SHC	CA	SHC	CA	SHC	CA	SHC	CA	SHC	CA	SHC	CA	SHC
20	10	2.1	1.9	2.2	2.0	2.4	2.0	2.4	2.0	2.5	2.1	2.6	2.1	2.8	2.0
	20	2.1	1.9	2.1	1.9	2.3	1.9	2.3	2.0	2.4	2.1	2.5	2.0	2.7	2.0
	30	2.0	1.8	2.0	1.9	2.1	1.9	2.2	1.9	2.3	2.0	2.4	2.0	2.5	1.9
	40	1.7	1.7	1.8	1.8	1.9	1.8	1.9	1.8	2.0	1.9	2.1	1.9	2.2	1.8
	45	1.6	1.7	1.7	1.7	1.8	1.7	1.8	1.8	1.9	1.9	2.0	1.8	2.1	1.8
25	10	2.7	2.2	2.8	2.2	3.0	2.2	3.1	2.3	3.2	2.4	3.3	2.3	3.5	2.3
	20	2.6	2.1	2.7	2.2	2.9	2.2	3.0	2.2	3.1	2.3	3.2	2.3	3.4	2.2
	30	2.5	2.1	2.6	2.1	2.7	2.1	2.8	2.2	2.9	2.2	3.0	2.2	3.2	2.2
	40	2.2	1.9	2.2	2.0	2.4	2.0	2.4	2.0	2.5	2.1	2.6	2.1	2.8	2.0
	45	2.0	1.9	2.1	1.9	2.2	1.9	2.3	2.0	2.4	2.0	2.5	2.0	2.6	2.0
32	10	3.5	2.5	3.6	2.6	3.9	2.6	4.0	2.6	4.1	2.7	4.3	2.6	4.5	2.6
	20	3.4	2.5	3.5	2.5	3.7	2.5	3.8	2.5	3.9	2.6	4.1	2.6	4.4	2.5
	30	3.2	2.4	3.3	2.4	3.5	2.4	3.6	2.4	3.7	2.5	3.9	2.5	4.1	2.4
	40	2.8	2.2	2.9	2.2	3.1	2.2	3.1	2.2	3.2	2.3	3.4	2.3	3.6	2.3
	45	2.6	2.1	2.7	2.2	2.9	2.1	3.0	2.2	3.0	2.3	3.2	2.2	3.4	2.2
40	10	4.4	3.2	4.5	3.3	4.8	3.2	5.0	3.3	5.1	3.4	5.4	3.3	5.7	3.3
	20	4.2	3.1	4.4	3.2	4.6	3.2	4.8	3.2	4.9	3.3	5.2	3.2	5.5	3.2
	30	4.0	3.0	4.1	3.1	4.4	3.0	4.5	3.1	4.6	3.2	4.9	3.1	5.2	3.1
	40	3.5	2.7	3.6	2.8	3.8	2.8	3.9	2.8	4.0	2.9	4.3	2.9	4.5	2.8
	45	3.3	2.6	3.4	2.7	3.6	2.7	3.7	2.7	3.8	2.8	4.0	2.8	4.2	2.8
50	10	5.5	4.0	5.6	4.1	6.0	4.1	6.2	4.1	6.3	4.3	6.7	4.2	7.1	4.1
	20	5.3	3.9	5.4	4.0	5.8	4.0	5.9	4.0	6.1	4.2	6.5	4.1	6.8	4.0
	30	5.0	3.8	5.1	3.9	5.5	3.8	5.6	3.9	5.8	4.0	6.1	4.0	6.4	3.9
	40	4.3	3.4	4.5	3.6	4.7	3.5	4.9	3.6	5.0	3.7	5.3	3.7	5.6	3.6
	45	4.1	3.3	4.2	3.4	4.5	3.4	4.6	3.5	4.7	3.6	5.0	3.6	5.3	3.5
63	10	6.9	5.0	7.2	5.1	7.6	5.1	7.8	5.1	8.0	5.3	8.5	5.2	9.0	5.1
	20	6.7	4.8	6.9	5.0	7.3	4.9	7.5	5.0	7.8	5.2	8.2	5.1	8.6	5.0
	30	6.3	4.6	6.5	4.8	6.9	4.7	7.1	4.8	7.3	5.0	7.7	4.9	8.1	4.8
	40	5.5	4.2	5.7	4.4	6.0	4.3	6.2	4.4	6.4	4.6	6.7	4.5	7.1	4.4
	45	5.2	4.1	5.3	4.2	5.7	4.2	5.8	4.3	6.0	4.4	6.3	4.4	6.7	4.3

2-8.Heating Capacity (In combination with WY, WR2)

SHC:Sensible Heat Capacity(kW)

PFFY-P-VLEM-A,VLRM-A

Unit size	Water temp.	Indoor air temp.:°CDB				
		15	19	20	25	27
	°C	SHC(kW)	SHC(kW)	SHC(kW)	SHC(kW)	SHC(kW)
20	10	2.2	2.2	2.1	1.7	1.5
	20	2.6	2.6	2.5	2.0	1.8
	30	2.6	2.6	2.5	2.0	1.8
	40	2.7	2.7	2.6	2.1	1.9
	45	2.9	2.9	2.9	2.3	2.1
25	10	2.8	2.8	2.7	2.2	2.0
	20	3.3	3.3	3.2	2.6	2.3
	30	3.3	3.3	3.2	2.6	2.3
	40	3.4	3.4	3.3	2.7	2.4
	45	3.8	3.7	3.6	2.9	2.6
32	10	3.5	3.5	3.4	2.7	2.4
	20	4.1	4.1	4.0	3.2	2.9
	30	4.1	4.1	4.0	3.2	2.9
	40	4.3	4.2	4.2	3.3	3.0
	45	4.7	4.7	4.6	3.6	3.3
40	10	4.4	4.3	4.3	3.4	3.1
	20	5.2	5.1	5.0	4.0	3.6
	30	5.2	5.1	5.0	4.0	3.6
	40	5.4	5.3	5.2	4.2	3.7
	45	5.9	5.8	5.7	4.6	4.1
50	10	5.5	5.5	5.4	4.3	3.9
	20	6.5	6.4	6.3	5.0	4.5
	30	6.5	6.4	6.3	5.0	4.5
	40	6.7	6.7	6.6	5.2	4.7
	45	7.4	7.3	7.2	5.7	5.2
63	10	7.0	6.9	6.8	5.4	4.9
	20	8.2	8.2	8.0	6.4	5.8
	30	8.2	8.2	8.0	6.4	5.8
	40	8.6	8.5	8.3	6.7	6.0
	45	9.4	9.3	9.1	7.3	6.6

PFFY-P-VLEM-A,VLRM-A

3. Sound Levels

3-1. Noise level

Floor standing

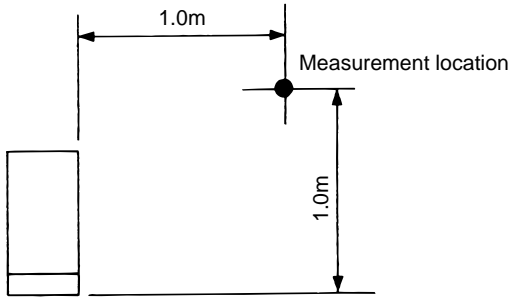

Noise level at anechoic room (Low-High)

Unit : dB(A)

Model	Noise level (A weighted)
PFFY-P20VLEM-A PFFY-P20VLRM-A PFFY-P25VLEM-A PFFY-P25VLRM-A	34-40
PFFY-P32VLEM-A PFFY-P32VLRM-A	35-40
PFFY-P40VLEM-A PFFY-P40VLRM-A PFFY-P50VLEM-A PFFY-P50VLRM-A	38-43
PFFY-P63VLEM-A PFFY-P63VLRM-A	40-46

3-2. NC curves

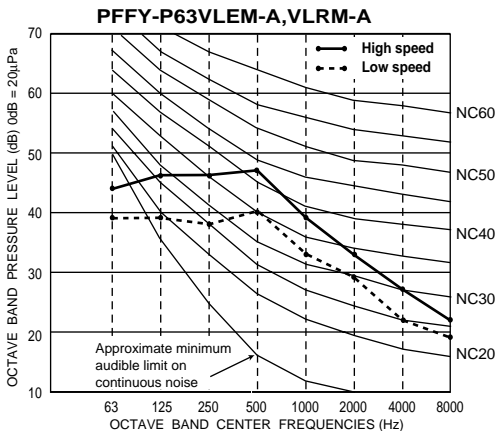
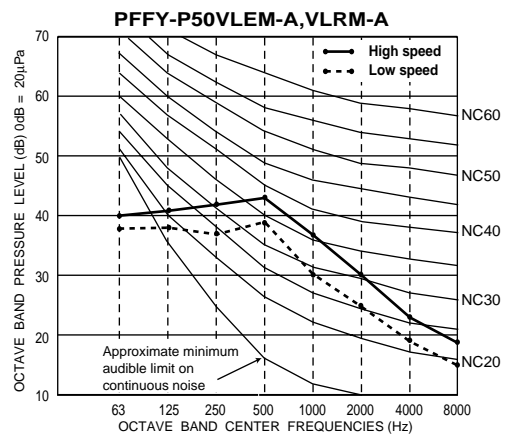
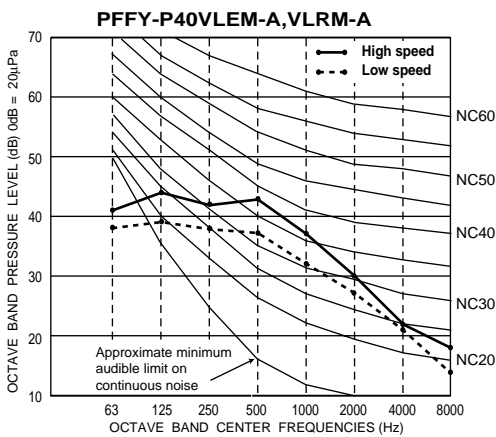
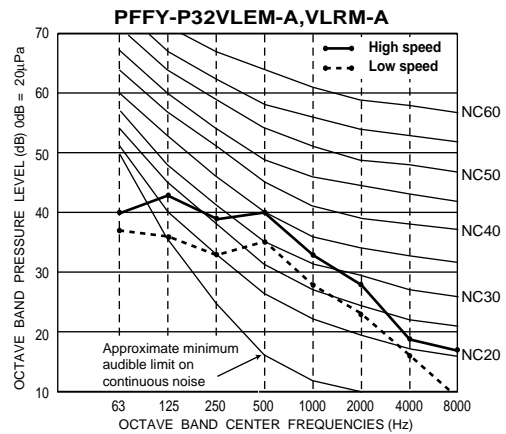
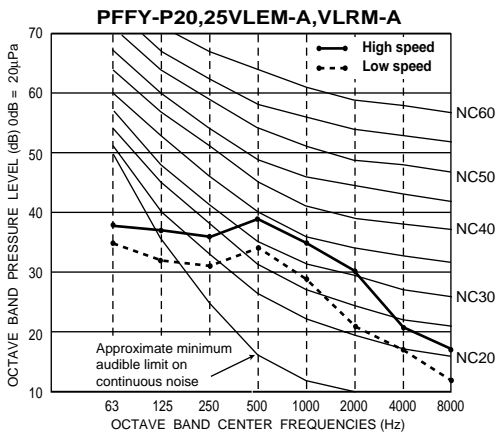

PFFY-P-VLEM-A/VLRM-A

4. External Dimensions

PFFY-P20,25,32,40,50,
63VLEM-A

Unit : mm

Dimensions

Model	A	B	C	D	E (Gas)	F (Liquid)
PFFY-P20VLEM-A	1050	640	600	610	φ12.7	φ6.35
PFFY-P25VLEM-A	1050	640	600	610	φ12.7	φ6.35
PFFY-P32VLEM-A	1170	760	720	730	φ12.7	φ6.35
PFFY-P40VLEM-A	1170	760	720	730	φ12.7	φ6.35
PFFY-P50VLEM-A	1410	1000	960	970	φ15.88	φ9.52
PFFY-P63VLEM-A	1410	1000	960	970	φ15.88	φ9.52

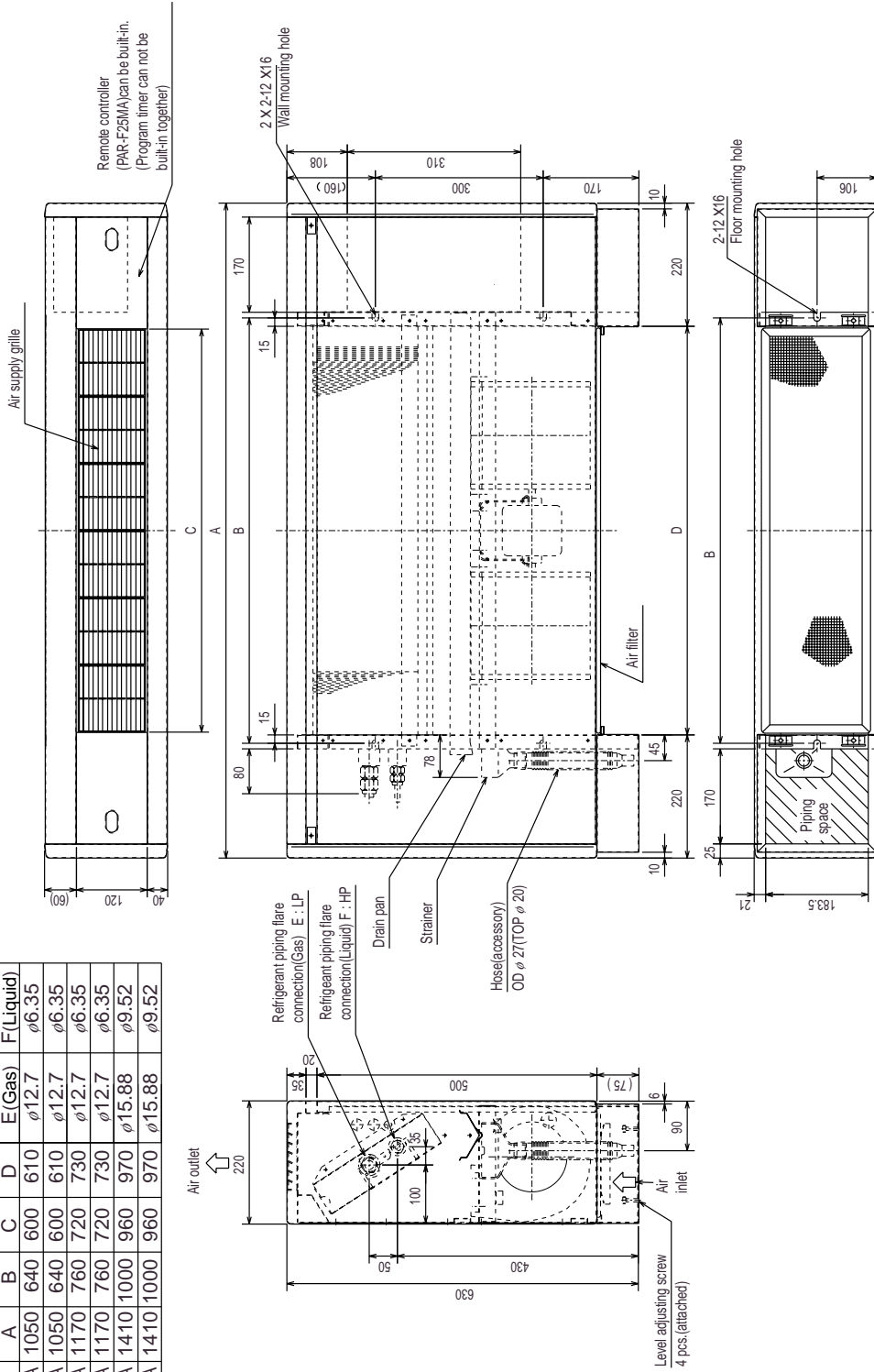

PFFY-P-
VLEM-A/VRM-A

PFFY-P20,25,32,40,50,
63VLRM-A

Unit : mm

Dimensions

Model	A	B	C	D	E	F	G(Gas)	H(Liquid)
PFFY-P20VLRM-A	886	640	572	610	360	4	ø12.7	ø6.35
PFFY-P25VLRM-A	886	640	572	610	360	4	ø12.7	ø6.35
PFFY-P32VLRM-A	1006	760	692	730	480	5	ø12.7	ø6.35
PFFY-P40VLRM-A	1006	760	692	730	480	5	ø12.7	ø6.35
PFFY-P50VLRM-A	1246	1000	932	970	720	7	ø15.88	ø9.52
PFFY-P63VLRM-A	1246	1000	932	970	720	7	ø15.88	ø9.52

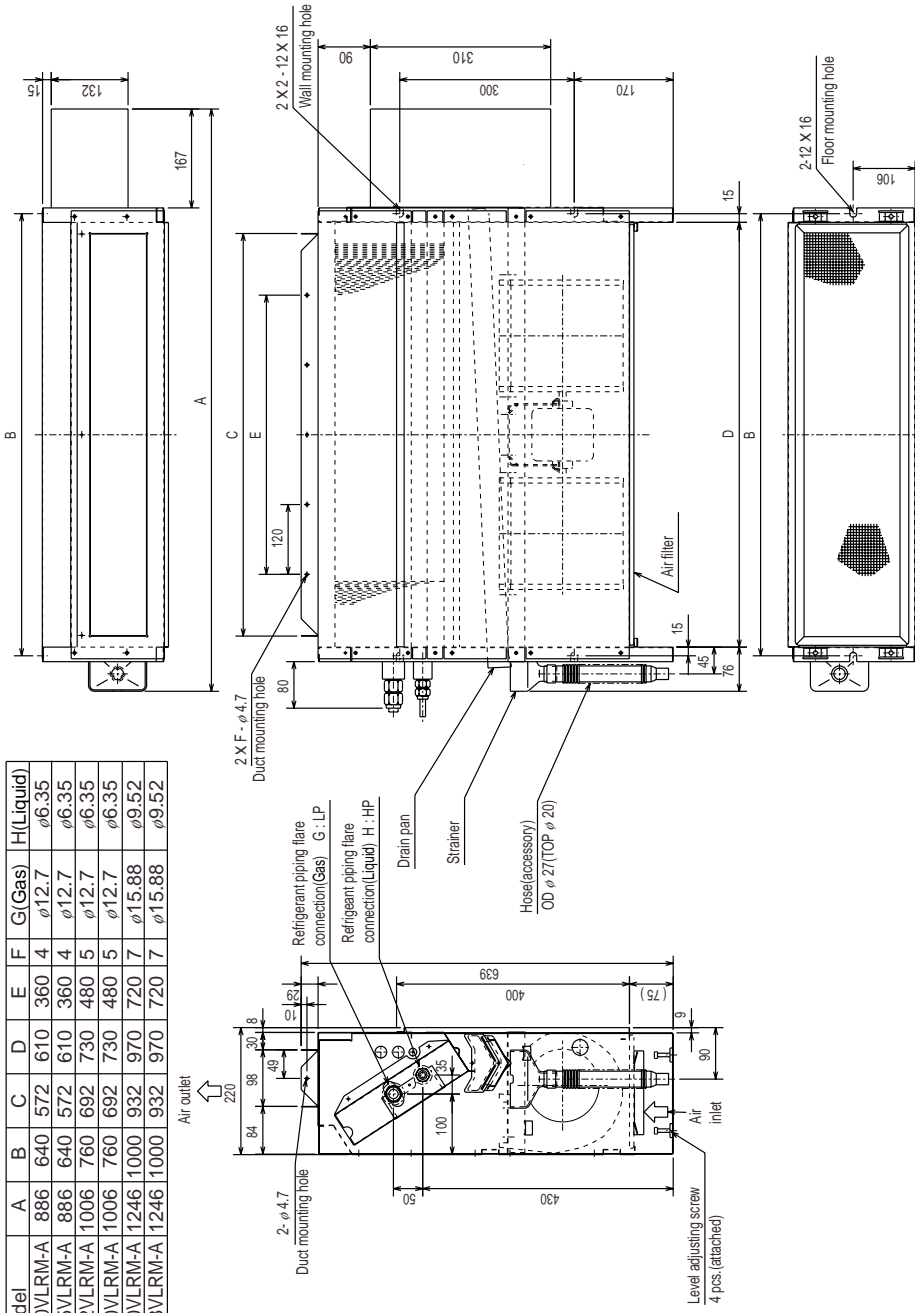

5. Electrical Wiring Diagram

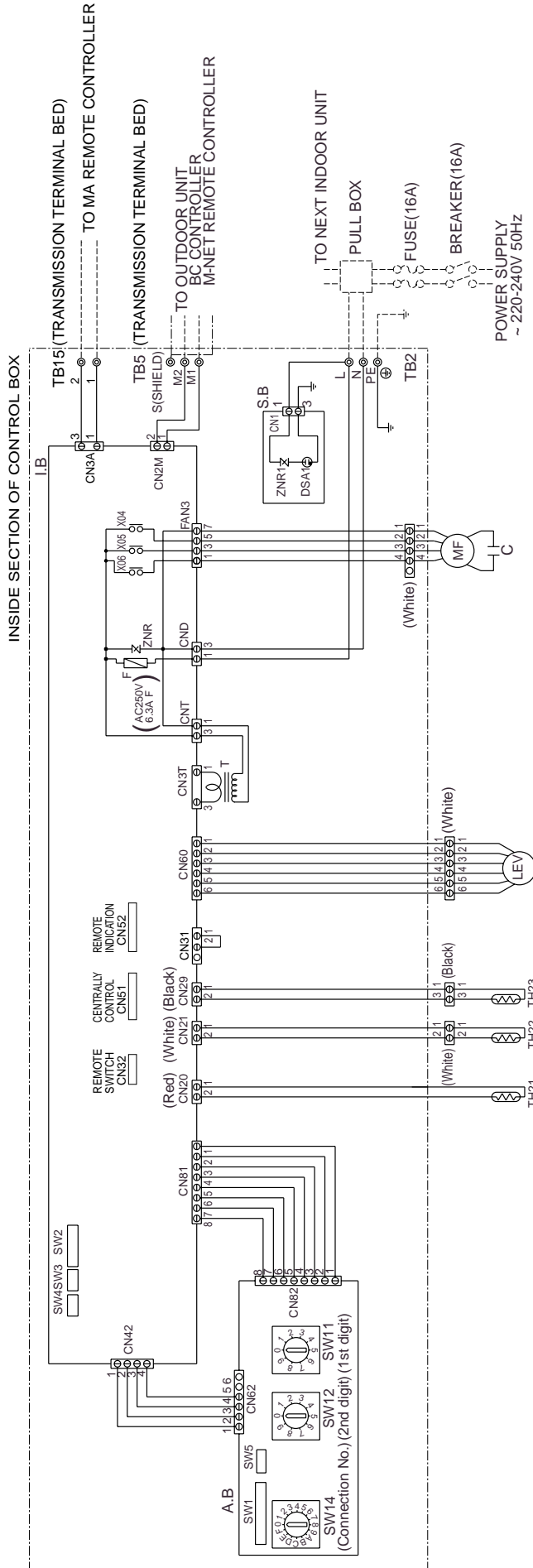

SYMBOL EXPLANATION

SYMBOL	NAME	SYMBOL	NAME
MF	Fan motor	TH 22	Thermistor (piping temp.detection/liquid)
C	*Capacitor (for MF)	TH 23	Thermistor (piping temp.detection/gas)
I . B	Indoor controller board	SW 1 1 (A . B)	Switch (1st digit address set)
A . B	Address board	SW 1 2 (A . B)	Switch (2nd digit address set)
TB 2	Power source terminal bed	SW 1 4 (A . B)	Switch (connection No.set)
TB 5	Transmission terminal bed	SW 1 (A . B)	Switch(for mode selection)
TB 1 5	Transmission terminal bed	SW 2 (I . B)	Switch(for capacity code)
F	Fuse AC250V 6.3A F	SW 3 (I . B)	Switch(for mode selection)
T	Transformer	SW 4 (I . B)	Switch(for model selection)
LEV	Electronic linear expan. valve	SW 5 (A . B)	Switch(for voltage selection)
S . B	Surge absorber board	X 0 4 - 0 6	Aux.relay
TH 2 1	Thermistor (inlet temp.detection)		

*Capacitor
 MODELS 20/25/32/40 1.5uF
 MODEL 50 2.0uF
 MODEL 63 2.5uF



6. Temperature/Airflow distribution

● Temperature distribution

<Cooling mode>

Room temp. : 27°C

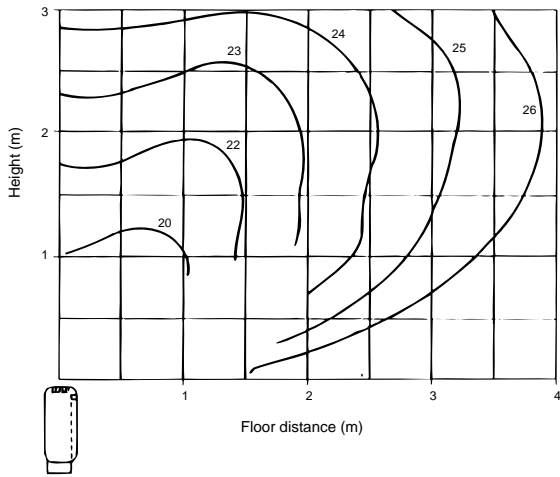

<Heating mode>

Room temp. : 20°C

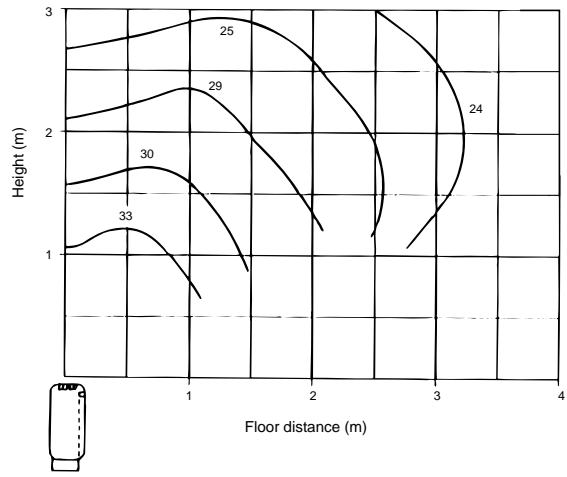

● Airflow distribution

<Cooling mode>

Room temp. : 27°C

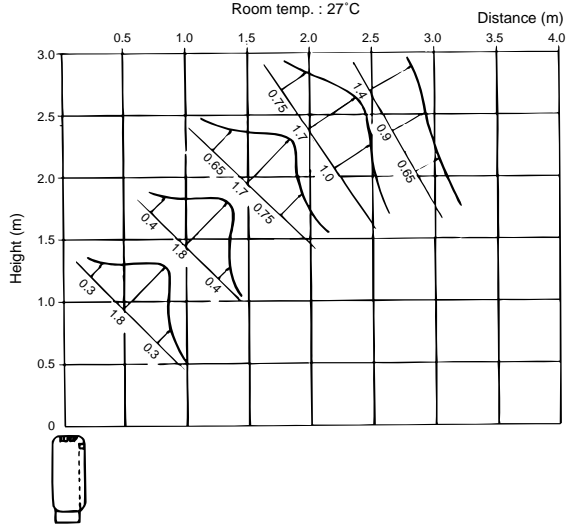

<Heating mode>

Room temp. : 20°C

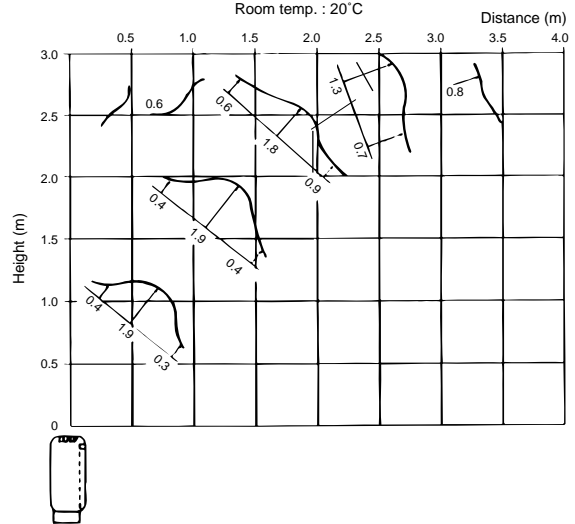

PFFP-VLEM-A/VLRM-A

CONTENTS

1. Specifications	II -116
2. Capacity Tables	II -117
2-1 Cooling Capacity(PUMY)	II -117
2-2 Heating Capacity(PUMY)	II -117
2-3 Cooling Capacity(Y/R2-8-10-13HP)	II -118
2-4 Heating Capacity(Y/R2-8-10-13HP)	II -118
2-5 Cooling Capacity(Big Y, Super Y, Big R2)	II -119
2-6 Heating Capacity(Big Y, Super Y, Big R2)	II -119
2-7 Cooling Capacity(WY, WR2)	II -120
2-8 Heating Capacity(WY, WR2)	II -120
3. Sound Levels	II -121
3-1 Noise levels	II -121
3-2 N/C curves	II -121
4. External Dimension	II -122
5. Electrical Wiring Diagram	II -123
6. Temperature/Airflow distribution	II -124
7. Options	II -125

1. Specifications

			PMFY-P20VBM-A	PMFY-P25VBM-A	PMFY-P32VBM-A	PMFY-P40VBM-A
Power source			~220-240V 50Hz / ~ 200V 60Hz			
Cooling capacity	*1	kW	2.2	2.8	3.6	4.5
	*2	kcal/h	2,000	2,500	3,150	4,000
Heating capacity	*1	kW	2.5	3.2	4.0	5.0
Power consumption	Cooling	kW	0.042	0.044		0.054
	Heating	kW	0.042	0.044		0.054
Current	Cooling	A	0.20	0.21		0.26
	Heating	A	0.20	0.21		0.26
External finish			Panel : 0.98Y8.99/0.63			
Dimension *3	Height	mm	230 (30)			
	Width	mm	812 (1000)			
	Depth	mm	395 (470)			
Net weight *3		kg	14 (3.0)			
Heat exchanger			Cross fin (Aluminum plate fin and copper tube)			
Fan	Type		Line flow fan X 1			
	Airflow rate (Low-Mid2-Mid1-High) *3	m ³ /min	6.5-7.2-8.0-8.7	7.3-8.0-8.6-9.3		7.7-8.7-9.7-10.7
	External static pressure	Pa	0			
Motor	Type		Single phase induction motor			
	Output	kW	0.028			
Air filter			PP Honeycomb fabric			
Refrigerant pipe dimension	Gas (Flare)	mm	ø 12.7			
	Liquid (Flare)	mm	ø 6.35			
Drain pipe dimension			VP-20			
Noise level (Low-Mid2-Mid1-High) *4		dB(A)	27-30-33-35	32-34-36-37		33-35-37-39

Note: *1 Cooling/Heating capacity indicates the maximum value at operation under the following condition.

Cooling : Indoor 27°CDB/19°CWB, Outdoor 35°CDB

Heating : Indoor 20°CDB, Outdoor 7°CDB/6°CWB

*2 Cooling capacity indicates the maximum value at operation under the following condition.

Cooling : Indoor 27°CDB/19.5°CWB, Outdoor 35°CDB (WR2: water 30°C)

*3 External dimension / net weight are shown in (panel), and airflow rate/noise level are in (low-middle2-middle1-high).

*4 It is measured in anechoic room.

2. Capacity Tables

2-1.Cooling Capacity (In combination with PUMY)

PMFY-P-VBM-A

CA:Capacity(kW)
SHC:Sensible Heat Capacity(kW)

Unit size	Outdoor air temp. °CDB	Indoor air temp.							
		23°CDB 16°CWB		25°CDB 18°CWB		28°CDB 20°CWB		30°CDB 22°CWB	
		CA	SHC	CA	SHC	CA	SHC	CA	SHC
20 (2.2)	20.0	2.2	1.9	2.3	1.9	2.4	1.9	2.6	2.0
	22.5	2.1	1.8	2.3	1.9	2.4	1.9	2.6	2.0
	25.0	2.1	1.8	2.3	1.9	2.4	1.9	2.5	2.0
	27.5	2.1	1.8	2.2	1.9	2.4	1.9	2.5	2.0
	30.0	2.1	1.8	2.2	1.9	2.3	1.9	2.5	2.0
	32.5	2.0	1.8	2.2	1.9	2.3	1.9	2.5	1.9
	35.0	2.0	1.8	2.1	1.9	2.3	1.9	2.4	1.9
	37.5	2.0	1.8	2.1	1.9	2.2	1.8	2.4	1.9
	40.0	2.0	1.8	2.1	1.8	2.2	1.8	2.4	1.9
46.0	1.9	1.7	2.0	1.8	2.1	1.8	2.3	1.9	
25 (2.8)	20.0	2.8	2.3	2.9	2.4	3.1	2.4	3.3	2.4
	22.5	2.7	2.3	2.9	2.4	3.1	2.3	3.2	2.4
	25.0	2.7	2.2	2.9	2.4	3.1	2.3	3.2	2.4
	27.5	2.7	2.2	2.8	2.3	3.0	2.3	3.2	2.4
	30.0	2.6	2.2	2.8	2.3	3.0	2.3	3.2	2.4
	32.5	2.6	2.2	2.8	2.3	2.9	2.3	3.1	2.4
	35.0	2.6	2.2	2.7	2.3	2.9	2.3	3.1	2.4
	37.5	2.5	2.2	2.7	2.3	2.9	2.3	3.0	2.3
	40.0	2.5	2.1	2.7	2.3	2.8	2.2	3.0	2.3
46.0	2.4	2.1	2.6	2.2	2.7	2.2	2.9	2.3	
32 (3.6)	20.0	3.6	2.6	3.7	2.7	4.0	2.7	4.2	2.8
	22.5	3.5	2.6	3.7	2.7	4.0	2.7	4.2	2.8
	25.0	3.5	2.6	3.7	2.7	3.9	2.7	4.1	2.8
	27.5	3.4	2.6	3.6	2.7	3.9	2.7	4.1	2.8
	30.0	3.4	2.5	3.6	2.7	3.8	2.6	4.1	2.7
	32.5	3.3	2.5	3.6	2.7	3.8	2.6	4.0	2.7
	35.0	3.3	2.5	3.5	2.6	3.7	2.6	4.0	2.7
	37.5	3.2	2.5	3.5	2.6	3.7	2.6	3.9	2.7
	40.0	3.2	2.5	3.4	2.6	3.6	2.6	3.9	2.7
46.0	3.1	2.4	3.3	2.5	3.5	2.5	3.7	2.6	
40 (4.5)	20.0	4.5	3.2	4.7	3.4	5.0	3.4	5.3	3.4
	22.5	4.4	3.2	4.6	3.3	5.0	3.3	5.2	3.4
	25.0	4.3	3.2	4.6	3.3	4.9	3.3	5.2	3.4
	27.5	4.3	3.2	4.6	3.3	4.9	3.3	5.1	3.4
	30.0	4.2	3.1	4.5	3.3	4.8	3.2	5.1	3.4
	32.5	4.2	3.1	4.4	3.3	4.7	3.2	5.0	3.3
	35.0	4.1	3.1	4.4	3.2	4.7	3.2	5.0	3.3
	37.5	4.1	3.0	4.3	3.2	4.6	3.2	4.9	3.3
	40.0	4.0	3.0	4.3	3.2	4.5	3.1	4.8	3.2
46.0	3.8	2.9	4.1	3.1	4.3	3.0	4.6	3.2	

2-2.Heating Capacity (In combination with PUMY)

PMFY-P-VBM-A

SHC:Sensible Heat Capacity(kW)

Unit size	Outdoor air temp. °CWB	Indoor air temp.:°CDB			Unit size	Outdoor air temp. °CWB	Indoor air temp.:°CDB		
		15.0	20.0	25.0			15.0	20.0	25.0
		SHC	SHC	SHC			SHC	SHC	SHC
20	-12.0	1.6	1.6	1.5	32	-12.0	2.5	2.5	2.5
	-10.0	1.7	1.6	1.6		-10.0	2.7	2.6	2.6
	-5.0	1.9	1.9	1.9		-5.0	3.1	3.0	3.0
	0.0	2.2	2.1	2.1		0.0	3.5	3.4	3.4
	2.5	2.3	2.3	2.3		2.5	3.7	3.7	3.6
	6.0	2.5	2.5	2.5		6.0	4.0	4.0	3.9
	7.5	2.6	2.6	2.5		7.5	4.2	4.1	4.0
	10.0	2.8	2.7	2.5		10.0	4.4	4.4	4.0
	12.5	2.9	2.8	2.5		12.5	4.7	4.4	4.0
15.5	3.1	2.8	2.5	15.5	4.9	4.4	4.0		
25	-12.0	2.0	2.0	2.0	40	-12.0	3.2	3.1	3.1
	-10.0	2.1	2.1	2.1		-10.0	3.4	3.3	3.2
	-5.0	2.4	2.4	2.4		-5.0	3.8	3.8	3.7
	0.0	2.8	2.8	2.7		0.0	4.3	4.3	4.2
	2.5	3.0	2.9	2.9		2.5	4.6	4.6	4.5
	6.0	3.2	3.2	3.2		6.0	5.0	5.0	4.9
	7.5	3.3	3.3	3.2		7.5	5.2	5.2	5.0
	10.0	3.5	3.5	3.2		10.0	5.5	5.5	5.0
	12.5	3.7	3.5	3.2		12.5	5.9	5.5	5.0
15.5	3.9	3.5	3.2	15.5	6.2	5.5	5.0		

PMFY-P-VBM-A

2-3.Cooling Capacity (In combination with PU(H)Y, PURY-(P)200-250-315YEM-A, TEM-A)

PMFY-P-VBM-A

CA:Capacity(kW)
SHC:Sensible Heat Capacity(kW)

Unit size	Outdoor air temp.	Indoor air temp.													
		21.5°CDB 15°CWB		23°CDB 16°CWB		25°CDB 18°CWB		27°CDB 19°CWB		28°CDB 20°CWB		30°CDB 22°CWB		32°CDB 24°CWB	
		°CDB	CA	SHC	CA	SHC	CA	SHC	CA	SHC	CA	SHC	CA	SHC	CA
20 (2.2)	20.0	2.2	1.8	2.2	1.9	2.3	1.9	2.3	1.9	2.4	2.0	2.5	1.9	2.6	1.9
	22.5	2.1	1.8	2.2	1.9	2.3	1.8	2.3	1.9	2.4	2.0	2.4	1.9	2.5	1.9
	25.0	2.1	1.8	2.2	1.9	2.2	1.8	2.3	1.9	2.3	1.9	2.4	1.9	2.5	1.9
	27.5	2.1	1.8	2.1	1.9	2.2	1.8	2.3	1.9	2.3	1.9	2.4	1.9	2.5	1.9
	30.0	2.1	1.8	2.1	1.9	2.2	1.8	2.2	1.9	2.3	1.9	2.4	1.9	2.5	1.8
	32.5	2.0	1.8	2.1	1.8	2.2	1.8	2.2	1.9	2.3	1.9	2.4	1.9	2.4	1.8
	35.0	2.0	1.8	2.1	1.8	2.2	1.8	2.2	1.8	2.2	1.9	2.3	1.9	2.4	1.8
	37.5	2.0	1.8	2.0	1.8	2.1	1.8	2.2	1.8	2.2	1.9	2.3	1.9	2.4	1.8
	40.0	2.0	1.8	2.0	1.8	2.1	1.8	2.2	1.8	2.2	1.9	2.3	1.9	2.4	1.8
43.0	2.0	1.7	2.0	1.8	2.1	1.8	2.1	1.8	2.2	1.9	2.3	1.8	2.3	1.8	
25 (2.8)	20.0	2.7	2.3	2.8	2.3	2.9	2.3	3.0	2.3	3.0	2.4	3.1	2.3	3.2	2.3
	22.5	2.7	2.2	2.8	2.3	2.9	2.3	2.9	2.3	3.0	2.4	3.1	2.3	3.2	2.3
	25.0	2.7	2.2	2.7	2.3	2.9	2.3	2.9	2.3	3.0	2.4	3.1	2.3	3.2	2.3
	27.5	2.7	2.2	2.7	2.3	2.8	2.2	2.9	2.3	2.9	2.4	3.1	2.3	3.2	2.3
	30.0	2.6	2.2	2.7	2.3	2.8	2.2	2.9	2.3	2.9	2.4	3.0	2.3	3.1	2.2
	32.5	2.6	2.2	2.7	2.3	2.8	2.2	2.8	2.3	2.9	2.3	3.0	2.3	3.1	2.2
	35.0	2.6	2.2	2.6	2.3	2.7	2.2	2.8	2.2	2.9	2.3	3.0	2.3	3.1	2.2
	37.5	2.5	2.2	2.6	2.2	2.7	2.2	2.8	2.2	2.8	2.3	2.9	2.3	3.1	2.2
	40.0	2.5	2.2	2.6	2.2	2.7	2.2	2.7	2.2	2.8	2.3	2.9	2.3	3.0	2.2
43.0	2.5	2.1	2.5	2.2	2.7	2.2	2.7	2.2	2.8	2.3	2.9	2.3	3.0	2.2	
32 (3.6)	20.0	3.5	2.6	3.6	2.7	3.7	2.6	3.8	2.6	3.9	2.7	4.0	2.6	4.2	2.6
	22.5	3.5	2.6	3.6	2.7	3.7	2.6	3.8	2.6	3.9	2.7	4.0	2.6	4.1	2.6
	25.0	3.5	2.6	3.5	2.6	3.7	2.6	3.7	2.6	3.8	2.7	4.0	2.6	4.1	2.5
	27.5	3.4	2.6	3.5	2.6	3.6	2.6	3.7	2.6	3.8	2.7	3.9	2.6	4.1	2.5
	30.0	3.4	2.5	3.5	2.6	3.6	2.6	3.7	2.6	3.7	2.7	3.9	2.6	4.0	2.5
	32.5	3.3	2.5	3.4	2.6	3.6	2.5	3.6	2.6	3.7	2.6	3.9	2.6	4.0	2.5
	35.0	3.3	2.5	3.4	2.6	3.5	2.5	3.6	2.5	3.7	2.6	3.8	2.6	4.0	2.5
	37.5	3.3	2.5	3.3	2.6	3.5	2.5	3.6	2.5	3.6	2.6	3.8	2.6	3.9	2.5
	40.0	3.2	2.5	3.3	2.5	3.5	2.5	3.5	2.5	3.6	2.6	3.7	2.5	3.9	2.5
43.0	3.2	2.5	3.3	2.5	3.4	2.5	3.5	2.5	3.6	2.6	3.7	2.5	3.8	2.5	
40 (4.5)	20.0	4.4	3.2	4.5	3.3	4.7	3.2	4.8	3.2	4.9	3.3	5.0	3.2	5.2	3.1
	22.5	4.4	3.2	4.5	3.3	4.6	3.2	4.7	3.2	4.8	3.3	5.0	3.2	5.2	3.1
	25.0	4.3	3.2	4.4	3.2	4.6	3.2	4.7	3.2	4.8	3.3	5.0	3.2	5.1	3.1
	27.5	4.3	3.1	4.4	3.2	4.5	3.1	4.6	3.2	4.7	3.3	4.9	3.2	5.1	3.1
	30.0	4.2	3.1	4.3	3.2	4.5	3.1	4.6	3.1	4.7	3.2	4.9	3.2	5.0	3.1
	32.5	4.2	3.1	4.3	3.2	4.5	3.1	4.5	3.1	4.6	3.2	4.8	3.1	5.0	3.1
	35.0	4.1	3.1	4.2	3.1	4.4	3.1	4.5	3.1	4.6	3.2	4.8	3.1	5.0	3.0
	37.5	4.1	3.1	4.2	3.1	4.4	3.1	4.5	3.1	4.5	3.2	4.7	3.1	4.9	3.0
	40.0	4.1	3.0	4.1	3.1	4.3	3.0	4.4	3.1	4.5	3.2	4.7	3.1	4.9	3.0
43.0	4.0	3.0	4.1	3.1	4.3	3.0	4.4	3.0	4.4	3.1	4.6	3.1	4.8	3.0	

2-4.Heating Capacity (In combination with PU(H)Y, PURY-(P)200-250-315YEM-A, TEM-A)

PMFY-P-VBM-A

SHC:Sensible Heat Capacity(kW)

Unit size	Outdoor air temp.	Indoor air temp.:°CDB			
		15.0	20.0	25.0	27.0
		°CWB	SHC	SHC	SHC
20	-15.0	1.7	1.6	1.6	1.6
	-10.0	1.9	1.9	1.9	1.7
	-5.0	2.1	2.1	2.0	1.7
	0.0	2.4	2.4	2.0	1.7
	2.5	2.5	2.5	2.0	1.7
	6.0	2.5	2.5	2.0	1.7
	7.5	2.6	2.5	2.0	1.7
	10.0	2.8	2.5	2.0	1.7
	12.5	3.0	2.5	2.0	1.7
15.5	3.0	2.5	2.0	1.7	
25	-15.0	2.1	2.1	2.1	2.1
	-10.0	2.4	2.4	2.4	2.2
	-5.0	2.7	2.7	2.5	2.2
	0.0	3.1	3.0	2.5	2.2
	2.5	3.2	3.2	2.5	2.2
	6.0	3.2	3.2	2.5	2.2
	7.5	3.4	3.2	2.5	2.2
	10.0	3.6	3.2	2.5	2.2
	12.5	3.8	3.2	2.5	2.2
15.5	3.9	3.2	2.5	2.2	
32	-15.0	2.7	2.6	2.6	2.6
	-10.0	3.1	3.0	3.0	2.8
	-5.0	3.4	3.4	3.1	2.8
	0.0	3.8	3.8	3.1	2.8
	2.5	4.0	4.0	3.1	2.8
	6.0	4.0	4.0	3.1	2.8
	7.5	4.2	4.0	3.1	2.8
	10.0	4.5	4.0	3.1	2.8
	12.5	4.8	4.0	3.1	2.8
15.5	4.8	4.0	3.1	2.8	
40	-15.0	3.3	3.3	3.3	3.3
	-10.0	3.8	3.8	3.7	3.5
	-5.0	4.3	4.2	3.9	3.5
	0.0	4.8	4.7	3.9	3.5
	2.5	5.0	5.0	3.9	3.5
	6.0	5.1	5.0	3.9	3.5
	7.5	5.3	5.0	3.9	3.5
	10.0	5.6	5.0	3.9	3.5
	12.5	6.0	5.0	3.9	3.5
15.5	6.1	5.0	3.9	3.5	

2-5.Cooling Capacity (In combination with Big Y, Super Y, Big R2)

PMFY-P-VBM-A

CA:Capacity(kW)
SHC:Sensible Heat Capacity(kW)

Unit size	Outdoor air temp.	21.5°CDB 15°CWB		23°CDB 16°CWB		25°CDB 18°CWB		28°CDB 20°CWB		30°CDB 22°CWB		32°CDB 24°CWB	
		°CDB	CA	SHC	CA	SHC	CA	SHC	CA	SHC	CA	SHC	CA
20	20.0	2.0	1.8	2.1	1.9	2.3	1.9	2.4	2.0	2.6	2.0	2.7	1.9
	22.5	2.0	1.8	2.1	1.9	2.3	1.9	2.4	2.0	2.6	2.0	2.7	1.9
	25.0	2.0	1.8	2.1	1.9	2.2	1.8	2.4	2.0	2.5	1.9	2.7	1.9
	27.5	2.0	1.8	2.1	1.8	2.2	1.8	2.4	2.0	2.5	1.9	2.6	1.9
	30.0	2.0	1.8	2.1	1.8	2.2	1.8	2.3	1.9	2.5	1.9	2.6	1.9
	32.5	2.0	1.8	2.0	1.8	2.2	1.8	2.3	1.9	2.4	1.9	2.6	1.9
	35.0	1.9	1.7	2.0	1.8	2.1	1.8	2.3	1.9	2.4	1.9	2.5	1.9
	37.5	1.9	1.7	2.0	1.8	2.1	1.8	2.2	1.9	2.4	1.9	2.5	1.8
	40.0	1.9	1.7	2.0	1.8	2.1	1.8	2.2	1.9	2.3	1.9	2.4	1.8
43.0	1.9	1.7	1.9	1.8	2.1	1.8	2.2	1.9	2.3	1.9	2.4	1.8	
25	20.0	2.6	2.2	2.7	2.3	2.9	2.3	3.1	2.4	3.3	2.4	3.5	2.4
	22.5	2.6	2.2	2.7	2.3	2.9	2.3	3.1	2.4	3.3	2.4	3.4	2.3
	25.0	2.6	2.2	2.7	2.3	2.9	2.3	3.0	2.4	3.2	2.4	3.4	2.3
	27.5	2.5	2.2	2.6	2.3	2.8	2.2	3.0	2.4	3.2	2.4	3.3	2.3
	30.0	2.5	2.2	2.6	2.2	2.8	2.2	3.0	2.4	3.1	2.3	3.3	2.3
	32.5	2.5	2.1	2.6	2.2	2.8	2.2	2.9	2.4	3.1	2.3	3.2	2.3
	35.0	2.5	2.1	2.6	2.2	2.7	2.2	2.9	2.3	3.0	2.3	3.2	2.3
	37.5	2.5	2.1	2.5	2.2	2.7	2.2	2.8	2.3	3.0	2.3	3.1	2.3
	40.0	2.4	2.1	2.5	2.2	2.7	2.2	2.8	2.3	3.0	2.3	3.1	2.2
43.0	2.4	2.1	2.5	2.2	2.6	2.2	2.8	2.3	2.9	2.3	3.0	2.2	
32	20.0	3.3	2.5	3.5	2.6	3.7	2.6	4.0	2.8	4.2	2.7	4.5	2.7
	22.5	3.3	2.5	3.5	2.6	3.7	2.6	4.0	2.7	4.2	2.7	4.4	2.7
	25.0	3.3	2.5	3.4	2.6	3.7	2.6	3.9	2.7	4.1	2.7	4.4	2.6
	27.5	3.3	2.5	3.4	2.6	3.6	2.6	3.9	2.7	4.1	2.7	4.3	2.6
	30.0	3.2	2.5	3.4	2.6	3.6	2.5	3.8	2.7	4.0	2.6	4.2	2.6
	32.5	3.2	2.5	3.3	2.5	3.5	2.5	3.8	2.7	4.0	2.6	4.2	2.6
	35.0	3.2	2.4	3.3	2.5	3.5	2.5	3.7	2.6	3.9	2.6	4.1	2.5
	37.5	3.2	2.4	3.3	2.5	3.5	2.5	3.7	2.6	3.8	2.6	4.0	2.5
	40.0	3.1	2.4	3.2	2.5	3.4	2.5	3.6	2.6	3.8	2.6	4.0	2.5
43.0	3.1	2.4	3.2	2.5	3.4	2.4	3.5	2.6	3.7	2.5	3.9	2.5	
40	20.0	4.1	3.1	4.3	3.2	4.7	3.2	5.0	3.4	5.3	3.3	5.6	3.3
	22.5	4.1	3.1	4.3	3.2	4.6	3.2	4.9	3.4	5.2	3.3	5.5	3.3
	25.0	4.1	3.1	4.3	3.2	4.6	3.2	4.9	3.3	5.2	3.3	5.5	3.2
	27.5	4.1	3.0	4.2	3.2	4.5	3.1	4.8	3.3	5.1	3.2	5.4	3.2
	30.0	4.0	3.0	4.2	3.1	4.5	3.1	4.8	3.3	5.0	3.2	5.3	3.2
	32.5	4.0	3.0	4.2	3.1	4.4	3.1	4.7	3.2	5.0	3.2	5.2	3.1
	35.0	4.0	3.0	4.1	3.1	4.4	3.1	4.6	3.2	4.9	3.2	5.1	3.1
	37.5	3.9	3.0	4.1	3.1	4.3	3.0	4.6	3.2	4.8	3.1	5.1	3.1
	40.0	3.9	3.0	4.0	3.1	4.3	3.0	4.5	3.2	4.7	3.1	5.0	3.1
43.0	3.9	2.9	4.0	3.0	4.2	3.0	4.4	3.1	4.7	3.1	4.9	3.0	

2-6.Heating Capacity (In combination with Big Y, Super Y, Big R2)

PMFY-P-VBM-A

SHC:Sensible Heat Capacity(kW)

Unit size	Outdoor air temp.	Indoor air temp.:°CDB			
		15	21	25	27
20	°CWB	SHC	SHC	SHC	SHC
	-15.0	1.6	1.5	1.5	1.5
	-10.0	1.8	1.8	1.7	1.7
	-5.0	2.0	2.0	2.0	1.9
	0.0	2.2	2.2	2.1	1.9
	2.5	2.4	2.3	2.1	1.9
	6.0	2.5	2.5	2.1	1.9
	7.5	2.6	2.5	2.1	1.9
	10.0	2.7	2.5	2.1	1.9
	12.5	2.9	2.5	2.1	1.9
15.5	2.9	2.5	2.1	1.9	
25	-15.0	2.0	2.0	1.9	1.9
	-10.0	2.3	2.2	2.2	2.2
	-5.0	2.6	2.5	2.5	2.5
	0.0	2.9	2.8	2.7	2.5
	2.5	3.0	3.0	2.7	2.5
	6.0	3.2	3.2	2.7	2.5
	7.5	3.3	3.2	2.7	2.5
	10.0	3.5	3.2	2.7	2.5
	12.5	3.7	3.2	2.7	2.5
	15.5	3.7	3.2	2.7	2.5

Unit size	Outdoor air temp.	Indoor air temp.:°CDB			
		15	21	25	27
32	°CWB	SHC	SHC	SHC	SHC
	-15.0	2.5	2.5	2.4	2.4
	-10.0	2.8	2.8	2.8	2.7
	-5.0	3.2	3.2	3.1	3.1
	0.0	3.6	3.5	3.4	3.1
	2.5	3.8	3.7	3.4	3.1
	6.0	4.0	4.0	3.4	3.1
	7.5	4.2	4.0	3.4	3.1
	10.0	4.4	4.0	3.4	3.1
	12.5	4.6	4.0	3.4	3.1
15.5	4.6	4.0	3.4	3.1	
40	-15.0	3.1	3.1	3.0	3.0
	-10.0	3.6	3.5	3.5	3.4
	-5.0	4.0	4.0	3.9	3.9
	0.0	4.5	4.4	4.3	3.9
	2.5	4.7	4.7	4.3	3.9
	6.0	5.0	5.0	4.3	3.9
	7.5	5.2	5.0	4.3	3.9
	10.0	5.4	5.0	4.3	3.9
	12.5	5.7	5.0	4.3	3.9
	15.5	5.8	5.0	4.3	3.9

PMFY-P-VBM-A

2-7.Cooling Capacity (In combination with WY, WR2)

CA:Capacity(kW)
SHC:Sensible Heat Capacity(kW)

PMFY-P-VBM-A

Unit size	Water temp.	Indoor air temp.													
		21.5°CDB 15°CWB		23°CDB 16°CWB		25°CDB 18°CWB		27°CDB 19°CWB		28°CDB 20°CWB		30°CDB 22°CWB		32°CDB 24°CWB	
	°C	CA	SHC	CA	SHC	CA	SHC	CA	SHC	CA	SHC	CA	SHC	CA	SHC
20	10	2.1	1.8	2.2	1.9	2.4	1.9	2.4	1.9	2.5	2.0	2.6	2.0	2.8	1.9
	20	2.1	1.8	2.1	1.9	2.3	1.9	2.3	1.9	2.4	2.0	2.5	1.9	2.7	1.9
	30	2.0	1.7	2.0	1.8	2.1	1.8	2.2	1.8	2.3	1.9	2.4	1.9	2.5	1.9
	40	1.7	1.6	1.8	1.7	1.9	1.7	1.9	1.7	2.0	1.8	2.1	1.8	2.2	1.8
	45	1.6	1.6	1.7	1.7	1.8	1.6	1.8	1.7	1.9	1.8	2.0	1.7	2.1	1.7
25	10	2.7	2.3	2.8	2.3	3.0	2.3	3.1	2.4	3.2	2.5	3.3	2.4	3.5	2.4
	20	2.6	2.2	2.7	2.3	2.9	2.3	3.0	2.3	3.1	2.4	3.2	2.4	3.4	2.3
	30	2.5	2.1	2.6	2.2	2.7	2.2	2.8	2.3	2.9	2.3	3.0	2.3	3.2	2.3
	40	2.2	2.0	2.2	2.1	2.4	2.1	2.4	2.1	2.5	2.2	2.6	2.2	2.8	2.1
	45	2.0	1.9	2.1	2.0	2.2	2.0	2.3	2.1	2.4	2.2	2.5	2.1	2.6	2.1
32	10	3.5	2.6	3.6	2.7	3.9	2.7	4.0	2.7	4.1	2.8	4.3	2.8	4.5	2.7
	20	3.4	2.5	3.5	2.6	3.7	2.6	3.8	2.6	3.9	2.7	4.1	2.7	4.4	2.6
	30	3.2	2.5	3.3	2.5	3.5	2.5	3.6	2.5	3.7	2.6	3.9	2.6	4.1	2.6
	40	2.8	2.3	2.9	2.3	3.1	2.3	3.1	2.4	3.2	2.4	3.4	2.4	3.6	2.4
	45	2.6	2.2	2.7	2.3	2.9	2.2	3.0	2.3	3.0	2.4	3.2	2.3	3.4	2.3
40	10	4.4	3.2	4.5	3.3	4.8	3.3	5.0	3.3	5.1	3.4	5.4	3.4	5.7	3.3
	20	4.2	3.1	4.4	3.2	4.6	3.2	4.8	3.2	4.9	3.3	5.2	3.3	5.5	3.2
	30	4.0	3.0	4.1	3.1	4.4	3.1	4.5	3.1	4.6	3.2	4.9	3.2	5.2	3.1
	40	3.5	2.8	3.6	2.8	3.8	2.8	3.9	2.9	4.0	3.0	4.3	2.9	4.5	2.9
	45	3.3	2.7	3.4	2.8	3.6	2.7	3.7	2.8	3.8	2.9	4.0	2.8	4.2	2.8

2-8.Heating Capacity (In combination with WY, WR2)

SHC:Sensible Heat Capacity(kW)

PMFY-P-VBM-A

Unit size	Water temp.	Indoor air temp.:°CDB				
		15	19	20	25	27
	°C	SHC(kW)	SHC(kW)	SHC(kW)	SHC(kW)	SHC(kW)
20	10	2.2	2.2	2.1	1.7	1.5
	20	2.6	2.6	2.5	2.0	1.8
	30	2.6	2.6	2.5	2.0	1.8
	40	2.7	2.7	2.6	2.1	1.9
	45	2.9	2.9	2.9	2.3	2.1
25	10	2.8	2.8	2.7	2.2	2.0
	20	3.3	3.3	3.2	2.6	2.3
	30	3.3	3.3	3.2	2.6	2.3
	40	3.4	3.4	3.3	2.7	2.4
	45	3.8	3.7	3.6	2.9	2.6
32	10	3.5	3.5	3.4	2.7	2.4
	20	4.1	4.1	4.0	3.2	2.9
	30	4.1	4.1	4.0	3.2	2.9
	40	4.3	4.2	4.2	3.3	3.0
	45	4.7	4.7	4.6	3.6	3.3
40	10	4.4	4.3	4.3	3.4	3.1
	20	5.2	5.1	5.0	4.0	3.6
	30	5.2	5.1	5.0	4.0	3.6
	40	5.4	5.3	5.2	4.2	3.7
	45	5.9	5.8	5.7	4.6	4.1

PMFY-P-VBM-A

3. Sound Levels

3-1. Noise level

Cassette ceiling (VBM-A series)

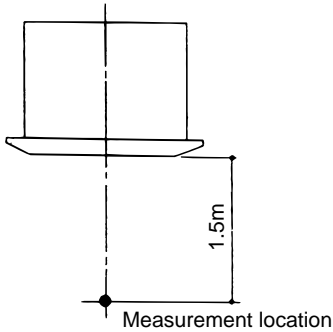

Noise level at anechoic room
(Low-Middle2-Middle1-High)

Unit : dB(A)

Model	Noise level (A weighted)
PMFY-P20VBM-A	27-30-33-35
PMFY-P25VBM-A PMFY-P32VBM-A	32-34-36-37
PMFY-P40VBM-A	33-35-37-39

3-2. NC curves

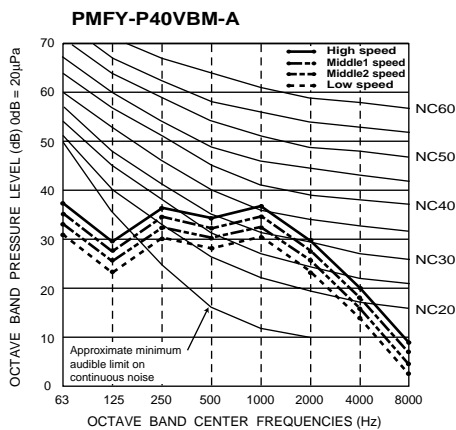
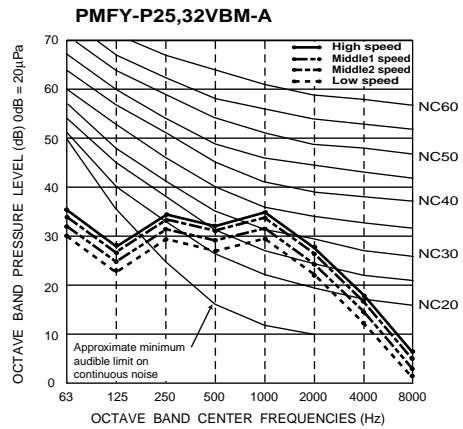
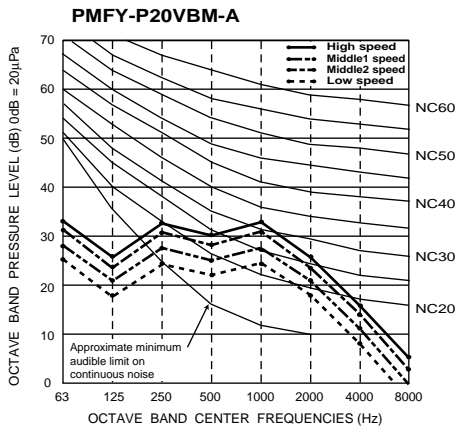

PMFY-P-VBM-A

5. Electrical Wiring Diagram

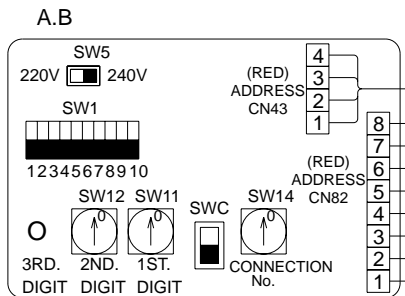
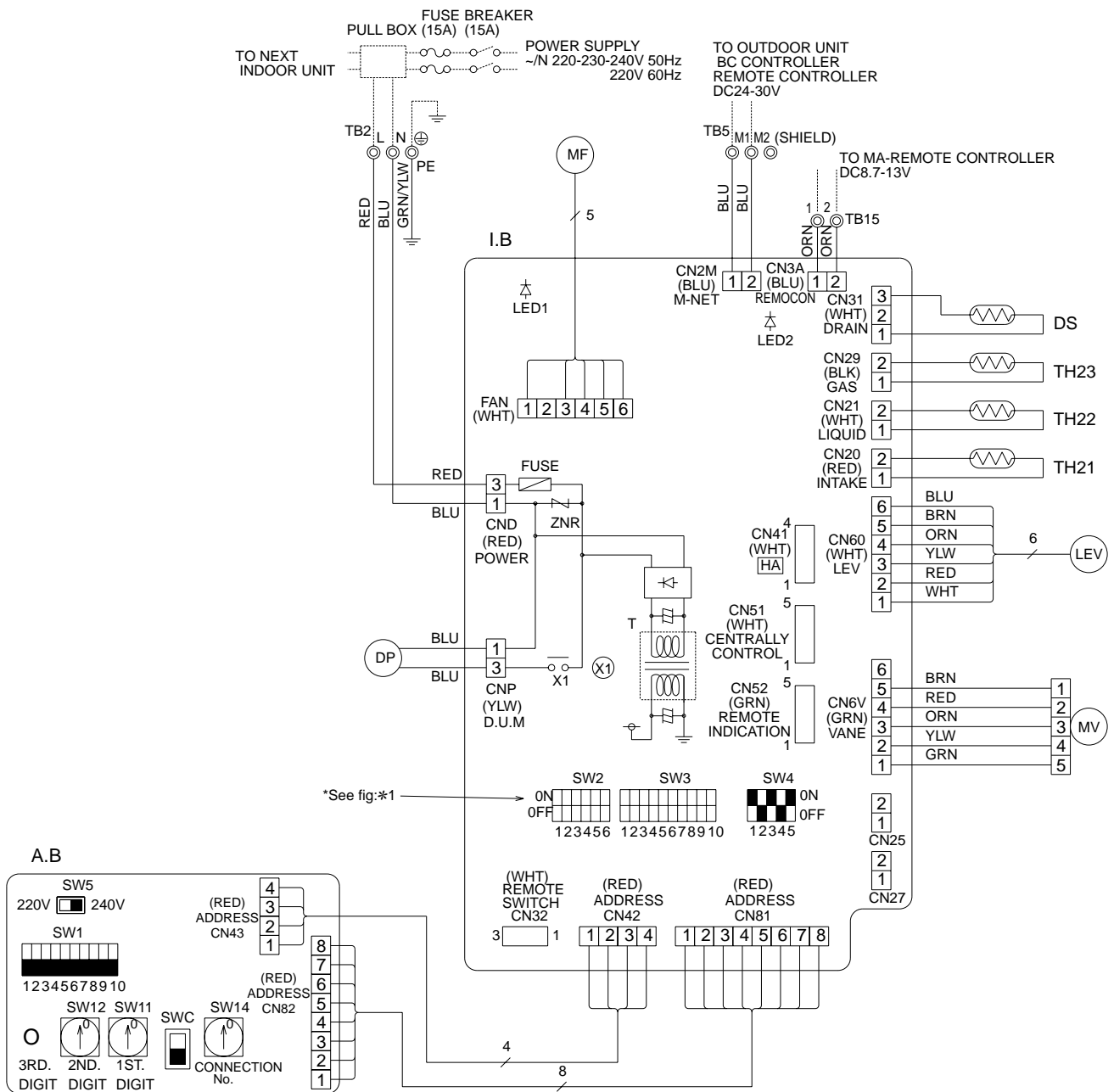

<SYMBOL EXPLANATION>

SYMBOL	NAME	SYMBOL	NAME
I.B	INDOOR CONTROLLER BOARD	MF	FAN MOTOR
CN25	HUMIDIFIER	MV	VANE MOTOR
CN27	DAMPER	DP	DRAIN WATER LIFTING-UP MACH.
CN32	CONNECTOR	DS	DRAIN SENSOR
CN41	HA TERMINAL-A	TB2	TERMINAL BLOCK
CN51	CENTRALLY CONTROL	TB5	TERMINAL BLOCK
CN52	REMOTE INDICATION	TB15	TERMINAL BLOCK
SW2	SWITCH	TH21	THERMISTOR
SW3	SWITCH	TH22	THERMISTOR
SW4	SWITCH	TH23	THERMISTOR
ZNR	VARIATOR	LEV	LINEAR EXPANSION VALVE
FUSE	FUSE (6.3A/250V)		
X1	AUX.RELAY / DRAIN PUMP		
T	TRANSFORMER		
LED1	POWER SUPPLY (I.B)		
LED2	POWER SUPPLY (I.B)		
A.B	CIRCUIT BOARD		
SW1	MODE SELECTION		
SW5	VOLTAGE SELECTION		
SW11	SWITCH		
SW12	SWITCH		
SW14	SWITCH		

<*1>

MODELS	SW2	SW3
P20VBM	ON OFF 123456	ON OFF 12345678910
P25VBM	ON OFF 123456	ON OFF 12345678910
P32VBM	ON OFF 123456	ON OFF 12345678910
P40VBM	ON OFF 123456	ON OFF 12345678910

NOTES:

- At servicing for outdoor unit, always follow the wiring diagram of outdoor unit.
- Symbol [S] of TB5 is the shield wire connection.
- Symbols used in wiring diagram above are,
 - ⊙: terminal block, □: connector.
- The setting of the SW2 dip switches differs in the capacity for the detail, see the table <*1>.
- Please set the switch SW5 according to the power supply voltage. Set SW5 to 240V side when the power supply is 230 and 240 volts. When the power supply is 220 volts, set SW5 to 220V side.

6. Temperature/Airflow distribution

● Temperature distribution

<Cooling mode>
Flow angle 30°

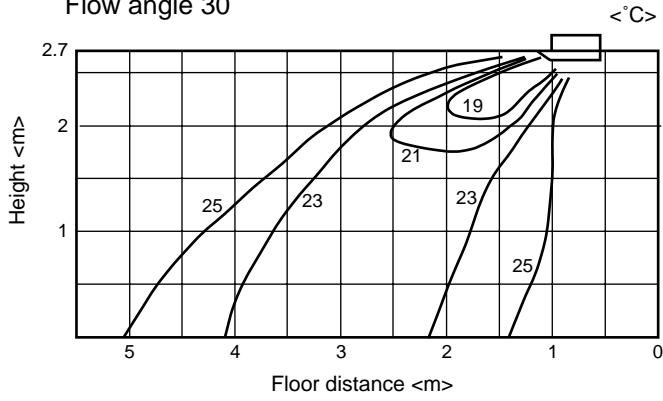

<Heating mode>
Flow angle 70°

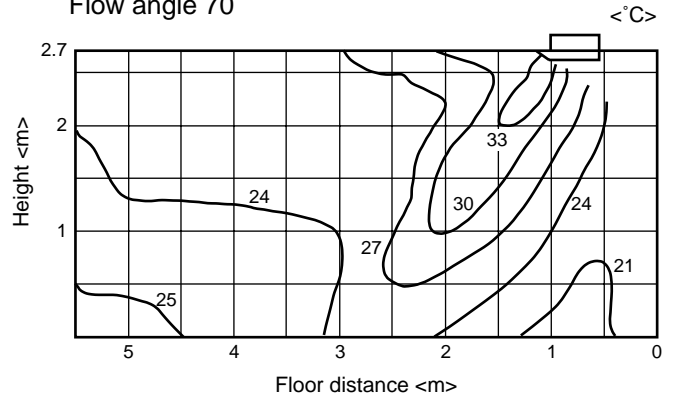

● Airflow distribution

<Fan mode>
Flow angle 30°

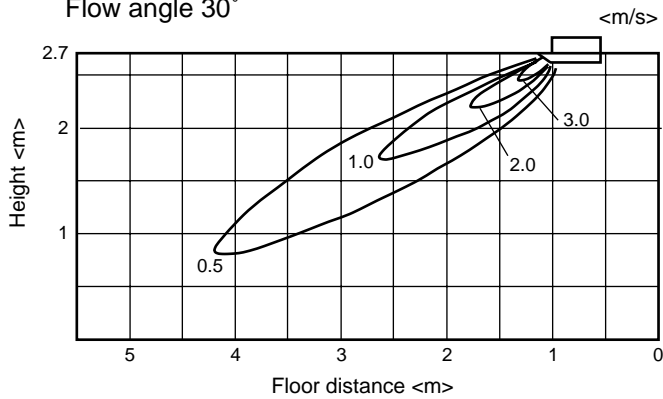

<Fan mode>
Flow angle 70°

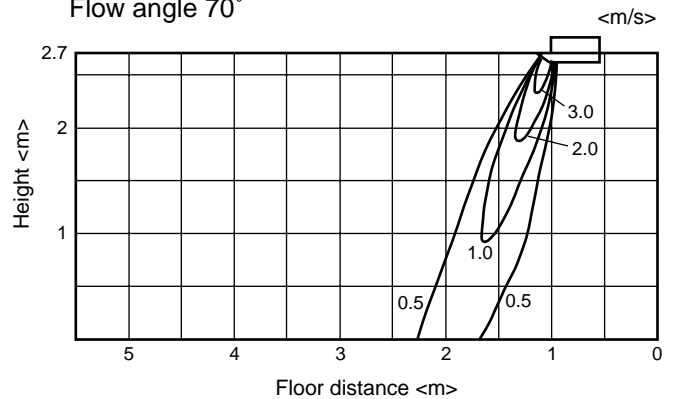

7. Options

Description	Model	Applicable capacity
Decoration panel	PMP-40BM	P20/P25/P32/P40

CONTENTS

1. Specifications	II -128
2. Capacity Tables	II -129
2-1 Cooling Capacity(PUMY)	II -129
2-2 Heating Capacity(PUMY)	II -131
2-3 Cooling Capacity(Y/R2-8-10-13HP)	II -132
2-4 Heating Capacity(Y/R2-8-10-13HP)	II -134
2-5 Cooling Capacity(Big Y, Super Y, Big R2)	II -135
2-6 Heating Capacity(Big Y, Super Y, Big R2)	II -137
2-7 Cooling Capacity(WY, WR2)	II -138
2-8 Heating Capacity(WY, WR2)	II -139
3. Sound Levels	II -140
3-1 Noise levels	II -140
3-2 N/C curves	II -140
3-3 OA Intake-static pressure curve	II -142
3-4 Branch duct Intake-static pressure curve	II -142
4. External Dimensions	II -143
5. Electrical Wiring Diagram	II -147
6. Temperature/Airflow distribution	II -149
7. Options	II -150

1. Specifications

			PLFY-P20VLMD-B	PLFY-P25VLMD-B	PLFY-P32VLMD-B	PLFY-P40VLMD-B	PLFY-P50VLMD-B	PLFY-P63VLMD-B
Power source			~ 220-240V 50Hz / ~ 220-230V 60Hz					
Cooling capacity	* 1	kW	2.2	2.8	3.6	4.5	5.6	7.1
	* 2	kcal/h	2,000	2,500	3,150	4,000	5,000	6,300
Heating capacity	* 1	kW	2.5	3.2	4.0	5.0	6.3	8.0
Power consumption	Cooling	kW	0.072 / 0.075	0.072 / 0.075	0.072 / 0.075	0.081 / 0.085	0.082 / 0.086	0.101 / 0.105
	Heating	kW	0.065 / 0.069	0.065 / 0.069	0.065 / 0.069	0.074 / 0.079	0.075 / 0.080	0.094 / 0.099
Current	Cooling	A	0.36 / 0.37	0.36 / 0.37	0.36 / 0.37	0.40 / 0.42	0.41 / 0.43	0.49 / 0.51
	Heating	A	0.30 / 0.32	0.30 / 0.32	0.30 / 0.32	0.34 / 0.37	0.35 / 0.38	0.43 / 0.46
External finish(Munsel No.)			Unit: Galvanizing Decoration Panel: ABS (0.7Y 8.59/0.97) Service Panel: Galvanizing (0.7Y 8.59/0.97)					
Dimension * 3	Height	mm	290 <20>					
	Width	mm	776 <1080>			946 <1250>		
	Depth	mm	634 <710>					
Net weight	* 3	kg	23 <6.5>		24 <6.5>		27 <7.5>	28 <7.5>
Heat exchanger			Cross fin					
Fan	Type	Turbo fan x 1						
	Airflow rate (Lo-Mid-Hi)	m³/min	6.5-8.0-9.5			7.0-8.5-10.5	9.0-11.0-12.5	10.0-13.0-15.5
	External static pressure	Pa	0					
Motor	Type	Single phase induction motor						
	Output	kW	0.015				0.020	
Air filter			PP honeycomb fabric (long life filter)					
Refrigerant pipe dimension	Gas(Flare)	mm	ø 12.7					ø 15.88
	Liquid(Flare)	mm	ø 6.35					ø 9.52
Drain pipe dimension			VP-25					
Noise level (Lo-Mid-Hi) *4	220V,240V	dB(A)	27-30-33			29-33-36	31-34-37	32-37-39
	230V	dB(A)	28-31-34			30-34-37	32-35-38	33-38-40

			PLFY-P80VLMD-A	PLFY-P100VLMD-A	PLFY-P125VLMD-A
Power source			~ 220-240V 50Hz		
Cooling capacity	* 1	kW	9.0	11.2	14.0
	* 2	kcal/h	8,000	10,000	12,500
Heating capacity	* 1	kW	10.0	12.5	16.0
Power consumption	Cooling	kW	0.23	0.25	0.28
	Heating	kW	0.22	0.24	0.27
Current	Cooling	A	1.10	1.20	1.35
	Heating	A	1.05	1.15	1.33
External finish(Munsel No.)			Unit : Galvanizing Panel : 0.70V8.59/0.97		
Dimension * 3	Height	mm	338 <8>		
	Width	mm	1,358 <1,650>	1,708 <2,000>	
	Depth	mm	606 <670>		
Net weight	* 3	kg	39 <10>		56 <11.5>
Heat exchanger			Cross fin (Aluminum plate fin and copper tube)		
Fan	Type	Sirocco fanX2			
	Airflow rate (Lo-Mid2-Mid1-Hi)	m³/min	15.0-17.0-19.0-21.0	21.0-23.0-26.0-29.0	24.0-27.0-30.0-33.0
	External static pressure	Pa	0		
Motor	Type	Single phase induction motor			
	Output	kW	0.078	0.078X2	
Air filter			Synthetic fiber unwoven cloth filter (long life)		
Refrigerant pipe dimension	Gas (Flare)	mm	ø 15.88		ø 19.05
	Liquid (Flare)	mm	ø 9.52		
Drain pipe dimension			VP-25		
Noise level (Lo-Mid2-Mid1-Hi) * 4		dB(A)	36-38-41-43	37-39-41-43	40-42-44-46

Note: * 1 Cooling/Heating capacity indicates the maximum value at operation under the following condition.

Cooling : Indoor 27°CDB/19°CWB, Outdoor 35°CDB

Heating : Indoor 20°CDB, Outdoor 7°CDB/6°CWB

* 2 Cooling capacity indicates the maximum value at operation under the following condition.

Cooling : Indoor 27°CDB/19.5°CWB, Outdoor 35°CDB (WR2: water 30°C)

* 3 The figure in < > indicates panel's

* 4 It is measured in anechoic room.

2. Capacity Tables

2-1. Cooling Capacity (In combination with PUMY)

PLFY-P-VLMD-A, VLMD-B

CA:Capacity(kW)
SHC:Sensible Heat Capacity(kW)

Unit size	Outdoor air temp.	Indoor air temp.							
		23°CDB 16°CWB		25°CDB 18°CWB		28°CDB 20°CWB		30°CDB 22°CWB	
		°CDB	CA	SHC	CA	SHC	CA	SHC	CA
20 (2.2)	20.0	2.2	1.8	2.3	1.8	2.4	1.8	2.6	1.9
	22.5	2.1	1.8	2.3	1.8	2.4	1.8	2.6	1.9
	25.0	2.1	1.7	2.3	1.8	2.4	1.8	2.5	1.9
	27.5	2.1	1.7	2.2	1.8	2.4	1.8	2.5	1.9
	30.0	2.1	1.7	2.2	1.8	2.3	1.8	2.5	1.9
	32.5	2.0	1.7	2.2	1.8	2.3	1.8	2.5	1.8
	35.0	2.0	1.7	2.1	1.8	2.3	1.8	2.4	1.8
	37.5	2.0	1.7	2.1	1.8	2.2	1.7	2.4	1.8
	40.0	2.0	1.7	2.1	1.8	2.2	1.7	2.4	1.8
46.0	1.9	1.6	2.0	1.7	2.1	1.7	2.3	1.8	
25 (2.8)	20.0	2.8	2.1	2.9	2.1	3.1	2.1	3.3	2.2
	22.5	2.7	2.0	2.9	2.1	3.1	2.1	3.2	2.2
	25.0	2.7	2.0	2.9	2.1	3.1	2.1	3.2	2.2
	27.5	2.7	2.0	2.8	2.1	3.0	2.1	3.2	2.2
	30.0	2.6	2.0	2.8	2.1	3.0	2.1	3.2	2.1
	32.5	2.6	2.0	2.8	2.1	2.9	2.1	3.1	2.1
	35.0	2.6	1.9	2.7	2.1	2.9	2.0	3.1	2.1
	37.5	2.5	1.9	2.7	2.0	2.9	2.0	3.0	2.1
	40.0	2.5	1.9	2.7	2.0	2.8	2.0	3.0	2.1
46.0	2.4	1.9	2.6	2.0	2.7	1.9	2.9	2.0	
32 (3.6)	20.0	3.6	2.6	3.7	2.7	4.0	2.7	4.2	2.7
	22.5	3.5	2.6	3.7	2.7	4.0	2.6	4.2	2.7
	25.0	3.5	2.5	3.7	2.6	3.9	2.6	4.1	2.7
	27.5	3.4	2.5	3.6	2.6	3.9	2.6	4.1	2.7
	30.0	3.4	2.5	3.6	2.6	3.8	2.6	4.1	2.7
	32.5	3.3	2.5	3.6	2.6	3.8	2.6	4.0	2.6
	35.0	3.3	2.4	3.5	2.6	3.7	2.5	4.0	2.6
	37.5	3.2	2.4	3.5	2.5	3.7	2.5	3.9	2.6
	40.0	3.2	2.4	3.4	2.5	3.6	2.5	3.9	2.6
46.0	3.1	2.3	3.3	2.5	3.5	2.4	3.7	2.5	
40 (4.5)	20.0	4.5	3.0	4.7	3.2	5.0	3.1	5.3	3.2
	22.5	4.4	3.0	4.6	3.1	5.0	3.1	5.2	3.2
	25.0	4.3	3.0	4.6	3.1	4.9	3.1	5.2	3.2
	27.5	4.3	3.0	4.6	3.1	4.9	3.1	5.1	3.1
	30.0	4.2	2.9	4.5	3.1	4.8	3.0	5.1	3.1
	32.5	4.2	2.9	4.4	3.0	4.7	3.0	5.0	3.1
	35.0	4.1	2.8	4.4	3.0	4.7	3.0	5.0	3.1
	37.5	4.1	2.8	4.3	3.0	4.6	2.9	4.9	3.0
	40.0	4.0	2.8	4.3	2.9	4.5	2.9	4.8	3.0
46.0	3.8	2.7	4.1	2.9	4.3	2.8	4.6	2.9	
50 (5.6)	20.0	5.5	3.8	5.8	4.0	6.2	4.0	6.6	4.1
	22.5	5.5	3.8	5.8	3.9	6.2	3.9	6.5	4.0
	25.0	5.4	3.7	5.7	3.9	6.1	3.9	6.4	4.0
	27.5	5.3	3.7	5.7	3.9	6.0	3.9	6.4	4.0
	30.0	5.3	3.7	5.6	3.8	5.9	3.8	6.3	3.9
	32.5	5.2	3.6	5.5	3.8	5.9	3.8	6.2	3.9
	35.0	5.1	3.6	5.5	3.8	5.8	3.7	6.2	3.9
	37.5	5.0	3.5	5.4	3.7	5.7	3.7	6.1	3.8
	40.0	5.0	3.5	5.3	3.7	5.6	3.7	6.0	3.8
46.0	4.8	3.4	5.1	3.6	5.4	3.5	5.8	3.7	
63 (7.1)	20.0	7.0	4.9	7.4	5.1	7.9	5.1	8.3	5.2
	22.5	6.9	4.9	7.3	5.1	7.8	5.1	8.2	5.2
	25.0	6.9	4.8	7.3	5.1	7.7	5.0	8.2	5.2
	27.5	6.8	4.8	7.2	5.0	7.7	5.0	8.1	5.1
	30.0	6.7	4.7	7.1	5.0	7.5	4.9	8.0	5.1
	32.5	6.6	4.7	7.0	4.9	7.5	4.9	7.9	5.0
	35.0	6.5	4.6	6.9	4.9	7.3	4.8	7.8	5.0
	37.5	6.4	4.6	6.8	4.8	7.2	4.8	7.7	5.0
	40.0	6.3	4.6	6.7	4.8	7.2	4.7	7.6	4.9
46.0	6.1	4.4	6.5	4.7	6.9	4.6	7.3	4.8	

PLFY-P-VLMD-A/VLMD-B

Cooling Capacity (In combination with PUMY)

PLFY-P-VLMD-A, VLMD-B

CA:Capacity(kW)
SHC:Sensible Heat Capacity(kW)

Unit size	Outdoor air temp.	Indoor air temp.							
		23°CDB 16°CWB		25°CDB 18°CWB		28°CDB 20°CWB		30°CDB 22°CWB	
		°CDB	CA	SHC	CA	SHC	CA	SHC	CA
80 (9.0)	20.0	8.9	6.3	9.4	6.6	10.0	6.6	10.6	6.7
	22.5	8.8	6.3	9.3	6.6	9.9	6.5	10.4	6.7
	25.0	8.7	6.2	9.2	6.5	9.8	6.5	10.4	6.7
	27.5	8.6	6.2	9.1	6.5	9.7	6.4	10.3	6.6
	30.0	8.5	6.1	9.0	6.4	9.5	6.4	10.2	6.6
	32.5	8.3	6.0	8.9	6.4	9.5	6.3	10.0	6.5
	35.0	8.2	6.0	8.8	6.3	9.3	6.2	9.9	6.5
	37.5	8.1	5.9	8.6	6.2	9.2	6.2	9.8	6.4
	40.0	8.0	5.9	8.6	6.2	9.1	6.1	9.6	6.3
46.0	7.7	5.7	8.2	6.0	8.7	6.0	9.3	6.2	
100 (11.2)	20.0	11.1	8.3	11.6	8.6	12.5	8.6	13.1	8.8
	22.5	10.9	8.2	11.5	8.6	12.3	8.5	13.0	8.8
	25.0	10.8	8.1	11.5	8.5	12.2	8.5	12.9	8.7
	27.5	10.7	8.1	11.3	8.5	12.1	8.4	12.8	8.7
	30.0	10.5	8.0	11.2	8.4	11.9	8.3	12.6	8.6
	32.5	10.4	7.9	11.1	8.3	11.8	8.3	12.5	8.5
	35.0	10.2	7.8	10.9	8.3	11.6	8.2	12.3	8.5
	37.5	10.1	7.8	10.8	8.2	11.4	8.1	12.2	8.4
	40.0	10.0	7.7	10.6	8.1	11.3	8.1	12.0	8.3
46.0	9.6	7.5	10.2	7.9	10.8	7.8	11.5	8.1	
125 (14.0)	20.0	13.9	10.1	14.6	10.5	15.6	10.5	16.4	10.8
	22.5	13.7	10.0	14.4	10.5	15.4	10.4	16.2	10.7
	25.0	13.5	10.0	14.3	10.4	15.3	10.3	16.1	10.6
	27.5	13.4	9.9	14.2	10.3	15.1	10.3	16.0	10.6
	30.0	13.2	9.8	14.0	10.3	14.9	10.2	15.8	10.5
	32.5	13.0	9.7	13.8	10.2	14.7	10.1	15.6	10.4
	35.0	12.8	9.6	13.7	10.1	14.5	10.0	15.4	10.3
	37.5	12.6	9.5	13.4	10.0	14.3	9.9	15.2	10.3
	40.0	12.5	9.4	13.3	9.9	14.1	9.8	15.0	10.2
46.0	12.0	9.2	12.8	9.7	13.5	9.6	14.4	9.9	

PLFY-P-VLMD-A/VLMD-B

2-2.Heating Capacity (In combination with PUMY)

PLFY-P-VLMD-A, VLMD-B

SHC:Sensible Heat Capacity(kW)

Unit size	Outdoor air temp.	Indoor air temp.:°CDB		
		15.0	20.0	25.0
		°CWB	SHC	SHC
20	-12.0	1.6	1.6	1.5
	-10.0	1.7	1.6	1.6
	-5.0	1.9	1.9	1.9
	0.0	2.2	2.1	2.1
	2.5	2.3	2.3	2.3
	6.0	2.5	2.5	2.5
	7.5	2.6	2.6	2.5
	10.0	2.8	2.7	2.5
	12.5	2.9	2.8	2.5
15.5	3.1	2.8	2.5	
25	-12.0	2.0	2.0	2.0
	-10.0	2.1	2.1	2.1
	-5.0	2.4	2.4	2.4
	0.0	2.8	2.8	2.7
	2.5	3.0	2.9	2.9
	6.0	3.2	3.2	3.2
	7.5	3.3	3.3	3.2
	10.0	3.5	3.5	3.2
	12.5	3.7	3.5	3.2
15.5	3.9	3.5	3.2	
32	-12.0	2.5	2.5	2.5
	-10.0	2.7	2.6	2.6
	-5.0	3.1	3.0	3.0
	0.0	3.5	3.4	3.4
	2.5	3.7	3.7	3.6
	6.0	4.0	4.0	3.9
	7.5	4.2	4.1	4.0
	10.0	4.4	4.4	4.0
	12.5	4.7	4.4	4.0
15.5	4.9	4.4	4.0	
40	-12.0	3.2	3.1	3.1
	-10.0	3.4	3.3	3.2
	-5.0	3.8	3.8	3.7
	0.0	4.3	4.3	4.2
	2.5	4.6	4.6	4.5
	6.0	5.0	5.0	4.9
	7.5	5.2	5.2	5.0
	10.0	5.5	5.5	5.0
	12.5	5.9	5.5	5.0
15.5	6.2	5.5	5.0	
50	-12.0	4.0	3.9	3.9
	-10.0	4.2	4.2	4.1
	-5.0	4.8	4.8	4.7
	0.0	5.5	5.4	5.3
	2.5	5.8	5.8	5.7
	6.0	6.3	6.3	6.2
	7.5	6.6	6.5	6.2
	10.0	7.0	6.9	6.2
	12.5	7.4	7.0	6.2
15.5	7.7	7.0	6.2	

Unit size	Outdoor air temp.	Indoor air temp.:°CDB		
		15.0	20.0	25.0
		°CWB	SHC	SHC
63	-12.0	5.1	5.0	4.9
	-10.0	5.4	5.3	5.2
	-5.0	6.1	6.0	5.9
	0.0	6.9	6.9	6.8
	2.5	7.4	7.3	7.2
	6.0	8.0	8.0	7.9
	7.5	8.3	8.3	7.9
	10.0	8.8	8.8	7.9
	12.5	9.4	8.8	7.9
15.5	9.8	8.8	7.9	
80	-12.0	6.4	6.2	6.1
	-10.0	6.7	6.6	6.5
	-5.0	7.6	7.5	7.4
	0.0	8.7	8.6	8.5
	2.5	9.2	9.2	9.0
	6.0	10.1	10.0	9.9
	7.5	10.4	10.4	9.9
	10.0	11.1	11.0	9.9
	12.5	11.7	11.0	9.9
15.5	12.3	11.0	9.9	
100	-12.0	8.0	7.8	7.7
	-10.0	8.4	8.2	8.1
	-5.0	9.6	9.4	9.3
	0.0	10.9	10.7	10.6
	2.5	11.5	11.4	11.3
	6.0	12.6	12.5	12.3
	7.5	13.0	12.9	12.4
	10.0	13.8	13.7	12.4
	12.5	14.6	13.8	12.4
15.5	15.4	13.8	12.4	
125	-12.0	10.2	10.0	9.8
	-10.0	10.7	10.6	10.4
	-5.0	12.2	12.1	11.9
	0.0	13.9	13.8	13.6
	2.5	14.8	14.7	14.5
	6.0	16.1	16.0	15.8
	7.5	16.7	16.6	15.8
	10.0	17.7	17.6	15.8
	12.5	18.7	17.7	15.8
15.5	19.7	17.7	15.8	

2-3.Cooling Capacity (In combination with PU(H)Y, PURY-(P)200-250-315YEM-A, TEM-A)

PLFY-P-VLMD-A, VLMD-B

CA:Capacity(kW)

SHC:Sensible Heat Capacity(kW)

Unit size	Outdoor air temp.	Indoor air temp.													
		21.5°CDB 15°CWB		23°CDB 16°CWB		25°CDB 18°CWB		27°CDB 19°CWB		28°CDB 20°CWB		30°CDB 22°CWB		32°CDB 24°CWB	
		°CDB	CA	SHC	CA	SHC	CA	SHC	CA	SHC	CA	SHC	CA	SHC	CA
20 (2.2)	20.0	2.2	1.8	2.2	1.8	2.3	1.8	2.3	1.8	2.4	1.9	2.5	1.8	2.6	1.8
	22.5	2.1	1.7	2.2	1.8	2.3	1.8	2.3	1.8	2.4	1.8	2.4	1.8	2.5	1.8
	25.0	2.1	1.7	2.2	1.8	2.2	1.7	2.3	1.8	2.3	1.8	2.4	1.8	2.5	1.8
	27.5	2.1	1.7	2.1	1.8	2.2	1.7	2.3	1.8	2.3	1.8	2.4	1.8	2.5	1.7
	30.0	2.1	1.7	2.1	1.8	2.2	1.7	2.2	1.8	2.3	1.8	2.4	1.8	2.5	1.7
	32.5	2.0	1.7	2.1	1.8	2.2	1.7	2.2	1.8	2.3	1.8	2.4	1.8	2.4	1.7
	35.0	2.0	1.7	2.1	1.7	2.2	1.7	2.2	1.7	2.2	1.8	2.3	1.8	2.4	1.7
	37.5	2.0	1.7	2.0	1.7	2.1	1.7	2.2	1.7	2.2	1.8	2.3	1.8	2.4	1.7
	40.0	2.0	1.7	2.0	1.7	2.1	1.7	2.2	1.7	2.2	1.8	2.3	1.8	2.4	1.7
43.0	2.0	1.7	2.0	1.7	2.1	1.7	2.1	1.7	2.2	1.8	2.3	1.7	2.3	1.7	
25 (2.8)	20.0	2.7	2.0	2.8	2.1	2.9	2.0	3.0	2.1	3.0	2.1	3.1	2.1	3.2	2.0
	22.5	2.7	2.0	2.8	2.1	2.9	2.0	2.9	2.0	3.0	2.1	3.1	2.1	3.2	2.0
	25.0	2.7	2.0	2.7	2.1	2.9	2.0	2.9	2.0	3.0	2.1	3.1	2.0	3.2	2.0
	27.5	2.7	2.0	2.7	2.0	2.8	2.0	2.9	2.0	2.9	2.1	3.1	2.0	3.2	2.0
	30.0	2.6	2.0	2.7	2.0	2.8	2.0	2.9	2.0	2.9	2.1	3.0	2.0	3.1	2.0
	32.5	2.6	2.0	2.7	2.0	2.8	2.0	2.8	2.0	2.9	2.1	3.0	2.0	3.1	2.0
	35.0	2.6	2.0	2.6	2.0	2.7	2.0	2.8	2.0	2.9	2.0	3.0	2.0	3.1	1.9
	37.5	2.5	1.9	2.6	2.0	2.7	2.0	2.8	2.0	2.8	2.0	2.9	2.0	3.1	1.9
	40.0	2.5	1.9	2.6	2.0	2.7	1.9	2.7	2.0	2.8	2.0	2.9	2.0	3.0	1.9
43.0	2.5	1.9	2.5	2.0	2.7	1.9	2.7	1.9	2.8	2.0	2.9	2.0	3.0	1.9	
32 (3.6)	20.0	3.5	2.6	3.6	2.6	3.7	2.5	3.8	2.6	3.9	2.6	4.0	2.6	4.2	2.5
	22.5	3.5	2.5	3.6	2.6	3.7	2.5	3.8	2.5	3.9	2.6	4.0	2.6	4.1	2.5
	25.0	3.5	2.5	3.5	2.6	3.7	2.5	3.7	2.5	3.8	2.6	4.0	2.5	4.1	2.5
	27.5	3.4	2.5	3.5	2.6	3.6	2.5	3.7	2.5	3.8	2.6	3.9	2.5	4.1	2.5
	30.0	3.4	2.5	3.5	2.5	3.6	2.5	3.7	2.5	3.7	2.6	3.9	2.5	4.0	2.4
	32.5	3.3	2.5	3.4	2.5	3.6	2.5	3.6	2.5	3.7	2.6	3.9	2.5	4.0	2.4
	35.0	3.3	2.4	3.4	2.5	3.5	2.4	3.6	2.5	3.7	2.5	3.8	2.5	4.0	2.4
	37.5	3.3	2.4	3.3	2.5	3.5	2.4	3.6	2.5	3.6	2.5	3.8	2.5	3.9	2.4
	40.0	3.2	2.4	3.3	2.5	3.5	2.4	3.5	2.4	3.6	2.5	3.7	2.5	3.9	2.4
43.0	3.2	2.4	3.3	2.4	3.4	2.4	3.5	2.4	3.6	2.5	3.7	2.4	3.8	2.4	
40 (4.5)	20.0	4.4	3.0	4.5	3.1	4.7	3.0	4.8	3.0	4.9	3.1	5.0	3.0	5.2	2.9
	22.5	4.4	3.0	4.5	3.0	4.6	3.0	4.7	3.0	4.8	3.0	5.0	2.9	5.2	2.8
	25.0	4.3	3.0	4.4	3.0	4.6	2.9	4.7	2.9	4.8	3.0	5.0	2.9	5.1	2.8
	27.5	4.3	2.9	4.4	3.0	4.5	2.9	4.6	2.9	4.7	3.0	4.9	2.9	5.1	2.8
	30.0	4.2	2.9	4.3	3.0	4.5	2.9	4.6	2.9	4.7	3.0	4.9	2.9	5.0	2.8
	32.5	4.2	2.9	4.3	2.9	4.5	2.9	4.5	2.9	4.6	2.9	4.8	2.9	5.0	2.8
	35.0	4.1	2.9	4.2	2.9	4.4	2.8	4.5	2.8	4.6	2.9	4.8	2.8	5.0	2.8
	37.5	4.1	2.8	4.2	2.9	4.4	2.8	4.5	2.8	4.5	2.9	4.7	2.8	4.9	2.7
	40.0	4.1	2.8	4.1	2.9	4.3	2.8	4.4	2.8	4.5	2.9	4.7	2.8	4.9	2.7
43.0	4.0	2.8	4.1	2.8	4.3	2.8	4.4	2.8	4.4	2.9	4.6	2.8	4.8	2.7	
50 (5.6)	20.0	5.5	3.8	5.6	3.8	5.8	3.8	5.9	3.8	6.0	3.8	6.3	3.7	6.5	3.6
	22.5	5.4	3.8	5.5	3.8	5.8	3.7	5.9	3.7	6.0	3.8	6.2	3.7	6.4	3.6
	25.0	5.4	3.7	5.5	3.8	5.7	3.7	5.8	3.7	5.9	3.8	6.2	3.7	6.4	3.6
	27.5	5.3	3.7	5.4	3.8	5.7	3.7	5.8	3.7	5.9	3.8	6.1	3.7	6.3	3.6
	30.0	5.3	3.7	5.4	3.7	5.6	3.6	5.7	3.6	5.8	3.7	6.0	3.6	6.3	3.5
	32.5	5.2	3.6	5.3	3.7	5.5	3.6	5.7	3.6	5.8	3.7	6.0	3.6	6.2	3.5
	35.0	5.2	3.6	5.3	3.7	5.5	3.6	5.6	3.6	5.7	3.7	5.9	3.6	6.2	3.5
	37.5	5.1	3.6	5.2	3.6	5.4	3.6	5.5	3.6	5.7	3.7	5.9	3.6	6.1	3.5
	40.0	5.0	3.5	5.2	3.6	5.4	3.5	5.5	3.5	5.6	3.6	5.8	3.6	6.0	3.4
43.0	5.0	3.5	5.1	3.6	5.3	3.5	5.4	3.5	5.5	3.6	5.8	3.5	6.0	3.4	
63 (7.1)	20.0	7.0	4.9	7.1	5.0	7.4	4.9	7.5	4.9	7.7	5.0	8.0	4.9	8.2	4.7
	22.5	6.9	4.9	7.0	4.9	7.3	4.8	7.5	4.8	7.6	5.0	7.9	4.8	8.2	4.7
	25.0	6.8	4.8	7.0	4.9	7.2	4.8	7.4	4.8	7.5	4.9	7.8	4.8	8.1	4.7
	27.5	6.7	4.8	6.9	4.9	7.2	4.8	7.3	4.8	7.5	4.9	7.7	4.8	8.0	4.6
	30.0	6.7	4.7	6.8	4.8	7.1	4.7	7.2	4.7	7.4	4.9	7.7	4.7	8.0	4.6
	32.5	6.6	4.7	6.7	4.8	7.0	4.7	7.2	4.7	7.3	4.8	7.6	4.7	7.9	4.6
	35.0	6.5	4.7	6.7	4.8	7.0	4.7	7.1	4.7	7.2	4.8	7.5	4.7	7.8	4.6
	37.5	6.5	4.6	6.6	4.7	6.9	4.6	7.0	4.6	7.2	4.8	7.5	4.7	7.7	4.5
	40.0	6.4	4.6	6.5	4.7	6.8	4.6	7.0	4.6	7.1	4.8	7.4	4.6	7.7	4.5
43.0	6.3	4.5	6.4	4.6	6.7	4.5	6.9	4.6	7.0	4.7	7.3	4.6	7.6	4.5	

PLFY-P-VLMD-A, VLMD-B

Cooling Capacity (In combination with PU(H)Y, PURY-(P)200-250-315YEM-A, TEM-A)

PLFY-P-VLMD-A, VLMD-B

CA:Capacity(kW)

SHC:Sensible Heat Capacity(kW)

Unit size	Outdoor air temp.	Indoor air temp.													
		21.5°CDB 15°CWB		23°CDB 16°CWB		25°CDB 18°CWB		27°CDB 19°CWB		28°CDB 20°CWB		30°CDB 22°CWB		32°CDB 24°CWB	
		°CDB	CA	SHC	CA	SHC	CA	SHC	CA	SHC	CA	SHC	CA	SHC	CA
80 (9.0)	20.0	8.8	6.3	9.0	6.4	9.4	6.3	9.5	6.3	9.7	6.5	10.1	6.3	10.4	6.1
	22.5	8.7	6.3	8.9	6.4	9.3	6.2	9.5	6.3	9.6	6.4	10.0	6.3	10.4	6.1
	25.0	8.6	6.2	8.8	6.3	9.2	6.2	9.4	6.2	9.5	6.4	9.9	6.2	10.3	6.0
	27.5	8.6	6.2	8.7	6.3	9.1	6.1	9.3	6.2	9.5	6.4	9.8	6.2	10.2	6.0
	30.0	8.5	6.1	8.6	6.2	9.0	6.1	9.2	6.1	9.4	6.3	9.7	6.2	10.1	6.0
	32.5	8.4	6.1	8.6	6.2	8.9	6.1	9.1	6.1	9.3	6.3	9.6	6.1	10.0	5.9
	35.0	8.3	6.0	8.5	6.2	8.8	6.0	9.0	6.1	9.2	6.2	9.5	6.1	9.9	5.9
	37.5	8.2	6.0	8.4	6.1	8.7	6.0	8.9	6.0	9.1	6.2	9.5	6.1	9.8	5.9
	40.0	8.1	5.9	8.3	6.1	8.6	5.9	8.8	6.0	9.0	6.2	9.4	6.0	9.7	5.9
43.0	8.0	5.9	8.2	6.0	8.5	5.9	8.7	5.9	8.9	6.1	9.3	6.0	9.6	5.8	
100 (11.2)	20.0	11.0	8.2	11.2	8.4	11.6	8.2	11.9	8.3	12.1	8.5	12.5	8.3	13.0	8.1
	22.5	10.9	8.2	11.1	8.3	11.5	8.2	11.8	8.2	12.0	8.5	12.4	8.3	12.9	8.1
	25.0	10.8	8.1	11.0	8.3	11.4	8.1	11.6	8.2	11.9	8.5	12.3	8.2	12.8	8.0
	27.5	10.6	8.0	10.9	8.2	11.3	8.1	11.5	8.1	11.8	8.4	12.2	8.2	12.7	8.0
	30.0	10.5	8.0	10.8	8.2	11.2	8.0	11.4	8.1	11.6	8.4	12.1	8.2	12.5	7.9
	32.5	10.4	7.9	10.6	8.1	11.1	8.0	11.3	8.0	11.5	8.3	12.0	8.1	12.4	7.9
	35.0	10.3	7.9	10.5	8.1	11.0	7.9	11.2	8.0	11.4	8.3	11.9	8.1	12.3	7.9
	37.5	10.2	7.8	10.4	8.0	10.9	7.9	11.1	8.0	11.3	8.2	11.8	8.0	12.2	7.8
	40.0	10.1	7.8	10.3	8.0	10.8	7.8	11.0	7.9	11.2	8.2	11.6	8.0	12.1	7.8
43.0	9.9	7.7	10.2	7.9	10.6	7.8	10.8	7.9	11.1	8.1	11.5	7.9	12.0	7.7	
125 (14.0)	20.0	13.7	10.1	14.0	10.3	14.6	10.0	14.8	10.1	15.1	10.4	15.7	10.1	16.2	9.8
	22.5	13.6	10.0	13.9	10.2	14.4	10.0	14.7	10.0	15.0	10.3	15.5	10.1	16.1	9.8
	25.0	13.4	9.9	13.7	10.1	14.3	9.9	14.6	10.0	14.8	10.3	15.4	10.0	16.0	9.7
	27.5	13.3	9.8	13.6	10.1	14.1	9.8	14.4	9.9	14.7	10.2	15.3	10.0	15.8	9.7
	30.0	13.2	9.8	13.4	10.0	14.0	9.8	14.3	9.9	14.6	10.2	15.1	9.9	15.7	9.6
	32.5	13.0	9.7	13.3	9.9	13.9	9.7	14.1	9.8	14.4	10.1	15.0	9.9	15.5	9.6
	35.0	12.9	9.6	13.2	9.9	13.7	9.7	14.0	9.7	14.3	10.1	14.8	9.8	15.4	9.5
	37.5	12.7	9.6	13.0	9.8	13.6	9.6	13.9	9.7	14.1	10.0	14.7	9.8	15.3	9.5
	40.0	12.6	9.5	12.9	9.7	13.4	9.5	13.7	9.6	14.0	9.9	14.6	9.7	15.1	9.4
43.0	12.4	9.4	12.7	9.6	13.3	9.5	13.6	9.6	13.8	9.9	14.4	9.6	15.0	9.4	

2-4.Heating Capacity (In combination with PU(H)Y, PURY-(P)200-250-315YEM-A, TEM-A)

PLFY-P-VLMD-A, VLMD-B

SHC:Sensible Heat Capacity(kW)

Unit size	Outdoor air temp. °CWB	Indoor air temp.:°CDB			
		15.0	20.0	25.0	27.0
		SHC	SHC	SHC	SHC
20	-15.0	1.7	1.6	1.6	1.6
	-10.0	1.9	1.9	1.9	1.7
	-5.0	2.1	2.1	2.0	1.7
	0.0	2.4	2.4	2.0	1.7
	2.5	2.5	2.5	2.0	1.7
	6.0	2.5	2.5	2.0	1.7
	7.5	2.6	2.5	2.0	1.7
	10.0	2.8	2.5	2.0	1.7
	12.5	3.0	2.5	2.0	1.7
	15.5	3.0	2.5	2.0	1.7
25	-15.0	2.1	2.1	2.1	2.1
	-10.0	2.4	2.4	2.4	2.2
	-5.0	2.7	2.7	2.5	2.2
	0.0	3.1	3.0	2.5	2.2
	2.5	3.2	3.2	2.5	2.2
	6.0	3.2	3.2	2.5	2.2
	7.5	3.4	3.2	2.5	2.2
	10.0	3.6	3.2	2.5	2.2
	12.5	3.8	3.2	2.5	2.2
	15.5	3.9	3.2	2.5	2.2
32	-15.0	2.7	2.6	2.6	2.6
	-10.0	3.1	3.0	3.0	2.8
	-5.0	3.4	3.4	3.1	2.8
	0.0	3.8	3.8	3.1	2.8
	2.5	4.0	4.0	3.1	2.8
	6.0	4.0	4.0	3.1	2.8
	7.5	4.2	4.0	3.1	2.8
	10.0	4.5	4.0	3.1	2.8
	12.5	4.8	4.0	3.1	2.8
	15.5	4.8	4.0	3.1	2.8
40	-15.0	3.3	3.3	3.3	3.3
	-10.0	3.8	3.8	3.7	3.5
	-5.0	4.3	4.2	3.9	3.5
	0.0	4.8	4.7	3.9	3.5
	2.5	5.0	5.0	3.9	3.5
	6.0	5.1	5.0	3.9	3.5
	7.5	5.3	5.0	3.9	3.5
	10.0	5.6	5.0	3.9	3.5
	12.5	6.0	5.0	3.9	3.5
	15.5	6.1	5.0	3.9	3.5
50	-15.0	4.2	4.2	4.1	4.1
	-10.0	4.8	4.8	4.7	4.3
	-5.0	5.4	5.3	4.9	4.3
	0.0	6.0	5.9	4.9	4.3
	2.5	6.3	6.2	4.9	4.3
	6.0	6.4	6.3	4.9	4.3
	7.5	6.6	6.3	4.9	4.3
	10.0	7.1	6.3	4.9	4.3
	12.5	7.5	6.3	4.9	4.3
	15.5	7.6	6.3	4.9	4.3

Unit size	Outdoor air temp. °CWB	Indoor air temp.:°CDB			
		15.0	20.0	25.0	27.0
		SHC	SHC	SHC	SHC
63	-15.0	5.4	5.3	5.2	5.2
	-10.0	6.1	6.0	6.0	5.5
	-5.0	6.9	6.8	6.2	5.5
	0.0	7.6	7.5	6.2	5.5
	2.5	8.0	7.9	6.2	5.5
	6.0	8.1	8.0	6.2	5.5
	7.5	8.4	8.0	6.2	5.5
	10.0	9.0	8.0	6.2	5.5
	12.5	9.6	8.0	6.2	5.5
	15.5	9.7	8.0	6.2	5.5
80	-15.0	6.7	6.6	6.5	6.5
	-10.0	7.6	7.5	7.4	6.9
	-5.0	8.6	8.5	7.8	6.9
	0.0	9.5	9.4	7.8	6.9
	2.5	10.0	9.9	7.8	6.9
	6.0	10.1	10.0	7.8	6.9
	7.5	10.5	10.0	7.8	6.9
	10.0	11.2	10.0	7.8	6.9
	12.5	12.0	10.0	7.8	6.9
	15.5	12.1	10.0	7.8	6.9
100	-15.0	8.4	8.2	8.2	8.1
	-10.0	9.6	9.4	9.3	8.6
	-5.0	10.7	10.6	9.8	8.6
	0.0	11.9	11.8	9.8	8.6
	2.5	12.5	12.4	9.8	8.6
	6.0	12.6	12.5	9.8	8.6
	7.5	13.2	12.5	9.8	8.6
	10.0	14.1	12.5	9.8	8.6
	12.5	15.0	12.5	9.8	8.6
	15.5	15.1	12.5	9.8	8.6
125	-15.0	10.7	10.6	10.5	10.4
	-10.0	12.2	12.1	11.9	11.0
	-5.0	13.7	13.6	12.5	11.0
	0.0	15.3	15.1	12.5	11.0
	2.5	16.0	15.8	12.5	11.0
	6.0	16.2	16.0	12.5	11.0
	7.5	16.8	16.0	12.5	11.0
	10.0	18.0	16.0	12.5	11.0
	12.5	19.1	16.0	12.5	11.0
	15.5	19.4	16.0	12.5	11.0

PLFY-P-VLMD-A, VLMD-B

2-5.Cooling Capacity (In combination with Big Y, Super Y, Big R2)

PLFY-P-VLMD-A

CA:Capacity(kW)
SHC:Sensible Heat Capacity(kW)

Unit size	Outdoor air temp.	Indoor air temp.												
		21.5°CDB 15°CWB			23°CDB 16°CWB		25°CDB 18°CWB		28°CDB 20°CWB		30°CDB 22°CWB		32°CDB 24°CWB	
		°CDB	CA	SHC	CA	SHC	CA	SHC	CA	SHC	CA	SHC	CA	SHC
20	20.0	2.0	1.7	2.1	1.8	2.3	1.8	2.4	1.9	2.6	1.9	2.7	1.8	
	22.5	2.0	1.7	2.1	1.8	2.3	1.8	2.4	1.9	2.6	1.8	2.7	1.8	
	25.0	2.0	1.7	2.1	1.8	2.2	1.7	2.4	1.9	2.5	1.8	2.7	1.8	
	27.5	2.0	1.7	2.1	1.7	2.2	1.7	2.4	1.8	2.5	1.8	2.6	1.8	
	30.0	2.0	1.7	2.1	1.7	2.2	1.7	2.3	1.8	2.5	1.8	2.6	1.8	
	32.5	2.0	1.7	2.0	1.7	2.2	1.7	2.3	1.8	2.4	1.8	2.6	1.8	
	35.0	1.9	1.7	2.0	1.7	2.1	1.7	2.3	1.8	2.4	1.8	2.5	1.8	
	37.5	1.9	1.6	2.0	1.7	2.1	1.7	2.2	1.8	2.4	1.8	2.5	1.7	
	40.0	1.9	1.6	2.0	1.7	2.1	1.7	2.2	1.8	2.3	1.8	2.4	1.7	
43.0	1.9	1.6	1.9	1.7	2.1	1.7	2.2	1.8	2.3	1.7	2.4	1.7		
25	20.0	2.6	2.0	2.7	2.0	2.9	2.0	3.1	2.2	3.3	2.1	3.5	2.1	
	22.5	2.6	2.0	2.7	2.0	2.9	2.0	3.1	2.1	3.3	2.1	3.4	2.1	
	25.0	2.6	1.9	2.7	2.0	2.9	2.0	3.0	2.1	3.2	2.1	3.4	2.1	
	27.5	2.5	1.9	2.6	2.0	2.8	2.0	3.0	2.1	3.2	2.1	3.3	2.0	
	30.0	2.5	1.9	2.6	2.0	2.8	2.0	3.0	2.1	3.1	2.1	3.3	2.0	
	32.5	2.5	1.9	2.6	2.0	2.8	2.0	2.9	2.1	3.1	2.0	3.2	2.0	
	35.0	2.5	1.9	2.6	2.0	2.7	2.0	2.9	2.1	3.0	2.0	3.2	2.0	
	37.5	2.5	1.9	2.5	2.0	2.7	1.9	2.8	2.0	3.0	2.0	3.1	2.0	
	40.0	2.4	1.9	2.5	1.9	2.7	1.9	2.8	2.0	3.0	2.0	3.1	2.0	
43.0	2.4	1.9	2.5	1.9	2.6	1.9	2.8	2.0	2.9	2.0	3.0	1.9		
32	20.0	3.3	2.4	3.5	2.5	3.7	2.5	4.0	2.6	4.2	2.6	4.5	2.6	
	22.5	3.3	2.4	3.5	2.5	3.7	2.5	4.0	2.6	4.2	2.6	4.4	2.5	
	25.0	3.3	2.4	3.4	2.5	3.7	2.5	3.9	2.6	4.1	2.6	4.4	2.5	
	27.5	3.3	2.4	3.4	2.5	3.6	2.5	3.9	2.6	4.1	2.5	4.3	2.5	
	30.0	3.2	2.4	3.4	2.5	3.6	2.4	3.8	2.6	4.0	2.5	4.2	2.5	
	32.5	3.2	2.4	3.3	2.4	3.5	2.4	3.8	2.5	4.0	2.5	4.2	2.4	
	35.0	3.2	2.3	3.3	2.4	3.5	2.4	3.7	2.5	3.9	2.5	4.1	2.4	
	37.5	3.2	2.3	3.3	2.4	3.5	2.4	3.7	2.5	3.8	2.4	4.0	2.4	
	40.0	3.1	2.3	3.2	2.4	3.4	2.4	3.6	2.5	3.8	2.4	4.0	2.4	
43.0	3.1	2.3	3.2	2.4	3.4	2.3	3.5	2.4	3.7	2.4	3.9	2.3		
40	20.0	4.1	3.1	4.3	3.2	4.7	3.2	5.0	3.4	5.3	3.3	5.6	3.3	
	22.5	4.1	3.1	4.3	3.2	4.6	3.2	4.9	3.3	5.2	3.3	5.5	3.2	
	25.0	4.1	3.1	4.3	3.2	4.6	3.2	4.9	3.3	5.2	3.3	5.5	3.2	
	27.5	4.1	3.0	4.2	3.1	4.5	3.1	4.8	3.3	5.1	3.2	5.4	3.2	
	30.0	4.0	3.0	4.2	3.1	4.5	3.1	4.8	3.3	5.0	3.2	5.3	3.2	
	32.5	4.0	3.0	4.2	3.1	4.4	3.1	4.7	3.2	5.0	3.2	5.2	3.1	
	35.0	4.0	3.0	4.1	3.1	4.4	3.1	4.6	3.2	4.9	3.2	5.1	3.1	
	37.5	3.9	3.0	4.1	3.1	4.3	3.0	4.6	3.2	4.8	3.1	5.1	3.1	
	40.0	3.9	3.0	4.0	3.0	4.3	3.0	4.5	3.2	4.7	3.1	5.0	3.0	
43.0	3.9	2.9	4.0	3.0	4.2	3.0	4.4	3.1	4.7	3.1	4.9	3.0		
50	20.0	5.2	3.8	5.4	3.9	5.8	3.9	6.2	4.1	6.6	4.1	7.0	4.0	
	22.5	5.2	3.8	5.4	3.9	5.8	3.9	6.2	4.1	6.5	4.0	6.9	4.0	
	25.0	5.1	3.8	5.3	3.9	5.7	3.9	6.1	4.1	6.4	4.0	6.8	3.9	
	27.5	5.1	3.7	5.3	3.9	5.6	3.8	6.0	4.0	6.3	4.0	6.7	3.9	
	30.0	5.0	3.7	5.2	3.8	5.6	3.8	5.9	4.0	6.2	3.9	6.6	3.9	
	32.5	5.0	3.7	5.2	3.8	5.5	3.8	5.8	4.0	6.2	3.9	6.5	3.8	
	35.0	4.9	3.7	5.1	3.8	5.4	3.8	5.8	3.9	6.1	3.9	6.4	3.8	
	37.5	4.9	3.6	5.1	3.8	5.4	3.7	5.7	3.9	6.0	3.8	6.3	3.8	
	40.0	4.9	3.6	5.0	3.7	5.3	3.7	5.6	3.9	5.9	3.8	6.2	3.7	
43.0	4.8	3.6	5.0	3.7	5.2	3.7	5.5	3.8	5.8	3.8	6.1	3.7		
63	20.0	6.5	4.8	6.9	5.0	7.4	5.0	7.9	5.3	8.4	5.2	8.9	5.1	
	22.5	6.5	4.8	6.8	5.0	7.3	5.0	7.8	5.3	8.3	5.2	8.7	5.1	
	25.0	6.5	4.8	6.8	5.0	7.2	5.0	7.7	5.2	8.1	5.1	8.6	5.0	
	27.5	6.4	4.8	6.7	4.9	7.2	4.9	7.6	5.2	8.0	5.1	8.5	5.0	
	30.0	6.4	4.7	6.6	4.9	7.1	4.9	7.5	5.1	7.9	5.0	8.4	5.0	
	32.5	6.3	4.7	6.6	4.9	7.0	4.8	7.4	5.1	7.8	5.0	8.2	4.9	
	35.0	6.3	4.7	6.5	4.8	6.9	4.8	7.3	5.0	7.7	5.0	8.1	4.9	
	37.5	6.2	4.7	6.4	4.8	6.8	4.8	7.2	5.0	7.6	4.9	8.0	4.8	
	40.0	6.2	4.6	6.4	4.8	6.7	4.7	7.1	5.0	7.5	4.9	7.9	4.8	
43.0	6.1	4.6	6.3	4.7	6.6	4.7	7.0	4.9	7.3	4.8	7.7	4.7		

PLFY-P-VLMD-B

Cooling Capacity (In combination with Big Y, Super Y, Big R2)

PLFY-P-VLMD-A

CA:Capacity(kW)
SHC:Sensible Heat Capacity(kW)

Unit size	Outdoor air temp.	Indoor air temp.											
		21.5°CDB 15°CWB		23°CDB 16°CWB		25°CDB 18°CWB		28°CDB 20°CWB		30°CDB 22°CWB		32°CDB 24°CWB	
		°CDB	CA	SHC	CA	SHC	CA	SHC	CA	SHC	CA	SHC	CA
80	20.0	8.3	6.0	8.7	6.3	9.4	6.3	10.0	6.6	10.6	6.5	11.2	6.4
	22.5	8.3	6.0	8.7	6.3	9.3	6.2	9.9	6.6	10.5	6.5	11.1	6.3
	25.0	8.2	6.0	8.6	6.2	9.2	6.2	9.8	6.5	10.3	6.4	10.9	6.3
	27.5	8.1	6.0	8.5	6.2	9.1	6.1	9.6	6.4	10.2	6.3	10.8	6.2
	30.0	8.1	5.9	8.4	6.1	9.0	6.1	9.5	6.4	10.0	6.3	10.6	6.2
	32.5	8.0	5.9	8.3	6.1	8.9	6.0	9.4	6.3	9.9	6.2	10.4	6.1
	35.0	8.0	5.9	8.2	6.0	8.8	6.0	9.3	6.3	9.8	6.2	10.3	6.1
	37.5	7.9	5.8	8.1	6.0	8.6	5.9	9.1	6.2	9.6	6.1	10.1	6.0
	40.0	7.8	5.8	8.1	6.0	8.5	5.9	9.0	6.2	9.5	6.1	10.0	5.9
43.0	7.7	5.8	8.0	5.9	8.4	5.8	8.9	6.1	9.3	6.0	9.8	5.9	
100	20.0	10.3	7.9	10.8	8.2	11.6	8.2	12.5	8.7	13.2	8.6	14.0	8.4
	22.5	10.3	7.9	10.8	8.2	11.5	8.2	12.3	8.6	13.0	8.5	13.8	8.4
	25.0	10.2	7.8	10.7	8.1	11.4	8.1	12.1	8.6	12.8	8.4	13.6	8.3
	27.5	10.1	7.8	10.6	8.1	11.3	8.1	12.0	8.5	12.7	8.4	13.4	8.2
	30.0	10.1	7.8	10.5	8.0	11.2	8.0	11.8	8.4	12.5	8.3	13.2	8.2
	32.5	10.0	7.7	10.3	8.0	11.0	7.9	11.7	8.4	12.3	8.2	13.0	8.1
	35.0	9.9	7.7	10.2	8.0	10.9	7.9	11.5	8.3	12.1	8.2	12.8	8.0
	37.5	9.8	7.7	10.1	7.9	10.8	7.8	11.4	8.3	12.0	8.1	12.6	8.0
	40.0	9.7	7.6	10.0	7.9	10.6	7.8	11.2	8.2	11.8	8.0	12.4	7.9
43.0	9.6	7.6	9.9	7.8	10.5	7.7	11.0	8.1	11.6	8.0	12.2	7.8	
125	20.0	12.9	9.6	13.5	10.0	14.6	10.0	15.6	10.6	16.5	10.4	17.5	10.3
	22.5	12.9	9.6	13.5	10.0	14.4	10.0	15.4	10.5	16.3	10.4	17.2	10.2
	25.0	12.8	9.6	13.3	9.9	14.3	9.9	15.2	10.4	16.1	10.3	17.0	10.1
	27.5	12.7	9.5	13.2	9.9	14.1	9.8	15.0	10.4	15.8	10.2	16.7	10.0
	30.0	12.6	9.5	13.1	9.8	13.9	9.8	14.8	10.3	15.6	10.1	16.5	9.9
	32.5	12.5	9.4	12.9	9.8	13.8	9.7	14.6	10.2	15.4	10.0	16.2	9.8
	35.0	12.4	9.4	12.8	9.7	13.6	9.6	14.4	10.1	15.2	9.9	16.0	9.8
	37.5	12.3	9.3	12.7	9.6	13.5	9.5	14.2	10.0	15.0	9.9	15.7	9.7
	40.0	12.2	9.3	12.5	9.6	13.3	9.5	14.0	10.0	14.8	9.8	15.5	9.6
43.0	12.0	9.2	12.4	9.5	13.1	9.4	13.8	9.9	14.5	9.7	15.2	9.5	

2-6.Heating Capacity (In combination with Big Y, Super Y, Big R2)

PLFY-P-VLMD-A

Unit size	Outdoor air temp. °CWB	Indoor air temp.:°CDB			
		15.0	20.0	25.0	27.0
		SHC	SHC	SHC	SHC
20	-15.0	1.6	1.5	1.5	1.5
	-10.0	1.8	1.8	1.7	1.7
	-5.0	2.0	2.0	2.0	1.9
	0.0	2.2	2.2	2.1	1.9
	2.5	2.4	2.3	2.1	1.9
	6.0	2.5	2.5	2.1	1.9
	7.5	2.6	2.5	2.1	1.9
	10.0	2.7	2.5	2.1	1.9
	12.5	2.9	2.5	2.1	1.9
15.5	2.9	2.5	2.1	1.9	
25	-15.0	2.0	2.0	1.9	1.9
	-10.0	2.3	2.2	2.2	2.2
	-5.0	2.6	2.5	2.5	2.5
	0.0	2.9	2.8	2.7	2.5
	2.5	3.0	3.0	2.7	2.5
	6.0	3.2	3.2	2.7	2.5
	7.5	3.3	3.2	2.7	2.5
	10.0	3.5	3.2	2.7	2.5
	12.5	3.7	3.2	2.7	2.5
15.5	3.7	3.2	2.7	2.5	
32	-15.0	2.5	2.5	2.4	2.4
	-10.0	2.8	2.8	2.8	2.7
	-5.0	3.2	3.2	3.1	3.1
	0.0	3.6	3.5	3.4	3.1
	2.5	3.8	3.7	3.4	3.1
	6.0	4.0	4.0	3.4	3.1
	7.5	4.2	4.0	3.4	3.1
	10.0	4.4	4.0	3.4	3.1
	12.5	4.6	4.0	3.4	3.1
15.5	4.6	4.0	3.4	3.1	
40	-15.0	3.1	3.1	3.0	3.0
	-10.0	3.6	3.5	3.5	3.4
	-5.0	4.0	4.0	3.9	3.9
	0.0	4.5	4.4	4.3	3.9
	2.5	4.7	4.7	4.3	3.9
	6.0	5.0	5.0	4.3	3.9
	7.5	5.2	5.0	4.3	3.9
	10.0	5.4	5.0	4.3	3.9
	12.5	5.7	5.0	4.3	3.9
15.5	5.8	5.0	4.3	3.9	
50	-15.0	3.9	3.9	3.8	3.7
	-10.0	4.5	4.4	4.3	4.3
	-5.0	5.0	5.0	4.9	4.9
	0.0	5.6	5.6	5.4	4.9
	2.5	5.9	5.9	5.4	4.9
	6.0	6.4	6.3	5.4	4.9
	7.5	6.6	6.3	5.4	4.9
	10.0	6.9	6.3	5.4	4.9
	12.5	7.2	6.3	5.4	4.9
15.5	7.2	6.3	5.4	4.9	

SHC:Sensible Heat Capacity(kW)

Unit size	Outdoor air temp. °CWB	Indoor air temp.:°CDB			
		15.0	20.0	25.0	27.0
		SHC	SHC	SHC	SHC
63	-15.0	5.0	4.9	4.8	4.7
	-10.0	5.7	5.6	5.5	5.4
	-5.0	6.4	6.3	6.2	6.2
	0.0	7.2	7.1	6.8	6.2
	2.5	7.5	7.5	6.8	6.2
	6.0	8.1	8.0	6.8	6.2
	7.5	8.3	8.0	6.8	6.2
	10.0	8.7	8.0	6.8	6.2
	12.5	9.1	8.0	6.8	6.2
15.5	9.2	8.0	6.8	6.2	
80	-15.0	6.2	6.1	6.0	5.9
	-10.0	7.1	7.0	6.9	6.8
	-5.0	8.0	7.9	7.8	7.7
	0.0	8.9	8.8	8.5	7.7
	2.5	9.4	9.3	8.5	7.7
	6.0	10.1	10.0	8.5	7.7
	7.5	10.4	10.0	8.5	7.7
	10.0	10.9	10.0	8.5	7.7
	12.5	11.4	10.0	8.5	7.7
15.5	11.5	10.0	8.5	7.7	
100	-15.0	7.8	7.7	7.5	7.4
	-10.0	8.9	8.8	8.6	8.5
	-5.0	10.0	9.9	9.8	9.6
	0.0	11.2	11.0	10.6	9.6
	2.5	11.8	11.6	10.6	9.6
	6.0	12.6	12.5	10.6	9.6
	7.5	13.0	12.5	10.6	9.6
	10.0	13.6	12.5	10.6	9.6
	12.5	14.3	12.5	10.6	9.6
15.5	14.4	12.5	10.6	9.6	
125	-15.0	10.0	9.8	9.6	9.5
	-10.0	11.4	11.2	11.0	10.9
	-5.0	12.8	12.6	12.5	12.3
	0.0	14.3	14.1	13.6	12.3
	2.5	15.1	14.9	13.6	12.3
	6.0	16.2	16.0	13.6	12.3
	7.5	16.6	16.0	13.6	12.3
	10.0	17.4	16.0	13.6	12.3
	12.5	18.3	16.0	13.6	12.3
15.5	18.4	16.0	13.6	12.3	

2-7.Cooling Capacity (In combination with WY, WR2)

CA:Capacity(kW)

SHC:Sensible Heat Capacity(kW)

PLFY-P-VLMD-A, VLMD-B

Unit size	Water temp. °C	Indoor air temp.													
		21.5°CDB 15°CWB		23°CDB 16°CWB		25°CDB 18°CWB		27°CDB 19°CWB		28°CDB 20°CWB		30°CDB 22°CWB		32°CDB 24°CWB	
		CA	SHC	CA	SHC	CA	SHC	CA	SHC	CA	SHC	CA	SHC	CA	SHC
20	10	2.1	1.8	2.2	1.8	2.4	1.8	2.4	1.8	2.5	1.9	2.6	1.9	2.8	1.8
	20	2.1	1.7	2.1	1.8	2.3	1.8	2.3	1.8	2.4	1.9	2.5	1.8	2.7	1.8
	30	2.0	1.7	2.0	1.7	2.1	1.7	2.2	1.7	2.3	1.8	2.4	1.8	2.5	1.8
	40	1.7	1.5	1.8	1.6	1.9	1.6	1.9	1.6	2.0	1.7	2.1	1.7	2.2	1.7
	45	1.6	1.5	1.7	1.6	1.8	1.6	1.8	1.6	1.9	1.7	2.0	1.6	2.1	1.6
25	10	2.7	2.0	2.8	2.1	3.0	2.1	3.1	2.1	3.2	2.2	3.3	2.1	3.5	2.1
	20	2.6	2.0	2.7	2.0	2.9	2.0	3.0	2.1	3.1	2.1	3.2	2.1	3.4	2.1
	30	2.5	1.9	2.6	2.0	2.7	2.0	2.8	2.0	2.9	2.1	3.0	2.0	3.2	2.0
	40	2.2	1.8	2.2	1.8	2.4	1.8	2.4	1.8	2.5	1.9	2.6	1.9	2.8	1.9
	45	2.0	1.7	2.1	1.8	2.2	1.7	2.3	1.8	2.4	1.9	2.5	1.8	2.6	1.8
32	10	3.5	2.5	3.6	2.6	3.9	2.6	4.0	2.6	4.1	2.7	4.3	2.7	4.5	2.6
	20	3.4	2.5	3.5	2.6	3.7	2.5	3.8	2.6	3.9	2.7	4.1	2.6	4.4	2.6
	30	3.2	2.4	3.3	2.5	3.5	2.4	3.6	2.5	3.7	2.6	3.9	2.5	4.1	2.5
	40	2.8	2.2	2.9	2.3	3.1	2.2	3.1	2.3	3.2	2.4	3.4	2.3	3.6	2.3
	45	2.6	2.1	2.7	2.2	2.9	2.2	3.0	2.2	3.0	2.3	3.2	2.3	3.4	2.2
40	10	4.4	3.0	4.5	3.1	4.8	3.1	5.0	3.1	5.1	3.2	5.4	3.1	5.7	3.1
	20	4.2	2.9	4.4	3.0	4.6	3.0	4.8	3.0	4.9	3.1	5.2	3.0	5.5	3.0
	30	4.0	2.8	4.1	2.9	4.4	2.8	4.5	2.8	4.6	2.9	4.9	2.9	5.2	2.8
	40	3.5	2.5	3.6	2.6	3.8	2.6	3.9	2.6	4.0	2.7	4.3	2.6	4.5	2.6
	45	3.3	2.4	3.4	2.5	3.6	2.5	3.7	2.5	3.8	2.6	4.0	2.5	4.2	2.5
50	10	5.5	3.8	5.6	3.9	6.0	3.8	6.2	3.9	6.3	4.0	6.7	3.9	7.1	3.8
	20	5.3	3.7	5.4	3.8	5.8	3.7	5.9	3.8	6.1	3.9	6.5	3.8	6.8	3.7
	30	5.0	3.5	5.1	3.6	5.5	3.6	5.6	3.6	5.8	3.7	6.1	3.7	6.4	3.6
	40	4.3	3.2	4.5	3.3	4.7	3.2	4.9	3.3	5.0	3.4	5.3	3.3	5.6	3.3
	45	4.1	3.1	4.2	3.1	4.5	3.1	4.6	3.2	4.7	3.3	5.0	3.2	5.3	3.2
63	10	6.9	4.9	7.2	5.0	7.6	5.0	7.8	5.0	8.0	5.2	8.5	5.1	9.0	5.0
	20	6.7	4.7	6.9	4.9	7.3	4.8	7.5	4.9	7.8	5.0	8.2	5.0	8.6	4.9
	30	6.3	4.5	6.5	4.7	6.9	4.6	7.1	4.7	7.3	4.8	7.7	4.8	8.1	4.7
	40	5.5	4.1	5.7	4.3	6.0	4.2	6.2	4.3	6.4	4.4	6.7	4.4	7.1	4.3
	45	5.2	4.0	5.3	4.1	5.7	4.1	5.8	4.1	6.0	4.3	6.3	4.2	6.7	4.1
80	10	8.8	6.3	9.1	6.5	9.6	6.4	9.9	6.5	10.2	6.7	10.8	6.6	11.4	6.5
	20	8.5	6.1	8.7	6.3	9.3	6.2	9.5	6.3	9.8	6.5	10.4	6.4	10.9	6.3
	30	8.0	5.9	8.3	6.1	8.8	6.0	9.0	6.1	9.3	6.3	9.8	6.2	10.3	6.1
	40	6.9	5.4	7.2	5.5	7.6	5.5	7.8	5.6	8.1	5.8	8.5	5.7	9.0	5.6
	45	6.5	5.2	6.8	5.3	7.2	5.3	7.4	5.4	7.6	5.6	8.0	5.5	8.5	5.4
100	10	10.9	8.2	11.3	8.4	12.0	8.4	12.3	8.5	12.7	8.8	13.4	8.7	14.1	8.5
	20	10.5	8.0	10.9	8.3	11.6	8.2	11.9	8.3	12.2	8.6	12.9	8.5	13.6	8.3
	30	9.9	7.7	10.3	8.0	10.9	7.9	11.2	8.0	11.5	8.3	12.2	8.2	12.8	8.0
	40	8.6	7.1	8.9	7.3	9.5	7.3	9.7	7.4	10.0	7.7	10.6	7.6	11.2	7.5
	45	8.1	6.9	8.4	7.1	8.9	7.1	9.2	7.2	9.5	7.5	10.0	7.4	10.5	7.3
125	10	13.7	10.0	14.1	10.3	15.0	10.2	15.4	10.3	15.9	10.7	16.7	10.5	17.7	10.4
	20	13.2	9.8	13.6	10.1	14.5	10.0	14.8	10.1	15.3	10.5	16.1	10.3	17.0	10.1
	30	12.4	9.4	12.8	9.7	13.6	9.6	14.0	9.7	14.4	10.1	15.2	10.0	16.1	9.8
	40	10.8	8.6	11.2	8.9	11.9	8.8	12.2	9.0	12.5	9.4	13.2	9.2	14.0	9.1
	45	10.2	8.3	10.5	8.6	11.2	8.6	11.5	8.7	11.8	9.1	12.5	8.9	13.2	8.8

PLFY-P-VLMD-A, VLMD-B

2-8.Heating Capacity (In combination with WY, WR2)

PLFY-P-VLMD-A, VLMD-B

SHC:Sensible Heat Capacity(kW)

Unit size	Water temp.	Indoor air temp.:°CDB				
		15	19	20	25	27
	°C	SHC	SHC	SHC	SHC	SHC
20	10	2.2	2.2	2.1	1.7	1.5
	20	2.6	2.6	2.5	2.0	1.8
	30	2.6	2.6	2.5	2.0	1.8
	40	2.7	2.7	2.6	2.1	1.9
	45	2.9	2.9	2.9	2.3	2.1
25	10	2.8	2.8	2.7	2.2	2.0
	20	3.3	3.3	3.2	2.6	2.3
	30	3.3	3.3	3.2	2.6	2.3
	40	3.4	3.4	3.3	2.7	2.4
	45	3.8	3.7	3.6	2.9	2.6
32	10	3.5	3.5	3.4	2.7	2.4
	20	4.1	4.1	4.0	3.2	2.9
	30	4.1	4.1	4.0	3.2	2.9
	40	4.3	4.2	4.2	3.3	3.0
	45	4.7	4.7	4.6	3.6	3.3
40	10	4.4	4.3	4.3	3.4	3.1
	20	5.2	5.1	5.0	4.0	3.6
	30	5.2	5.1	5.0	4.0	3.6
	40	5.4	5.3	5.2	4.2	3.7
	45	5.9	5.8	5.7	4.6	4.1
50	10	5.5	5.5	5.4	4.3	3.9
	20	6.5	6.4	6.3	5.0	4.5
	30	6.5	6.4	6.3	5.0	4.5
	40	6.7	6.7	6.6	5.2	4.7
	45	7.4	7.3	7.2	5.7	5.2
63	10	7.0	6.9	6.8	5.4	4.9
	20	8.2	8.2	8.0	6.4	5.8
	30	8.2	8.2	8.0	6.4	5.8
	40	8.6	8.5	8.3	6.7	6.0
	45	9.4	9.3	9.1	7.3	6.6
80	10	8.8	8.7	8.5	6.8	6.1
	20	10.3	10.2	10.0	8.0	7.2
	30	10.3	10.2	10.0	8.0	7.2
	40	10.7	10.6	10.4	8.3	7.5
	45	11.7	11.6	11.4	9.1	8.2
100	10	10.9	10.8	10.6	8.5	7.7
	20	12.9	12.8	12.5	10.0	9.0
	30	12.9	12.8	12.5	10.0	9.0
	40	13.4	13.3	13.0	10.4	9.4
	45	14.7	14.5	14.3	11.4	10.3
125	10	14.0	13.9	13.6	10.9	9.8
	20	16.5	16.3	16.0	12.8	11.5
	30	16.5	16.3	16.0	12.8	11.5
	40	17.1	17.0	16.6	13.3	12.0
	45	18.8	18.6	18.2	14.6	13.1

3. Sound Levels

3-1. Noise level

Cassette ceiling

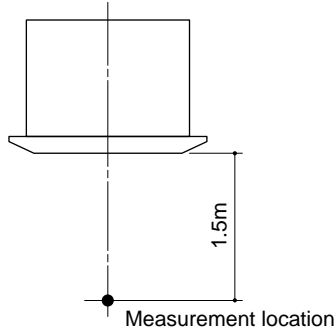

Noise level at anechoic room
(Low - Middle - High)

Unit : dB(A)

Model	Noise level (A weighted)	
	220V,240V	230V
PLFY-P20VLMD-B	27-30-33	28-31-34
PLFY-P25VLMD-B		
PLFY-P32VLMD-B		
PLFY-P40VLMD-B	29-33-36	30-34-37
PLFY-P50VLMD-B	31-34-37	32-35-38
PLFY-P63VLMD-B	32-37-39	33-38-40
PLFY-P80VLMD-A	36-38-41-43	
PLFY-P100VLMD-A	37-39-41-43	
PLFY-P125VLMD-A	40-42-44-46	

3-2. NC curves

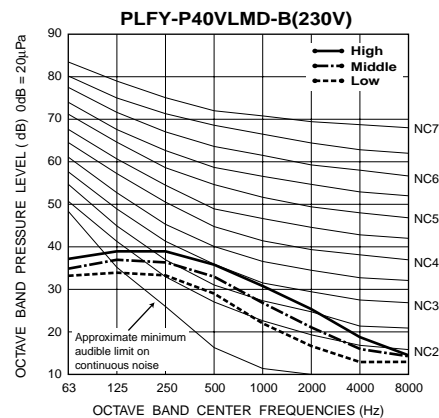
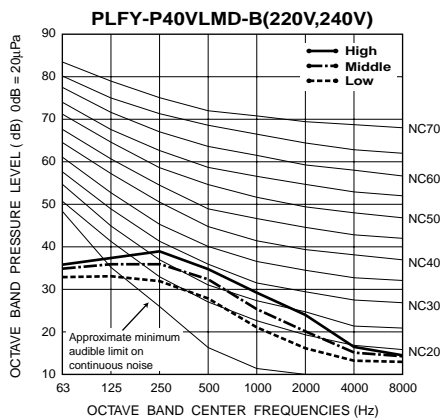
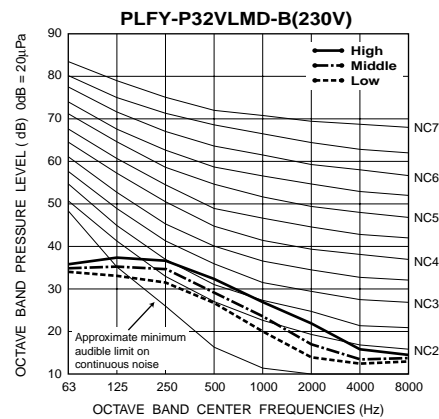
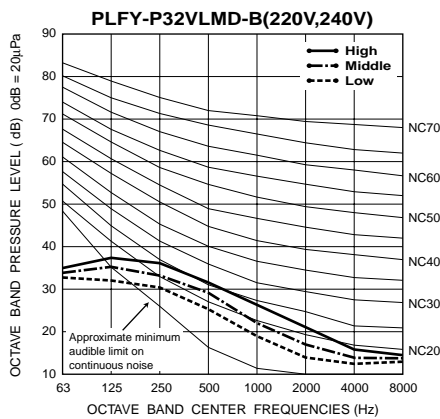
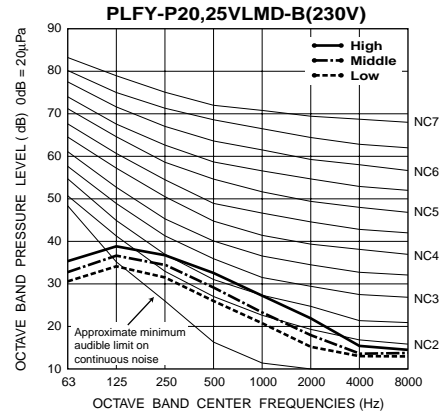
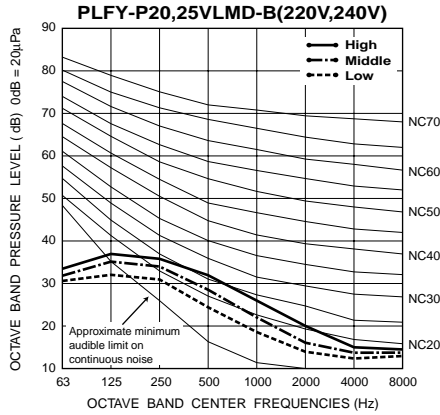

PLFY-P-VLMD-A/VLMD-B

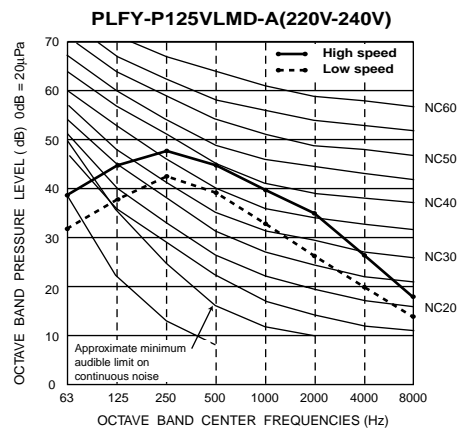
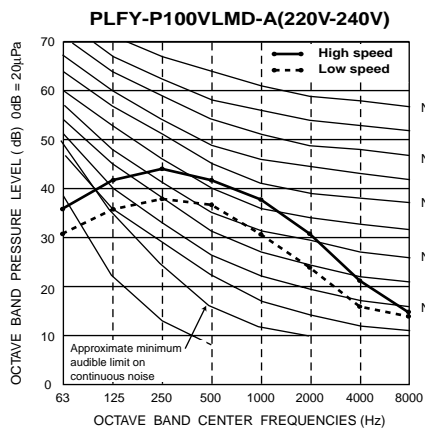
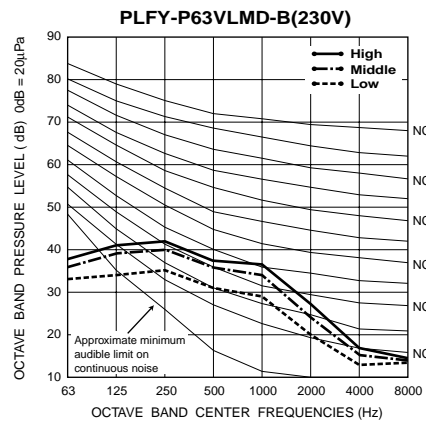
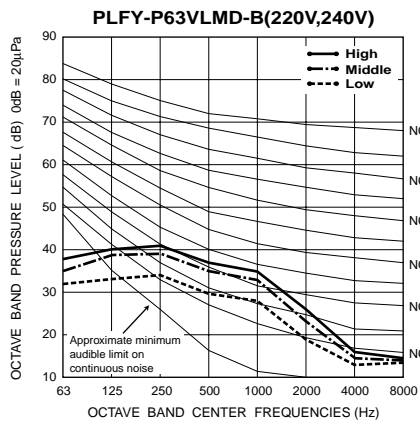
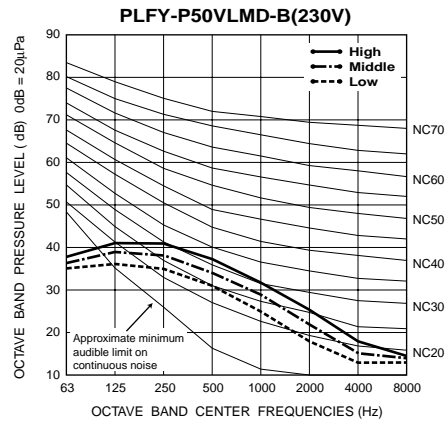
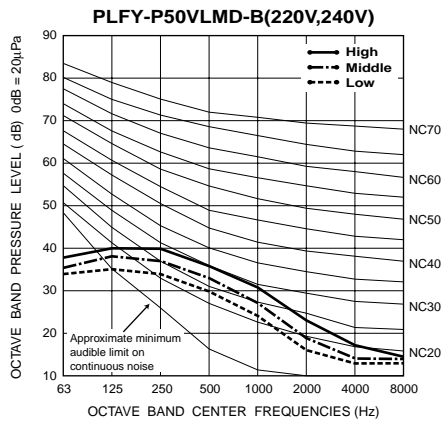

3-3. OA Intake-static pressure curve

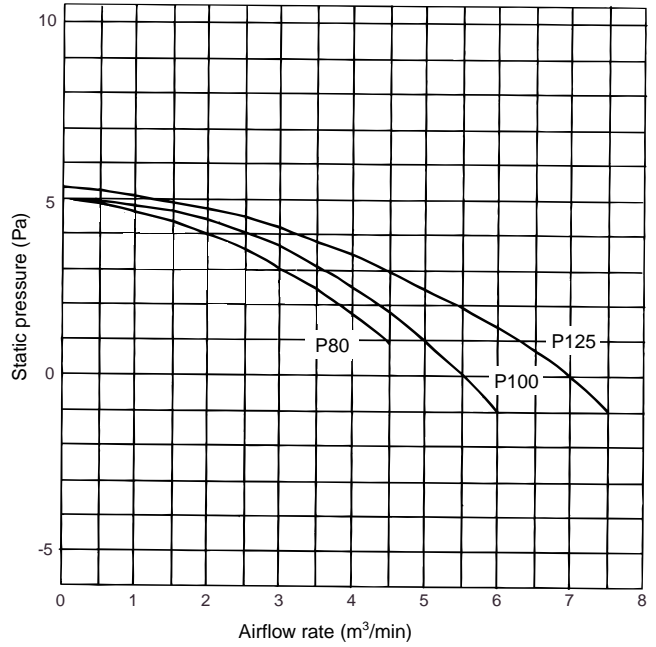
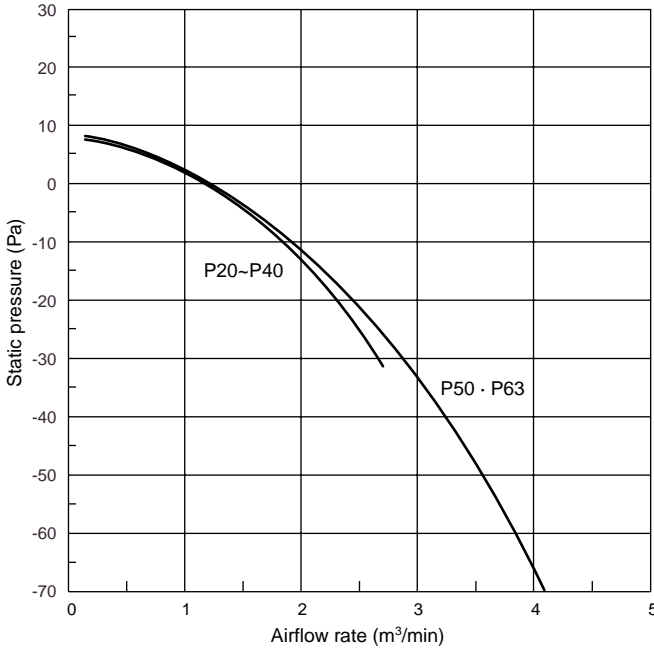

Please confirm that inlet-air temperature (which is mixed with outdoor air) is in the following operating temperature range.

-P-VLMD-B : Operating temperature range

Mode	Temperature range of inlet air
Cooling	15°C~24°C(Wet bulb)
Dry	
Heating	15°C~27°C(Dry bulb)

*Relative humidity range is 30~80%.

3-4. Branch duct Intake-static pressure curve

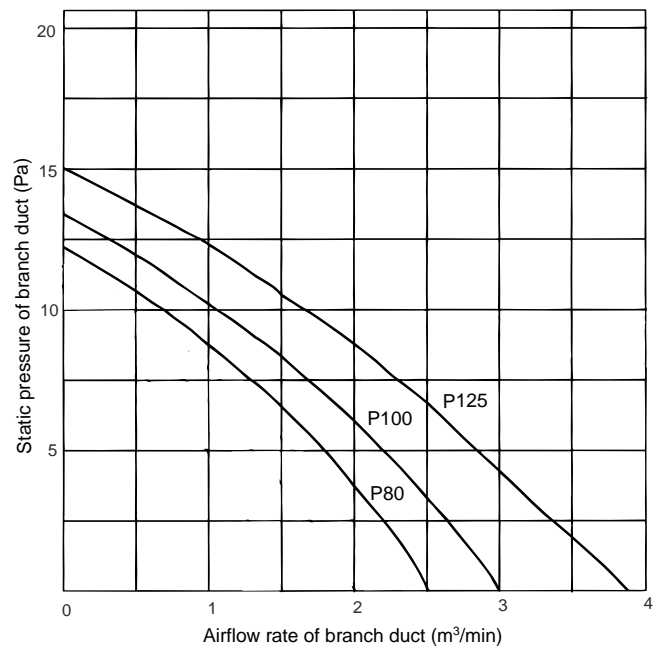
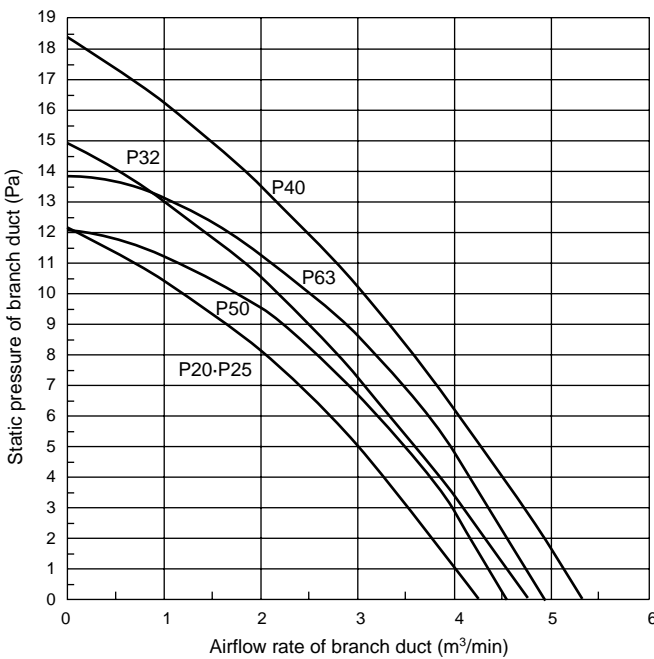

P125-P-
VLMD-A/VLMD-B

4. External Dimensions

PLFY-P20, 25, 32, 40, 50, 63VLM-D-B

Unit : mm

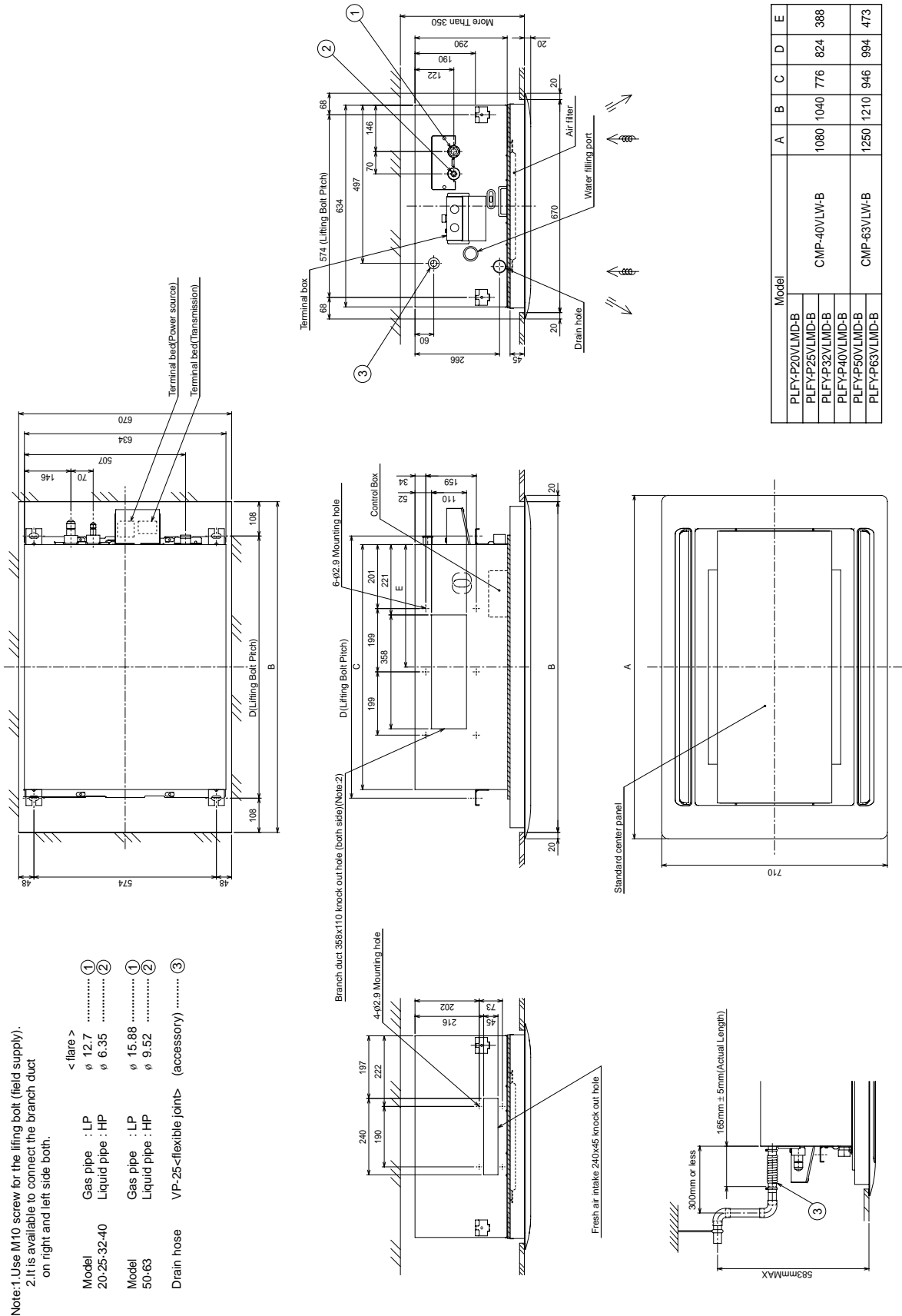

Note:1. Use M10 screw for the lifting bolt (field supply).
 2. It is available to connect the branch duct on right and left side both.

- < flare >
- | | | |
|-------------|-----------------------------------|---------|
| Model | Gas pipe : LP | ① |
| 20-25-32-40 | Liquid pipe : HP | φ 12.7 |
| | | φ 6.35 |
| Model | Gas pipe : LP | ① |
| 50-63 | Liquid pipe : HP | φ 15.88 |
| | | φ 9.52 |
| Drain hose | VP-25-flexible joint< accessory > | ③ |

Model	A	B	C	D	E
PLFY-P20VLM-D-B					
PLFY-P25VLM-D-B					
PLFY-P32VLM-D-B					
PLFY-P40VLM-D-B					
PLFY-P50VLM-D-B					
PLFY-P63VLM-D-B					
CMP-40VLM-B	1080	1040	776	824	388
CMP-63VLM-B	1250	1210	946	994	473



**PLFY-P20, 25, 32, 40, 50,
63VLM-D-B
with OA duct flange**

Unit : mm

Note:1, Use M10 screw for the lifting bolt (field supply).
2, It is available to connect the branch duct on right and left side both.

- | | | |
|-------------|-----------------------|---------------|
| | < flare > | |
| Model | Gas pipe : LP | ① |
| 20-25-32-40 | Liquid pipe : HP | ② |
| Model | Gas pipe : LP | ① |
| 50-63 | Liquid pipe : HP | ② |
| Drain hose | VP-25<flexible joint> | (accessory) ③ |

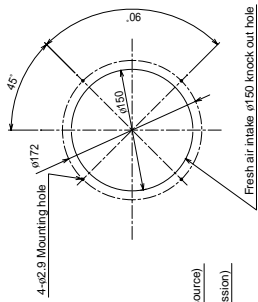
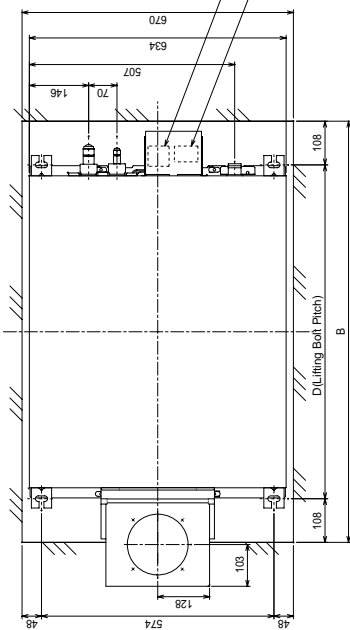

Fresh air intake knock out dimension.

Terminal bed(Power source)
Terminal bed (Transmission)

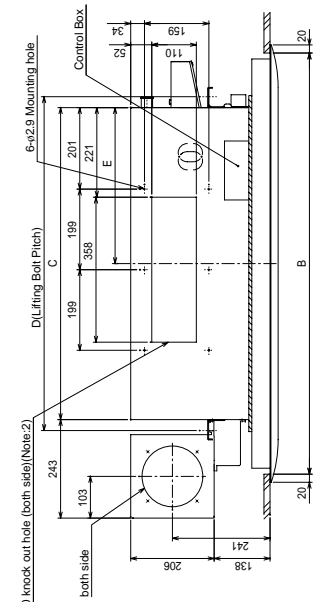
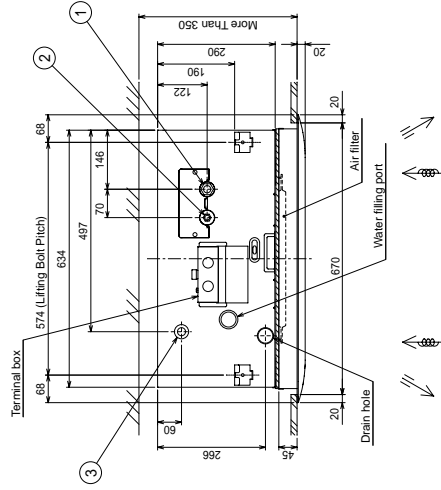

Branch duct 35×110 knock out hole (both side)(Note 2)

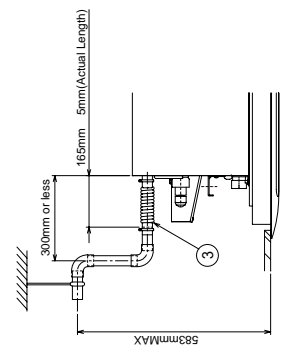
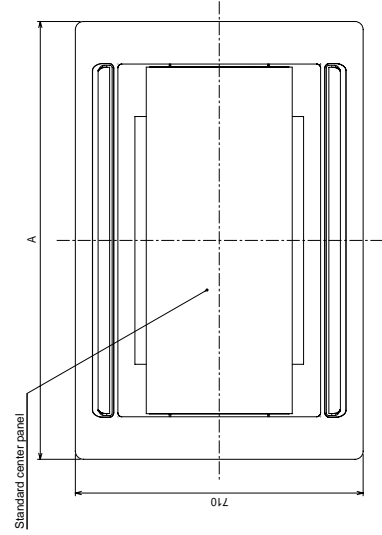
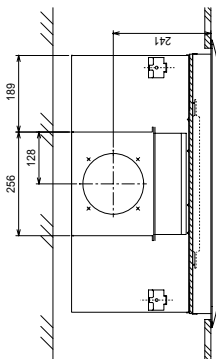

Model	A	B	C	D	E
PLFY-P20VLM-D-B					
PLFY-P25VLM-D-B	1080	1040	776	824	388
PLFY-P32VLM-D-B					
PLFY-P40VLM-D-B					
PLFY-P50VLM-D-B	1250	1210	946	994	473
PLFY-P63VLM-D-B					

PLFY-P80VLM-D-A

Unit : mm

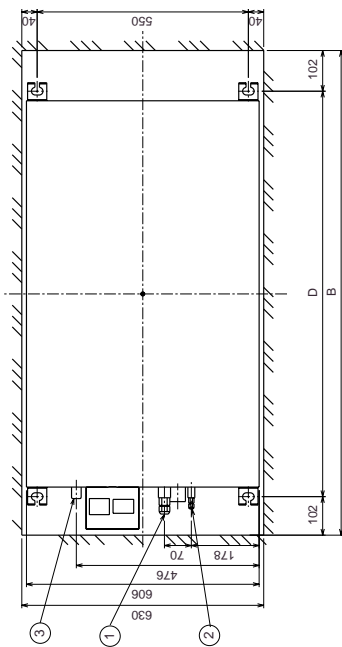

- Note: 1 Use M10 screw for the lifting bolt (field supply).
 Model 20 : LP ϕ 12.7 (1)
 : HP ϕ 6.35 (2)
 Model 50 : LP ϕ 15.88 (1)
 : HP ϕ 9.52 (2)
 Drain hose VP-25<flexible joint> (accessory) (3)

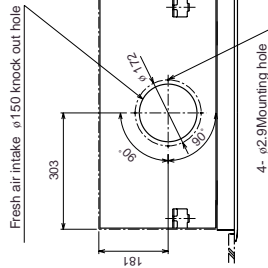
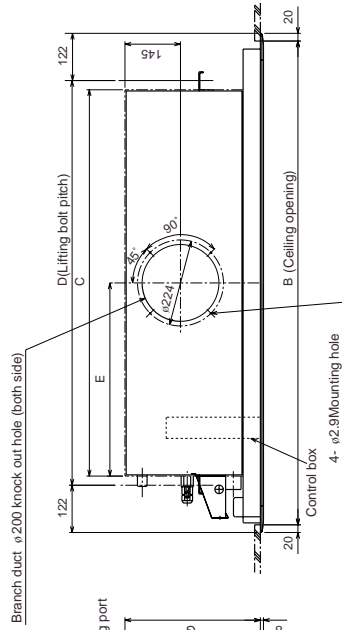
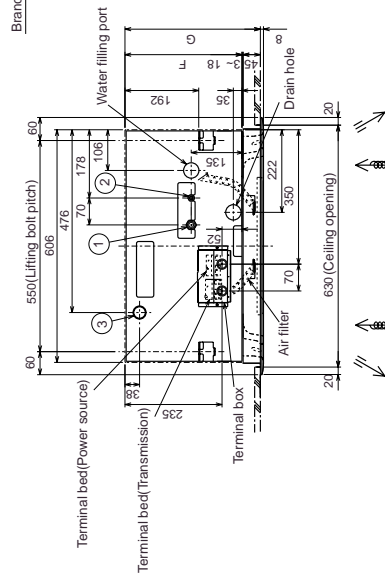

Model	A	B	C	D	E	F	G
PLFY-P20VLM-D-A	1060	1020	768	816	386	Standard center panel 290	Standard center panel 338-353
P25							
P32	300	1260	1008	1056	506		
P40							
P50							
P63	1650	1610	1358	1406	681		
P80							

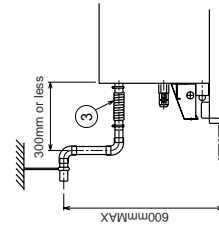
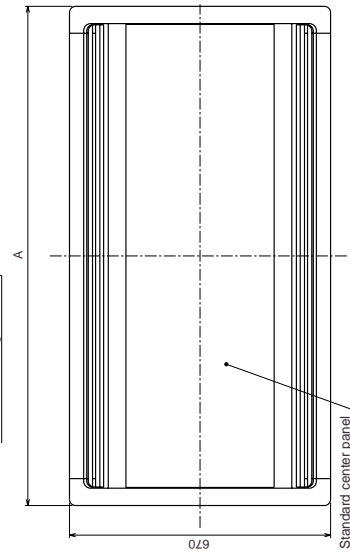

PLFY-P100, 125VLM-D-A

Unit : mm

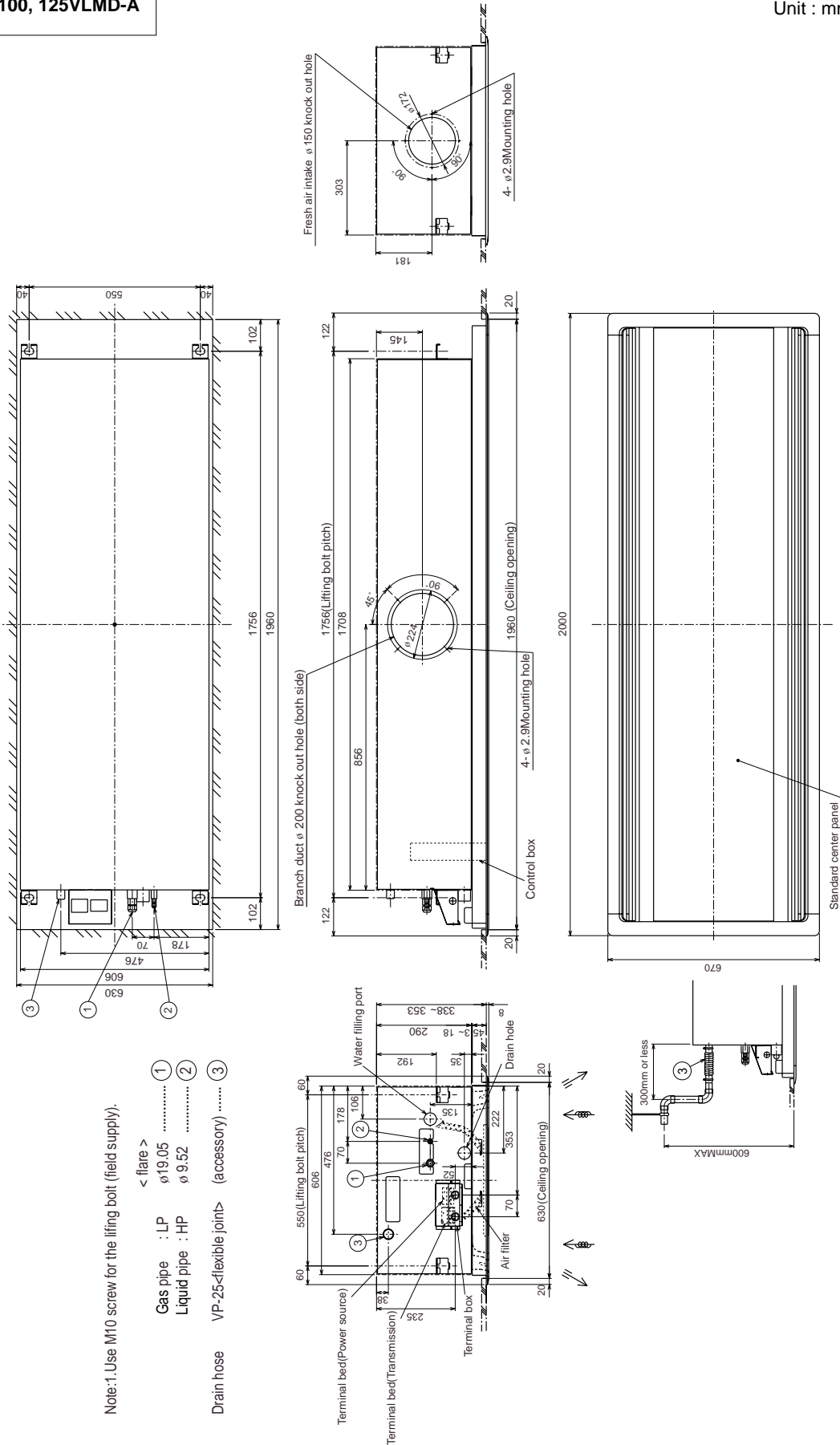

Note: 1. Use M10 screw for the lifting bolt (field supply).

- < flare >
- Gas pipe : LP ①
 - Liquid pipe : HP ②
 - Drain hose VP-25<flexible joint> (accessory) ③

PLY-P-100, 125VLM-D-B

5. Electrical Wiring Diagram

● PLFY-P20~63VLM-D-B

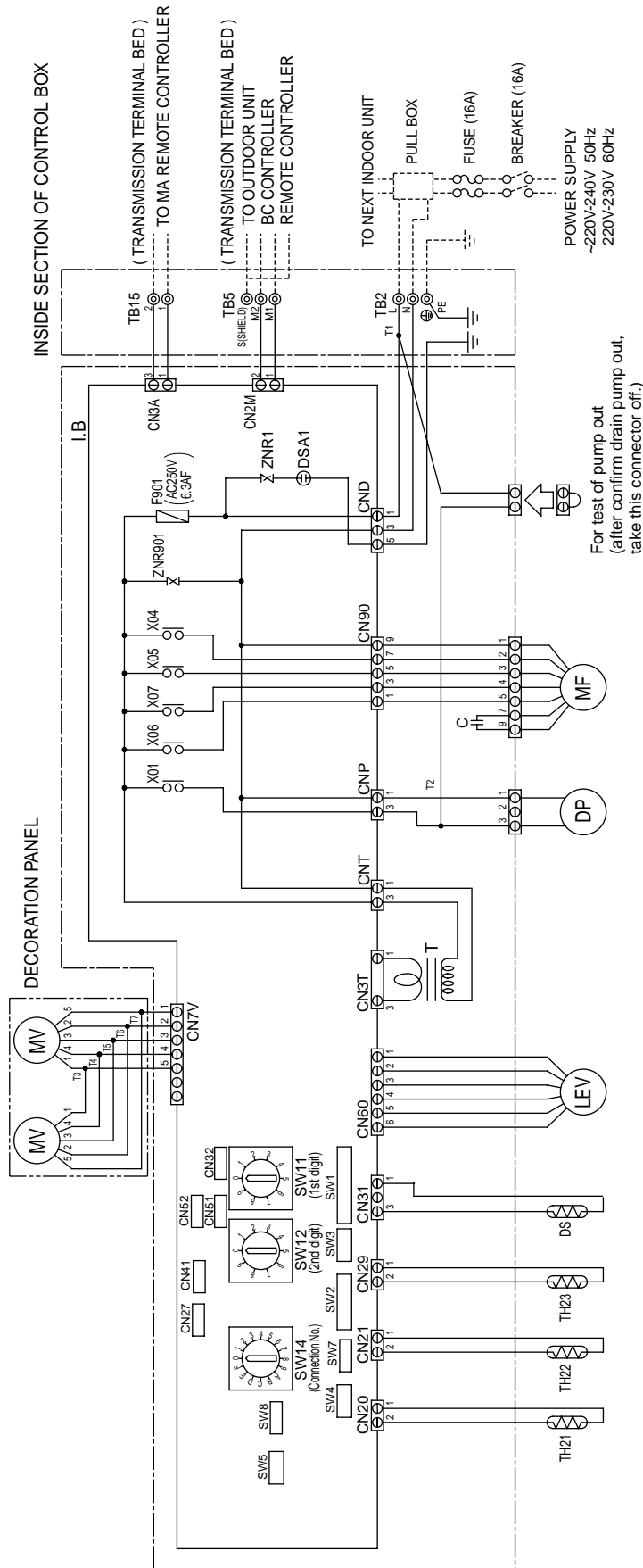

For test of pump out
(after confirm drain pump out,
take this connector off.)

NOTE : 1. TB2, TB5, and TB15 shown in dotted line are field work.
2. Mark ⊕ indicates terminal bed, ⊕ connector, ⊕ board insertion connector of fastening connector of control board.

SYMBOL EXPLANATION

SYMBOL	NAME	SYMBOL	NAME	SYMBOL	NAME
MF	Fan motor	CN27	Connector (Damper)	SW11	Switch (1st digit address set)
C	Capacitor(for MF)	CN32	Connector (Centrally control)	SW12	Switch (2nd digit address set)
I.B	Indoor controller board	CN41	Connector (HA terminal-A)	SW14	Switch (connection No.set)
TB2	Power source terminal bed	CN51	Connector (Centrally control)	SW1	Switch (for mode selection 1)
TB5	Transmission terminal bed	CN52	Connector (Remote indication)	SW2	Switch (for capacity code)
TB15	MA Remote controller terminal bed	X01	Aux.relay (Drain pump)	SW3	Switch (for mode selection 2)
F901	Fuse (6.3A/6A)	X04	Aux.relay (L notch;240V)	SW4	Switch (for model selection)
ZNR1,ZNR901	Varistor	X05	Aux.relay (M/L notch;240V/220-230V)	SW5	Switch (for voltage selection)
T	Transformer	X06	Aux.relay (H notch;220-230V)	SW7	Switch (for model selection)
DP	Drain pump	X07	Aux.relay (H/M notch;240V/220-230V)	SW8	Switch (for mode selection 3)
LEV	Electronic linear expan.valve	TH21	Thermistor (inlet temp.detection)	T1~T7	Terminal
DS	Drain sensor	TH22	Thermistor (pipe temp.detection/liquid)		
MV	Motor for vane	TH23	Thermistor (pipe temp.detection/gas)		



● PLFY-P80~125VLMD-A

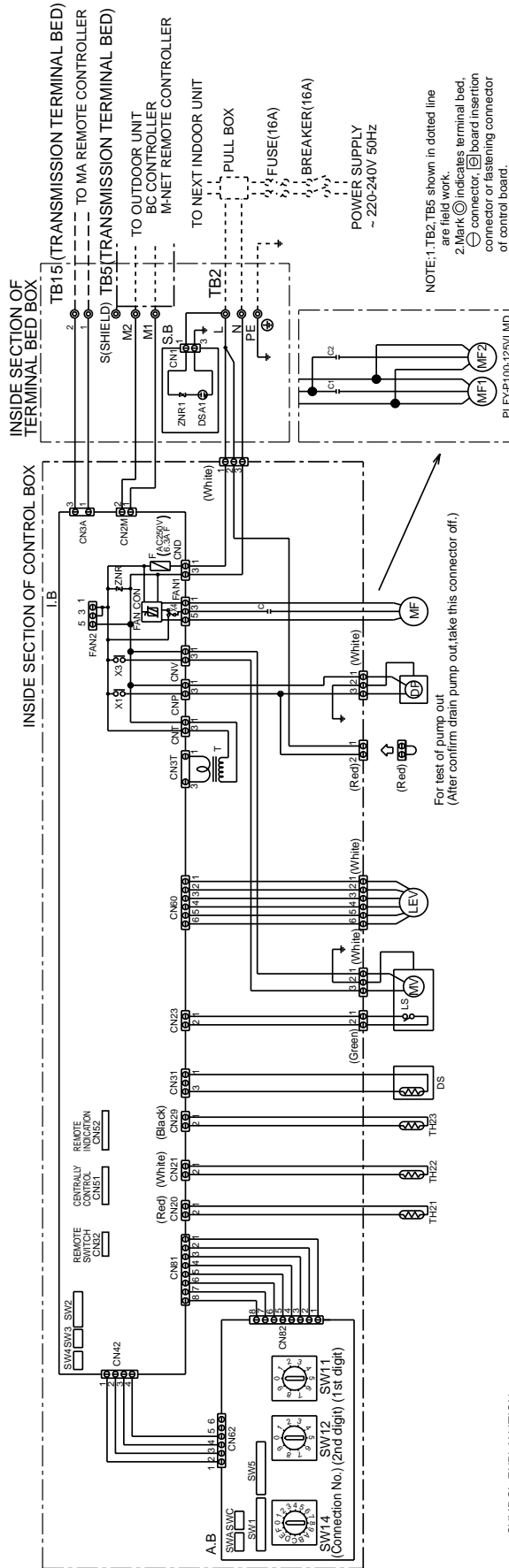

NOTE: 1. TB2, TB5 shown in dotted line are field work.
 2. Mark (⊙) indicates terminal bed, (⊕) board insertion connector, (⊖) board insertion connector or fastening connector of control board.

* Capacitor
 MODELS 20/25/32 2.5μF
 MODELS 40/80 5.0μF
 MODELS 50 4.0μF
 MODELS 63 6.0μF
 MODELS 100/125 5.0μF X 2

SYMBOL	EXPLANATION	SYMBOL	NAME	SYMBOL	NAME
MF, MF1, MF2	Fan motor	LEV	Electronic linear expan. valve	SW14(A,B)	Switch (connection No. set)
C, C1, C2	* Capacitor (for MF, MF1, MF2)	S, B	Surge absorber board	SW1(A,B)	Switch (for mode selection)
LB	Indoor controller board	LS	Limit switch (MV built in)	SW2(L,B)	Switch (for capacity code)
A, B	Address board	MV	Motor for valve (with limit switch)	SW3(L,B)	Switch (for mode selection)
TB2	Power source terminal bed	DS	Drain sensor	SW4(L,B)	Switch (for mode selection)
TB5	Transmission terminal bed	TH21	Thermistor (inlet temp. detection)	SW5(A,B)	Switch (for voltage selection)
TB15	Transmission terminal bed	TH22	Thermistor (pipe temp. detection / liquid)	SWA(A,B)	Switch (option parts)
F	Fuse AC250V 6.3A F	TH23	Thermistor (pipe temp. detection / gas)	SWC(A,B)	Switch (option parts)
T	Transformer	SW1(A,B)	Switch (1st digit address set)	X1, X3, X4	Aux. relay
DP	Drain pump	SW12(A,B)	Switch (2nd digit address set)		

6. Temperature/Airflow distribution

●Temperature distribution

- PLFY-P20~63VLMD-B

< Cooling mode >

Airflow angle : Horizontal Room temp.: 27°C Airflow rate : High

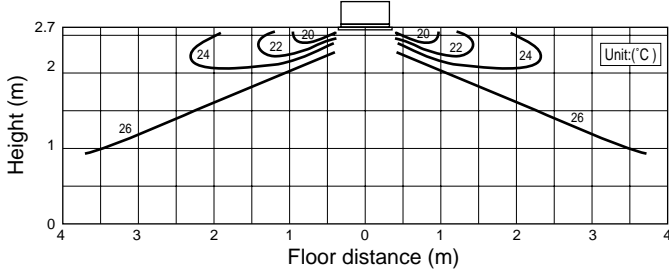

< Heating mode >

Airflow angle : Downward Room temp.: 20°C Airflow rate : High

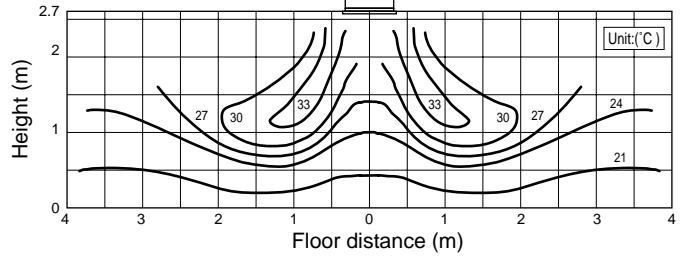

- PLFY-P80~125VLMD-A

<Cooling mode>

Flow angle : 20° Room temp. : 27°C

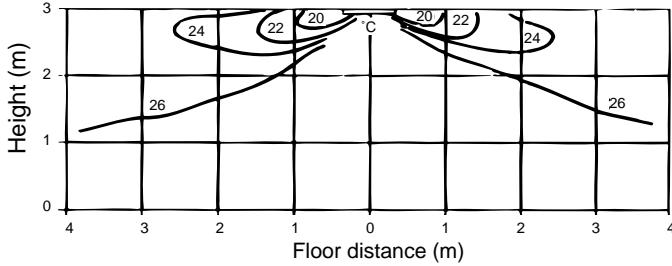

<Heating mode>

Flow angle : 70° Room temp. : 20°C

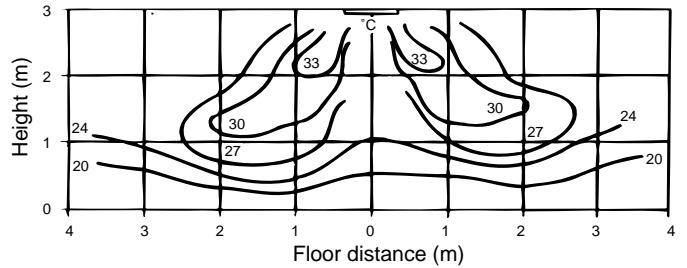

Airflow rate : Low Flow angle : 70° Room temp. : 21°C

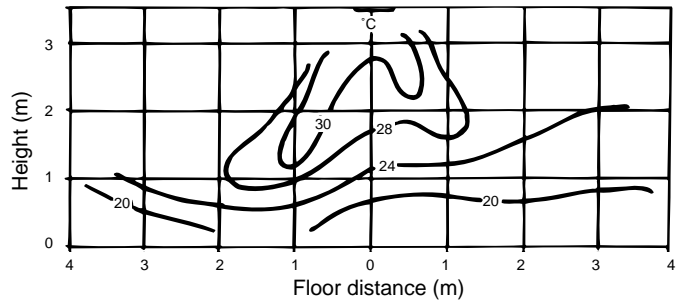

note : These figures show typical temperature distributions in the conditions above. In the actual installation, they may differ from these figures under the influence of air temperature conditions, ceiling height, cooling/heating load,obstacles,etc.

PLFY-P-
VLMD-A/VLMD-B

● Airflow distribution

– PLFY-P20~63VLMD-B

< Cooling mode >

Airflow angle : Horizontal Room temp. : 27°C Airflow rate : High

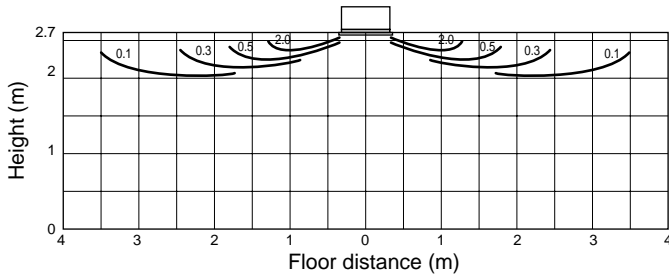

< Heating mode >

Airflow angle : Downward Room temp. : 20°C Airflow rate : High

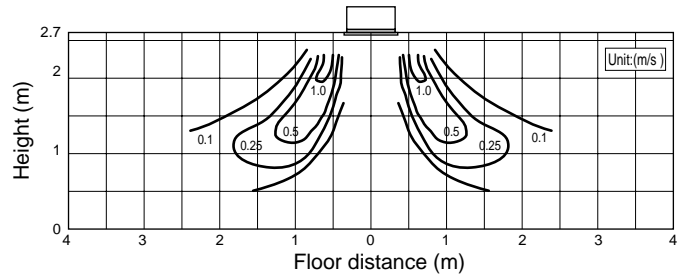

- PLFY-P80~125VLMD-A

< Cooling mode >

Flow angle : 20° Room temp. : 27°C

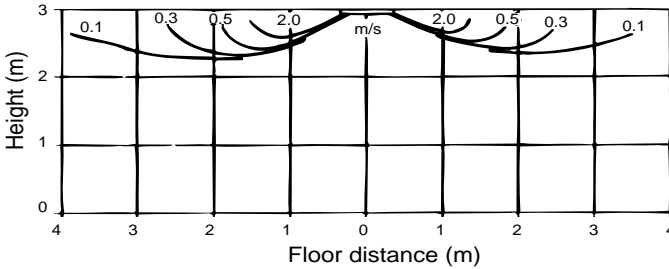

< Heating mode >

Flow angle : 70° Room temp. : 20°C

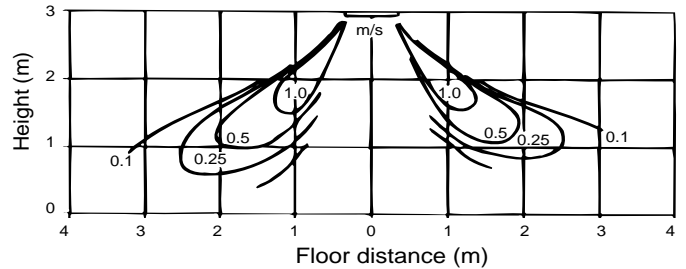

note : These figures show typical temperature distributions in the conditions above. In the actual installation, they may differ from these figures under the influence of air temperature conditions, ceiling height, cooling/heating load, obstacles, etc.

7. Options

Description	Model	Applicable capacity
Decoration panel	CMP-40VLW-B	P20/P25/P32/P40
	CMP-63VLW-B	P50/P63
	CMP-63LW-F	P80
	CMP-125LW-F	P100/P125
OA duct flange	PAC-KH11OF	P20/P25/P32/P40/P50/P63

PLFY-P-
VLMD-A/VLMD-B

CONTENTS

1. Specifications II -152

2. Capacity Tables II -153

 2-1 Cooling Capacity(PUMY) II -153

 2-2 Heating Capacity(PUMY) II -154

 2-3 Cooling Capacity(Y/R2-8-10-13HP) II -155

 2-4 Heating Capacity(Y/R2-8-10-13HP) II -156

 2-5 Cooling Capacity(Big Y, Super Y, Big R2) II -157

 2-6 Heating Capacity(Big Y, Super Y, Big R2) II -158

 2-7 Cooling Capacity(WY, WR2) II -159

 2-8 Heating Capacity(WY, WR2) II -160

3. Sound Levels II -161

 3-1 Noise levels II -161

 3-2 N/C curves II -161

4. External Dimensions II -162

5. Electrical Wiring Diagrams II -164

6. Temperature/Airflow distribution II -166

7. Options II -167



1. Specifications

			PLFY-P32VKM-A	PLFY-P40VKM-A	PLFY-P50VKM-A	PLFY-P63VKM-A
Power source			~ 220-240V 50Hz / ~ 220V 60Hz			
Cooling capacity	* 1	kW	3.6	4.5	5.6	7.1
	* 2	kcal/h	3,150	4,000	5,000	6,300
Heating capacity	* 1	kW	4.0	5.0	6.3	8.0
Power consumption	Cooling	kW	0.13		0.14	0.15
	Heating	kW	0.13		0.14	0.15
Current	Cooling	A	0.60		0.64	0.68
	Heating	A	0.60		0.64	0.68
External finish(Munsel No.)			Panel : 0.70Y 8.59/0.97			
Dimension	* 3	Height	mm 298(30)			
		Width	mm 660(760)			
		Depth	mm 660(760)			
Net weight	* 3	kg	19(3.7)			20(3.7)
Heat exchanger			Cross fin (Aluminum plate fin and copper tube)			
Fan	Type		Turbo fan			
	Airflow rate	* 3	m³/min 13-14-14.5-15		13-14-15-16	14-15-16-17
	External static pressure		Pa 0			
Motor	Type		Single phase induction motor			
	Output	kW	0.030			
Air filter			PP Honeycomb			
Refrigerant pipe dimension	Gas (Flare)	mm	ø 12.7		ø 15.88	
	Liquid (Flare)	mm	ø 6.35		ø 9.52	
Drain pipe dimension			VP-25			
Noise level (Lo-Mid2-Mid1-Hi)	* 3 * 4	dB(A)	31-32.5-34-35		32-34-35.5-37	35-36.5-38-39

			PLFY-P80VAM-A	PLFY-P100VAM-A	PLFY-P125VAM-A	
Power source			~ 220-240V 50Hz / ~ 220V 60Hz			
Cooling capacity	* 1	kW	9.0	11.2	14.0	
	* 2	kcal/h	8,000	10,000	12,500	
Heating capacity	* 1	kW	10.0	12.5	16.0	
Power consumption	Cooling	kW	0.18	0.30	0.34	
	Heating	kW	0.18	0.30	0.34	
Current	Cooling	A	0.86	1.43	1.64	
	Heating	A	0.86	1.43	1.64	
External finish(Munsel No.)			Panel : 0.70Y 8.59/0.97			
Dimension	* 3	Height	258(30)	298(30)		
		Width	mm 840(950)			
		Depth	mm 840(950)			
Net weight	* 3	kg	24(5)	30(5)	30(5)	
Heat exchanger			Cross fin (Aluminum plate fin and copper tube)			
Fan	Type		Turbo fan			
	Airflow rate	* 3	m³/min 16-18-20-22		20-23-26-28	22-25-28-30
	External static pressure		Pa 0			
Motor	Type		Single phase induction motor			
	Output	kW	0.070	0.120		
Air filter			PP Honeycomb			
Refrigerant pipe dimension	Gas (Flare)	mm	ø 15.88		ø 19.05	
	Liquid (Flare)	mm	ø 9.52			
Drain pipe dimension			VP-25			
Noise level (Lo-Mid2-Mid1-Hi)	* 3 * 4	dB(A)	30-32-35-37	33-36-39-41	35-38-41-43	

Note: * 1 Cooling/Heating capacity indicates the maximum value at operation under the following condition.

Cooling : Indoor 27°C DB/19°C WB, Outdoor 35°C DB

Heating : Indoor 20°C DB, Outdoor 7°C DB/6°C WB

* 2 Cooling capacity indicates the maximum value at operation under the following condition.

Cooling : Indoor 27°C DB/19.5°C WB, Outdoor 35°C DB (WR2: water 30°C)

* 3 External dimension/ net weight are shown in (unit/panel) , and airflow rate/noise level are in (low-middle2-middle1-high).

* 4 It is measured in anechoic room.

2. Capacity Tables

2-1.Cooling Capacity (In combination with PUMY)

PLFY-P-VKM-AVAM-A

CA :Capacity(kW)
SHC:Sensible Heat Capacity(kW)

Unit size	Outdoor air temp.	Indoor air temp.							
		23°CDB 16°CWB		25°CDB 18°CWB		28°CDB 20°CWB		30°CDB 22°CWB	
		CA	SHC	CA	SHC	CA	SHC	CA	SHC
32 (3.6)	20.0	3.6	2.7	3.7	2.8	4.0	2.8	4.2	2.9
	22.5	3.5	2.7	3.7	2.8	4.0	2.8	4.2	2.9
	25.0	3.5	2.7	3.7	2.8	3.9	2.8	4.1	2.8
	27.5	3.4	2.6	3.6	2.8	3.9	2.7	4.1	2.8
	30.0	3.4	2.6	3.6	2.7	3.8	2.7	4.1	2.8
	32.5	3.3	2.6	3.6	2.7	3.8	2.7	4.0	2.8
	35.0	3.3	2.6	3.5	2.7	3.7	2.7	4.0	2.8
	37.5	3.2	2.5	3.5	2.7	3.7	2.6	3.9	2.7
	40.0	3.2	2.5	3.4	2.7	3.6	2.6	3.9	2.7
46.0	3.1	2.5	3.3	2.6	3.5	2.6	3.7	2.7	
40 (4.5)	20.0	4.5	3.4	4.7	3.5	5.0	3.5	5.3	3.6
	22.5	4.4	3.4	4.6	3.5	5.0	3.5	5.2	3.6
	25.0	4.3	3.3	4.6	3.5	4.9	3.5	5.2	3.6
	27.5	4.3	3.3	4.6	3.5	4.9	3.5	5.1	3.6
	30.0	4.2	3.3	4.5	3.5	4.8	3.4	5.1	3.5
	32.5	4.2	3.3	4.4	3.4	4.7	3.4	5.0	3.5
	35.0	4.1	3.2	4.4	3.4	4.7	3.4	5.0	3.5
	37.5	4.1	3.2	4.3	3.4	4.6	3.3	4.9	3.5
	40.0	4.0	3.2	4.3	3.4	4.5	3.3	4.8	3.4
46.0	3.8	3.1	4.1	3.3	4.3	3.2	4.6	3.4	
50 (5.6)	20.0	5.5	4.0	5.8	4.2	6.2	4.1	6.6	4.3
	22.5	5.5	4.0	5.8	4.1	6.2	4.1	6.5	4.2
	25.0	5.4	3.9	5.7	4.1	6.1	4.1	6.4	4.2
	27.5	5.3	3.9	5.7	4.1	6.0	4.1	6.4	4.2
	30.0	5.3	3.9	5.6	4.1	5.9	4.0	6.3	4.1
	32.5	5.2	3.8	5.5	4.0	5.9	4.0	6.2	4.1
	35.0	5.1	3.8	5.5	4.0	5.8	3.9	6.2	4.1
	37.5	5.0	3.7	5.4	3.9	5.7	3.9	6.1	4.0
	40.0	5.0	3.7	5.3	3.9	5.6	3.9	6.0	4.0
46.0	4.8	3.6	5.1	3.8	5.4	3.8	5.8	3.9	
63 (7.1)	20.0	7.0	4.9	7.4	5.1	7.9	5.1	8.3	5.2
	22.5	6.9	4.9	7.3	5.1	7.8	5.1	8.2	5.2
	25.0	6.9	4.8	7.3	5.1	7.7	5.0	8.2	5.2
	27.5	6.8	4.8	7.2	5.0	7.7	5.0	8.1	5.1
	30.0	6.7	4.7	7.1	5.0	7.5	4.9	8.0	5.1
	32.5	6.6	4.7	7.0	4.9	7.5	4.9	7.9	5.0
	35.0	6.5	4.6	6.9	4.9	7.3	4.8	7.8	5.0
	37.5	6.4	4.6	6.8	4.8	7.2	4.8	7.7	5.0
	40.0	6.3	4.6	6.7	4.8	7.2	4.7	7.6	4.9
46.0	6.1	4.4	6.5	4.7	6.9	4.6	7.3	4.8	
80 (9.0)	20.0	8.9	6.4	9.4	6.7	10.0	6.7	10.6	6.9
	22.5	8.8	6.4	9.3	6.7	9.9	6.6	10.4	6.8
	25.0	8.7	6.3	9.2	6.6	9.8	6.6	10.4	6.8
	27.5	8.6	6.3	9.1	6.6	9.7	6.5	10.3	6.7
	30.0	8.5	6.2	9.0	6.5	9.5	6.5	10.2	6.7
	32.5	8.3	6.1	8.9	6.5	9.5	6.4	10.0	6.6
	35.0	8.2	6.1	8.8	6.4	9.3	6.4	9.9	6.6
	37.5	8.1	6.0	8.6	6.4	9.2	6.3	9.8	6.5
	40.0	8.0	6.0	8.6	6.3	9.1	6.2	9.6	6.5
46.0	7.7	5.8	8.2	6.2	8.7	6.1	9.3	6.3	
100 (11.2)	20.0	11.1	8.1	11.6	8.4	12.5	8.4	13.1	8.6
	22.5	10.9	8.0	11.5	8.4	12.3	8.3	13.0	8.6
	25.0	10.8	8.0	11.5	8.3	12.2	8.3	12.9	8.5
	27.5	10.7	7.9	11.3	8.3	12.1	8.2	12.8	8.5
	30.0	10.5	7.8	11.2	8.2	11.9	8.1	12.6	8.4
	32.5	10.4	7.7	11.1	8.2	11.8	8.1	12.5	8.4
	35.0	10.2	7.7	10.9	8.1	11.6	8.0	12.3	8.3
	37.5	10.1	7.6	10.8	8.0	11.4	7.9	12.2	8.2
	40.0	10.0	7.5	10.6	7.9	11.3	7.9	12.0	8.1
46.0	9.6	7.4	10.2	7.8	10.8	7.7	11.5	7.9	
125 (14.0)	20.0	13.9	9.7	14.6	10.1	15.6	10.1	16.4	10.3
	22.5	13.7	9.6	14.4	10.0	15.4	10.0	16.2	10.2
	25.0	13.5	9.5	14.3	10.0	15.3	9.9	16.1	10.2
	27.5	13.4	9.4	14.2	9.9	15.1	9.8	16.0	10.1
	30.0	13.2	9.3	14.0	9.8	14.9	9.7	15.8	10.0
	32.5	13.0	9.2	13.8	9.7	14.7	9.6	15.6	9.9
	35.0	12.8	9.1	13.7	9.6	14.5	9.5	15.4	9.8
	37.5	12.6	9.0	13.4	9.5	14.3	9.4	15.2	9.8
	40.0	12.5	9.0	13.3	9.4	14.1	9.4	15.0	9.7
46.0	12.0	8.7	12.8	9.2	13.5	9.1	14.4	9.4	



2-2.Heating Capacity (In combination with PUMY)

PLFY-P-VKM-A,VAM-A

SHC:Sensible Heat Capacity(kW)

Unit size	Outdoor air temp. °CWB	Indoor air temp.:°CDB		
		15.0	20.0	25.0
		SHC	SHC	SHC
32	-12.0	2.5	2.5	2.5
	-10.0	2.7	2.6	2.6
	-5.0	3.1	3.0	3.0
	0.0	3.5	3.4	3.4
	2.5	3.7	3.7	3.6
	6.0	4.0	4.0	3.9
	7.5	4.2	4.1	4.0
	10.0	4.4	4.4	4.0
	12.5	4.7	4.4	4.0
15.5	4.9	4.4	4.0	
40	-12.0	3.2	3.1	3.1
	-10.0	3.4	3.3	3.2
	-5.0	3.8	3.8	3.7
	0.0	4.3	4.3	4.2
	2.5	4.6	4.6	4.5
	6.0	5.0	5.0	4.9
	7.5	5.2	5.2	5.0
	10.0	5.5	5.5	5.0
	12.5	5.9	5.5	5.0
15.5	6.2	5.5	5.0	
50	-12.0	4.0	3.9	3.9
	-10.0	4.2	4.2	4.1
	-5.0	4.8	4.8	4.7
	0.0	5.5	5.4	5.3
	2.5	5.8	5.8	5.7
	6.0	6.3	6.3	6.2
	7.5	6.6	6.5	6.2
	10.0	7.0	6.9	6.2
	12.5	7.4	7.0	6.2
15.5	7.7	7.0	6.2	
63	-12.0	5.1	5.0	4.9
	-10.0	5.4	5.3	5.2
	-5.0	6.1	6.0	5.9
	0.0	6.9	6.9	6.8
	2.5	7.4	7.3	7.2
	6.0	8.0	8.0	7.9
	7.5	8.3	8.3	7.9
	10.0	8.8	8.8	7.9
	12.5	9.4	8.8	7.9
15.5	9.8	8.8	7.9	

Unit size	Outdoor air temp. °CWB	Indoor air temp.:°CDB		
		15.0	20.0	25.0
		SHC	SHC	SHC
80	-12.0	6.4	6.2	6.1
	-10.0	6.7	6.6	6.5
	-5.0	7.6	7.5	7.4
	0.0	8.7	8.6	8.5
	2.5	9.2	9.2	9.0
	6.0	10.1	10.0	9.9
	7.5	10.4	10.4	9.9
	10.0	11.1	11.0	9.9
	12.5	11.7	11.0	9.9
15.5	12.3	11.0	9.9	
100	-12.0	8.0	7.8	7.7
	-10.0	8.4	8.2	8.1
	-5.0	9.6	9.4	9.3
	0.0	10.9	10.7	10.6
	2.5	11.5	11.4	11.3
	6.0	12.6	12.5	12.3
	7.5	13.0	12.9	12.4
	10.0	13.8	13.7	12.4
	12.5	14.6	13.8	12.4
15.5	15.4	13.8	12.4	
125	-12.0	10.2	10.0	9.8
	-10.0	10.7	10.6	10.4
	-5.0	12.2	12.1	11.9
	0.0	13.9	13.8	13.6
	2.5	14.8	14.7	14.5
	6.0	16.1	16.0	15.8
	7.5	16.7	16.6	15.8
	10.0	17.7	17.6	15.8
	12.5	18.7	17.7	15.8
15.5	19.7	17.7	15.8	

2-3.Cooling Capacity (In combination with PU(H)Y, PURY-(P)200-250-315YEM-A, TEM-A)

PLFY-P-VKM-A,VAM-A

CA :Capacity(kW)

SHC:Sensible Heat Capacity(kW)

Unit size	Outdoor air temp.	Indoor air temp.													
		21.5°CDB 15°CWB		23°CDB 16°CWB		25°CDB 18°CWB		27°CDB 19°CWB		28°CDB 20°CWB		30°CDB 22°CWB		32°CDB 24°CWB	
		°CDB	CA	SHC	CA	SHC	CA	SHC	CA	SHC	CA	SHC	CA	SHC	CA
32 (3.6)	20.0	3.5	2.7	3.6	2.7	3.7	2.7	3.8	2.7	3.9	2.8	4.0	2.7	4.2	2.6
	22.5	3.5	2.7	3.6	2.7	3.7	2.7	3.8	2.7	3.9	2.8	4.0	2.7	4.1	2.6
	25.0	3.5	2.6	3.5	2.7	3.7	2.6	3.7	2.7	3.8	2.8	4.0	2.7	4.1	2.6
	27.5	3.4	2.6	3.5	2.7	3.6	2.6	3.7	2.7	3.8	2.7	3.9	2.7	4.1	2.6
	30.0	3.4	2.6	3.5	2.7	3.6	2.6	3.7	2.6	3.7	2.7	3.9	2.7	4.0	2.6
	32.5	3.3	2.6	3.4	2.7	3.6	2.6	3.6	2.6	3.7	2.7	3.9	2.7	4.0	2.6
	35.0	3.3	2.6	3.4	2.6	3.5	2.6	3.6	2.6	3.7	2.7	3.8	2.6	4.0	2.6
	37.5	3.3	2.6	3.3	2.6	3.5	2.6	3.6	2.6	3.6	2.7	3.8	2.6	3.9	2.6
	40.0	3.2	2.5	3.3	2.6	3.5	2.6	3.5	2.6	3.6	2.7	3.7	2.6	3.9	2.5
43.0	3.2	2.5	3.3	2.6	3.4	2.5	3.5	2.6	3.6	2.7	3.7	2.6	3.8	2.5	
40 (4.5)	20.0	4.4	3.4	4.5	3.5	4.7	3.4	4.8	3.4	4.9	3.5	5.0	3.4	5.2	3.3
	22.5	4.4	3.4	4.5	3.4	4.6	3.4	4.7	3.4	4.8	3.5	5.0	3.4	5.2	3.3
	25.0	4.3	3.3	4.4	3.4	4.6	3.3	4.7	3.4	4.8	3.5	5.0	3.4	5.1	3.3
	27.5	4.3	3.3	4.4	3.4	4.5	3.3	4.6	3.4	4.7	3.5	4.9	3.4	5.1	3.3
	30.0	4.2	3.3	4.3	3.4	4.5	3.3	4.6	3.3	4.7	3.5	4.9	3.4	5.0	3.3
	32.5	4.2	3.3	4.3	3.4	4.5	3.3	4.5	3.3	4.6	3.4	4.8	3.4	5.0	3.3
	35.0	4.1	3.2	4.2	3.3	4.4	3.3	4.5	3.3	4.6	3.4	4.8	3.3	5.0	3.3
	37.5	4.1	3.2	4.2	3.3	4.4	3.2	4.5	3.3	4.5	3.4	4.7	3.3	4.9	3.2
	40.0	4.1	3.2	4.1	3.3	4.3	3.2	4.4	3.3	4.5	3.4	4.7	3.3	4.9	3.2
43.0	4.0	3.2	4.1	3.3	4.3	3.2	4.4	3.2	4.4	3.4	4.6	3.3	4.8	3.2	
50 (5.6)	20.0	5.5	4.0	5.6	4.1	5.8	4.0	5.9	4.0	6.0	4.1	6.3	4.0	6.5	3.9
	22.5	5.4	3.9	5.5	4.0	5.8	3.9	5.9	4.0	6.0	4.1	6.2	4.0	6.4	3.9
	25.0	5.4	3.9	5.5	4.0	5.7	3.9	5.8	3.9	5.9	4.1	6.2	3.9	6.4	3.8
	27.5	5.3	3.9	5.4	4.0	5.7	3.9	5.8	3.9	5.9	4.0	6.1	3.9	6.3	3.8
	30.0	5.3	3.9	5.4	3.9	5.6	3.9	5.7	3.9	5.8	4.0	6.0	3.9	6.3	3.8
	32.5	5.2	3.8	5.3	3.9	5.5	3.8	5.7	3.9	5.8	4.0	6.0	3.9	6.2	3.8
	35.0	5.2	3.8	5.3	3.9	5.5	3.8	5.6	3.8	5.7	4.0	5.9	3.9	6.2	3.8
	37.5	5.1	3.8	5.2	3.9	5.4	3.8	5.5	3.8	5.7	3.9	5.9	3.8	6.1	3.7
	40.0	5.0	3.7	5.2	3.8	5.4	3.8	5.5	3.8	5.6	3.9	5.8	3.8	6.0	3.7
43.0	5.0	3.7	5.1	3.8	5.3	3.7	5.4	3.8	5.5	3.9	5.8	3.8	6.0	3.7	
63 (7.1)	20.0	7.0	4.9	7.1	5.0	7.4	4.9	7.5	4.9	7.7	5.0	8.0	4.9	8.2	4.7
	22.5	6.9	4.9	7.0	4.9	7.3	4.8	7.5	4.8	7.6	5.0	7.9	4.8	8.2	4.7
	25.0	6.8	4.8	7.0	4.9	7.2	4.8	7.4	4.8	7.5	4.9	7.8	4.8	8.1	4.7
	27.5	6.7	4.8	6.9	4.9	7.2	4.8	7.3	4.8	7.5	4.9	7.7	4.8	8.0	4.6
	30.0	6.7	4.7	6.8	4.8	7.1	4.7	7.2	4.7	7.4	4.9	7.7	4.7	8.0	4.6
	32.5	6.6	4.7	6.7	4.8	7.0	4.7	7.2	4.7	7.3	4.8	7.6	4.7	7.9	4.6
	35.0	6.5	4.7	6.7	4.8	7.0	4.7	7.1	4.7	7.2	4.8	7.5	4.7	7.8	4.6
	37.5	6.5	4.6	6.6	4.7	6.9	4.6	7.0	4.6	7.2	4.8	7.5	4.7	7.7	4.5
	40.0	6.4	4.6	6.5	4.7	6.8	4.6	7.0	4.6	7.1	4.8	7.4	4.6	7.7	4.5
43.0	6.3	4.6	6.4	4.6	6.7	4.6	6.9	4.6	7.0	4.7	7.3	4.6	7.6	4.5	
80 (9.0)	20.0	8.8	6.4	9.0	6.5	9.4	6.4	9.5	6.4	9.7	6.6	10.1	6.4	10.4	6.2
	22.5	8.7	6.4	8.9	6.5	9.3	6.3	9.5	6.4	9.6	6.6	10.0	6.4	10.4	6.2
	25.0	8.6	6.3	8.8	6.4	9.2	6.3	9.4	6.3	9.5	6.5	9.9	6.4	10.3	6.2
	27.5	8.6	6.3	8.7	6.4	9.1	6.3	9.3	6.3	9.5	6.5	9.8	6.3	10.2	6.1
	30.0	8.5	6.2	8.6	6.4	9.0	6.2	9.2	6.3	9.4	6.5	9.7	6.3	10.1	6.1
	32.5	8.4	6.2	8.6	6.3	8.9	6.2	9.1	6.2	9.3	6.4	9.6	6.3	10.0	6.1
	35.0	8.3	6.1	8.5	6.3	8.8	6.1	9.0	6.2	9.2	6.4	9.5	6.2	9.9	6.0
	37.5	8.2	6.1	8.4	6.2	8.7	6.1	8.9	6.1	9.1	6.3	9.5	6.2	9.8	6.0
	40.0	8.1	6.0	8.3	6.2	8.6	6.1	8.8	6.1	9.0	6.3	9.4	6.1	9.7	6.0
43.0	8.0	6.0	8.2	6.1	8.5	6.0	8.7	6.1	8.9	6.3	9.3	6.1	9.6	5.9	
100 (11.2)	20.0	11.0	8.0	11.2	8.2	11.6	8.0	11.9	8.1	12.1	8.3	12.5	8.1	13.0	7.9
	22.5	10.9	8.0	11.1	8.2	11.5	8.0	11.8	8.0	12.0	8.3	12.4	8.1	12.9	7.8
	25.0	10.8	7.9	11.0	8.1	11.4	7.9	11.6	8.0	11.9	8.2	12.3	8.0	12.8	7.8
	27.5	10.6	7.9	10.9	8.1	11.3	7.9	11.5	7.9	11.8	8.2	12.2	8.0	12.7	7.8
	30.0	10.5	7.8	10.8	8.0	11.2	7.8	11.4	7.9	11.6	8.1	12.1	7.9	12.5	7.7
	32.5	10.4	7.8	10.6	7.9	11.1	7.8	11.3	7.8	11.5	8.1	12.0	7.9	12.4	7.7
	35.0	10.3	7.7	10.5	7.9	11.0	7.7	11.2	7.8	11.4	8.1	11.9	7.9	12.3	7.6
	37.5	10.2	7.7	10.4	7.8	10.9	7.7	11.1	7.8	11.3	8.0	11.8	7.8	12.2	7.6
	40.0	10.1	7.6	10.3	7.8	10.8	7.6	11.0	7.7	11.2	8.0	11.6	7.8	12.1	7.6
43.0	9.9	7.5	10.2	7.7	10.6	7.6	10.8	7.6	11.1	7.9	11.5	7.7	12.0	7.5	
125 (14.0)	20.0	13.7	9.6	14.0	9.8	14.6	9.6	14.8	9.6	15.1	9.9	15.7	9.6	16.2	9.3
	22.5	13.6	9.6	13.9	9.7	14.4	9.5	14.7	9.5	15.0	9.8	15.5	9.5	16.1	9.2
	25.0	13.4	9.5	13.7	9.7	14.3	9.4	14.6	9.5	14.8	9.7	15.4	9.5	16.0	9.2
	27.5	13.3	9.4	13.6	9.6	14.1	9.4	14.4	9.4	14.7	9.7	15.3	9.4	15.8	9.1
	30.0	13.2	9.3	13.4	9.5	14.0	9.3	14.3	9.3	14.6	9.6	15.1	9.3	15.7	9.1
	32.5	13.0	9.3	13.3	9.4	13.9	9.2	14.1	9.3	14.4	9.5	15.0	9.3	15.5	9.0
	35.0	12.9	9.2	13.2	9.4	13.7	9.2	14.0	9.2	14.3	9.5	14.8	9.2	15.4	9.0
	37.5	12.7	9.1	13.0	9.3	13.6	9.1	13.9	9.1	14.1	9.4	14.7	9.2	15.3	8.9
	40.0	12.6	9.0	12.9	9.2	13.4	9.0	13.7	9.1	14.0	9.4	14.6	9.1	15.1	8.9
43.0	12.4	9.0	12.7	9.1	13.3	9.0	13.6	9.0	13.8	9.3	14.4	9.1	15.0	8.8	

PLFY-P-VKM-A,VAM-A

2-4.Heating Capacity (In combination with PU(H)Y, PURY-(P)200-250-315YEM-A, TEM-A)

PLFY-P-VKM-A,VAM-A

SHC:Sensible Heat Capacity(kW)

Unit size	Outdoor air temp. °CWB	Indoor air temp.:°CDB			
		15.0	20.0	25.0	27.0
32	-15.0	2.7	2.6	2.6	2.6
	-10.0	3.1	3.0	3.0	2.8
	-5.0	3.4	3.4	3.1	2.8
	0.0	3.8	3.8	3.1	2.8
	2.5	4.0	4.0	3.1	2.8
	6.0	4.0	4.0	3.1	2.8
	7.5	4.2	4.0	3.1	2.8
	10.0	4.5	4.0	3.1	2.8
	12.5	4.8	4.0	3.1	2.8
15.5	4.8	4.0	3.1	2.8	
40	-15.0	3.3	3.3	3.3	3.3
	-10.0	3.8	3.8	3.7	3.5
	-5.0	4.3	4.2	3.9	3.5
	0.0	4.8	4.7	3.9	3.5
	2.5	5.0	5.0	3.9	3.5
	6.0	5.1	5.0	3.9	3.5
	7.5	5.3	5.0	3.9	3.5
	10.0	5.6	5.0	3.9	3.5
	12.5	6.0	5.0	3.9	3.5
15.5	6.1	5.0	3.9	3.5	
50	-15.0	4.2	4.2	4.1	4.1
	-10.0	4.8	4.8	4.7	4.3
	-5.0	5.4	5.3	4.9	4.3
	0.0	6.0	5.9	4.9	4.3
	2.5	6.3	6.2	4.9	4.3
	6.0	6.4	6.3	4.9	4.3
	7.5	6.6	6.3	4.9	4.3
	10.0	7.1	6.3	4.9	4.3
	12.5	7.5	6.3	4.9	4.3
15.5	7.6	6.3	4.9	4.3	
63	-15.0	5.4	5.3	5.2	5.2
	-10.0	6.1	6.0	6.0	5.5
	-5.0	6.9	6.8	6.2	5.5
	0.0	7.6	7.5	6.2	5.5
	2.5	8.0	7.9	6.2	5.5
	6.0	8.1	8.0	6.2	5.5
	7.5	8.4	8.0	6.2	5.5
	10.0	9.0	8.0	6.2	5.5
	12.5	9.6	8.0	6.2	5.5
15.5	9.7	8.0	6.2	5.5	

Unit size	Outdoor air temp. °CWB	Indoor air temp.:°CDB			
		15.0	20.0	25.0	27.0
80	-15.0	6.7	6.6	6.5	6.5
	-10.0	7.6	7.5	7.4	6.9
	-5.0	8.6	8.5	7.8	6.9
	0.0	9.5	9.4	7.8	6.9
	2.5	10.0	9.9	7.8	6.9
	6.0	10.1	10.0	7.8	6.9
	7.5	10.5	10.0	7.8	6.9
	10.0	11.2	10.0	7.8	6.9
	12.5	12.0	10.0	7.8	6.9
15.5	12.1	10.0	7.8	6.9	
100	-15.0	8.4	8.2	8.2	8.1
	-10.0	9.6	9.4	9.3	8.6
	-5.0	10.7	10.6	9.8	8.6
	0.0	11.9	11.8	9.8	8.6
	2.5	12.5	12.4	9.8	8.6
	6.0	12.6	12.5	9.8	8.6
	7.5	13.2	12.5	9.8	8.6
	10.0	14.1	12.5	9.8	8.6
	12.5	15.0	12.5	9.8	8.6
15.5	15.1	12.5	9.8	8.6	
125	-15.0	10.7	10.6	10.5	10.4
	-10.0	12.2	12.1	11.9	11.0
	-5.0	13.7	13.6	12.5	11.0
	0.0	15.3	15.1	12.5	11.0
	2.5	16.0	15.8	12.5	11.0
	6.0	16.2	16.0	12.5	11.0
	7.5	16.8	16.0	12.5	11.0
	10.0	18.0	16.0	12.5	11.0
	12.5	19.1	16.0	12.5	11.0
15.5	19.4	16.0	12.5	11.0	



2-5.Cooling Capacity (In combination with Big Y, Super Y, Big R2)

PLFY-P-VKM-A,VAM-A

CA :Capacity(kW)
SHC:Sensible Heat Capacity(kW)

Unit size	Outdoor air temp.	Indoor air temp.												
		21.5°CDB 15°CWB			23°CDB 16°CWB		25°CDB 18°CWB		28°CDB 20°CWB		30°CDB 22°CWB		32°CDB 24°CWB	
		CDB	CA	SHC	CA	SHC	CA	SHC	CA	SHC	CA	SHC	CA	SHC
32	20.0	3.3	2.6	3.5	2.7	3.7	2.7	4.0	2.8	4.2	2.8	4.5	2.8	
	22.5	3.3	2.6	3.5	2.7	3.7	2.7	4.0	2.8	4.2	2.8	4.4	2.7	
	25.0	3.3	2.6	3.4	2.7	3.7	2.6	3.9	2.8	4.1	2.8	4.4	2.7	
	27.5	3.3	2.5	3.4	2.6	3.6	2.6	3.9	2.8	4.1	2.7	4.3	2.7	
	30.0	3.2	2.5	3.4	2.6	3.6	2.6	3.8	2.8	4.0	2.7	4.2	2.7	
	32.5	3.2	2.5	3.3	2.6	3.5	2.6	3.8	2.7	4.0	2.7	4.2	2.6	
	35.0	3.2	2.5	3.3	2.6	3.5	2.6	3.7	2.7	3.9	2.7	4.1	2.6	
	37.5	3.2	2.5	3.3	2.6	3.5	2.6	3.7	2.7	3.8	2.7	4.0	2.6	
	40.0	3.1	2.5	3.2	2.6	3.4	2.5	3.6	2.7	3.8	2.6	4.0	2.6	
43.0	3.1	2.5	3.2	2.5	3.4	2.5	3.5	2.7	3.7	2.6	3.9	2.6		
40	20.0	4.1	3.2	4.3	3.4	4.7	3.4	5.0	3.6	5.3	3.5	5.6	3.5	
	22.5	4.1	3.2	4.3	3.4	4.6	3.4	4.9	3.6	5.2	3.5	5.5	3.5	
	25.0	4.1	3.2	4.3	3.4	4.6	3.3	4.9	3.5	5.2	3.5	5.5	3.4	
	27.5	4.1	3.2	4.2	3.3	4.5	3.3	4.8	3.5	5.1	3.5	5.4	3.4	
	30.0	4.0	3.2	4.2	3.3	4.5	3.3	4.8	3.5	5.0	3.4	5.3	3.4	
	32.5	4.0	3.2	4.2	3.3	4.4	3.3	4.7	3.5	5.0	3.4	5.2	3.3	
	35.0	4.0	3.2	4.1	3.3	4.4	3.3	4.6	3.4	4.9	3.4	5.1	3.3	
	37.5	3.9	3.2	4.1	3.3	4.3	3.2	4.6	3.4	4.8	3.4	5.1	3.3	
	40.0	3.9	3.1	4.0	3.2	4.3	3.2	4.5	3.4	4.7	3.3	5.0	3.3	
43.0	3.9	3.1	4.0	3.2	4.2	3.2	4.4	3.4	4.7	3.3	4.9	3.2		
50	20.0	5.2	3.8	5.4	4.0	5.8	4.0	6.2	4.2	6.6	4.1	7.0	4.1	
	22.5	5.2	3.8	5.4	3.9	5.8	3.9	6.2	4.1	6.5	4.1	6.9	4.0	
	25.0	5.1	3.8	5.3	3.9	5.7	3.9	6.1	4.1	6.4	4.0	6.8	4.0	
	27.5	5.1	3.8	5.3	3.9	5.6	3.9	6.0	4.1	6.3	4.0	6.7	3.9	
	30.0	5.0	3.7	5.2	3.9	5.6	3.8	5.9	4.0	6.2	4.0	6.6	3.9	
	32.5	5.0	3.7	5.2	3.8	5.5	3.8	5.8	4.0	6.2	3.9	6.5	3.9	
	35.0	4.9	3.7	5.1	3.8	5.4	3.8	5.8	4.0	6.1	3.9	6.4	3.8	
	37.5	4.9	3.7	5.1	3.8	5.4	3.8	5.7	3.9	6.0	3.9	6.3	3.8	
	40.0	4.9	3.7	5.0	3.8	5.3	3.7	5.6	3.9	5.9	3.8	6.2	3.8	
43.0	4.8	3.6	5.0	3.7	5.2	3.7	5.5	3.9	5.8	3.8	6.1	3.7		
63	20.0	6.5	4.7	6.9	4.9	7.4	4.9	7.9	5.1	8.4	5.0	8.9	5.0	
	22.5	6.5	4.7	6.8	4.8	7.3	4.8	7.8	5.1	8.3	5.0	8.7	4.9	
	25.0	6.5	4.6	6.8	4.8	7.2	4.8	7.7	5.0	8.1	4.9	8.6	4.9	
	27.5	6.4	4.6	6.7	4.8	7.2	4.8	7.6	5.0	8.0	4.9	8.5	4.8	
	30.0	6.4	4.6	6.6	4.7	7.1	4.7	7.5	4.9	7.9	4.9	8.4	4.8	
	32.5	6.3	4.6	6.6	4.7	7.0	4.7	7.4	4.9	7.8	4.8	8.2	4.7	
	35.0	6.3	4.5	6.5	4.7	6.9	4.6	7.3	4.8	7.7	4.8	8.1	4.7	
	37.5	6.2	4.5	6.4	4.6	6.8	4.6	7.2	4.8	7.6	4.7	8.0	4.6	
	40.0	6.2	4.5	6.4	4.6	6.7	4.6	7.1	4.8	7.5	4.7	7.9	4.6	
43.0	6.1	4.5	6.3	4.6	6.6	4.5	7.0	4.7	7.3	4.6	7.7	4.5		
80	20.0	8.3	6.1	8.7	6.4	9.4	6.4	10.0	6.7	10.6	6.6	11.2	6.5	
	22.5	8.3	6.1	8.7	6.4	9.3	6.3	9.9	6.7	10.5	6.6	11.1	6.5	
	25.0	8.2	6.1	8.6	6.3	9.2	6.3	9.8	6.6	10.3	6.5	10.9	6.4	
	27.5	8.1	6.1	8.5	6.3	9.1	6.2	9.6	6.6	10.2	6.5	10.8	6.4	
	30.0	8.1	6.0	8.4	6.2	9.0	6.2	9.5	6.5	10.0	6.4	10.6	6.3	
	32.5	8.0	6.0	8.3	6.2	8.9	6.2	9.4	6.5	9.9	6.4	10.4	6.2	
	35.0	8.0	6.0	8.2	6.2	8.8	6.1	9.3	6.4	9.8	6.3	10.3	6.2	
	37.5	7.9	5.9	8.1	6.1	8.6	6.1	9.1	6.4	9.6	6.3	10.1	6.1	
	40.0	7.8	5.9	8.1	6.1	8.5	6.0	9.0	6.3	9.5	6.2	10.0	6.1	
43.0	7.7	5.9	8.0	6.0	8.4	6.0	8.9	6.2	9.3	6.1	9.8	6.0		
100	20.0	10.3	7.7	10.8	8.0	11.6	8.0	12.5	8.5	13.2	8.4	14.0	8.2	
	22.5	10.3	7.7	10.8	8.0	11.5	8.0	12.3	8.4	13.0	8.3	13.8	8.2	
	25.0	10.2	7.7	10.7	8.0	11.4	7.9	12.1	8.4	12.8	8.2	13.6	8.1	
	27.5	10.1	7.6	10.6	7.9	11.3	7.9	12.0	8.3	12.7	8.2	13.4	8.0	
	30.0	10.1	7.6	10.5	7.9	11.2	7.8	11.8	8.2	12.5	8.1	13.2	7.9	
	32.5	10.0	7.6	10.3	7.8	11.0	7.8	11.7	8.2	12.3	8.0	13.0	7.9	
	35.0	9.9	7.5	10.2	7.8	10.9	7.7	11.5	8.1	12.1	8.0	12.8	7.8	
	37.5	9.8	7.5	10.1	7.7	10.8	7.6	11.4	8.0	12.0	7.9	12.6	7.7	
	40.0	9.7	7.4	10.0	7.7	10.6	7.6	11.2	8.0	11.8	7.8	12.4	7.7	
43.0	9.6	7.4	9.9	7.6	10.5	7.5	11.0	7.9	11.6	7.7	12.2	7.6		
125	20.0	12.9	9.2	13.5	9.6	14.6	9.6	15.6	10.1	16.5	9.9	17.5	9.7	
	22.5	12.9	9.2	13.5	9.5	14.4	9.5	15.4	10.0	16.3	9.8	17.2	9.7	
	25.0	12.8	9.1	13.3	9.5	14.3	9.4	15.2	9.9	16.1	9.7	17.0	9.6	
	27.5	12.7	9.1	13.2	9.4	14.1	9.4	15.0	9.8	15.8	9.6	16.7	9.5	
	30.0	12.6	9.0	13.1	9.3	13.9	9.3	14.8	9.7	15.6	9.6	16.5	9.4	
	32.5	12.5	9.0	12.9	9.3	13.8	9.2	14.6	9.6	15.4	9.5	16.2	9.3	
	35.0	12.4	8.9	12.8	9.2	13.6	9.1	14.4	9.5	15.2	9.4	16.0	9.2	
	37.5	12.3	8.9	12.7	9.1	13.5	9.0	14.2	9.5	15.0	9.3	15.7	9.1	
	40.0	12.2	8.8	12.5	9.1	13.3	9.0	14.0	9.4	14.8	9.2	15.5	9.0	
43.0	12.0	8.8	12.4	9.0	13.1	8.9	13.8	9.3	14.5	9.1	15.2	8.9		

PLFY-P-VKM-A,VAM-A

2-6.Heating Capacity (In combination with Big Y, Super Y, Big R2)

PLFY-P-VKM-A,VAM-A

Unit size	Outdoor air temp. °CWB	Indoor air temp.:°CDB			
		15	21	25	27
		SHC	SHC	SHC	SHC
32	-15.0	2.5	2.5	2.4	2.4
	-10.0	2.8	2.8	2.8	2.7
	-5.0	3.2	3.2	3.1	3.1
	0.0	3.6	3.5	3.4	3.1
	2.5	3.8	3.7	3.4	3.1
	6.0	4.0	4.0	3.4	3.1
	7.5	4.2	4.0	3.4	3.1
	10.0	4.4	4.0	3.4	3.1
	12.5	4.6	4.0	3.4	3.1
	15.5	4.6	4.0	3.4	3.1
40	-15.0	3.1	3.1	3.0	3.0
	-10.0	3.6	3.5	3.5	3.4
	-5.0	4.0	4.0	3.9	3.9
	0.0	4.5	4.4	4.3	3.9
	2.5	4.7	4.7	4.3	3.9
	6.0	5.0	5.0	4.3	3.9
	7.5	5.2	5.0	4.3	3.9
	10.0	5.4	5.0	4.3	3.9
	12.5	5.7	5.0	4.3	3.9
	15.5	5.8	5.0	4.3	3.9
50	-15.0	3.9	3.9	3.8	3.7
	-10.0	4.5	4.4	4.3	4.3
	-5.0	5.0	5.0	4.9	4.9
	0.0	5.6	5.6	5.4	4.9
	2.5	5.9	5.9	5.4	4.9
	6.0	6.4	6.3	5.4	4.9
	7.5	6.6	6.3	5.4	4.9
	10.0	6.9	6.3	5.4	4.9
	12.5	7.2	6.3	5.4	4.9
	15.5	7.2	6.3	5.4	4.9
63	-15.0	5.0	4.9	4.8	4.7
	-10.0	5.7	5.6	5.5	5.4
	-5.0	6.4	6.3	6.2	6.2
	0.0	7.2	7.1	6.8	6.2
	2.5	7.5	7.5	6.8	6.2
	6.0	8.1	8.0	6.8	6.2
	7.5	8.3	8.0	6.8	6.2
	10.0	8.7	8.0	6.8	6.2
	12.5	9.1	8.0	6.8	6.2
	15.5	9.2	8.0	6.8	6.2

SHC:Sensible Heat Capacity(kW)

Unit size	Outdoor air temp. °CWB	Indoor air temp.:°CDB			
		15	21	25	27
		SHC	SHC	SHC	SHC
80	-15.0	6.2	6.1	6.0	5.9
	-10.0	7.1	7.0	6.9	6.8
	-5.0	8.0	7.9	7.8	7.7
	0.0	8.9	8.8	8.5	7.7
	2.5	9.4	9.3	8.5	7.7
	6.0	10.1	10.0	8.5	7.7
	7.5	10.4	10.0	8.5	7.7
	10.0	10.9	10.0	8.5	7.7
	12.5	11.4	10.0	8.5	7.7
	15.5	11.5	10.0	8.5	7.7
100	-15.0	7.8	7.7	7.5	7.4
	-10.0	8.9	8.8	8.6	8.5
	-5.0	10.0	9.9	9.8	9.6
	0.0	11.2	11.0	10.6	9.6
	2.5	11.8	11.6	10.6	9.6
	6.0	12.6	12.5	10.6	9.6
	7.5	13.0	12.5	10.6	9.6
	10.0	13.6	12.5	10.6	9.6
	12.5	14.3	12.5	10.6	9.6
	15.5	14.4	12.5	10.6	9.6
125	-15.0	10.0	9.8	9.6	9.5
	-10.0	11.4	11.2	11.0	10.9
	-5.0	12.8	12.6	12.5	12.3
	0.0	14.3	14.1	13.6	12.3
	2.5	15.1	14.9	13.6	12.3
	6.0	16.2	16.0	13.6	12.3
	7.5	16.6	16.0	13.6	12.3
	10.0	17.4	16.0	13.6	12.3
	12.5	18.3	16.0	13.6	12.3
	15.5	18.4	16.0	13.6	12.3

2-7.Cooling Capacity (In combination with WY, WR2)

CA :Capacity(kW)

SHC:Sensible Heat Capacity(kW)

PLFY-P-VKM-A,VAM-A

Unit size	Water temp. °C	Indoor air temp.													
		21.5°CDB 15°CWB		23°CDB 16°CWB		25°CDB 18°CWB		27°CDB 19°CWB		28°CDB 20°CWB		30°CDB 22°CWB		32°CDB 24°CWB	
		CA	SHC	CA	SHC	CA	SHC	CA	SHC	CA	SHC	CA	SHC	CA	SHC
32	10	3.5	2.7	3.6	2.8	3.9	2.7	4.0	2.8	4.1	2.9	4.3	2.8	4.5	2.8
	20	3.4	2.6	3.5	2.7	3.7	2.7	3.8	2.7	3.9	2.8	4.1	2.8	4.4	2.7
	30	3.2	2.5	3.3	2.6	3.5	2.6	3.6	2.6	3.7	2.7	3.9	2.7	4.1	2.6
	40	2.8	2.3	2.9	2.4	3.1	2.4	3.1	2.4	3.2	2.5	3.4	2.5	3.6	2.5
	45	2.6	2.2	2.7	2.3	2.9	2.3	3.0	2.4	3.0	2.5	3.2	2.4	3.4	2.4
40	10	4.4	3.4	4.5	3.5	4.8	3.4	5.0	3.5	5.1	3.6	5.4	3.6	5.7	3.5
	20	4.2	3.3	4.4	3.4	4.6	3.4	4.8	3.4	4.9	3.5	5.2	3.5	5.5	3.4
	30	4.0	3.2	4.1	3.3	4.4	3.3	4.5	3.3	4.6	3.4	4.9	3.4	5.2	3.3
	40	3.5	2.9	3.6	3.0	3.8	3.0	3.9	3.1	4.0	3.2	4.3	3.2	4.5	3.1
	45	3.3	2.8	3.4	2.9	3.6	2.9	3.7	3.0	3.8	3.1	4.0	3.1	4.2	3.0
50	10	5.5	4.0	5.6	4.1	6.0	4.0	6.2	4.1	6.3	4.2	6.7	4.2	7.1	4.1
	20	5.3	3.9	5.4	4.0	5.8	3.9	5.9	4.0	6.1	4.1	6.5	4.1	6.8	4.0
	30	5.0	3.7	5.1	3.8	5.5	3.8	5.6	3.8	5.8	4.0	6.1	3.9	6.4	3.8
	40	4.3	3.4	4.5	3.5	4.7	3.5	4.9	3.5	5.0	3.7	5.3	3.6	5.6	3.6
	45	4.1	3.3	4.2	3.4	4.5	3.4	4.6	3.4	4.7	3.6	5.0	3.5	5.3	3.4
63	10	6.9	4.9	7.2	5.0	7.6	5.0	7.8	5.0	8.0	5.2	8.5	5.1	9.0	5.0
	20	6.7	4.7	6.9	4.9	7.3	4.8	7.5	4.9	7.8	5.0	8.2	5.0	8.6	4.9
	30	6.3	4.5	6.5	4.7	6.9	4.6	7.1	4.7	7.3	4.9	7.7	4.8	8.1	4.7
	40	5.5	4.1	5.7	4.3	6.0	4.2	6.2	4.3	6.4	4.4	6.7	4.4	7.1	4.3
	45	5.2	4.0	5.3	4.1	5.7	4.1	5.8	4.1	6.0	4.3	6.3	4.2	6.7	4.2
80	10	8.8	6.4	9.1	6.6	9.6	6.5	9.9	6.6	10.2	6.8	10.8	6.7	11.4	6.6
	20	8.5	6.2	8.7	6.4	9.3	6.3	9.5	6.4	9.8	6.7	10.4	6.5	10.9	6.4
	30	8.0	6.0	8.3	6.2	8.8	6.1	9.0	6.2	9.3	6.4	9.8	6.3	10.3	6.2
	40	6.9	5.5	7.2	5.7	7.6	5.6	7.8	5.7	8.1	5.9	8.5	5.8	9.0	5.7
	45	6.5	5.3	6.8	5.5	7.2	5.4	7.4	5.5	7.6	5.7	8.0	5.6	8.5	5.6
100	10	10.9	8.0	11.3	8.3	12.0	8.2	12.3	8.3	12.7	8.6	13.4	8.4	14.1	8.3
	20	10.5	7.8	10.9	8.1	11.6	8.0	11.9	8.1	12.2	8.4	12.9	8.3	13.6	8.1
	30	9.9	7.5	10.3	7.8	10.9	7.7	11.2	7.8	11.5	8.1	12.2	8.0	12.8	7.8
	40	8.6	6.9	8.9	7.2	9.5	7.1	9.7	7.2	10.0	7.5	10.6	7.4	11.2	7.3
	45	8.1	6.7	8.4	6.9	8.9	6.9	9.2	7.0	9.5	7.3	10.0	7.2	10.5	7.0
125	10	13.7	9.6	14.1	9.9	15.0	9.8	15.4	9.8	15.9	10.2	16.7	10.0	17.7	9.8
	20	13.2	9.3	13.6	9.6	14.5	9.5	14.8	9.6	15.3	9.9	16.1	9.8	17.0	9.6
	30	12.4	9.0	12.8	9.2	13.6	9.1	14.0	9.2	14.4	9.5	15.2	9.4	16.1	9.2
	40	10.8	8.1	11.2	8.4	11.9	8.3	12.2	8.4	12.5	8.7	13.2	8.6	14.0	8.5
	45	10.2	7.8	10.5	8.1	11.2	8.0	11.5	8.1	11.8	8.5	12.5	8.3	13.2	8.2

2-8.Heatling Capacity (In combination with WY, WR2)

PLFY-P-VKM-A,VAM-A

SHC:Sensible Heat Capacity(kW)

Unit size	Water temp. °C	Indoor air temp.:°CDB				
		15	19	20	25	27
		SHC	SHC	SHC	SHC	SHC
32	10	3.5	3.5	3.4	2.7	2.4
	20	4.1	4.1	4.0	3.2	2.9
	30	4.1	4.1	4.0	3.2	2.9
	40	4.3	4.2	4.2	3.3	3.0
	45	4.7	4.7	4.6	3.6	3.3
40	10	4.4	4.3	4.3	3.4	3.1
	20	5.2	5.1	5.0	4.0	3.6
	30	5.2	5.1	5.0	4.0	3.6
	40	5.4	5.3	5.2	4.2	3.7
	45	5.9	5.8	5.7	4.6	4.1
50	10	5.5	5.5	5.4	4.3	3.9
	20	6.5	6.4	6.3	5.0	4.5
	30	6.5	6.4	6.3	5.0	4.5
	40	6.7	6.7	6.6	5.2	4.7
	45	7.4	7.3	7.2	5.7	5.2
63	10	7.0	6.9	6.8	5.4	4.9
	20	8.2	8.2	8.0	6.4	5.8
	30	8.2	8.2	8.0	6.4	5.8
	40	8.6	8.5	8.3	6.7	6.0
	45	9.4	9.3	9.1	7.3	6.6
80	10	8.8	8.7	8.5	6.8	6.1
	20	10.3	10.2	10.0	8.0	7.2
	30	10.3	10.2	10.0	8.0	7.2
	40	10.7	10.6	10.4	8.3	7.5
	45	11.7	11.6	11.4	9.1	8.2
100	10	10.9	10.8	10.6	8.5	7.7
	20	12.9	12.8	12.5	10.0	9.0
	30	12.9	12.8	12.5	10.0	9.0
	40	13.4	13.3	13.0	10.4	9.4
	45	14.7	14.5	14.3	11.4	10.3
125	10	14.0	13.9	13.6	10.9	9.8
	20	16.5	16.3	16.0	12.8	11.5
	30	16.5	16.3	16.0	12.8	11.5
	40	17.1	17.0	16.6	13.3	12.0
	45	18.8	18.6	18.2	14.6	13.1

3. Sound Levels

3-1. Noise level

Cassette ceiling (VKM-A/VAM-A series)

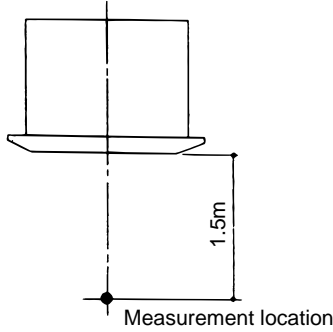

Noise level at anechoic room
(Low-Middle2-Middle1-High)

Unit : dB(A)

Model	Noise level (A weighted)
PLFY-P32VKM-A PLFY-P40VKM-A	31-32.5-34-35
PLFY-P50VKM-A	32-34-35.5-37
PLFY-P63VKM-A	35-36.5-38-39
PLFY-P80VAM-A	30-32-35-37
PLFY-P100VAM-A	33-36-39-41
PLFY-P125VAM-A	35-38-41-43

3-2. NC curves

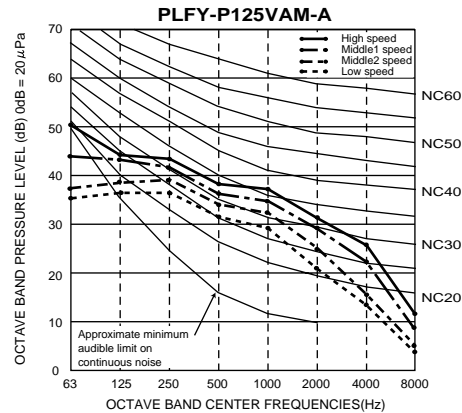
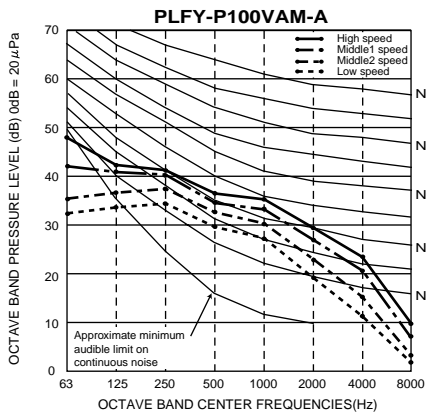
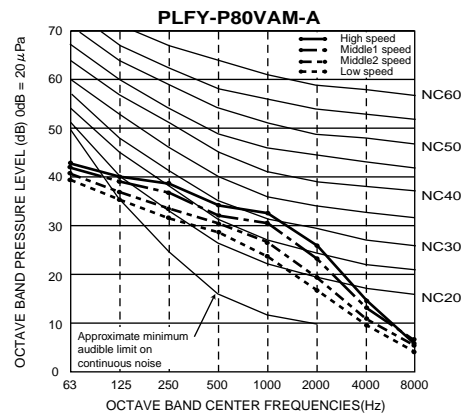
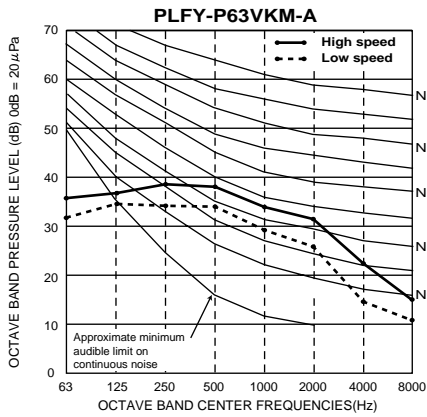
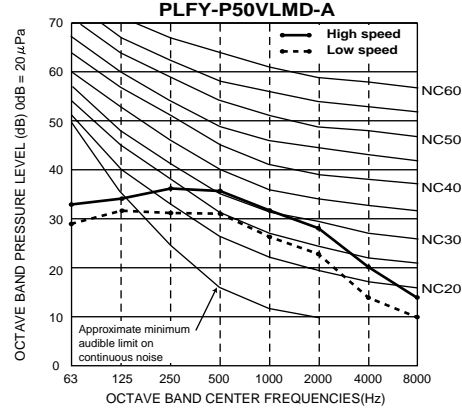
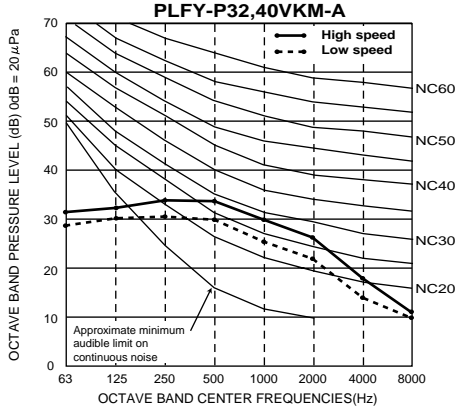

PLFY-P-
VKM-A/VAM-A

4. External Dimensions

PLFY-P32,40,50,63VKM-A

Unit : mm

NOTE 1. The electrical parts box may be removed during servicing. When connecting the power line and the control wire, provide enough length to the electric wires.

NOTE 2. When installing the optional high-efficiency filter, the dimension between the transom and ceiling shall be more than 440mm. Also, when installing the optional fresh air intake casement or the multi-functional case, the dimension between the transom and ceiling shall be more than 440mm. (The optional high-efficiency filter can also be installed.)

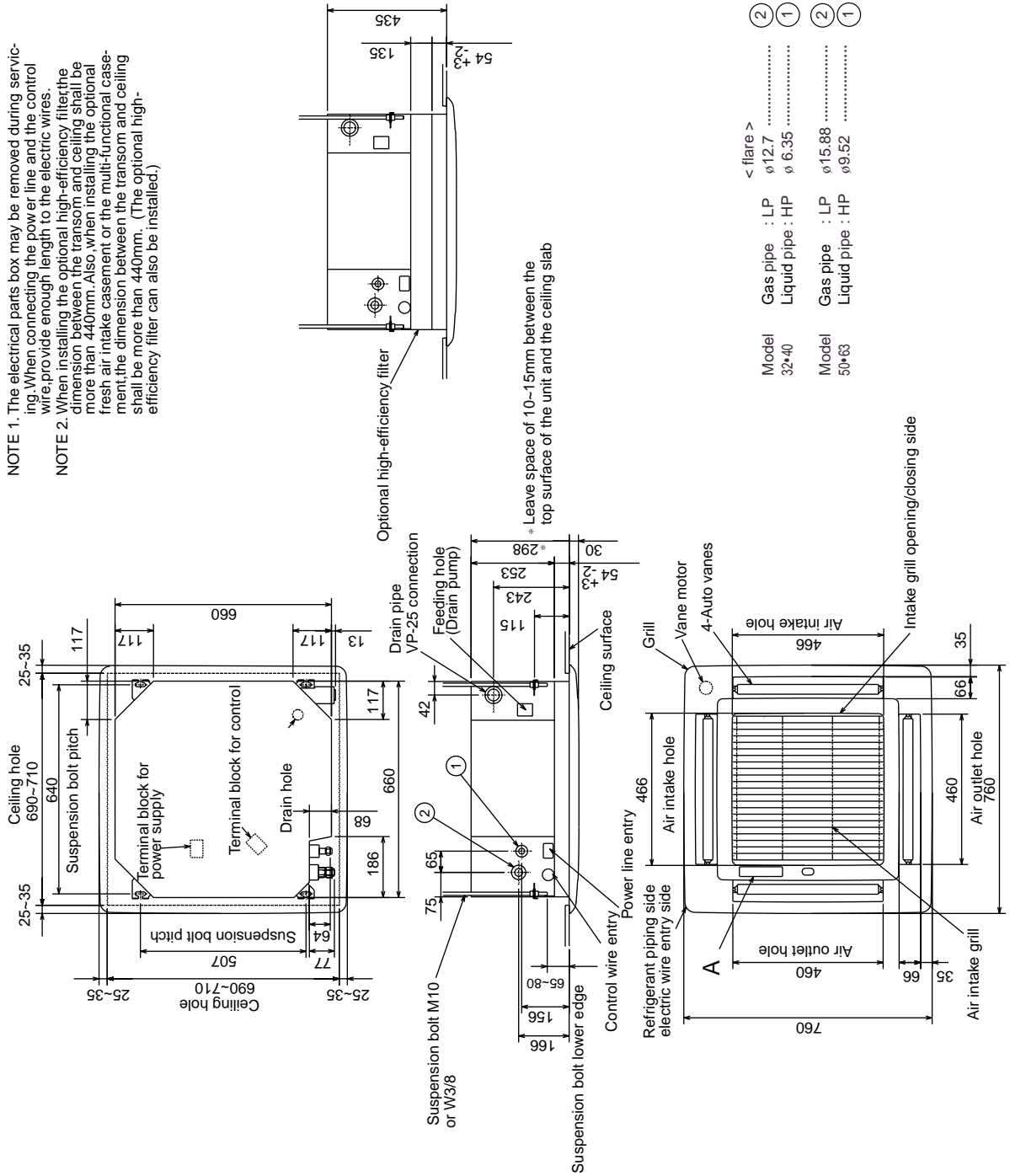

PLFY-P80,100,125VAM-A

Unit : mm

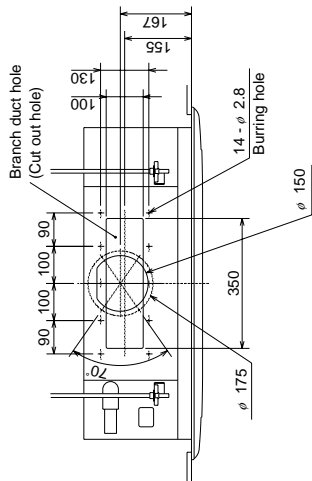
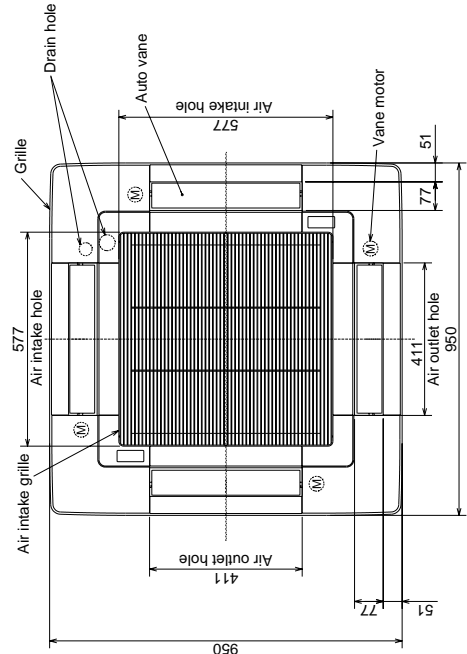
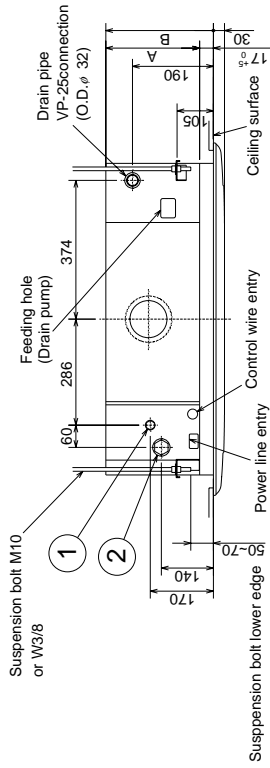
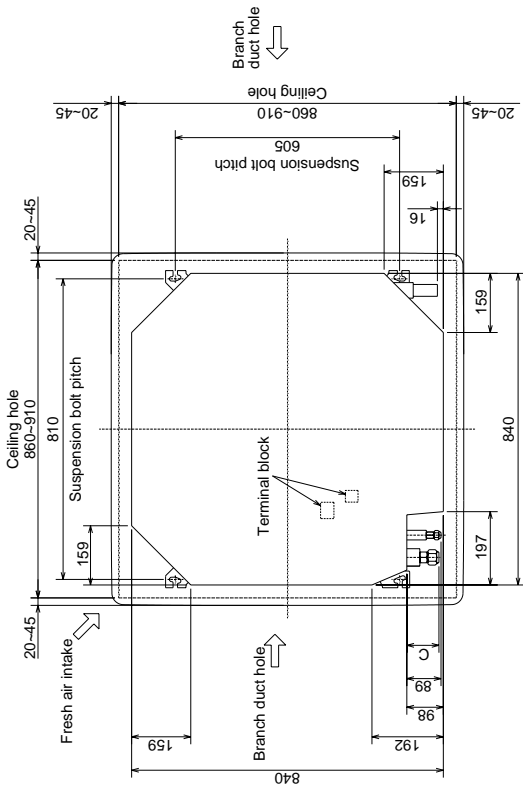

Detail drawing of fresh air intake

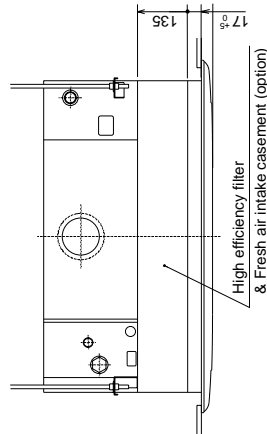
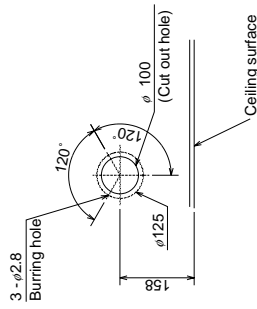

Models	①	②	A	B	C
PLFY-P80VAM-A	Refrigerant pipe (9.52mm dia.) flared connection 3/8F	Refrigerant pipe (15.88mm dia.) flared connection 5/8F	241	258	80
PLFY-P100,125VAM-A	Refrigerant pipe (9.52mm dia.) flared connection 3/8F	Refrigerant pipe (19.05mm dia.) flared connection 3/4F	281	298	84

5. Electrical Wiring Diagrams

● PLFY-P32~63VKM-A

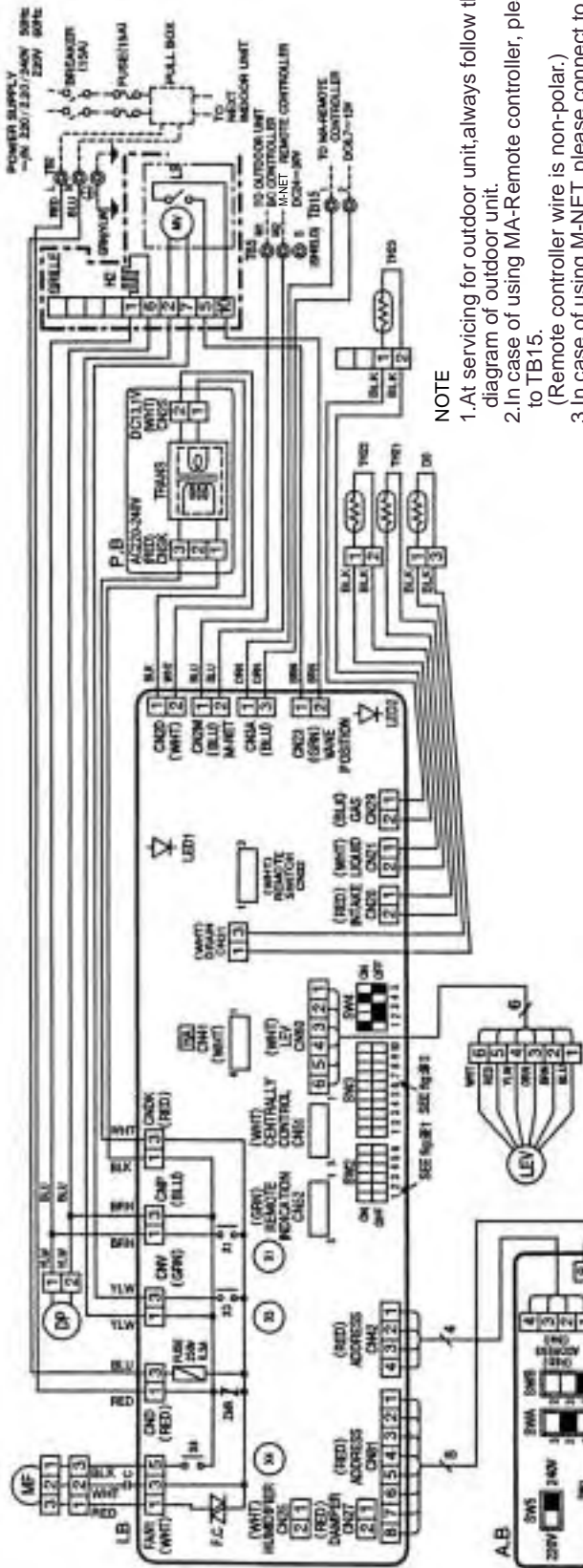

NOTE

1. At servicing for outdoor unit, always follow the wiring diagram of outdoor unit.
2. In case of using MA-Remote controller, please connect to TB15.
3. In case of using M-NET, please connect to TB5. (Transmission line is non-polar.)
4. Symbol[S] of TB5 is the shield wire connection.
5. Symbols used in wiring diagram above are,
 - ⊙: Terminal block, □: Connector.
6. The setting of the SW2 dip switches differs in the capacity. For the detail, refer to the fig. *1.
7. Please set the switch SW5 according to the power supply voltage.
 - Set SW5 to 240V side when the power supply is 230 and 240 volts.
 - When the power supply is 220 volts, set SW5 to 220V side.

[LEGEND]

SYMBOL	NAME	SYMBOL	CIRCUIT BOARD (ADDRESS)
IN25	INDOOR CONTROLLER BOARD	A, B	MODE SELECTION
GN27	HUMIDIFIER	SW1	VOLTAGE SELECTION
GN32	CONNECTOR	SW5	ADDRESS SETTING 1ST DIGIT
GN41	REMOTE SWITCH	SW11	ADDRESS SETTING 2ND DIGIT
GN51	CENTRALLY CONTROL	SW12	CONNECTION NO.
GN62	REMOTE INDICATION	SWA	CEILING HEIGHT SELECTOR
SW2	CAPACITY CODE	SWB	DISCHARGE OUTLET NUMBER
SW3	SWITCH	SWC	SECTOR
SW4	MODE SELECTION		OPTION SELECTOR
ZNR	VARIABLE RESISTOR	TH21	ROOM TEMP. DETECTION (0°C/15kΩ, 25°C/5.4kΩ)
FUSE	FUSE(6.3A)	TH22	PIPE TEMP. DETECTION/LIQUID (0°C/15kΩ, 25°C/5.4kΩ)
F.C	FAN PHASE CONTROL	TH23	PIPE TEMP. DETECTION/GAS (0°C/15kΩ, 25°C/5.4kΩ)
X1	DRAIN PUMP	LEV	LINEAR EXPANSION VALVE
X3	AUX-RELAY/VAINE	P.B	INDOOR POWER BOARD
X4	FAN MOTOR	C	CAPACITOR(FAN MOTOR)
LED1	POWER SUPPLY(L/B)	LS	LIMIT SWITCH
LED2	POWER SUPPLY(L/B)	H2	DEW PREVENTION HEATER
MF	FAN MOTOR(WITH INNER THERMO.)	DP	DRAIN WATER LIFTING-UP MACH.
IV	VAINE MOTOR	DS	DRAIN SENSOR
TB2	TERMINAL BLOCK		
TB5	TERMINAL BLOCK		
TB15	TERMINAL BLOCK		

Led on indoor board for service

Mark	Meaning	Function
LED1	Main power supply	Main power supply (indoor unit:220-240V) power on → lamp is lit
LED2	Power supply for MA-Remote controller	Power supply for MA-Remote controller on → lamp is lit

Position of TB2, TB5, TB15, (For Control box)



<fig.*1>

MODELS	SW2	MODELS	SW2
P32	ON OFF 1 2 3 4 5 6	P50	ON OFF 1 2 3 4 5 6
P40	ON OFF 1 2 3 4 5 6	P63	ON OFF 1 2 3 4 5 6

<fig.*2>

MODELS	SW3
P32,P40	ON OFF 1 2 3 4 5 6 7 8 9 10
P50,P63	ON OFF 1 2 3 4 5 6 7 8 9 10

● PLFY-P80~125VAM-A

<SYMBOL EXPLANATION>

SYMBOL	NAME	SYMBOL	NAME	SYMBOL	NAME
P.B	INDOOR POWER BOARD	C	CAPACITOR(FAN MOTOR)	TH23	THERMISTOR
I.B	INDOOR CONTROLLER BOARD	MF	FAN MOTOR(WITH INNER THERMO)		PIPE TEMPERATURE DETECTION / GAS (0°C/15kΩ, 25°C/5.4kΩ)
CN25	HUMIDIFIER	MV	VANE MOTOR	A.B	CIRCUIT BOARD
CN32	REMOTE SWITCH	DP	DRAIN WATER LIFTING-UP MACH	SW1	MODE SELECTION
CN41	CONNECTOR	DS	DRAIN SENSOR	SW5	VOLTAGE SELECTION
CN51	CENTRALLY CONTROL	H2	DEW PREVENTION HEATER	SW11	ADDRESS SETTING 1ST DIGIT
CN52	REMOTE INDICATION	TB2	TERMINAL BLOCK	SW12	ADDRESS SETTING 2ND DIGIT
SW2	CAPACITY CODE	TB5	TERMINAL BLOCK	SW14	CONNECTION No.
SW3	SWITCH	LEV	LINEAR EXPANSION VALVE	SWA	CEILING HEIGHT SELECTOR
SW4	SWITCH			SWB	DISCHARGE OUTLET NUMBER SELECTOR
ZNR	VARIATOR			SWC	OPTION SELECTOR
FUSE	FUSE (6.3A/250V)	TH21	THERMISTOR		
F.C	FAN PHASE CONTROL				
X1	AUX.RELAY				
X4	FAN MOTOR	TH22	THERMISTOR		
LED1	POWER SUPPLY(I.B)				
LED2	POWER SUPPLY(I.B)				

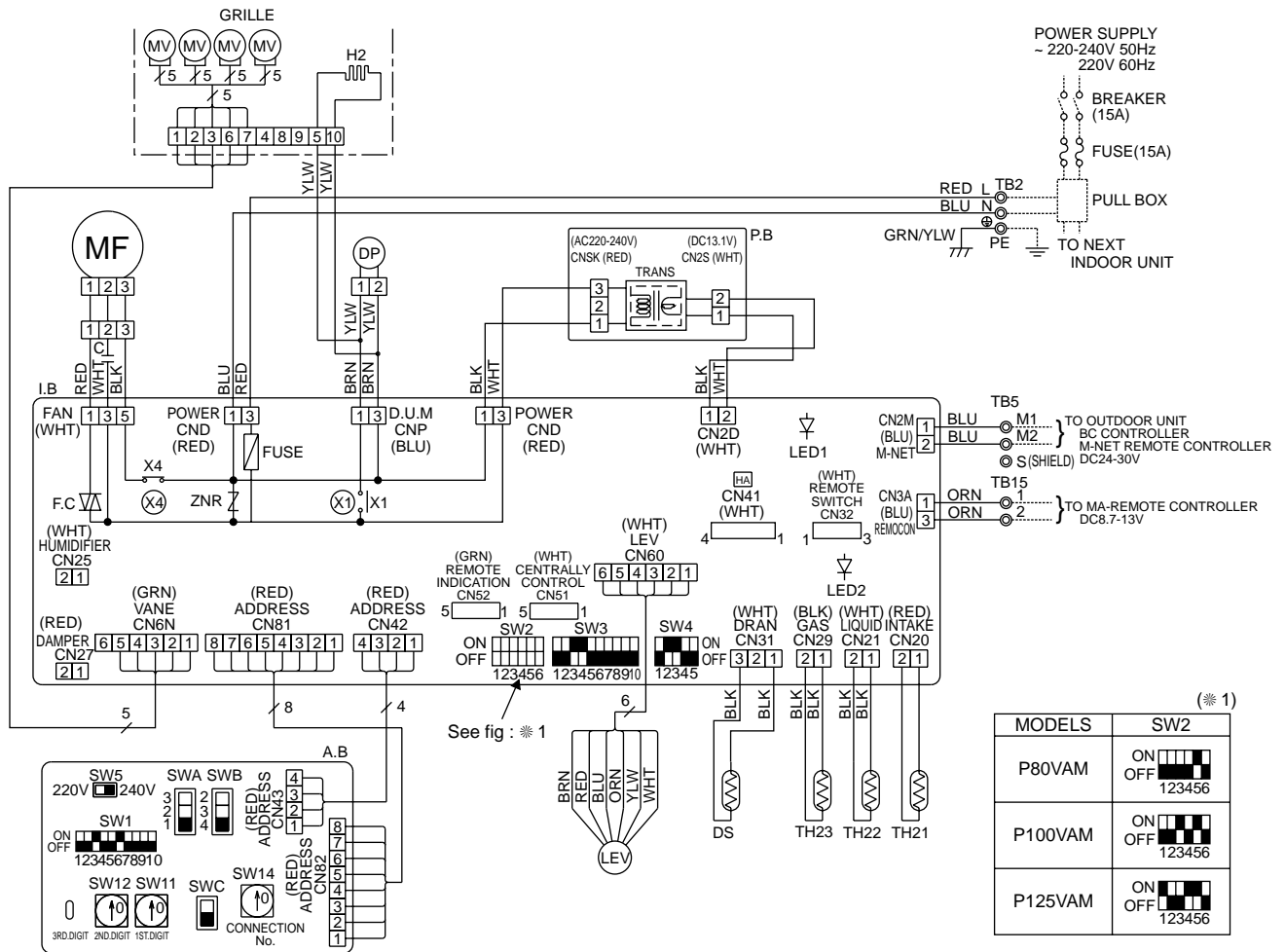

NOTE

1. At servicing for outdoor unit, always follow the wiring diagram of outdoor unit.
2. Symbol(S) of TB5 is the shield wire connection.
3. Symbols used in wiring diagram above are, ⊙: Terminal block, □: Connector.
4. The setting of the SW2 dip switches differs in the capacity for the detail, see the table below.
5. Please set the switch SW5 according to the power supply voltage.
Set SW5 to 240V side when the power supply is 230 and 240 volts.
When the power supply is 220 volts, set SW5 to 220V side.

6. Temperature/Airflow distribution

● Temperature distribution

<Cooling mode>
Flow angle 30°

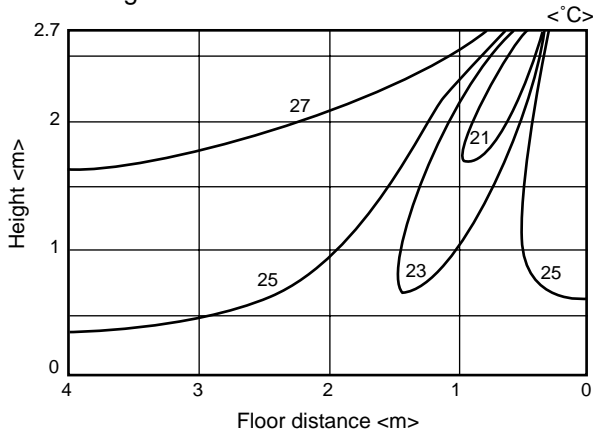

<Heating mode>
Flow angle 70°

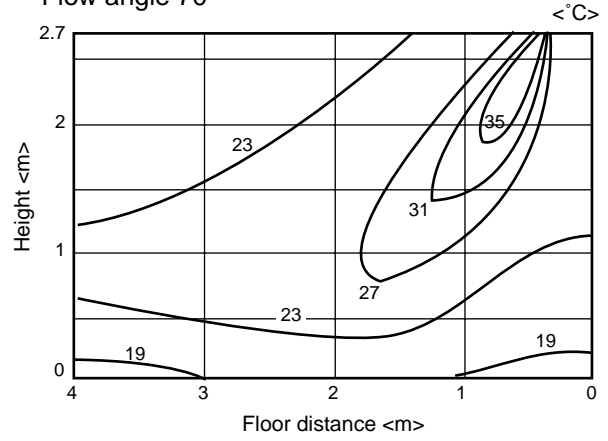

<Cooling mode>
Flow angle 70°

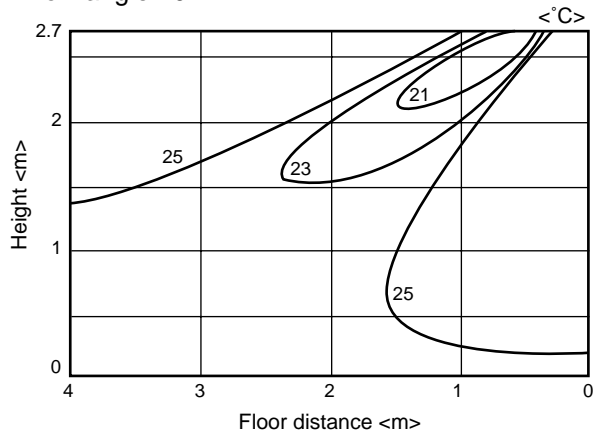

● Airflow distribution

<Fan mode>
Flow angle 70°

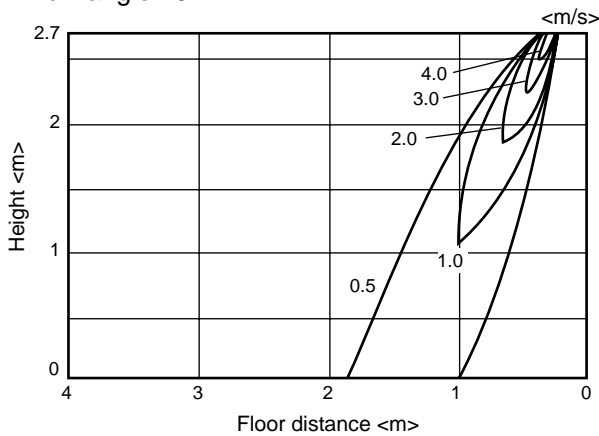

<Fan mode>
Flow angle 30°

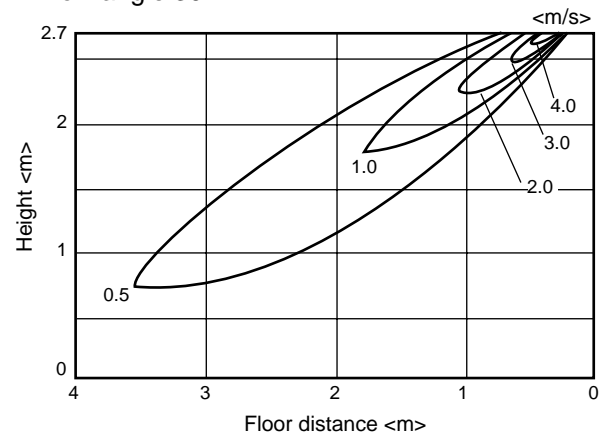

**PLFY-P-
VKM-A/VAM-A**

7. Options

Description	Model	Applicable capacity
Decoration panel	PLP-25KB	P32/P40/P50/P63
Space panel	PAC-SE01AS-E	
Wide panel	PAC-SE06WP-E	
Air outlet shutter plate	PAC-SE14SP-E	P80/P100/P125
	PAC-SG06SP-E	
High efficiency filter element	PAC-SE13KF-E (PAC-SE21TM-E is necessary to use this filter)	P32/P40/P50/P63
	PAC-SG01KF	P80/P100/P125
Multi-function casement (High efficiency filter casement Fresh air intake casement)	PAC-SE21TM-E	P32/P40/P50/P63
Multi-function casement	PAC-SG03TM-E	P80/P100/P125

Wall mounted

PKFY-P-VAM-A
PKFY-P-VGM-A

CONTENTS

1. Specifications	II -170
2. Capacity Tables	II -171
2-1 Cooling Capacity(PUMY)	II -171
2-2 Heating Capacity(PUMY)	II -172
2-3 Cooling Capacity(Y/R2-8-10-13HP)	II -173
2-4 Heating Capacity(Y/R2-8-10-13HP)	II -174
2-5 Cooling Capacity(Big Y, Super Y, Big R2)	II -175
2-6 Heating Capacity(Big Y, Super Y, Big R2)	II -176
2-7 Cooling Capacity(WY, WR2)	II -177
2-8 Heating Capacity(WY, WR2)	II -177
3. Sound Levels	II -178
3-1 Noise levels	II -178
3-2 N/C curves	II -178
4. External Dimensions	II -179
5. Electrical Wiring Diagrams	II -181
5-1 PKFY-P-VAM-A	II -181
5-2 PKFY-P-VGM-A	II -182
6. Temperature/Airflow distribution	II -183
6-1 PKFY-P-VAM-A	II -183
6-2 PKFY-P-VGM-A	II -184

1. Specifications

PKFY-P-VAM-A/VGM-A

			PKFY-P20VAM-A	PKFY-P25VAM-A	PKFY-P32VGM-A	PKFY-P40VGM-A	PKFY-P50VGM-A	
Power source			~ 220-240V 50Hz ~ 220V 60Hz					
Cooling capacity	*1	kW	2.2	2.8	3.6	4.5	5.6	
	*2	kcal/h	2,000	2,500	3,150	4,000	5,000	
Heating capacity	*1	kW	2.5	3.2	4.0	5.0	6.3	
Power consumption	Cooling	kW	0.04		0.07			
	Heating	kW	0.04		0.07			
Current	Cooling	A	0.20		0.32			
	Heating	A	0.20		0.32			
External finish(Munsel No.)			Plastic 2.60Y 8.66/0.69		Plastic <PS,ABS> white 0.70Y 8.59/0.97			
Dimension	Height	mm	295		340			
	Width	mm	815		990			
	Depth	mm	158		235			
Net weight	kg	8.5		16				
Heat exchanger			Cross fin (Aluminum plate fin and copper tube)					
Fan	Type	Line flow fan X 1						
	Airflow rate (Lo-Mid2-Mid1-Hi)	*3	m ³ /min	4.9-5.2-5.6-5.9		8-9.5-10.5-11.5		9-10-11-12
	External static pressure		Pa	0				
Motor	Type	Single phase induction motor						
	Output		kW	0.017		0.030		
Air filter			PP Honeycomb (long life)					
Refrigerant pipe dimension	Gas (Flare)	mm	ø 12.7				ø 15.88	
	Liquid (Flare)	mm	ø 6.35				ø 9.52	
Drain pipe dimension			ø 28,VP-16		VP-20			
Noise level (Lo-Mid2-Mid1-Hi)			*3 *4	dB(A) 32-33-35-36		33-36-38-41		34-37-40-43

Note: *1 Cooling/Heating capacity indicates the maximum value at operation under the following condition.

Cooling : Indoor 27°CDB/19°CWB, Outdoor 35°CDB
 Heating : Indoor 20°CDB, Outdoor 7°CDB/6°CWB

*2 Cooling capacity indicates the maximum value at operation under the following condition.
 Cooling : Indoor 27°CDB/19.5°CWB, Outdoor 35°CDB (WR2: water 30°C)

*3 Airflow rate/noise level are in (low-middle2-middle1-high).

*4 It is measured in anechoic room.

2. Capacity Tables

2-1.Cooling Capacity (In combination with PUMY)

CA:Capacity(kW)
SHC:Sensible Heat Capacity(kW)

PKFY-P-VAM-A,VGM-A

PKFY-P-VAM-A,VGM-A

Unit size	Outdoor air temp.	Indoor air temp.							
		23°CDB 16°CWB		25°CDB 18°CWB		28°CDB 20°CWB		30°CDB 22°CWB	
		°CDB	CA	SHC	CA	SHC	CA	SHC	CA
20 (2.2)	20.0	2.2	1.5	2.3	1.6	2.4	1.6	2.6	1.6
	22.5	2.1	1.5	2.3	1.6	2.4	1.6	2.6	1.6
	25.0	2.1	1.5	2.3	1.6	2.4	1.6	2.5	1.6
	27.5	2.1	1.5	2.2	1.6	2.4	1.6	2.5	1.6
	30.0	2.1	1.5	2.2	1.5	2.3	1.5	2.5	1.6
	32.5	2.0	1.5	2.2	1.5	2.3	1.5	2.5	1.6
	35.0	2.0	1.4	2.1	1.5	2.3	1.5	2.4	1.6
	37.5	2.0	1.4	2.1	1.5	2.2	1.5	2.4	1.5
	40.0	2.0	1.4	2.1	1.5	2.2	1.5	2.4	1.5
46.0	1.9	1.4	2.0	1.5	2.1	1.4	2.3	1.5	
25 (2.8)	20.0	2.8	1.9	2.9	2.0	3.1	2.0	3.3	2.0
	22.5	2.7	1.9	2.9	2.0	3.1	2.0	3.2	2.0
	25.0	2.7	1.9	2.9	2.0	3.1	2.0	3.2	2.0
	27.5	2.7	1.9	2.8	2.0	3.0	1.9	3.2	2.0
	30.0	2.6	1.8	2.8	1.9	3.0	1.9	3.2	2.0
	32.5	2.6	1.8	2.8	1.9	2.9	1.9	3.1	2.0
	35.0	2.6	1.8	2.7	1.9	2.9	1.9	3.1	1.9
	37.5	2.5	1.8	2.7	1.9	2.9	1.9	3.0	1.9
	40.0	2.5	1.8	2.7	1.9	2.8	1.8	3.0	1.9
46.0	2.4	1.7	2.6	1.8	2.7	1.8	2.9	1.9	
32 (3.6)	20.0	3.6	2.8	3.7	3.0	4.0	3.0	4.2	3.1
	22.5	3.5	2.8	3.7	3.0	4.0	2.9	4.2	3.0
	25.0	3.5	2.8	3.7	2.9	3.9	2.9	4.1	3.0
	27.5	3.4	2.8	3.6	2.9	3.9	2.9	4.1	3.0
	30.0	3.4	2.8	3.6	2.9	3.8	2.9	4.1	3.0
	32.5	3.3	2.7	3.6	2.9	3.8	2.9	4.0	3.0
	35.0	3.3	2.7	3.5	2.9	3.7	2.8	4.0	2.9
	37.5	3.2	2.7	3.5	2.8	3.7	2.8	3.9	2.9
	40.0	3.2	2.7	3.4	2.8	3.6	2.8	3.9	2.9
46.0	3.1	2.6	3.3	2.8	3.5	2.7	3.7	2.8	
40 (4.5)	20.0	4.5	3.3	4.7	3.4	5.0	3.4	5.3	3.5
	22.5	4.4	3.2	4.6	3.4	5.0	3.4	5.2	3.4
	25.0	4.3	3.2	4.6	3.4	4.9	3.3	5.2	3.4
	27.5	4.3	3.2	4.6	3.3	4.9	3.3	5.1	3.4
	30.0	4.2	3.1	4.5	3.3	4.8	3.3	5.1	3.4
	32.5	4.2	3.1	4.4	3.3	4.7	3.2	5.0	3.4
	35.0	4.1	3.1	4.4	3.2	4.7	3.2	5.0	3.3
	37.5	4.1	3.1	4.3	3.2	4.6	3.2	4.9	3.3
	40.0	4.0	3.0	4.3	3.2	4.5	3.2	4.8	3.3
46.0	3.8	3.0	4.1	3.1	4.3	3.1	4.6	3.2	
50 (5.6)	20.0	5.5	3.8	5.8	4.0	6.2	4.0	6.6	4.1
	22.5	5.5	3.8	5.8	3.9	6.2	3.9	6.5	4.0
	25.0	5.4	3.8	5.7	3.9	6.1	3.9	6.4	4.0
	27.5	5.3	3.7	5.7	3.9	6.0	3.9	6.4	4.0
	30.0	5.3	3.7	5.6	3.9	5.9	3.8	6.3	3.9
	32.5	5.2	3.6	5.5	3.8	5.9	3.8	6.2	3.9
	35.0	5.1	3.6	5.5	3.8	5.8	3.7	6.2	3.9
	37.5	5.0	3.6	5.4	3.7	5.7	3.7	6.1	3.8
	40.0	5.0	3.5	5.3	3.7	5.6	3.7	6.0	3.8
46.0	4.8	3.4	5.1	3.6	5.4	3.6	5.8	3.7	

2-2.Heating Capacity (In combination with PUMY)

PKFY-P-VAM-A,VGM-A

Unit size	Outdoor air temp. °CWB	Indoor air temp.:°CDB		
		15.0 SHC	20.0 SHC	25.0 SHC
20	-12.0	1.6	1.6	1.5
	-10.0	1.7	1.6	1.6
	-5.0	1.9	1.9	1.9
	0.0	2.2	2.1	2.1
	2.5	2.3	2.3	2.3
	6.0	2.5	2.5	2.5
	7.5	2.6	2.6	2.5
	10.0	2.8	2.7	2.5
	12.5	2.9	2.8	2.5
15.5	3.1	2.8	2.5	
25	-12.0	2.0	2.0	2.0
	-10.0	2.1	2.1	2.1
	-5.0	2.4	2.4	2.4
	0.0	2.8	2.8	2.7
	2.5	3.0	2.9	2.9
	6.0	3.2	3.2	3.2
	7.5	3.3	3.3	3.2
	10.0	3.5	3.5	3.2
	12.5	3.7	3.5	3.2
15.5	3.9	3.5	3.2	

SHC:Sensible Heat Capacity(kW)

Unit size	Outdoor air temp. °CWB	Indoor air temp.:°CDB		
		15.0 SHC	20.0 SHC	25.0 SHC
32	-12.0	2.5	2.5	2.5
	-10.0	2.7	2.6	2.6
	-5.0	3.1	3.0	3.0
	0.0	3.5	3.4	3.4
	2.5	3.7	3.7	3.6
	6.0	4.0	4.0	3.9
	7.5	4.2	4.1	4.0
	10.0	4.4	4.4	4.0
	12.5	4.7	4.4	4.0
15.5	4.9	4.4	4.0	
40	-12.0	3.2	3.1	3.1
	-10.0	3.4	3.3	3.2
	-5.0	3.8	3.8	3.7
	0.0	4.3	4.3	4.2
	2.5	4.6	4.6	4.5
	6.0	5.0	5.0	4.9
	7.5	5.2	5.2	5.0
	10.0	5.5	5.5	5.0
	12.5	5.9	5.5	5.0
15.5	6.2	5.5	5.0	
50	-12.0	4.0	3.9	3.9
	-10.0	4.2	4.2	4.1
	-5.0	4.8	4.8	4.7
	0.0	5.5	5.4	5.3
	2.5	5.8	5.8	5.7
	6.0	6.3	6.3	6.2
	7.5	6.6	6.5	6.2
	10.0	7.0	6.9	6.2
	12.5	7.4	7.0	6.2
15.5	7.7	7.0	6.2	

2-3.Cooling Capacity (In combination with PU(H)Y, PURY-(P)200-250-315YEM-A, TEM-A)

PKFY-P-VAM-A,VGM-A

CA:Capacity(kW)

SHC:Sensible Heat Capacity(kW)

Unit size	Outdoor air temp.	Indoor air temp.													
		21.5°CDB 15°CWB		23°CDB 16°CWB		25°CDB 18°CWB		27°CDB 19°CWB		28°CDB 20°CWB		30°CDB 22°CWB		32°CDB 24°CWB	
		°CDB	CA	SHC	CA	SHC	CA	SHC	CA	SHC	CA	SHC	CA	SHC	CA
20 (2.2)	20.0	2.2	1.5	2.2	1.5	2.3	1.5	2.3	1.5	2.4	1.6	2.5	1.5	2.6	1.5
	22.5	2.1	1.5	2.2	1.5	2.3	1.5	2.3	1.5	2.4	1.5	2.4	1.5	2.5	1.5
	25.0	2.1	1.5	2.2	1.5	2.2	1.5	2.3	1.5	2.3	1.5	2.4	1.5	2.5	1.5
	27.5	2.1	1.5	2.1	1.5	2.2	1.5	2.3	1.5	2.3	1.5	2.4	1.5	2.5	1.4
	30.0	2.1	1.5	2.1	1.5	2.2	1.5	2.2	1.5	2.3	1.5	2.4	1.5	2.5	1.4
	32.5	2.0	1.5	2.1	1.5	2.2	1.5	2.2	1.5	2.3	1.5	2.4	1.5	2.4	1.4
	35.0	2.0	1.5	2.1	1.5	2.2	1.5	2.2	1.5	2.2	1.5	2.3	1.5	2.4	1.4
	37.5	2.0	1.4	2.0	1.5	2.1	1.4	2.2	1.4	2.2	1.5	2.3	1.5	2.4	1.4
	40.0	2.0	1.4	2.0	1.5	2.1	1.4	2.2	1.4	2.2	1.5	2.3	1.4	2.4	1.4
43.0	2.0	1.4	2.0	1.4	2.1	1.4	2.1	1.4	2.2	1.5	2.3	1.4	2.3	1.4	
25 (2.8)	20.0	2.7	1.9	2.8	1.9	2.9	1.9	3.0	1.9	3.0	1.9	3.1	1.9	3.2	1.8
	22.5	2.7	1.9	2.8	1.9	2.9	1.9	2.9	1.9	3.0	1.9	3.1	1.9	3.2	1.8
	25.0	2.7	1.9	2.7	1.9	2.9	1.9	2.9	1.9	3.0	1.9	3.1	1.9	3.2	1.8
	27.5	2.7	1.9	2.7	1.9	2.8	1.8	2.9	1.9	2.9	1.9	3.1	1.9	3.2	1.8
	30.0	2.6	1.8	2.7	1.9	2.8	1.8	2.9	1.8	2.9	1.9	3.0	1.8	3.1	1.8
	32.5	2.6	1.8	2.7	1.9	2.8	1.8	2.8	1.8	2.9	1.9	3.0	1.8	3.1	1.8
	35.0	2.6	1.8	2.6	1.9	2.7	1.8	2.8	1.8	2.9	1.9	3.0	1.8	3.1	1.8
	37.5	2.5	1.8	2.6	1.8	2.7	1.8	2.8	1.8	2.8	1.9	2.9	1.8	3.1	1.8
	40.0	2.5	1.8	2.6	1.8	2.7	1.8	2.7	1.8	2.8	1.8	2.9	1.8	3.0	1.7
43.0	2.5	1.8	2.5	1.8	2.7	1.8	2.7	1.8	2.8	1.8	2.9	1.8	3.0	1.7	
32 (3.6)	20.0	3.5	2.8	3.6	2.9	3.7	2.8	3.8	2.9	3.9	3.0	4.0	2.9	4.2	2.8
	22.5	3.5	2.8	3.6	2.9	3.7	2.8	3.8	2.9	3.9	3.0	4.0	2.9	4.1	2.8
	25.0	3.5	2.8	3.5	2.9	3.7	2.8	3.7	2.9	3.8	3.0	4.0	2.9	4.1	2.8
	27.5	3.4	2.8	3.5	2.9	3.6	2.8	3.7	2.8	3.8	2.9	3.9	2.9	4.1	2.8
	30.0	3.4	2.8	3.5	2.8	3.6	2.8	3.7	2.8	3.7	2.9	3.9	2.9	4.0	2.8
	32.5	3.3	2.7	3.4	2.8	3.6	2.8	3.6	2.8	3.7	2.9	3.9	2.9	4.0	2.8
	35.0	3.3	2.7	3.4	2.8	3.5	2.8	3.6	2.8	3.7	2.9	3.8	2.8	4.0	2.8
	37.5	3.3	2.7	3.3	2.8	3.5	2.7	3.6	2.8	3.6	2.9	3.8	2.8	3.9	2.8
	40.0	3.2	2.7	3.3	2.8	3.5	2.7	3.5	2.8	3.6	2.9	3.7	2.8	3.9	2.7
43.0	3.2	2.7	3.3	2.8	3.4	2.7	3.5	2.8	3.6	2.9	3.7	2.8	3.8	2.7	
40 (4.5)	20.0	4.4	3.2	4.5	3.3	4.7	3.2	4.8	3.2	4.9	3.3	5.0	3.3	5.2	3.2
	22.5	4.4	3.2	4.5	3.3	4.6	3.2	4.7	3.2	4.8	3.3	5.0	3.2	5.2	3.2
	25.0	4.3	3.2	4.4	3.3	4.6	3.2	4.7	3.2	4.8	3.3	5.0	3.2	5.1	3.1
	27.5	4.3	3.2	4.4	3.2	4.5	3.2	4.6	3.2	4.7	3.3	4.9	3.2	5.1	3.1
	30.0	4.2	3.1	4.3	3.2	4.5	3.1	4.6	3.2	4.7	3.3	4.9	3.2	5.0	3.1
	32.5	4.2	3.1	4.3	3.2	4.5	3.1	4.5	3.2	4.6	3.3	4.8	3.2	5.0	3.1
	35.0	4.1	3.1	4.2	3.2	4.4	3.1	4.5	3.1	4.6	3.2	4.8	3.2	5.0	3.1
	37.5	4.1	3.1	4.2	3.2	4.4	3.1	4.5	3.1	4.5	3.2	4.7	3.1	4.9	3.1
	40.0	4.1	3.1	4.1	3.1	4.3	3.1	4.4	3.1	4.5	3.2	4.7	3.1	4.9	3.0
43.0	4.0	3.0	4.1	3.1	4.3	3.0	4.4	3.1	4.4	3.2	4.6	3.1	4.8	3.0	
50 (5.6)	20.0	5.5	3.8	5.6	3.9	5.8	3.8	5.9	3.8	6.0	3.9	6.3	3.7	6.5	3.6
	22.5	5.4	3.8	5.5	3.8	5.8	3.7	5.9	3.7	6.0	3.8	6.2	3.7	6.4	3.6
	25.0	5.4	3.7	5.5	3.8	5.7	3.7	5.8	3.7	5.9	3.8	6.2	3.7	6.4	3.6
	27.5	5.3	3.7	5.4	3.8	5.7	3.7	5.8	3.7	5.9	3.8	6.1	3.7	6.3	3.6
	30.0	5.3	3.7	5.4	3.7	5.6	3.7	5.7	3.7	5.8	3.8	6.0	3.7	6.3	3.5
	32.5	5.2	3.6	5.3	3.7	5.5	3.6	5.7	3.6	5.8	3.7	6.0	3.6	6.2	3.5
	35.0	5.2	3.6	5.3	3.7	5.5	3.6	5.6	3.6	5.7	3.7	5.9	3.6	6.2	3.5
	37.5	5.1	3.6	5.2	3.7	5.4	3.6	5.5	3.6	5.7	3.7	5.9	3.6	6.1	3.5
	40.0	5.0	3.6	5.2	3.6	5.4	3.5	5.5	3.6	5.6	3.7	5.8	3.6	6.0	3.5
43.0	5.0	3.5	5.1	3.6	5.3	3.5	5.4	3.5	5.5	3.6	5.8	3.5	6.0	3.4	

2-4.Heating Capacity (In combination with PU(H)Y, PURY-(P)200-250-315YEM-A, TEM-A)

PKFY-P-VAM-A,VGM-A

SHC:Sensible Heat Capacity(kW)

Unit size	Outdoor air temp.	Indoor air temp.:°CDB			
		15.0	20.0	25.0	27.0
		°CWB	SHC	SHC	SHC
20	-15.0	1.7	1.6	1.6	1.6
	-10.0	1.9	1.9	1.9	1.7
	-5.0	2.1	2.1	2.0	1.7
	0.0	2.4	2.4	2.0	1.7
	2.5	2.5	2.5	2.0	1.7
	6.0	2.5	2.5	2.0	1.7
	7.5	2.6	2.5	2.0	1.7
	10.0	2.8	2.5	2.0	1.7
	12.5	3.0	2.5	2.0	1.7
	15.5	3.0	2.5	2.0	1.7
25	-15.0	2.1	2.1	2.1	2.1
	-10.0	2.4	2.4	2.4	2.2
	-5.0	2.7	2.7	2.5	2.2
	0.0	3.1	3.0	2.5	2.2
	2.5	3.2	3.2	2.5	2.2
	6.0	3.2	3.2	2.5	2.2
	7.5	3.4	3.2	2.5	2.2
	10.0	3.6	3.2	2.5	2.2
	12.5	3.8	3.2	2.5	2.2
	15.5	3.9	3.2	2.5	2.2

Unit size	Outdoor air temp.	Indoor air temp.:°CDB			
		15.0	20.0	25.0	27.0
		°CWB	SHC	SHC	SHC
32	-15.0	2.7	2.6	2.6	2.6
	-10.0	3.1	3.0	3.0	2.8
	-5.0	3.4	3.4	3.1	2.8
	0.0	3.8	3.8	3.1	2.8
	2.5	4.0	4.0	3.1	2.8
	6.0	4.0	4.0	3.1	2.8
	7.5	4.2	4.0	3.1	2.8
	10.0	4.5	4.0	3.1	2.8
	12.5	4.8	4.0	3.1	2.8
	15.5	4.8	4.0	3.1	2.8
40	-15.0	3.3	3.3	3.3	3.3
	-10.0	3.8	3.8	3.7	3.5
	-5.0	4.3	4.2	3.9	3.5
	0.0	4.8	4.7	3.9	3.5
	2.5	5.0	5.0	3.9	3.5
	6.0	5.1	5.0	3.9	3.5
	7.5	5.3	5.0	3.9	3.5
	10.0	5.6	5.0	3.9	3.5
	12.5	6.0	5.0	3.9	3.5
	15.5	6.1	5.0	3.9	3.5
50	-15.0	4.2	4.2	4.1	4.1
	-10.0	4.8	4.8	4.7	4.3
	-5.0	5.4	5.3	4.9	4.3
	0.0	6.0	5.9	4.9	4.3
	2.5	6.3	6.2	4.9	4.3
	6.0	6.4	6.3	4.9	4.3
	7.5	6.6	6.3	4.9	4.3
	10.0	7.1	6.3	4.9	4.3
	12.5	7.5	6.3	4.9	4.3
	15.5	7.6	6.3	4.9	4.3

2-5.Cooling Capacity (In combination with Big Y, Super Y, Big R2)

PKFY-P-VAM-A,VGM-A

CA:Capacity(kW)
 SHC:Sensible Heat Capacity(kW)

Unit size	Outdoor air temp.	Indoor air temp.:°CDB											
		21.5°CDB 15°CWB		23°CDB 16°CWB		25°CDB 18°CWB		28°CDB 20°CWB		30°CDB 22°CWB		32°CDB 24°CWB	
		°CDB	CA	SHC	CA	SHC	CA	SHC	CA	SHC	CA	SHC	CA
20	20.0	2.0	1.5	2.1	1.5	2.3	1.5	2.4	1.6	2.6	1.6	2.7	1.5
	22.5	2.0	1.5	2.1	1.5	2.3	1.5	2.4	1.6	2.6	1.6	2.7	1.5
	25.0	2.0	1.4	2.1	1.5	2.2	1.5	2.4	1.6	2.5	1.5	2.7	1.5
	27.5	2.0	1.4	2.1	1.5	2.2	1.5	2.4	1.6	2.5	1.5	2.6	1.5
	30.0	2.0	1.4	2.1	1.5	2.2	1.5	2.3	1.5	2.5	1.5	2.6	1.5
	32.5	2.0	1.4	2.0	1.5	2.2	1.5	2.3	1.5	2.4	1.5	2.6	1.5
	35.0	1.9	1.4	2.0	1.5	2.1	1.4	2.3	1.5	2.4	1.5	2.5	1.5
	37.5	1.9	1.4	2.0	1.4	2.1	1.4	2.2	1.5	2.4	1.5	2.5	1.4
	40.0	1.9	1.4	2.0	1.4	2.1	1.4	2.2	1.5	2.3	1.5	2.4	1.4
43.0	1.9	1.4	1.9	1.4	2.1	1.4	2.2	1.5	2.3	1.4	2.4	1.4	
25	20.0	2.6	1.8	2.7	1.9	2.9	1.9	3.1	2.0	3.3	2.0	3.5	1.9
	22.5	2.6	1.8	2.7	1.9	2.9	1.9	3.1	2.0	3.3	1.9	3.4	1.9
	25.0	2.6	1.8	2.7	1.9	2.9	1.9	3.0	1.9	3.2	1.9	3.4	1.9
	27.5	2.5	1.8	2.6	1.9	2.8	1.8	3.0	1.9	3.2	1.9	3.3	1.9
	30.0	2.5	1.8	2.6	1.8	2.8	1.8	3.0	1.9	3.1	1.9	3.3	1.8
	32.5	2.5	1.8	2.6	1.8	2.8	1.8	2.9	1.9	3.1	1.9	3.2	1.8
	35.0	2.5	1.8	2.6	1.8	2.7	1.8	2.9	1.9	3.0	1.8	3.2	1.8
	37.5	2.5	1.8	2.5	1.8	2.7	1.8	2.8	1.9	3.0	1.8	3.1	1.8
	40.0	2.4	1.7	2.5	1.8	2.7	1.8	2.8	1.8	3.0	1.8	3.1	1.8
43.0	2.4	1.7	2.5	1.8	2.6	1.8	2.8	1.8	2.9	1.8	3.0	1.7	
32	20.0	3.3	2.7	3.5	2.9	3.7	2.8	4.0	3.0	4.2	3.0	4.5	2.9
	22.5	3.3	2.7	3.5	2.8	3.7	2.8	4.0	3.0	4.2	3.0	4.4	2.9
	25.0	3.3	2.7	3.4	2.8	3.7	2.8	3.9	3.0	4.1	3.0	4.4	2.9
	27.5	3.3	2.7	3.4	2.8	3.6	2.8	3.9	3.0	4.1	2.9	4.3	2.9
	30.0	3.2	2.7	3.4	2.8	3.6	2.8	3.8	3.0	4.0	2.9	4.2	2.9
	32.5	3.2	2.7	3.3	2.8	3.5	2.8	3.8	2.9	4.0	2.9	4.2	2.8
	35.0	3.2	2.7	3.3	2.8	3.5	2.7	3.7	2.9	3.9	2.9	4.1	2.8
	37.5	3.2	2.7	3.3	2.8	3.5	2.7	3.7	2.9	3.8	2.9	4.0	2.8
	40.0	3.1	2.6	3.2	2.7	3.4	2.7	3.6	2.9	3.8	2.8	4.0	2.8
43.0	3.1	2.6	3.2	2.7	3.4	2.7	3.5	2.9	3.7	2.8	3.9	2.8	
40	20.0	4.1	3.1	4.3	3.2	4.7	3.2	5.0	3.4	5.3	3.4	5.6	3.3
	22.5	4.1	3.1	4.3	3.2	4.6	3.2	4.9	3.4	5.2	3.3	5.5	3.3
	25.0	4.1	3.1	4.3	3.2	4.6	3.2	4.9	3.4	5.2	3.3	5.5	3.3
	27.5	4.1	3.1	4.2	3.2	4.5	3.2	4.8	3.3	5.1	3.3	5.4	3.2
	30.0	4.0	3.1	4.2	3.2	4.5	3.1	4.8	3.3	5.0	3.3	5.3	3.2
	32.5	4.0	3.0	4.2	3.1	4.4	3.1	4.7	3.3	5.0	3.2	5.2	3.2
	35.0	4.0	3.0	4.1	3.1	4.4	3.1	4.6	3.3	4.9	3.2	5.1	3.1
	37.5	3.9	3.0	4.1	3.1	4.3	3.1	4.6	3.2	4.8	3.2	5.1	3.1
	40.0	3.9	3.0	4.0	3.1	4.3	3.0	4.5	3.2	4.7	3.1	5.0	3.1
43.0	3.9	3.0	4.0	3.1	4.2	3.0	4.4	3.2	4.7	3.1	4.9	3.1	
50	20.0	5.2	3.6	5.4	3.8	5.8	3.8	6.2	3.9	6.6	3.9	7.0	3.8
	22.5	5.2	3.6	5.4	3.7	5.8	3.7	6.2	3.9	6.5	3.9	6.9	3.8
	25.0	5.1	3.6	5.3	3.7	5.7	3.7	6.1	3.9	6.4	3.8	6.8	3.7
	27.5	5.1	3.6	5.3	3.7	5.6	3.7	6.0	3.8	6.3	3.8	6.7	3.7
	30.0	5.0	3.6	5.2	3.7	5.6	3.6	5.9	3.8	6.2	3.7	6.6	3.7
	32.5	5.0	3.5	5.2	3.6	5.5	3.6	5.8	3.8	6.2	3.7	6.5	3.6
	35.0	4.9	3.5	5.1	3.6	5.4	3.6	5.8	3.7	6.1	3.7	6.4	3.6
	37.5	4.9	3.5	5.1	3.6	5.4	3.5	5.7	3.7	6.0	3.6	6.3	3.6
	40.0	4.9	3.5	5.0	3.6	5.3	3.5	5.6	3.7	5.9	3.6	6.2	3.5
43.0	4.8	3.4	5.0	3.5	5.2	3.5	5.5	3.6	5.8	3.6	6.1	3.5	

2-6.Heating Capacity (In combination with Big Y, Super Y, Big R2)

PKFY-P-VAM-A,VGM-A

Unit size	Outdoor air temp. °CWB	Indoor air temp.:°CDB			
		15	21	25	27
		SHC	SHC	SHC	SHC
20	-15.0	1.6	1.5	1.5	1.5
	-10.0	1.8	1.8	1.7	1.7
	-5.0	2.0	2.0	2.0	1.9
	0.0	2.2	2.2	2.1	1.9
	2.5	2.4	2.3	2.1	1.9
	6.0	2.5	2.5	2.1	1.9
	7.5	2.6	2.5	2.1	1.9
	10.0	2.7	2.5	2.1	1.9
	12.5	2.9	2.5	2.1	1.9
	15.5	2.9	2.5	2.1	1.9
25	-15.0	2.0	2.0	1.9	1.9
	-10.0	2.3	2.2	2.2	2.2
	-5.0	2.6	2.5	2.5	2.5
	0.0	2.9	2.8	2.7	2.5
	2.5	3.0	3.0	2.7	2.5
	6.0	3.2	3.2	2.7	2.5
	7.5	3.3	3.2	2.7	2.5
	10.0	3.5	3.2	2.7	2.5
	12.5	3.7	3.2	2.7	2.5
	15.5	3.7	3.2	2.7	2.5
32	-15.0	2.5	2.5	2.4	2.4
	-10.0	2.8	2.8	2.8	2.7
	-5.0	3.2	3.2	3.1	3.1
	0.0	3.6	3.5	3.4	3.1
	2.5	3.8	3.7	3.4	3.1
	6.0	4.0	4.0	3.4	3.1
	7.5	4.2	4.0	3.4	3.1
	10.0	4.4	4.0	3.4	3.1
	12.5	4.6	4.0	3.4	3.1
	15.5	4.6	4.0	3.4	3.1

SHC:Sensible Heat Capacity(kW)

Unit size	Outdoor air temp. °CWB	Indoor air temp.:°CDB			
		15	21	25	27
		SHC	SHC	SHC	SHC
40	-15.0	3.1	3.1	3.0	3.0
	-10.0	3.6	3.5	3.5	3.4
	-5.0	4.0	4.0	3.9	3.9
	0.0	4.5	4.4	4.3	3.9
	2.5	4.7	4.7	4.3	3.9
	6.0	5.0	5.0	4.3	3.9
	7.5	5.2	5.0	4.3	3.9
	10.0	5.4	5.0	4.3	3.9
	12.5	5.7	5.0	4.3	3.9
	15.5	5.8	5.0	4.3	3.9
50	-15.0	3.9	3.9	3.8	3.7
	-10.0	4.5	4.4	4.3	4.3
	-5.0	5.0	5.0	4.9	4.9
	0.0	5.6	5.6	5.4	4.9
	2.5	5.9	5.9	5.4	4.9
	6.0	6.4	6.3	5.4	4.9
	7.5	6.6	6.3	5.4	4.9
	10.0	6.9	6.3	5.4	4.9
	12.5	7.2	6.3	5.4	4.9
	15.5	7.2	6.3	5.4	4.9

2-7.Cooling Capacity (In combination with WY, WR2)

PKFY-P-VAM-A,VGM-A

CA:Capacity(kW)
SHC:Sensible Heat Capacity(kW)

Unit size	Water temp.	Indoor air temp.													
		21.5°CDB 15°CWB		23°CDB 16°CWB		25°CDB 18°CWB		27°CDB 19°CWB		28°CDB 20°CWB		30°CDB 22°CWB		32°CDB 24°CWB	
		°C	CA	SHC	CA	SHC	CA	SHC	CA	SHC	CA	SHC	CA	SHC	CA
20	10	2.1	1.5	2.2	1.6	2.4	1.5	2.4	1.6	2.5	1.6	2.6	1.6	2.8	1.6
	20	2.1	1.5	2.1	1.5	2.3	1.5	2.3	1.5	2.4	1.6	2.5	1.5	2.7	1.5
	30	2.0	1.4	2.0	1.5	2.1	1.4	2.2	1.5	2.3	1.5	2.4	1.5	2.5	1.5
	40	1.7	1.3	1.8	1.3	1.9	1.3	1.9	1.3	2.0	1.4	2.1	1.4	2.2	1.3
	45	1.6	1.2	1.7	1.3	1.8	1.3	1.8	1.3	1.9	1.3	2.0	1.3	2.1	1.3
25	10	2.7	1.9	2.8	2.0	3.0	1.9	3.1	1.9	3.2	2.0	3.3	2.0	3.5	1.9
	20	2.6	1.8	2.7	1.9	2.9	1.9	3.0	1.9	3.1	2.0	3.2	1.9	3.4	1.9
	30	2.5	1.8	2.6	1.8	2.7	1.8	2.8	1.8	2.9	1.9	3.0	1.8	3.2	1.8
	40	2.2	1.6	2.2	1.7	2.4	1.6	2.4	1.7	2.5	1.7	2.6	1.7	2.8	1.7
	45	2.0	1.5	2.1	1.6	2.2	1.6	2.3	1.6	2.4	1.7	2.5	1.6	2.6	1.6
32	10	3.5	2.8	3.6	2.9	3.9	2.9	4.0	2.9	4.1	3.1	4.3	3.0	4.5	3.0
	20	3.4	2.8	3.5	2.9	3.7	2.8	3.8	2.9	3.9	3.0	4.1	3.0	4.4	2.9
	30	3.2	2.7	3.3	2.8	3.5	2.7	3.6	2.8	3.7	2.9	3.9	2.9	4.1	2.8
	40	2.8	2.5	2.9	2.6	3.1	2.6	3.1	2.6	3.2	2.7	3.4	2.7	3.6	2.7
	45	2.6	2.4	2.7	2.5	2.9	2.5	3.0	2.6	3.0	2.7	3.2	2.6	3.4	2.6
40	10	4.4	3.2	4.5	3.3	4.8	3.3	5.0	3.3	5.1	3.5	5.4	3.4	5.7	3.3
	20	4.2	3.1	4.4	3.2	4.6	3.2	4.8	3.3	4.9	3.4	5.2	3.3	5.5	3.3
	30	4.0	3.0	4.1	3.1	4.4	3.1	4.5	3.1	4.6	3.3	4.9	3.2	5.2	3.1
	40	3.5	2.8	3.6	2.9	3.8	2.8	3.9	2.9	4.0	3.0	4.3	3.0	4.5	2.9
	45	3.3	2.7	3.4	2.8	3.6	2.8	3.7	2.8	3.8	2.9	4.0	2.9	4.2	2.8
50	10	5.5	3.8	5.6	3.9	6.0	3.8	6.2	3.9	6.3	4.0	6.7	3.9	7.1	3.9
	20	5.3	3.7	5.4	3.8	5.8	3.7	5.9	3.8	6.1	3.9	6.5	3.8	6.8	3.8
	30	5.0	3.5	5.1	3.6	5.5	3.6	5.6	3.6	5.8	3.7	6.1	3.7	6.4	3.6
	40	4.3	3.2	4.5	3.3	4.7	3.3	4.9	3.3	5.0	3.4	5.3	3.4	5.6	3.3
	45	4.1	3.1	4.2	3.2	4.5	3.1	4.6	3.2	4.7	3.3	5.0	3.2	5.3	3.2

2-8.Heating Capacity (In combination with WY, WR2)

PKFY-P-VAM-A,VGM-A

SHC:Sensible Heat Capacity(kW)

Unit size	Water temp.	Indoor air temp.:°CDB				
		15	19	20	25	27
		°C	SHC(kW)	SHC(kW)	SHC(kW)	SHC(kW)
20	10	2.2	2.2	2.1	1.7	1.5
	20	2.6	2.6	2.5	2.0	1.8
	30	2.6	2.6	2.5	2.0	1.8
	40	2.7	2.7	2.6	2.1	1.9
	45	2.9	2.9	2.9	2.3	2.1
25	10	2.8	2.8	2.7	2.2	2.0
	20	3.3	3.3	3.2	2.6	2.3
	30	3.3	3.3	3.2	2.6	2.3
	40	3.4	3.4	3.3	2.7	2.4
	45	3.8	3.7	3.6	2.9	2.6
32	10	3.5	3.5	3.4	2.7	2.4
	20	4.1	4.1	4.0	3.2	2.9
	30	4.1	4.1	4.0	3.2	2.9
	40	4.3	4.2	4.2	3.3	3.0
	45	4.7	4.7	4.6	3.6	3.3
40	10	4.4	4.3	4.3	3.4	3.1
	20	5.2	5.1	5.0	4.0	3.6
	30	5.2	5.1	5.0	4.0	3.6
	40	5.4	5.3	5.2	4.2	3.7
	45	5.9	5.8	5.7	4.6	4.1
50	10	5.5	5.5	5.4	4.3	3.9
	20	6.5	6.4	6.3	5.0	4.5
	30	6.5	6.4	6.3	5.0	4.5
	40	6.7	6.7	6.6	5.2	4.7
	45	7.4	7.3	7.2	5.7	5.2

3. Sound Levels

PKFY-P-VAM-A/VGM-A

3-1. Noise level

Wall mounted

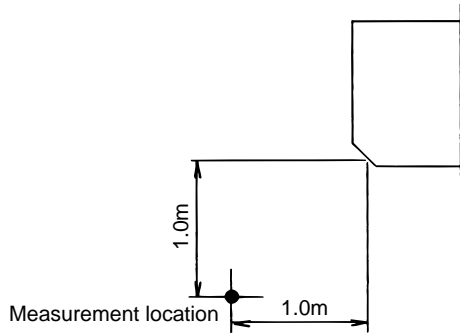

Noise level at anechoic room
(Low-Middle2-Middle1-High)

Unit : dB(A)

Model	Noise level (A weighted)
PKFY-P20VAM-A PKFY-P25VAM-A	32-33-35-36
PKFY-P32VGM-A PKFY-P40VGM-A	33-36-38-41
PKFY-P50VGM-A	34-37-40-43

3-2. NC curves

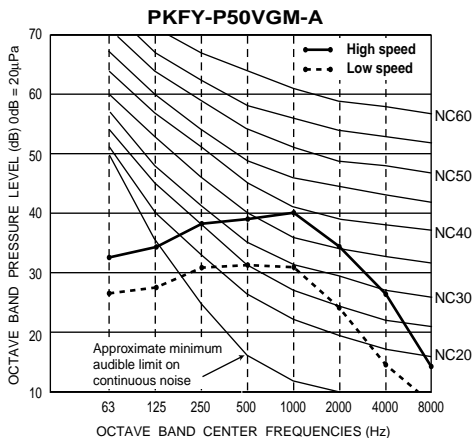
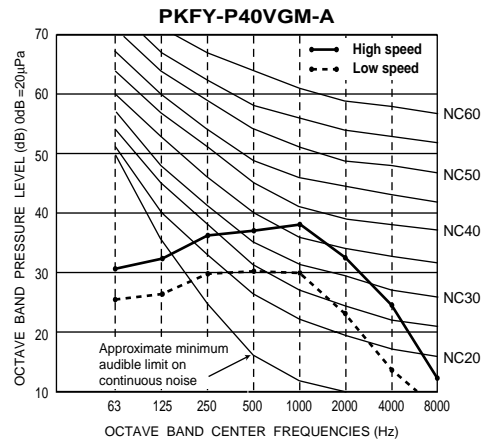
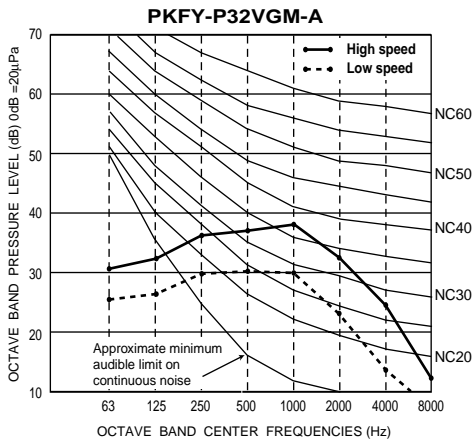
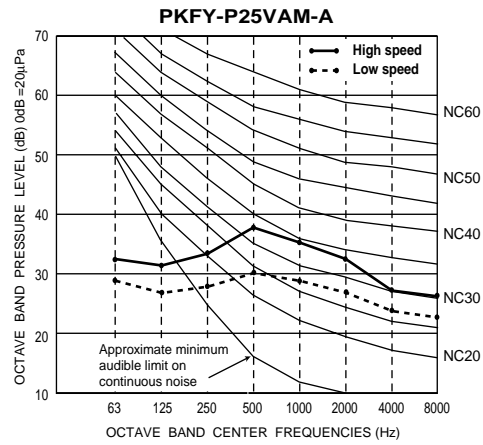
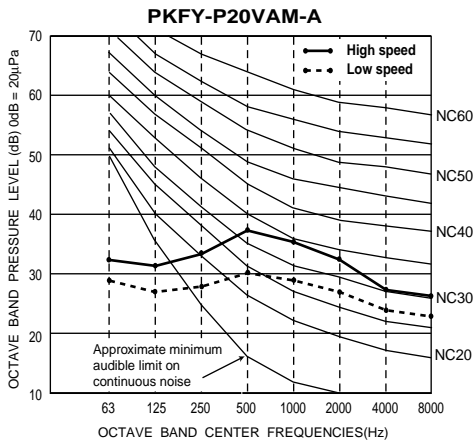

4. External Dimensions

PKFY-P20, 25VAM-A

Unit : mm

Liquid pipe	φ6.35
Gas pipe	φ12.7

The address board is protected by a plastic cover.
Remove the cover with a screwdriver (one screw) to set the board.

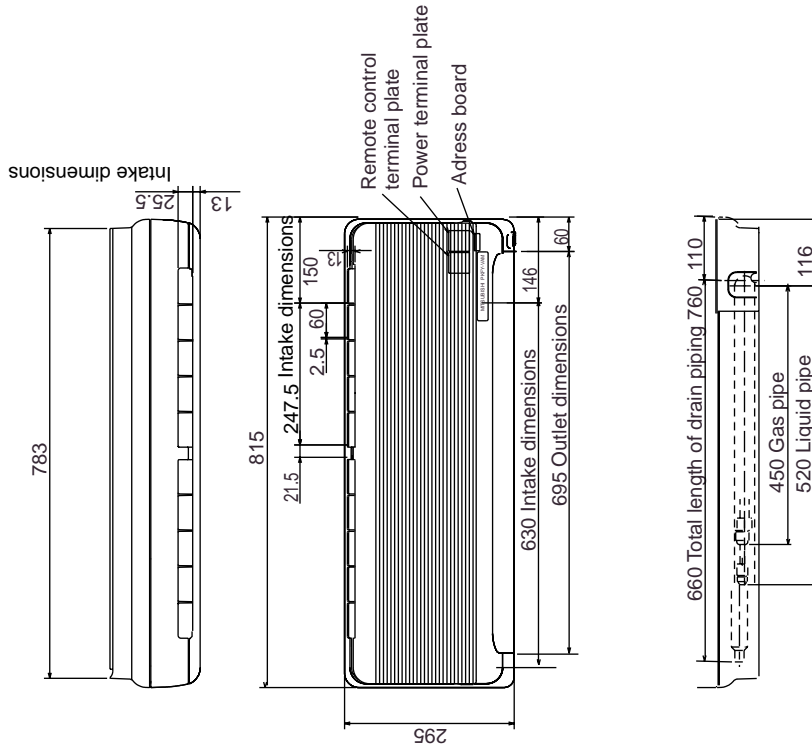
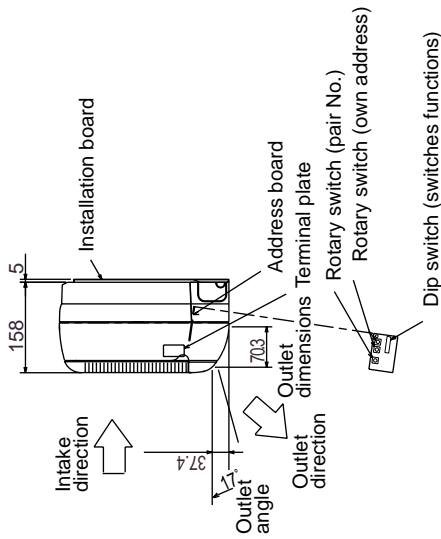

PKFY-P32,40,50VGM-A

Unit : mm

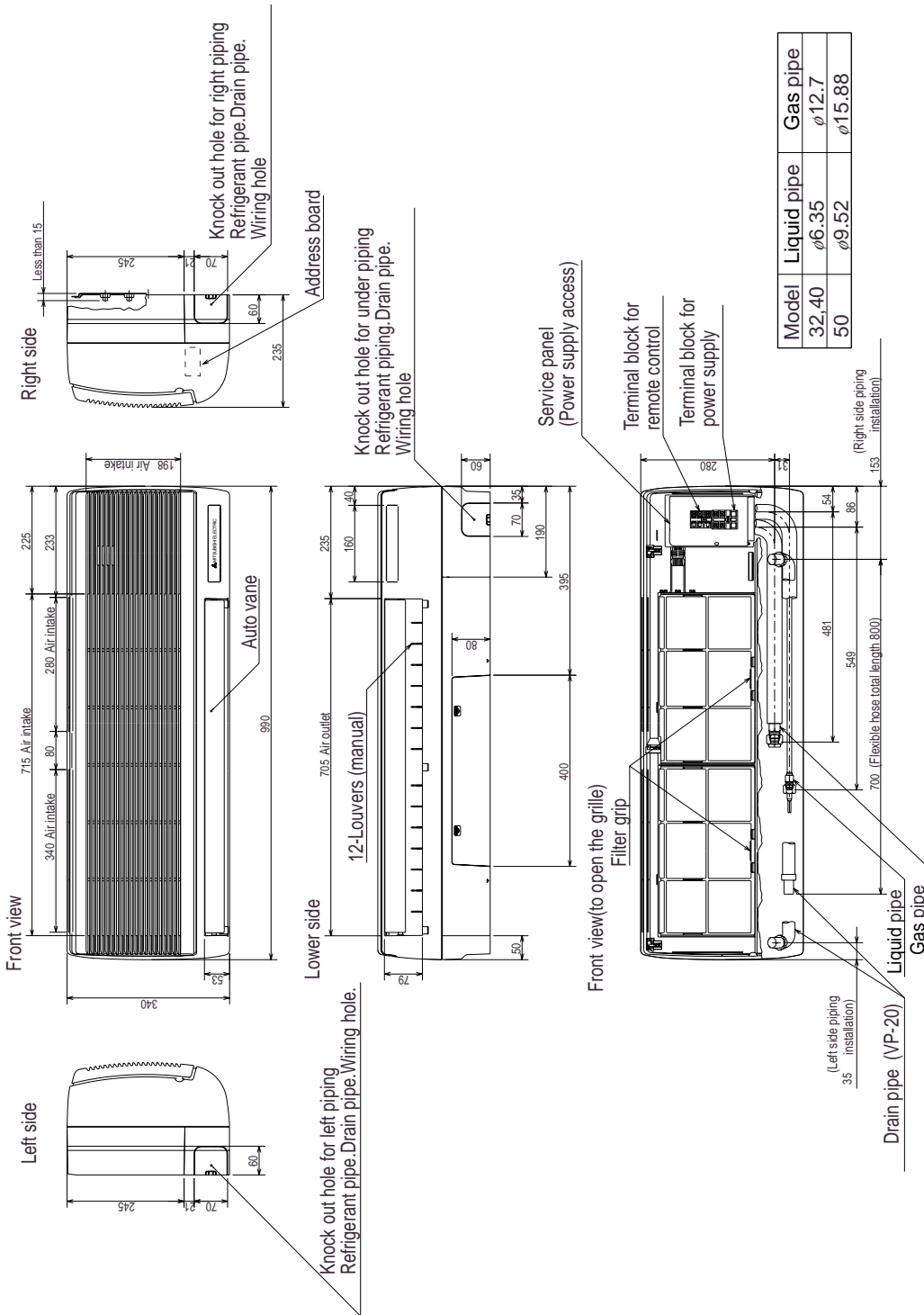

Model	Liquid pipe	Gas pipe
32,40	φ6.35	φ12.7
50	φ9.52	φ15.88

5. Electrical Wiring Diagrams

5-1 PKFY-P-VAM-A

<SYMBOL EXPLANATION>

Symbol	Name	Symbol	Name	Symbol	Name	
M.B	Indoor controller board	TH23	Thermistor Pipe temp. detection/Gas (0°C / 15kΩ, 25°C / 5.4kΩ)	TB2	Terminal block Power supply	
CN32	Connector	P.B	Indoor power board	TB5	Terminal block MA-Remote controller	
CN41		ZNR	Varistor	A.B	Circuit board Address	
CN51		FUSE	Fuse (6.3A)	SW1 <A.B>	Switch	Mode selection
CN52		F.C	Fan phase control	SW5 <A.B>		Voltage selection
SW2		MF	Fan motor	SW11 <A.B>		Address setting 1st digit
SW3	C1	Capacity (fan motor)	SW12 <A.B>	Address setting 2nd digit		
TH21	Thermistor	MV	Vane motor	SW14 <A.B>	Connection No.	
TH22		LEV	Linear expansion valve			

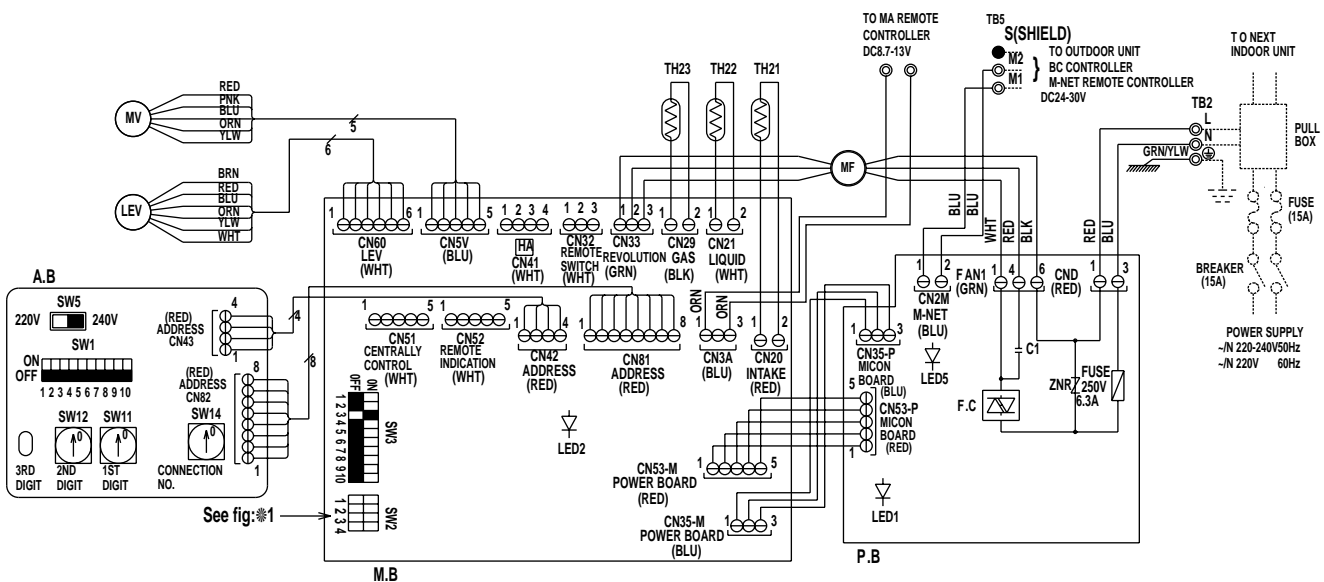

Note

- At servicing for outdoor unit, always follow the wiring diagram of outdoor unit.
- In case of using MA-Remote controller, please connect to TB15.(Remote controller wire is non-polar.)
- In case of using M-NET, please connect to the wire.(BLU, two wire) <M1, M2>of CN2M (Transmission line is non-polar.)
- Symbols used in wiring diagram above are, ⊙ : terminal block, ⊖ : connector, ● : direct wire connection.
- The setting of the SW2 dip switches differs in the capacity for the detail, refer to the fig: ※1.
- Please set the switch SW5 accordingly to the power supply voltage.
SW5 to 240V side when the power supply is 230 and 240 volts.
When the power supply is 220 volts, set SW5 to 220V side.

Led on indoor board for service

Mark	Meaning	Function
LED1	Main power supply	Main power supply (indoor unit:220-240V) power on ⇒ lamp is lit
LED2	Power supply for MA-Remote controller	Power supply for MA-Remote controller on → lamp is lit

<※ 1>

MODELS	SW2	MODELS	SW2
PKFY-P20VAM	ON OFF	PKFY-P25VAM	ON OFF

5-2 PKFY-P-VGM-A

<SYMBOL EXPLANATION>

Symbol	Name	Symbol	Name	Symbol	Name
I.B	Indoor controller board	TH21	Room temp. detection (0°C/15kΩ, 25°C/5.4kΩ)	A.B	Circuit board
CN32	Connector	TH22	Pipe temp. detection/liquid (0°C/15kΩ, 25°C/5.4kΩ)	SW1	Mode selection
CN41	Remote switch	TH23	Pipe temp. detection/Gas (0°C/15kΩ, 25°C/5.4kΩ)	SW5	Voltage selection
CN51	HA terminal-A			SW11	Address setting 1st digit
CN52	Centrally control			SW12	Address setting 2nd digit
SW2	Capacity code			SW14	Connection No.
SW3	Mode selection	MF	Fan motor (with inner thermostat)	SWC	Option selector
SW4	Model selection	C1	Capacitor (fan motor)	P.B	Indoor power board
ZNR	Varistor	MV	Vane motor		
X4	Aux.Relay (Fan motor)	TB2	Power supply		
FUSE	Fuse (6.3A)	TB5	Transmission		
F.C	Fan phase control	TB15	MA-Remote controller		
		LEV	Linear expansion valve		

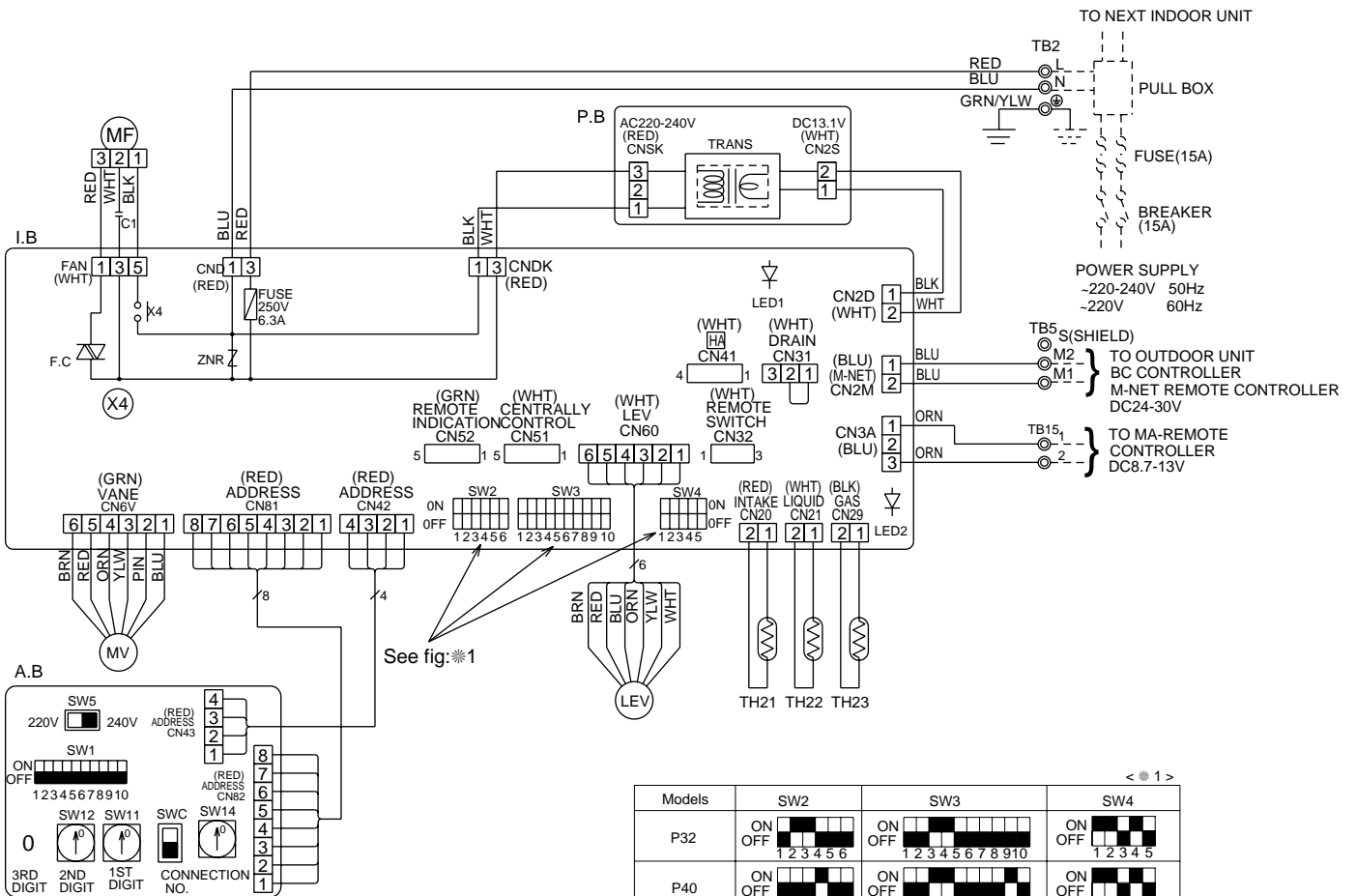

NOTE

- At servicing for outdoor unit, always follow the wiring diagram of outdoor unit.
- In case of using MA-Remote controller, please connect to TB15.
(Remote controller wire is non-polar.)
- In case of using M-NET, please connect to TB5. (Transmission line is non-polar.)
- Symbol[S] of TB5 is the shield wire connection.
- Symbols used in wiring diagram above are,
○: Terminal block, □: Connector.
- The setting of the SW2 dip switches differs in the capacity. For the detail, refer to the fig: ※1.
- Please set the switch SW5 according to the power supply voltage.
Set SW5 to 240V side when the power supply is 230 and 240 volts.
When the power supply is 220 volts, set SW5 to 220V side.

< ※ 1 >

Models	SW2	SW3	SW4
P32	ON OFF 1 2 3 4 5 6	ON OFF 1 2 3 4 5 6 7 8 9 10	ON OFF 1 2 3 4 5
P40	ON OFF 1 2 3 4 5 6	ON OFF 1 2 3 4 5 6 7 8 9 10	ON OFF 1 2 3 4 5
P50	ON OFF 1 2 3 4 5 6	ON OFF 1 2 3 4 5 6 7 8 9 10	ON OFF 1 2 3 4 5

Led on indoor board for sevice

Mark	Meaning	Function
LED1	Main power supply	Main power supply (indoor unit: 220-240V) power on → lamp is lit
LED2	Power supply for MA-Remote controller	Power supply for MA-Remote controller on → lamp is lit

6. Temperature/Airflow distribution

6-1 PKFY-P-VAM-A

● Temperature distribution

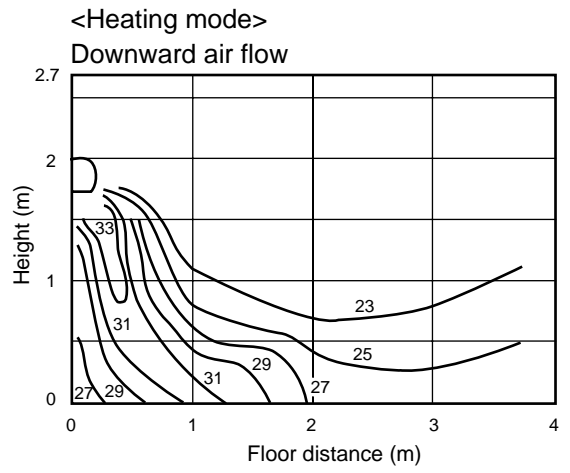
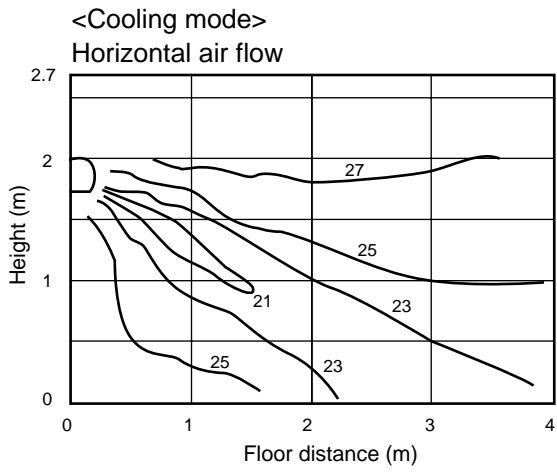

● Airflow distribution

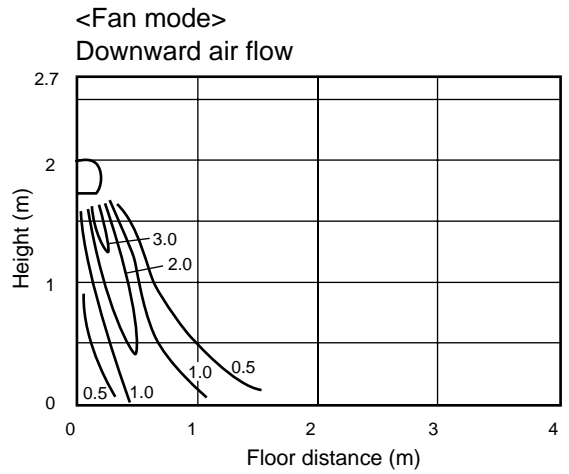
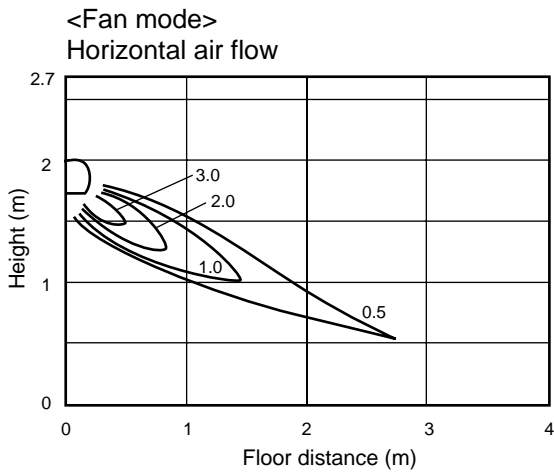

6-2 PKFY-P-VGM-A

● Temperature distribution

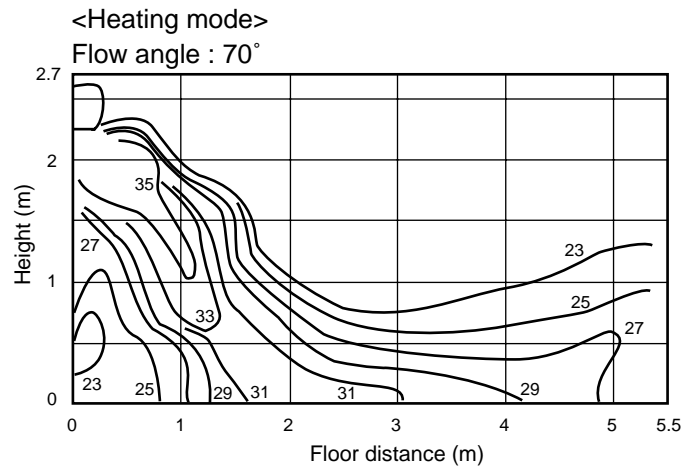
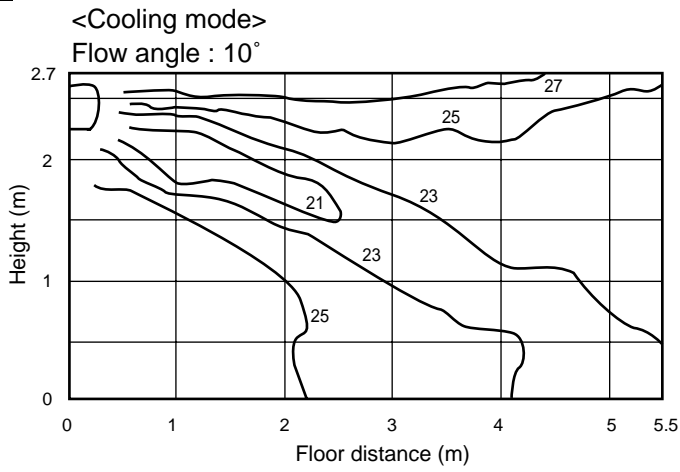

● Airflow distribution

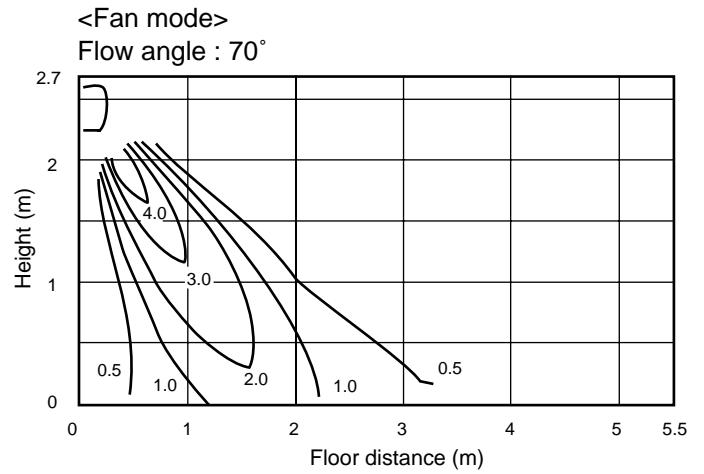
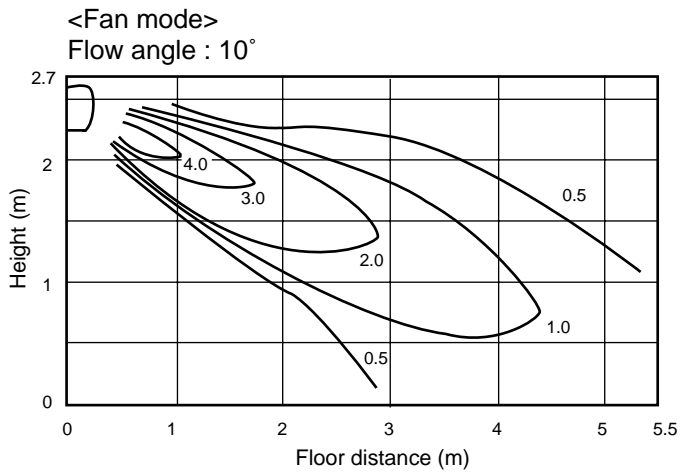

CONTENTS

1. Specifications II -186

2. Capacity Tables II -187

 2-1 Cooling Capacity(PUMY) II -187

 2-2 Heating Capacity(PUMY) II -187

 2-3 Cooling Capacity(Y/R2-8-10-13HP) II -188

 2-4 Heating Capacity(Y/R2-8-10-13HP) II -188

 2-5 Cooling Capacity(Big Y, Super Y, Big R2) II -189

 2-6 Heating Capacity(Big Y, Super Y, Big R2) II -189

 2-7 Cooling Capacity(WY, WR2) II -190

 2-8 Heating Capacity(WY, WR2) II -190

3. Sound Levels II -191

 3-1 Noise levels II -191

 3-2 N/C curves II -191

4. External Dimensions II -192

5. Electrical Wiring Diagrams II -194

 5-1 PKFY-P-VFM-A II -194

1. Specifications

PKFY(NOP-CE)

			PKFY-P63VFM-A	PKFY-P100VFM-A
Power source			~ 220-240V 50Hz / ~ 220V 60Hz	
Cooling capacity	*1	kW	7.1	11.2
	*2	kcal/h	6,300	10,000
Heating capacity		*1 kW	8.0	12.5
Power consumption	Cooling	kW	0.11-0.12	0.13-0.14
	Heating	kW	0.11-0.12	0.13-0.14
Current	Cooling	A	0.54-0.55	0.63-0.64
	Heating	A	0.54-0.55	0.63-0.64
External finish(Munsel No.)			Plastic, white : <3.4Y7.7/0.8>	
Dimension	Height	mm	340	
	Width	mm	1,400	1,680
	Depth	mm	235	
Net weight		kg	24	28
Heat exchanger			Cross fin (Aluminum plate fin and copper tube)	
Fan	Type		Line flow fan X 2	
	Airflow rate (Lo-Hi)	*3 m ³ /min	15-20	22-28
	External static pressure		Pa	0
Motor	Type		Single phase induction motor	
	Output		kW	0.04
Air filter			PP Honeycomb fabric	
Refrigerant pipe dimension	Gas (Flare)	mm	ø 15.88	ø 19.05
	Liquid (Flare)	mm	ø 9.52	
Drain pipe dimension			VP-20	
Noise level (Lo-Hi)		*3 *4 dB(A)	39-45	41-46

- Note: *1 Cooling/Heating capacity indicates the maximum value at operation under the following condition.
Cooling : Indoor 27°CDB/19°CWB, Outdoor 35°CDB
Heating : Indoor 20°CDB, Outdoor 7°CDB/6°CWB
*2 Cooling capacity indicates the maximum value at operation under the following condition.
Cooling : Indoor 27°CDB/19.5°CWB, Outdoor 35°CDB (WR2: water 30°C)
*3 Airflow rate/noise level are in (low-high).
*4 It is measured in anechoic room.

2. Capacity Table

2-1. Cooling Capacity (In combination with PUMY)

PKFY-P-VFM-A

CA:Capacity(kW)

SHC:Sensible Heat Capacity(kW)

Unit size	Outdoor air temp.	Indoor air temp.							
		23°CDB 16°CWB		25°CDB 18°CWB		28°CDB 20°CWB		30°CDB 22°CWB	
		°CDB	CA	SHC	CA	SHC	CA	SHC	CA
63 (7.1)	20.0	7.0	5.3	7.4	5.6	7.9	5.5	8.3	5.7
	22.5	6.9	5.3	7.3	5.5	7.8	5.5	8.2	5.7
	25.0	6.9	5.2	7.3	5.5	7.7	5.5	8.2	5.6
	27.5	6.8	5.2	7.2	5.5	7.7	5.4	8.1	5.6
	30.0	6.7	5.2	7.1	5.4	7.5	5.4	8.0	5.6
	32.5	6.6	5.1	7.0	5.4	7.5	5.3	7.9	5.5
	35.0	6.5	5.1	6.9	5.3	7.3	5.3	7.8	5.5
	37.5	6.4	5.0	6.8	5.3	7.2	5.2	7.7	5.4
	40.0	6.3	5.0	6.7	5.3	7.2	5.2	7.6	5.4
46.0	6.1	4.9	6.5	5.1	6.9	5.1	7.3	5.3	
100 (11.2)	20.0	11.1	8.0	11.6	8.3	12.5	8.3	13.1	8.5
	22.5	10.9	7.9	11.5	8.3	12.3	8.2	13.0	8.4
	25.0	10.8	7.9	11.5	8.2	12.2	8.2	12.9	8.4
	27.5	10.7	7.8	11.3	8.2	12.1	8.1	12.8	8.3
	30.0	10.5	7.7	11.2	8.1	11.9	8.0	12.6	8.3
	32.5	10.4	7.6	11.1	8.0	11.8	8.0	12.5	8.2
	35.0	10.2	7.6	10.9	8.0	11.6	7.9	12.3	8.1
	37.5	10.1	7.5	10.8	7.9	11.4	7.8	12.2	8.1
	40.0	10.0	7.4	10.6	7.8	11.3	7.7	12.0	8.0
46.0	9.6	7.2	10.2	7.6	10.8	7.5	11.5	7.8	

PKFY(NON-GE)

2-2. Heating Capacity (In combination with PUMY)

PKFY-P-VFM-A

SHC:Sensible Heat Capacity(kW)

Unit size	Outdoor air temp.	Indoor air temp.:°CDB		
		15.0	20.0	25.0
		°CWB	SHC	SHC
63	-12.0	5.1	5.0	4.9
	-10.0	5.4	5.3	5.2
	-5.0	6.1	6.0	5.9
	0.0	6.9	6.9	6.8
	2.5	7.4	7.3	7.2
	6.0	8.0	8.0	7.9
	7.5	8.3	8.3	7.9
	10.0	8.8	8.8	7.9
	12.5	9.4	8.8	7.9
	15.5	9.8	8.8	7.9

Unit size	Outdoor air temp.	Indoor air temp.:°CDB		
		15.0	20.0	25.0
		°CWB	SHC	SHC
100	-12.0	8.0	7.8	7.7
	-10.0	8.4	8.2	8.1
	-5.0	9.6	9.4	9.3
	0.0	10.9	10.7	10.6
	2.5	11.5	11.4	11.3
	6.0	12.6	12.5	12.3
	7.5	13.0	12.9	12.4
	10.0	13.8	13.7	12.4
	12.5	14.6	13.8	12.4
	15.5	15.4	13.8	12.4

2-3.Cooling Capacity (In combination with PU(H)Y, PURY-(P)200-250-315YEM-A, TEM-A)

CA:Capacity(kW)
SHC:Sensible Heat Capacity(kW)

PKFY-P-VFM-A

Unit size	Outdoor air temp.	Indoor air temp.													
		21.5°CDB 15°CWB		23°CDB 16°CWB		25°CDB 18°CWB		27°CDB 19°CWB		28°CDB 20°CWB		30°CDB 22°CWB		32°CDB 24°CWB	
		°CDB	CA	SHC	CA	SHC	CA	SHC	CA	SHC	CA	SHC	CA	SHC	CA
63 (7.1)	20.0	7.0	5.3	7.1	5.4	7.4	5.3	7.5	5.4	7.7	5.5	8.0	5.4	8.2	5.2
	22.5	6.9	5.3	7.0	5.4	7.3	5.3	7.5	5.3	7.6	5.5	7.9	5.4	8.2	5.2
	25.0	6.8	5.2	7.0	5.4	7.2	5.2	7.4	5.3	7.5	5.5	7.8	5.3	8.1	5.2
	27.5	6.7	5.2	6.9	5.3	7.2	5.2	7.3	5.3	7.5	5.4	7.7	5.3	8.0	5.2
	30.0	6.7	5.2	6.8	5.3	7.1	5.2	7.2	5.2	7.4	5.4	7.7	5.3	8.0	5.1
	32.5	6.6	5.1	6.7	5.3	7.0	5.1	7.2	5.2	7.3	5.4	7.6	5.3	7.9	5.1
	35.0	6.5	5.1	6.7	5.2	7.0	5.1	7.1	5.2	7.2	5.4	7.5	5.2	7.8	5.1
	37.5	6.5	5.1	6.6	5.2	6.9	5.1	7.0	5.2	7.2	5.3	7.5	5.2	7.7	5.1
	40.0	6.4	5.0	6.5	5.2	6.8	5.1	7.0	5.1	7.1	5.3	7.4	5.2	7.7	5.1
43.0	6.3	5.0	6.4	5.1	6.7	5.0	6.9	5.1	7.0	5.3	7.3	5.1	7.6	5.0	
100 (11.2)	20.0	11.0	7.9	11.2	8.1	11.6	7.9	11.9	8.0	12.1	8.2	12.5	8.0	13.0	7.7
	22.5	10.9	7.9	11.1	8.0	11.5	7.9	11.8	7.9	12.0	8.1	12.4	7.9	12.9	7.7
	25.0	10.8	7.8	11.0	8.0	11.4	7.8	11.6	7.9	11.9	8.1	12.3	7.9	12.8	7.7
	27.5	10.6	7.8	10.9	7.9	11.3	7.8	11.5	7.8	11.8	8.0	12.2	7.8	12.7	7.6
	30.0	10.5	7.7	10.8	7.9	11.2	7.7	11.4	7.8	11.6	8.0	12.1	7.8	12.5	7.6
	32.5	10.4	7.7	10.6	7.8	11.1	7.7	11.3	7.7	11.5	8.0	12.0	7.8	12.4	7.5
	35.0	10.3	7.6	10.5	7.8	11.0	7.6	11.2	7.7	11.4	7.9	11.9	7.7	12.3	7.5
	37.5	10.2	7.5	10.4	7.7	10.9	7.6	11.1	7.6	11.3	7.9	11.8	7.7	12.2	7.5
	40.0	10.1	7.5	10.3	7.7	10.8	7.5	11.0	7.6	11.2	7.8	11.6	7.6	12.1	7.4
43.0	9.9	7.4	10.2	7.6	10.6	7.4	10.8	7.5	11.1	7.8	11.5	7.6	12.0	7.4	

PKFY(NON-CE)

2-4.Heating Capacity (In combination with PU(H)Y, PURY-(P)200-250-315YEM-A, TEM-A)

PKFY-P-VFM-A

SHC:Sensible Heat Capacity(kW)

Unit size	Outdoor air temp.	Indoor air temp.:°CDB			
		15.0	20.0	25.0	27.0
		°CWB	SHC	SHC	SHC
63	-15.0	5.4	5.3	5.2	5.2
	-10.0	6.1	6.0	6.0	5.5
	-5.0	6.9	6.8	6.2	5.5
	0.0	7.6	7.5	6.2	5.5
	2.5	8.0	7.9	6.2	5.5
	6.0	8.1	8.0	6.2	5.5
	7.5	8.4	8.0	6.2	5.5
	10.0	9.0	8.0	6.2	5.5
	12.5	9.6	8.0	6.2	5.5
	15.5	9.7	8.0	6.2	5.5

Unit size	Outdoor air temp.	Indoor air temp.:°CDB			
		15.0	20.0	25.0	27.0
		°CWB	SHC	SHC	SHC
100	-15.0	8.4	8.2	8.2	8.1
	-10.0	9.6	9.4	9.3	8.6
	-5.0	10.7	10.6	9.8	8.6
	0.0	11.9	11.8	9.8	8.6
	2.5	12.5	12.4	9.8	8.6
	6.0	12.6	12.5	9.8	8.6
	7.5	13.2	12.5	9.8	8.6
	10.0	14.1	12.5	9.8	8.6
	12.5	15.0	12.5	9.8	8.6
	15.5	15.1	12.5	9.8	8.6

2-5.Cooling Capacity (In combination with Big Y, Super Y, Big R2)

PKFY-P-VFM-A

CA:Capacity(kW)
SHC:Sensible Heat Capacity(kW)

Unit size	Outdoor air temp.	Indoor air temp.											
		21.5°CDB 15°CWB		23°CDB 16°CWB		25°CDB 18°CWB		28°CDB 20°CWB		30°CDB 22°CWB		32°CDB 24°CWB	
		°CDB	CA	SHC	CA	SHC	CA	SHC	CA	SHC	CA	SHC	CA
63	20.0	6.5	5.1	6.9	5.3	7.4	5.3	7.9	5.6	8.4	5.5	8.9	5.5
	22.5	6.5	5.1	6.8	5.3	7.3	5.3	7.8	5.6	8.3	5.5	8.7	5.4
	25.0	6.5	5.1	6.8	5.3	7.2	5.2	7.7	5.5	8.1	5.5	8.6	5.4
	27.5	6.4	5.0	6.7	5.2	7.2	5.2	7.6	5.5	8.0	5.4	8.5	5.3
	30.0	6.4	5.0	6.6	5.2	7.1	5.2	7.5	5.5	7.9	5.4	8.4	5.3
	32.5	6.3	5.0	6.6	5.2	7.0	5.1	7.4	5.4	7.8	5.3	8.2	5.2
	35.0	6.3	5.0	6.5	5.1	6.9	5.1	7.3	5.4	7.7	5.3	8.1	5.2
	37.5	6.2	4.9	6.4	5.1	6.8	5.1	7.2	5.3	7.6	5.3	8.0	5.2
	40.0	6.2	4.9	6.4	5.1	6.7	5.0	7.1	5.3	7.5	5.2	7.9	5.1
	43.0	6.1	4.9	6.3	5.0	6.6	5.0	7.0	5.3	7.3	5.2	7.7	5.1
100	20.0	10.3	7.6	10.8	7.9	11.6	7.9	12.5	8.4	13.2	8.2	14.0	8.1
	22.5	10.3	7.6	10.8	7.9	11.5	7.9	12.3	8.3	13.0	8.2	13.8	8.0
	25.0	10.2	7.6	10.7	7.8	11.4	7.8	12.1	8.2	12.8	8.1	13.6	8.0
	27.5	10.1	7.5	10.6	7.8	11.3	7.7	12.0	8.2	12.7	8.0	13.4	7.9
	30.0	10.1	7.5	10.5	7.7	11.2	7.7	11.8	8.1	12.5	8.0	13.2	7.8
	32.5	10.0	7.4	10.3	7.7	11.0	7.6	11.7	8.0	12.3	7.9	13.0	7.7
	35.0	9.9	7.4	10.2	7.6	10.9	7.6	11.5	8.0	12.1	7.8	12.8	7.7
	37.5	9.8	7.4	10.1	7.6	10.8	7.5	11.4	7.9	12.0	7.8	12.6	7.6
	40.0	9.7	7.3	10.0	7.5	10.6	7.5	11.2	7.8	11.8	7.7	12.4	7.5
	43.0	9.6	7.3	9.9	7.5	10.5	7.4	11.0	7.7	11.6	7.6	12.2	7.4

PKFY(NOT-GE)

2-6.Heating Capacity (In combination with Big Y, Super Y, Big R2)

PKFY-P-VFM-A

SHC:Sensible Heat Capacity(kW)

Unit size	Outdoor air temp.	Indoor air temp.:°CDB			
		15	21	25	27
		°CWB	SHC	SHC	SHC
40	-15.0	3.1	3.1	3.0	3.0
	-10.0	3.6	3.5	3.5	3.4
	-5.0	4.0	4.0	3.9	3.9
	0.0	4.5	4.4	4.3	3.9
	2.5	4.7	4.7	4.3	3.9
	6.0	5.0	5.0	4.3	3.9
	7.5	5.2	5.0	4.3	3.9
	10.0	5.4	5.0	4.3	3.9
	12.5	5.7	5.0	4.3	3.9
	15.5	5.8	5.0	4.3	3.9

Unit size	Outdoor air temp.	Indoor air temp.:°CDB			
		15	21	25	27
		°CWB	SHC	SHC	SHC
100	-15.0	7.8	7.7	7.5	7.4
	-10.0	8.9	8.8	8.6	8.5
	-5.0	10.0	9.9	9.8	9.6
	0.0	11.2	11.0	10.6	9.6
	2.5	11.8	11.6	10.6	9.6
	6.0	12.6	12.5	10.6	9.6
	7.5	13.0	12.5	10.6	9.6
	10.0	13.6	12.5	10.6	9.6
	12.5	14.3	12.5	10.6	9.6
	15.5	14.4	12.5	10.6	9.6

2-7.Cooling Capacity (In combination with WY, WR2)

CA:Capacity(kW)
SHC:Sensible Heat Capacity(kW)

PKFY-P-VFM-A

Unit size	Water temp. °C	Indoor air temp.													
		21.5°CDB 15°CWB		23°CDB 16°CWB		25°CDB 18°CWB		27°CDB 19°CWB		28°CDB 20°CWB		30°CDB 22°CWB		32°CDB 24°CWB	
		CA	SHC	CA	SHC	CA	SHC	CA	SHC	CA	SHC	CA	SHC	CA	SHC
63	10	6.9	5.3	7.2	5.5	7.6	5.4	7.8	5.5	8.0	5.7	8.5	5.6	9.0	5.5
	20	6.7	5.2	6.9	5.3	7.3	5.3	7.5	5.4	7.8	5.6	8.2	5.5	8.6	5.4
	30	6.3	5.0	6.5	5.1	6.9	5.1	7.1	5.2	7.3	5.4	7.7	5.3	8.1	5.2
	40	5.5	4.6	5.7	4.8	6.0	4.7	6.2	4.8	6.4	5.0	6.7	4.9	7.1	4.9
	45	5.2	4.5	5.3	4.6	5.7	4.6	5.8	4.7	6.0	4.9	6.3	4.8	6.7	4.7
100	10	10.9	7.9	11.3	8.2	12.0	8.1	12.3	8.2	12.7	8.5	13.4	8.3	14.1	8.2
	20	10.5	7.7	10.9	7.9	11.6	7.9	11.9	8.0	12.2	8.3	12.9	8.1	13.6	8.0
	30	9.9	7.4	10.3	7.6	10.9	7.6	11.2	7.7	11.5	8.0	12.2	7.8	12.8	7.7
	40	8.6	6.8	8.9	7.0	9.5	7.0	9.7	7.1	10.0	7.3	10.6	7.2	11.2	7.1
	45	8.1	6.6	8.4	6.8	8.9	6.7	9.2	6.8	9.5	7.1	10.0	7.0	10.5	6.9

PKFY(NON-CE)

2-8.Heatling Capacity (In combination with WY, WR2)

SHC:Sensible Heat Capacity(kW)

PKFY-P-VFM-A

Unit size	Water temp. °C	Indoor air temp.:°CDB				
		15	19	20	25	27
		SHC	SHC	SHC	SHC	SHC
63	10	7.0	6.9	6.8	5.4	4.9
	20	8.2	8.2	8.0	6.4	5.8
	30	8.2	8.2	8.0	6.4	5.8
	40	8.6	8.5	8.3	6.7	6.0
	45	9.4	9.3	9.1	7.3	6.6
100	10	10.9	10.8	10.6	8.5	7.7
	20	12.9	12.8	12.5	10.0	9.0
	30	12.9	12.8	12.5	10.0	9.0
	40	13.4	13.3	13.0	10.4	9.4
	45	14.7	14.5	14.3	11.4	10.3

3. Sound Levels

3-1. Noise level

Wall mounted

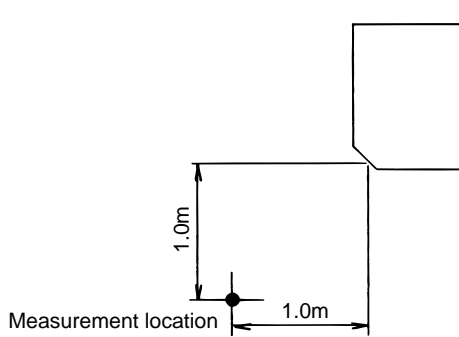

Noise level at anechoic room
(Low-Middle2-Middle1-High)

Unit : dB(A)

Model	Noise level (A weighted)
PKFY-P63VFM-A	39-45 (Low-High)
PKFY-P100VFM-A	41-46 (Low-High)

PKFY(NON-GE)

3-2. NC curves

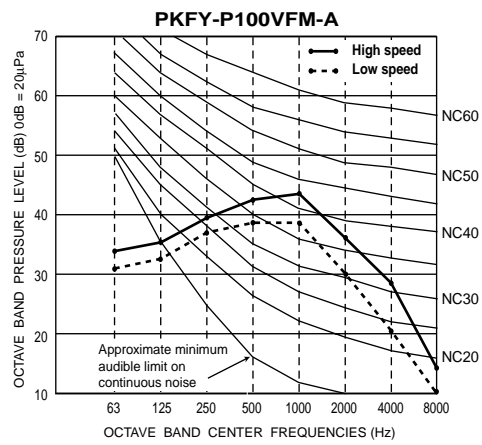
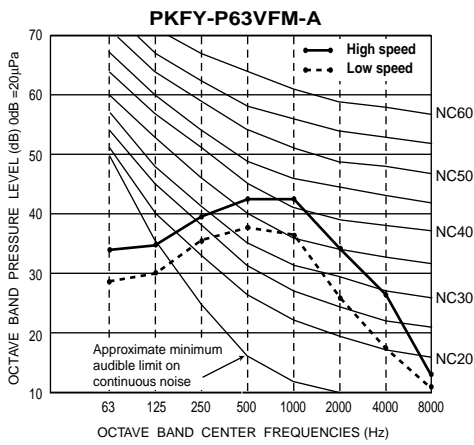

4. External Dimensions

PKFY(NON-CE)

PKFY-P63VFM-A

Unit : mm

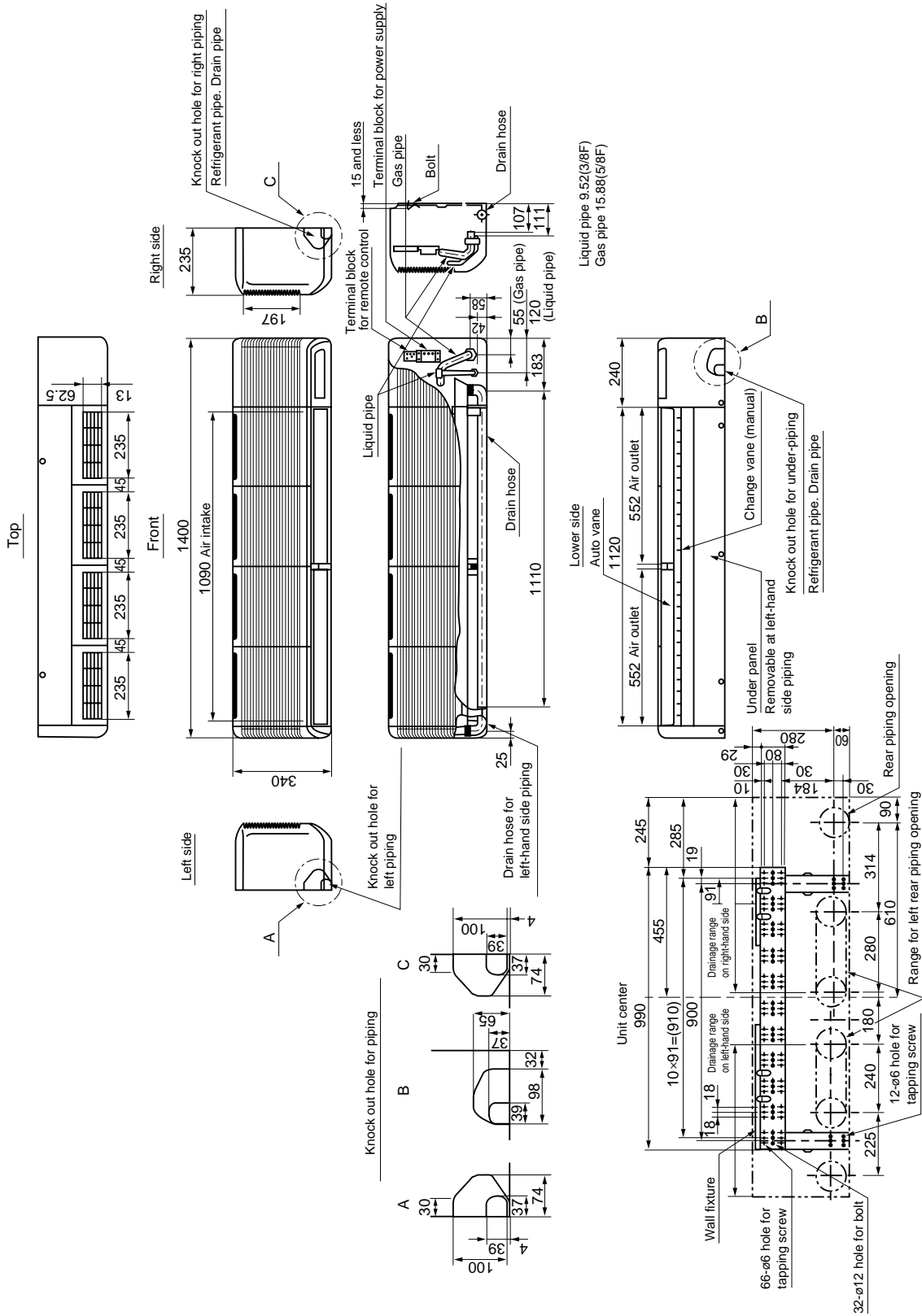

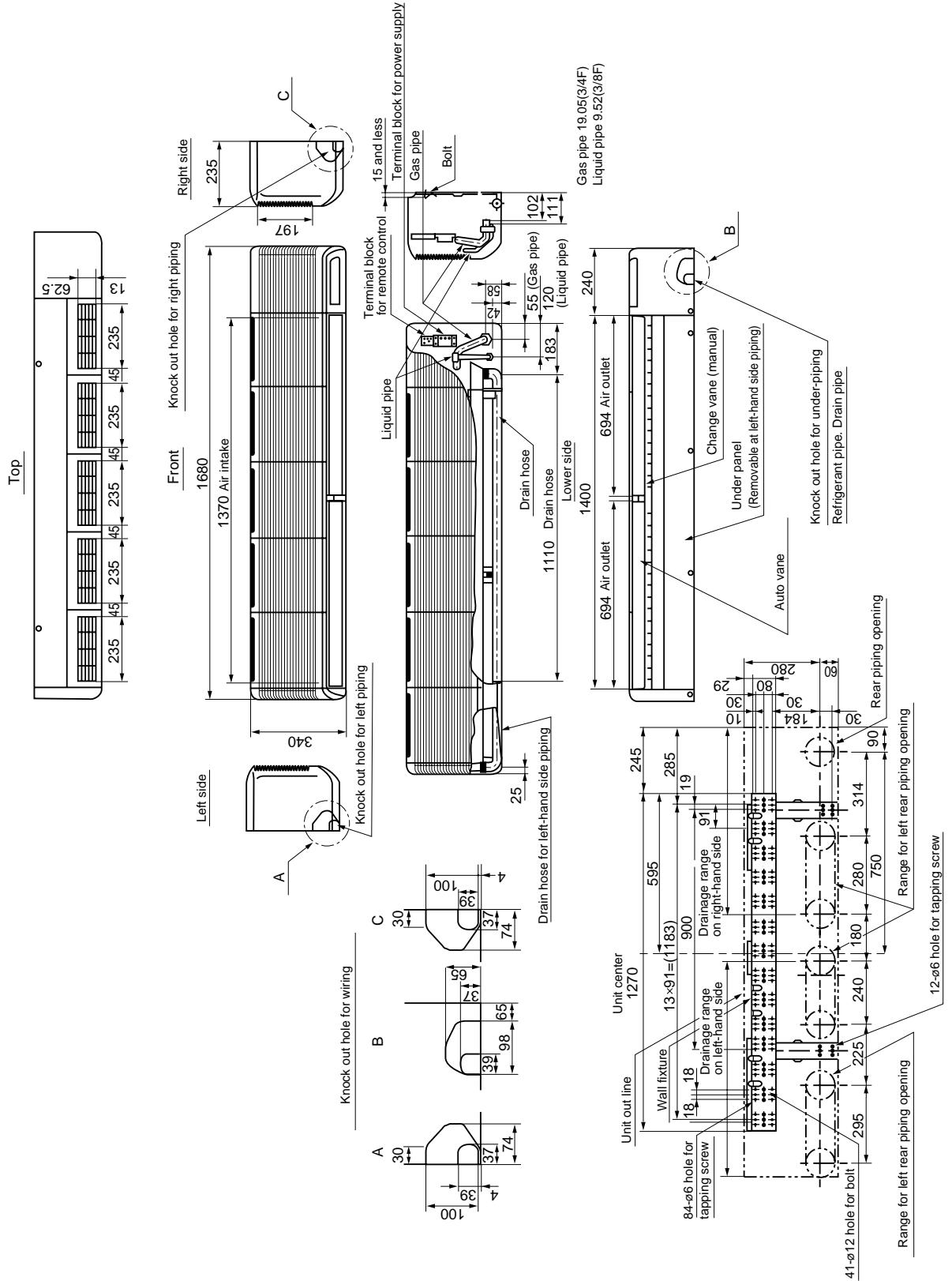

5. Electrical Wiring Diagram

5-1 PKFY-P-VFM-A

<SYMBOL EXPLANATION>

Symbol	Name	Symbol	Name	Symbol	Name	
I.B	Indoor controller board	TH21	Room temp. detection (0°C/15kΩ, 25°C/5.4kΩ)	A.B	Circuit board	
CN32	Remote switch	TH22	Thermistor	SW1	Mode selection	
CN41	HA terminal-A	TH23		TH22	SW5	Voltage selection
CN51	Connector	TH23		TH23	SW11	Address setting 1st digit
CN52	Remotely indication	MF	Fan motor (with inner thermostat)	SW12	Address setting 2nd digit	
CNP	D. Heater	C1	Capacitor (fan motor)	SW14	Connection No.	
SW2	Capacity code	MV	Vane motor	SWC	Option selector	
SW3	Switch	P.B	Indoor power board			
SW4	Switch	DP	Drain-up machine (OPTION)			
ZNR	Varistor	DS	Drain sensor (OPTION)			
X4	Aux.Relay (Fan motor)	TB2	Terminal block			
X1	Aux.Relay D. Heater	TB5		Power supply		
FUSE	Fuse (6.3A)	TB15		Transmission		
F.C	Fan phase control	LEV	Linear expansion valve			
		H2	Dew prevention heater			

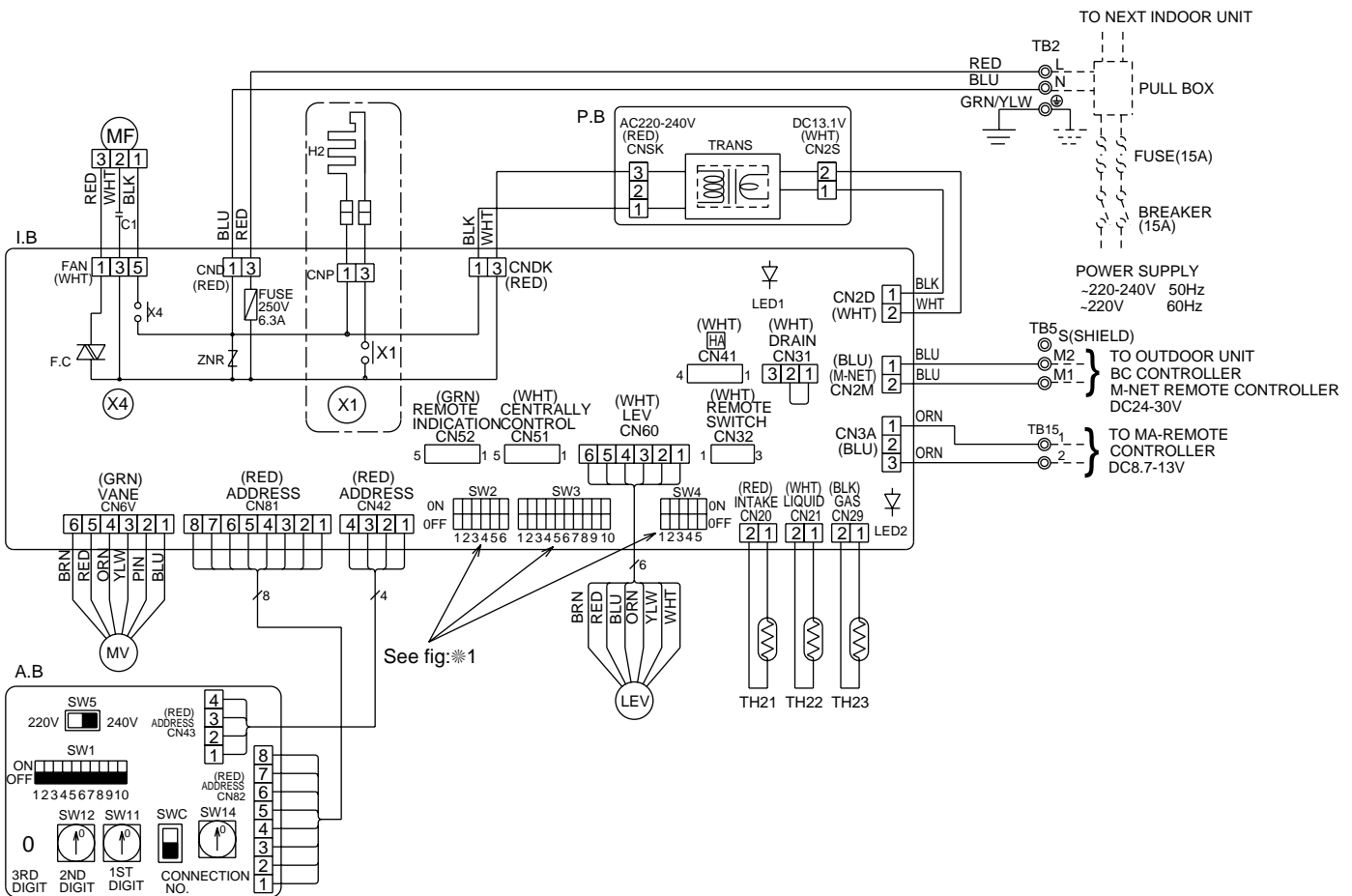

NOTE

- At servicing for outdoor unit, always follow the wiring diagram of outdoor unit.
- In case of using MA-Remote controller, please connect to TB15.
(Remote controller wire is non-polar.)
- In case of using M-NET, please connect to TB5. (Transmission line is non-polar.)
- Symbol[S] of TB5 is the shield wire connection.
- Symbols used in wiring diagram above are,
⊙: Terminal block, □: Connector.
- The setting of the SW2 dip switches differs in the capacity. For the detail, refer to the fig: ※1.
- Please set the switch SW5 according to the power supply voltage.
Set SW5 to 240V side when the power supply is 230 and 240 volts.
When the power supply is 220 volts, set SW5 to 220V side.

< ※ 1 >

Models	SW2	SW3	SW4
P63	ON OFF 1 2 3 4 5 6	ON OFF 1 2 3 4 5 6 7 8 9 10	ON OFF 1 2 3 4 5
P100	ON OFF 1 2 3 4 5 6	ON OFF 1 2 3 4 5 6 7 8 9 10	ON OFF 1 2 3 4 5

Led on indoor board for service

Mark	Meaning	Function
LED1	Main power supply	Main power supply (indoor unit: 220-240V) power on ⇒ lamp is lit
LED2	Power supply for MA-Remote controller	Power supply for MA-Remote controller on ⇒ lamp is lit

CONTENTS

1. Specifications	II -196
2. Capacity Tables	II -197
2-1 Cooling Capacity(PUMY)	II -197
2-2 Heating Capacity(PUMY)	II -197
2-3 Cooling Capacity(Y/R2-8-10-13HP)	II -198
2-4 Heating Capacity(Y/R2-8-10-13HP)	II -198
2-5 Cooling Capacity(Big Y, Super Y, Big R2)	II -199
2-6 Heating Capacity(Big Y, Super Y, Big R2)	II -199
2-7 Cooling Capacity(WY, WR2)	II -200
2-8 Heating Capacity(WY, WR2)	II -200
3. Sound Levels	II -201
3-1 Sound levels	II -201
3-2 N/C curves	II -201
4. External Dimension	II -202
5. Wiring Diagram	II -203
6. Temperature/Airflow distribution	II -204

1. Specifications

PCFY-P-VGM-A

			PCFY-P40VGM-A	PCFY-P63VGM-A	PCFY-P100VGM-A	PCFY-P125VGM-A
Power source			~ 220-240V 50Hz / ~220V 60Hz			
Cooling capacity	*1	kW	4.5	7.1	11.2	14.0
	*2	kcal/h	4,000	6,300	10,000	12,500
Heating capacity	*1	kW	5.0	8.0	12.5	16.0
Power consumption	Cooling	kW	0.10	0.13	0.16	0.24
	Heating	kW	0.10	0.13	0.16	0.24
Current	Cooling	A	0.46	0.60	0.73	1.10
	Heating	A	0.46	0.60	0.73	1.10
External finish(Munsel No.)			0.70Y 8.59/0.97			
Dimension *3	Height	mm	210		270	
	Width	mm	1,000	1,310		1,620
	Depth	mm	680			
Net weight	*3	kg	27	34	37	43
Heat exchanger			Cross fin (Aluminum plate fin and copper tube)			
Fan	Type		Sirocco fanX 2	Sirocco fanX 3	Sirocco fanX 4	
	Airflow rate (Lo-Mid2-Mid1-Hi) *3	m³/min	8-10-11-12	12-14-16-18	18-20-23-25	26-28-32-35
	External static pressure	Pa	0			
Motor	Type		Single phase induction motor			
	Output	kW	0.054	0.070	0.090	0.150
Air filter			PP Honeycomb (long life)			
Refrigerant pipe dimension	Gas (Flare)	mm	ø 12.7	ø 15.88	ø 19.05	
	Liquid (Flare)	mm	ø 6.35	ø 9.52		
Drain pipe dimension			VP-25			
Noise level (Lo-Mid2-Mid1-Hi) *3 *4		dB(A)	29-33-36-38	32-34-37-39	36-38-41-43	37-39-42-44

Note: *1 Cooling/Heating capacity indicates the maximum value at operation under the following condition.

Cooling : Indoor 27°CDB/19°CWB, Outdoor 35°CDB

Heating : Indoor 20°CDB, Outdoor 7°CDB/6°CWB

*2 Cooling capacity indicates the maximum value at operation under the following condition.

Cooling : Indoor 27°CDB/19.5°CWB, Outdoor 35°CDB (WR2: water 30°C)

*3 External dimension/net weight are shown in (unit/panel), and airflw rate/noise level are in (low-middle 2-middle 1-high).

*4 It is measured in anechoic room.

2. Capacity Tables

2-1.Cooling Capacity (In combination with PUMY)

CA :Capacity(kW)
SHC:Sensible Heat Capacity(kW)

PCFY-P-VGM-A

Unit size	Outdoor air temp. °CDB	Indoor air temp.							
		23°CDB 16°CWB		25°CDB 18°CWB		28°CDB 20°CWB		30°CDB 22°CWB	
		CA	SHC	CA	SHC	CA	SHC	CA	SHC
40 (4.5)	20.0	4.5	3.1	4.7	3.2	5.0	3.2	5.3	3.3
	22.5	4.4	3.1	4.6	3.2	5.0	3.2	5.2	3.3
	25.0	4.3	3.1	4.6	3.2	4.9	3.2	5.2	3.3
	27.5	4.3	3.0	4.6	3.2	4.9	3.2	5.1	3.2
	30.0	4.2	3.0	4.5	3.2	4.8	3.1	5.1	3.2
	32.5	4.2	3.0	4.4	3.1	4.7	3.1	5.0	3.2
	35.0	4.1	2.9	4.4	3.1	4.7	3.1	5.0	3.2
	37.5	4.1	2.9	4.3	3.1	4.6	3.0	4.9	3.1
	40.0	4.0	2.9	4.3	3.0	4.5	3.0	4.8	3.1
46.0	3.8	2.8	4.1	3.0	4.3	2.9	4.6	3.0	
63 (7.1)	20.0	7.0	5.0	7.4	5.1	7.9	5.1	8.3	5.3
	22.5	6.9	4.9	7.3	5.1	7.8	5.1	8.2	5.2
	25.0	6.9	4.9	7.3	5.1	7.7	5.1	8.2	5.2
	27.5	6.8	4.8	7.2	5.0	7.7	5.0	8.1	5.2
	30.0	6.7	4.8	7.1	5.0	7.5	5.0	8.0	5.1
	32.5	6.6	4.7	7.0	5.0	7.5	4.9	7.9	5.1
	35.0	6.5	4.7	6.9	4.9	7.3	4.9	7.8	5.0
	37.5	6.4	4.6	6.8	4.9	7.2	4.8	7.7	5.0
	40.0	6.3	4.6	6.7	4.8	7.2	4.8	7.6	4.9
46.0	6.1	4.5	6.5	4.7	6.9	4.6	7.3	4.8	
100 (11.2)	20.0	11.1	7.8	11.6	8.1	12.5	8.1	13.1	8.3
	22.5	10.9	7.8	11.5	8.1	12.3	8.0	13.0	8.3
	25.0	10.8	7.7	11.5	8.0	12.2	8.0	12.9	8.2
	27.5	10.7	7.6	11.3	8.0	12.1	7.9	12.8	8.2
	30.0	10.5	7.5	11.2	7.9	11.9	7.8	12.6	8.1
	32.5	10.4	7.5	11.1	7.8	11.8	7.8	12.5	8.0
	35.0	10.2	7.4	10.9	7.8	11.6	7.7	12.3	7.9
	37.5	10.1	7.3	10.8	7.7	11.4	7.6	12.2	7.9
	40.0	10.0	7.3	10.6	7.6	11.3	7.6	12.0	7.8
46.0	9.6	7.1	10.2	7.4	10.8	7.3	11.5	7.6	
125 (14.0)	20.0	13.9	9.9	14.6	10.3	15.6	10.2	16.4	10.5
	22.5	13.7	9.8	14.4	10.2	15.4	10.1	16.2	10.4
	25.0	13.5	9.7	14.3	10.1	15.3	10.1	16.1	10.3
	27.5	13.4	9.6	14.2	10.1	15.1	10.0	16.0	10.3
	30.0	13.2	9.5	14.0	10.0	14.9	9.9	15.8	10.2
	32.5	13.0	9.4	13.8	9.9	14.7	9.8	15.6	10.1
	35.0	12.8	9.3	13.7	9.8	14.5	9.7	15.4	10.0
	37.5	12.6	9.2	13.4	9.7	14.3	9.6	15.2	9.9
	40.0	12.5	9.1	13.3	9.6	14.1	9.5	15.0	9.8
46.0	12.0	8.9	12.8	9.4	13.5	9.2	14.4	9.6	

PCFY-P-VGM-A

2-2.Heating Capacity (In combination with PUMY)

PCFY-P-VGM-A

SHC:Sensible Heat Capacity(kW)

Unit size	Outdoor air temp. °CWB	Indoor air temp.:°CDB			Unit size	Outdoor air temp. °CWB	Indoor air temp.:°CDB		
		15.0	20.0	25.0			15.0	20.0	25.0
		SHC	SHC	SHC			SHC	SHC	SHC
40	-12.0	3.2	3.1	3.1	100	-12.0	8.0	7.8	7.7
	-10.0	3.4	3.3	3.2		-10.0	8.4	8.2	8.1
	-5.0	3.8	3.8	3.7		-5.0	9.6	9.4	9.3
	0.0	4.3	4.3	4.2		0.0	10.9	10.7	10.6
	2.5	4.6	4.6	4.5		2.5	11.5	11.4	11.3
	6.0	5.0	5.0	4.9		6.0	12.6	12.5	12.3
	7.5	5.2	5.2	5.0		7.5	13.0	12.9	12.4
	10.0	5.5	5.5	5.0		10.0	13.8	13.7	12.4
	12.5	5.9	5.5	5.0		12.5	14.6	13.8	12.4
15.5	6.2	5.5	5.0	15.5	15.4	13.8	12.4		
63	-12.0	5.1	5.0	4.9	125	-12.0	10.2	10.0	9.8
	-10.0	5.4	5.3	5.2		-10.0	10.7	10.6	10.4
	-5.0	6.1	6.0	5.9		-5.0	12.2	12.1	11.9
	0.0	6.9	6.9	6.8		0.0	13.9	13.8	13.6
	2.5	7.4	7.3	7.2		2.5	14.8	14.7	14.5
	6.0	8.0	8.0	7.9		6.0	16.1	16.0	15.8
	7.5	8.3	8.3	7.9		7.5	16.7	16.6	15.8
	10.0	8.8	8.8	7.9		10.0	17.7	17.6	15.8
	12.5	9.4	8.8	7.9		12.5	18.7	17.7	15.8
15.5	9.8	8.8	7.9	15.5	19.7	17.7	15.8		

2-3.Cooling Capacity (In combination with PU(H)Y, PURY-(P)200-250-315YEM-A)

CA :Capacity(kW)
SHC:Sensible Heat Capacity(kW)

PCFY-P-VGM-A

Unit size	Outdoor air temp. °CDB	Indoor air temp.													
		21.5°CDB 15°CWB		23°CDB 16°CWB		25°CDB 18°CWB		27°CDB 19°CWB		28°CDB 20°CWB		30°CDB 22°CWB		32°CDB 24°CWB	
		CA	SHC	CA	SHC	CA	SHC	CA	SHC	CA	SHC	CA	SHC	CA	SHC
40 (4.5)	20.0	4.4	3.1	4.5	3.2	4.7	3.1	4.8	3.1	4.9	3.2	5.0	3.1	5.2	3.0
	22.5	4.4	3.1	4.5	3.1	4.6	3.1	4.7	3.1	4.8	3.1	5.0	3.1	5.2	3.0
	25.0	4.3	3.1	4.4	3.1	4.6	3.0	4.7	3.0	4.8	3.1	5.0	3.0	5.1	3.0
	27.5	4.3	3.0	4.4	3.1	4.5	3.0	4.6	3.0	4.7	3.1	4.9	3.0	5.1	2.9
	30.0	4.2	3.0	4.3	3.1	4.5	3.0	4.6	3.0	4.7	3.1	4.9	3.0	5.0	2.9
	32.5	4.2	3.0	4.3	3.0	4.5	3.0	4.5	3.0	4.6	3.1	4.8	3.0	5.0	2.9
	35.0	4.1	3.0	4.2	3.0	4.4	2.9	4.5	3.0	4.6	3.0	4.8	3.0	5.0	2.9
	37.5	4.1	2.9	4.2	3.0	4.4	2.9	4.5	2.9	4.5	3.0	4.7	3.0	4.9	2.9
	40.0	4.1	2.9	4.1	3.0	4.3	2.9	4.4	2.9	4.5	3.0	4.7	2.9	4.9	2.9
43.0	4.0	2.9	4.1	2.9	4.3	2.9	4.4	2.9	4.4	3.0	4.6	2.9	4.8	2.8	
63 (7.1)	20.0	7.0	4.9	7.1	5.0	7.4	4.9	7.5	4.9	7.7	5.0	8.0	4.9	8.2	4.7
	22.5	6.9	4.9	7.0	5.0	7.3	4.8	7.5	4.9	7.6	5.0	7.9	4.9	8.2	4.7
	25.0	6.8	4.8	7.0	4.9	7.2	4.8	7.4	4.8	7.5	5.0	7.8	4.8	8.1	4.7
	27.5	6.7	4.8	6.9	4.9	7.2	4.8	7.3	4.8	7.5	4.9	7.7	4.8	8.0	4.7
	30.0	6.7	4.8	6.8	4.9	7.1	4.7	7.2	4.8	7.4	4.9	7.7	4.8	8.0	4.6
	32.5	6.6	4.7	6.7	4.8	7.0	4.7	7.2	4.7	7.3	4.9	7.6	4.7	7.9	4.6
	35.0	6.5	4.7	6.7	4.8	7.0	4.7	7.1	4.7	7.2	4.8	7.5	4.7	7.8	4.6
	37.5	6.5	4.7	6.6	4.7	6.9	4.6	7.0	4.7	7.2	4.8	7.5	4.7	7.7	4.6
	40.0	6.4	4.6	6.5	4.7	6.8	4.6	7.0	4.6	7.1	4.8	7.4	4.7	7.7	4.5
43.0	6.3	4.6	6.4	4.7	6.7	4.6	6.9	4.6	7.0	4.7	7.3	4.6	7.6	4.5	
100 (11.2)	20.0	11.0	7.8	11.2	7.9	11.6	7.7	11.9	7.7	12.1	8.0	12.5	7.7	13.0	7.5
	22.5	10.9	7.7	11.1	7.9	11.5	7.7	11.8	7.7	12.0	7.9	12.4	7.7	12.9	7.5
	25.0	10.8	7.7	11.0	7.8	11.4	7.6	11.6	7.7	11.9	7.9	12.3	7.7	12.8	7.4
	27.5	10.6	7.6	10.9	7.7	11.3	7.6	11.5	7.6	11.8	7.8	12.2	7.6	12.7	7.4
	30.0	10.5	7.5	10.8	7.7	11.2	7.5	11.4	7.6	11.6	7.8	12.1	7.6	12.5	7.3
	32.5	10.4	7.5	10.6	7.6	11.1	7.5	11.3	7.5	11.5	7.7	12.0	7.5	12.4	7.3
	35.0	10.3	7.4	10.5	7.6	11.0	7.4	11.2	7.5	11.4	7.7	11.9	7.5	12.3	7.3
	37.5	10.2	7.4	10.4	7.5	10.9	7.4	11.1	7.4	11.3	7.6	11.8	7.4	12.2	7.2
	40.0	10.1	7.3	10.3	7.5	10.8	7.3	11.0	7.4	11.2	7.6	11.6	7.4	12.1	7.2
43.0	9.9	7.2	10.2	7.4	10.6	7.2	10.8	7.3	11.1	7.5	11.5	7.3	12.0	7.1	
125 (14.0)	20.0	13.7	9.8	14.0	10.0	14.6	9.7	14.8	9.8	15.1	10.1	15.7	9.8	16.2	9.5
	22.5	13.6	9.7	13.9	9.9	14.4	9.7	14.7	9.7	15.0	10.0	15.5	9.7	16.1	9.4
	25.0	13.4	9.6	13.7	9.8	14.3	9.6	14.6	9.6	14.8	9.9	15.4	9.7	16.0	9.4
	27.5	13.3	9.6	13.6	9.8	14.1	9.5	14.4	9.6	14.7	9.9	15.3	9.6	15.8	9.3
	30.0	13.2	9.5	13.4	9.7	14.0	9.5	14.3	9.5	14.6	9.8	15.1	9.6	15.7	9.3
	32.5	13.0	9.4	13.3	9.6	13.9	9.4	14.1	9.5	14.4	9.8	15.0	9.5	15.5	9.2
	35.0	12.9	9.4	13.2	9.6	13.7	9.3	14.0	9.4	14.3	9.7	14.8	9.4	15.4	9.2
	37.5	12.7	9.3	13.0	9.5	13.6	9.3	13.9	9.3	14.1	9.6	14.7	9.4	15.3	9.1
	40.0	12.6	9.2	12.9	9.4	13.4	9.2	13.7	9.3	14.0	9.6	14.6	9.3	15.1	9.1
43.0	12.4	9.1	12.7	9.3	13.3	9.1	13.6	9.2	13.8	9.5	14.4	9.3	15.0	9.0	

PCFY-P-VGM-A

2-4.Heating Capacity (In combination with PU(H)Y, PURY-(P)200-250-315YEM-A)

PCFY-P-VGM-A

SHC:Sensible Heat Capacity(kW)

Unit size	Outdoor air temp. °CWB	Indoor air temp.:°CDB			
		15.0	20.0	25.0	27.0
		SHC	SHC	SHC	SHC
40	-15.0	3.3	3.3	3.3	3.3
	-10.0	3.8	3.8	3.7	3.5
	-5.0	4.3	4.2	3.9	3.5
	0.0	4.8	4.7	3.9	3.5
	2.5	5.0	5.0	3.9	3.5
	6.0	5.1	5.0	3.9	3.5
	7.5	5.3	5.0	3.9	3.5
	10.0	5.6	5.0	3.9	3.5
	12.5	6.0	5.0	3.9	3.5
15.5	6.1	5.0	3.9	3.5	
63	-15.0	5.4	5.3	5.2	5.2
	-10.0	6.1	6.0	6.0	5.5
	-5.0	6.9	6.8	6.2	5.5
	0.0	7.6	7.5	6.2	5.5
	2.5	8.0	7.9	6.2	5.5
	6.0	8.1	8.0	6.2	5.5
	7.5	8.4	8.0	6.2	5.5
	10.0	9.0	8.0	6.2	5.5
	12.5	9.6	8.0	6.2	5.5
15.5	9.7	8.0	6.2	5.5	
Unit size	Outdoor air temp. °CWB	Indoor air temp.:°CDB			
		15.0	20.0	25.0	27.0
		SHC	SHC	SHC	SHC
100	-15.0	8.4	8.2	8.2	8.1
	-10.0	9.6	9.4	9.3	8.6
	-5.0	10.7	10.6	9.8	8.6
	0.0	11.9	11.8	9.8	8.6
	2.5	12.5	12.4	9.8	8.6
	6.0	12.6	12.5	9.8	8.6
	7.5	13.2	12.5	9.8	8.6
	10.0	14.1	12.5	9.8	8.6
	12.5	15.0	12.5	9.8	8.6
15.5	15.1	12.5	9.8	8.6	
125	-15.0	10.7	10.6	10.5	10.4
	-10.0	12.2	12.1	11.9	11.0
	-5.0	13.7	13.6	12.5	11.0
	0.0	15.3	15.1	12.5	11.0
	2.5	16.0	15.8	12.5	11.0
	6.0	16.2	16.0	12.5	11.0
	7.5	16.8	16.0	12.5	11.0
	10.0	18.0	16.0	12.5	11.0
	12.5	19.1	16.0	12.5	11.0
15.5	19.4	16.0	12.5	11.0	

2-5.Cooling Capacity (In combination with Big Y, Super Y, Big R2)

PCFY-P-VGM-A

CA :Capacity(kW)
SHC:Sensible Heat Capacity(kW)

Unit size	Outdoor air temp.	Indoor air temp.											
		21.5°CDB 15°CWB		23°CDB 16°CWB		25°CDB 18°CWB		28°CDB 20°CWB		30°CDB 22°CWB		32°CDB 24°CWB	
		°CDB	CA	SHC	CA	SHC	CA	SHC	CA	SHC	CA	SHC	CA
40	20.0	4.1	3.0	4.3	3.1	4.7	3.1	5.0	3.2	5.3	3.2	5.6	3.1
	22.5	4.1	3.0	4.3	3.1	4.6	3.1	4.9	3.2	5.2	3.2	5.5	3.1
	25.0	4.1	2.9	4.3	3.0	4.6	3.0	4.9	3.2	5.2	3.1	5.5	3.1
	27.5	4.1	2.9	4.2	3.0	4.5	3.0	4.8	3.2	5.1	3.1	5.4	3.0
	30.0	4.0	2.9	4.2	3.0	4.5	3.0	4.8	3.1	5.0	3.1	5.3	3.0
	32.5	4.0	2.9	4.2	3.0	4.4	3.0	4.7	3.1	5.0	3.0	5.2	3.0
	35.0	4.0	2.9	4.1	3.0	4.4	2.9	4.6	3.1	4.9	3.0	5.1	3.0
	37.5	3.9	2.9	4.1	2.9	4.3	2.9	4.6	3.0	4.8	3.0	5.1	2.9
	40.0	3.9	2.8	4.0	2.9	4.3	2.9	4.5	3.0	4.7	3.0	5.0	2.9
43.0	3.9	2.8	4.0	2.9	4.2	2.9	4.4	3.0	4.7	2.9	4.9	2.9	
63	20.0	6.5	4.7	6.9	4.9	7.4	4.9	7.9	5.1	8.4	5.1	8.9	5.0
	22.5	6.5	4.7	6.8	4.9	7.3	4.9	7.8	5.1	8.3	5.0	8.7	4.9
	25.0	6.5	4.7	6.8	4.8	7.2	4.8	7.7	5.0	8.1	5.0	8.6	4.9
	27.5	6.4	4.6	6.7	4.8	7.2	4.8	7.6	5.0	8.0	4.9	8.5	4.8
	30.0	6.4	4.6	6.6	4.8	7.1	4.7	7.5	5.0	7.9	4.9	8.4	4.8
	32.5	6.3	4.6	6.6	4.7	7.0	4.7	7.4	4.9	7.8	4.8	8.2	4.7
	35.0	6.3	4.6	6.5	4.7	6.9	4.7	7.3	4.9	7.7	4.8	8.1	4.7
	37.5	6.2	4.5	6.4	4.7	6.8	4.6	7.2	4.8	7.6	4.7	8.0	4.7
	40.0	6.2	4.5	6.4	4.6	6.7	4.6	7.1	4.8	7.5	4.7	7.9	4.6
43.0	6.1	4.5	6.3	4.6	6.6	4.5	7.0	4.7	7.3	4.7	7.7	4.5	
100	20.0	10.3	7.4	10.8	7.7	11.6	7.7	12.5	8.1	13.2	8.0	14.0	7.9
	22.5	10.3	7.4	10.8	7.7	11.5	7.7	12.3	8.1	13.0	7.9	13.8	7.8
	25.0	10.2	7.4	10.7	7.6	11.4	7.6	12.1	8.0	12.8	7.9	13.6	7.7
	27.5	10.1	7.3	10.6	7.6	11.3	7.6	12.0	7.9	12.7	7.8	13.4	7.7
	30.0	10.1	7.3	10.5	7.5	11.2	7.5	11.8	7.9	12.5	7.7	13.2	7.6
	32.5	10.0	7.3	10.3	7.5	11.0	7.4	11.7	7.8	12.3	7.7	13.0	7.5
	35.0	9.9	7.2	10.2	7.4	10.9	7.4	11.5	7.7	12.1	7.6	12.8	7.4
	37.5	9.8	7.2	10.1	7.4	10.8	7.3	11.4	7.7	12.0	7.5	12.6	7.4
	40.0	9.7	7.1	10.0	7.3	10.6	7.3	11.2	7.6	11.8	7.5	12.4	7.3
43.0	9.6	7.1	9.9	7.3	10.5	7.2	11.0	7.5	11.6	7.4	12.2	7.2	
125	20.0	12.9	9.4	13.5	9.7	14.6	9.7	15.6	10.3	16.5	10.1	17.5	9.9
	22.5	12.9	9.4	13.5	9.7	14.4	9.7	15.4	10.2	16.3	10.0	17.2	9.9
	25.0	12.8	9.3	13.3	9.6	14.3	9.6	15.2	10.1	16.1	9.9	17.0	9.8
	27.5	12.7	9.3	13.2	9.6	14.1	9.5	15.0	10.0	15.8	9.8	16.7	9.7
	30.0	12.6	9.2	13.1	9.5	13.9	9.5	14.8	9.9	15.6	9.8	16.5	9.6
	32.5	12.5	9.2	12.9	9.4	13.8	9.4	14.6	9.8	15.4	9.7	16.2	9.5
	35.0	12.4	9.1	12.8	9.4	13.6	9.3	14.4	9.8	15.2	9.6	16.0	9.4
	37.5	12.3	9.0	12.7	9.3	13.5	9.2	14.2	9.7	15.0	9.5	15.7	9.3
	40.0	12.2	9.0	12.5	9.3	13.3	9.2	14.0	9.6	14.8	9.4	15.5	9.2
43.0	12.0	8.9	12.4	9.2	13.1	9.1	13.8	9.5	14.5	9.3	15.2	9.1	

PCFY-P-VGM-A

2-6.Heating Capacity (In combination with Big Y, Super Y, Big R2)

PCFY-P-VGM-A

SHC:Sensible Heat Capacity(kW)

Unit size	Outdoor air temp.	Indoor air temp.:°CDB			
		15	21	25	27
		°CWB	SHC	SHC	SHC
40	-15.0	3.1	3.1	3.0	3.0
	-10.0	3.6	3.5	3.5	3.4
	-5.0	4.0	4.0	3.9	3.9
	0.0	4.5	4.4	4.3	3.9
	2.5	4.7	4.7	4.3	3.9
	6.0	5.0	5.0	4.3	3.9
	7.5	5.2	5.0	4.3	3.9
	10.0	5.4	5.0	4.3	3.9
	12.5	5.7	5.0	4.3	3.9
15.5	5.8	5.0	4.3	3.9	
63	-15.0	5.0	4.9	4.8	4.7
	-10.0	5.7	5.6	5.5	5.4
	-5.0	6.4	6.3	6.2	6.2
	0.0	7.2	7.1	6.8	6.2
	2.5	7.5	7.5	6.8	6.2
	6.0	8.1	8.0	6.8	6.2
	7.5	8.3	8.0	6.8	6.2
	10.0	8.7	8.0	6.8	6.2
	12.5	9.1	8.0	6.8	6.2
15.5	9.2	8.0	6.8	6.2	
100	-15.0	7.8	7.7	7.5	7.4
	-10.0	8.9	8.8	8.6	8.5
	-5.0	10.0	9.9	9.8	9.6
	0.0	11.2	11.0	10.6	9.6
	2.5	11.8	11.6	10.6	9.6
	6.0	12.6	12.5	10.6	9.6
	7.5	13.0	12.5	10.6	9.6
	10.0	13.6	12.5	10.6	9.6
	12.5	14.3	12.5	10.6	9.6
15.5	14.4	12.5	10.6	9.6	
125	-15.0	10.0	9.8	9.6	9.5
	-10.0	11.4	11.2	11.0	10.9
	-5.0	12.8	12.6	12.5	12.3
	0.0	14.3	14.1	13.6	12.3
	2.5	15.1	14.9	13.6	12.3
	6.0	16.2	16.0	13.6	12.3
	7.5	16.6	16.0	13.6	12.3
	10.0	17.4	16.0	13.6	12.3
	12.5	18.3	16.0	13.6	12.3
15.5	18.4	16.0	13.6	12.3	

2-7.Cooling Capacity (In combination with WY, WR2)

CA :Capacity(kW)
SHC:Sensible Heat Capacity(kW)

PCFY-P-VGM-A

Unit size	Outdoor air temp.	Indoor air temp.													
		21.5°CDB 15°CWB		23°CDB 16°CWB		25°CDB 18°CWB		27°CDB 19°CWB		28°CDB 20°CWB		30°CDB 22°CWB		32°CDB 24°CWB	
		CA	SHC	CA	SHC	CA	SHC	CA	SHC	CA	SHC	CA	SHC	CA	SHC
40	10	4.4	3.1	4.5	3.2	4.8	3.1	5.0	3.2	5.1	3.3	5.4	3.2	5.7	3.2
	20	4.2	3.0	4.4	3.1	4.6	3.1	4.8	3.1	4.9	3.2	5.2	3.1	5.5	3.1
	30	4.0	2.9	4.1	3.0	4.4	2.9	4.5	3.0	4.6	3.1	4.9	3.0	5.2	3.0
	40	3.5	2.6	3.6	2.7	3.8	2.7	3.9	2.7	4.0	2.8	4.3	2.8	4.5	2.7
	45	3.3	2.5	3.4	2.6	3.6	2.6	3.7	2.6	3.8	2.7	4.0	2.7	4.2	2.6
63	10	6.9	4.9	7.2	5.0	7.6	5.0	7.8	5.0	8.0	5.2	8.5	5.1	9.0	5.0
	20	6.7	4.8	6.9	4.9	7.3	4.9	7.5	4.9	7.8	5.1	8.2	5.0	8.6	4.9
	30	6.3	4.6	6.5	4.7	6.9	4.7	7.1	4.7	7.3	4.9	7.7	4.8	8.1	4.7
	40	5.5	4.2	5.7	4.3	6.0	4.3	6.2	4.3	6.4	4.5	6.7	4.4	7.1	4.3
	45	5.2	4.0	5.3	4.1	5.7	4.1	5.8	4.2	6.0	4.3	6.3	4.3	6.7	4.2
100	10	10.9	7.8	11.3	8.0	12.0	7.9	12.3	8.0	12.7	8.2	13.4	8.1	14.1	7.9
	20	10.5	7.5	10.9	7.8	11.6	7.7	11.9	7.8	12.2	8.0	12.9	7.9	13.6	7.8
	30	9.9	7.2	10.3	7.5	10.9	7.4	11.2	7.5	11.5	7.7	12.2	7.6	12.8	7.5
	40	8.6	6.6	8.9	6.8	9.5	6.7	9.7	6.8	10.0	7.1	10.6	7.0	11.2	6.9
	45	8.1	6.4	8.4	6.6	8.9	6.5	9.2	6.6	9.5	6.9	10.0	6.8	10.5	6.6
125	10	13.7	9.8	14.1	10.0	15.0	9.9	15.4	10.0	15.9	10.4	16.7	10.2	17.7	10.0
	20	13.2	9.5	13.6	9.8	14.5	9.7	14.8	9.8	15.3	10.1	16.1	10.0	17.0	9.8
	30	12.4	9.1	12.8	9.4	13.6	9.3	14.0	9.4	14.4	9.8	15.2	9.6	16.1	9.4
	40	10.8	8.3	11.2	8.6	11.9	8.5	12.2	8.6	12.5	9.0	13.2	8.8	14.0	8.7
	45	10.2	8.0	10.5	8.3	11.2	8.2	11.5	8.4	11.8	8.7	12.5	8.5	13.2	8.4

2-8.Heating Capacity (In combination with WY, WR2)

SHC:Sensible Heat Capacity(kW)

PCFY-P-VGM-A

Unit size	Outdoor air temp.	Indoor air temp.:°CDB				
		15	19	20	25	27
		SHC	SHC	SHC	SHC	SHC
40	10	4.4	4.3	4.3	3.4	3.1
	20	5.2	5.1	5.0	4.0	3.6
	30	5.2	5.1	5.0	4.0	3.6
	40	5.4	5.3	5.2	4.2	3.7
	45	5.9	5.8	5.7	4.6	4.1
63	10	7.0	6.9	6.8	5.4	4.9
	20	8.2	8.2	8.0	6.4	5.8
	30	8.2	8.2	8.0	6.4	5.8
	40	8.6	8.5	8.3	6.7	6.0
	45	9.4	9.3	9.1	7.3	6.6
100	10	10.9	10.8	10.6	8.5	7.7
	20	12.9	12.8	12.5	10.0	9.0
	30	12.9	12.8	12.5	10.0	9.0
	40	13.4	13.3	13.0	10.4	9.4
	45	14.7	14.5	14.3	11.4	10.3
125	10	14.0	13.9	13.6	10.9	9.8
	20	16.5	16.3	16.0	12.8	11.5
	30	16.5	16.3	16.0	12.8	11.5
	40	17.1	17.0	16.6	13.3	12.0
	45	18.8	18.6	18.2	14.6	13.1

3. Sound Levels

3-1. Noise level

Ceiling suspended

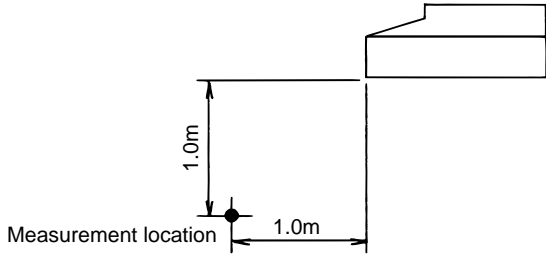

Noise level at anechoic room
(Low-Middle2-Middle1-High)

Unit : dB(A)

Model	Noise level (A weighted)
PCFY-P40VGM-A	29-33-36-38
PCFY-P63VGM-A	32-34-37-39
PCFY-P100VGM-A	36-38-41-43
PCFY-P125VGM-A	37-39-42-44

PCFY-P-VGM-A

3-2. NC curves

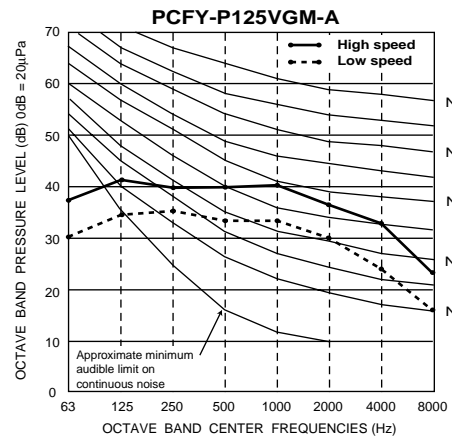
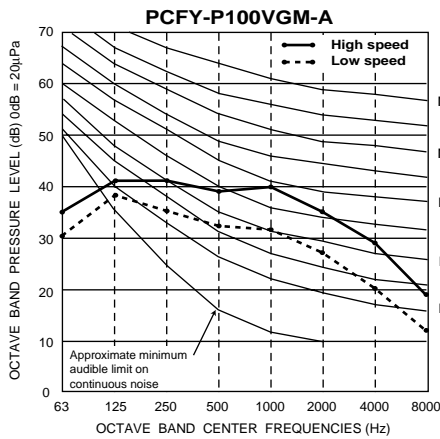
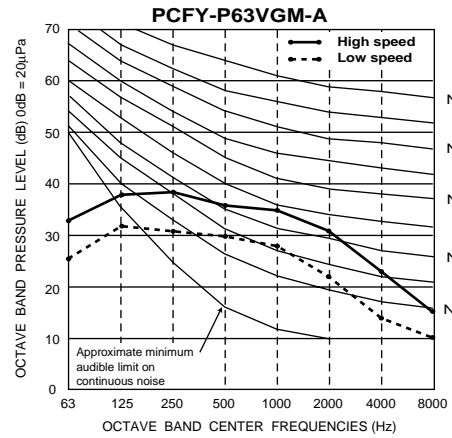
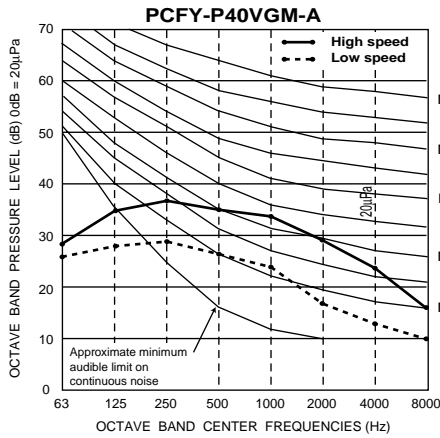

4. External Dimension

PCFY-P-VGM-A

PCFY-P40,63,100,125VGM-A

Unit : mm

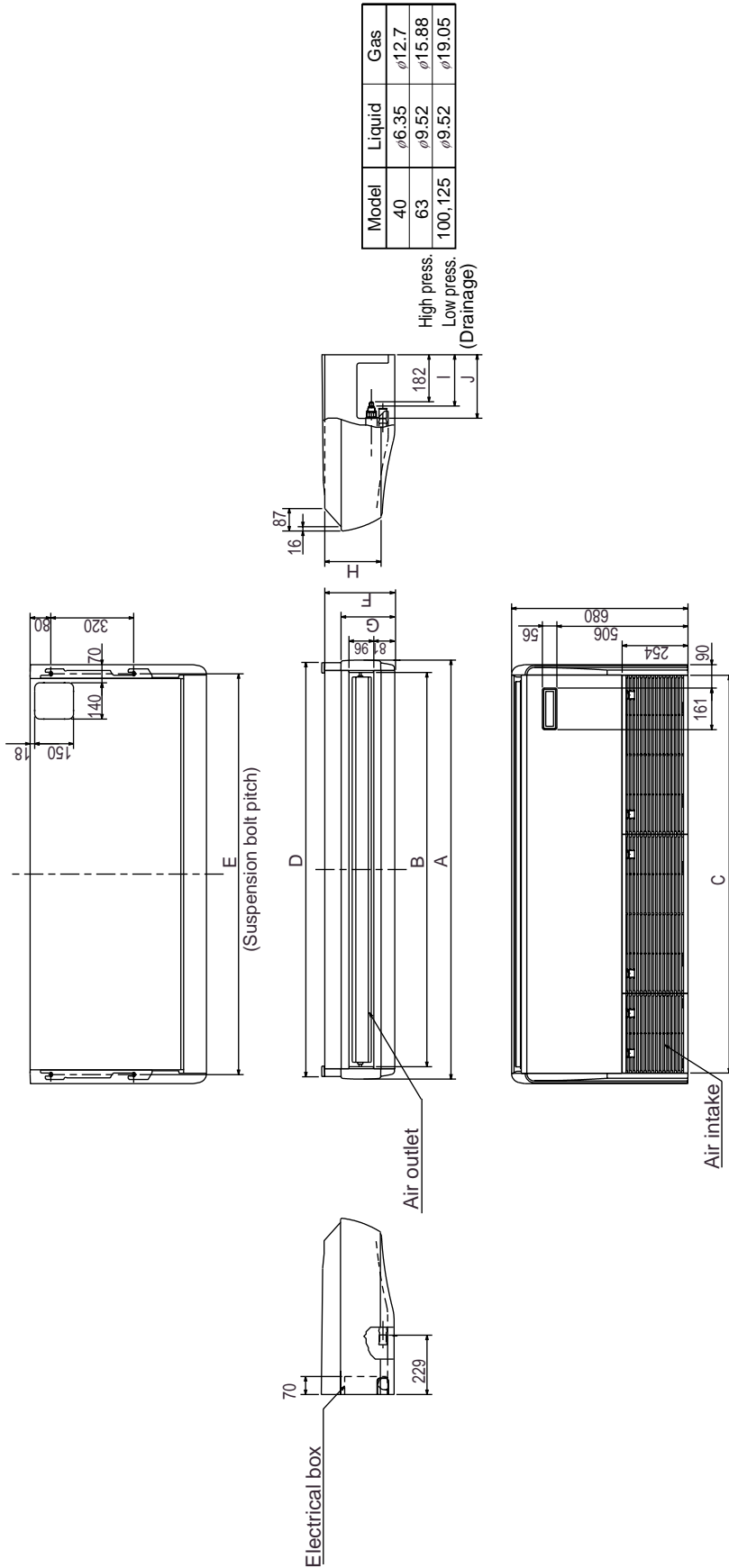

Model	Liquid	Gas
40	φ6.35	φ12.7
63	φ9.52	φ15.88
100, 125	φ9.52	φ19.05

High press.
Low press.
(Drainage)

Model	A	B	C	D	E	F	G	H	I	J
PCFY -P40VGM-A	1,000	904	918	983	933	210	180	157	201	241
PCFY -P63VGM-A	1,310	1,214	1,228	1,290	1,240	210	180	157	201	241
PCFY -P100VGM-A	1,310	1,214	1,228	1,290	1,240	270	207	217	198	245
PCFY -P125VGM-A	1,620	1,524	1,535	1,600	1,547	270	207	217	198	245

5. Electrical Wiring Diagram

<SYMBOL EXPLANATION>

Symbol	Name	Symbol	Name	Symbol	Name	
I.B	Indoor controller board	C1	Capacitor(fan motor)	A.B	Circuit board	
CN32	Connector	LEV	Linear expansion valve	SW1	Mode selection	
CN51		MF	Fan motor(with inner thermo)	SW5	Voltage selection	
CN52		MV	Vane motor	SW11	Address setting 1st digit	
CNP		TH21	Thermistor	SW12	Address setting 2nd digit	
F.C	Fan phase control	TH22		SW14	Connection No.	
FUSE	Fuse (6.3A)	TH23	Room temp. detection (0°C/15kΩ,25°C/5.4kΩ)	SWA	Ceiling high selector	
SW2	Switch	TB2	Pipe temp. detection / Liquid (0°C/15kΩ,25°C/5.4kΩ)	SWC	Option selector	
SW3			Capacity code	Pipe temp. detection / Gas (0°C/15kΩ,25°C/5.4kΩ)	Led on indoor board for service	
SW4			Mode selection	Power supply	Mark	Meaning
X1	Aux.Relay	TB5	Transmission	LED1	Main power supply	Main power supply (indoor unit:220-240V) power on → lamp is lit
X4	Fan motor	TB15	MA-remote controller	LED2	Power supply for MA-Remote controller	Power supply for MA-Remote controller power on → lamp is lit
ZNR	Varistor	DP	Drain-up machine (OPTION)			
P.B	Indoor power board	DS	Drain sensor (OPTION)			

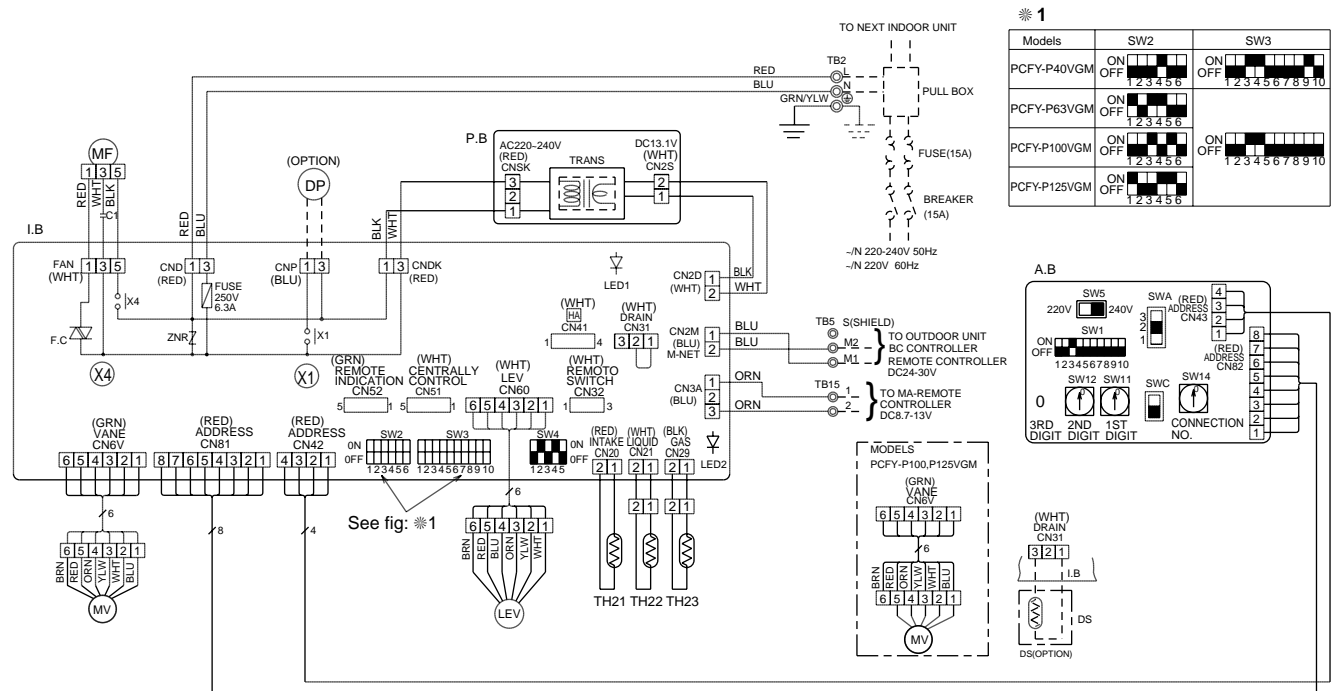

Note

- At servicing for outdoor unit, always follow the wiring diagram of outdoor unit.
- In case of using MA-Remote controller, please connect to TB15.
(Remote controller wire is non-polar.)
- In case of using M-NET, please connect to TB5. (Transmission line is non-polar.)
- Symbol[S] of TB5 is the shield wire connection.
- Symbols used in wiring diagram above are,
⊙: Terminal block, □: Connector.
- The setting of the SW2 dip switches differs in the capacity. For the detail, refer to the fig: ※1.
- Please set the switch SW5 according to the power supply voltage.
Set SW5 to 240V side when the power supply is 230 and 240 volts.
When the power supply is 220 volts, set SW5 to 220V side.
- Fasten terminal of the terminal board "TB5" equips lock system.
To remove the fasten terminal, pull it while pressing the protruding portion (locking lever) of the terminal.
Connection of the fasten terminal, protruding portion should face upward.

6. Temperature/Airflow distribution

● Temperature distribution

<Cooling mode>
Flow angle : 0°



<Heating mode>
Flow angle : 60°

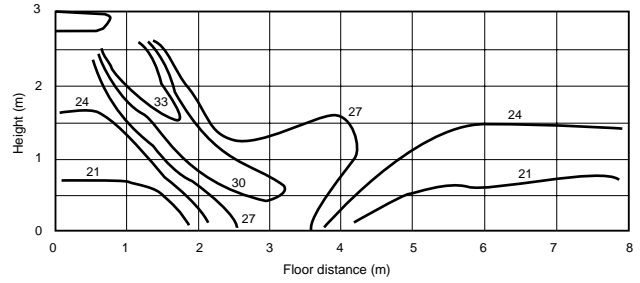

● Airflow distribution

<Fan mode>
Flow angle : 0°



<Fan mode>
Flow angle : 60°

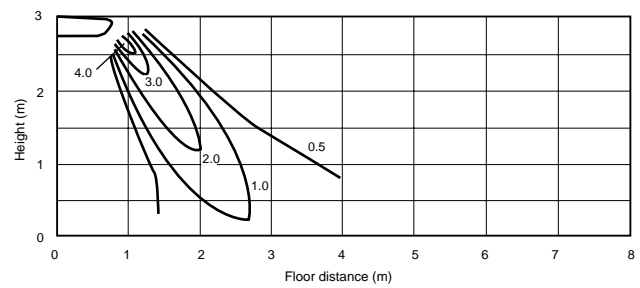

PCFY-P-VGM-A

OA Processing unit

GUF-RD2
GUF-RDH2

CONTENTS

1. Specifications	II -206
2. Sound Levels	II -207
2-1 NC-curves	II -207
2-2 Fan characteristics curves	II -208
3. External Dimension	II -209
4. Wiring Diagrams	II -210

1. Specifications

Item	Model		GUF-50RDH2	GUF-100RDH2	GUF-50RD2	GUF-100RD2
Power supply			Single phase 220-240V ~50Hz			
Current	A		1.15	2.20	1.15	2.20
Input	W		235-265	480-505	235-265	480-505
Cooling capacity	kW		5.29<1.66>	10.81<3.49>	5.29<1.66>	10.81<3.49>
Heating capacity	kW		6.42<2.25>	13.00<4.70>	6.42<2.25>	13.00<4.70>
Fan	Type X No.		SA : Centrifugal fan [Sirocco fan] X1 EA : Centrifugal fan [Sirocco fan] X1			
	Air volume	m ³ /h	500	1000	500	1000
		L/S	139	278	139	278
External static pressure	Pa	125	135	140	140	
Noise level (Low-High) ※	dB(A)		33.5-34.5	38-39	33.5-34.5	38-39
Humidifying capacity	kg/h		2.7	5.4	-	-
Cladding			Galvanized steel plate			
Dimensions	Height	mm	317	398	317	398
	Width	mm	1016	1231	1016	1231
	Depth	mm	1288	1580	1288	1580
Weight (drying)	kg		57	98	54	93
Motor			Totally enclosed capacitor permanent split-phase induction motor, 4 poles, 2 units			
Air filter	Supply air		Non-woven fabrics filter : Gravitational method 82% +High efficiency filter : Colorimetric method 65% (optional parts)			
	Exhaust air		Non-woven fabrics filter : Gravitational method 82%			
Total heat exchanger (Lossnay element)			Partition, spacing plate-special treated paper			
Direct expansion heat exchanger coil			Aluminum plate fins and copper tubes			
Humidifying			Permeable film humidifier		-	
Refrigerant pipe dimension	Gas	φ mm	12.7	15.88	12.7	15.88
	Liquid	φ mm	6.35	9.52	6.35	9.52
Drain pipe dimension			VP25			
Capacity equivalent to the indoor unit			P32	P63	P32	P63

- Note: 1 The figures in < > indicates the heat recovery at Lossnay element.
 2 Cooling/Heating capacity indicates the maximum value at operation under the following condition.
 Cooling : Indoor : 27°C DB/19.5°C WB Outdoor : 35°C DB/24°C WB
 Heating : Indoor : 21°C DB/14.6°C WB Outdoor : 7°C DB/6°C WB
 3 The values given in the table for the noise level reflect the levels measured at a position 1.5 meters immediately below the unit in anechoic chamber.
 4 The noise at the air outlets (at a 45° angle, 1.5 meters in front) is about 5-6 dB(A) higher than the values given in the table.
 5 The above values apply during Lossnay ventilation when the fan speed is set to high speed.
 6 Specification may be subject to change without notice.
 ※ It is measured in anechoic room.

2. Sound Levels

2-1. NC curves

GUF-50RDH2/50RD2

Directly below (Measurement point A)

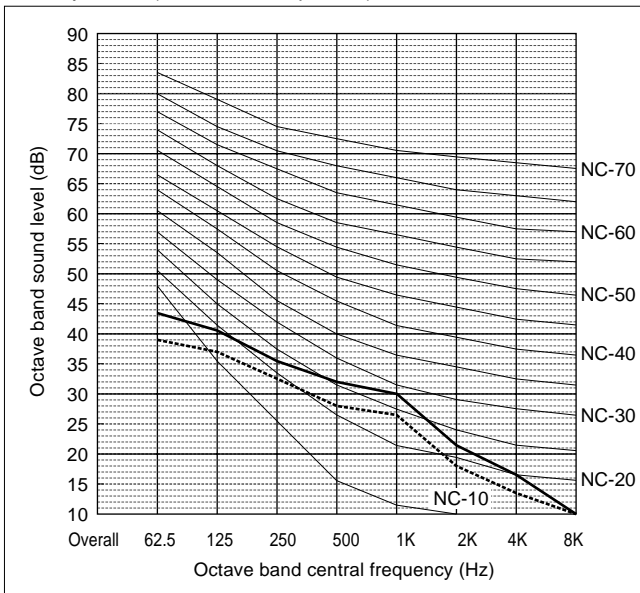

Outlet (Measurement point B)

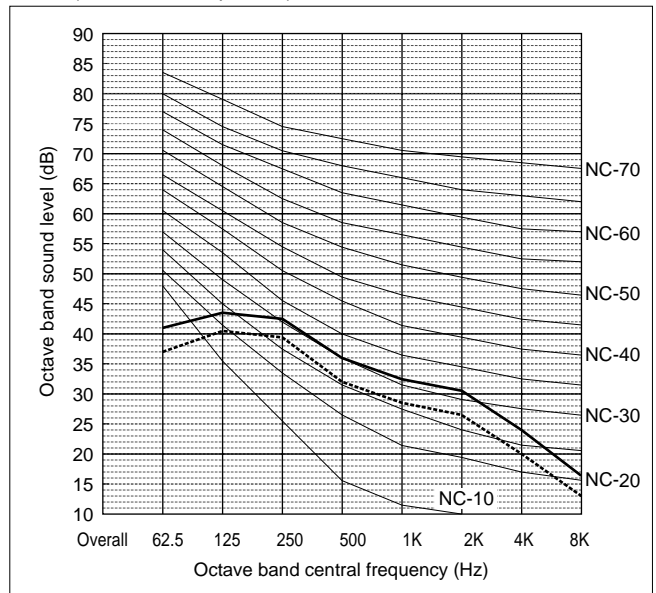

GUF-100RDH2/100RD2

Directly below (Measurement point A)

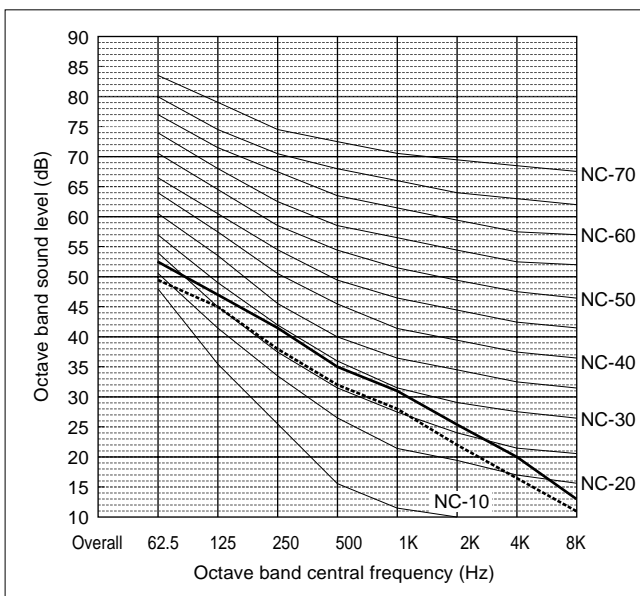

Outlet (Measurement point B)

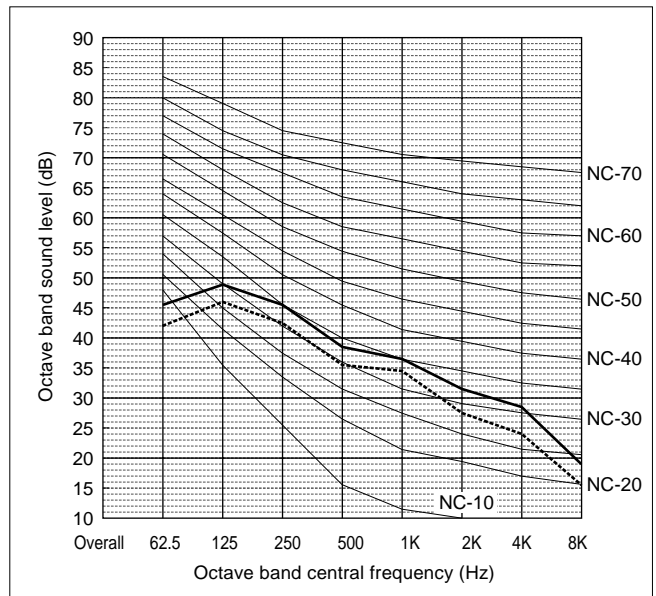

OA Processing unit

● Measurement Condition

Measurement site:

Mitsubishi Electric Co.,
Nakatsugawa Works
Anechoic chamber

<Ceiling recessed type>

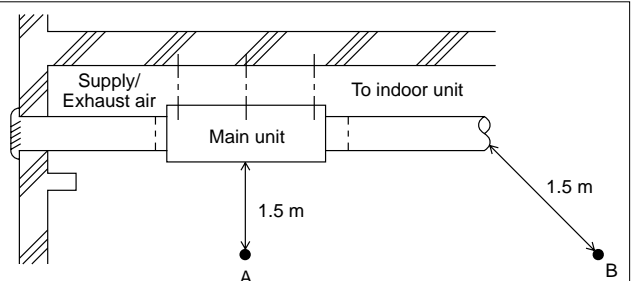

2-2. Fan characteristics curves

■ Humidifying Type

GUF-50RDH2

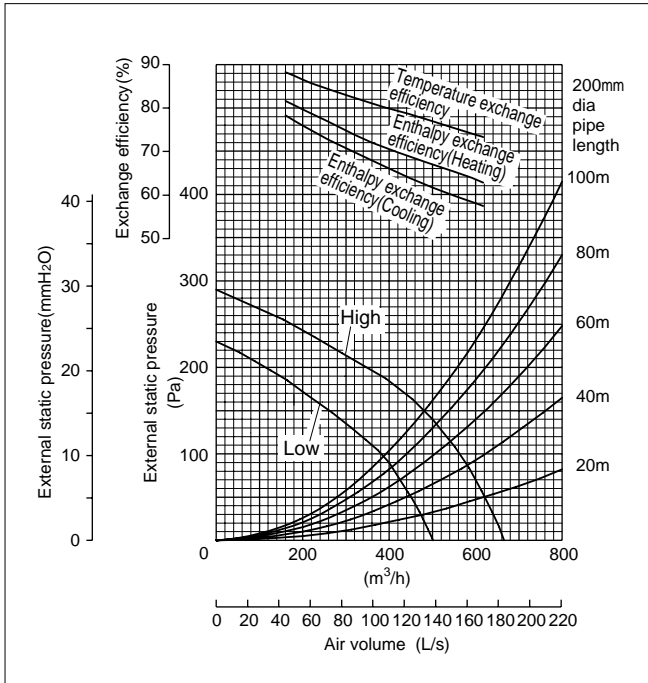

GUF-100RDH2

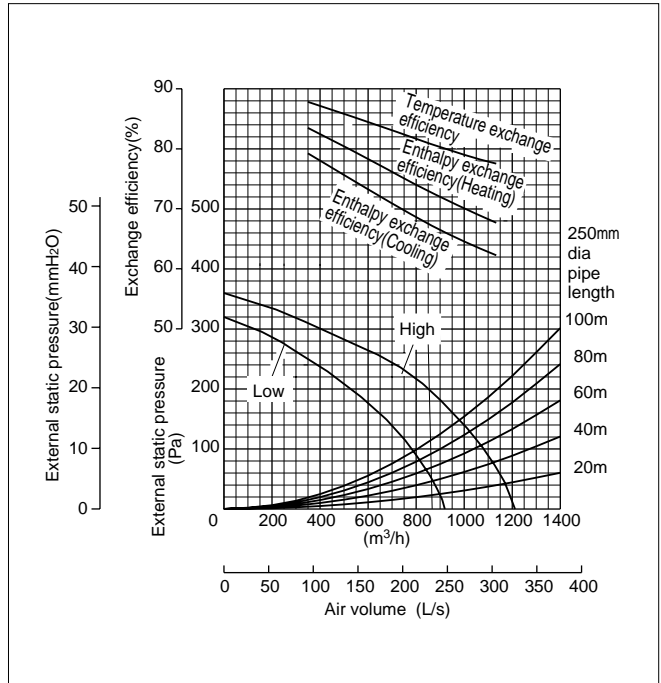

■ Non-Humidifying Type

GUF-50RD2

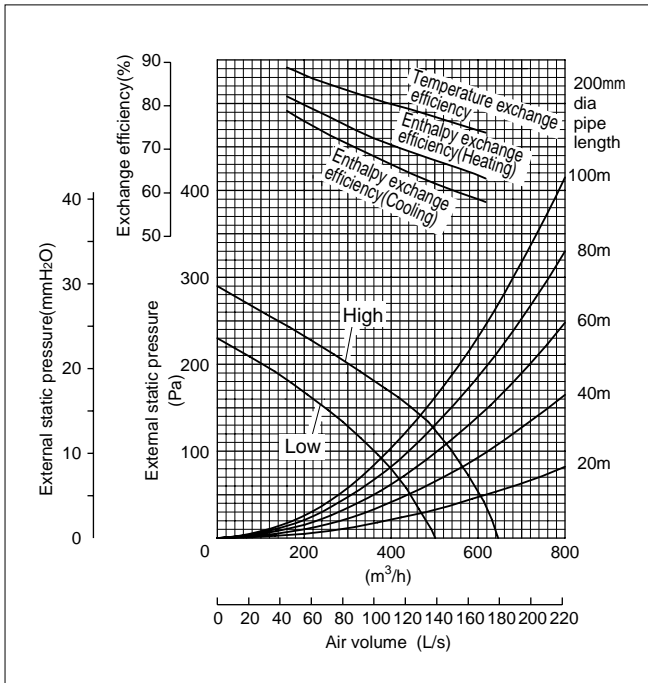

GUF-100RD2

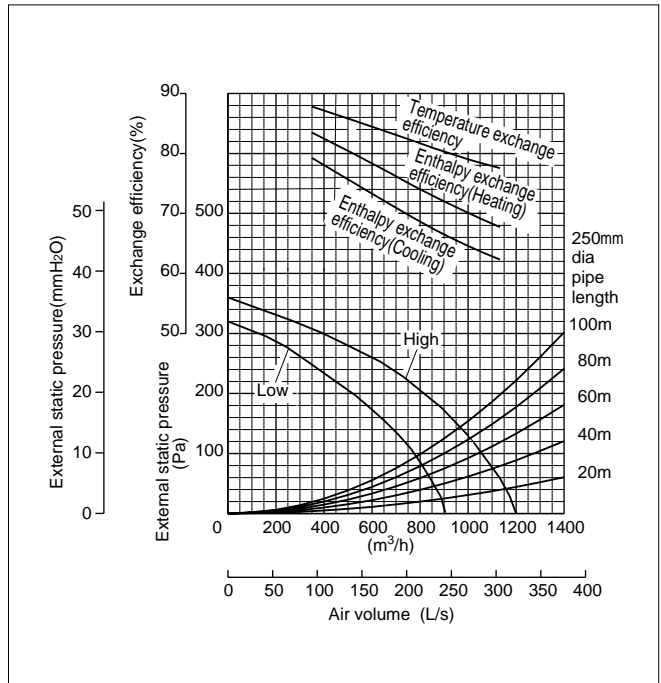

3. External Dimension

GUF-50, 100RD(H)2

Unit : mm

Humidifying Type GUF-50/100RDH2

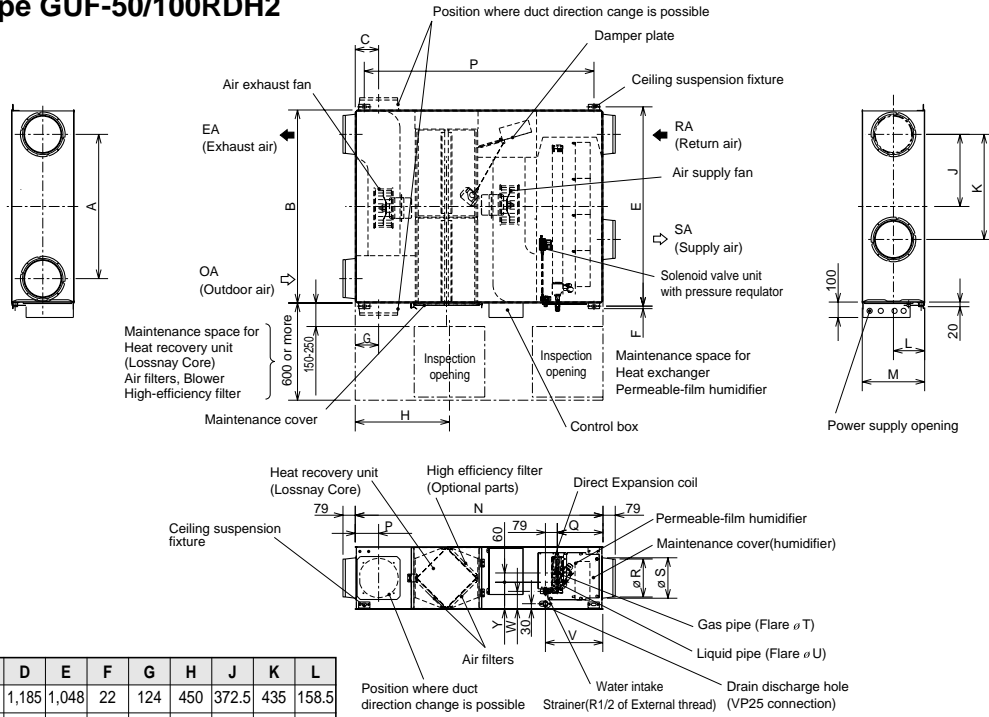

Model	A	B	C	D	E	F	G	H	J	K	L
GUF-50RDH2	745	1,016	124	1,185	1,048	22	124	450	372.5	435	158.5
GUF-100RDH2	920	1,231	149	1,465	1,271	16	149	600	460	670	199
Model	M	N	P	Q	R	S	T	U	V	W	Y
GUF-50RDH2	317	1,288	124	266	192	208	12.7	6.35	347	99	135
GUF-100RDH2	398	1,580	149	280	242	258	15.88	9.52	361	110	169

Non-Humidifying Type GUF-50/100RD2

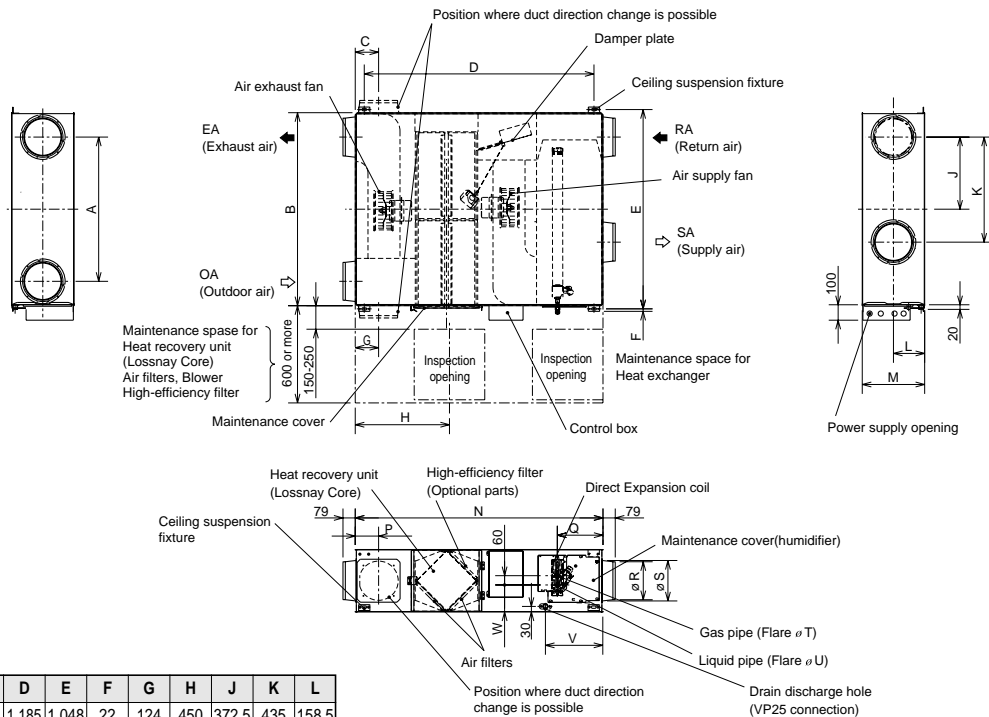

Model	A	B	C	D	E	F	G	H	J	K	L
GUF-50RD2	745	1,016	124	1,185	1,048	22	124	450	372.5	435	158.5
GUF-100RD2	920	1,231	149	1,465	1,271	16	149	600	460	670	199
Model	M	N	P	Q	R	S	T	U	V	W	
GUF-50RD2	317	1,288	124	266	192	208	12.7	6.35	347	135	
GUF-100RD2	398	1,580	149	280	242	258	15.88	9.52	361	169	

OA Processing unit

4. Wiring Diagrams

Humidifying Type GUF-50/100RDH2

- TM1, TM2 shown in dotted lines are field work.
- Be sure to connect the grounding wire.
- Breakers and controller switches should be provided by the customer.

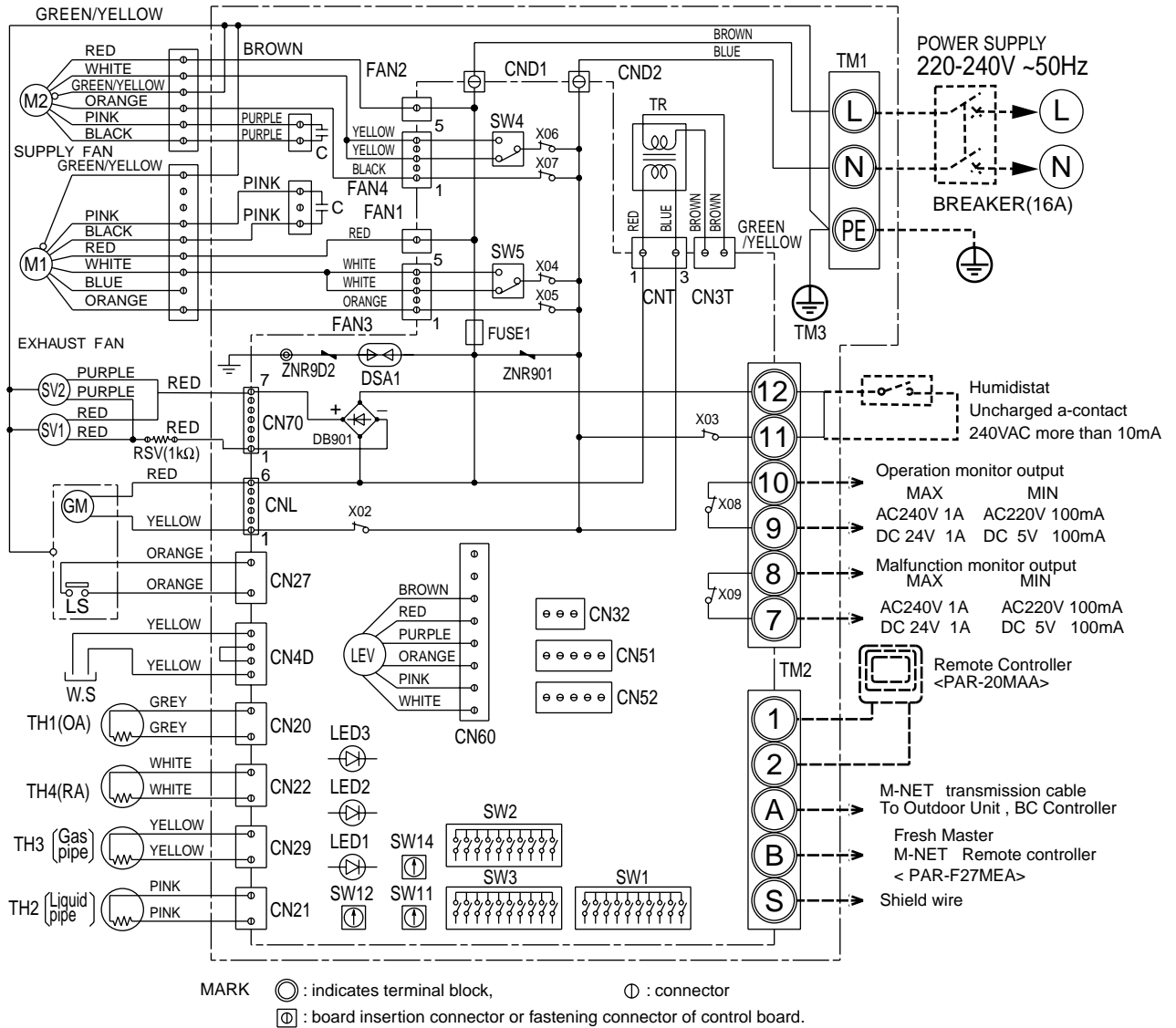

Symbol Explanation

Symbol	Name	Symbol	Name	Symbol	Name
M1	Fan motor (exhaust)	TM1	Terminal block (power supply)	1, 2	Remote control terminal
M2	Fan motor (supply)	TM2	Terminal block (transmission)	A, B	M-NET transmission terminal
C	Capacitor	TM3	Terminal block (humidistat, monitor)	S	Shield
W.S	Water sensor	SW1	Switch (function selection)	CND1, CND2	Connector (power supply)
SV1	Solenoid valve (pressure regulator)	SW2	Switch (capacity code setting)	X02-X09	Relay
SV2	Solenoid valve (exhaust)	SW3	Switch (function selection)	TR	Transformer
TH1	Thermistor (outdoor air temp. detection)	SW4, SW5	Switch	GM	Damper motor
TH2	Thermistor (pipe temp. detection/liquid)	SW11	Switch (1st digit address set)	LS	Limit switch
TH3	Thermistor (pipe temp. detection/gas)	SW12	Switch (2nd digit address set)	LED1	Power supply monitor
TH4	Thermistor (room air temp. detection)	SW14	Switch (branch NO. set)	LED2	MA Remote contolle
LEV	Electronic linear expansion valve	CN32	Connector (Remote input)	LED3	Power supply monitor
RSV	Resistance (solenoid valve)	CN51, CN52	Connector (Remote input/output)		M-NET Power supply monitor

Non-Humidifying Type GUF-50/100RD2

- TM1, TM2 shown in dotted lines are field work.
- Be sure to connect the grounding wire.
- Breakers and controller switches should be provided by the customer.

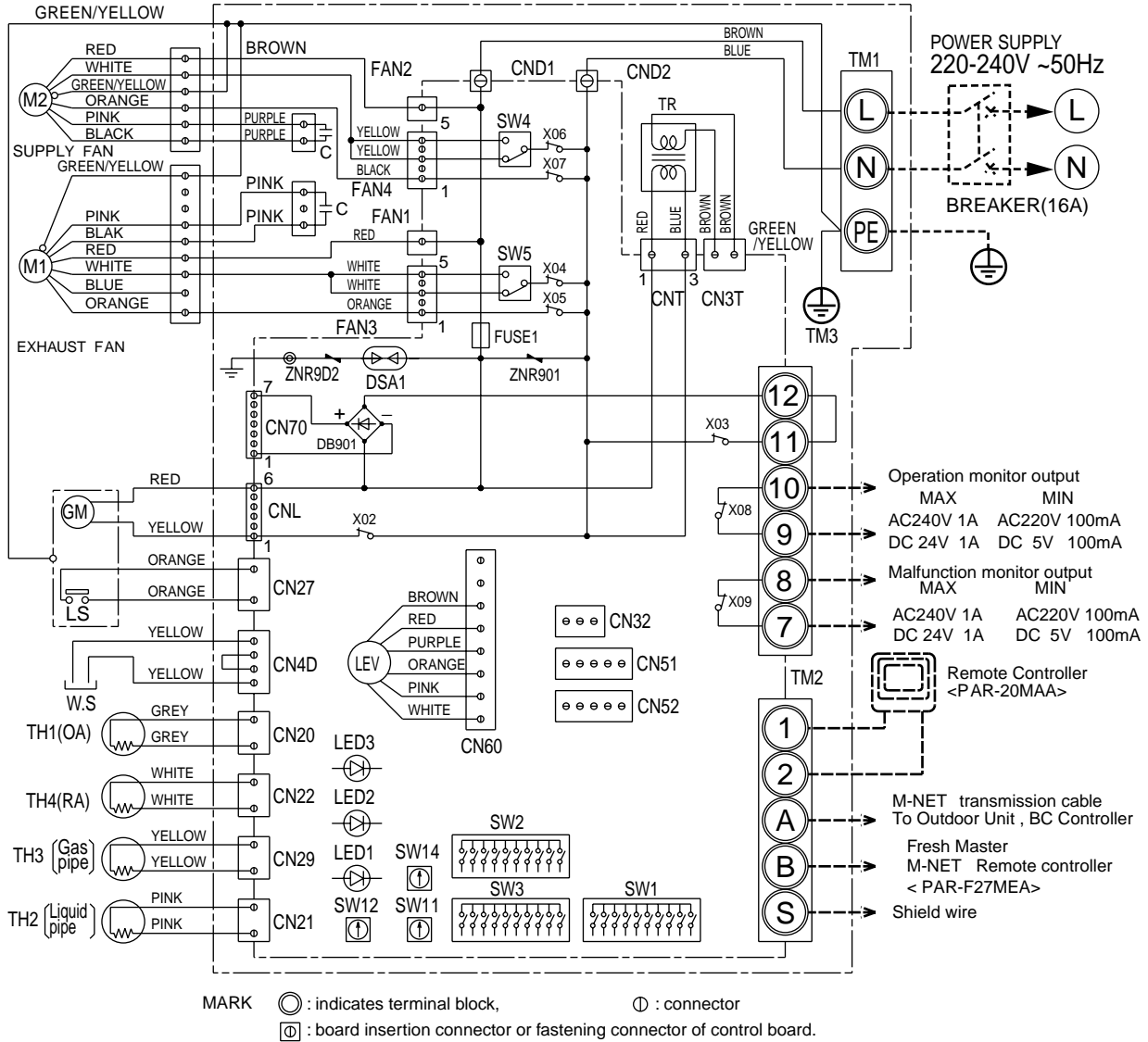

Symbol Explanation

Symbol	Name	Symbol	Name	Symbol	Name
M1	Fan motor (exhaust)	TM1	Terminal block (power supply)	1, 2	Remote control terminal
M2	Fan motor (supply)	TM2	Terminal block (transmission)	A, B	M-NET transmission terminal
C	Capacitor	TM3	Terminal block (humidistat, monitor)	s	Shield
W.S	Water sensor	SW1	Switch (function selection)	CND1, CND2	Connector (power supply)
TH1	Thermistor (outdoor air temp. detection)	SW2	Switch (capacity code setting)	X02-X09	Relay
TH2	Thermistor (pipe temp. detection/liquid)	SW3	Switch (function selection)	TR	Transformer
TH3	Thermistor (pipe temp. detection/gas)	SW4, SW5	Switch	GM	Damper motor
TH4	Thermistor (room air temp. detection)	SW11	Switch (1st digit address set)	LS	Limit switch
LEV	Electronic linear expansion valve	SW12	Switch (2nd digit address set)	LED1	Power supply monitor
		SW14	Switch (branch NO. set)	LED2	MA Remote controller
		CN32	Connector (Remote input)	LED3	M-NET Power supply monitor
		CN51, CN52	Connector (Remote input/output)		

LOSSNAY unit

LGH-RX₃-E

CONTENTS

1. Dimensions	II -214
2. Performance	II -215
3. Specifications	II -216
4. Sample Installations	II -217
5. Electrical Installations	II -219
6. Wiring Diagrams	II -220

LOSSNAY

1. Dimensions

LGH-15RX₃-E to LGH-100RX₃-E

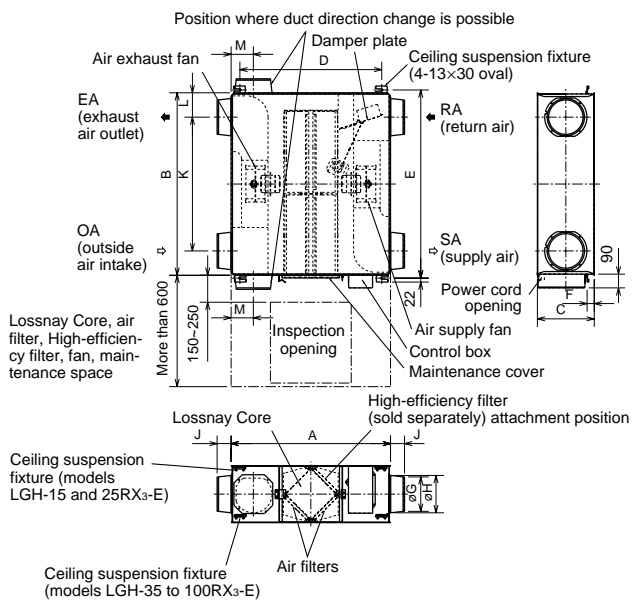

LGH-150RX₃-E and LGH-200RX₃-E

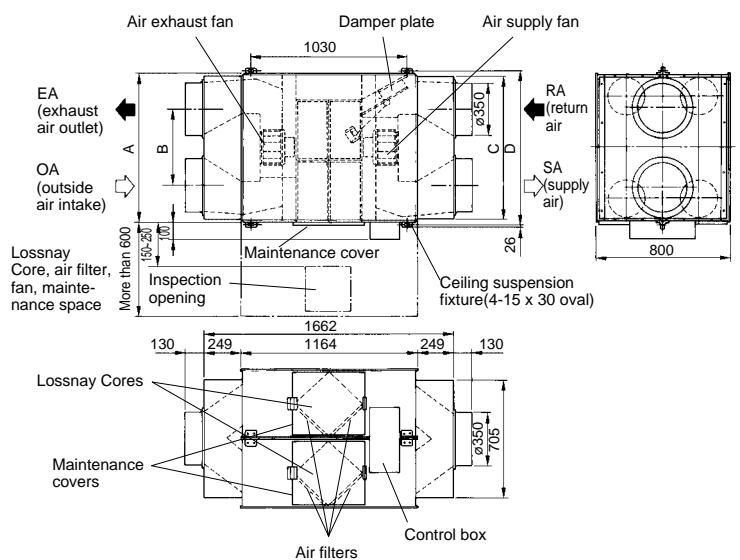
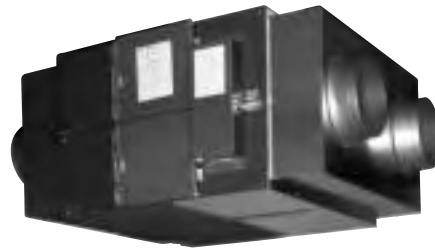

Accessory parts

- Mounting screws.....×18
- Duct connecting flanges×4
(double flanges at SA and EA sides)
- Protective cover.....×1
<for installing upside down>
- Slim-Lossnay connection cable (gray: two wires)....×1

Accessory parts

- Duct connecting flanges.....×4
- Mounting screws.....×34
- Washers.....×32
- Protective cover.....×1
<for installing upside down>
- Slim-Lossnay connection cable (gray: two wires)....×1

LGH-15RX₃-E to LGH-100RX₃-E

Model	Dimensions			Ceiling suspension fixture pitch			Nominal diameter	Duct connecting flange			Duct pitch			Weight (kg)
	A	B	C	D	E	F		G	H	J	K	L	M	
LGH-15RX ₃ -E	780	610	275	700	641	10*	ø100	97.5	110	54	450	80	119	17
LGH-25RX ₃ -E	780	735	275	700	765	10*	ø150	142	160	63	530	102.5	102	21
LGH-35RX ₃ -E	888	874	317	790	906	40	ø150	142	160	63	650	112	124	30
LGH-50RX ₃ -E	888	1,016	317	790	1,048	40	ø200	192	208	79	745	135.5	124	33
LGH-80RX ₃ -E	1,164	1,004	398	1,030	1,036	10	ø250	242	258	79	690	157	149	61
LGH-100RX ₃ -E	1,164	1,231	398	1,030	1,263	10	ø250	242	258	79	920	155.5	149	72

*Shows the distance from the ceiling.

Model	A	B	C	D	Weight (kg)
LGH-150RX ₃ -E	1,004	510	964	1,046	154
LGH-200RX ₃ -E	1,231	740	1,194	1,273	179

2. Performance

LGH-15RX3-E

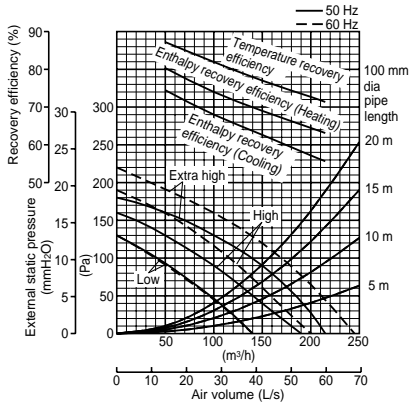

LGH-80RX3-E

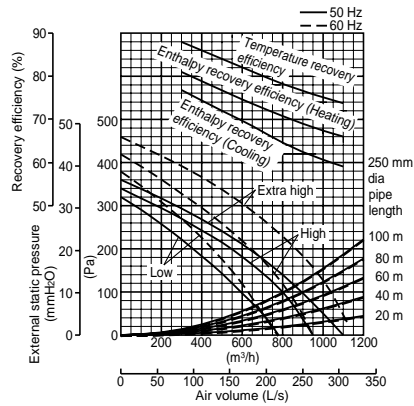

LGH-25RX3-E

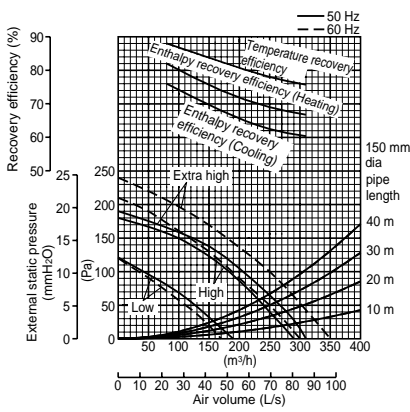

LGH-100RX3-E

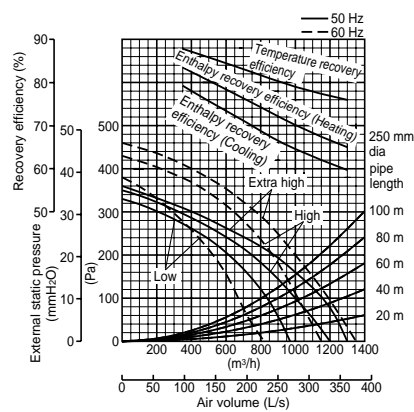

LGH-35RX3-E

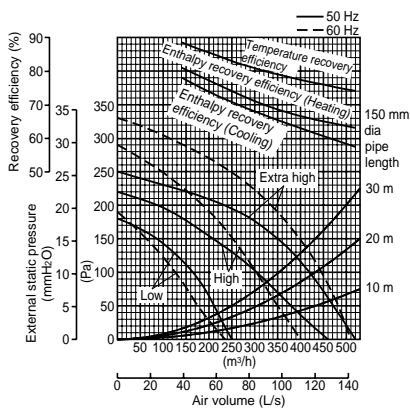

LGH-150RX3-E

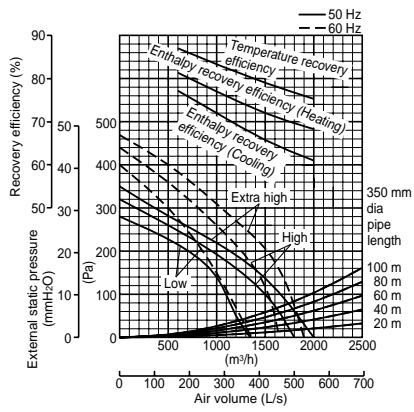

LGH-50RX3-E

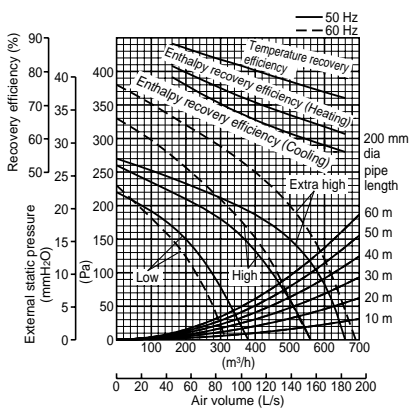

LGH-200RX3-E

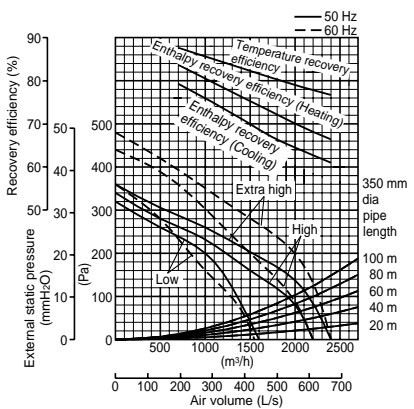

3. Specifications

LGH-15RX3-E

Model		LGH-15RX3-E					
Power source		Single phase 220-240V ~50Hz/220V~60Hz					
Ventilation mode		Lossnay ventilation			Bypass ventilation		
Speed		Extra high	High	Low	Extra high	High	Low
Current (A)		0.48-0.52/0.57	0.34-0.35/0.39	0.24-0.25/0.27	0.48-0.52/0.58	0.34-0.36/0.40	0.24-0.25/0.27
Input (W)		104-122/119	74-83/85	52-59/58	104-123/120	74-85/85	52-59/58
Air volume	(m³/h)	150/150	150/150	120/110	150/150	150/150	120/110
	(L/s)	42/42	42/42	33/31	42/42	42/42	33/31
External static pressure	(mmH ₂ O)	9.2/12.2	4.1/6.1	2.6/3.6	9.2/12.2	4.1/6.1	2.6/3.6
	(Pa)	90/120	40/60	25/35	90/120	40/60	25/35
Temperature recovery efficiency (%)		77/77	77/77	80/81	—	—	—
Enthalpy recovery efficiency (%)	Heating	69/69	69/69	72/73	—	—	—
	Cooling	62.5/62.5	62.5/62.5	66/67	—	—	—
Noise (dB) (Measured at 1.5m under the center of the unit)		26-27/28	24-25/25	21-22/22	26-27/28	24-25/25.5	21-22/22
Weight (kg)		17					
Starting current		Under 0.8/0.7A or less					

LGH-25RX3-E

Model		LGH-25RX3-E					
Power source		Single phase 220-240V ~50Hz/220V~60Hz					
Ventilation mode		Lossnay ventilation			Bypass ventilation		
Speed		Extra high	High	Low	Extra high	High	Low
Current (A)		0.51-0.54/0.63	0.42-0.44/0.49	0.25-0.27/0.28	0.52-0.55/0.63	0.42-0.45/0.50	0.25-0.27/0.27
Input (W)		111-128/131	91-104/106	54-64/60	112-130/132	91-105/107	54-64/58
Air volume	(m³/h)	250/250	250/250	165/150	250/250	250/250	165/150
	(L/s)	69/69	69/69	46/42	69/69	69/69	46/42
External static pressure	(mmH ₂ O)	6.6/10.2	4.1/5.1	2.0/2.0	6.6/10.2	4.1/5.1	2.0/2.0
	(Pa)	65/100	40/50	20/20	65/100	40/50	20/20
Temperature recovery efficiency (%)		78/78	78/78	83/84	—	—	—
Enthalpy recovery efficiency (%)	Heating	69/69	69/69	74/75	—	—	—
	Cooling	62.5/62.5	62.5/62.5	68/70	—	—	—
Noise (dB) (Measured at 1.5m under the center of the unit)		26.5-27.5/28.5	25-26/25.5	21-22/21	27-28/29	25.5-26.5/26	21-22/21
Weight (kg)		21					
Starting current		Under 0.8/0.7A or less					

LGH-35RX3-E

Model		LGH-35RX3-E					
Power source		Single phase 220-240V ~50Hz/220V~60Hz					
Ventilation mode		Lossnay ventilation			Bypass ventilation		
Speed		Extra high	High	Low	Extra high	High	Low
Current (A)		0.78-0.79/0.99	0.71-0.71/0.83	0.46-0.48/0.46	0.81-0.82/1.00	0.72-0.73/0.83	0.46-0.49/0.46
Input (W)		169-187/215	154-167/180	97-110/97	176-192/217	156-172/180	97-111/97
Air volume	(m³/h)	350/350	350/350	230/210	350/350	350/320	230/210
	(L/s)	97/97	97/97	64/58	97/97	97/89	64/58
External static pressure	(mmH ₂ O)	15.3/19.4	7.1/5.1	2.6/2.0	15.3/19.4	7.1/5.1	2.7/2.0
	(Pa)	150/190	70/50	25/20	150/190	70/50	26/20
Temperature recovery efficiency (%)		79/79	79/79	84/85	—	—	—
Enthalpy recovery efficiency (%)	Heating	68.5/68.5	68.5/68.5	75.5/76.5	—	—	—
	Cooling	65.5/65.5	65.5/65.5	72/73	—	—	—
Noise (dB) (Measured at 1.5m under the center of the unit)		31-32/32.5	28-30/27	23-24/21	31.5-32.5/33.5	28-30/28	23-24/21
Weight (kg)		30					
Starting current		Under 1.6/1.5A or less					

LGH-50RX3-E

Model		LGH-50RX3-E					
Power source		Single phase 220-240V ~50Hz/220V~60Hz					
Ventilation mode		Lossnay ventilation			Bypass ventilation		
Speed		Extra high	High	Low	Extra high	High	Low
Current (A)		0.94-0.95/1.21	0.89-0.90/1.05	0.57-0.60/0.60	0.95-0.96/1.22	0.90-0.93/1.05	0.58-0.60/0.60
Input (W)		204-225/262	193-214/231	123-142/130	206-228/263	196-221/228	125-142/130
Air volume	(m³/h)	500/500	500/500	350/300	500/500	500/500	350/300
	(L/s)	139/139	139/139	97/83	139/139	139/139	97/83
External static pressure	(mmH ₂ O)	15.3/20.4	6.1/6.1	3.1/2.0	15.3/20.4	6.1/6.1	3.1/2.0
	(Pa)	150/200	60/60	30/20	150/200	60/60	30/20
Temperature recovery efficiency (%)		77/77	77/77	82/83.5	—	—	—
Enthalpy recovery efficiency (%)	Heating	67/67	67/67	73/75	—	—	—
	Cooling	61.5/61.5	61.5/61.5	68/70	—	—	—
Noise (dB) (Measured at 1.5m under the center of the unit)		32.5-33.5/32.5	30-31/28.5	23.5-24.5/23	33.5-34.5/33.5	30.5-31.5/29.5	23.5-24.5/23
Weight (kg)		33					
Starting current		Under 1.9/1.7A or less					

LGH-80RX3-E

Model		LGH-80RX3-E					
Power source		Single phase 220-240V ~50Hz/220V~60Hz					
Ventilation mode		Lossnay ventilation			Bypass ventilation		
Speed		Extra high	High	Low	Extra high	High	Low
Current (A)		1.8-1.8/2.1	1.7-1.7/1.9	1.4-1.4/1.5	1.7-1.7/2.0	1.6-1.6/1.8	1.4-1.4/1.4
Input (W)		392-418/455	368-396/405	304-332/315	370-394/425	348-374/390	298-330/305
Air volume	(m ³ /h)	800/800	800/800	670/660	800/800	800/800	670/660
	(L/s)	222/222	222/222	186/183	222/222	222/222	186/183
External static pressure	(mmHzO)	14.3/23.5	10.2/12.2	7.1/8.2	14.3/23.5	10.2/12.2	7.1/8.2
	(Pa)	140/230	100/120	70/80	140/230	100/120	70/80
Temperature recovery efficiency (%)		78/78	78/78	80.5/81	—	—	—
Enthalpy recovery efficiency (%)	Heating	71/71	71/71	73/73.5	—	—	—
	Cooling	64.5/64.5	64.5/64.5	68/68.5	—	—	—
Noise (dB) (Measured at 1.5m under the center of the unit)		33.5-34.5/35	32-33/31	30-31/29	34.5-35.5/36	33-34/32	30.5-31.5/29.5
Weight (kg)		61					
Starting current		Under 3.8/3.1A or less					

LGH-100RX3-E

Model		LGH-100RX3-E					
Power source		Single phase 220-240V ~50Hz/220V~60Hz					
Ventilation mode		Lossnay ventilation			Bypass ventilation		
Speed		Extra high	High	Low	Extra high	High	Low
Current (A)		2.3-2.3/2.8	2.3-2.3/2.6	2.2-2.2/1.7	2.3-2.3/2.8	2.3-2.2/2.6	2.1-2.1/1.7
Input (W)		500-525/600	495-515/555	465-475/365	505-525/595	500-515/550	455-485/365
Air volume	(m ³ /h)	1000/1000	1000/1000	870/720	1000/1000	1000/1000	870/720
	(L/s)	278/278	278/278	242/200	278/278	278/278	242/200
External static pressure	(mmHzO)	16.3/20.4	10.2/11.2	8.2/6.1	16.3/20.4	10.2/11.2	8.2/6.1
	(Pa)	160/200	100/110	80/60	160/200	100/110	80/60
Temperature recovery efficiency (%)		79/79	79/79	81/83	—	—	—
Enthalpy recovery efficiency (%)	Heating	70/70	70/70	73/76	—	—	—
	Cooling	64.5/64.5	64.5/64.5	67/71	—	—	—
Noise (dB) (Measured at 1.5m under the center of the unit)		36-37/36	34-35/34	31.5-32.5/30	37-38/37	35-36/35	33-34/31
Weight (kg)		72					
Starting current		Under 5.7/5.0A or less					

LGH-150RX3-E

Model		LGH-150RX3-E					
Power source		Single phase 220-240V ~50Hz/220V~60Hz					
Ventilation mode		Lossnay ventilation			Bypass ventilation		
Speed		Extra high	High	Low	Extra high	High	Low
Current (A)		3.3-3.3/4.2	3.1-3.1/3.7	2.7-2.8/2.9	3.2-3.2/4.2	3.0-3.0/3.7	2.6-2.6/2.9
Input (W)		720-785/915	670-730/805	585-660/630	695-760/905	650-705/800	565-615/630
Air volume	(m ³ /h)	1500/1500	1500/1500	1200/1200	1500/1500	1500/1500	1200/1200
	(L/s)	417/417	417/417	333/333	417/417	417/417	333/333
External static pressure	(mmHzO)	14.0/21.0	10.2/12.0	5.1/7.0	14.0/21.0	10.2/12.0	5.1/7.0
	(Pa)	137/206	100/118	50/69	137/206	100/118	50/69
Temperature recovery efficiency (%)		79/79	79/79	81/81	—	—	—
Enthalpy recovery efficiency (%)	Heating	72/72	72/72	75/75	—	—	—
	Cooling	65.5/65.5	65.5/65.5	69/69	—	—	—
Noise (dB) (Measured at 1.5m under the center of the unit)		36.5-37.5/37	35.5-36.5/36	32.5-33.5/33	36.5-37.5/37	35.5-36.5/36	32.5-33.5/33
Weight (kg)		154					
Starting current		Under 6.8/5.9A or less					

LGH-200RX3-E

Model		LGH-200RX3-E					
Power source		Single phase 220-240V ~50Hz/220V~60Hz					
Ventilation mode		Lossnay ventilation			Bypass ventilation		
Speed		Extra high	High	Low	Extra high	High	Low
Current (A)		4.6-4.3/5.4	4.6-4.3/5.2	4.1-3.8/3.3	4.4-4.2/5.3	4.4-4.1/5.0	4.1-3.8/3.3
Input (W)		1000-1020/1175	995-1020/1130	900-905/735	960-995/1155	955-975/1090	885-900/720
Air volume	(m ³ /h)	2000/2000	2000/2000	1400/1400	2000/2000	2000/2000	1400/1400
	(L/s)	556/556	556/556	389/389	556/556	556/556	389/389
External static pressure	(mmHzO)	14.0/20.0	8.2/9.0	8.5/7.0	14.0/20.0	8.2/9.0	8.5/7.0
	(Pa)	137/196	80/88	83/69	137/196	80/88	83/69
Temperature recovery efficiency (%)		79/79	79/79	83/83	—	—	—
Enthalpy recovery efficiency (%)	Heating	70/70	70/70	76/76	—	—	—
	Cooling	64.5/64.5	64.5/64.5	71/71	—	—	—
Noise (dB) (Measured at 1.5m under the center of the unit)		39-40/38.5	37-38/36.5	35.5-36.5/34.5	39.5-40.5/38.5	37.5-38.5/36.5	36-37/34.5
Weight (kg)		179					
Starting current		Under 13.0/9.7A or less					

4. Sample Installations

LGH-15RX3-E to 100RX3-E

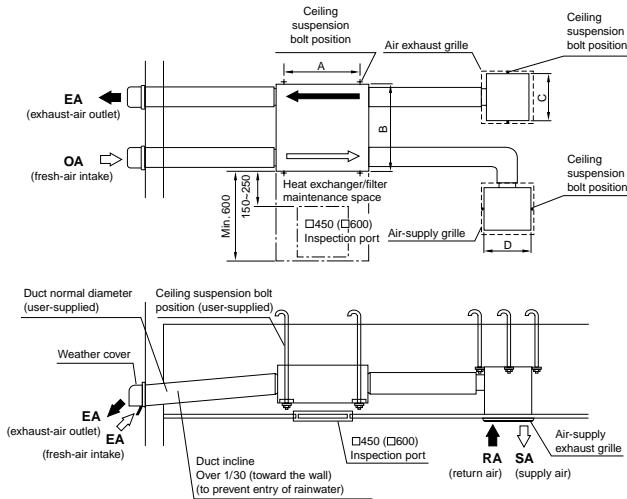

- An inspection port (□450 or □600) must be installed on the filter and Lossnay Core removing side.
- Provide heat insulation to prevent moisture condensation along the two outside ducts (fresh-air intake and exhaust-air outlet).
- Ceiling installation hardware can be attached to the top of the unit. (models LGH-35 to 100RX3-E)
- Do not use vent caps or round hoods in places directly exposed to rain.

(Unit: mm)

	A	B	C	D
LGH-15RX3-E	700	641	334	334
LGH-25RX3-E	700	765	334	334
LGH-35RX3-E	790	906	334	334
LGH-50RX3-E	790	1,048	414	414
LGH-80RX3-E	1,030	1,036	414	414
LGH-100RX3-E	1,030	1,263	414	414

Installation conditions:

- Ambient conditions: Temperature -10°C to +40°C, relative humidity less than 80%. When condensation is expected to form, heat up the outside air using a duct heater, etc.
- Outside air intake conditions: Temperature -15°C to +40°C, relative humidity less than 80%.

LGH-150RX3-E and 200RX3-E

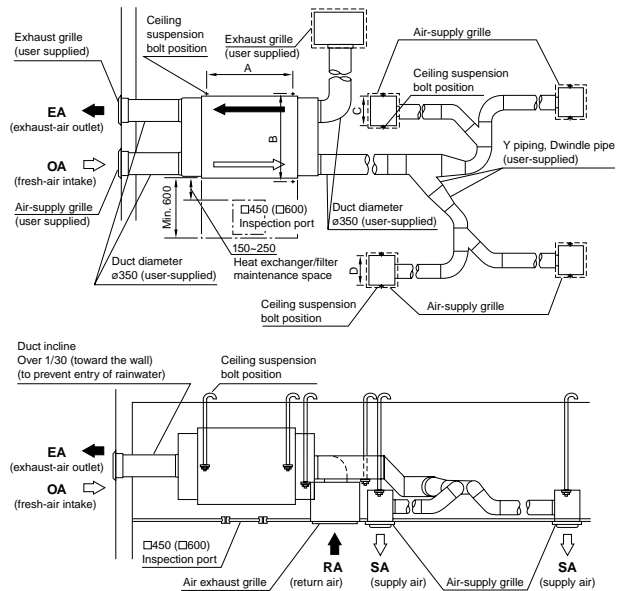

- An inspection port (□450 or □600) must be installed on the filter and Lossnay Core removing side.
- Provide heat insulation to prevent moisture condensation along the two outside ducts (fresh-air intake and exhaust-air outlet).
- Where rain falls directly on the machinery, use the weather cover to prevent entry of rainwater.

(Unit: mm)

	A	B	C	D
LGH-150RX3-E	1,030	1,046	414	414
LGH-200RX3-E	1,030	1,273	414	414

5. Electrical Installations

LGH-15RX3-E to 100RX3-E

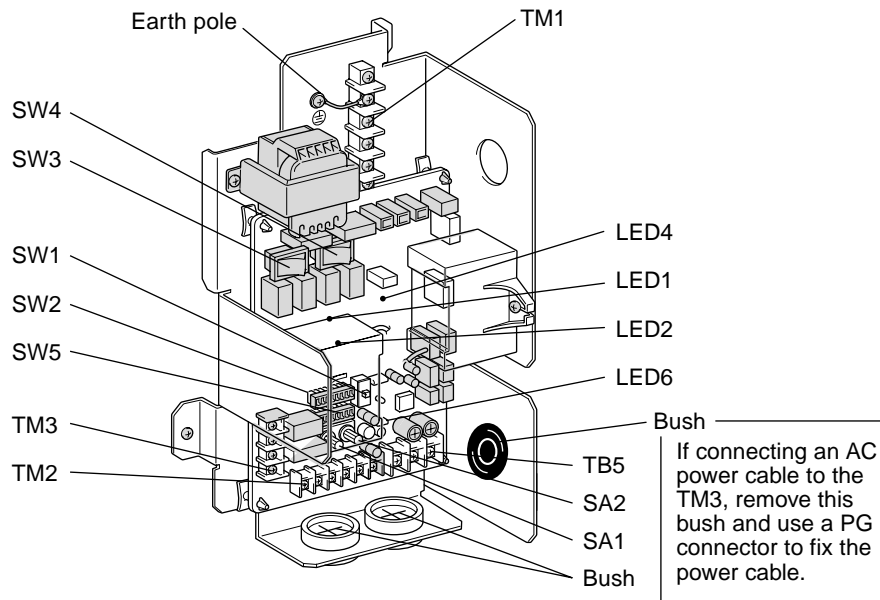

LGH-150RX3-E and 200RX3-E

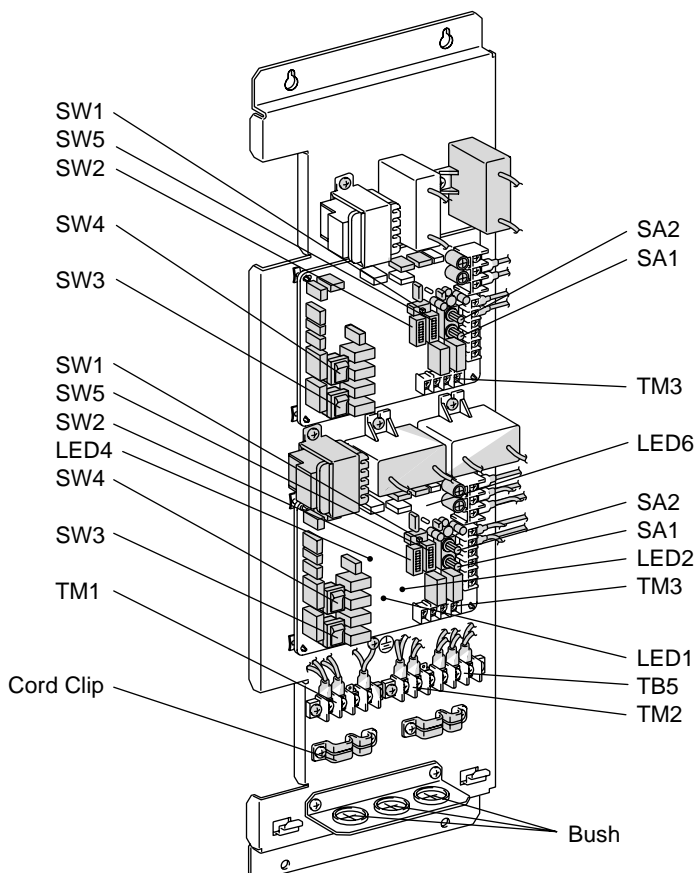

6. Wiring Diagrams

LGH-15RX3-E to 100RX3-E

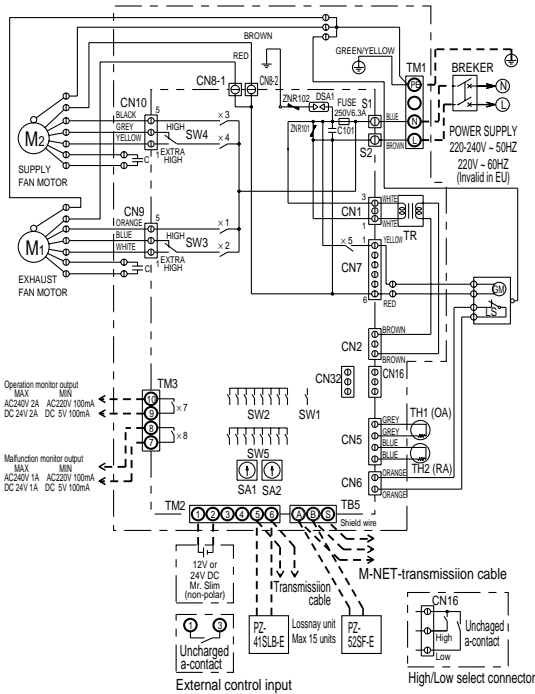

- Connect the wires shown as dotted lines.
- Be sure to connect the grounding wire.
- Breaker should be provided by the customer.

Symbol explanation

M1:	Motor for exhaust fan
M2:	Motor for supply fan
C:	Capacitor
GM:	Motor for Bypass movement
LS:	Microswitch
TH1:	Thermistor for outside air
TH2:	Thermistor for return air
SW1:	Switch (Main/Sub change)
SW2, 5:	Switch (Function selection)
SW3:	High/E. High select switch (Exhaust fan)
SW4:	High/E. High select switch (Supply fan)
TM1:	Terminal block (Power supply)
TM2:	Terminal block (Transmission cable and external control input)
TM3:	Terminal block (Monitor output)
TB5:	Terminal block (M-NET Transmission cable)
S1, S2:	Connector (Power supply)
TR:	Control circuit transformer
X7:	Relay contact (for operation monitor output)
X8:	Relay contact (for malfunction monitor output)
CN1:	Connector (Transformer primary)
CN2:	Connector (Transformer secondary)
CN5:	Connector (Thermistor)
CN6:	Connector (Microswitch)
CN7:	Connector (Motor for bypass operation)
CN8-1:	Tab connector (Fan motor)
CN8-2:	Tab connector (Fan motor)
CN9:	Connector (Fan motor)
CN10:	Connector (Fan motor)
CN16:	Connector (High/Low switch)
CN32:	Connector (Remote control selection)
SA1:	Address setting rotary switch (10 digit)
SA2:	Address setting rotary switch (1 digit)
LED1:	Inspection indicator lamp
LED2:	Inspection indicator lamp
LED4:	Power supply indicator lamp
LED6:	M-NET indicator lamp
MARK	⊙ : Indicates terminal block ⊕ : Connector ⊞ : Board insertion connector or fastening connector of control board

LGH-150RX3-E and 200RX3-E

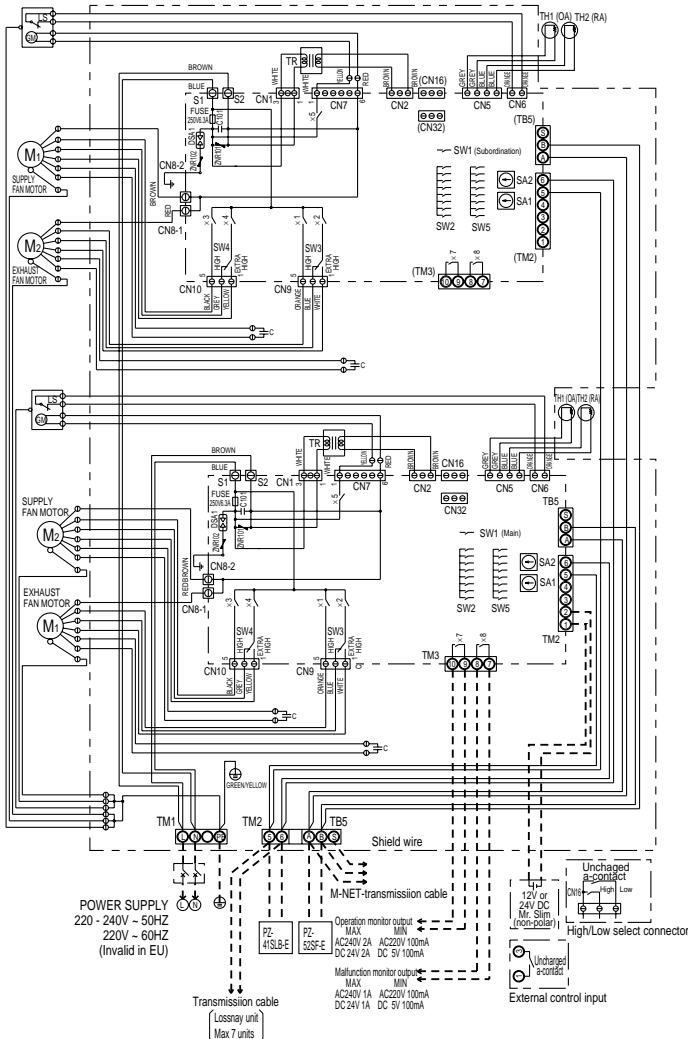

- PZ-41SLB-E and PZ-52SF-E cannot be used simultaneously.

BC controller

CMB-P-V-F
CMB-P-V-FA
CMB-P-V-FB

CONTENTS

1. Specifications	II -222
2. External Dimension	II -224
3. Wiring Diagrams	II -227
4. Refrigerant circuit	II -233

1. Specifications

Model name		CMB-P104V-F	CMB-P105V-F	CMB-P106V-F	CMB-P108V-F	CMB-P1010V-F	CMB-P1013V-F	CMB-P1016V-F
Number of branch		4	5	6	8	10	13	16
Power source		~220/230/240V 50Hz/60Hz						
Power input	kW	0.068	0.083	0.098	0.128	0.158	0.203	0.248
Current	A	0.31/0.30/0.28	0.38/0.36/0.35	0.45/0.43/0.41	0.58/0.56/0.53	0.72/0.69/0.66	0.92/0.88/0.85	1.13/1.08/1.03
External finish		Galvanizing						
Indoor unit capacity connectable to 1 branch		Model 80 or smaller •Use optional joint pipe combining 2-branch when the total unit capacity exceeds 81. •Use the reducer (standard accessory) when the indoor unit Model 40 or smaller is connected.						
Height	mm	284						
Width	mm	362 + 70 (control box)						
Depth	mm	648					1098	
Refrigerant piping diameter	To outdoor unit	High pressure pipe	φ19.05 Brazed					
		Low pressure pipe	200type : φ25.4 Brazed 250type : φ28.58 Brazed					
	To indoor unit	Liquid pipe	φ9.52 Flare (φ6.35 with attached reducer used, φ12.7 with optional joint pipe used)					
		Gas pipe	φ15.88 Flare (φ12.7 with attached reducer used, φ19.05 with optional joint pipe used)					
Drain pipe		VP-25						
Net weight	kg	24	27	29	34	39	47	54
Accessories		•Drain connection pipe (with flexible hose and insulation) •Reducer						

Note: 1.Works not included : Installation/foundation work, electrical connection work, duct work, insulation work, power source switch and other items not specified in this specification.

Model name		CMB-P108V-FA	CMB-P1010V-FA	CMB-P1013V-FA	CMB-P1016V-FA	CMB-P108V-FB
Number of branch		8	10	13	16	8
Power source		~220/230/240V 50Hz/60Hz				
Power input	kW	0.138	0.168	0.213	0.258	0.128
Current	A	0.63/0.60/0.58	0.76/0.73/0.70	0.97/0.93/0.89	1.17/1.12/1.08	0.58/0.56/0.53
External finish		Galvanizing				
Indoor unit capacity connectable to 1 branch		<p>Model 80 or smaller</p> <ul style="list-style-type: none"> •Use optional joint pipe combining 2-branch when the total unit capacity exceeds 81. •Use the reducer (standard accessory) when the indoor unit Model 40 or smaller is connected. 				
Height	mm	289				284
Width	mm	450 + 70 (control box)				362 + 70 (control box)
Depth	mm	1110				648
Refrigerant piping diameter	To outdoor unit	High pressure pipe	ø25.4 Brazed			
		Low pressure pipe	ø34.93 Brazed			
	To indoor unit	Liquid pipe	ø9.52 Flare (ø6.35 with attached reducer used, ø12.7 with optional joint pipe used)			
		Gas pipe	ø15.88 Flare (ø12.7 with attached reducer used, ø19.05 with optional joint pipe used)			
	To another BC controller	Low press gas pipe	ø28.58 Brazed			
		High press gas pipe	ø19.05 Brazed			
Liquid pipe		ø12.7 Brazed				
Drain pipe		VP-25				
Net weight	kg	44	49	57	64	32
Accessories		<ul style="list-style-type: none"> •Drain connection pipe (with flexible hose and insulation) •Reducer 				

Note: 1.Works not included : Installation/foundation work, electrical connection work, duct work, insulation work, power source switch and other items not specified in this specification.

CMB-P108V-FB

Unit : mm

- <Accessories>
- Reducer(Large, Small).....Quantity for all connections
 - Drain hose(VP-25 connector).....1pc.
 - Pipe cover for drain hose.....1pc.
 - Hose band.....1pc.
 - Tie band.....2pcs.
- Note1. Suspension bolt($\phi 10$), washer(M10), and nut(M10) prepare in the field.

2. Take notice of service space as follows.
(Please give attention not to occupy service space by letting ducts and pipes through.)
3. Can't use singleness.(MASTER BC CONTROLLER is necessary.)

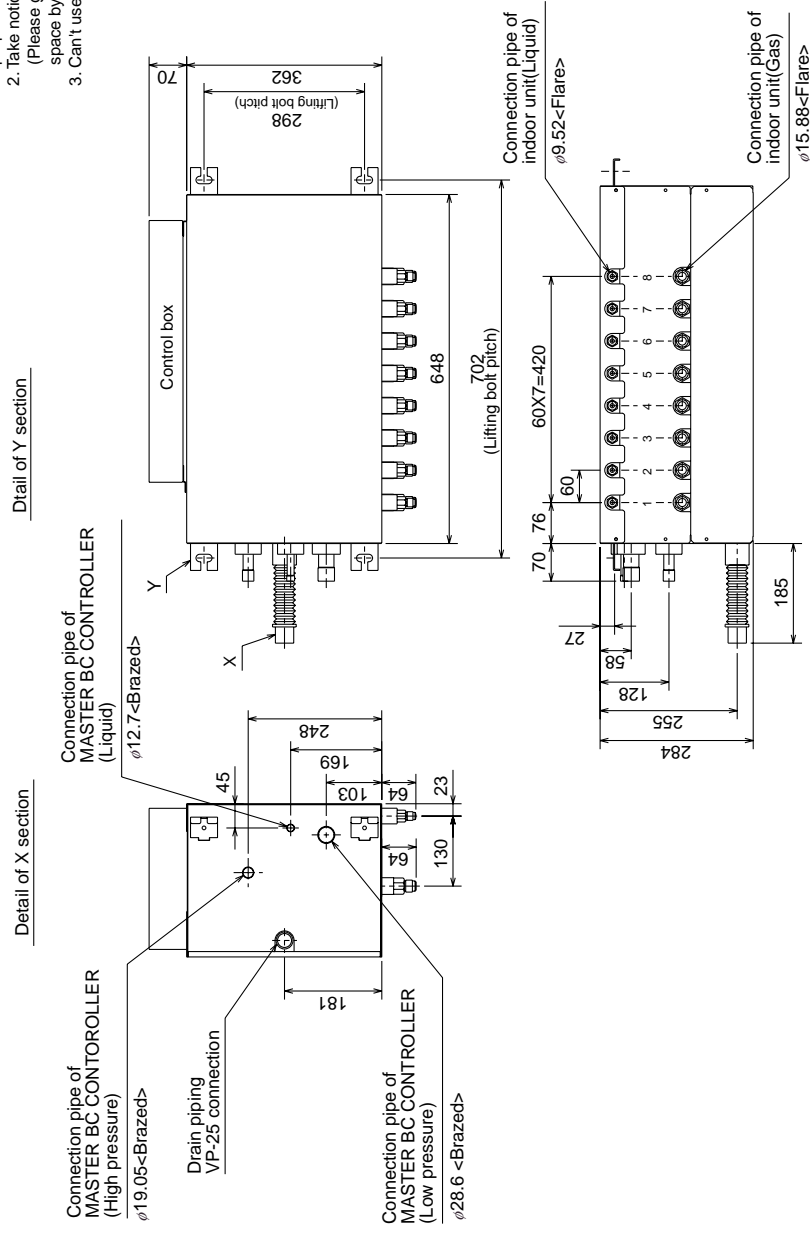
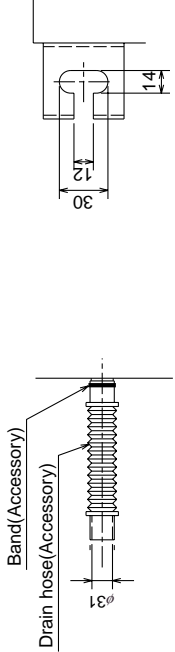

3. Wiring Diagrams

CMB-P104, P105, P106V-F

Symbol explanation

Symbol	Name
TR	Transformer
TH11,12,15,16	Thermister sensor
LEV1,3	Expansion valve
PS1,3	Pressure sensor
TB0	Terminal block (for power source)
TB02	Terminal block (for transmission)
SV1-6A	Solenoid valve
SV1-6B	Solenoid valve
SV1-6C	Solenoid valve
T1-6	Terminal
F01	Fuse AC250V 6.3A F

Note: TB02 is terminal block for transmission.
Never connect power line to it.

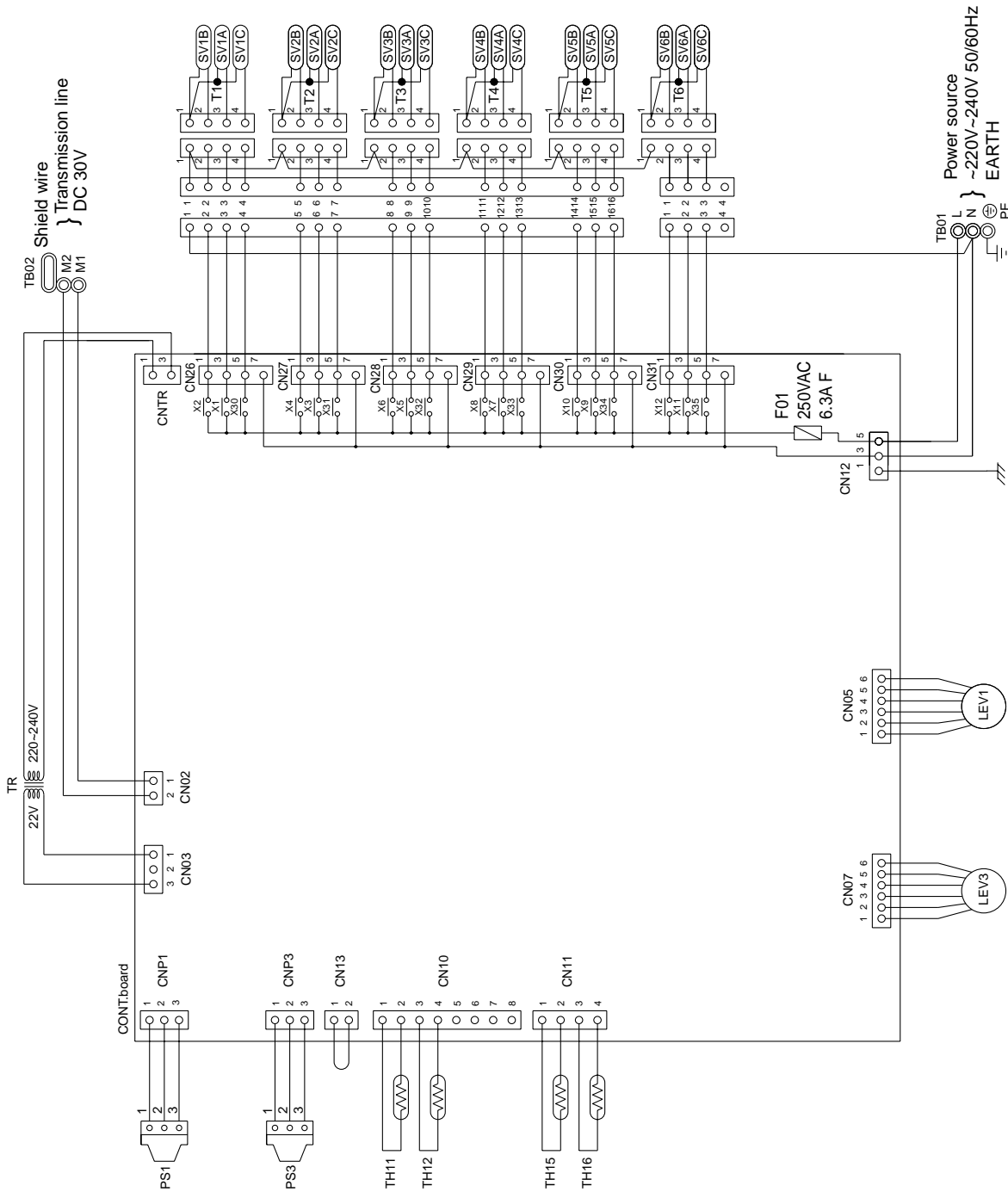

CMB-P108, P1010V-F

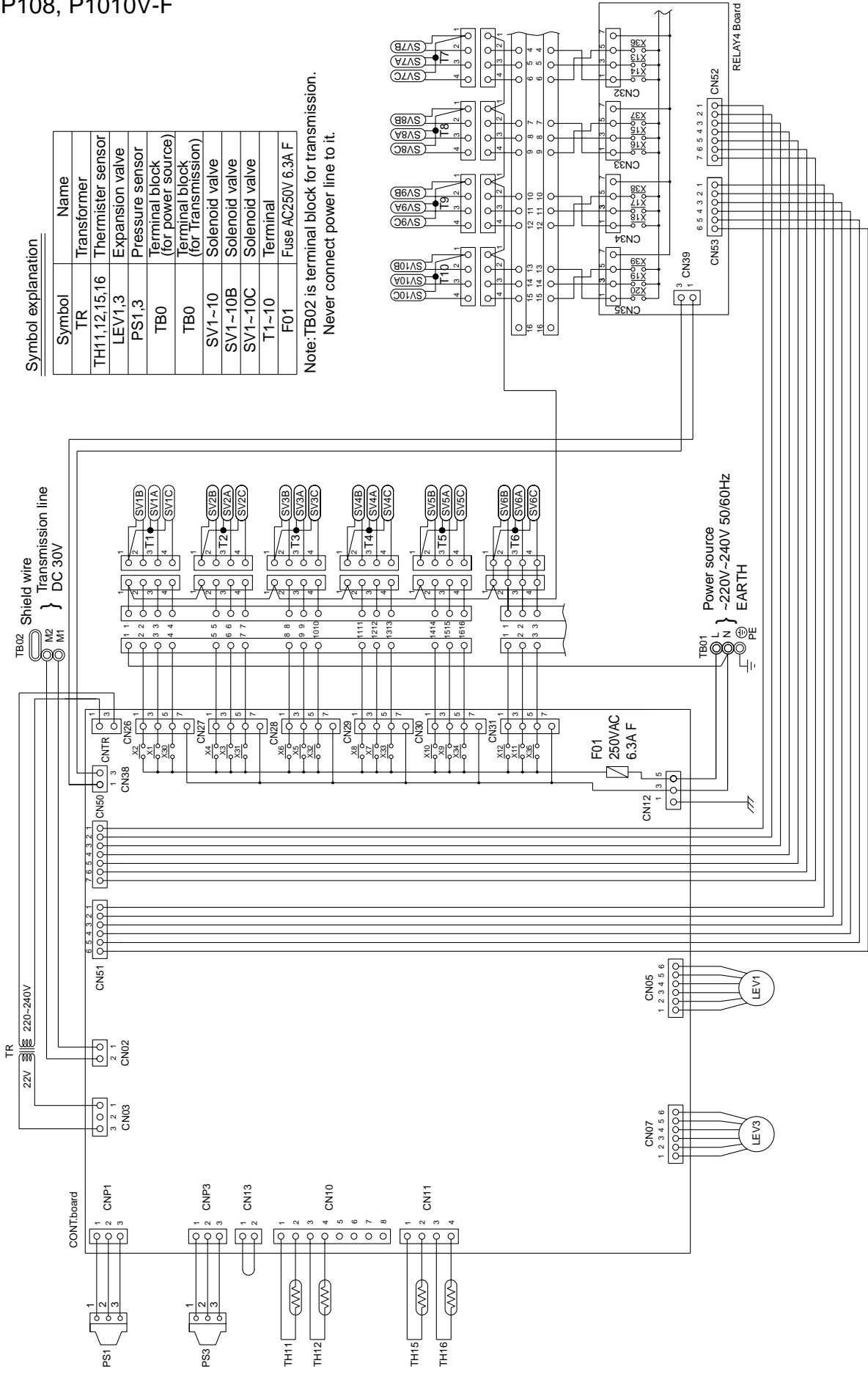

Symbol explanation

Symbol	Name
TR	Transformer
TH1,12,15,16	Thermister sensor
LEV1,3	Expansion valve
PS1,3	Pressure sensor
TB0	Terminal block (for power source)
TB0	Terminal block (for transmission)
SV1~10	Solenoid valve
SV1~10B	Solenoid valve
SV1~10C	Solenoid valve
T1~10	Terminal
F01	Fuse AC250V 6.3A F

Note: TB02 is terminal block for transmission.
Never connect power line to it.

CMB-P1013, P1016V-F

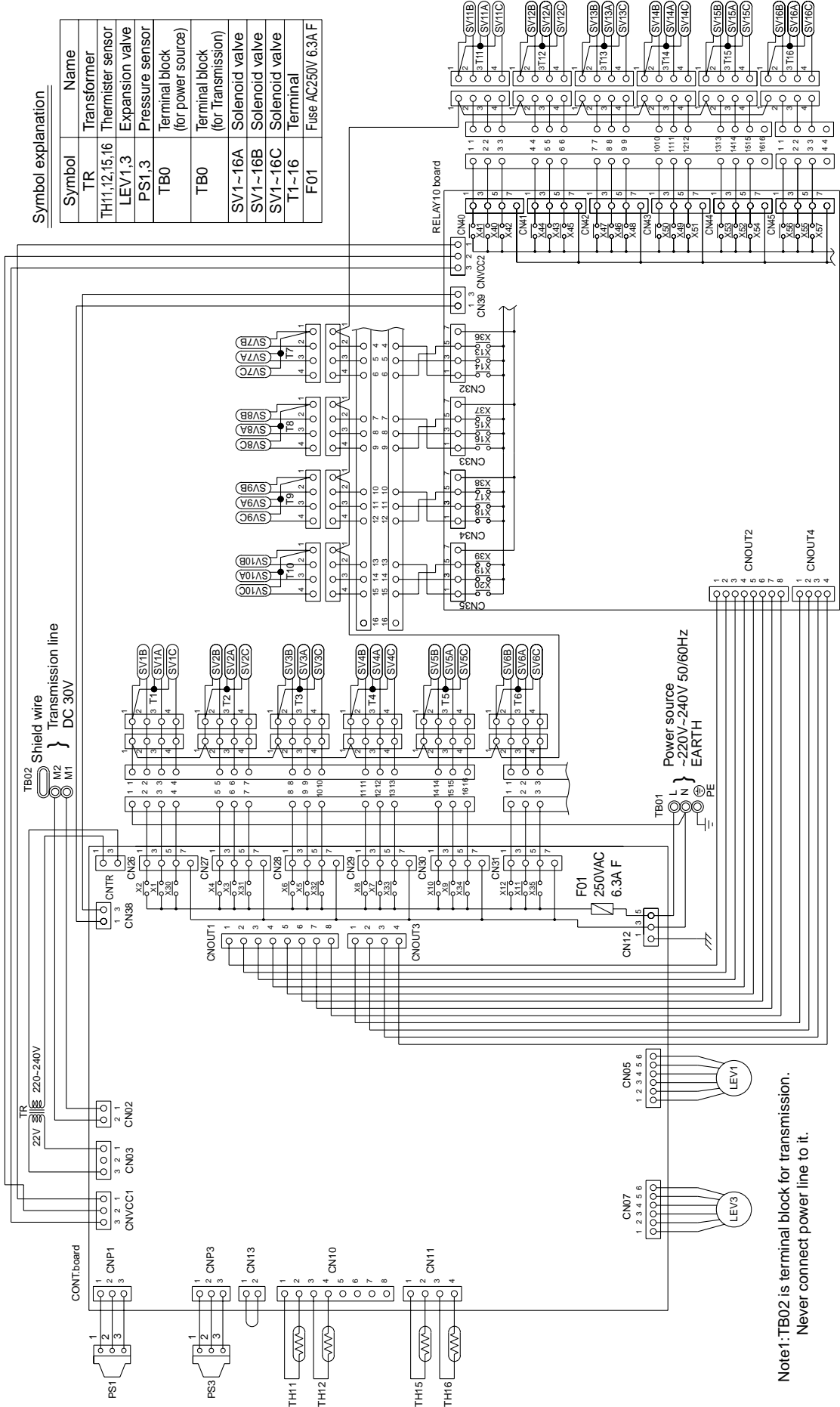

Note1: TB02 is terminal block for transmission.
Never connect power line to it.

CMB-P108, 1010V-FA

Symbol explanation

Symbol	Name
TR	Transformer
TH11,12,15,16	Thermister sensor
LEV1,3	Expansion valve
PS1,3	Pressure sensor
TB0	Terminal block (for power source)
TB02	Terminal block (for Transmission)
SV1~10A	Solenoid valve
SV1~10B	Solenoid valve
SV1~10C	Solenoid valve
SVM1,2	Solenoid valve
T1~10	Terminal
F01	Fuse AC250V 6.3A F

Note: TB02 is terminal block for transmission.
Never connect power line to it.

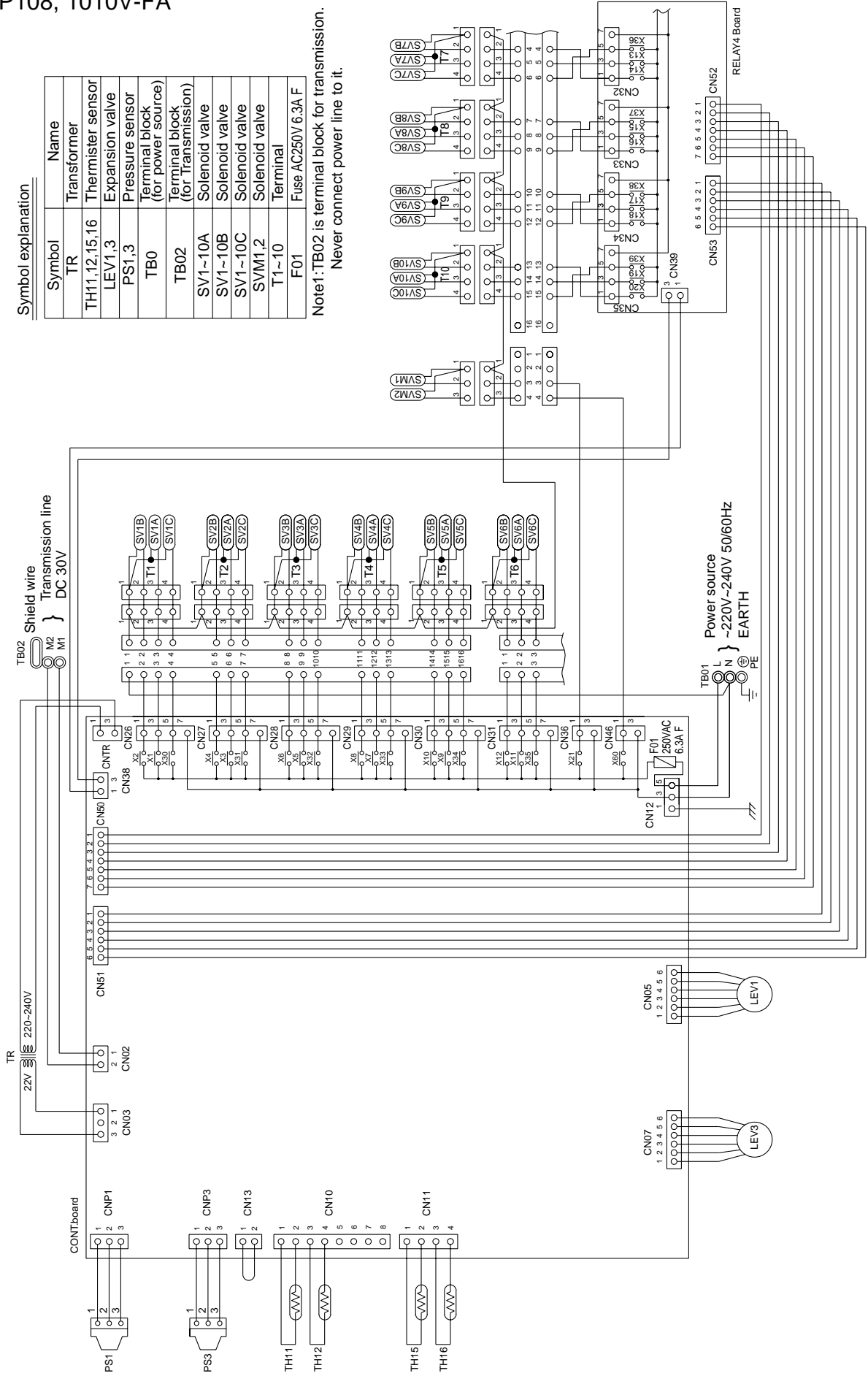

CMB-P1013, P1016V-FA

Symbol explanation

Symbol	Name
TR	Transformer
TH1,12,15,16	Thermister sensor
LEV1,3	Expansion valve
PS1,3	Pressure sensor
TB0	Terminal block (for power source)
TB0	Terminal block (for Transmission)
SV1~16A	Solenoid valve
SV1~16B	Solenoid valve
SV1~16C	Solenoid valve
SVM1,2	Solenoid valve
T1~16	Terminal
F01	Fuse AC250V 6.3A F

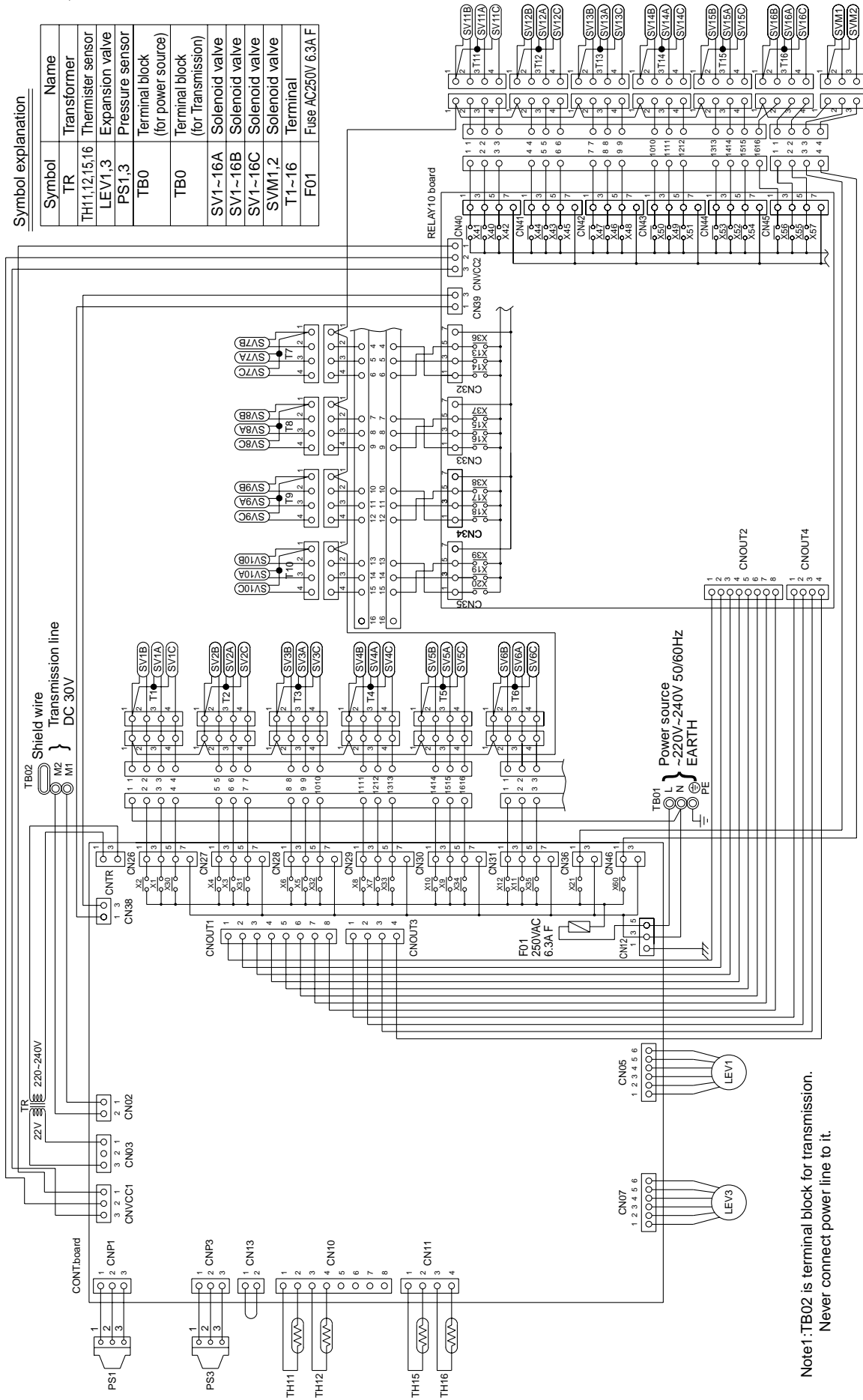

Note1: TB02 is terminal block for transmission.
Never connect power line to it.

RC controller

CMB-P108V-FB

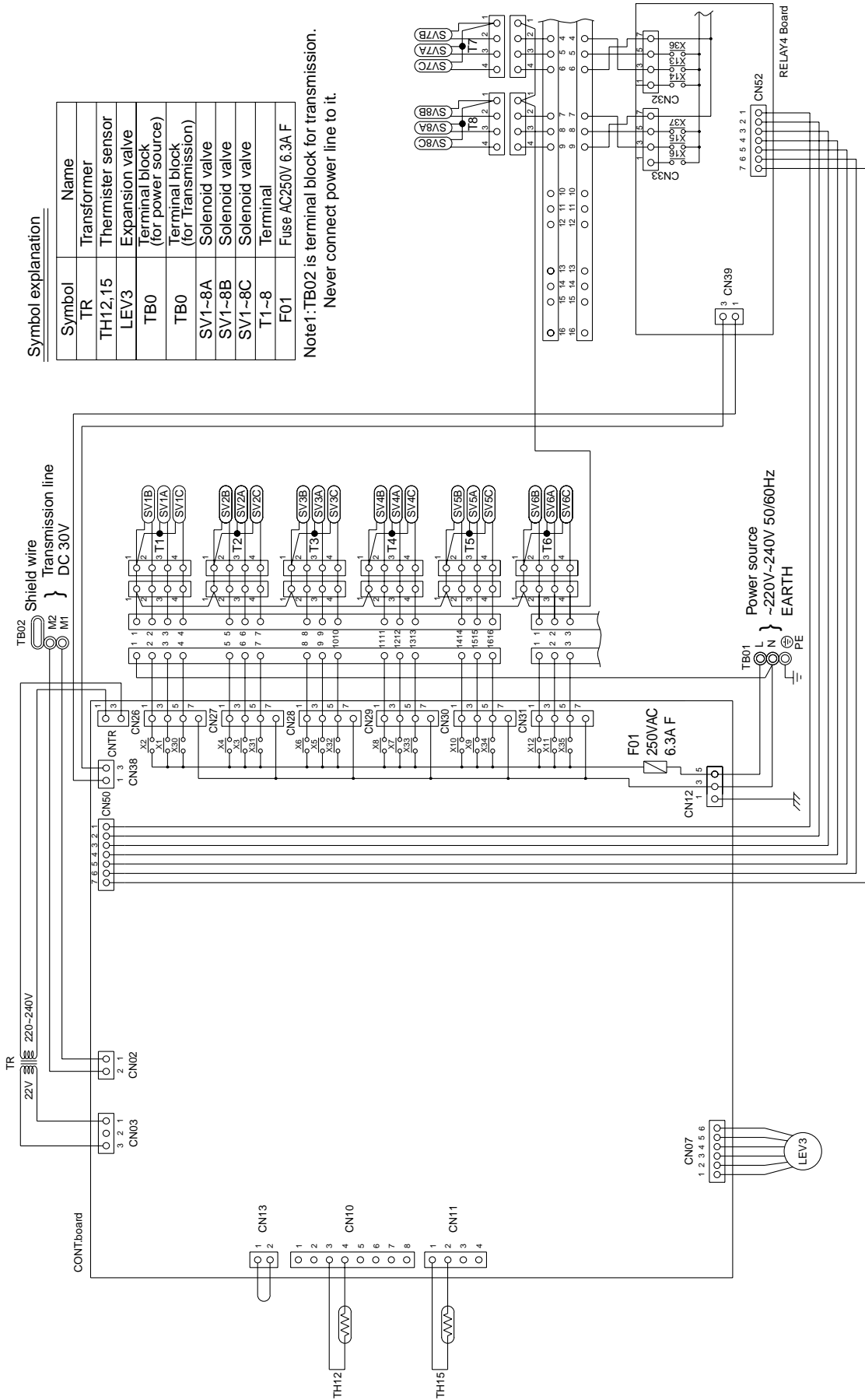

Symbol explanation

Symbol	Name
TR	Transformer
TH12,15	Thermister sensor
LEV3	Expansion valve
TB0	Terminal block (for power source)
TB0	Terminal block (for Transmission)
SV1-8A	Solenoid valve
SV1-8B	Solenoid valve
SV1-8C	Solenoid valve
T1-8	Terminal
F01	Fuse AC250V 6.3A F

Note1:TB02 is terminal block for transmission.
Never connect power line to it.

4. Refrigerant Circuit

CMB-P104, P105, P106, P108, P1010, P1013, P1016V-F

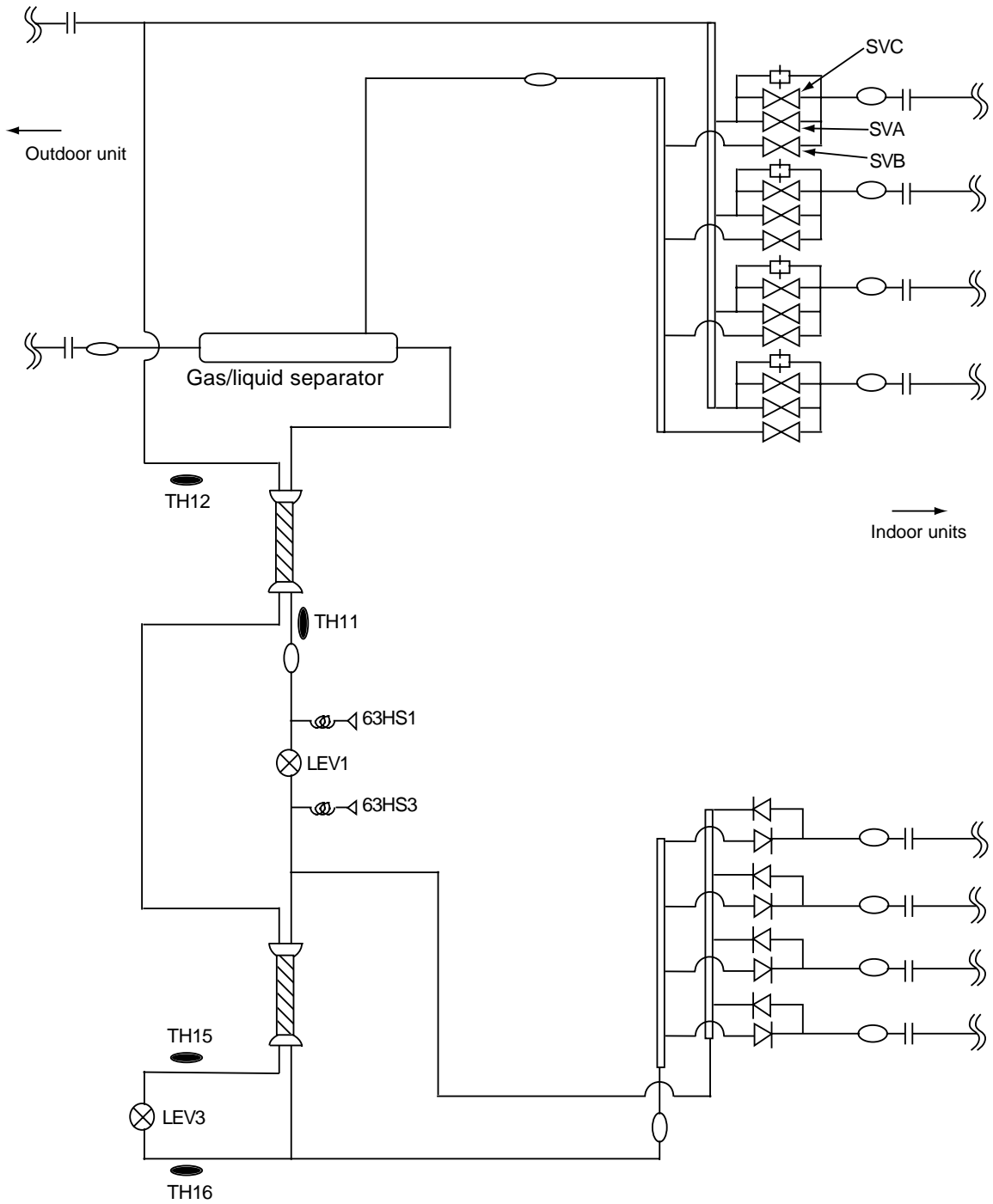

BC controller

CMB-P108, P1010, P1013, P1016V-FA

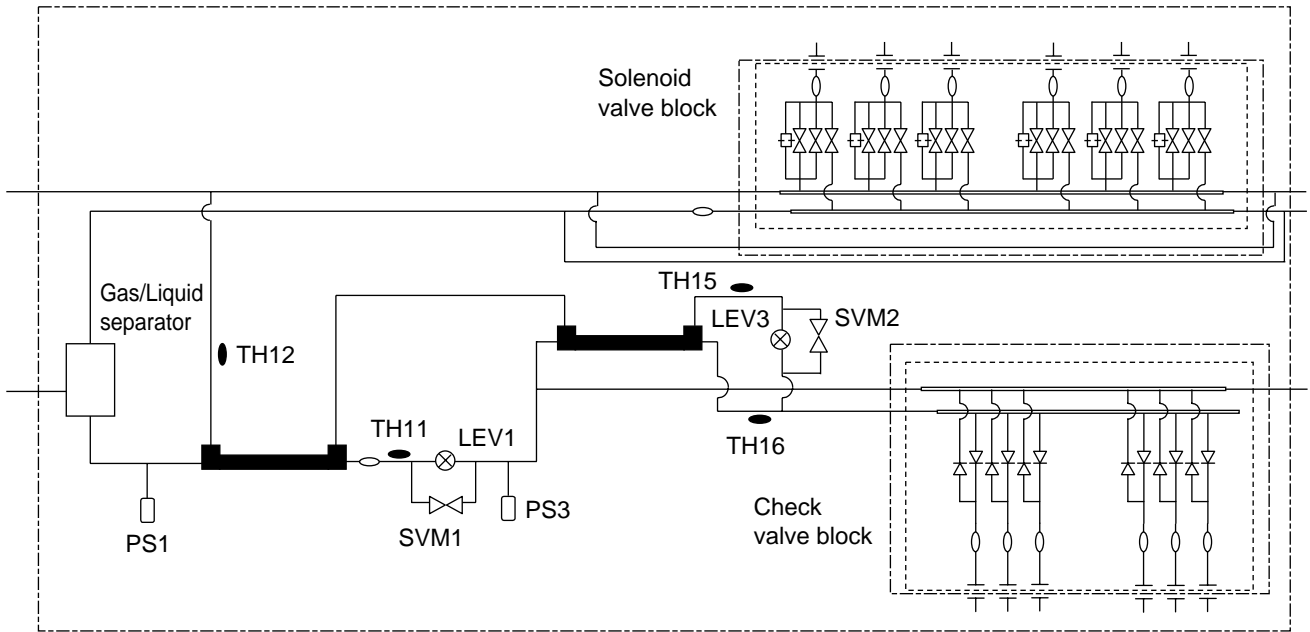

CMB-P108V-FB

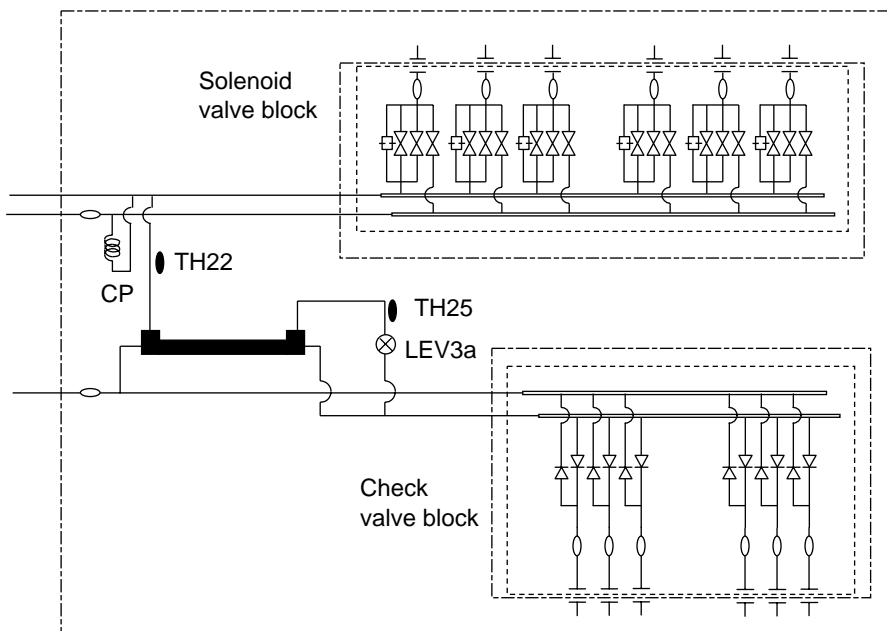

BC controller

CITY MULTI Controller

CONTENTS

1. Function table of controllers	III-2
2. Local remote controller	
2-1 Wired remote controller	PAR-20MAA III-3
	PAR-F27MEA III-4
2-2 Simple remote controller	PAC-SE51CRA III-5
2-3 Simple MA controller	PAC-YT51CRA III-6
2-4 Wireless remote controller	PAR-FL31MA III-7
	PAR-FA31MA
2-5 LOSSNAY remote controller	PZ-52SF-E III-8
2-6 Program timer	PAC-YT32PTA III-9
3. System controller	
3-1 Group remote controller	PAC-SC30GRA..... III-10
3-2 System remote controller	PAC-SF44SRA..... III-12
3-3 Schedule timer	PAC-YT34STA III-14
3-4 ON/OFF remote controller	PAC-YT40ANRA III-16
3-5 Centralized controller	G-50A III-18
	TG-2000A..... III-24
	MB-300..... III-28
3-6 Air conditioner interface	LMAP02-E III-34
3-7 Power supply unit	PAC-SC34KUA III-36
	PAC-SC50KUA III-37
3-8 Transmission booster unit	PAC-SF46EPA III-38
4. System component	III-39

1. Function table of controllers

Model	Local remote controller								MELANS series (Man-machine type)				Interface type Air conditioner interface
	Remote controller		Simple remote controller	Wireless remote controller	ON/OFF remote controller	Group remote controller	System remote controller	Schedule timer	Centralized controller				
	PAR-20MAA	PAR-F27MEA	PAC-SE51CRA	PAR-FL31MA	PAC-YT40ANRA	PAC-SC30GRA	PAC-SF44SRA	PAC-YT34STA	G-50A	TG-2000A	LMAP02-E		
No. of units controllable (Groups (G) / units)	1G/16units	1G/16units	1G/16units	1G/16units	16/50	8G/16units	50/50	50G/50U	50G/50units G-50A browser *4	2000G/2000units *7	50G/50units		
Operation	Start / Stop	○	○	○	○	⊙	⊙	⊙	⊙	⊙	⊙		
	Operation mode	○	○	×	○	×	⊙	⊙	×	⊙	⊙		
	Temperature setting	○	○	○	○	×	⊙	⊙	×	⊙	⊙		
	Permit / Prohibit direction	×	×	×	×	×	×	⊙	×	⊙	⊙		
	Fan speed	○	○	○	○	×	⊙	⊙	×	⊙	⊙		
	Air flow direction	○	○	×	○	×	⊙	⊙	×	⊙	⊙		
Monitoring	Status	○	○	○	○	×	⊙	○	×	⊙	⊙		
	Error flashing	○	○	○	○	○	○	○	○	○	○		
	Error content	○	○	○	×	○	○	○	○	○	○		
	Filter sign	○	○	×	×	×	○	○	×	○	○		
	Operating hour	×	×	×	×	×	×	×	×	×	●		
	Operation mode	○	○	○	○	×	○	○	×	○	○		
	Setting temperature	○	○	○	○	×	○	○	×	○	○		
	Indoor temperature (intake)	○	○	×	×	×	○	×	×	○	○		
	Permit / Prohibit	○	○	○	○	×	○	○	×	○	○		
	Fan speed	○	○	○	○	×	○	○	×	○	○		
Air flow direction	○	○	×	○	×	○	○	×	○	○			
Scheduling	Weekly	×/○ ^{*1}	×/○ ^{*1}	×	×	×	×/⊙ ^{*1}	×	○	○	●		
	Annual (Designated day setting)	×	×	×	×	×	×	×	×	×	●		
	One day	×	×	×	×	×	×	×	×	×	●		
	Times of stops / Starts per day	1/1 / 48 ^{*1}	1/1 / 48 ^{*1}	×	1/1	×	×/48 ^{*1}	×	16	3/3	12		
	Times of stops / Starts per week	×	×	×	×	×	×/336 ^{*1}	×	112	21/21	84		
	Auto off timer	×	○	×	×	×	×	×	×	×	×		
	Minimum setting unit (minutes)	10/30 ^{*1}	10/30 ^{*1}	×	10	×	×/30 ^{*1}	×	5	10	1		
Recording	Error history	×	×	×	×	×	○	○	×	○	○		
	Daily / Monthly reports	×	×	×	×	×	×	×	×	×	○		
	Electricity charges	×	×	×	×	×	×	×	×	×	●		
Others	Set temperature range limit	×	○	×	×	×	×	×	×	×	○ ^{*6}		
	Auto lock	×	○	×	×	×	×	×	×	×	×		
Control and management	Ventilation (group / interlocked)	×/○	×/○	×	×	×	×/○	○	×	○	○/○ ^{*5}		
	Group setting	× ^{*3}	○	×	×	×	○	○	×	○	○ ^{*5}		
	Block setting	×	×	×	×	×	×	×	×	×	○ ^{*5}		
	Revision of electricity charges	×	×	×	×	×	×	×	×	×	■		
Operation Ventilation (group / interlocked)	Start / Stop	-/○	-/○	-/○	-/○	×	-/⊙	⊙/⊙	×	⊙/⊙	⊙/⊙		
	Fan speed	-/○	-/○	-/×	-/×	×	-/○	⊙/⊙	×	⊙/⊙	○/○		
	Ventilation mode	-/×	-/×	-/×	-/×	×	-/×	⊙/×	×	⊙/×	⊙/×		
Monitoring Ventilation (group / interlocked)	Status	-/○	-/○	-/×	-/×	×	-/○	○/○	×	⊙/⊙	⊙/⊙		
	Fan speed	-/○	-/○	-/×	-/×	×	-/○	○/○	×	○/○	○/○		
	Ventilation mode	-/×	-/×	-/×	-/×	×	-/×	○/×	×	○/×	○/×		

Specifications vary depending on host system device.

⊙ : Each group / Batched ○ : Each group □ : Depend on the Building management system ■ : Block (City Multi indoor unit only)
 ▲ : Set up by a local remote controller △ : Please inquire × : Not available - : Not used ● : G50 license registration possible.

*1: When PAC-YT32PTA is connected. *2: daily timer availability *3: For group operation, cross-over wiring is required between indoor unit.
 *4: Contact the retailer for questions relating to the browser. *5: Installation possible at Initial setting tool. *6: Ver.4.10 or more.
 *7: Web monitor license is required for G-50.

2. Local remote controller

2-1 Wired remote controller

2-1-1 PAR-20MAA

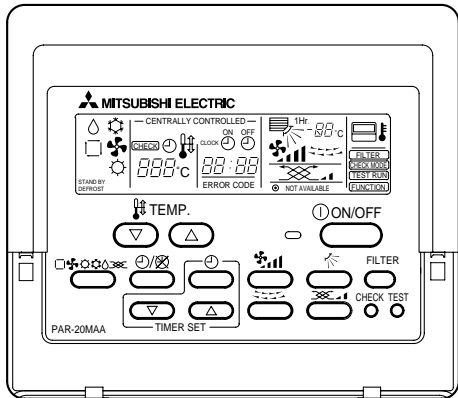

- Group operation is possible without requiring address setting.
 - Usable as the local remote controller for System Controller (MELANS).
 - Remote controller automatically judges the function required for indoor unit such as vane/louver selection.
- (*) For group operation, cross-over wiring is required between indoor units.
- (*) Combined use with M-NET remote controller (F27MEA, Simple R/C, LOSSNAY R/C) can not be conducted inside a group.

■ System example

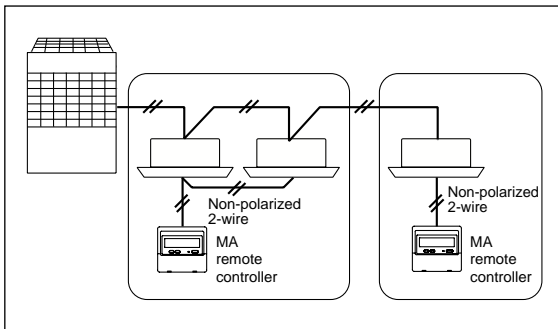

■ External dimension

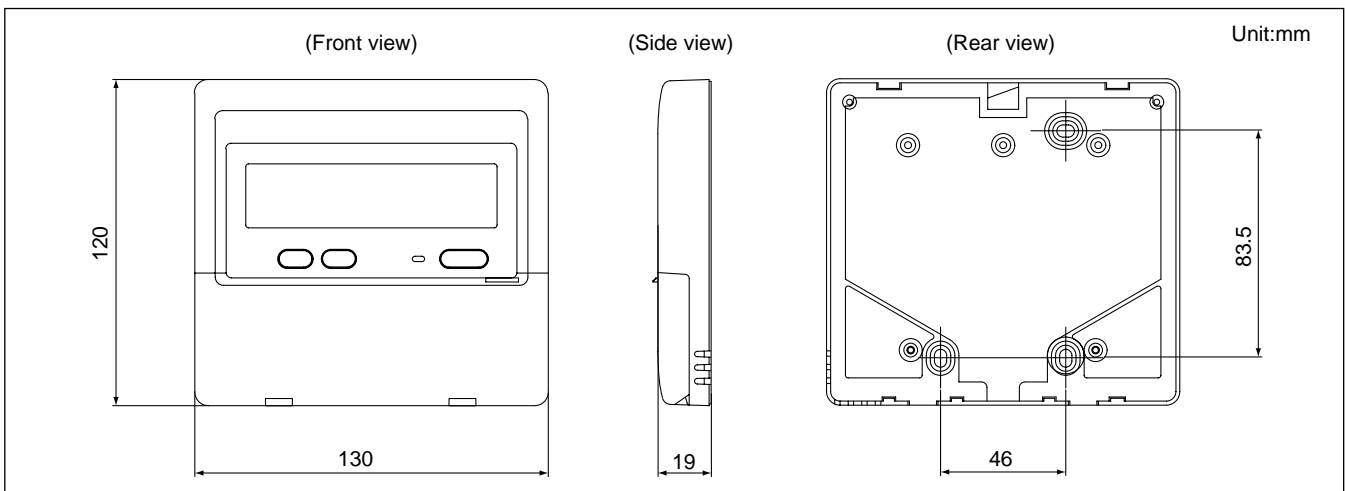

■ Functions

□:Each unit ○:Each group ●:Each block
 △:Each floor ◎:Collective ✕:Not available

Item	Description	Operations	Display
ON/OFF	Run and stop operation for a single group	○	○
Operation mode switching	Switches between Cool / Dry / Auto / Fan / Heat. Operation modes vary depending on the air conditioner unit. Auto mode is the City Multi R2 and WR2 series only.	○	○
Temperature setting	Sets the temperature for a single group Range of temperature setting Cool/Dry : 19°C - 30°C Heat : 17°C - 28°C Auto : 19°C - 28°C	○	○
Fan speed setting	Models with 4 air flow speed settings: Hi/Mid-2/Mid-1/Low Models with 3 air flow speed settings: Hi/Mid/Low Models with 2 air flow speed settings: Hi/Low	○	○
Air flow direction setting	Air flow direction angles 100% - 80% - 60% - 40%, Swing, Louver ON/OFF Air flow direction settings vary depending on the model.	○	○
Timer operation	One ON/OFF setting can be set for one day. By connecting the Program timer, set 48 ON/OFF settings every 30 minutes. By loading only one pattern, it can operate as a weekly schedule.	○	○
Permit / Prohibit local operation	Individually prohibit operation of each local remote control function (Start/Stop, Change operation mode, Set temperature, Reset filter). *1: When the local remote controller inactivation command is received from the master system controller, "- CENTRALLY CONTROLLED -" is displayed.	✕	○ ^{*1}
Prohibition/permission of specified mode (Cooling prohibited /heating prohibited /cooling-heating prohibited)	By the setting from System Controller, the operation for the following modes is prohibited. At cooling prohibited : Cool, Dry, Auto, At heating prohibited : Heat, Auto, At cooling-heating prohibited : Cool, Heat, Dry, Auto	✕	○
Indoor unit intake temperature	Measures the intake temperature of the indoor unit when the indoor unit is operating.	✕	○
Error	When an error is currently occurring on an air conditioner unit, the afflicted unit and the error code are displayed.	✕	□
Test run	This operates air conditioner units in test run mode.	○	○
Ventilation equipment	Up to 16 indoor units can be connected to an interlocked system that has one LOSSNAY. LOSSNAY items that can be set are "Hi" "Low" "Stop". Ventilation mode switching is not available.	○	○
External input/output	By connecting the Program timer "PAC-YT32PTA", a weekly schedule can be controlled. External start/stop control and emergency stop is not supported.	○	○

2-1-2 PAR-F27MEA

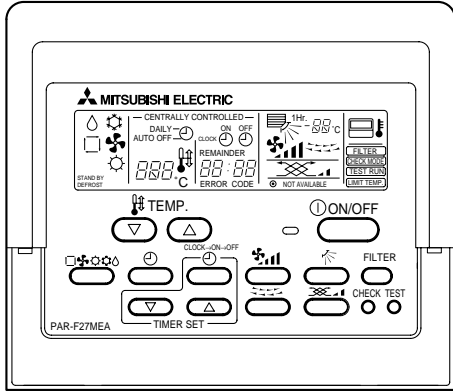

- Three timer modes are prepared by enriching the timer function. The timer mode can selectively be used depending on the application configuration.
- The range of room temperature setting can be limited by the initial setting. By setting the room temperature range narrower than usual setting, cooling/heating operation with excessive temperature can be prevented thus saving energy easily.
- Equipped with simplified button locking function.

System example

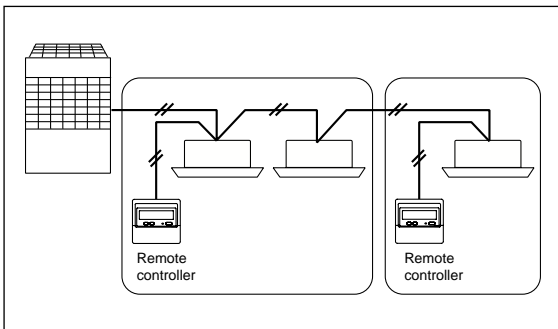

External dimension

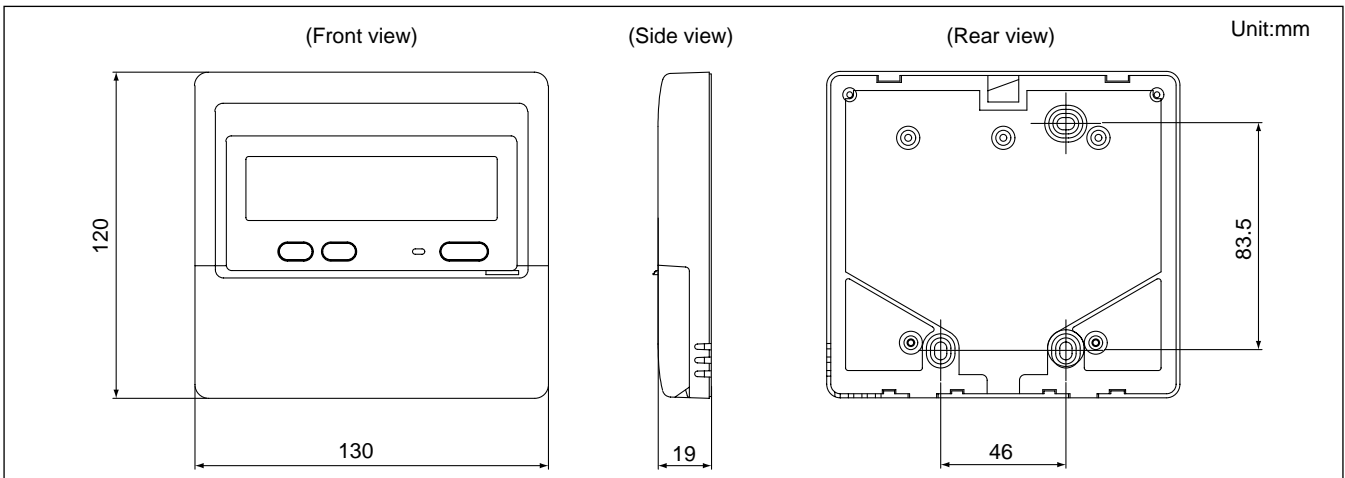

Functions

□: Each unit ○: Each group ●: Each block
 △: Each floor ◎: Collective X: Not available

Item	Description	Operations	Display
ON/OFF	Run and stop operation for a single group	○	○
☐☐☐☐ Operation mode switching	Switches between Cool / Dry / Auto / Fan / Heat. Operation modes vary depending on the air conditioner unit. Auto mode is the City Multi R2 and WR2 series only.	○	○
TEMP. Temperature setting	Sets the temperature for a single group Range of temperature setting Cool/Dry : 19°C - 30°C Heat : 17°C - 28°C Auto : 19°C - 28°C	○	○
Fan speed setting	Models with 4 air flow speed settings: Hi/Mid-2/Mid-1/Low Models with 3 air flow speed settings: Hi/Mid/Low Models with 2 air flow speed settings: Hi/Low	○	○
Air flow direction setting	Air flow direction angles 100% - 80% - 60% - 40%, Swing, Louver ON/OFF Air flow direction settings vary depending on the model.	○	○
Permit / Prohibit local operation	Individually prohibit operation of each local remote control function (Start/Stop, Change operation mode, Set temperature, Reset filter). *1: When the local remote controller inactivation command is received from the master system controller, "- CENTRALLY CONTROLLED -" is displayed.	X	○ ^{#1}
Prohibition/permission of specified mode (Cooling prohibited /heating prohibited /cooling-heating prohibited)	By the setting from System Controller, the operation for the following modes is prohibited. At cooling prohibited : Cool, Dry, Auto, At heating prohibited : Heat, Auto, At cooling-heating prohibited : Cool, Heat, Dry, Auto	X	○
Indoor unit intake temperature	Measures the intake temperature of the indoor unit when the indoor unit is operating.	X	○
Error	When an error is currently occurring on an air conditioner unit, the afflicted unit and the error code are displayed.	X	☐
Timer operation	Thanks to the three timer modes equipped, a proper mode can be selected to meet the usage. One day timer : ON/OFF setting of one time on one day can be applied. Daily timer : ON/OFF setting by the One day timer can be repeated for everyday. Auto OFF timer : OFF timer can be set in a range from 30 minutes to 4 hours. *Setting of Auto OFF timer automatically activates OFF timer at the next operation. This function can be utilized to prevent the negligence of OFF setting. *Weekly schedule in only one patterns can be employed by connecting Program timer. *2	○	○
Test run	This operates air conditioner units in test run mode.	○	○
Ventilation equipment	Up to 16 indoor units can be connected to an interlocked system that has one LOSSNAY. LOSSNAY items that can be set are "Hi" "Low" "Stop". Ventilation mode switching is not available.	○	○
Function to limit the setting range of room temperature (Set temperature range limit)	The range of room temperature setting can be limited by the initial setting. The lowest limit temperature can be made higher than the usual (19°C) at cooling/drying, while the upper limit temperature lower than the usual (28°C) at heating. *When making the function to limit room temperature setting range effective, the operation mode can not be set to the auto mode.	○	○
Easy-to-operate simplified locking function (Auto lock function)	Setting/releasing of simplified locking for remote control switch can be performed. - Locking of all switches - Locking of all switches except Start/Stop switch	○	○
External input/output	By connecting the Program timer "PAC-YT32PTA", a weekly schedule can be controlled. External start/stop control and emergency stop is not supported.	○	○

2-2 Simple remote controller (PAC-SE51CRA)

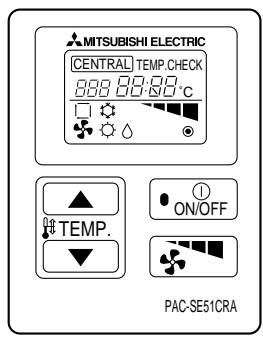

- To simplify operation of the system, the range of controls has been limited to Start/Stop, room temperature and fan speed.
 - The only wiring required is cross-over wiring based on two-wire signal lines.
 - Room temperature sensor is built-in to the unit. The indoor unit can be replaced this with the body thermostat.
- ※: This equipment does not have functions such as operation mode switching, test run mode, self checking ability and settings for interlocking. Therefore, always use this equipment together with a PAR-F27ME or other system controller.
- ※: Combined use with MA remote controller (PAR-20MAA) can not be conducted inside a group.

■ Functions

□:Each unit ○:Each group ●:Each block
 △:Each floor ◎:Collective ✕:Not available

Item	Description	Operations	Display
ON/OFF	Run and stop operation for a single group	○	○
Operation mode switching	Switches between Cool / Dry / Auto / Fan / Heat. Operation modes vary depending on the air conditioner unit. Auto mode is the City Multi R2 and WR2 series only.	✕	○
Temperature setting	Sets the temperature for a single group Range of temperature setting Cool/Dry : 19°C - 30°C Heat : 17°C - 28°C Auto : 19°C - 28°C	○	○
Fan speed setting	Models with 4 air flow speed settings: Hi/Mid-2/Mid-1/Low Models with 2 air flow speed settings: Hi/Low	○	○
Air flow direction setting	Air flow direction angles 100% - 80% - 60% - 40%, Swing, Louver ON/OFF Air flow direction settings vary depending on the model.	✕	✕
Timer operation	Not available	✕	✕
Permit / Prohibit local operation	Individually prohibit operation of each local remote control function (Start/Stop, Set temperature). *1: When the local remote controller inactivation command is received from the master system controller, "- CENTRALLY CONTROLLED -" is displayed.	✕	○ ^{*1}
Indoor unit intake temperature	Measures the intake temperature of the indoor unit only when the indoor unit is operating.	✕	✕
Error	When an error is currently occurring on an air conditioner unit, the afflicted unit and the error code are displayed.	✕	□
Test run	This operates air conditioner units in test run mode. *2: The display for test run mode will be the same as for normal start/stop (no display "test run").	✕	○ ^{*2}
Ventilation equipment	Up to 16 indoor units can be connected to an interlocked system that has one LOSSNAY.	✕	✕
External input/output	By connecting the Program timer, allocate A/B2 mode for a week and control a week's schedule. External start/stop control and emergency stop is not supported.	✕	✕

■ System example

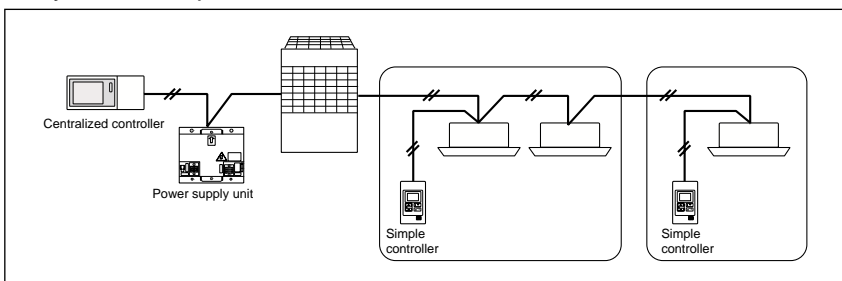

■ External dimension

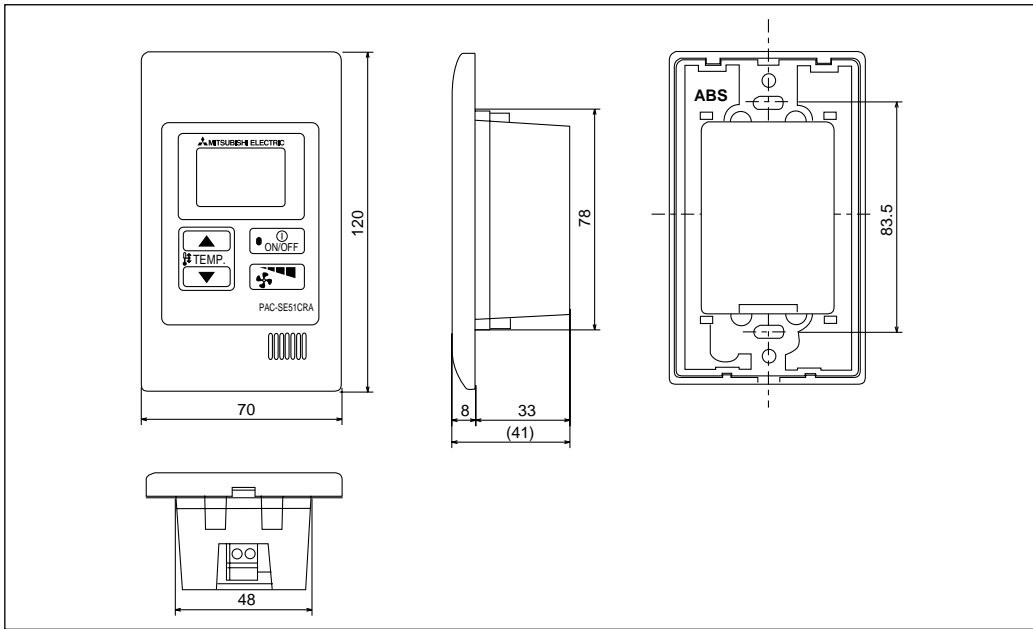

2-3 Simple MA controller (PAC-YT51CRA)

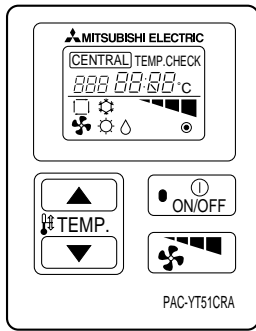

- To simplify operation of the system, the range of controls has been limited to Start/Stop, room temperature and fan speed.
- The only wiring required is cross-over wiring based on two-wire signal lines.
- Room temperature sensor is built-in to the unit. The indoor unit can be replaced this with the body thermostat.

*: This equipment does not have functions such as operation mode switching, test run mode, self checking ability and settings for interlocking. Therefore, always use this equipment together with a PAR-20MAA or other system controller.

*: Combined use with M-NET remote controller (PAR-F27MEA) can not be conducted inside a group.

■ Functions

□: Each unit ○: Each group ●: Each block
△: Each floor ◎: Collective ✕: Not available

Item	Description	Operations	Display
ON/OFF	Run and stop operation for a single group	○	○
Operation mode switching	Switches between Cool / Dry / Auto / Fan / Heat. Operation modes vary depending on the air conditioner unit. Auto mode is the City Multi R2 and WR2 series only.	✕	○
Temperature setting	Sets the temperature for a single group Range of temperature setting Cool/Dry : 19°C - 30°C Heat : 17°C - 28°C Auto : 19°C - 28°C	○	○
Fan speed setting	Models with 4 air flow speed settings: Hi/Mid-2/Mid-1/Low Models with 3 air flow speed settings: Hi/Mid/Low Models with 2 air flow speed settings: Hi/Low	○	○
Air flow direction setting	Air flow direction angles 100% - 80% - 60% - 40%, Swing, Louver ON/OFF Air flow direction settings vary depending on the model.	✕	✕
Timer operation	Not available	✕	✕
Permit / Prohibit local operation	Individually prohibit operation of each local remote control function (Start/Stop, Set temperature). *1: When the local remote controller inactivation command is received from the master system controller, "- CENTRALLY CONTROLLED -" is displayed.	✕	○ ^{#1}
Indoor unit intake temperature	Measures the intake temperature of the indoor unit only when the indoor unit is operating.	✕	✕
Error	When an error is currently occurring on an air conditioner unit, the afflicted unit and the error code are displayed.	✕	□
Test run	This operates air conditioner units in test run mode. *2: The display for test run mode will be the same as for normal start/stop (no display "test run").	✕	○ ^{#2}
Ventilation equipment	Up to 16 indoor units can be connected to an interlocked system that has one LOSSNAY.	✕	✕
External input/output	By connecting the Program timer, allocate A/B2 mode for a week and control a week's schedule. External start/stop control and emergency stop is not supported.	✕	✕

■ System example

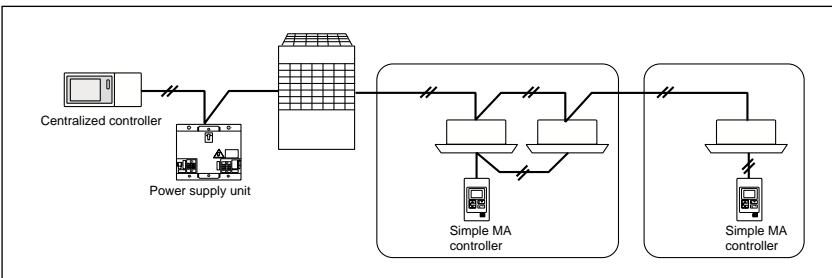

■ External dimension

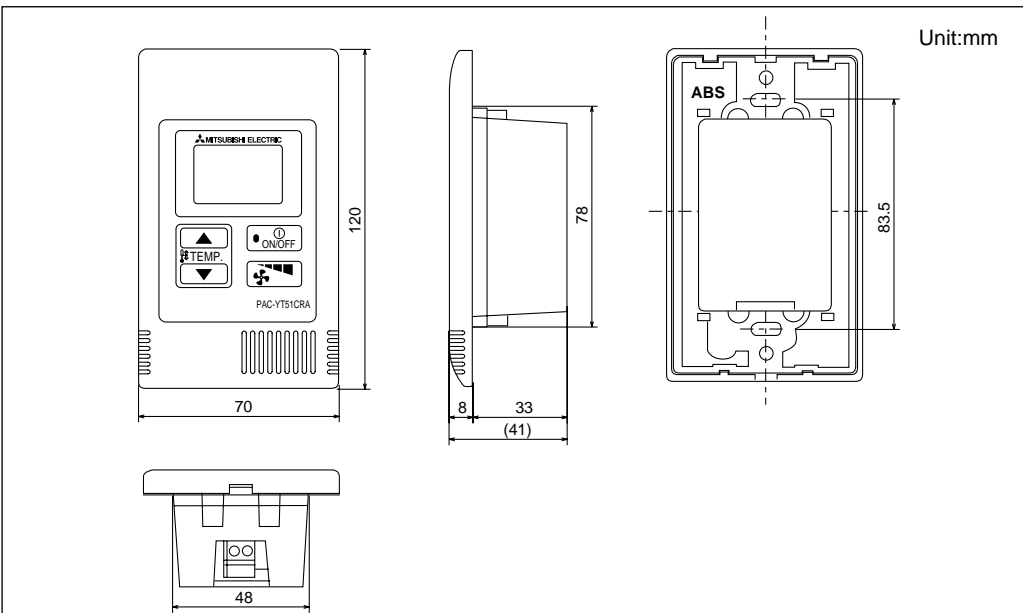

2-4 Wireless remote controller Controller :PAR-FL31MA Signal receiving unit :PAR-FA31MA

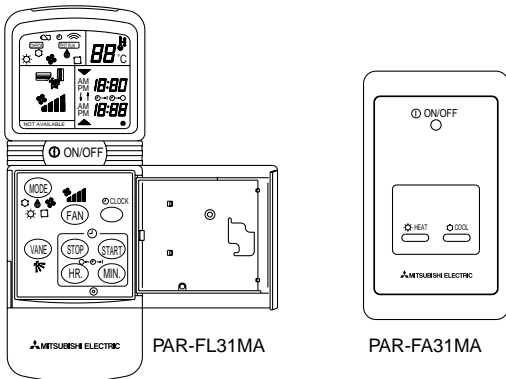

- It can operate in a group system without requiring address settings.

- When operating, it displays LED lamps. When errors occur, the error code can be shown by the LED flash count.

- ※: If an indoor unit with different functionality is operating inside the same group, please note there may be cases when functionality is partially disabled for batch control.

- ※: Wireless remote controllers can only be used for a single refrigerant system.

- ※: If you use a system controller to centrally control a group, you will need cross-wiring between indoor units when using a wireless remote controller.

Also ensure there is no difference between the group setting of the master system controller and the cross wiring across indoor units when wiring and setting cross wires.

■ Functions

□:Each unit ○:Each group ●:Each block
△:Each floor ⊙:Collective ×:Not available

Item	Description	Operations	Display
ON/OFF	Run and stop operation for a single group	○	○
Operation mode switching	Switches between Cool / Dry / Fan / Heat / Auto. Operation modes vary depending on the air conditioner unit. Auto mode is the City Multi R2 and WR2 series only.	○	○
Temperature setting	Sets the temperature for a single group Range of temperature setting Cool/Dry : 19°C - 30°C Heat : 17°C - 28°C Auto : 19°C - 28°C	○	○
Fan speed setting	Models with 4 air flow speed settings: Hi/Mid-2/Mid-1/Low Models with 2 air flow speed settings: Hi/Low	※	※
Air flow direction setting	Air flow direction angles 100% - 80% - 60% - 40%, Swing. Air flow direction settings vary depending on the model.	※	※
Timer operation	One ON/OFF setting can be set for one day.	○	○
Permit / Prohibit local operation	Individually prohibit operation of each local remote control function (Start/Stop, Change operation mode, Set temperature, Reset filter). *1: If operation is performed when the local remote controller inactivation command is received from the master system controller, a buzzer will ring and an LED will flash.	×	*1 ○
Indoor unit intake temperature	Measures the intake temperature of the indoor unit when the indoor unit is operating.	×	×
Error	When an error occurs on the air conditioner unit, the operation lamp on the signal receiving unit will flash.	×	○
Test run	This operates air conditioner units in test run mode.	○	○
Ventilation equipment	Up to 16 indoor units can be connected to an interlocked system that has one LOSSNAY.	×	×
External input/output	By connecting the Program timer, allocate A/B2 mode for a week and control a week's schedule.	×	×

※ Some models will have different display for the air flow direction and fan speed. Set the air flow direction and fan speed when performing initial setting.

■ System example

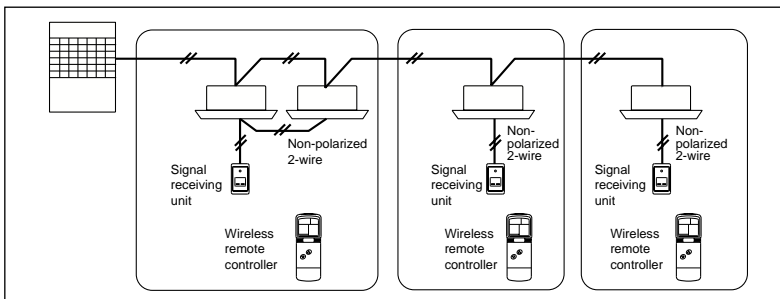

■ External dimension

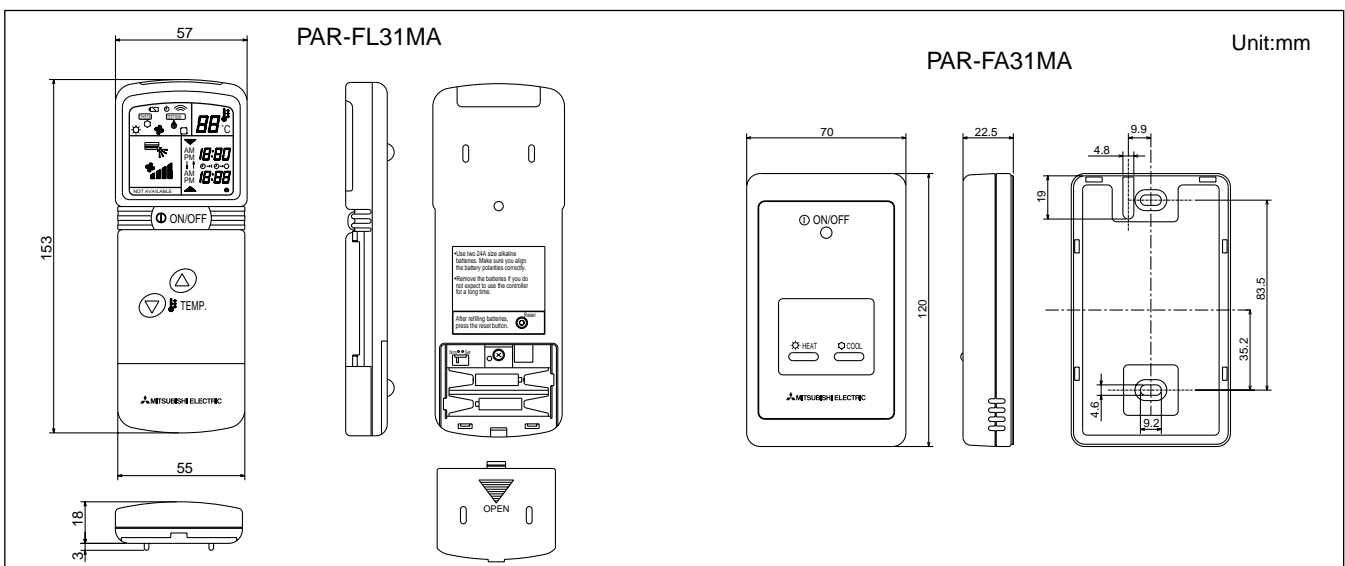

2-5 LOSSNAY remote controller (PZ-52SF-E)

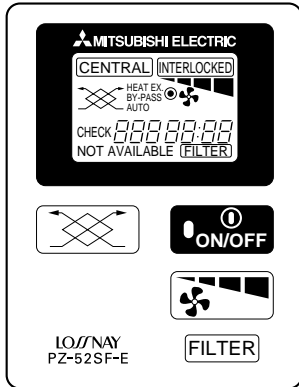

- Stand-alone LOSSNAY operation is possible by commands from a centralized controller or LOSSNAY remote controller. (G-50A is a centralized controller that supports LOSSNAY operation.)
 - The LOSSNAY remote controller is capable of changing the air flow and vent modes.
 - All the wiring is cross-wiring that uses non-polar two wire system signal cables.
- ※ : When setting up a LOSSNAY stand-alone system or when setting up a LOSSNAY and centralized controller system, connect a power supply unit for the signal cables.
- ※ : It is impossible to use a LOSSNAY remote controller for LOSSNAY unit that is interlocked other indoor unit (except for some models).

■ Functions

□:Each unit ○:Each group ●:Each block
 △:Each floor ◎:Collective ✕:Not available

Item	Description	Operations	Display
ON/OFF	Run and stop operation for a LOSSNAY unit	○	○
 Operation mode switching	Switches between automatic ventilation/ vent - heat interchange/ normal ventilation Note: Operation modes vary depending on the model. When connecting to only models without a damper, these models cannot be used. ("NOT AVAILABLE" will appear in the display.)	○	○
Temperature setting	Not available	✕	✕
Fan speed setting	Models with 2 air flow speed settings: Hi/Low When only connected to single notch models, this function is disabled.	○	○
Air flow direction setting	Not available	✕	✕
Timer operation	Not available	✕	✕
Permit / Prohibit local operation	Individually prohibit operation of each local remote control function (Start/Stop, Reset filter). *1: When the local remote controller inactivation command is received from a master system controller, "CENTRAL" is displayed.	✕	○ ^{#1}
Indoor unit intake temperature	Not available	✕	✕
Error	When an error occurs on the air conditioner unit, the operation lamp on the signal receiving unit will flash.	✕	□
Test run	There is no test run switch for LOSSNAY remote controllers. Set test run on a LOSSNAY by using the test run switch on the LOSSNAY unit. *2: Cancel by operating the start/stop switch after switching off the LOSSNAY unit test run switch.	✕ ^{#2}	○
Ventilation equipment	Up to 16 indoor units can be connected to an interlocked system that has one LOSSNAY.	○	○
Interlocked operation	This is displayed to indicate it is being operated by an operation control unit's external control terminal for an interlocked system that contains LOSSNAY units and indoor units.	✕	○
External input/output	The program timer (PAC-YT30ST) cannot be connected. When external ON/OFF is required, use the LOSSNAY unit's external control input.	✕	✕

■ System example

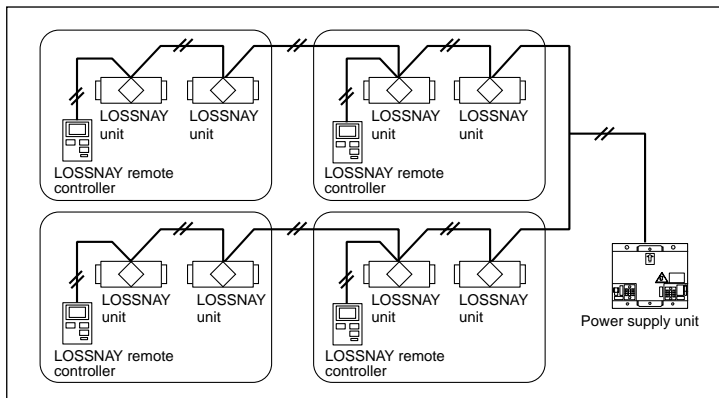

■ External dimension

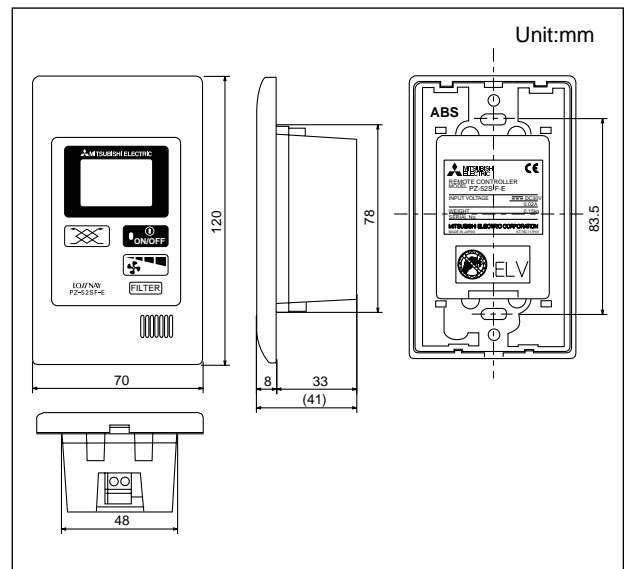

2-6 Program timer (PAC-YT32PTA)

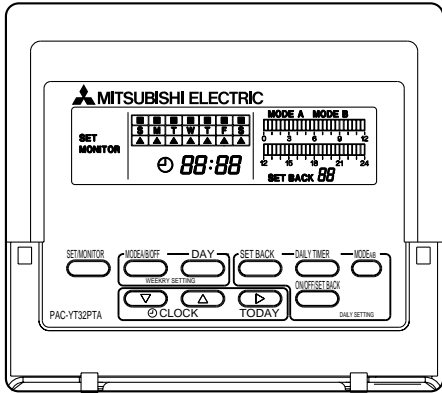

- To be set the ON/OFF schedule each 30 minutes. (2 pattern)
- To be set the effective/ineffective of schedule in each individual days.
- To be set the set-back temperature. (0, 1, 2, 6, 8 deg.)

■ System example

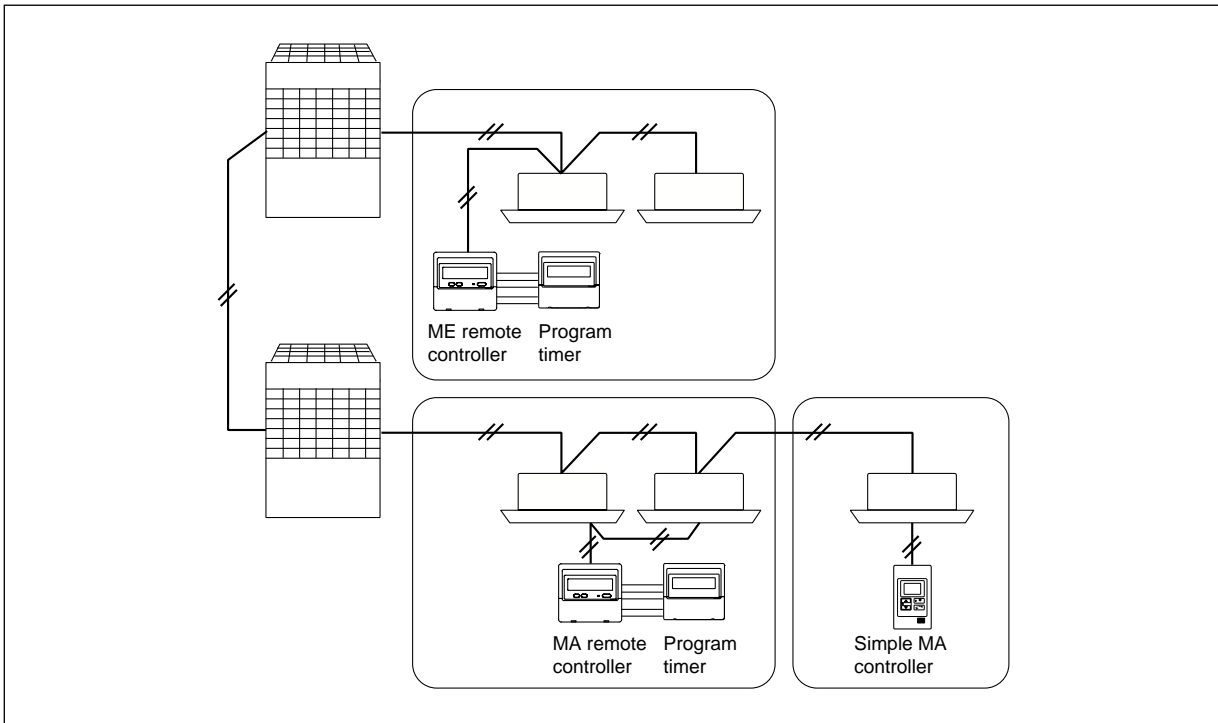

3. System controller

PAC-SC30GRA

3-1 Group remote controller (PAC-SC30GRA)

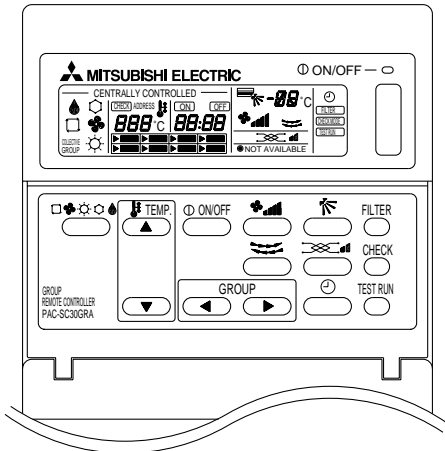

- Up to 8 groups can be operated (maximum of 16 units). Just by pressing switches, groups can be started and stopped individually, or all groups can be started and stopped as a batch.
- Detailed settings and operations can also be made for each individual group.
- All the wiring is simply done with non-polarized two wire signal lines. The connection is the same as the connection to the master system controller.
- It supports operation of groups that can extend beyond one refrigerant system. Furthermore, it is possible to drive interlocked systems that use ventilator equipment or drive ventilator equipment in a stand-alone situation.

※: With the group remote controller, you cannot control groups that only contain the LOSSNAY remote controller.

※: It is impossible to use the group remote controller to control K control units.

※: When connecting to signal cables for central control, it must use a power supply unit for the signal cables.

■ Functions

□: Each unit ○: Each group ●: Each block
 △: Each floor ◎: Collective ✕: Not available

Item	Description	Operations	Display
ON/OFF	Run and stop operation for the air conditioner units *1: Even when only a single indoor unit connected to the group remote controller is operated, the collective ON/OFF lamp will light up.	○ ◎	*1 ○ ◎
Operation mode switching	Switches between Cool / Dry / Auto / Fan / Heat. *2: When collective operation is set, the display will show "COLLECTIVE" in the bottom left of the LCD screen. Operation modes vary depending on the air conditioner unit. Auto mode is the City Multi R2 and WR2 series only.	○ ◎	*2 ○
Temperature setting	Sets the temperature for a single group Range of temperature setting Cool/Dry : 19°C - 30°C Heat : 17°C - 28°C Auto : 19°C - 28°C *3: When collective operation is set, the display will show "COLLECTIVE" in the bottom left of the LCD screen.	○ ◎	*3 ○
Fan speed setting	Models with 4 air flow speed settings: Hi/Mid-2/Mid-1/Low Models with 3 air flow speed settings: Hi/Mid/Low Models with 2 air flow speed settings: Hi/Low *4: When collective operation is set, the display will show "COLLECTIVE" in the bottom left of the LCD screen.	○ ◎	*4 ○
Air flow direction setting	Air flow direction angles 100% - 80% - 60% - 40%, Swing, Louver ON/OFF Air flow direction settings vary depending on the model. *5: When collective operation is set, the display will show "COLLECTIVE" in the bottom left of the LCD screen.	○ ◎	*5 ○
Timer operation	It is impossible to set schedules by only using this group remote controller. By connecting a program timer, set 48 ON/OFF settings every 30 minutes. By loading only one pattern, it can operate as a weekly schedule. *6: If the Program timer is connected, you can enable/disable timer operation for each group.	*6 ○ ◎	○
Permit / Prohibit local operation	Individually prohibit operation of each local remote control function (Start/Stop, Change operation mode, Set temperature, Reset filter). *7: When the local remote controller inactivation command is received from a master system controller, "- CENTRALLY CONTROLLED -" is displayed.	✕	*7 ○
Indoor unit intake temperature	Measures the intake temperature of the indoor unit only when the indoor unit is operating.	✕	○
Error	When an error is currently occurring on an air conditioner unit, the afflicted unit and the error code are displayed. *8: This is indicated by the batch operation lamp.	✕	*8 □ ◎
Test run	This operates air conditioner units in test run mode.	○	○
Ventilation equipment	Up to 16 indoor units can be connected to an interlocked system that has one LOSSNAY. LOSSNAY items that can be set are "Hi" "Low" "Stop". Ventilation mode switching is not possible. *9: When collective operation is set, the display will show "COLLECTIVE" in the bottom left of the LCD screen.	○ ◎	*9 ○
External input/output	By connecting the Program timer "PAC-YT32PTA", a weekly schedule can be controlled. External start/stop control and emergency stop is not supported.	○ ◎	○

■ System example

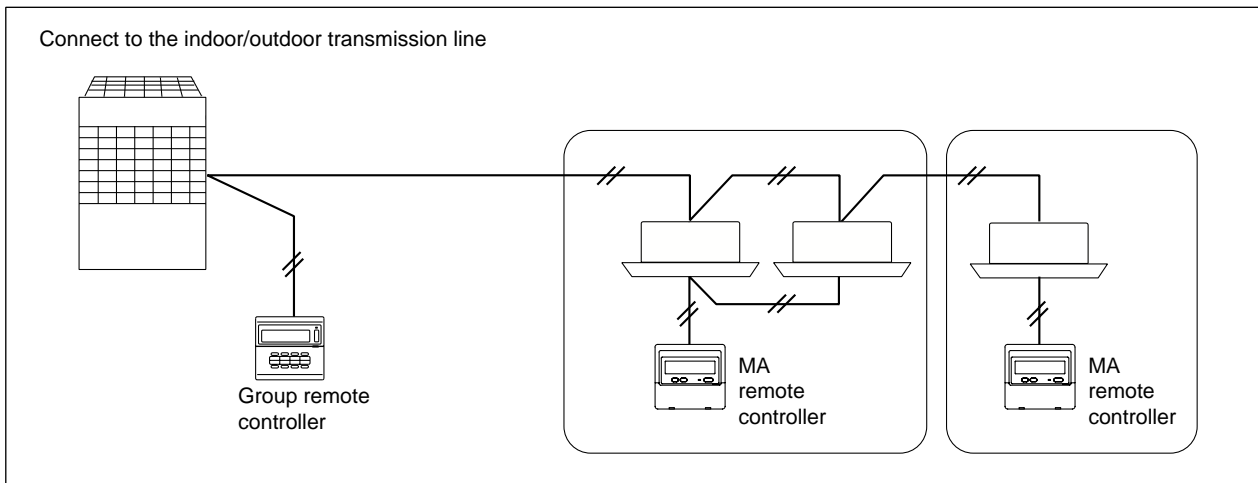
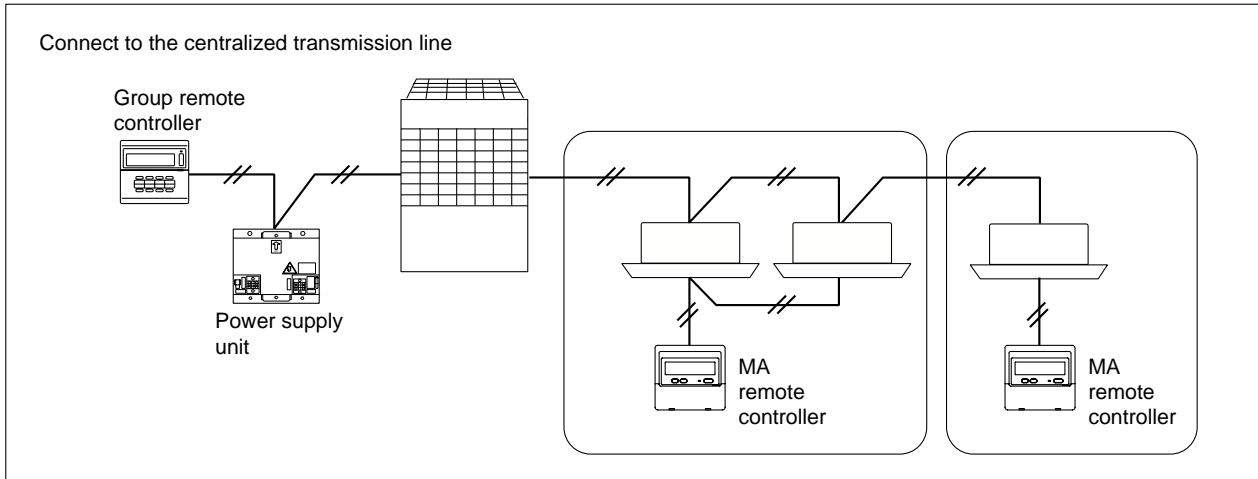

■ External dimension

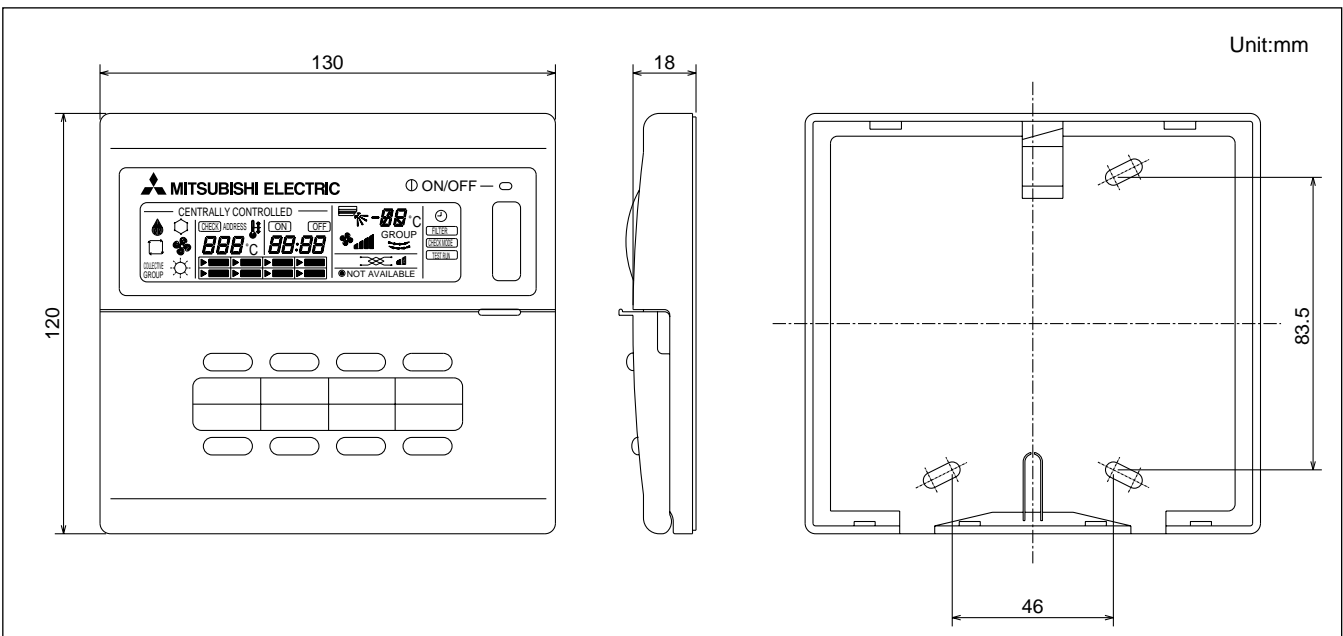

3-2 System remote controller (PAC-SF44SRA)

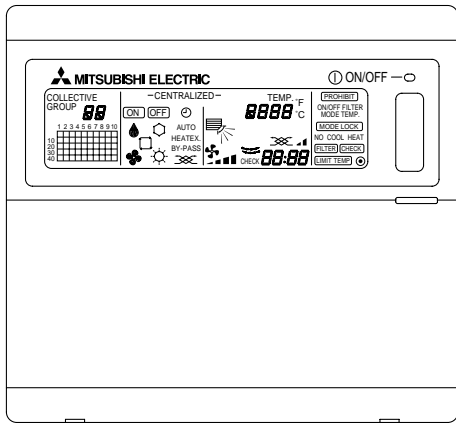

■ Functions

□: Each unit ○: Each group ●: Each block
 △: Each floor ◎: Collective ✕: Not available

Item	Remarks	Operations	Display
ON/OFF	Run and stop operation for the air conditioner units	◎	◎
Operation mode switching	Switches between Cool / Dry / Auto / Fan / Heat. * There are modes that cannot be selected depending on the unit.	◎	○
Temperature setting	The temperature can be set within the following range. Values in parentheses are for the medium-temperature indoor unit. Cool/Dry : 19°C~30°C (14°C~30°C) Heat : 17°C~28°C (17°C~28°C) Automatic : 17°C~28°C (17°C~28°C)	◎	○
Fan speed setting	The fan speed cannot be set.	◎	◎
Air flow direction setting	The air flow direction cannot be set.	◎	◎
Manual operation prohibit/permit (ON/OFF, mode change, setting temperature, filter reset)	When set as the master, the ON/OFF, operation mode, setting temperature and filter sign reset operations using the local remote controllers can be prohibited. * [PROHIBIT] will appear when prohibited. Only ON/OFF and filter reset can be prohibited for the LOSSNAY group.	◎	◎
Specific mode operation prohibit (Cooling prohibit, heating prohibit, cooling/heating prohibit)	When set as the master, operation of the following modes with the local remote controllers can be prohibited. When cooling is prohibited: Cooling, dry, automatic can not be chosen. When heating is prohibited: Heating, automatic can not be chosen. When cooling/heating is prohibited: Cooling, dry, heating, automatic can not be chosen.	◎	◎
Room temperature display	The room temperature cannot be displayed.	-	✕
Error display	The details of the currently occurring error are displayed with the address. * The address may not be displayed depending on the details of the error.	-	◎
Schedule operation	Two patterns of weekly schedules can be operated with the Schedule timer.(PAC-YT34STA) * The schedule validity can be set for each group.	△	△
Ventilation (independent)	Group operation of only the free plan LOSSNAY is possible. * The operation mode of these groups is automatic ventilation, ventilation with heat exchanger and normal ventilation.	○	○
Ventilation (interlocked)	The LOSSNAY will run in interlock with the operation of indoor unit. * The fan rate and mode cannot be changed. The LED will turn ON during operation after interlocking.	△	△

- 50 groups/50 units of air conditioners can be controlled.
 - Up to 50 groups/50 units of air conditioners can be operated with one remote controller.
- Operation status displayed on easy-to-read LCD
 - The group currently operating can be seen at a glance with the operation status display for each group.
- Simple remote controller limited to basic operations.
 - The only operations required for the air conditioner are "ON/OFF", "Operation mode changeover", "Temperature setting" and "Prohibit operation by local remote controller", so anyone can easily operate the unit.
 - Using collective control from the system remote controller, operation mode settings using the local remote controllers can be prohibited. (Operation mode limit function)
- Schedule operation is available
 - Groups of air conditioners are available for operation at a set schedule using the Schedule timer (PAC-YT34STA).
- Independent LOSSNAY operation is possible
 - LOSSNAY units can be grouped the same as the Central remote controller and ON/OFF remote controller.
 - "Automatic ventilation", "Normal ventilation" and "Ventilation with heat exchanger" can be switched from the system controller.

■ System example

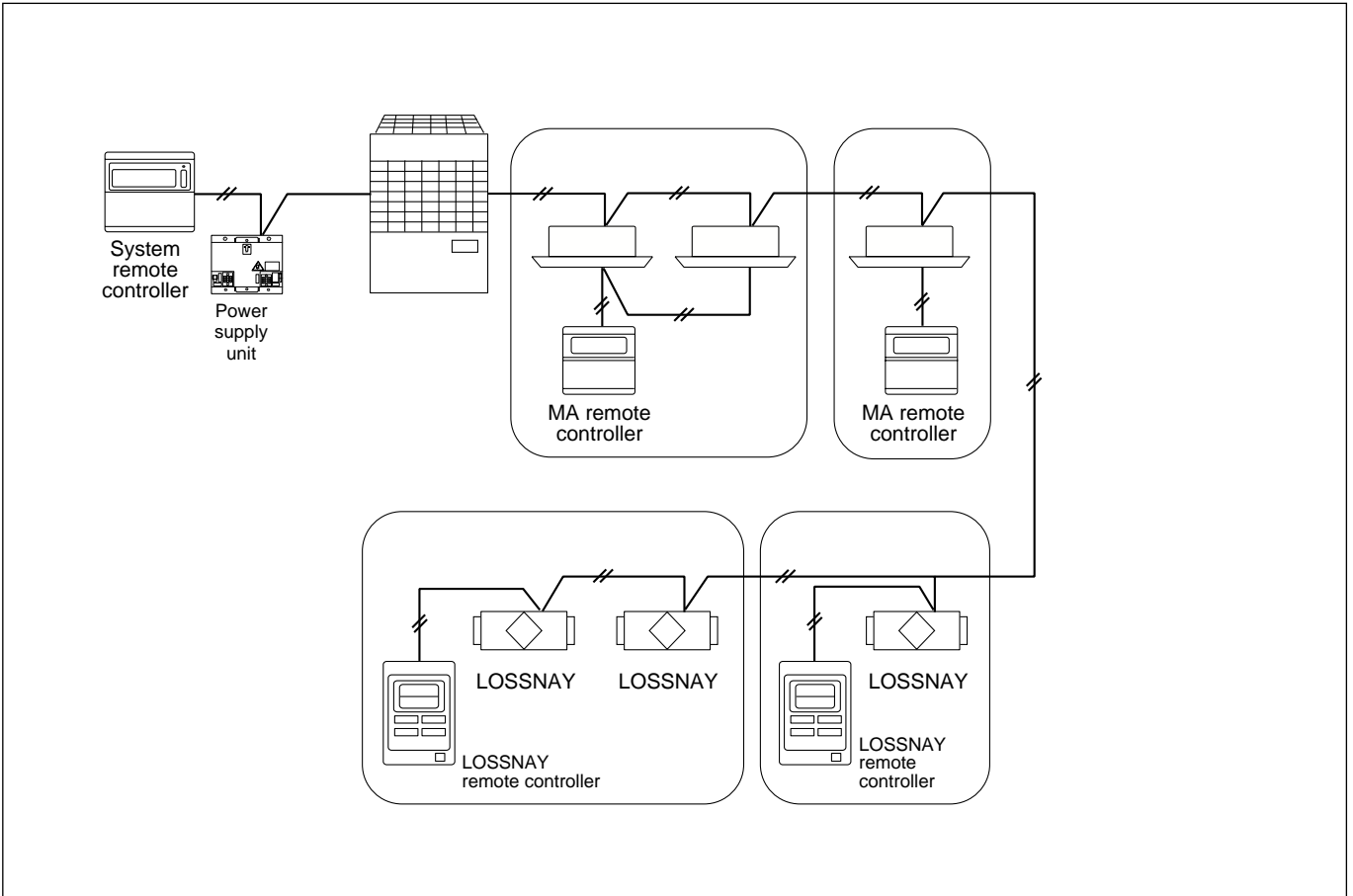

■ External dimension

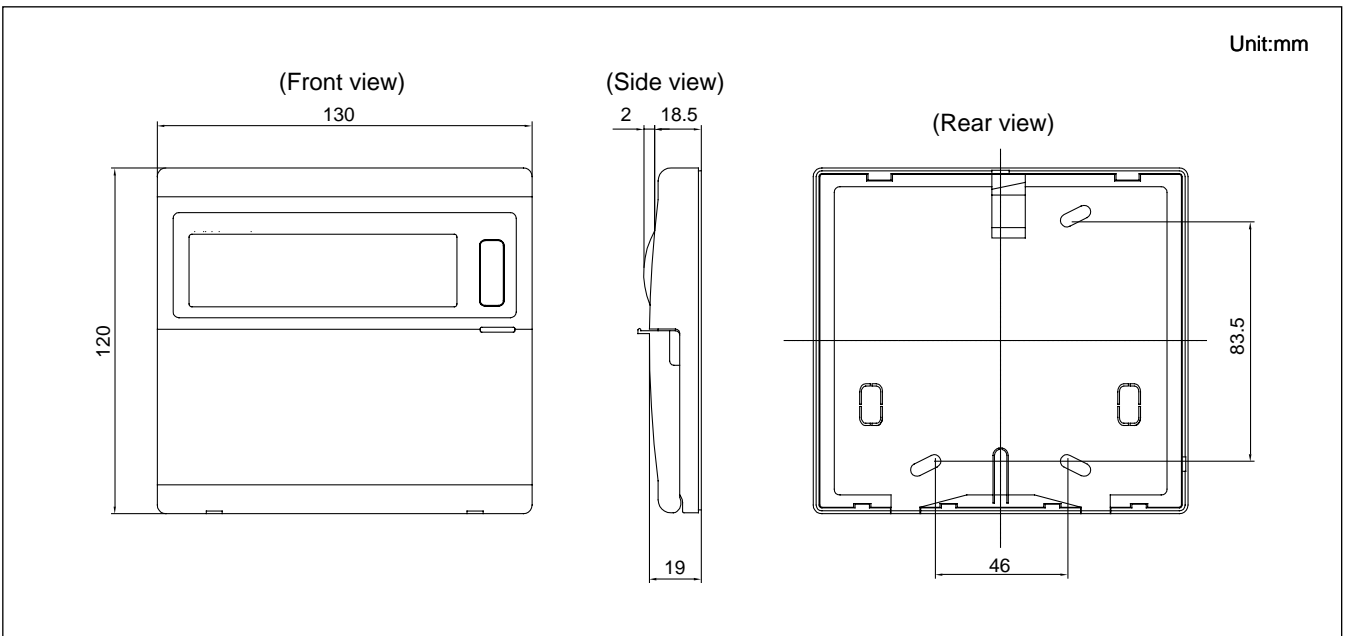

3-3 Schedule timer (PAC-YT34STA)

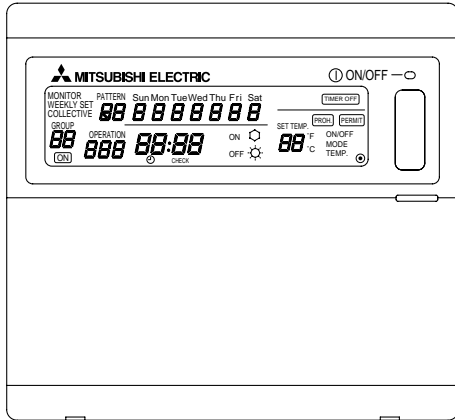

- The weekly schedule of up to 50 groups/50 units can be controlled with one schedule timer.
- The weekly schedule of up to ten patterns (no setting + nine patterns) is available for setting.
- "ON/OFF", "Operation Prohibit", "COOL/HEAT" and "Set Temperature" can be scheduled with up to 16 settings in one pattern.
- It can be connected to the center control transmission line or to the indoor/outdoor transmission line without the power supply unit (PAC-SC34KUA). It is nonpolar 2-wire.
- It can be interlocked with a building management system using the external input/output managing function.

An error unit address and error code appear on the display.

(*) Use in combination with other system controllers.

■ Functions

□: Each unit ○: Each group ●: Each block
 △: Each floor ◎: Collective X: Not available

Item	Details	Operations	Display
Unit control	50 units/50 groups (Maximum 16 units connected in one group)	◎	○
Schedule control	One week	○	○
Operation	ON/OFF	○	○
	Timer reset	○	—
Schedule function	Setting details	○	—
	Number of settings	○	—
	Time setting unit	○	—
Display	Current time and day	—	○
	Error state	—	○
	Unit operation state	—	X
External input (Timer connection, emergency stop input, etc.)	The following can be input with the level signals or pulse signals. Level signal: "Emergency stop input" or "Collective ON/OFF" Pulse signal: "Collective ON/OFF" or "Local remote controller prohibit/permit" One input can be selected from those above.	○	—
External output (Error output, operation output)	"ON/OFF" and "error/normal" are output with the level signal. * The optional output cable is required.	○	—
Connection position	Indoor/outdoor transmission line: Connectable Central system transmission line: Connectable (Optional power supply unit (PAC-SC34KUA) is needed.)	—	—

■ System example

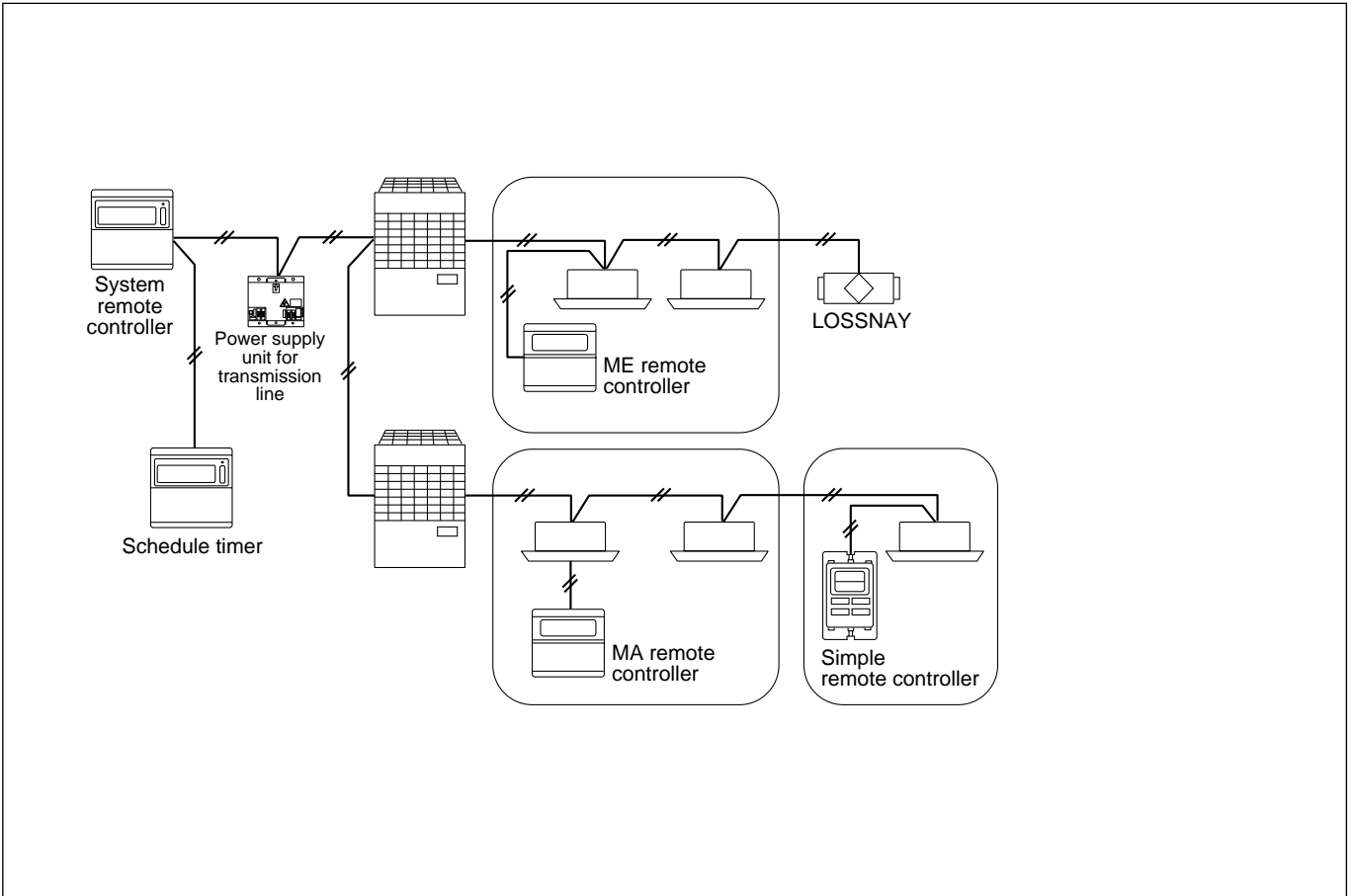

■ External dimension

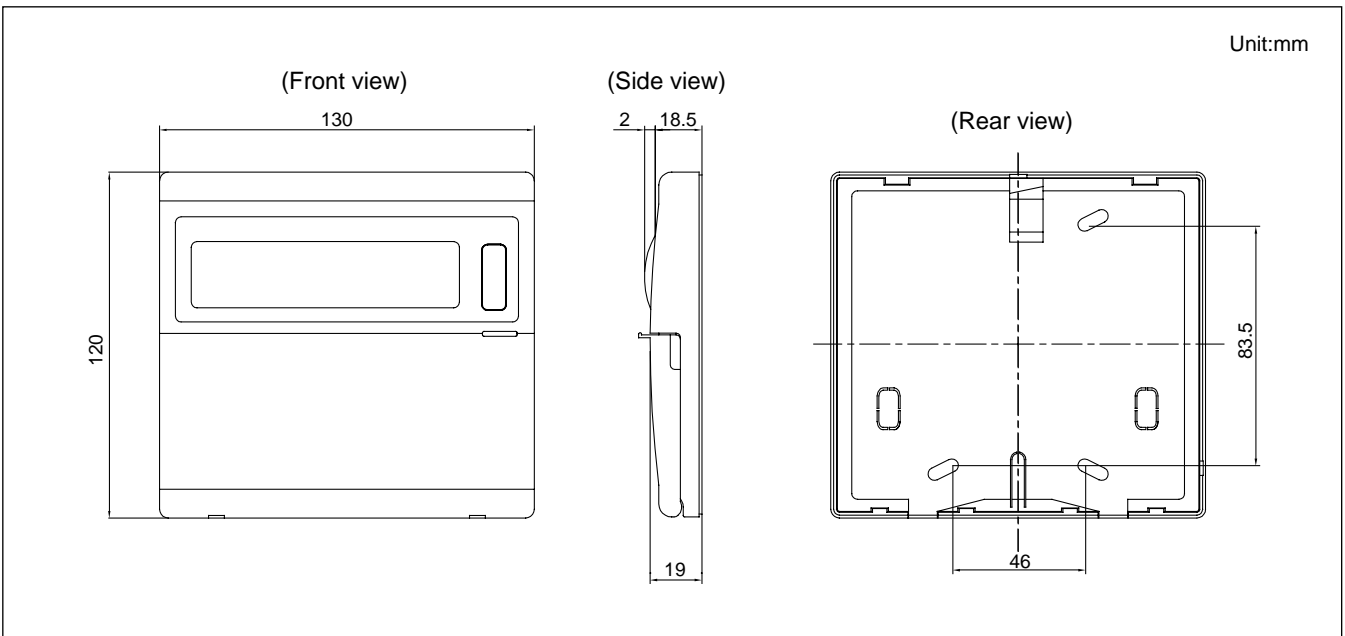

3-4 ON/OFF remote controller (PAC-YT40ANRA)

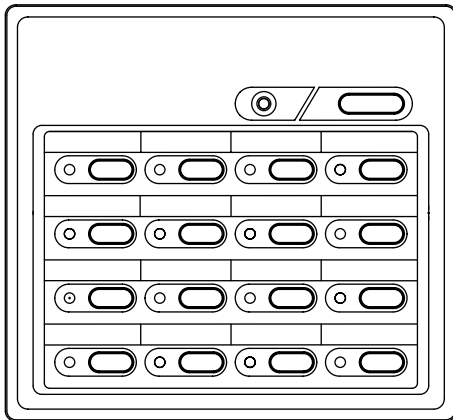

- 16 groups/50 units can be controlled.
 - Up to 16 groups/50 units can be operated with one ON/OFF remote controller.
 - A general-purpose interface is available for control, so general devices can also be turned ON and OFF.
- Just press a switch to start.
 - All of the units can be started and stopped by pressing the main switch, and each unit in the group can be started and stopped with individual switches.
 - A general-purpose interface is available for control, so general devices can also be turned ON and OFF.
- LED flashing during failure.
 - If any error should occur in the air conditioner, its details can be confirmed easily with the flashing LED. The LED also indicates whether each group is running or stopped.
- Interlock operation with external system possible.
 - It can be flexibly interlocked with a card reader, fire alarm system or building management system, etc., using the incorporated external input/output function.
- Flexible group setting.
 - The groups can be easily configured, so the group pattern can be freely set according to the layout.
 - The ON/OFF remote controller can be connected at the indoor/outdoor transmission line with out the power supply unit.

■ Functions

□: Each unit ○: Each group ●: Each block
 △: Each floor ◎: Collective X: Not available

Item	Description	Operations	Display
ON/OFF	Run and stop operation for the air conditioner units	◎	◎
Operation mode switching	Not available	X	X
Temperature setting	Not available	X	X
Fan speed setting	Not available	X	X
Air flow direction setting	Not available	X	X
Manual operation prohibit/permit (ON/OFF, operation mode, setting temperature, filter reset)	Compatible only with external input.	X	X
Specific mode operation prohibit (Cooling prohibit, heating prohibit, cooling/heating prohibit)	Not available	X	X
Room temperature display	Not available	—	X
Error display	LED flashes during failure. (The error code can be confirmed by removing the cover.)	—	△
Schedule operation	Not available	X	X
Ventilation operation (independent)	Group operation of only LOSSNAY units possible. * Only ON/OFF of group.	○	○
Ventilation operation (interlocked)	The LOSSNAY will run in interlock with the operation of indoor unit. * The fan rate and mode cannot be changed. The LED will turn ON only during operation after interlocking.	△	△
External output (Error output, operation output)	"ON/OFF" and "error/normal" are output with the level signal. * The optional output cable is required.	◎	◎
Connection position	Indoor/outdoor transmission line: Connectable Central system transmission line: Connectable (Power supply unit (PAC-SC34KUA) is needed.)		

■ System example

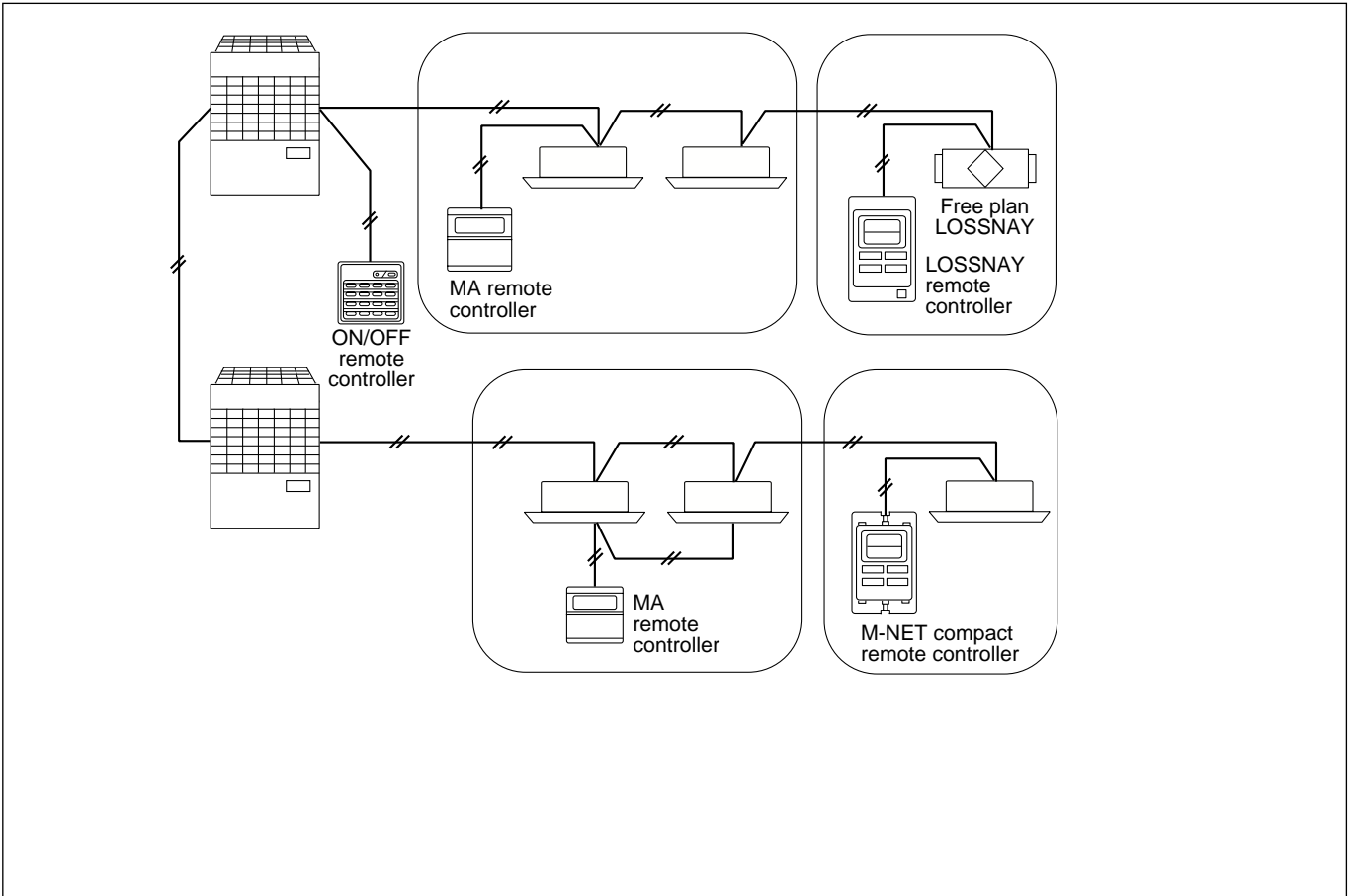

■ External dimension

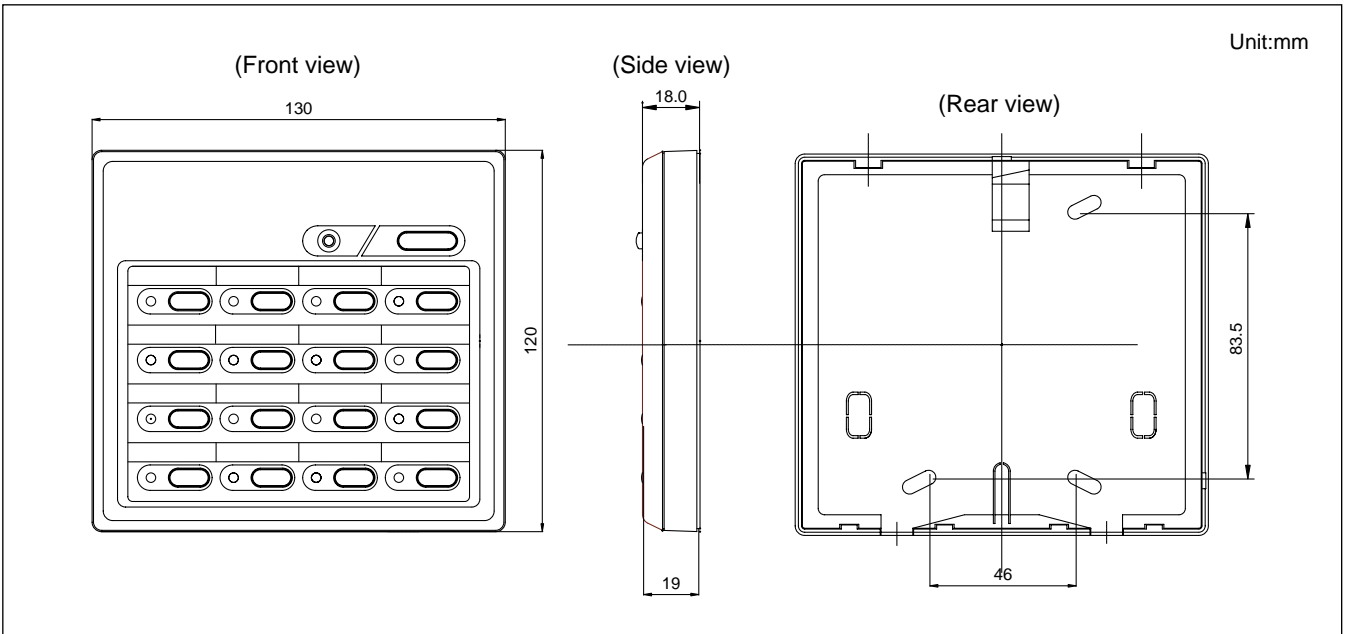

3-5 Centralized controller 3-5-1 G-50A

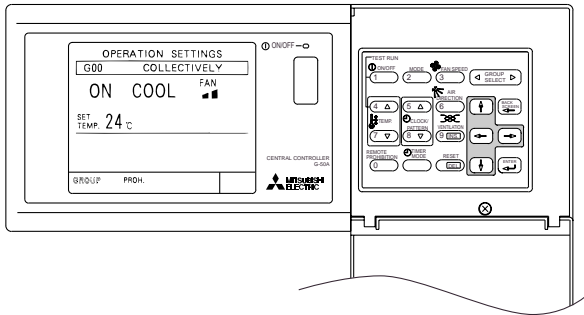

- Adds a web server function (optional) to the conventional central controller, thus allowing central monitoring of air-conditioners using browser software* on a PC.
Use of a public telephone line allows long-distance monitoring and operation, as well as central control of air-conditioners in two or more buildings.
(*) Internet Explorer Ver.5 or later. Microsoft® Internet Explorer is a registered trademark of Microsoft Corporation US in the United States of America and other countries.
- Incorporation of system expansion software (eg 'Proportional Power Distribution', 'Energy-saving Operation', and 'Yearly Schedule Setting')*1 allows addition of a variety of functions required for control of building air-conditioning.
- A maximum of 50 indoor units may be monitored and operated from one G50, and the incorporation of multiple central controllers in a system network allows a maximum of 2000 indoor units to be operated and managed from a PC.
- The use of 'Energy-saving Operation' software (*1) (optional) allows the temperature setting to be changed automatically (*2) in consideration of the temperature in the vicinity of the air-conditioner, thus allowing energy-saving air-conditioning without loss of comfort.
Energy-saving operation is also possible using rotating ventilation and air-conditioning performance saving operation.
- If a fault occurs in the air-conditioner, fault details are sent to a specified email address (*3) (optional).
This ensures security of operation while no operator is present (eg holidays, night-time).

*1 ('Proportional Power Distribution', 'Energy-saving Operation', and 'Yearly Schedule Setting') expansion software scheduled for release.
*2 The system considers the intake temperature and temperature setting at pre-set intervals in order to set the temperature slightly high when cooling and slightly low when heating.
*3 Notification may be delayed in some cases (eg out of transmission range, service provider problems).

■ Functions

□:Each unit ○:Each group ●:Each block
△:Each floor ◎:Collective ×:Not available

Item	Description	Operations	Display
ON/OFF	Run and stop operation for the air conditioner units	○◎	○◎
Operation mode switching	Switches between Cool / Dry / Auto / Fan / Heat. (Group of LOSSNAY unit : automatic ventilation/ vent - heat interchange/ normal ventilation) Operation modes vary depending on the air conditioner unit. Auto mode is the City Multi R2 and WR2 series only.	○◎	○
Temperature setting	Range of temperature setting Cool/Dry : 19°C - 30°C Heat : 17°C - 28°C Auto : 19°C - 28°C * Range of temperature settings vary depending on model.	○◎	○
Fan speed setting	Models with 4 air flow speed settings: Hi/Mid-2/Mid-1/Low Models with 3 air flow speed settings: Hi/Mid/Low Models with 2 air flow speed settings: Hi/Low	○◎	○
Air flow direction setting	Air flow direction angles 100% - 80% - 60% - 40%, Swing. *1: Louver cannot be set. Air flow direction settings vary depending on the model.	*1 ○◎	○
Timer operation	For one day, you can set start/stop three times and you can set enable/disable three times. For a week's schedule, you can store three start/stop patterns and one enable/disable pattern. *2: When the timer is set, "Timer enabled" is shown on the operation setting screen of the LCD.	○◎	*2 ○
Permit / Prohibit local operation	Individually prohibit operation of each local remote control function (Start/Stop, Change operation mode, Set temperature, Reset filter). *3: When the local remote controller inactivation command is received from the master system controller, "Disabled" appears in inverted display on the operation setting screen.	○◎	*3 ○
Indoor unit intake temperature	Measures the intake temperature of the indoor unit only when the indoor unit is operating.	×	○
Error	When an error is currently occurring on an air conditioner unit, the afflicted unit and the error code are displayed. *4: When an error occurs, the LED flashes. The operation monitor screen shows the abnormal unit by flashing it. The error monitor screen shows the abnormal unit address, error code and source of detection. The error log monitor screen shows the time and date, the abnormal unit address, error code and source of detection.	×	*4 □◎
Test run	This operates air conditioner units in test run mode.	○	○
Ventilation equipment	The interlocked system settings can be performed by the master system controller. When setting the interlocked system, you can use the ventilation switch to switch the free plan LOSSNAY settings between "Hi", "Low" and "Stop". When setting a group of only free plan LOSSNAY units, you can switch between "Normal ventilation", "Interchange ventilation" and "Automatic ventilation".	○	○
External input/output	By using accessory cables you can set and monitor the following. Input By level signal: "Batch start/stop", "Batch emergency stop" By pulse signal: "Batch start/stop", "Enable/disable local remote controller" Output "Start/stop", "Error/Normal" *5: Requires the external I/O cable (PAC-YG10HA-E) sold separately.	◎*5	◎*5

■ System example

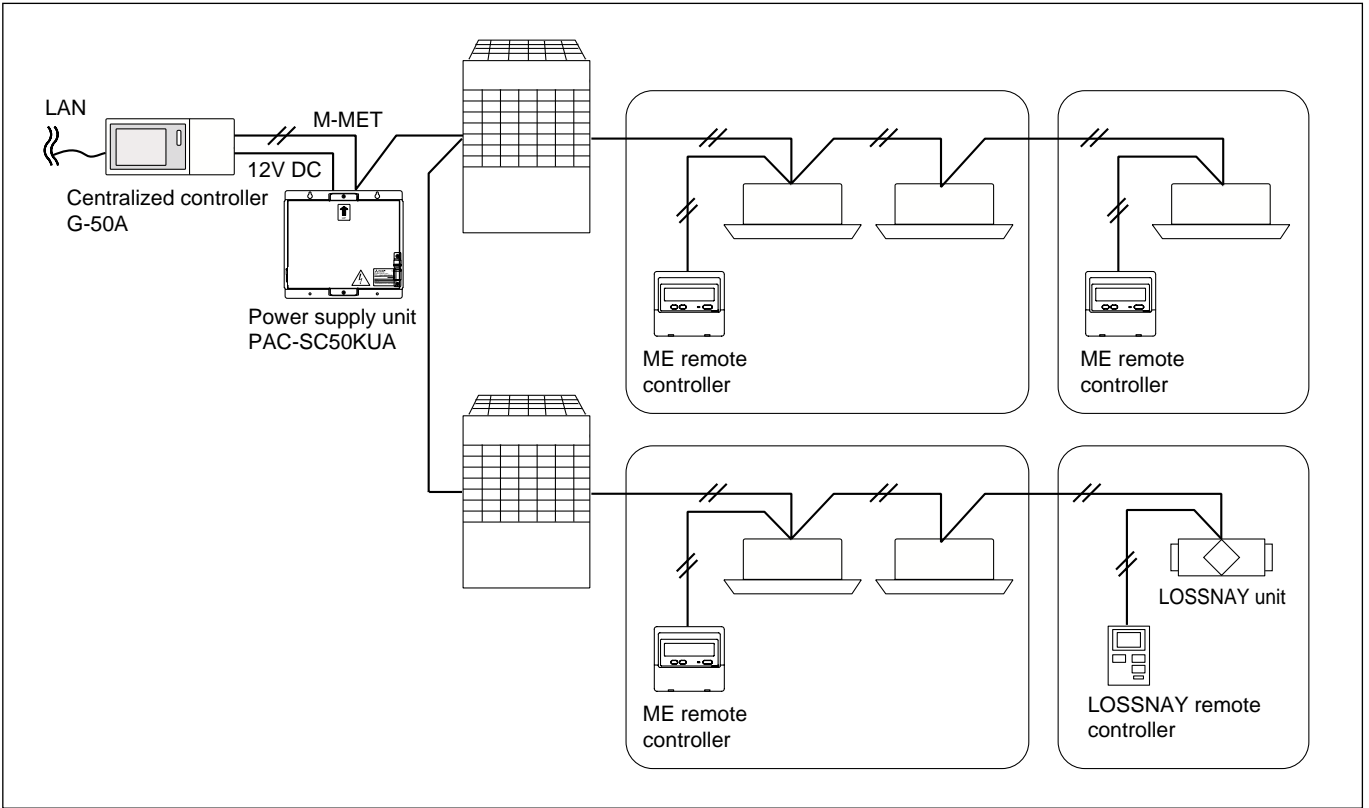

■ External dimension

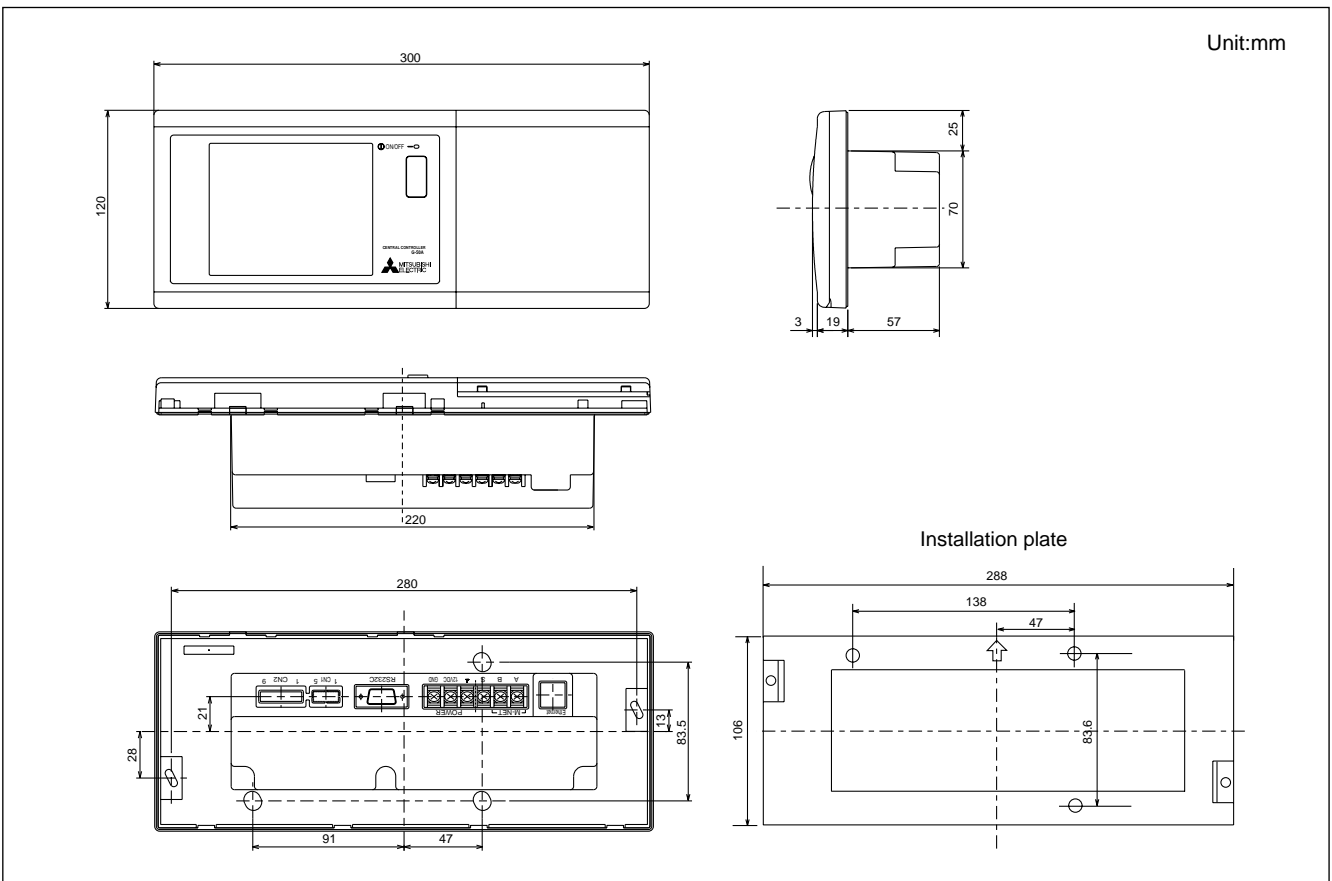

External input/output usage method

1. External signal input function

* External signal input requires the external I/O adapter (Model: PAC-YG10HA-E) sold separately.

(1) External input

Emergency stop/normal, run/stop and prohibit/enable of local remote controller operation can be controlled for all air conditioners being controlled by using a voltage (DC12V or DC24V) contact signal from an external source.

(Select with the function select setting)

No	External signal input function	Function		Remarks
		No.6	No.7	
1	Do not use external input signal (factory setting)	OFF	OFF	
2	Execute emergency stop/normal with level signal	OFF	ON	The local remote controller ON/OFF operations, and the controller ON/OFF operation and prohibit/enable change operations will be prohibited during emergency stop.
3	Perform ON/OFF with level signal	ON	OFF	The local remote controller ON/OFF operations, and the controller ON/OFF operations and prohibit/enable change operations will be prohibited.
4	Perform ON/OFF, prohibit/enable with pulse signals.	ON	ON	Set the pulse width while the contact is ON to 0.5 to 1 sec.

(2) Level signal and pulse signal (DC12V or DC24V)

(A) Level signal

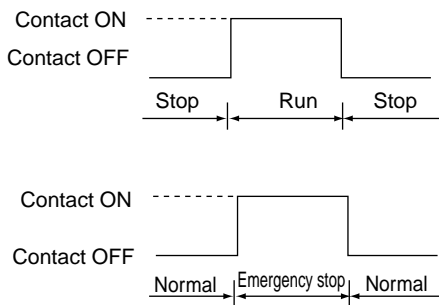

(B) Pulse signal

(Example) for ON/OFF

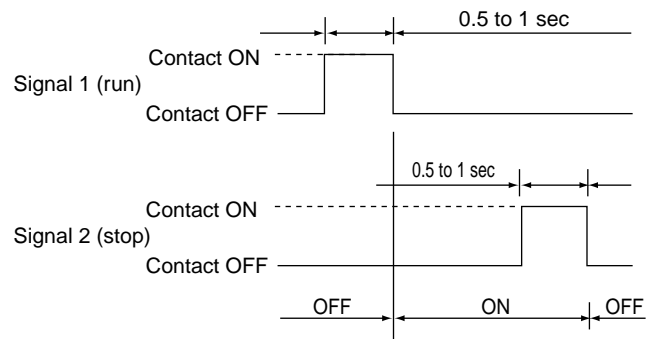

* The prohibit/enable input is the same.

(3) External input specifications

CN2	Lead wire	Emergency stop/normal level signal	ON/OFF, level signal	ON/OFF, prohibit/enable pulse signal
No.5	Orange	Emergency stop/normal input	ON/OFF input	ON input
No.6	Yellow	Not used	Not used	OFF input
No.7	Blue	Not used	Not used	Local remote controller operation prohibit input
No.8	Gray	Not used	Not used	Local remote controller operation enable input
No.9	Red	External DC source "+"		

(A) For level signal

- ① When the emergency stop/normal signal is selected, the status will change from normal to emergency stop when the external input signal contact changes from OFF to ON, and will change from emergency stop to normal when the contact changes from ON to OFF.
- ② When the ON/OFF signal is selected, the status will change from OFF to ON when the external input signal contact changes from OFF to ON, and will change from ON to OFF when the contact changes from ON to OFF.

(B) For pulse signal

- ① Even if the ON signal is input during ON, the status will remain ON.
- ② If the local remote controller is prohibited, the ON/OFF operation mode and temperature setting operations by the local remote controller will be prohibited.
- ③ Set the pulse width (contact ON time) to 0.5 to 1 sec.

(4) Recommended circuit example

(A) For level signal

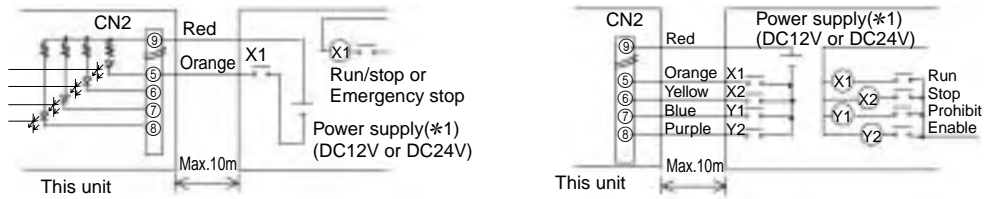

- ① The contact relay, DC power source, extension cable, etc., must be prepared separately at the site.
- ② The connection cable can be extended up to 10m. (Use a 0.3mm² or larger wire.)
- ③ Strip the extra cable near the connector, and securely insulate the exposed section with tape, etc.

2. External signal output function

* External signal output requires the external I/o adapter (Model: PAC-YG10HA-E) sold separately.

(1) External output

When one or more air conditioners are running, the "ON" signal will be output and if a malfunction occurs in one or more air conditioners, the "Malfunction" signal will be shown.

(2) External output specifications

CN 2	Lead wire	Details of each terminal
No.1	Green	Common (External ground)
No.2	Black	ON/OFF
No.3	Brown	Malfunction/normal
No.9	Red	Common (External power supply) (*1)

① "ON" signal and "Malfunction" signal will both be output.

(3) Recommended circuit example

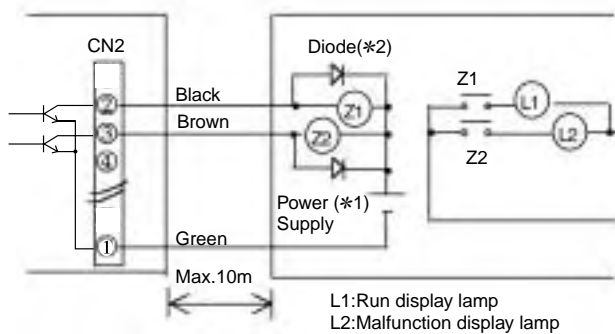

Use Z1 and Z2 relays having the following specifications.
 Operation coil : DC12V, DC24V
 Rated voltage : DC12V, DC24V
 Power Consumption : 0.9W or less
 (*1) Prepare a power supply separately according to the relay being used. (DC12V or DC24V)
 (*2) Always insert a diode on both ends of the relay coil.

- ① Each element will turn on while ON operation or a malfunction occurs.
- ② The connection cable can be extended up to 10m.
- ③ The relays, lamps, diodes and extension cables, etc, must be prepared separately at the site.

CAUTION

When connecting the external input/output cables to connector CN2 on the controller, Peel off the label on the controller connector section.

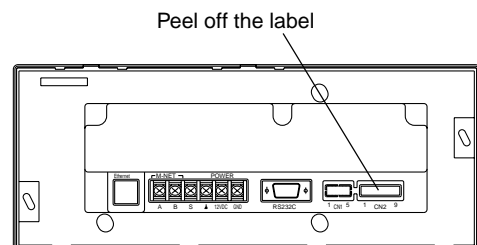

3. LAN connection function

When using the LAN connection function, connect the LAN cable to the Ethernet connector of this device.

- * Procure the LAN cable at the site, and use an enhanced category 5UTP cable.
- * For a description of the IP address setting method, refer to Installation Manual.
- * LAN is 10 BASE-T Specification.

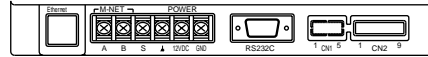

NOTE

- * Perform the LAN wiring before installation, and wire up to the body by the same method as wiring the M-NET transmission line.
- * When a LAN is already connected, decide the IP address by consultation with the system administrator and connect to the LAN body after changing the IP address.
- * When connecting an LAN connector, space for the connector and wiring is required. Provide this space at this unit and the rear of the electric box. Refer to Installation Manual.
- * When the G-50A cover is opened, the LAN status lamp and LAN changeover switch are accessed. For detailed information, refer to sections 3-2 and 5-9 of the Instruction Book.

4. RS232C connection function

When using an RS232C port, connect the cable to the RS232C connector of this device.

- * The RS232C cable is procured at the site, and the connector of the cable that connects to this device is a D-Sub9pin (female). RS-232C cable is maximum 15m.
- * When using an RS-232C cable, to suppress the noise radiated from the RS-232C communication line, always procure the option Model PAC-YG11FC-E and install it so that the RS-232C communication line is inserted near the D-sub connector of the G-50A.

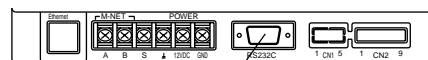

Remove the cap

NOTE

- * When installing G-50A to the electric box, the D-sub connector does not pass through the conduit. In this case, use a type that can be separated from the D-sub connector cable. Remove the D-sub connector from the cable, pass the cable through the conduit, connect the cable to the D-sub connector using solder, etc., and then connect the D-sub connector to this unit.
- * When connecting the RS-232C connector, a connector and wiring space is required. Provide this space at this unit and the rear of the electric box. Refer to Installation Manual.
- * Wire the RS-232C before installation, and wire up to the body by the same method as wiring the M-NET transmission line.

■ Browser screen



Condition List (Overview)



Condition List (Block)



Operation



Malfunction List

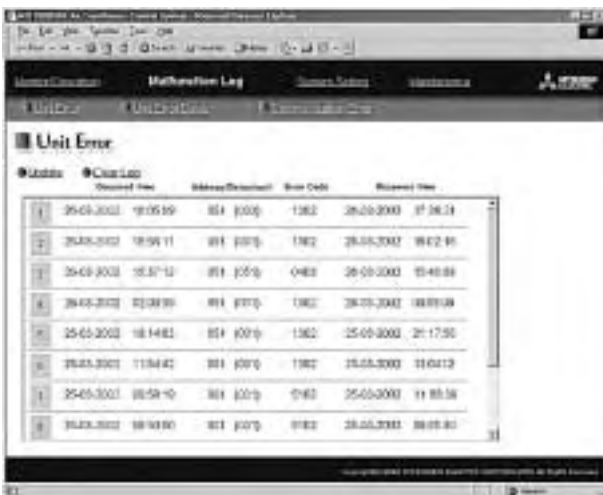

Malfunction Log



Weekly Schedule

3-5-2 TG-2000A

(1) Example of Basic System Configuration.

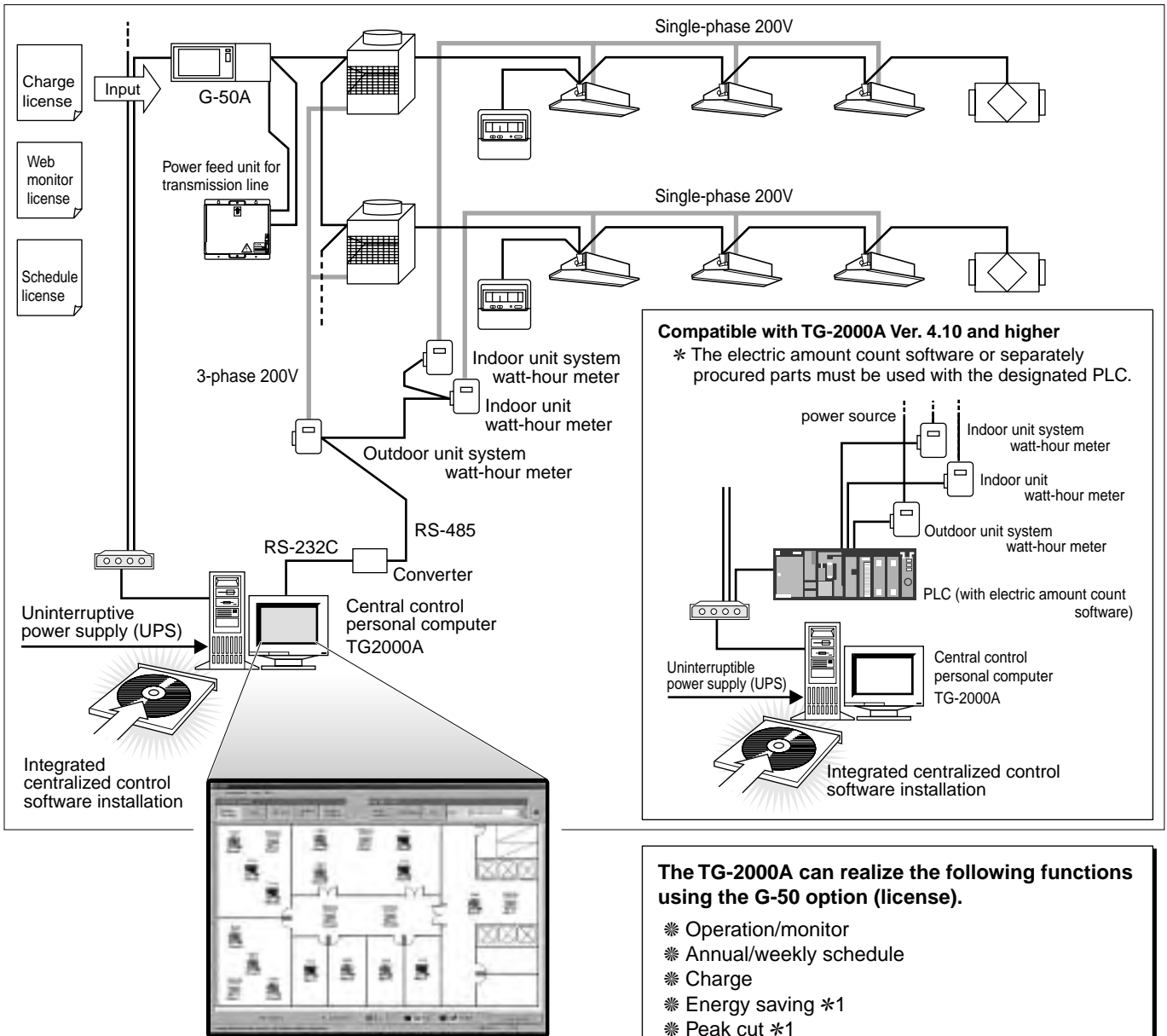

■ Main features of TG-2000A

- ① Up to 2000 indoor units (40 G-50A units) can be operated and monitored simultaneously.
- ② The air-conditioner layout can be displayed on the screen, making control and operation easier.
- ③ The annual and weekly schedules can be set. Two schedules, such as the summer master and winter master, can be saved in the weekly schedule.
- ④ Air-conditioning charges can be calculated based on the multiple air-conditioner usage results. The power apportionment percentage data and apportioned power rate can be calculated for each indoor unit using the power apportionment function, and can be output as a CSV format file. * Power apportionment charging is not possible with the old model, A control or K control.
 - Charging without WHM : The user manually inputs the power rate to calculate the air-conditioning charges. (Using a tool)
 - RS-485 WHM charging : The RS-485 WHM value is automatically tabulated to calculate the air-conditioning charges.
 - PLC + pulse WHM charging : The pulse output WHM value is automatically tabulated by the PLC to calculate the air-conditioning charges.
- ⑤ Energy saving operation is possible using the "ON/OFF", "set temperature change", "fan operation changeover" and "performance save operation (60% to 90%)" functions.

Energy saving operation matching the amount of power in use is possible by using the PLC's electric amount count software.
- ⑥ Defrost protection operation is possible with schedule settings. *1
- ⑦ General equipment can be operated and monitored. *2

*1: Compatible with TG-2000A Ver. 4.10 and higher, G-50A Ver. 2.50 and higher.

*2: Compatible with TG-2000A Ver. 4.30 and higher, G-50A Ver. 2.50 and higher.

(2) List of functions

The data for each G-50A can be grouped and used to control the operation of up to 2000 units in floor or block units, etc., from the personal computer screen. By using a PLC or a watt-hour meter, the power rate can be apportioned, energy saving control can be executed, and other general equipment can be controlled.

List of integral software functions

Item	Details	G-50 license				
		Web monitor	Charge	Schedule	Energy saving	Energy saving (peak cut)
ON/OFF	The units can be turned ON and OFF for all floors or in block, floor or group units.	√				
	The general equipment can be turned ON and OFF. (* A PLC and the general equipment control PLC software required.) *2	√				
Operation modes	The operation mode can be switched between COOL, DRY, FAN, AUTO and HEAT for all floors or in block, floor or group units.	√				
Temperature setting	The room temperature can be set for all floors or in block, floor or group units. Set temperature range COOL / DRY : 19°C to 30°C HEAT : 17°C to 28°C AUTO : 19°C to 28°C * Depend on unit type	√				
Fan speed	The fan speed can be set to four stages for all floors or in block, floor or group units.	√				
Air direction	The air direction can be set in four vertical directions or to swing for all floors or in block, floor or group units. (The selectable air direction differs according to the model.)	√				
Interlocked unit ON/OFF (LOSSNAY)	If there is an interlocked unit (LOSSNAY), the unit can be turned ON (strong/weak) or OFF for all floors or in block, floor or group units. (Note that the ventilation mode cannot be selected for interlocked units.)	√				
Local operation prohibit	The items for which operation with the local remote controller are to be prohibited can be selected for all floors or in block, floor or group units. (The items that can be prohibited are ON/OFF, operation mode, set temperature and filter sign reset.)	√				
Annual / weekly schedule	The annual/weekly schedule function can be used by registering the license. Two settings, such as seasonal settings for summer and winter, can be saved.	√		√		
Power rate apportionment charging (power rate manual input)	By registering the G-50A unit license number, the power rate apportionment percentage data for each indoor unit can be output in CSV format. The power rate for each tenant can be easily calculated by having each user input the power rate manually.	√	√			
Power rate apportionment charging	An RS-485 watt-hour meter is connected to calculate the air-conditioning charges based on the amount each tenant's air-conditioner has operated. Two charging rates can be applied per day.	√	√			
	By using a PLC (with electric amount count software) and a watt-hour meter with pulse transmitter, the air-conditioning charges can be calculated based on the amount each tenant's air-conditioner has operated. Up to five charging rates can be applied per day. *1	√	√			
History	Up to 3000 items for the error history and up to 10000 items for operation history can be saved. Each history file can be output as a daily report or monthly report in CSV format. The operation history consists only of the operations carried out with the TG-2000A, and is limited to some limited operation items.	√				
Operation time monitor	The cumulative operation time of each indoor unit can be viewed or output as a CSV format file. (This function is valid only when the charging function license is registered.)	√	√			
Filter sign display mask	Automatic display of the filter sign can be disabled. (System batch.) In this case, the filter sign state is confirmed with manual operations.	√				
Energy saving control *1	Energy saving operation is possible using the "ON/OFF", "set temperature change", "fan operation changeover" and "performance save operation" functions.	√			√	
Energy saving (peak cut) *1	Energy saving operation matching the amount of power in use is possible. (PLC (with electric amount count software) and watt-hour meter with pulse transmitter are required.)	√				√
Frost protect *1	Heating from 12°C and higher can be set using the schedule.	√				
Set temperature limit *1	The set temperature lower limit can be set for cooling and the upper limit for heating.	√				

*1: Compatible with TG-2000A Ver. 4.10 and higher, G-50A Ver. 2.50 and higher.

*2: Compatible with TG-2000A Ver. 4.30 and higher, G-50A Ver. 2.50 and higher.

(3) Screen images



Floor screen



Weekly schedule screen



Block screen



Annual schedule screen

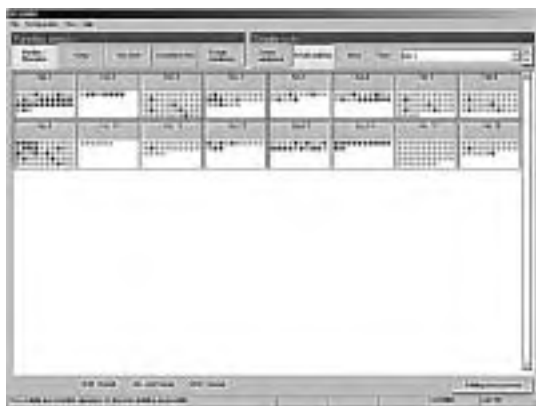

All floor screen

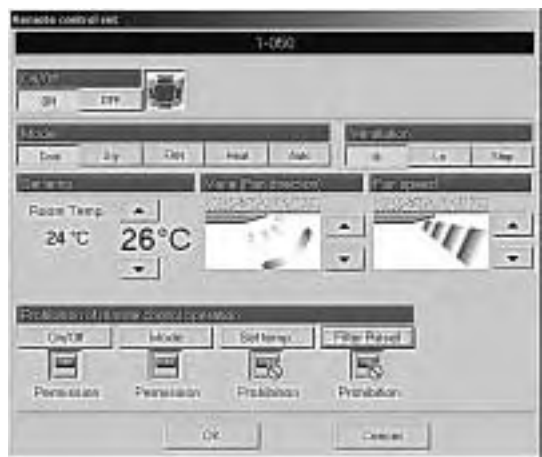

Operation setting screen



Air-conditioning charge screen

(4) Requirements (system recommendations)

We recommend the following software and hardware when using this application (TG-2000A).

Item	Requirement	Recommended
PC	PC/AT interchangeable machine	Operation check completed, using IBM, COMPAQ, and DELL
CPU	Within 1000 indoor units : Pentium 4 1.8GHz or faster 1001 indoor units or over : Pentium 4 1.8GHz or faster (Case of temp, trend use : 2.8GHz or faster.)	Pentium 4 2.8GHz or faster
Memory	128MB or more (In Windows XP : 256MB or more)	256MB or more
HDD	6GB or more (2GB or more of C drive free space necessary)	4GB or more of C drive free space necessary When using the trend function, the drive used for automatic output must have the following free space according to the number of groups. 200 groups = 2GB, 500 groups = 5GB, 1000 groups = 10GB, 2000 groups = 20GB
Storage device	FDD, CD-ROM drive	Devices other than those shown at the left may also be installed.
Resolution	1024 X 768 or higher, 65536 colors or more	
Serial port	1 port or more	Required when using RS-485 communication WHM
LAN	Internal LAN (10/100 Mbps)	*1
OS	Windows XP Professional Windows 2000 Professional Service Pack 2 and above	English version only * Personal computer must support each OS.
Other	Computer must be dedicated for this use (TG-2000A).	

*1 Purchase the option, or use the equipment recommended for the personal computer when purchasing the personal computer.

(5) Compatible Units

The TG-2000A has two main functions: air conditioner controller and cost accounting. However, not all functions are available with all air conditioners.

Table: Compatible units and function list (○ : supported, △ : Certain restrictions apply, × : Not supported)

Function Model	Control/ Maintenance	Charging (Billing) without WHM	Charging (Billing) with WHM
Y series	○		○ *1
Super Y series	○		○ *1
R2 series	○		○ *1
WR2 series	○		○ *1
WY series	○		○ *1
Multi S series	○		○ *1
Free plan Indoor unit	○		○ *1
Free plan LOSSNAY	○	×	△ (A separate watt hour meter is required. Billing is done with watt-hour units)
OA processing unit	○	×	△ (A separate watt hour meter is *2 required. Billing is done with watt-hour units(Only the fan part))
"A" control type	○ (Adapter required)	×	△ (A separate watt hour meter is required. Billing is done with watt-hour units)
"K" control type	○ (Adapter required)	×	△ (A separate watt hour meter is required. Billing is done with watt-hour units)

*1 : Can be calculated for each charging block.

May not be available with some older models.

*2 : When used with IC attributes, it becomes the same as an indoor unit and billing is possible.

Example

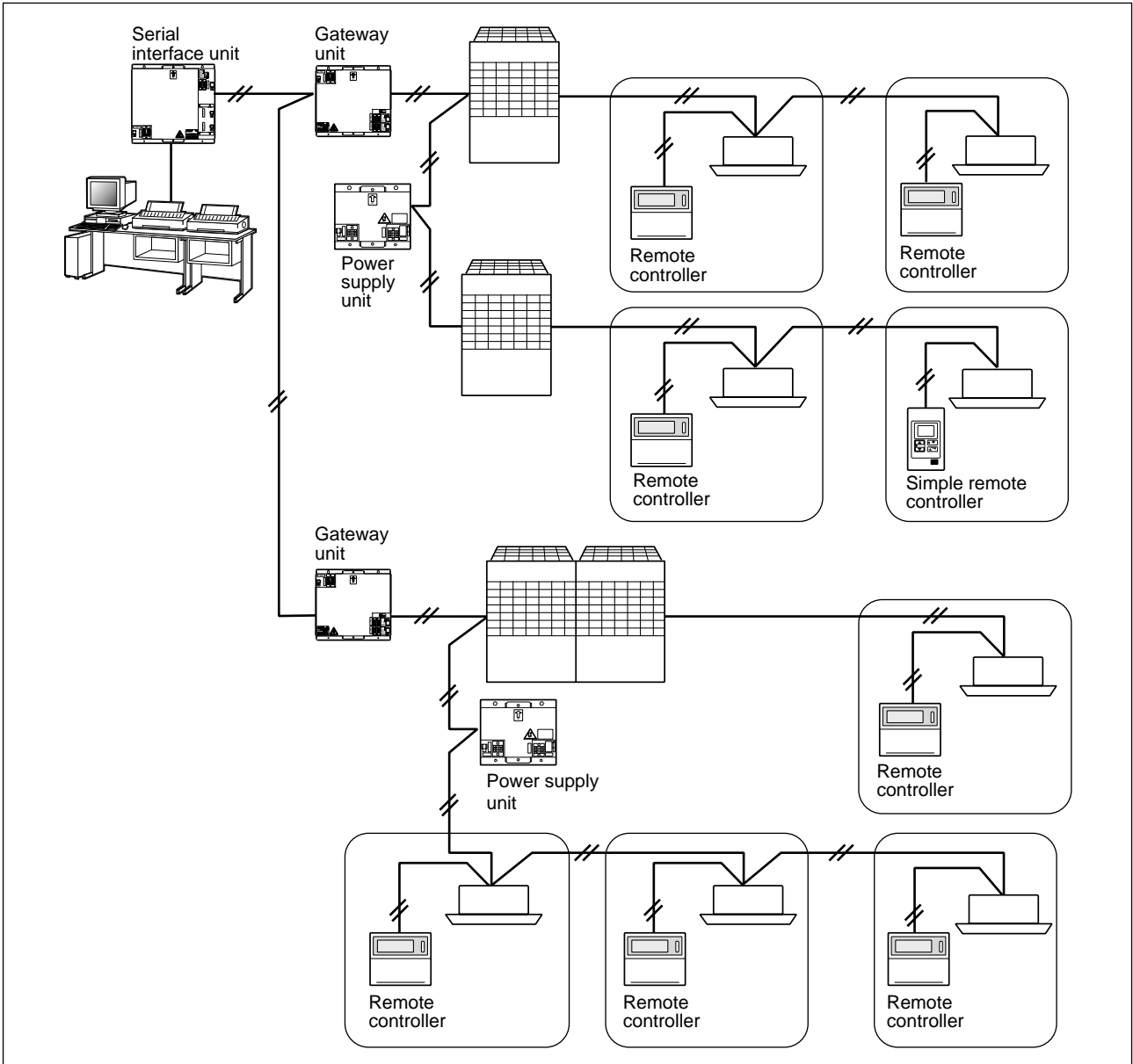

● Main features of MB-300 system

* The air-conditioner can be centrally controlled from the building control system by connecting the building control system and air-conditioner with serial communication (RS-232-C).

1. MB-300

■ Functions

Functions of main controller
<Standard functions>

Function		MB-300	Remarks
Separation of operating window Password for maintenance window		The exact nature of operation depends on the specification of the building management system.	
Monitoring	Operation & setting	ON/OFF	The building management system is capable of performing ON/OFF operation by group unit. The building management system is also capable of monitoring ON/OFF status.
		Operation mode	The building management system is able to switch and monitor operation modes (cool, heat, fan, dry) by group unit.
		Set temperature	The building management system is able to set and monitor the temperature by group unit. Set temperature range (in 1°C unit) COOL/DRY 19°C - 30°C HEAT 17°C - 28°C
		Air speed	Operation cannot be performed by the building management system.
		Remote controller prohibit / permit	The building management system is capable of setting and monitoring the inactivation/activation of local remote controller operation by group unit. When an inactivation has been set, operation by the local remote controller is disabled and only operation by the building management system is possible. It is possible to individually disable/enable operation functions (ON/OFF, operation mode, temperature) of the local remote controller.
		Abnormality monitor	The building management system keeps track of error occurrence. It keeps track of the error code and the unit address of the unit from where there error is occurring.
	Room temperature monitor	The room temperature is monitored by monitoring requests from the building management system.	
Control	Calendar function	The calendar and schedule function vary depending on the specification of the building management system.	
	Scheduled ON/OFF control		
Measurement	Operation time accumulation	The power save amount is totaled for each unit by request from the building management system. The total count is calculated at the 15 and 45 minute mark every hour. The total count will increase until 999999 and when the count exceeds this number, it will loop and start at 0. This counter can also be freely preset by the building management system.	
Record	Abnormality history	Recording varies depending on the specification of the building management system.	
	Operation history		
	Daily and monthly reports		
Control	Grouping	The monitor display and the operation method varies depending on the specification of the building management system.	
	Plane image setting (CRT display)		
Application	Input operation		
	Summer time		

2. Basic configuration

Basic configuration

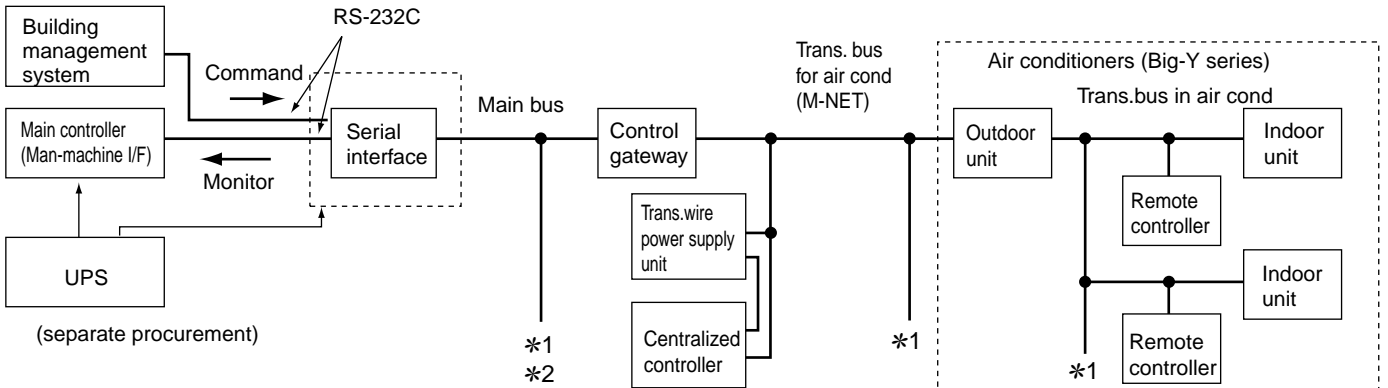

Deliverable equipment list

Description	Function
Main controller	Man-machine device to monitor, operate, and record air conditioners
Serial I/F	Interface for host system to exchange comm. data with MELANS main bus
Control gateway	Exchanges comm. data between MELANS main bus and air-cond. transmission bus
Centralized controller	Centrally controls each group for backup when host system cannot control M-NET units due to trouble
Trans. wire power supply unit	Provides DC power to air-conditioner transmission bus to communicate each unit connected to air-conditioner transmission bus
Remote controller	Operates and monitors the Y, R2, Super-Y series air conditioners

Notes *1 Continued to similar organization (omitted)

*2 Adding gateway board enables extension of air conditioners. G/W = max.20 units

Figure 1. 2 Restriction on wiring

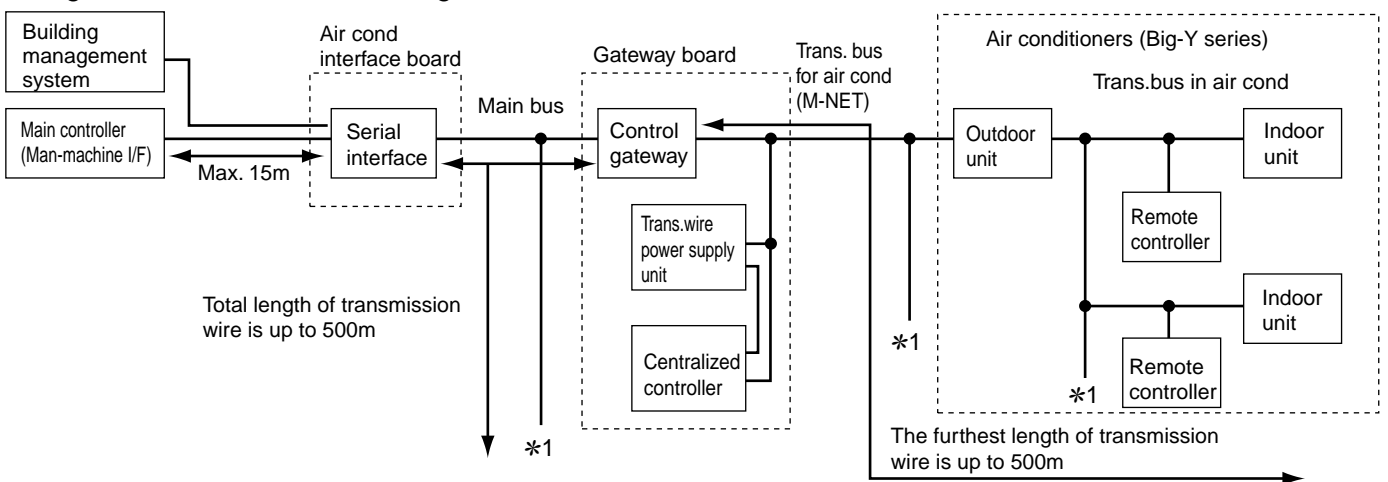

Notes *1 Continued to similar organization (omitted)

3. Serial Interface unit (IFU-1000SA)

■ Specification

Source power	Input voltage	AC220V~AC240V, 0.1A(Maximum loading) / 50Hz, Single-phase	
	Fuse:	2.0A Time-delay type (IEC-127-2 S.S.3)	
Interface condition for transmission line	MAIN-BUS transmission line ; AMI signal		
	RS-232C transmission line ; V.24/V.28 Pin Arrangement 1: FG, 2: SD, 3: RD, 4: RS, 5: CS, 6: DR, 7: SG, 8: CD, 20: ER		
Environmental condition	Temperature	Operating	0~40°C
		Non operating	0~70°C
	Humidity	30~90%RH(No condensation)	
Dimensions	380(High) X 400(Width) X 59.2(Depth)		
Weight	3.6kg		

■ External dimension

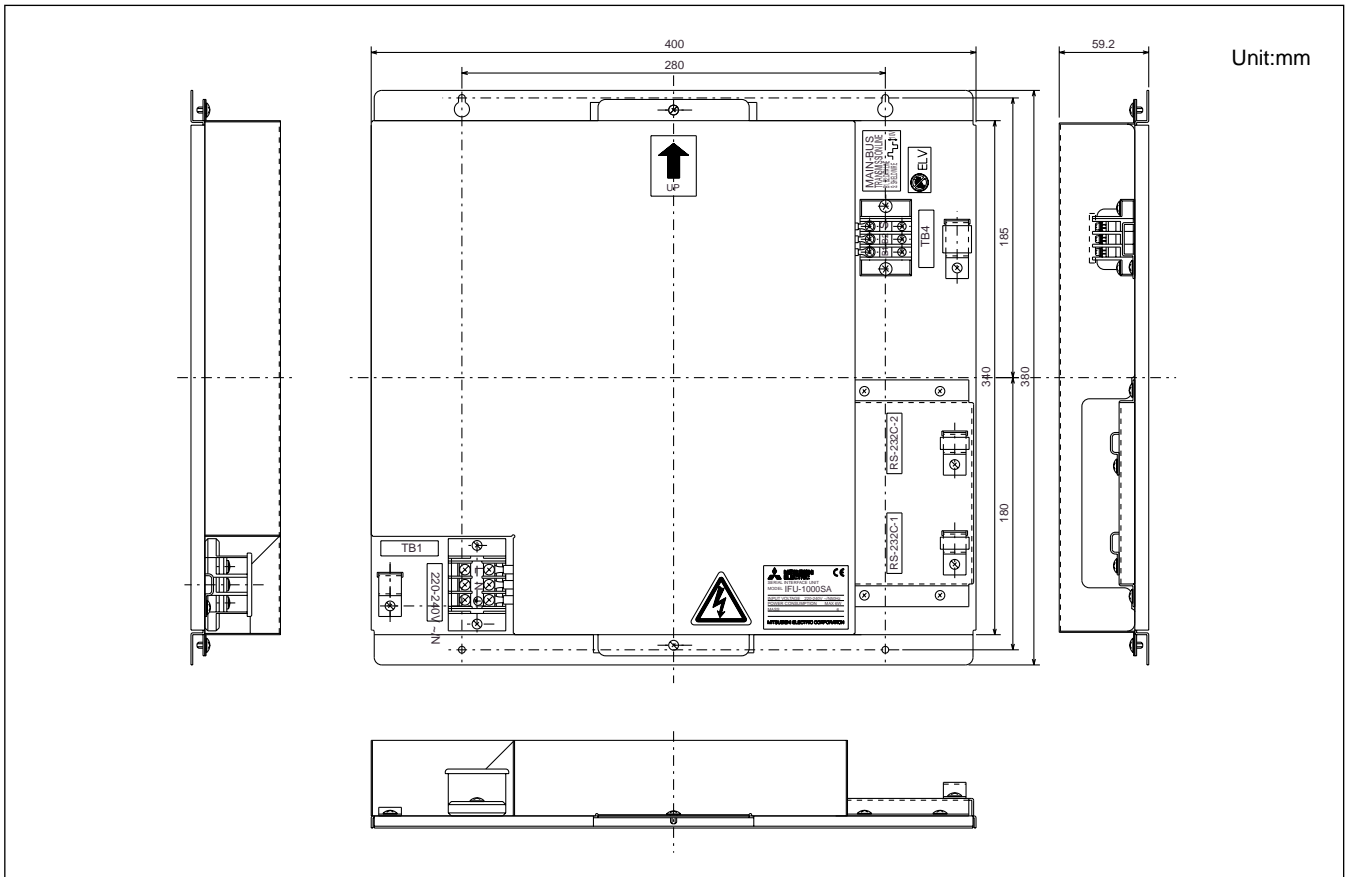

■ Parts prepared at site

Please prepare the following parts before installation of the unit.

Preparation parts	Specification
Unit fixing screw	M4 screw X 4 pcs
Power cable Protective earth cable	Please prepare the power cable complied with your applicable technical standard in consider with power requirement of the unit. *Recommend type; $\phi 1.5\text{mm} \sim \phi 2.0\text{mm}$ (H03VV-F, H03VVH2-F, H05VV-F, H05VVH2-F2)
Main power switch (Circuit breaker)	Qty. : 1 pc Type : 250VAC Single-phase 50Hz 3A *Recommend type; CP30-BA series (MITSUBISHI ELECTRIC) or equivalent.
Transmission cable	1. MAIN-BUS transmission line: Sheathed vinyl cords or cable which comply with the following specification or equivalent. CPEVS $\phi 1.2\text{mm} \sim \phi 1.6\text{mm}$ CVVS $1.25\text{mm}^2 \sim 2\text{mm}^2$ *CPEV; PE insulated, PCV jacketed shielded communication cable *CVVS; PVC insulated, PVC jacketed shielded control cable 2. RS-232C transmission line: Please prepare the RS-232C cable which comply with the pin arrangement in "Specification". NOTE Cable length; There is a limitation for the transmission line. Please refer to section "System limitation".

4. Gateway unit (GW-50A)

■ Specification

Source power requirement	Input voltage	AC220V~AC240V ; 0.1A/50Hz Single-phase	
	Fuse	2.0A Time-delay type (IEC-127-2 S.S.3)	
Interface condition for transmission line	MAIN-BUS transmission line ; AMI signal M-NET transmission line ; DC30V+AMI signal		
Environmental condition	Temperature	Operating	0~40°C
		Non operating	0~70°C
	Humidity	30~90%RH(No condensation)	
Dimensions	340(Height) X 360(Width) X 59.2(Depth)		
Weight	3.2kg		

■ External dimension

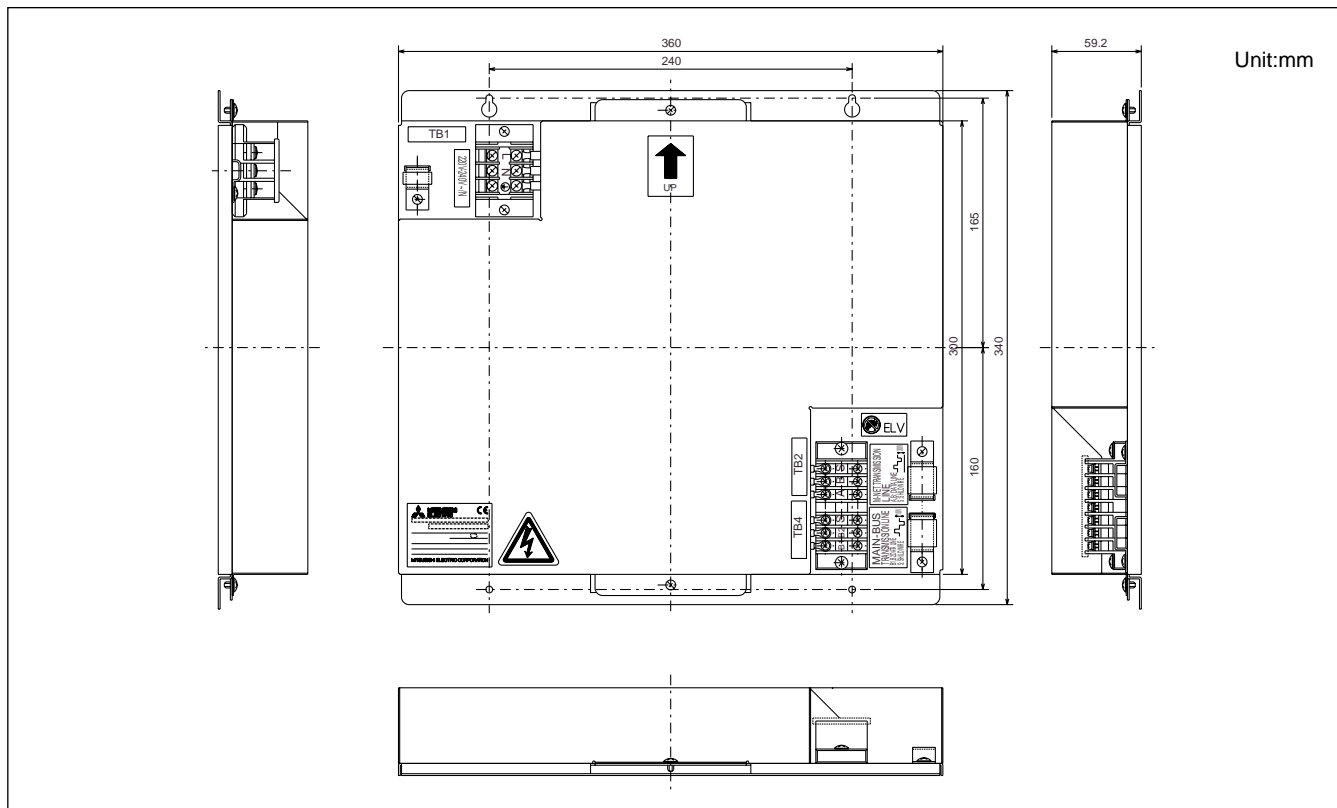

3-6 Air conditioner interface (LMAPO2-E)

- **Achieve an open network by using LONWORKS.**
 The demand is growing for open network systems that cater for demands such as the ability to freely select the facility equipment that will connect to the building management system regardless of maker or demands to cut back on the interface kit or gateway that links the building management system with the facility equipment. By using LONWORKS, Mitsubishi Electric has achieved an open network for operation information at the remote controller level for the multiple air conditioner units used in a building.
- **This has created the potential for system architectures that require simpler design and reduced labor cost.**
 By first making the functional profile (protocol specification) open, the onsite system integrators can enjoy design freedom. Furthermore, because LONWORKS provides a means for each facility equipment to connect to a single network, you can cut back on the wiring labor cost as your system will require less wiring.
- **One LM ADAPTER unit can connect up to 50 indoor units.**
 Using a single LONWORKS adapter (LM ADAPTER), you can connect up to a maximum of 50 indoor units.

	Item
Operation	Request On/Off
	Request Mode
	Setpoint from network(Both cool and heat)
	Request Fanspeed
	Request Local Prohibit On/Off
	Request Local Prohibit mode
	Request Local Prohibit SetPoint
	Request All Off
Monitor	On/Off run state
	Mode state
	Setpoint state(both cool and heat)
	FanSpeed state
	Thermo On/Off state
	Temperature state of indoor
	Alarm state
	Local Prohibit On/Off state
	Local Prohibit mode state
Local Prohibit SetPoint state	

■ System example

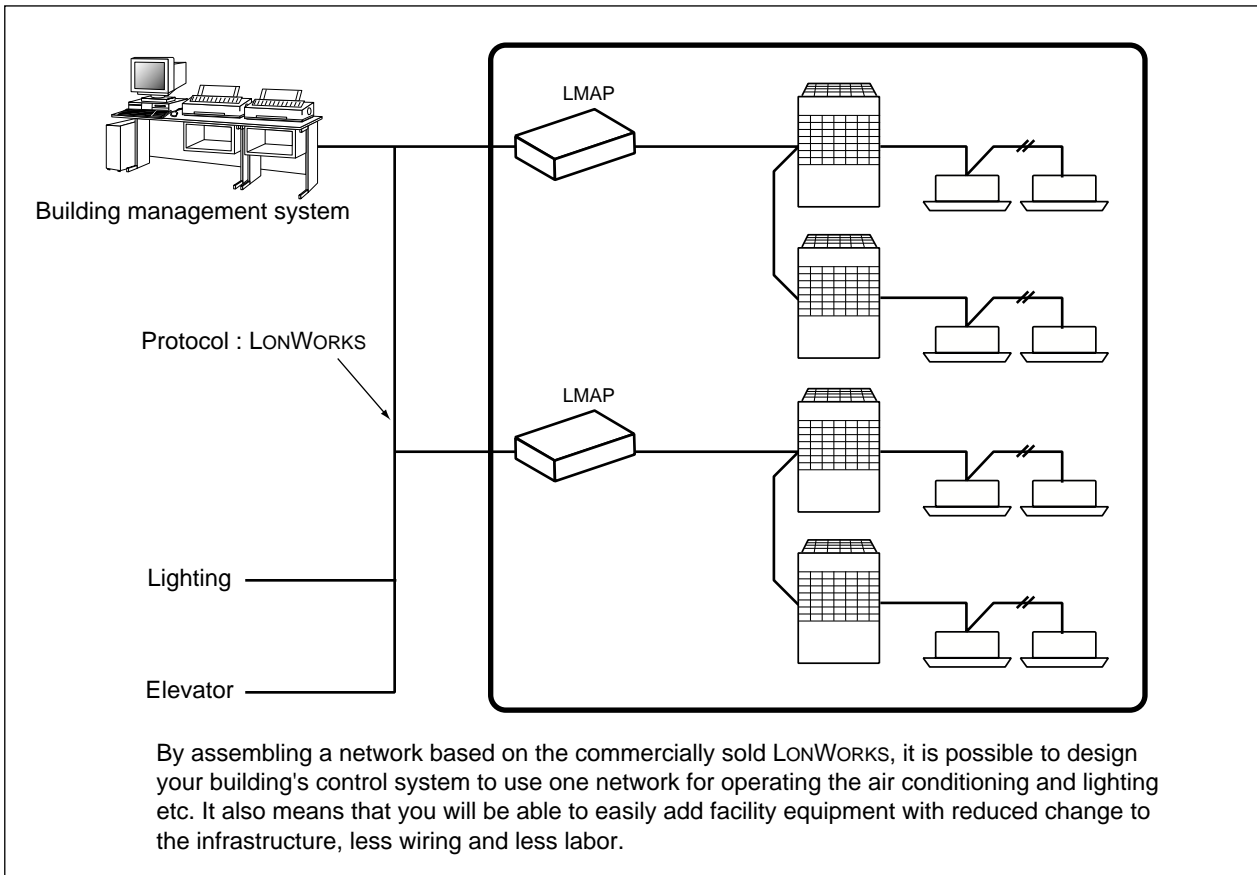

■ Environment specification

Item	Description	
Connected Equipment	MITSUBISHI ELECTRIC Multiple split type air conditioners CITY MULTI Split-type air conditioners Mr.SLIM Heat recovery ventilators LOSSNAY (*For details of the connected models, please contact the dealer.)	
Number of Units	LM-AP can control 50 indoor units (including LOSSNAY)	
Neuron CHIP	TMPN3150 (10MHz)	
Network Transceiver	FTT-10A (Free Topology 78kbps)	
Performance	Average communication capacity	2.5 inputs/second
	Peak communication capacity	50 inputs/second (for one second)

* The proper communication is not obtainable when communication intervals exceed its performance, assure sufficient intervals.
 * ACK Service is recommended for the network service.
 * Detailed specifications for the LONWORKS network can be found in "FTT-10A Free Topology Transceiver User's Guide" by Echelon Corporation.

<LMAP02-E Network Variables>

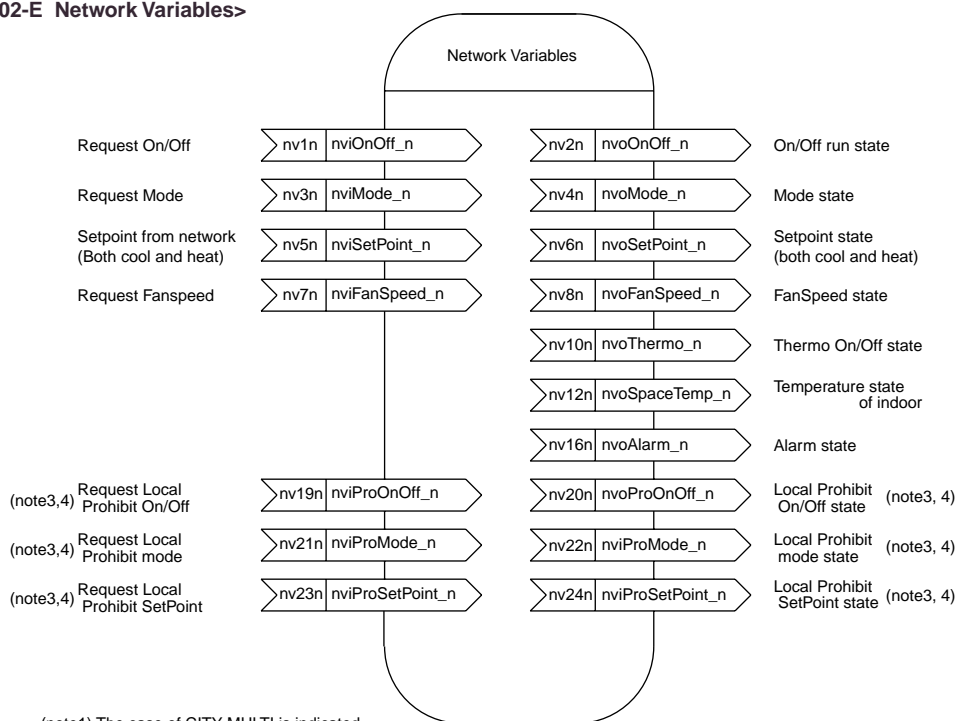

(note1) The case of CITY MULTI is indicated.
 (note2) There is a case which cannot be used with the system configuration of the air conditioners units.
 (note3) "n" of the network variable shows indoor unit address (M-NET).
 (note4) It is possible to use when the "MA" remote controller.

■ External dimension

Unit:mm

Item	Description		
Dimensions	340 (H) x 360 (W) x 59.6 (D) mm		
Net Weight	3.3 kg		
Power Source	~ 220 - 240V (50/60 Hz)		
Current Consumption	50 mA (Maximum)		
Operation Environment	Temperature	Operating Range	-15 to 43°C
		Storage Range	-20 to 60°C
	Humidity	30 to 95 RH (No condensation)	
Installation Environment	In the control box		

3-7 Power supply unit 3-7-1 PAC-SC34KUA

- This unit is recommended when the air conditioner system has up to two system controller units.
- This unit is designed to supply power to MELANS controllers and remote controllers. When your local remote controllers are not powered from the outside unit, always use it for local remote controllers as well.

■ System example

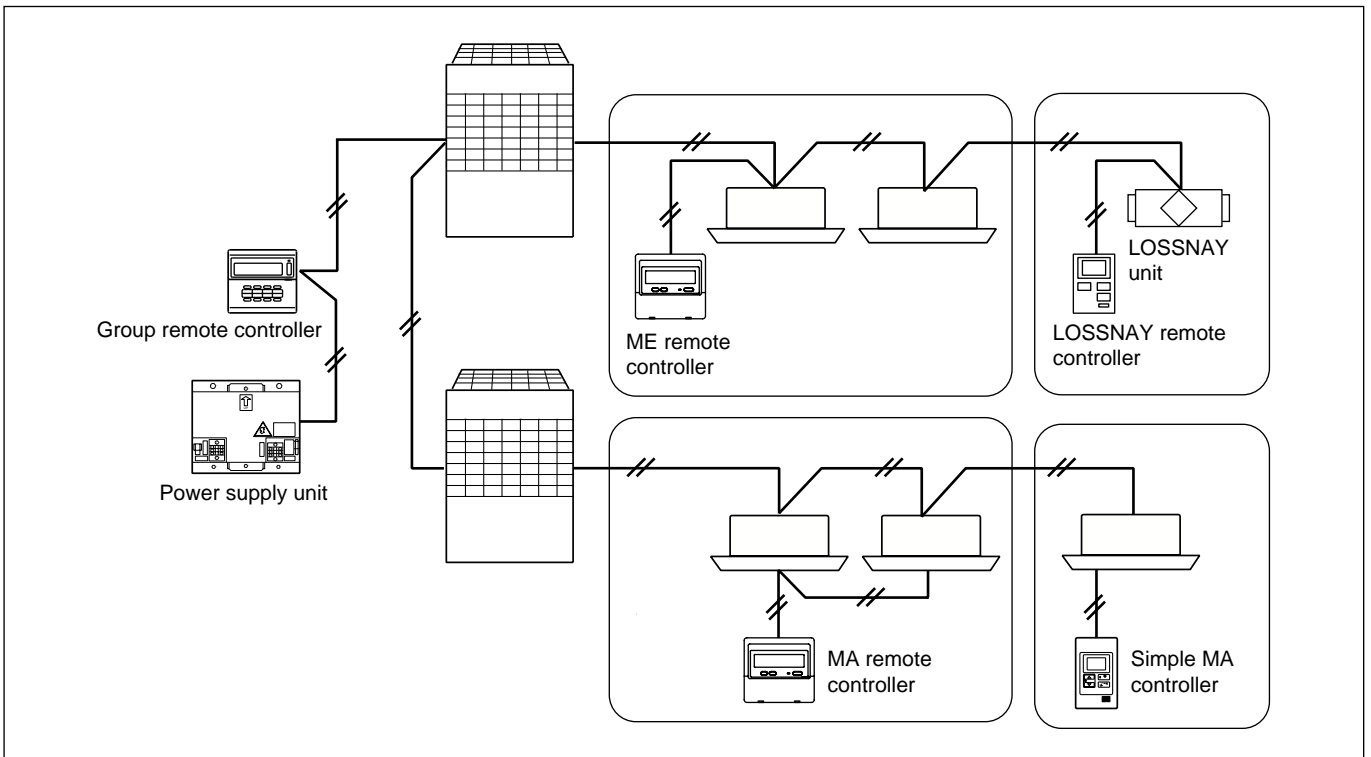

■ External dimension

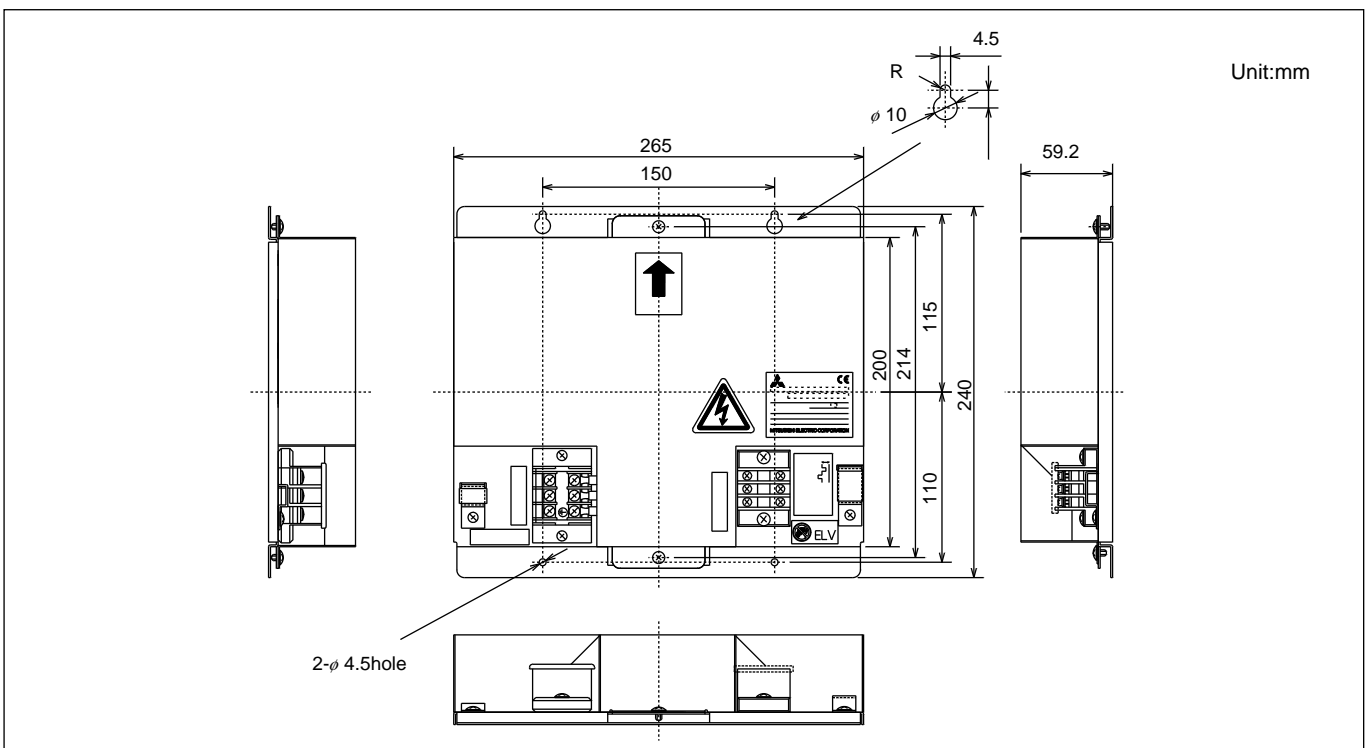

3-7-2 PAC-SC50KUA

- This unit supplies DC power to the central controller G-50A by means of the central controller system M-NET transmission line and DC power line.
 Number of the loading unit: G-50A Central Controller 1 unit
 In addition to one G-50A unit, a total of four PAC-SC30GRA/ SF44SRA/YT34STA units can be connected.
 (Up to two units can be connected when using the PAC-YT40ANRA.)

■ System example

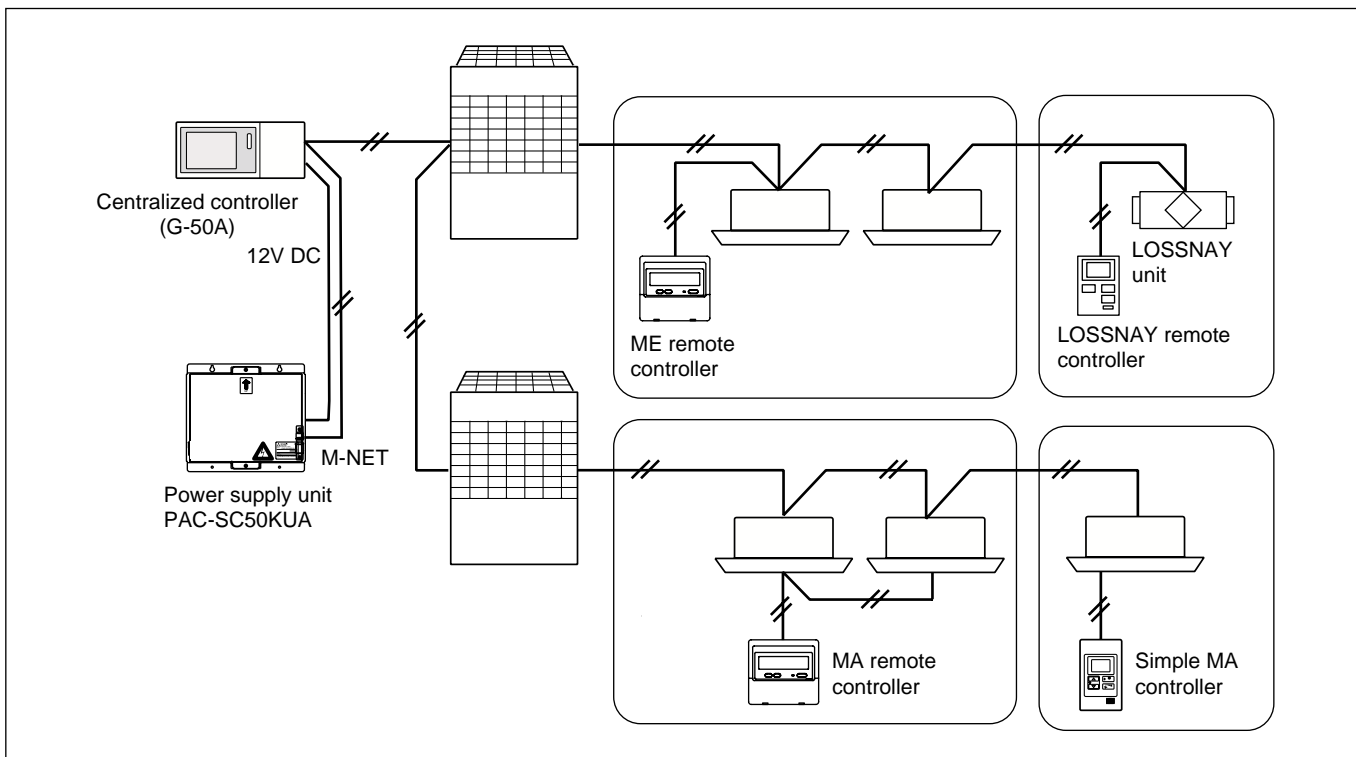

■ External dimension

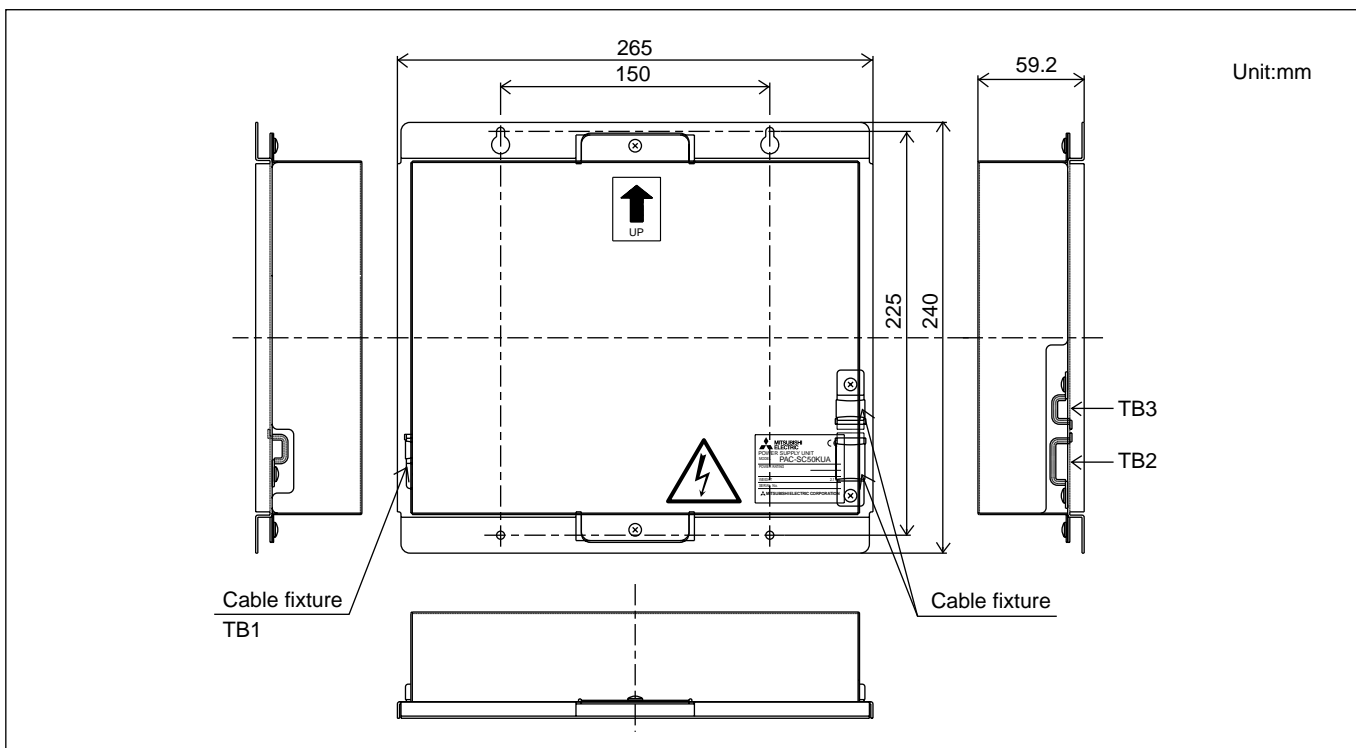

3-8 Transmission booster unit (PAC-SF46EPA)

- Use this unit when adding more Y (16HP, 20HP) or SUPER Y indoor units or local remote controllers. Requirement depends on the number of indoor units connected to the same refrigerant system.
- See the Y (16HP, 20HP) or SUPER Y installation documentation for more information.
- This unit is also suitable when adding more LOSSNAY remote controllers.
- Requirement depends on the performance of the unit supplying power to the signal cables and on the number of LOSSNAY remote controllers (PZ-52SF and PZ-52SKF2) that are connected. In this case, a power supply expansion unit for signal cables can provide power for up to 50 LOSSNAY remote controllers. Please use the power supply expansion unit for the signal cable if the power supply exceeds the amount prescribed in the following table.

■ System example

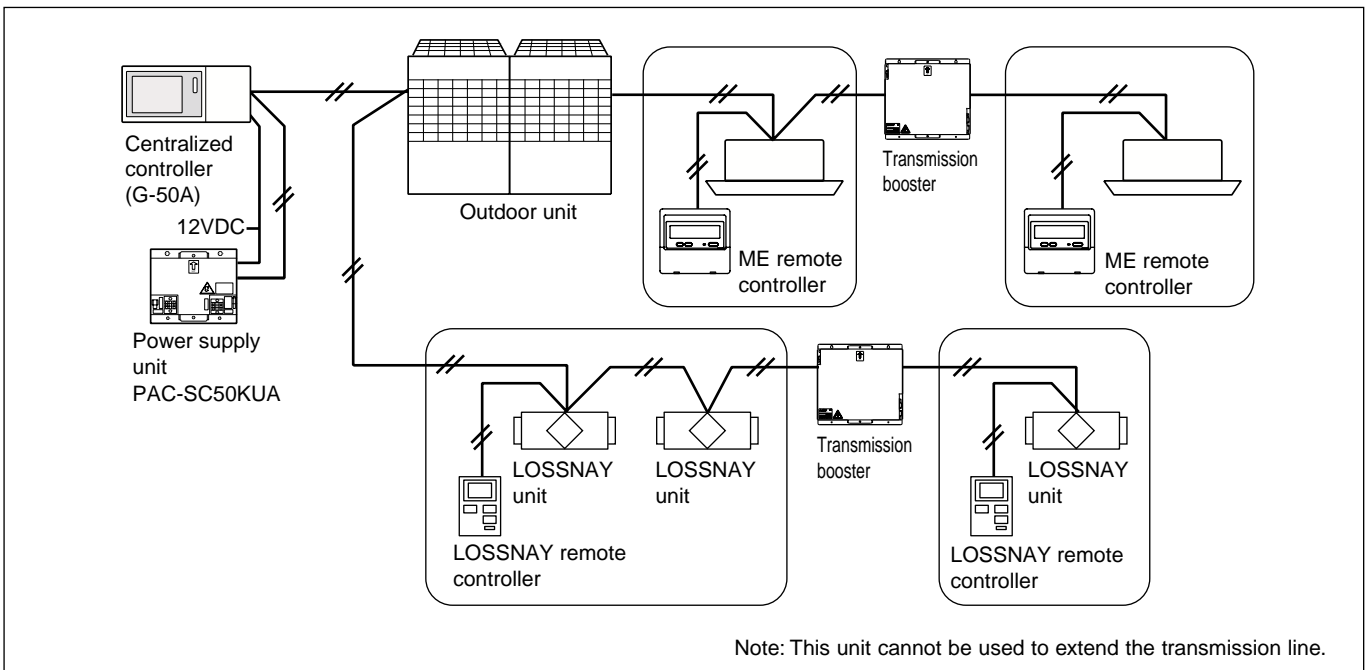

■ External dimension

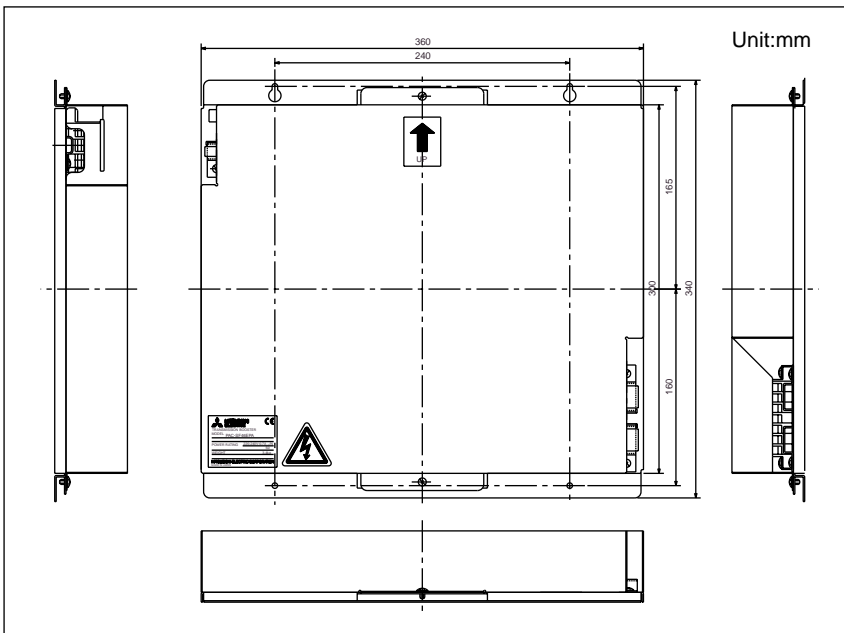

■ Restriction of connecting, LOSSNAY remote controller

Use the transmission booster, when the value of power supply to the remote controllers from the power supply unit over the one of the under table.

Power supply unit PAC-SC34KUA		LOSSNAY Remote controller	
Centralized controller Multi panel	0	30	
	1	26	
	2	22	
	3	18	
	4	14	

4. System component

In a multi air conditioner system that is a free plan direct-expansion type, a connector for inputting and outputting signals to/from the outside is fitted as standard on the control board of the indoor and outdoor units. Use this when you want each unit to input/output signals individually. (Note: When there are many control units it is recommended that you use MELANS. This would enable you to save on labor.) In order to have an input output signal from each connector, you must have a dedicated adapter (sold separately) and a relay circuit (onsite arrangements).

Note : See next page for actual examples of use.

■ Types of control that uses connectors for the outdoor unit input output signal (connection for each type of option).

Category	Application	Function	Connector		
			Y, Super Y	R2,Big R2	WR2
Input	Method of disabling cool and heat operation (thermo off) by input from the outside to the outdoor unit.	Comp ON/OFF	CN3S	CN3D	—
	The low noise operation of the indoor unit can be commenced by the external input to the outdoor unit.(The night mode can be adapted only under the outdoor temperature condition of 30°C or less for cooling and 3°C or more for heating)	Night mode	CN3D	CN3D	—
	You can switch the operation mode between cooling and heating by input from the outside to the outdoor unit.	Autochangeover		—	
Output	Method of receiving a signal from the outdoor unit to the outside. * Can be used as a device that displays the operation state. * Can be used as an interlocked control with external equipment.	Compressor is run state	CN51	CN51	CN51
		Error state			

■ Types of control that uses connectors for the indoor unit input output signal (connection for each type of option)

Category	Application	Function	Connector
Input (Note 2,3)	Method of ON/OFF control by turning on and off switches or contacts from an outside to each indoor unit group. Can be used as a timer adapter (Note 1) Can be used as a "forget to switch off prevention" or "forced stop".	Distant/local switching (note 1)	CN32
		ON/OFF (level)	
	Method of ON/OFF control by inverting start/stop using external pulse (a-contact) for each indoor unit group.	ON/OFF (pulse)	CN51
Output	Method of sending signals to outside for each indoor unit group. It can be used as a device to display operation states. It can be used as an interlocked control with the external equipment.	Operation state	CN51
		Error state	
		Operation mode (heat) state	CN52
		Operation mode (cool, dry) state	
	Thermo ON (fan) state		

Note 1: Connect the signal input only to the principal unit in a group.

(However, the demand input is required to enter into indoor units individually.)

Note 2: When using start/stop input at group operation, Local remote controller is necessary.

(MA remote controller or M-NET remote controller)

Note 3: When setting to Remote, operation can not be performed from Local remote controller.

The remote controller displays [CENTRALLY CONTROLLED].

Note 4: When using start/stop input at group operation, [Automatic address start-up] can not be performed.

Note 5: When CN51 or CN52 is commonly used as an output signal, be sure to use the remote display kit.

Note 6: The remote display kit can be used for the input signal of CN51 and CN52.

Note 7: Connect to the principal unit only when using [Operating status] or [Operation mode (Heating/Cooling-Dry) of signal output. Connect to indoor units individually when using [Error status] or [Thermostat ON (or fan) status]

It is possible to have ON/OFF control by turning the indoor unit power on and off. You can select functions by setting the DipSW1-9 and 1-10 on the indoor unit.

■ Types of ON/OFF control (indoor unit settings)

It is possible to have ON/OFF control for each indoor unit (or group) by dip switches 9 and 10 (SW1-9, SW1-10) of the indoor unit.

Function	Operation when indoor unit recovers	Setting SW2 (note 1)	
		9	10
All auto restart	All indoor units will always restart regardless of the state that was before the power was turned off (POWER OFF) (after 5 minutes).	—	ON
Auto recovery	Indoor units which are operated before the power was turned off (POWER OFF) will restart (after 5 minutes).	ON	OFF
All OFF	Operation stays stopped regardless of the state that was before the power was turned off.	OFF	OFF

Note 1. The dip switch setting for all units in the indoor unit group is required.

Note 2. Do not cut-off the power to the outdoor unit. If you do, it will disconnect the power to the crankcase heater of the outdoor unit and that could cause damage to the compressor.

Note 3. This cannot be applied to the power ON/OFF of the drain pump and humidifier equipment.

■ Description of when using distant/local switching (CN32)

SW1 Local switching	SW2 ON/OFF	State	Remote controller display/operation
OFF	OFF	Local / Permit	The operation permit
ON	OFF	Distant / Stop	It displays "CENTRALLY CONTROLLED", while the state is distant.
ON	ON	Distant / Operate	It prohibits ON/OFF operation of remote controller.

■ System example

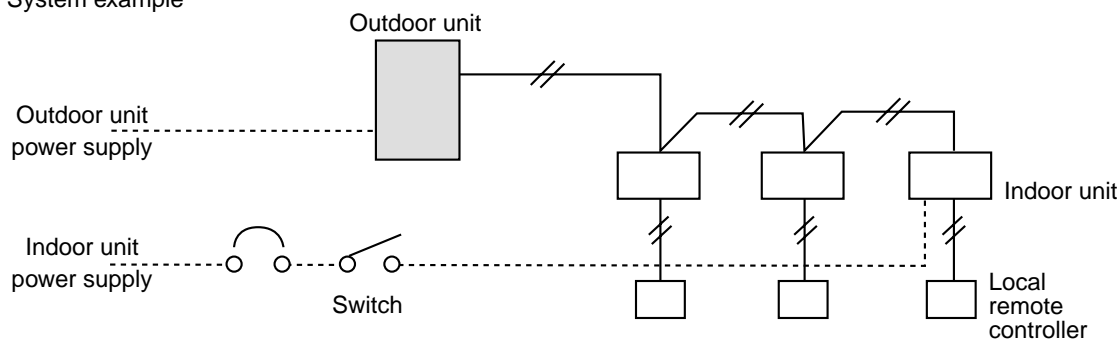

When the power to the outdoor unit is cut-off for a long time, the crankcase heater for the compressor also stops. If the compressor is started soon after the power is restored, there is a chance that a fault will occur in the compressor. When using the above function, make sure the power to the outdoor units will not be cut-off.

■ Limitations to combining system controls

	Description		Control combining distant/local	Pulse ON/OFF	Power ON/OFF	Automatic recover
1	Control combining distant/local	CN32	—	× *1	× *1	× *1
2	Pulse ON/OFF	CN51		—	○	○
3	HA ON/OFF (JEMA)	CN51			○	○
4	Power ON/OFF	-			—	×
5	Automatic recover	-				—

*1: Pulse ON/OFF, Power ON/OFF and automatic recover can only be used when the distant/local setting (CN32) is set to local. Therefore, always avoid this function when combining control.

Outdoor unit input/output connector

(1) All units

• State (CN51)

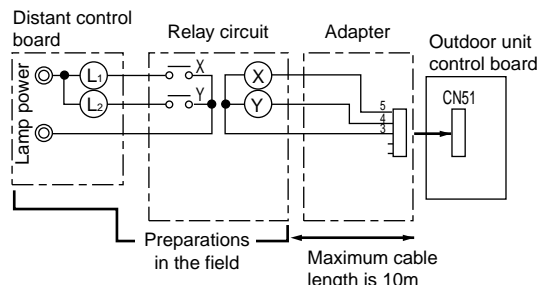

L1 : Error display lamp
 L2 : Compressor operation lamp
 X, Y : Relay (Coil standard of 0.9W or less for DC12V)

(2) PUMY-P

• Demand (CN3S)

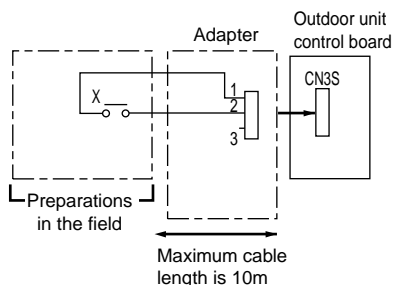

X : Relay
 Demand : The compressor is stopped when X is closed.

• Autochangeover (CN3D)

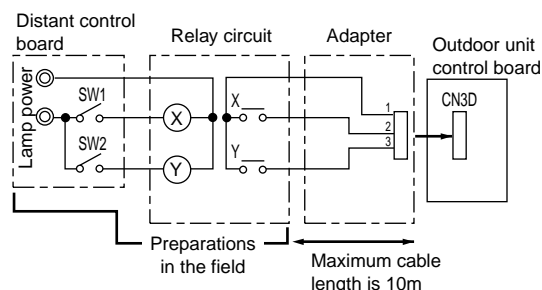

SW1 : Cooling / Heating
 SW2 : Validity / Invalidity of SW1
 X, Y : Relay (Point of contact rating : DC1mA)

(3) PUMY

• Demand (CN3D)

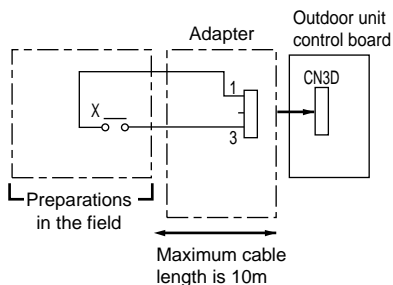

Demand : The compressor is stopped when X is closed.

(4) PURY, PU(H)Y-(P)200-250-315

• Step demand (CN3D + DipSW4-7 ON)

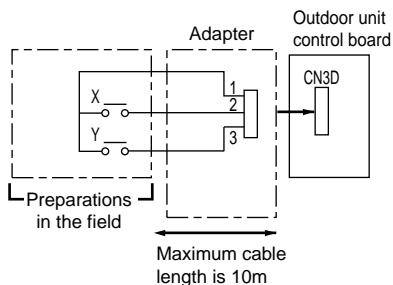

		X	
		OFF	ON
Y	OFF	100%	75%
	ON	0%	50%

※They are rough values.

• Night mode (CN3D + DipSW4-7 OFF)

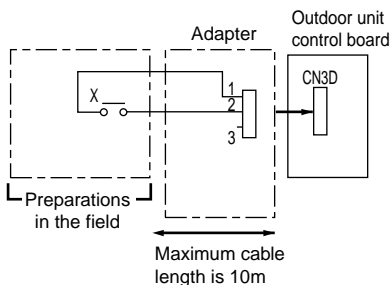

X : Relay
 Night mode : The noise level is reduced by controlling the maximum fan frequency to be lower under the flowing condition.
 Cooling mode : ambient temp. (TH6) < 30°C
 Heating mode : ambient temp. (TH6) > 3°C

-Note-
 The noise level can not be reduced. When the fan frequency is not maximum.

• Snow sensor (CN3S)

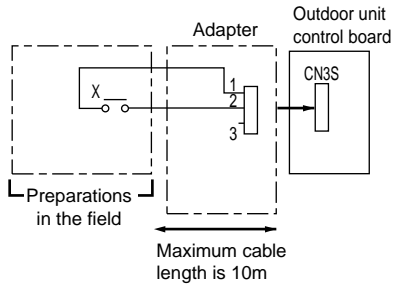

X : Relay
 Snow sensor : The outdoor fan runs when X is closed in stop mode or thermostat mode.

• Autochangeover (CN3N) ※ Y series only

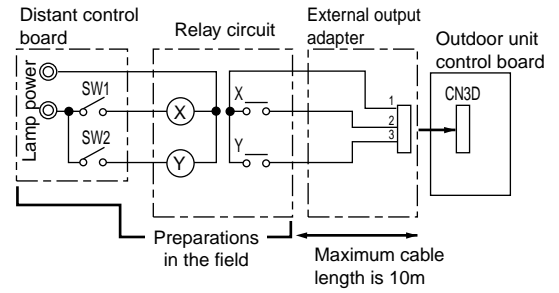

SW1 : Cooling / Heating
 SW2 : Validity / Invalidity of SW1
 X, Y : Relay (Point of contact rating : DC1mA)

(5) Big Y, Super Y, Big R2

• Demand (CN3S)

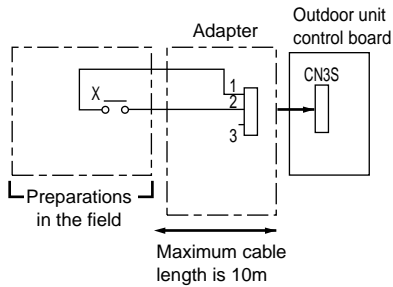

X : Relay
 Demand : The compressor is stopped when X is closed.

• Snow and Night mode (CN3N)

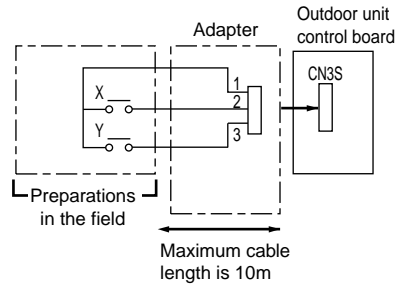

X : Night mode
 Y : Snow mode

• Autochangeover (CN3D) ※ Big Y and Super Y only

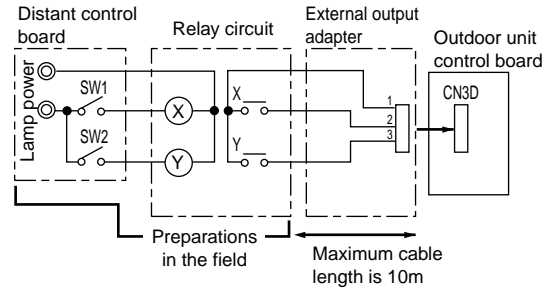

SW1 : Cooling / Heating
 SW2 : Validity / Invalidity of SW1
 X, Y : Relay (Point of contact rating : DC1mA)

(6) WR2, WY

• Demand (CN3D)

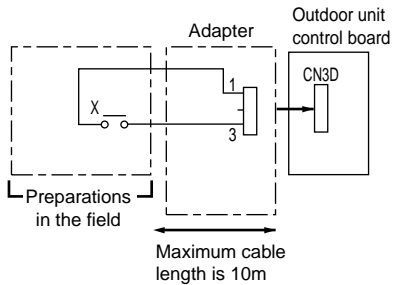

Demand : The compressor is stopped when X is closed.

Indoor unit input/output connector

ON/OFF (Pulse) input specification

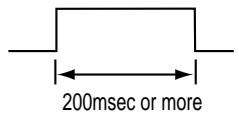
Item	Description
Input signal	Pulse sign (a connect)
Standard of pulse	 200msec or more

Input

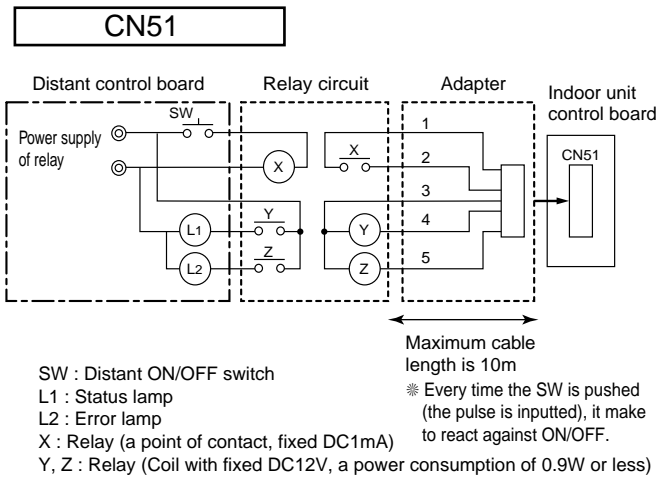

Output

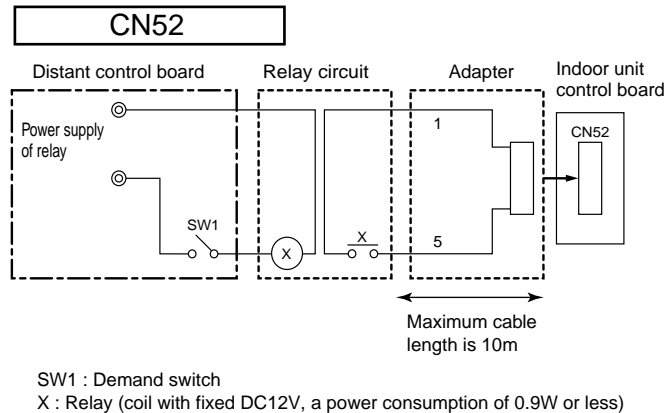
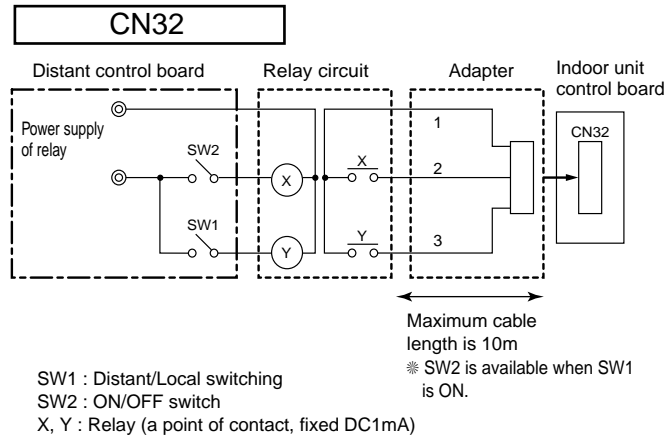
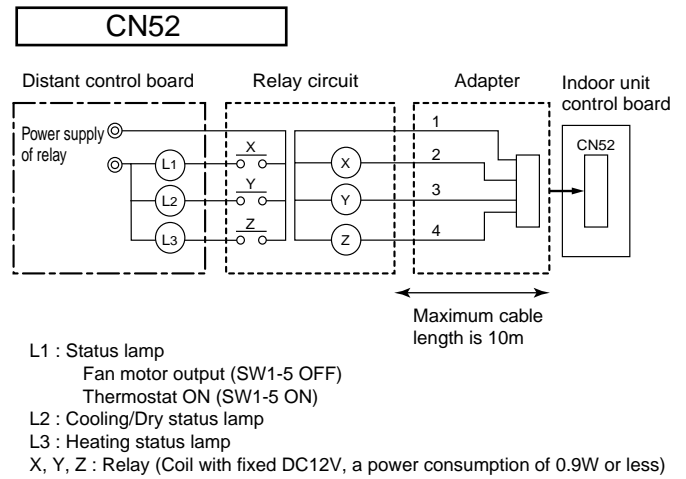

CITY MULTI SYSTEM DESIGN

CONTENTS

1. Electrical Work & M-NET control	
1-1 Attention	IV-2
1-2 Allowable length of transmission line	IV-3
1-3 Electrical work	IV-6
1-4 System configuration restrictions	IV-9
1-5 Address setting	IV-12
2. Refrigerant & Piping	
2-1 System examples	IV-21
2-2 Restrictions on refrigerant piping lengths	IV-23
2-3 Refrigerant piping selection	IV-29
2-4 Example of refrigerant piping selection	IV-33
2-5 Calculation of additional refrigerant charge	IV-38
2-6 Electric characteristics	IV-44
2-7 Installation	IV-50
2-8 Joint / Header / Reduction	IV-64
3. Caution For Refrigerant Leak	
3-1 Introduction	IV-66
3-2 Checking procedure of limiting concentration	IV-66

1. Electrical Work & M-NET control

1-1 Attention

- ① Follow ordinance of your governmental organization for technical standard related to electrical equipment, wiring regulations, and guidance of each electric power company.
- ② Wiring for control (hereinafter referred to as transmission line) shall be (5cm or more) apart from power source wiring so that it is not influenced by electric noise from power source wiring. (Do not insert transmission line and power source wire in the same conduit.)
- ③ Be sure to provide designated grounding work to outdoor unit.
- ④ Give some allowance to wiring for electrical part box of indoor and outdoor units, because the box is sometimes removed at the time of service work.
- ⑤ Never connect 380~415V(220~240V)power source to terminal block of transmission line.If connected,electrical parts will be burnt out
- ⑥ Use 2-core shield cable for transmission line. If transmission lines of different systems are wired with the same multiple-core cable, the resultant poor transmitting and receiving will cause erroneous operations.

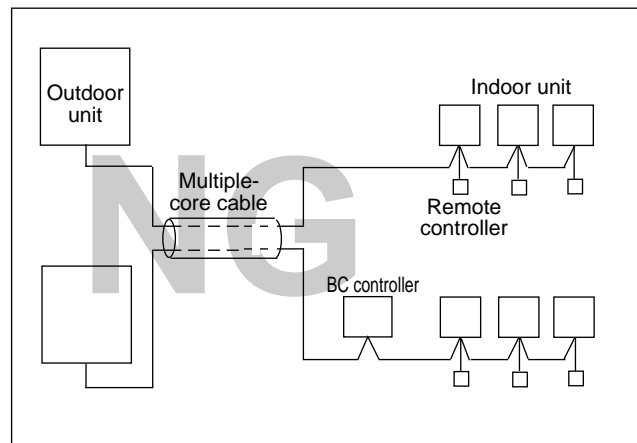
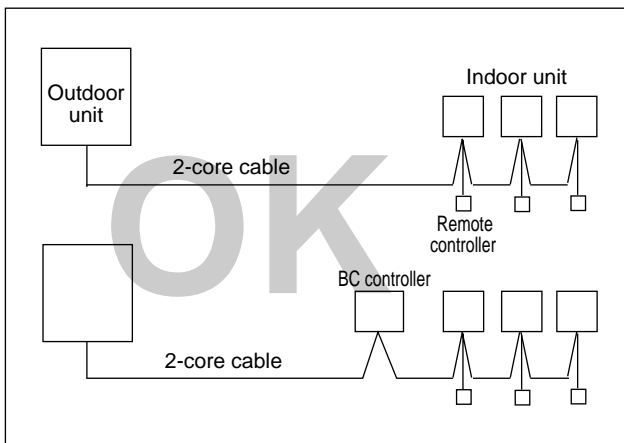

1-2 Allowable length of transmission line

- ① PUHY, PUY, PUMY
MA Remote controller

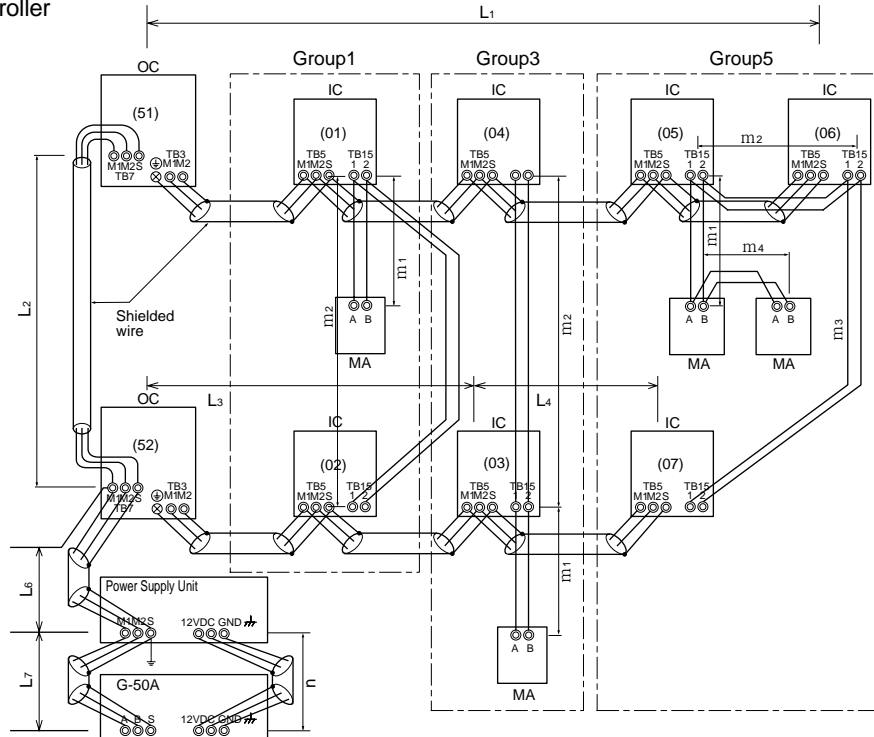

- Max length via outdoor unit (M-NET cable) : $L_1+L_2+L_3+L_4$ and $L_1+L_2+L_6+L_7$ and L_6 and $L_3+L_4+L_6+L_7 \leq 500$ m (1.25 mm² or more)
- Max transmission cable length (M-NET cable) : L_1 and L_3+L_4 and L_6 and L_2+L_6 and $L_7 \leq 200$ m (1.25 mm² or more)
- Remote controller cable length : m_1+m_2 and $m_1+m_2+m_3+m_4 \leq 200$ m (0.3 to 1.25 mm²)
- DC12V power supply line : $n \leq 10$ m (0.75 to 2mm²)

M-NET Remote controller

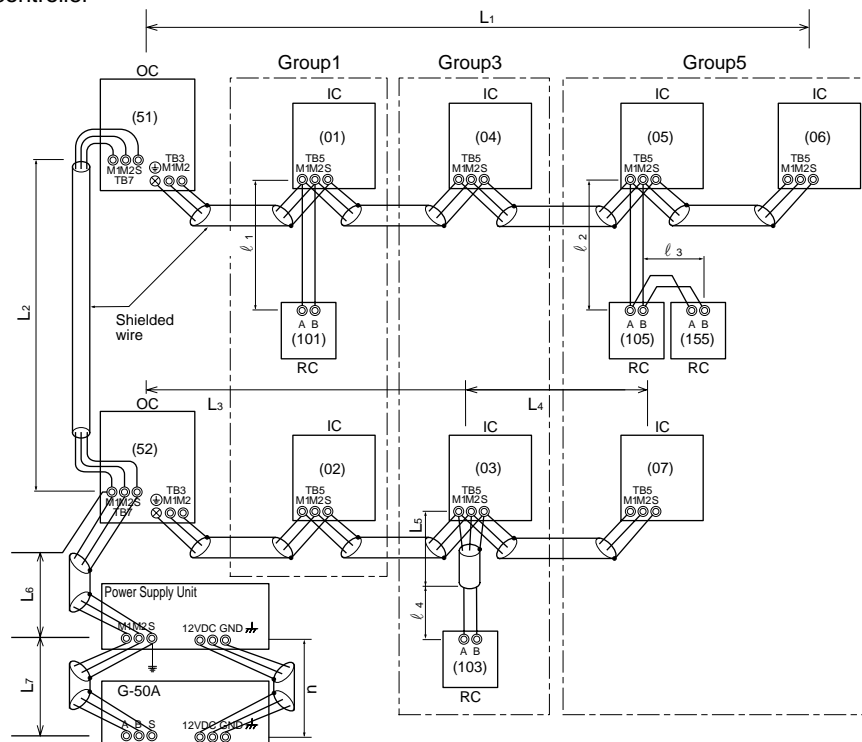

- Max length via outdoor units : $L_1+L_2+L_3+L_4$ and $L_1+L_2+L_3+L_5$ and $L_1+L_2+L_6+L_7 \leq 500$ m (1.25 mm² or more)
- Max transmission cable length : L_1 and L_3+L_4 and L_3+L_5 and L_6 and L_2+L_6 and $L_7 \leq 200$ m (1.25 mm² or more)
- Remote controller cable length : $l_1, l_2, l_3, l_4 \leq 10$ m (0.3 to 1.25 mm²)
If the length exceeds 10 m, use a 1.25 mm² shielded wire. The length of this section (L_5) should be included in the calculation of the maximum length and overall length.
- DC12V power supply line : $n \leq 10$ m (0.75 to 2mm²)

② PURY, PQRY <In case of 1 BC controller system>
MA Remote controller

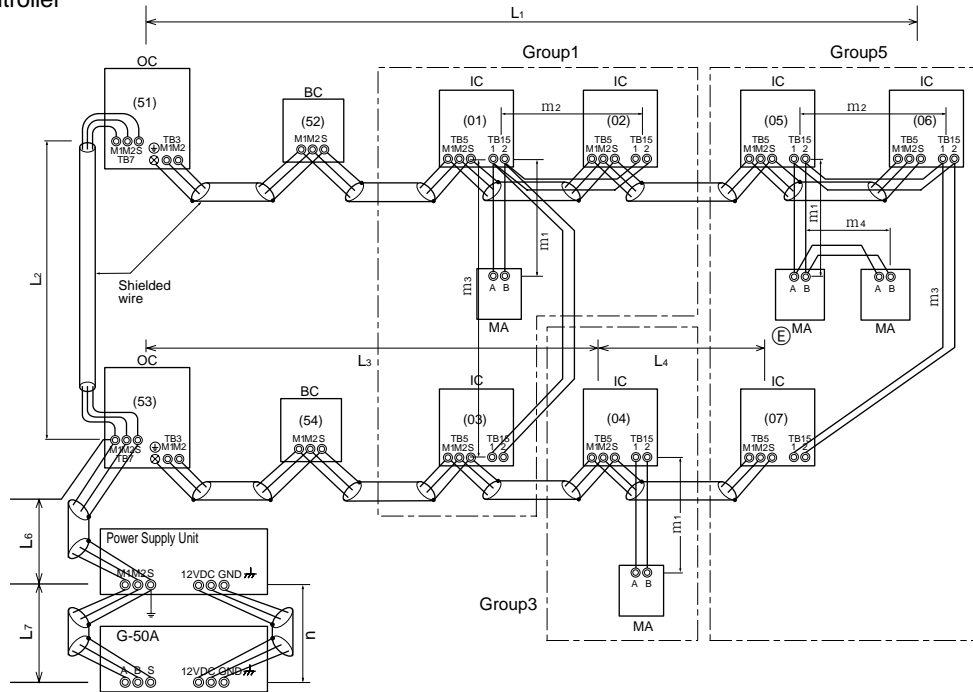

- Max length via outdoor unit (M-NET cable) : $L_1+L_2+L_3+L_4$ and $L_1+L_2+L_6+L_7$ and $L_3+L_4+L_6+L_7 \leq 500$ m (1.25 mm² or more)
- Max transmission cable length (M-NET cable) : L_1 and L_3+L_4 and L_6 and L_2+L_6 and $L_7 \leq 200$ m (1.25 mm² or more)
- Remote controller cable length : m_1 and $m_1+m_2+m_3$ and $m_1+m_2+m_3+m_4 \leq 200$ m (0.3 to 1.25 mm²)
- DC12V power supply line : $n \leq 10$ m (0.75 to 2mm²)

M-NET Remote controller

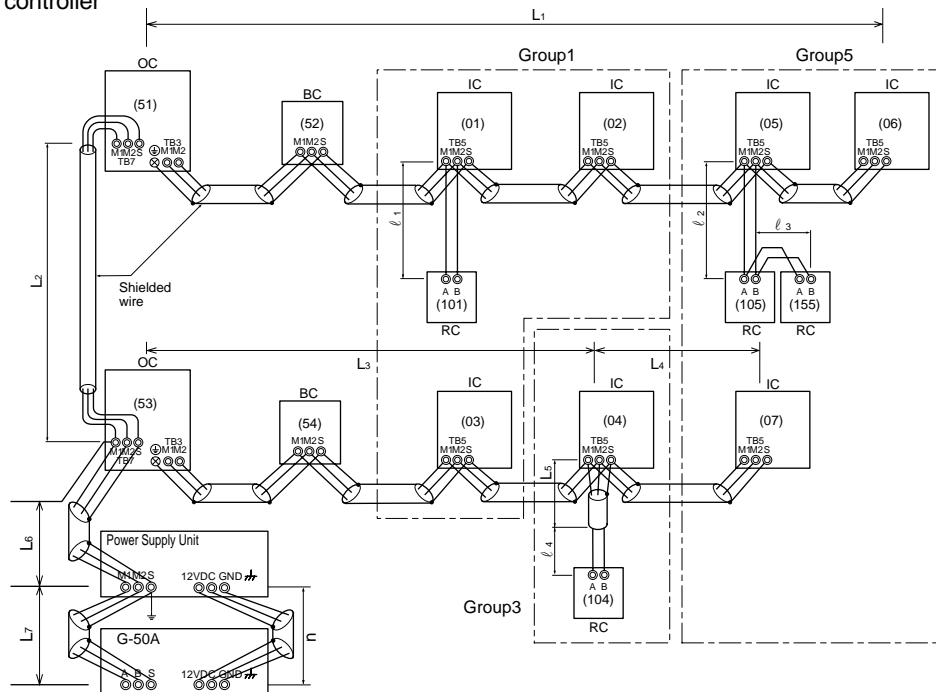

- Max length via outdoor units : $L_1+L_2+L_3+L_4$ and $L_1+L_2+L_3+L_5$ and $L_1+L_2+L_6+L_7 \leq 500$ m (1.25 mm² or more)
- Max transmission cable length : L_1 and L_3+L_4 and L_3+L_5 and L_6 and L_2+L_6 and $L_7 \leq 200$ m (1.25 mm² or more)
- Remote controller cable length : $l_1, l_2, l_3, l_4 \leq 10$ m (0.3 to 1.25 mm²)
If the length exceeds 10 m, use a 1.25 mm² shielded wire. The length of this section (L_5) should be included in the calculation of the maximum length and overall length.
- DC12V power supply line : $n \leq 10$ m (0.75 to 2mm²)

③ PURY-P400-500 <In case of 2 BC controllers system>

MA Remote controller

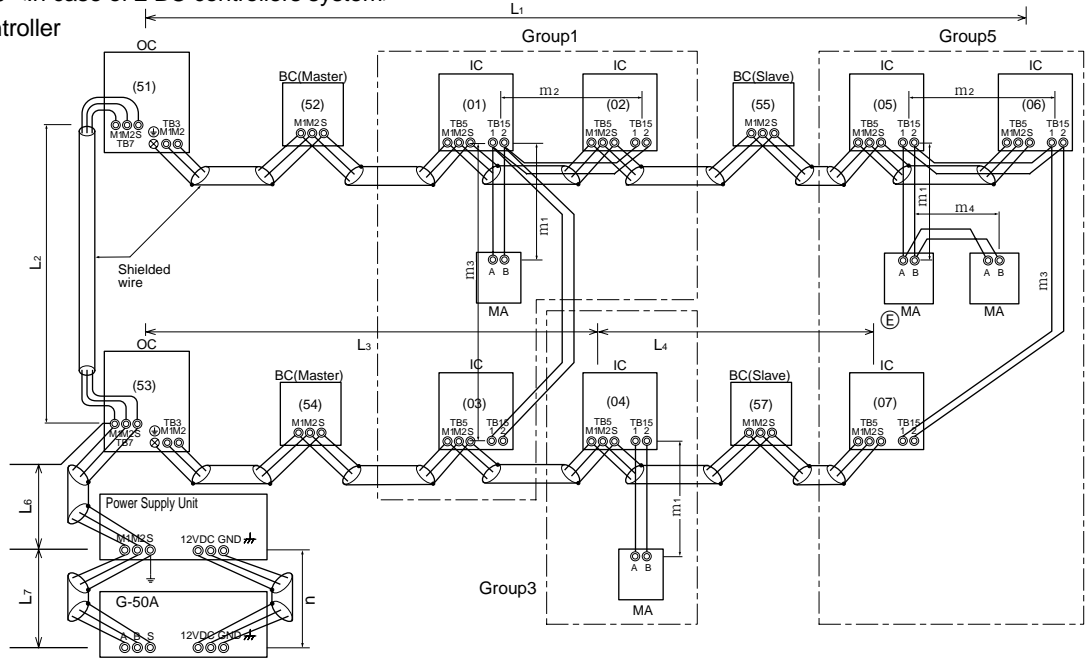

- Max length via outdoor unit (M-NET cable) : $L_1+L_2+L_3+L_4$ and $L_1+L_2+L_6+L_7$ and $L_3+L_4+L_6+L_7 \leq 500$ m (1.25 mm² or more)
- Max transmission cable length (M-NET cable) : L_1 and L_3+L_4 and L_6 and L_2+L_6 and $L_7 \leq 200$ m (1.25 mm² or more)
- Remote controller cable length : m_1 and $m_1+m_2+m_3$ and $m_1+m_2+m_3+m_4 \leq 200$ m (0.3 to 1.25 mm²)
- DC12V power supply line : $n \leq 10$ m (0.75 to 2mm²)

M-NET Remote controller

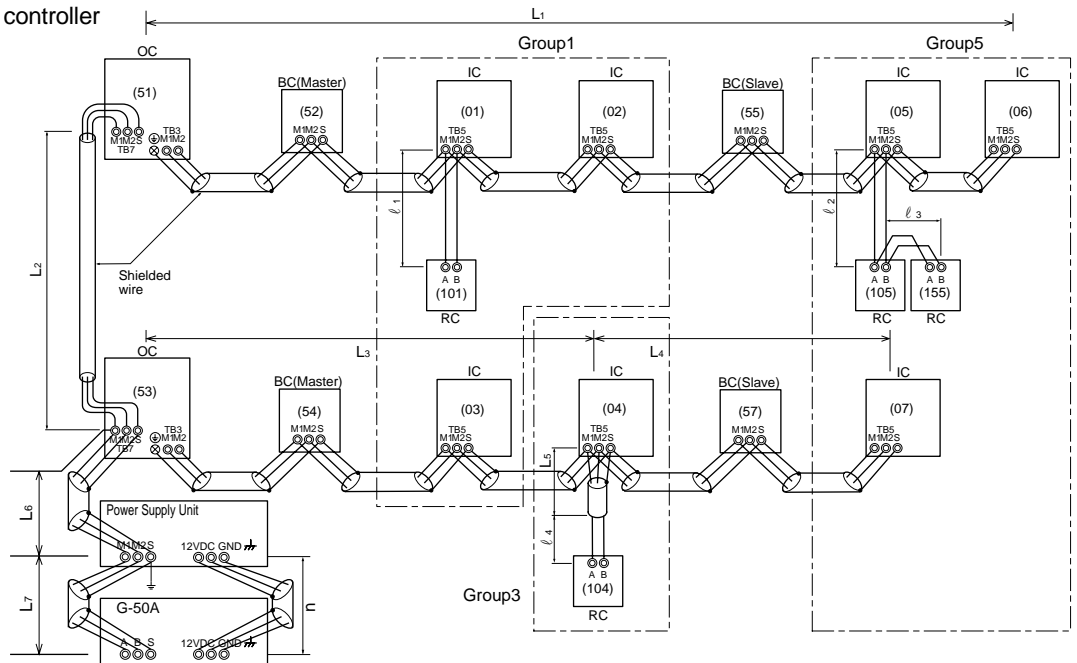

- Max length via outdoor units : $L_1+L_2+L_3+L_4$ and $L_1+L_2+L_3+L_5$ and $L_1+L_2+L_6+L_7 \leq 500$ m (1.25 mm² or more)
- Max transmission cable length : L_1 and L_3+L_4 and L_3+L_5 and L_6 and L_2+L_6 and $L_7 \leq 200$ m (1.25 mm² or more)
- Remote controller cable length : $l_1, l_2, l_3, l_4 \leq 10$ m (0.3 to 1.25 mm²)
If the length exceeds 10 m, use a 1.25 mm² shielded wire. The length of this section (L_5) should be included in the calculation of the maximum length and overall length.
- DC12V power supply line : $n \leq 10$ m (0.75 to 2mm²)

City Multi is a systemized product of which components are outdoor unit, BC controller, indoor unit, and remote controller. Each system part has its own microcomputer, and operated by no-polarity two wires multiple transmission system. Therefore, in order for several microcomputers connected to the common two wires to identify transmitter, identification No. (address) must be set for each microcomputer.

Be sure to set address numbers at the time of installation work by using switches for setting addresses for outdoor unit, BC controller, indoor unit, and remote controller.

When signal receiving unit is used, connect the accessory cable (polarity 2 lines) to the specified connector (CN3A) on the printed circuit board.

1-3 Electrical work

(1) Main power supply connections and equipment capacities

The selection of capacities should be determined in accordance with the relevant standards.

- ① PUMY,
PU(H)Y-(P)200-250-315
PURY-(P)200-250, PQRY, PQHY

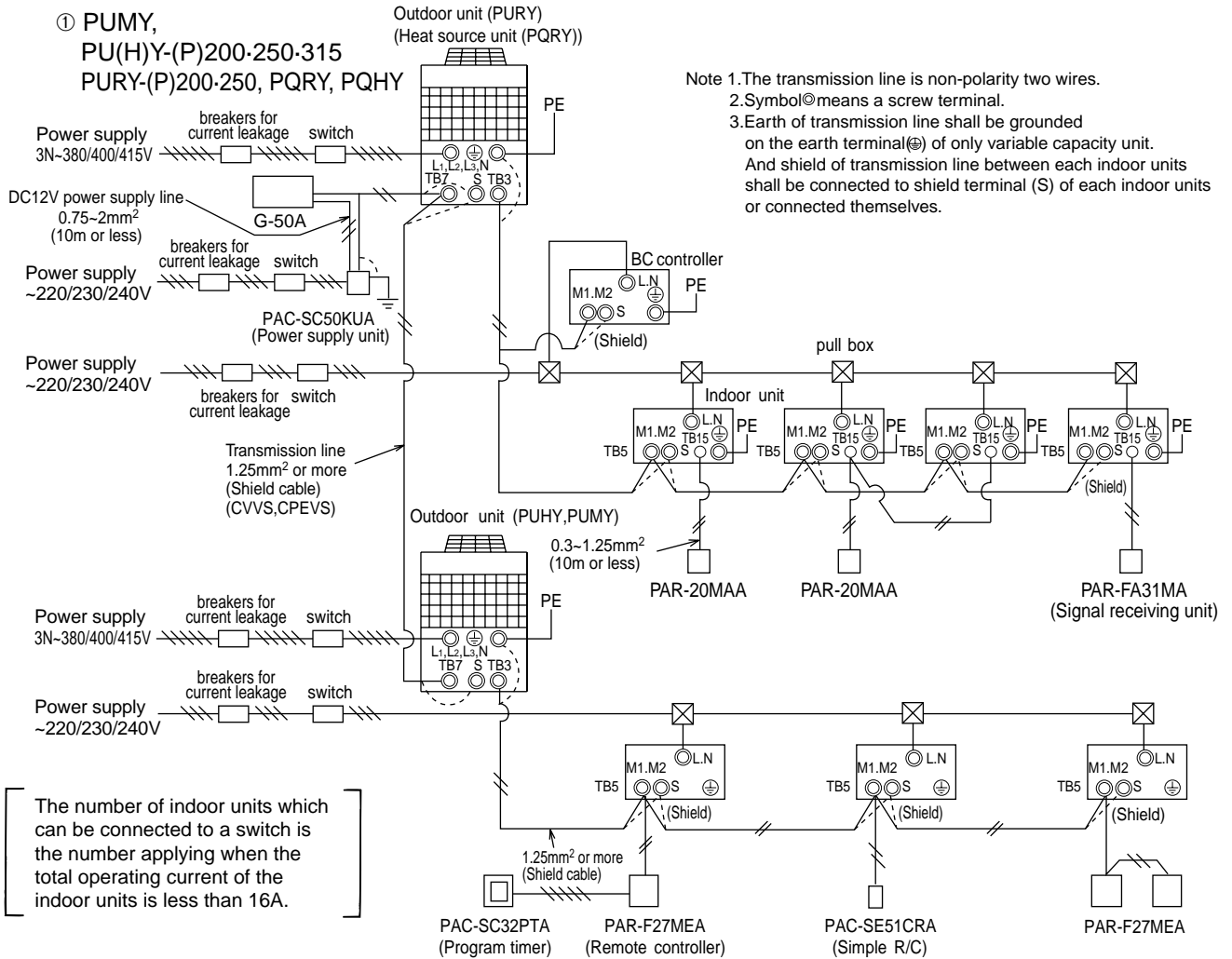

- ② PUHY-(P)400-500

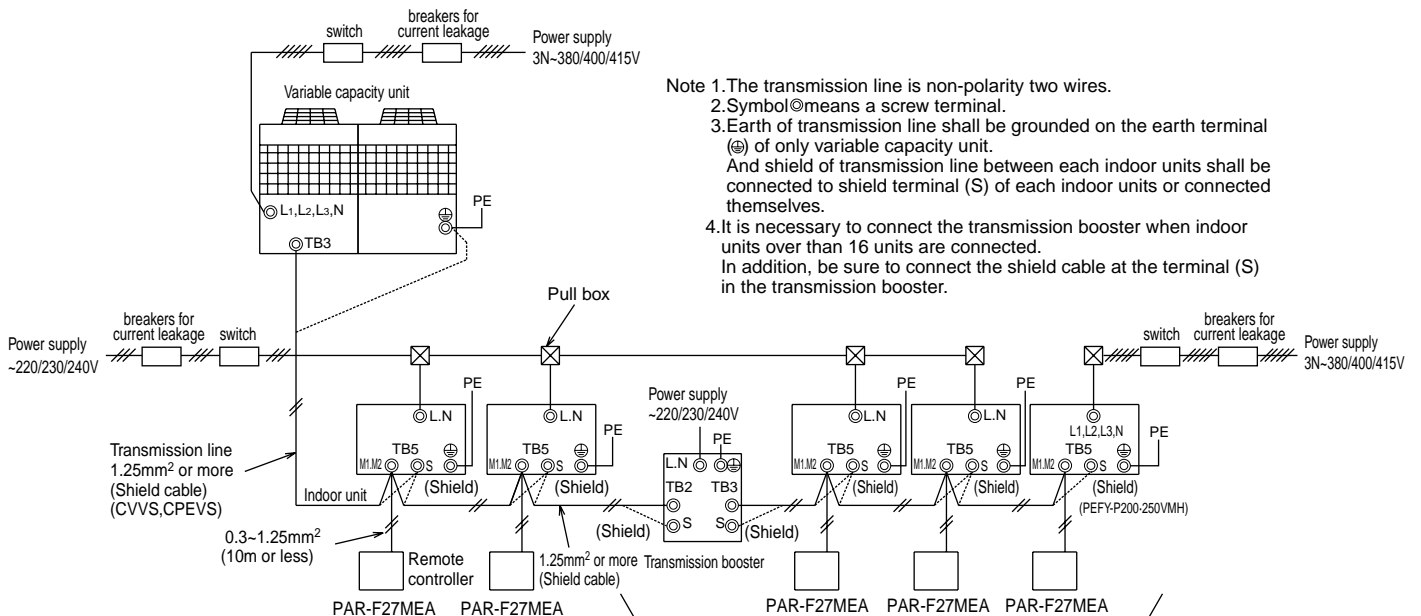

Note 4

③ PUHY-(P)600-650-700-750

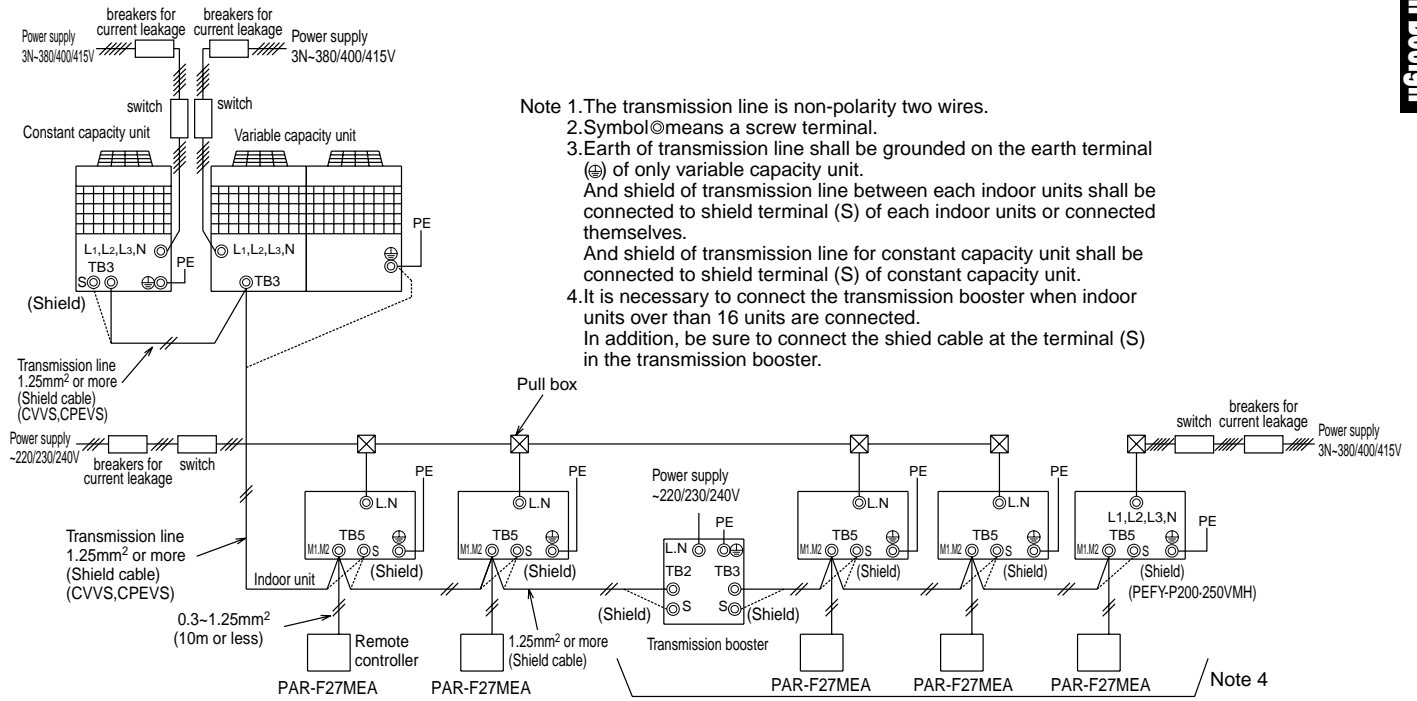

- Note 1. The transmission line is non-polarity two wires.
 2. Symbol Ⓞ means a screw terminal.
 3. Earth of transmission line shall be grounded on the earth terminal (Ⓞ) of only variable capacity unit.
 And shield of transmission line between each indoor units shall be connected to shield terminal (S) of each indoor units or connected themselves.
 And shield of transmission line for constant capacity unit shall be connected to shield terminal (S) of constant capacity unit.
 4. It is necessary to connect the transmission booster when indoor units over than 16 units are connected.
 In addition, be sure to connect the shield cable at the terminal (S) in the transmission booster.

④ PURY-P400-500

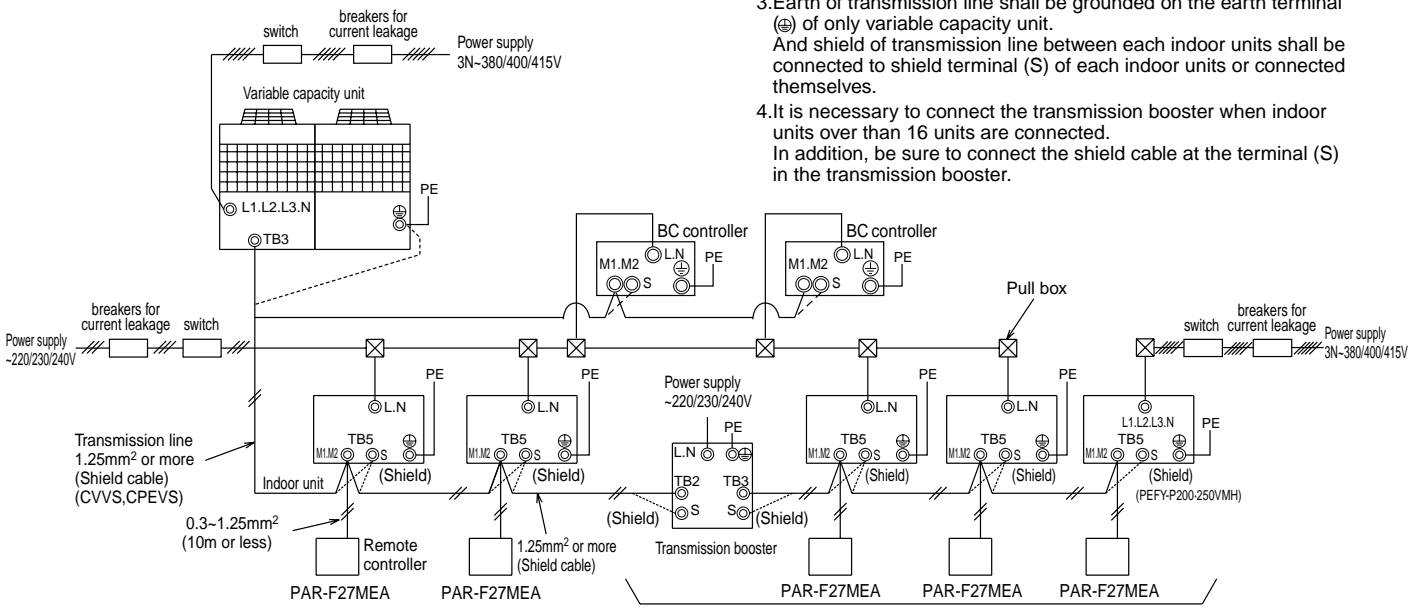

- Note 1. The transmission line is non-polarity two wires.
 2. Symbol Ⓞ means a screw terminal.
 3. Earth of transmission line shall be grounded on the earth terminal (Ⓞ) of only variable capacity unit.
 And shield of transmission line between each indoor units shall be connected to shield terminal (S) of each indoor units or connected themselves.
 4. It is necessary to connect the transmission booster when indoor units over than 16 units are connected.
 In addition, be sure to connect the shield cable at the terminal (S) in the transmission booster.

Specific wiring requirements should adhere to the wiring regulations of the region.

Model	Minimum Wire Thickness (mm ²)			Switch(A)		Breaker for Wiring (NFB)	Breaker for Current Leakage		
	Main Cable	Branch	Ground	Capacity	Fuse				
Outdoor unit	200	4.0	-	4.0	25	25	30A	30A 100mA 0.1sec. or less	
	250	4.0	-	4.0	32	32	30A	30A 100mA 0.1sec. or less	
	315	6.0	-	6.0	40	40	40A	40A 100mA 0.1sec. or less	
	400	10.0	-	10.0	63	63	75A	75A 100mA 0.1sec. or less	
	500	16.0	-	16.0					
	600	400	10.0	-	10.0	63	63	75A	75A 100mA 0.1sec. or less
		200	4.0	-	4.0	32	32	40A	30A 100mA 0.1sec. or less
	650	400	10.0	-	10.0	63	63	75A	75A 100mA 0.1sec. or less
		250	6.0	-	6.0	40	40	40A	40A 100mA 0.1sec. or less
	700	500	16.0	-	16.0	63	63	75A	75A 100mA 0.1sec. or less
		200	4.0	-	4.0	32	32	40A	30A 100mA 0.1sec. or less
	750	500	16.0	-	16.0	63	63	75A	75A 100mA 0.1sec. or less
		250	6.0	-	6.0	40	40	40A	40A 100mA 0.1sec. or less
	Heat source unit	200	4.0	-	4.0	32	32	40A	30A 100mA 0.1sec. or less
250		6.0	-	6.0	40	40	40A	40A 100mA 0.1sec. or less	

Model	Wire Thickness (mm ²)			Switch(A)		Breaker for Wiring	Breaker for Current Leakage	
	Main Cable	Branch	Ground	Capacity	Fuse			
Total operating current of the indoor units *1	16A or less	1.5	1.5	1.5	16	16	20A	20A 30mA 0.1sec. or less
	25A or less	2.5	2.5	2.5	25	25	30A	30A 30mA 0.1sec. or less
	32A or less	4.0	4.0	4.0	32	32	40A	40A 30mA 0.1sec. or less

- *1 Use a separate power supply for the outdoor unit and indoor unit.
- *2 Bear in mind ambient conditions (ambient temperature, direct sunlight, rain water, etc.) when proceeding with the wiring and connections.
- *3 The wire size is the minimum value for metal conduit wiring. The power cord size should be 1 rank thicker with consideration of voltage drops.
Make sure the power supply voltage does not drop more than 10%.
- *4 Specific wiring requirements should adhere to the wiring regulations of the region.
- *5 Power supply cords of parts of appliances for outdoor use shall not be lighter than polychloroprene sheathed flexible cord (design 245 IEC57).
- *6 A switch with at least 3 mm contact separation in each pole shall be provided by the Air conditioner installation.

(2) Types of control cables

	Transmission cables	M-NET Remote controller cables	MA Remote controller cables
Type of cable	Shielding wire (2-core) CVVS or CPEVS	Sheathed 2-core cable (unshielded) CVV	
Cable diameter	More than 1.25mm ²	0.3 ~ 1.25mm ² (0.75 ~ 1.25mm ²) *1	
Remarks	—	When 10m is exceeded, use cables with the same specification as transmission cables.	Max length : 200m

- *1 Connected with simple remote controller.
- CVVS : PVC insulated PVC jacketed shielded control cable
- CPEVS : PE insulated PVC jacketed shielded communication cable
- CVV : PV insulated PVC sheathed control cable

1-4 System configuration restrictions (Common matters for each unit regarding system limits)

* Refer to section [1.1 Device configuration table] for details on limits for connecting each unit.

Item	Set-up		For indoor/outdoor automatic address startup (Note 4)	For indoor/outdoor manual address startup	Set-up With Connection to System Controller (Note 5)			
					Connection to Central Control Transmission Line (Note 13)	Connection to Indoor/outdoor Transmission Line (TB3) (Note 10)		
						SC1	SC2	SC3
Number of connected remote controller.			one or two units per group					
Number of indoor units connected per group.			1 to 16 units					
Number of ventilation units connected to indoor unit.			1 unit per indoor unit					
Number of indoor units connected to ventilation unit.			All indoor units in same refrigerant system (Note 6)	Random between 1 and 16 units per ventilation unit (Note 7)				
Number of ventilation units connected in refrigeration system.			1 unit	-	-	-		
Number of system controllers connected when indoor/outdoor transmission line connected.			-	-	-	Max. 3 units in same refrigerant system		
Total number of units connected in refrigerant system <MA Remote Controller> (Note 2).	With no distribution controller	All indoor units under Type 200.	Max. 32units (excluding LOSSNAY)			Max. 30 units	Max. 28 units	Max. 26units
		Type 200 or higher	Max. 26units (Note 8)			Above numbers exclusive of LOSSNAY (Note 11, 12)		
	With distribution controller, one BC unit /two BC units	All indoor units under Type 200.	Max. 31/30units (excluding LOSSNAY)			Max. 29/28units	Max. 27/26units	Max. 25/24units
		Type 200 or higher	Max. 25/24units (Note 8)			(Note 11,12)		
						Max. 23/22units	Max. 21/20units	Max. 19/18units
						(Note 11,12)		
Total number of units connected in same refrigerant system <M-NET Remote Controller> (Note 2, 3).	With no distribution controller	All indoor units under Type 200.	Max. 20units (40units) (Note 8,9)			Max. 18units (38units)	Max. 16units (36units)	Max. 14units (34units)
		Type 200 or higher	Max. 16units (32units) (Note 8,9)			(Note 9,11,12)		
	With distribution controller, one BC unit /two BC units	All indoor units under Type 200.	Max. 19/18units (Max. 38/36 units) (Note 8,9)			Max. 17/16units (36/34units)	Max. 15/14units (34/32units)	Max. 13/12units (32/30units)
		Type 200 or higher	Max. 15/14units (Max. 30/28 units) (Note 8,9)			(Note 9,11,12)		
						Max. 13/12units (28/26units)	Max. 11/10units (26/24 units)	Max. 9/8units (24/22units)
						(Note 9,11,12)		

- Note 1 "Indoor/outdoor unit automatic address startup" cannot be used when sequencing the ventilation unit with 16 or more indoor units in the same refrigerant system, or when connecting two or more ventilation units to the refrigeration system.
* Select 'Automatic Address Set-up' or 'Set-up With Connection to System Controller'.
- Note 2 The total number of connected units is the total of indoor units and ventilation units (LOSSNAY with heating and humidifying functions).
- Note 3 The number of units limited when using the MA remote controller and M-NET remote controller is the number of units indicated for <M-NET remote controller connection>.
- Note 4 'Automatic Address Set-up' is not possible when Start/Stop input is used with group operation or when the system is with two distribution controllers.
- Note 5 When MA and M-NET remote controllers are used together the system controller is connected and 'Set-up With Connection to System Controller' is used.
- Note 6 All indoor units within the refrigerant system are automatically linked and registered when a ventilation unit is connected by 'Automatic Address Set-up'.
- Note 7 Linking and registration of indoor units and ventilation unit must be performed manually except when using 'Automatic Address Set-up'.
- Note 8 The power feed expansion unit for transmission line is required when the maximum number of units is exceeded.
- Note 9 Figures in brackets are the total number of indoor units and M-NET remote controllers.
- Note 10 The system controllers that can be connected to the indoor/outdoor transmission line are the G-50A, PAC-SF44SRA, PAC-YT34STA, PAC-YT40ANRA and PAC-SC30GRA.
Note that the system controller cannot be connected to the indoor/outdoor transmission line when using the City-Multi S (PUMY) outdoor unit.
Operation from the system controller will be impossible if the outdoor unit power supply is shut off while the system controller is connected to the indoor/outdoor transmission line .
When using "power apportion billing", an option for the central controller (G-50A), do not connect the G-50A to the indoor/outdoor transmission line. The G-50A will also stop when the indoor/outdoor unit's power is shut off. If the other outdoor units operate during this time, the charges will not be calculated.
- Note 11 The number of indoor units which may be connected is reduced two for each system controller.
A maximum of three system controllers can be connected in the same refrigerant system.
Note that when using the G-50A, only one unit can be connected. The number of connectable indoor units will decrease by four units.
- Note 12 A transmission booster must not be used when the system controller is connected to the indoor/outdoor transmission line.
Connect the system controller to the 'Central Control Transmission Line' when the maximum number of units is exceeded.
- Note 13 Up to five system controllers can be connected. (Excluding when G-50A is connected.)

Connecting the power feed expansion unit for transmission line

A transmission booster is required when the total number of units within the same refrigerant system exceeds the maximum number of units.

Ensure that the number of indoor units (N1) between the outdoor unit and the transmission booster, and the number of indoor units (N2) after the transmission booster, are within the restrictions in the following table.

		Type of remote controller	
		MA remote controller (Note 1)	M-NET remote controller (Note 2)
Number of indoor units (All indoor units under Type 200.)	Without BC	32	20 (40)
	With BC (one unit /two units)	31/30	19/18 (38/36)
Number of indoor units (Type 200 or higher)	Without BC	26	16 (32)
	With BC (one unit /two units)	25/24	15/14 (30/28)

Figures in brackets are the total number of indoor units and M-NET remote controllers.

Note 1 'MA remote controller' refers to the MA remote controller and wireless remote controller.

Note 2 The M-NET remote controller refers to the ME remote controller and compact remote controller.

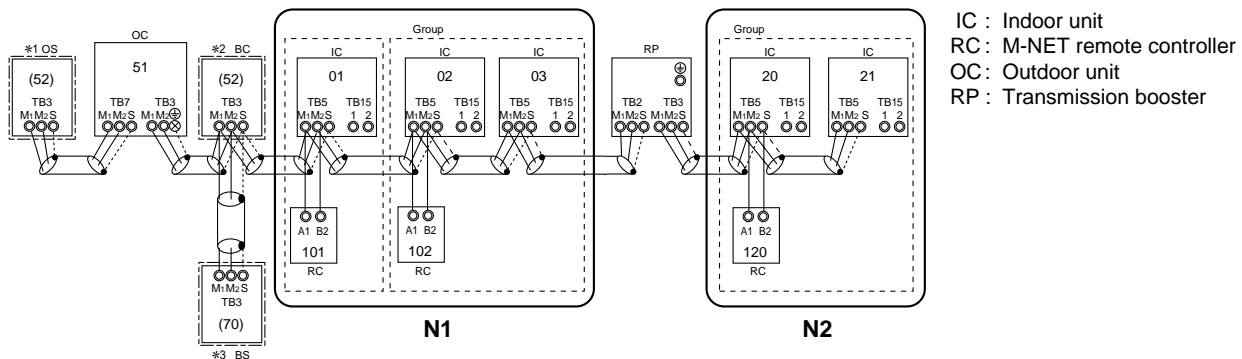

IC : Indoor unit
 RC : M-NET remote controller
 OC : Outdoor unit
 RP : Transmission booster

- *1 OS : Exists only with *** YSEM type.
- *2 BC : Exists only with R2/WR2/BIG R2 system.
- *3 BS : Connectable only when using BIG R2 system

Power supply for system controller

The system controller is fed power from the M-NET transmission line. (Excluding the G-50A, LM adaptor.)

1. Connecting to the transmission line for central control

The power feed unit for transmission line (PAC-SC50KUA/PAC-SC34KUA) is required.

The number of system controllers that can be connected differ according to the power feed unit for transmission line.

Power feed unit for transmission line	System controller		
	System remote controller, schedule timer, group remote controller(Note 1)	ON/OFF remote controller (Note 1)	Central controller (G-50A)(Note 1)
PAC-SC50KUA	1 to 10 units	1 to 5 units	1 to 2 units
PAC-SC34KUA	1 to 10 units	1 to 5 units	-

Note 1: The power consumption of the system remote controller, schedule timer (M-NET compatible) and group remote controller is one-half compared to the ON/OFF remote controller.

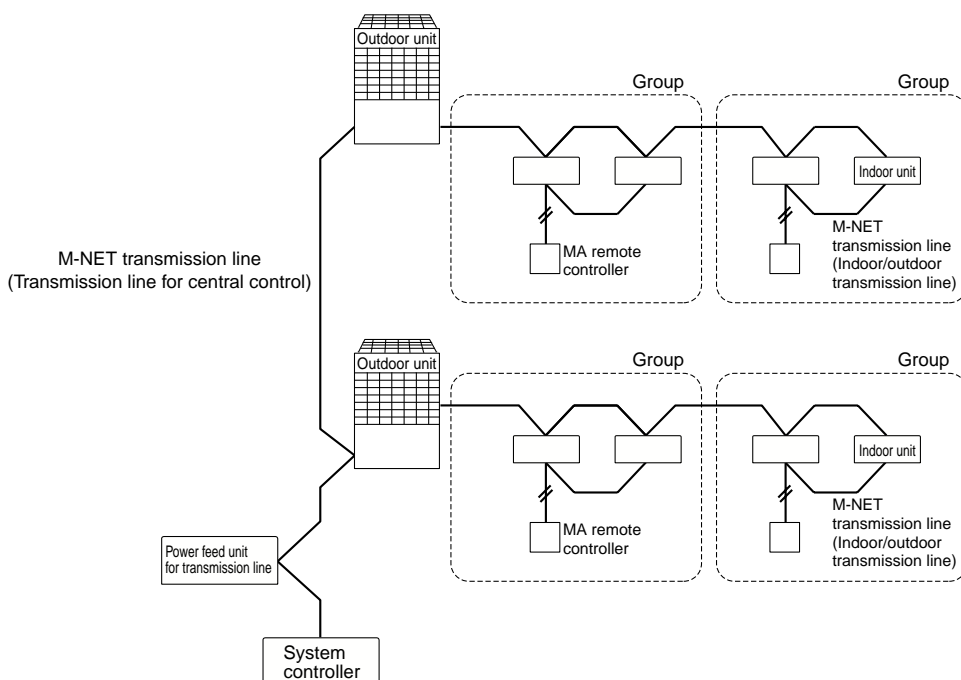

2. Connecting to the indoor/outdoor transmission line (Excluding LM adaptor)

Up to three system controllers can be connected to the M-NET transmission line's indoor/outdoor transmission line.

The power feed unit for transmission line is not required in this case.

* The number of connectable system controllers will differ according to the limits on the total number of connectable units in the refrigerant system.

Always refer to section [V. 1 (5) System configuration restrictions].

< When system controller is connected to indoor/outdoor transmission line >

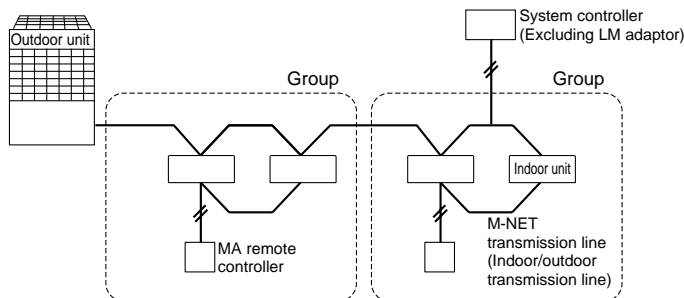

3. Using the LM adaptor

A single-phase 200VAC power supply is required.

* The power feed unit for transmission line is not required when connecting only the LM adaptor, but the LM adaptor power feed changeover connector must be changed from (CN41) to (CN40).

1-5 Address setting

(1) Switch operation

In order to constitute CITY MULTI in a complete system, switch operation for setting the unit address No. and connection No. is required.

- ① Unit address No., group No. and branch No.
 The unit address No. is determined by the address setting switch of the outdoor unit, indoor unit and remote controller.
 Set the indoor unit branch No. switch to branch No. of the BC controller connecting the piping and that indoor unit.
 When using two or more branches, set the lowest branch No.
 The indoor unit capacity that can be connected per branch is P80 or less and the maximum number of connectable units is 3.

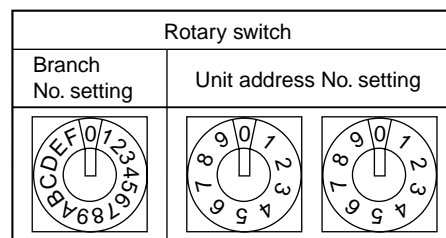

② Caution for switch operations

- Be sure to shut off power source before switch setting. If operated with power source on, switch can not operate properly.
- No units with identical unit address shall exist in one system. If set erroneously, system can not operate.

③ MA remote controller

- When connecting only one remote controller to one group, it is always the main remote controller.
 When connecting two remote controllers to one group, set one remote controller as the main remote controller and the other as the sub remote controller.
- The factory setting is "Main".

Setting the dip switches

The dip switches are at the bottom of the remote controller.
 Remote controller Main/Sub and other function settings are performed using these switches.

Ordinarily, only change the Main/Sub setting of SW1. (The factory settings are all "ON".)

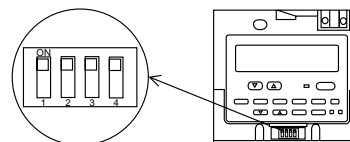

SW No	SW contents Main	ON	OFF	Comment
1	Remote controller Main/Sub setting	Main	Sub	Set one of the two remote controllers at one group to "Main".
2	When remote controller power turned on	Normally on	Timer mode on	When you want to return to the timer mode when the power is restored after a power failure when a Program timer is connected, select "Timer mode".
3	Cooling/heating display in AUTO mode	Yes	No	When you do not want to display "Cooling" and "Heating" in the Auto mode, set to "No".
4	Intake temperature display	Yes	No	When you do not want to display the intake temperature, set to "No".

(2) Rule of address setting

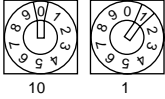
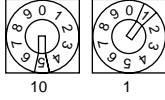
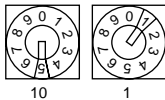
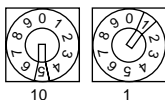
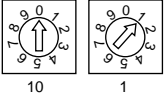
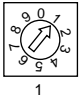
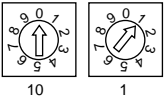
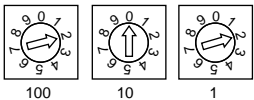
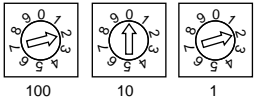
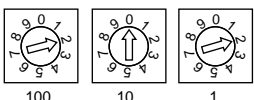
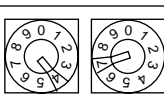
Unit	Address setting	Example	Note	
Indoor unit	01 ~ 50		Use the most recent address within the same group of indoor units. Make the indoor units address connected to the BC controller (Slave) larger than the indoor units address connected to the BC controller (Master).	
Outdoor unit Heat source unit	51 ~ 99, 100		The smallest address of indoor unit in same refrigerant system + 50 * The address automatically becomes "100" if it is set as "01~ 50"	
BC controller (Master)	52 ~ 99, 100		The address of outdoor unit + 1 * Please re-set another address between 01 and 50 when two addresses overlap. * The address automatically becomes "100" if it is set as "01~ 50"	
BC controller (Slave)	53 ~ 99, 100		Lowest address within the indoor units connected to the BC controller (Slave) plus 50.	
Local remote controller	M-NET, LOSSNAY Remote controller (Main)	101 ~ 150	1 Fixed 	The smallest address of indoor unit in the group + 100 * The place of "100" is fixed to "1"
	M-NET, LOSSNAY Remote controller (Sub)	151 ~ 199, 200	1 Fixed 	The address of main remote controller + 50 * The address automatically becomes "200" if it is set as "00"
System controller	Group remote controller	201 ~ 250	2 Fixed 	The smallest group No. to be managed + 200
	System remote controller	000, 201 ~ 250		
	ON/OFF remote controller	000, 201 ~ 250		
	G-50A	000, 201 ~ 250		
	LMAP02-E	201 ~ 250	2 Fixed 	

(3) System example

Setting of the switches when the units are shipped from the factory is as follows.

- Outdoor unit : Address : 00
On CN41
SW2-1: OFF
- Indoor unit : Address : 00
- Remote controller : Address : 100
- LMAP : Address : 247
On CN41
SW 1-2 : OFF

Example 1

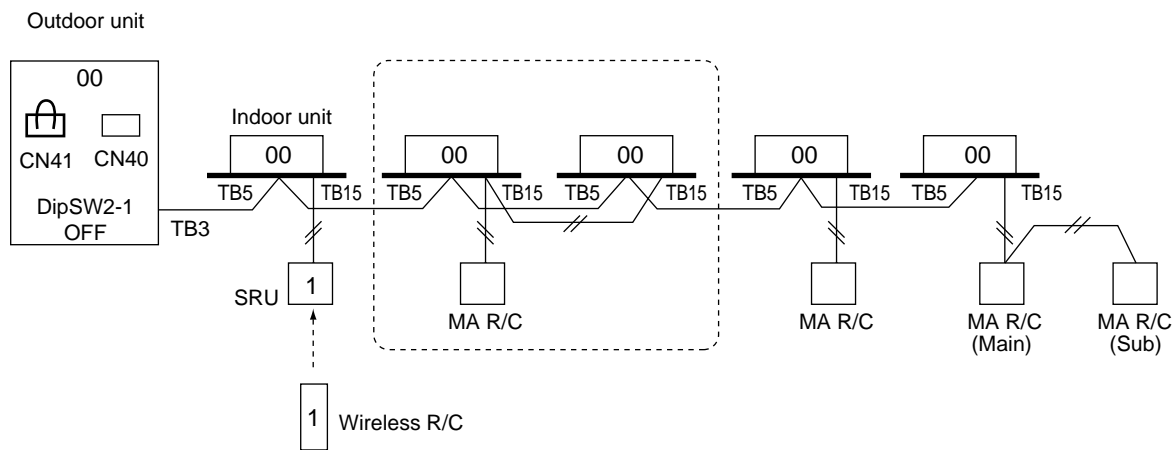

MA R/C : PAR-20MAA
 SRU(Signal receiving unit) : PAR-FA31MA
 Wireless R/C : PAR-FL31MA

NOTE

- It is not necessary to set all of address.

Example 2

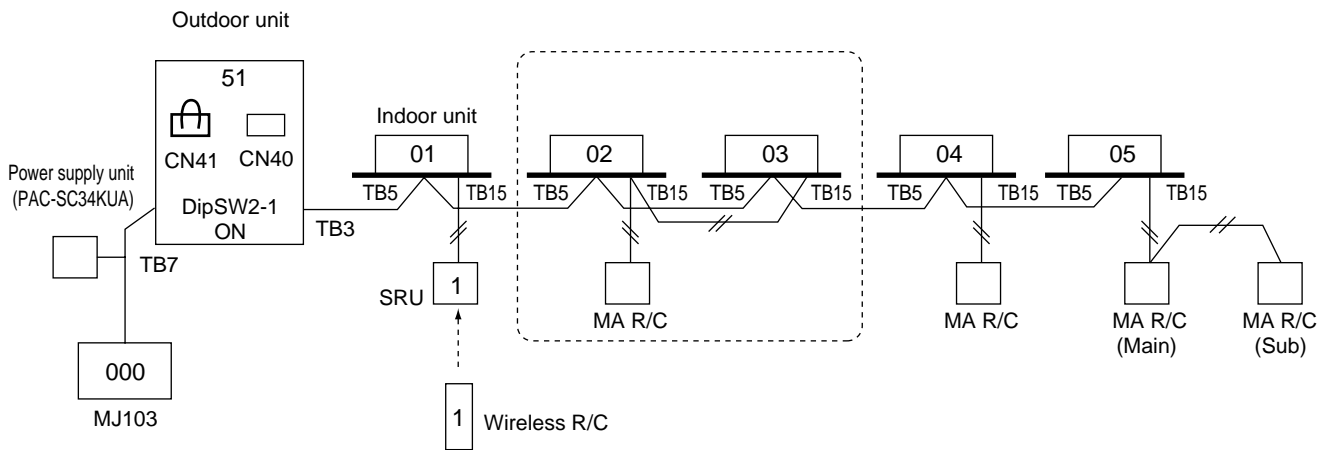

MA R/C : PAR-20MAA
 SRU(Signal receiving unit) : PAR-FA31MA
 Wireless R/C : PAR-FL31MA
 Programme timer : PAC-SC32PTA

NOTE

- It is necessary to set addresses indoor unit and outdoor unit with MJ103.

Example 3

Outdoor unit
(PUMY, PUHY, PUY)

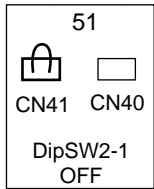

Main R/C : PAR-F27MEA
Sub R/C : PAR-F27MEA
Program timer : PAC-SC32PTA

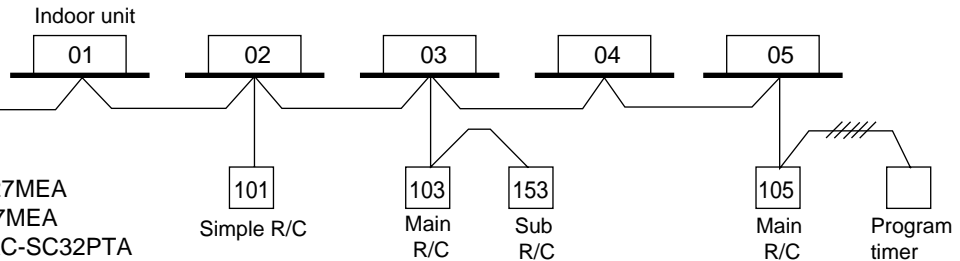

NOTE

- It is necessary to install the other polarity wires when the wireless R/C is used.

Example 4

Outdoor unit
(PURY, PQRY)

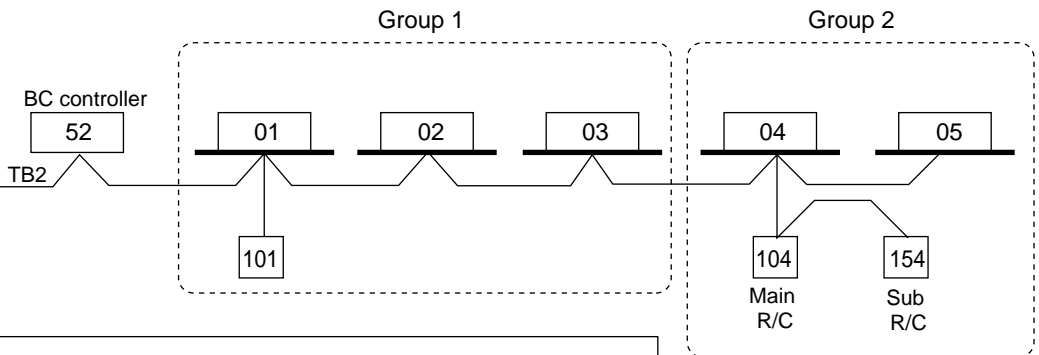
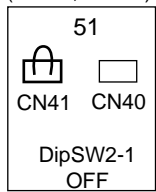

NOTE

- BC address = O/U address + 1
- R/C address = the smallest address of indoor unit + 100 in same group
- Sub R/C address = Main R/C address + 50
- Indoor units should be set with a branch number.

Example 5

Outdoor unit
(Big R2)

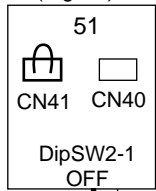

NOTE

- Indoor units should be set with a branch number.
- Be sure to set up the address number of the indoor unit connected to BC controller (slave) more higher than the address numbers of the indoor units connected to BC controller (master).
- BC (master) address = O/U address + 1
- BC (slave) address = Lowest address within the indoor units connected to the BC controller (slave) + 50

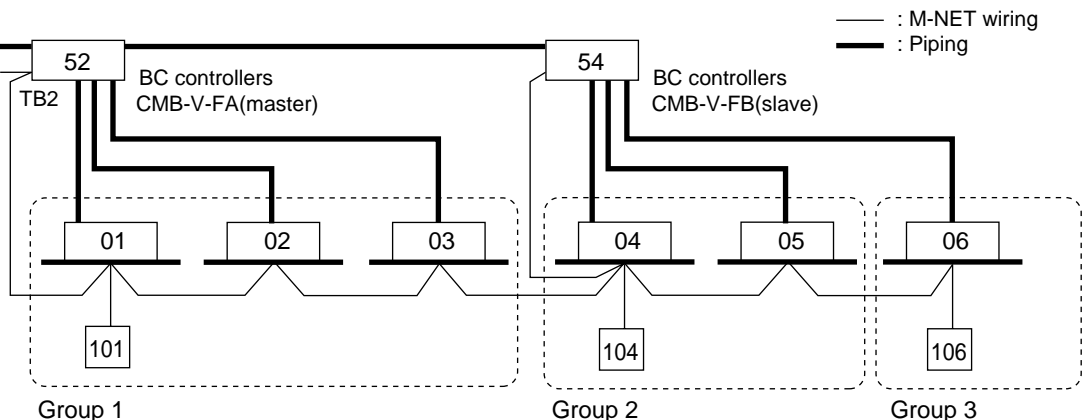

Example 6

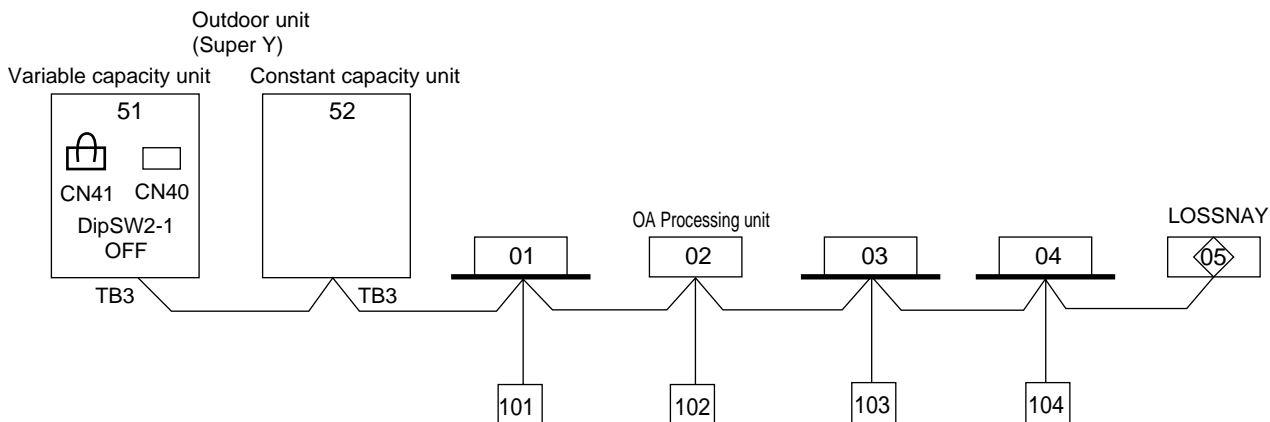

NOTE

- Constant capacity unit address = Variable capacity unit address + 1

Example 7

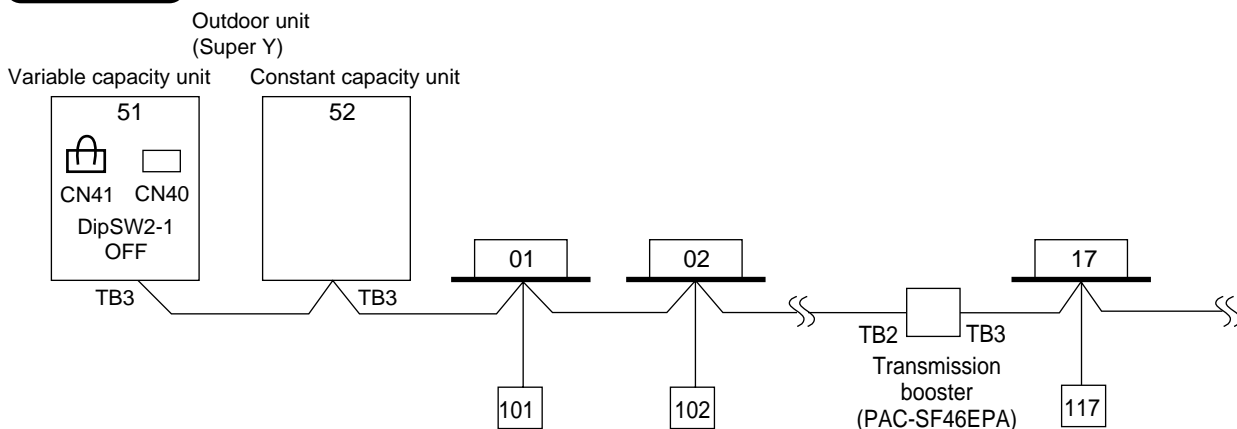

Notes

The transmission booster (RP) is required when the number of connected indoor unit models in cooling system exceeds the number of models specified in the chart below.

* The maximum number of units that can be controlled is determined by the indoor unit model, M-NET remote controller (PAR-F27MEA) and their capabilities.

	Number of BC controllers		
	Zero	One	Two
(*1) Capability of the connected indoor units	F27MEA		
Under 200	20(40)	19(38)	18(36)
Over 200	16(32)	15(30)	14(28)

The number of indoor units and the total number of remote controllers is displayed within the parenthesis ().

*1 If even one unit that is higher than 200 exists in the cooling system, the maximum capacity will be over 200.

Example 8

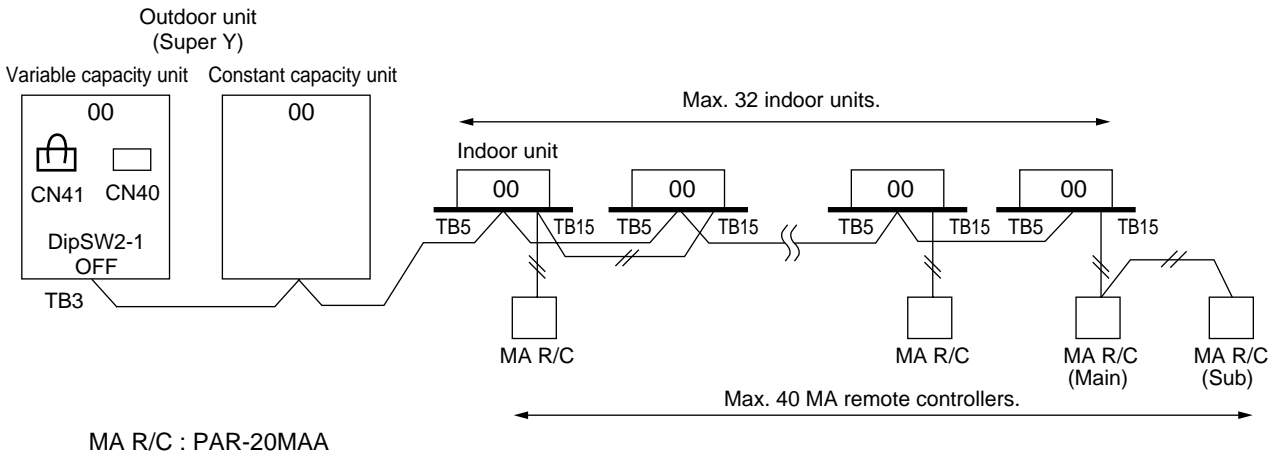

NOTE

- It is not necessary to install the transmission booster on the MA remote controller system.

Example 9

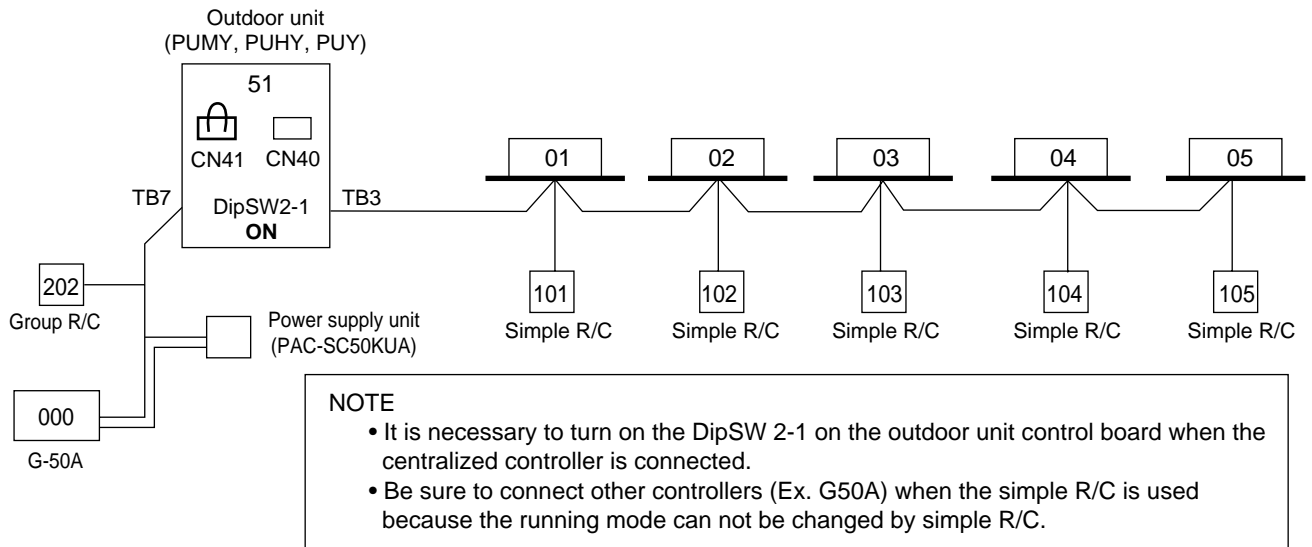

NOTE

- It is necessary to turn on the DipSW 2-1 on the outdoor unit control board when the centralized controller is connected.
- Be sure to connect other controllers (Ex. G50A) when the simple R/C is used because the running mode can not be changed by simple R/C.

Example 10

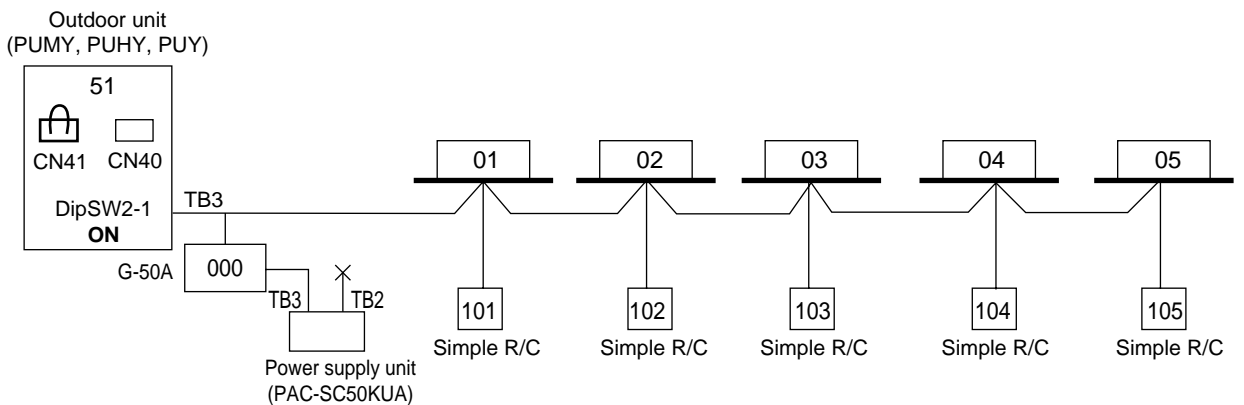

NOTE

- It is not necessary to connect the M-NET line between G-50A and Power supply unit (TB2) when G-50A is connected on the indoor line.

Example 11

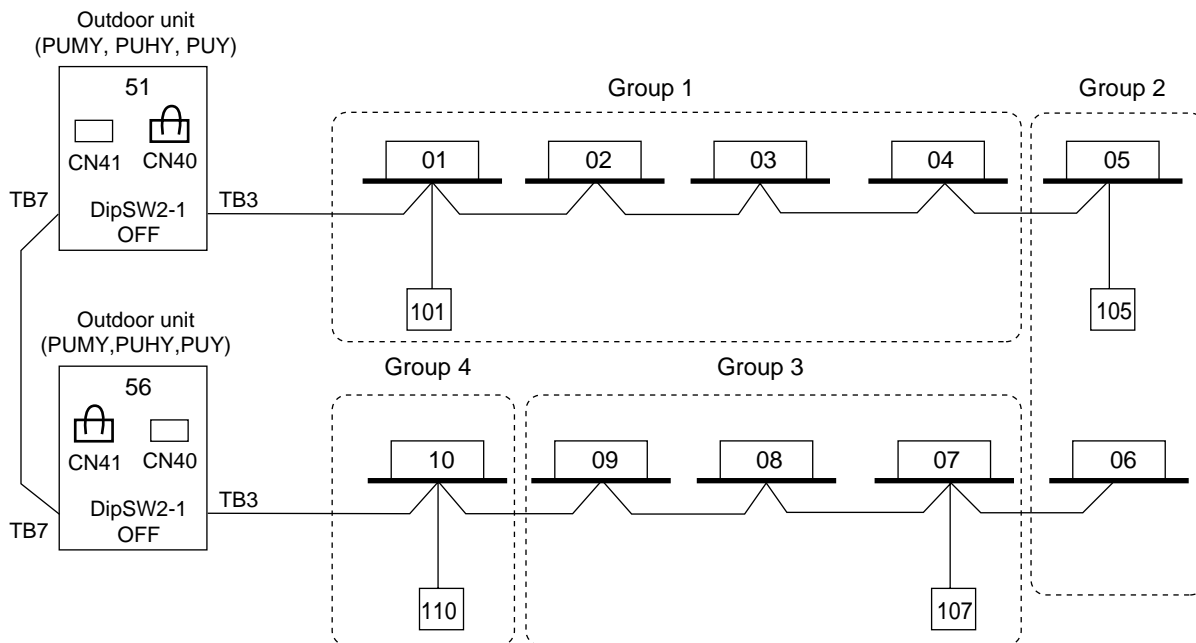

NOTE

- It is necessary to change the connector to CN40 on the outdoor unit control board (only one outdoor unit) when the group is set between other refrigerant systems.
- It is necessary to set on the remote controller by manual when group sets on the different refrigerant system. Please refer to remote controller installation manual.

Example 12

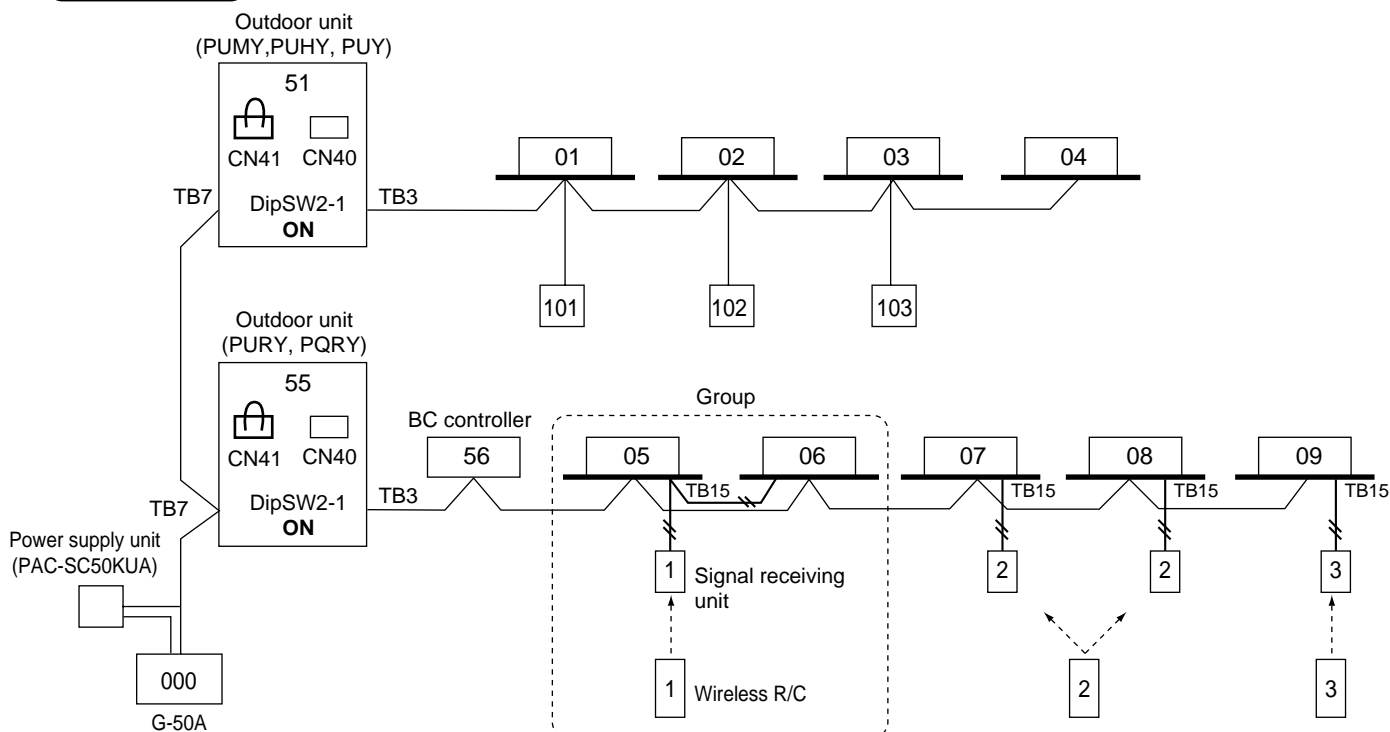

Example 13

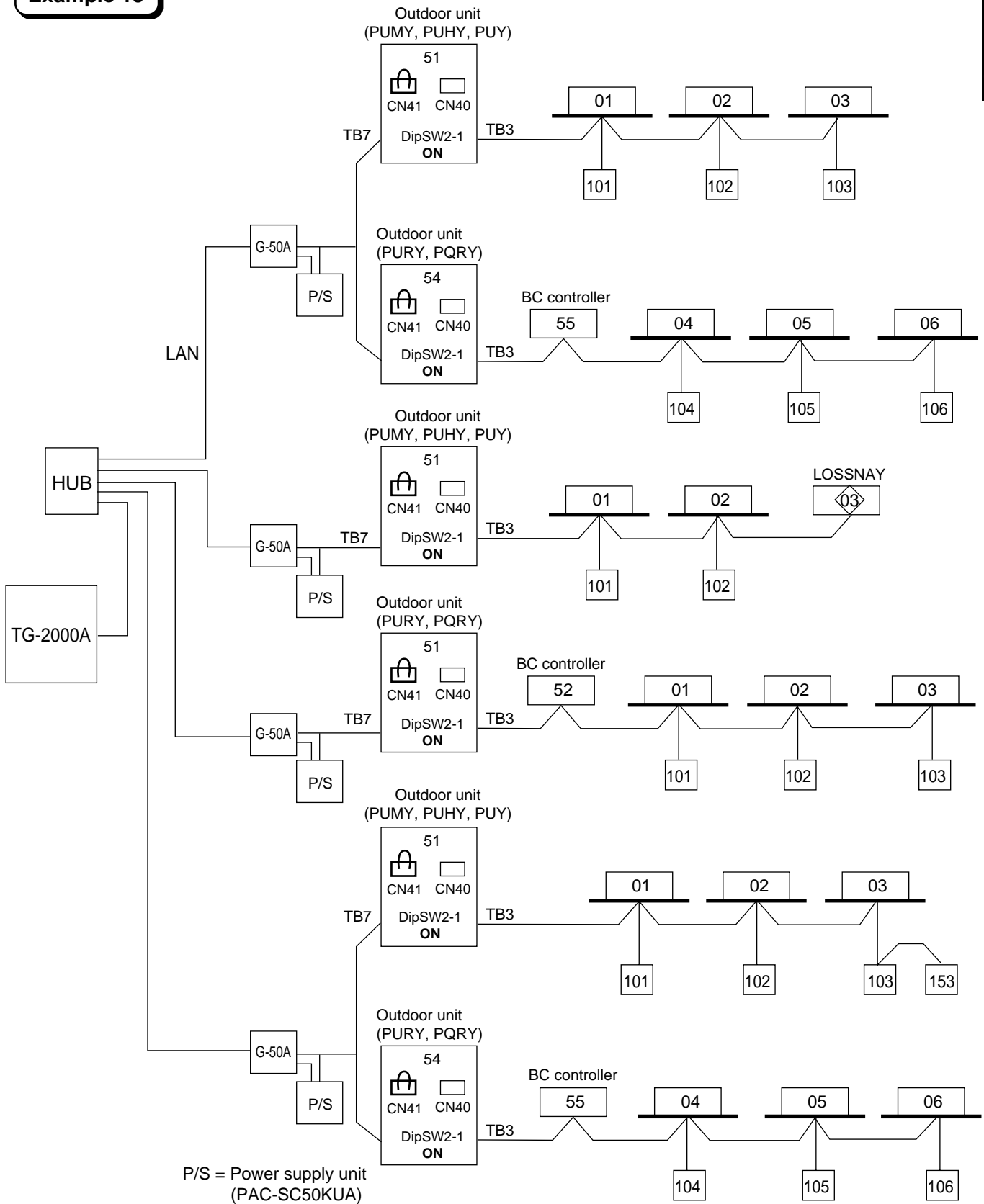

NOTE

- G-50A can control 50 indoor units.
- TG-2000A can control 40 G-50As.
- TG-2000A can control 2000 indoor units.

Example 14

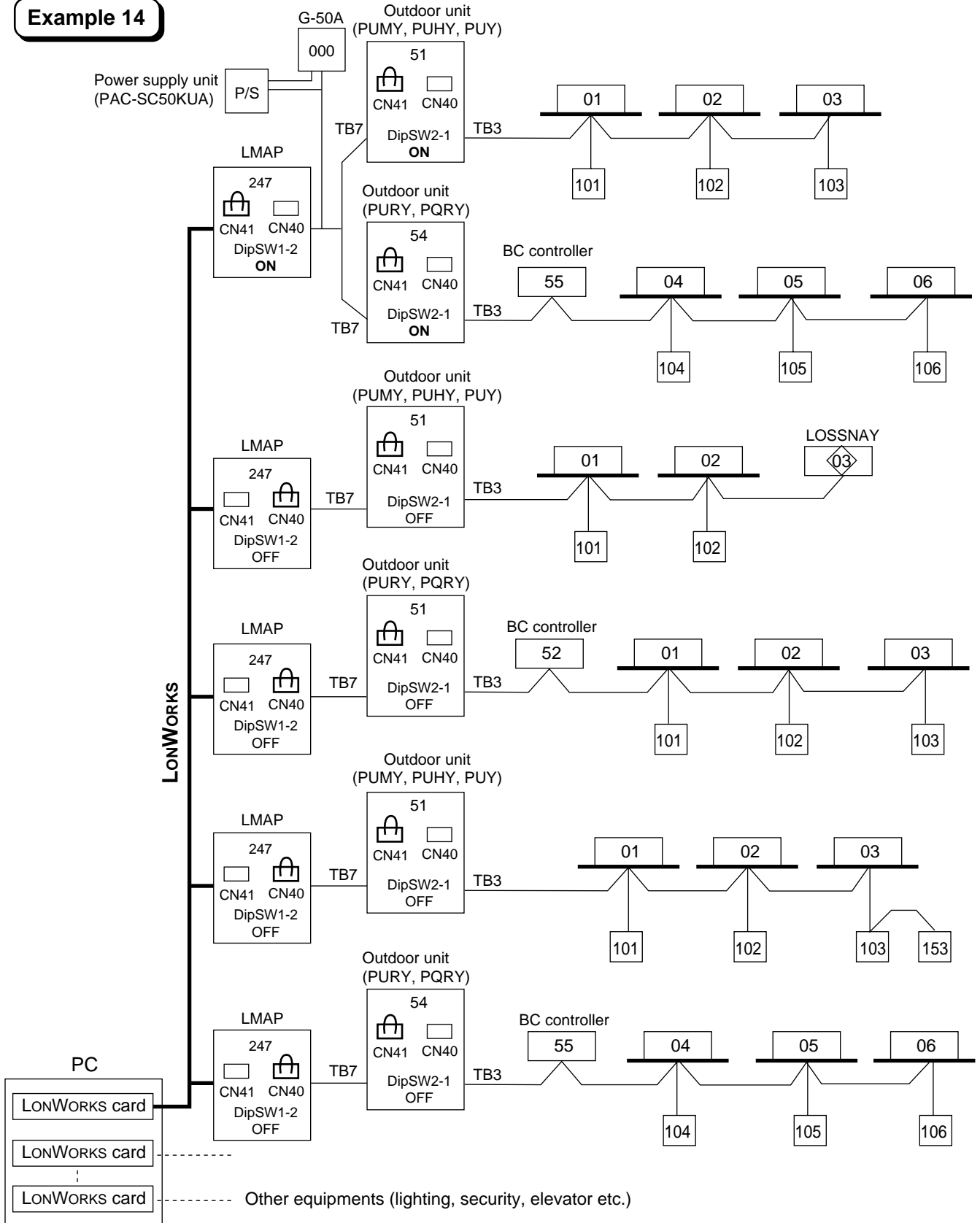

NOTE

- LMAP (LMAP02-E) can control 50 indoor units.
- It is necessary to turn on the DipSW1-2 on the LMAP control board and the DipSW2-1 on the outdoor unit control board with centralized controllers (Power supply unit).
- It is necessary to change the connector to CN40 on the LMAP control board without centralized controllers (Power supply unit).

2. Refrigerant & Piping

2-1 System examples

Using line branches, header branches and combinations of these branches, a "free piping system" involving minimal restrictions can be configured to give a free hand in indoor and outdoor unit refrigerant piping design.

① PUMY, PUHY, PUY

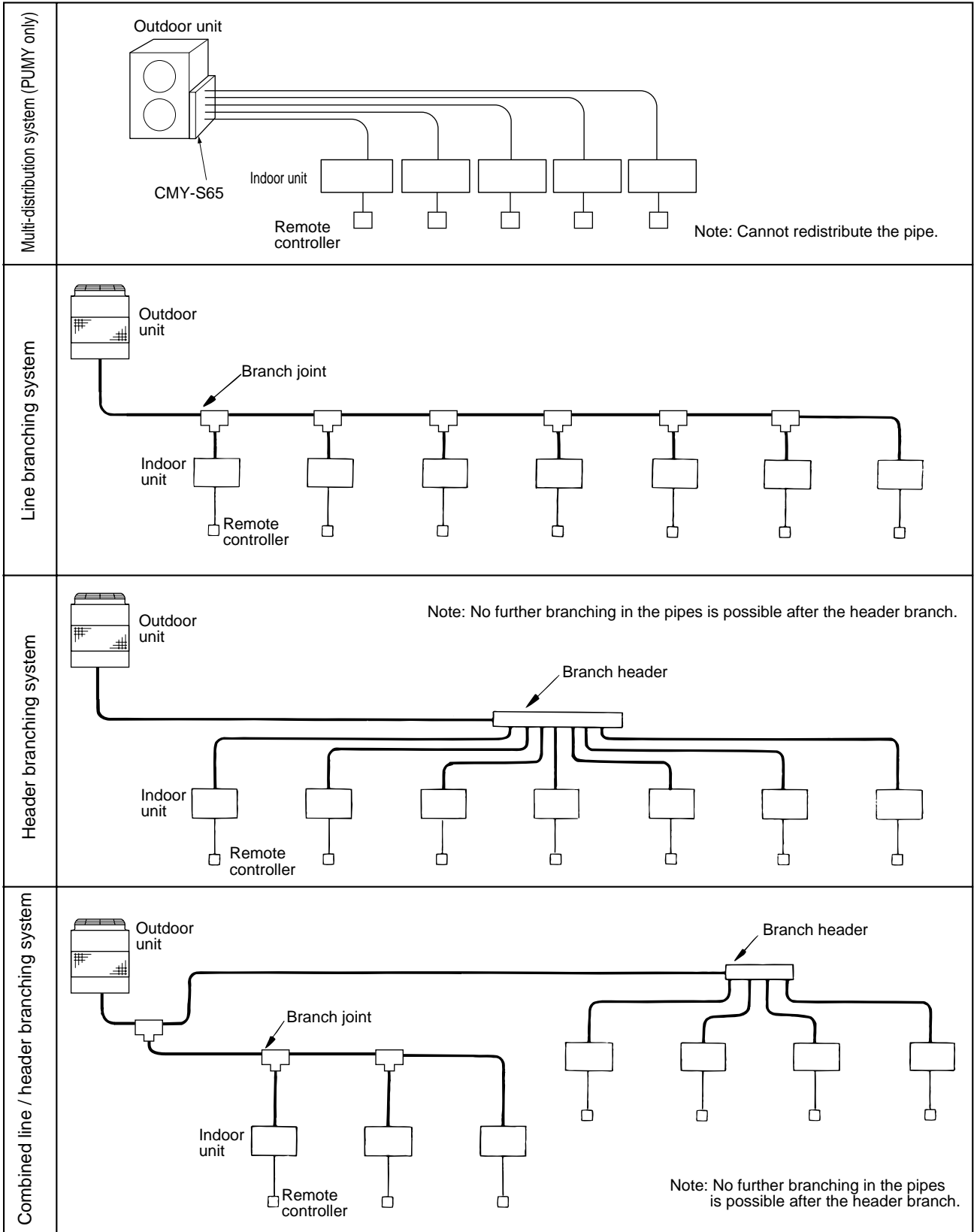

② PURY, PQRY

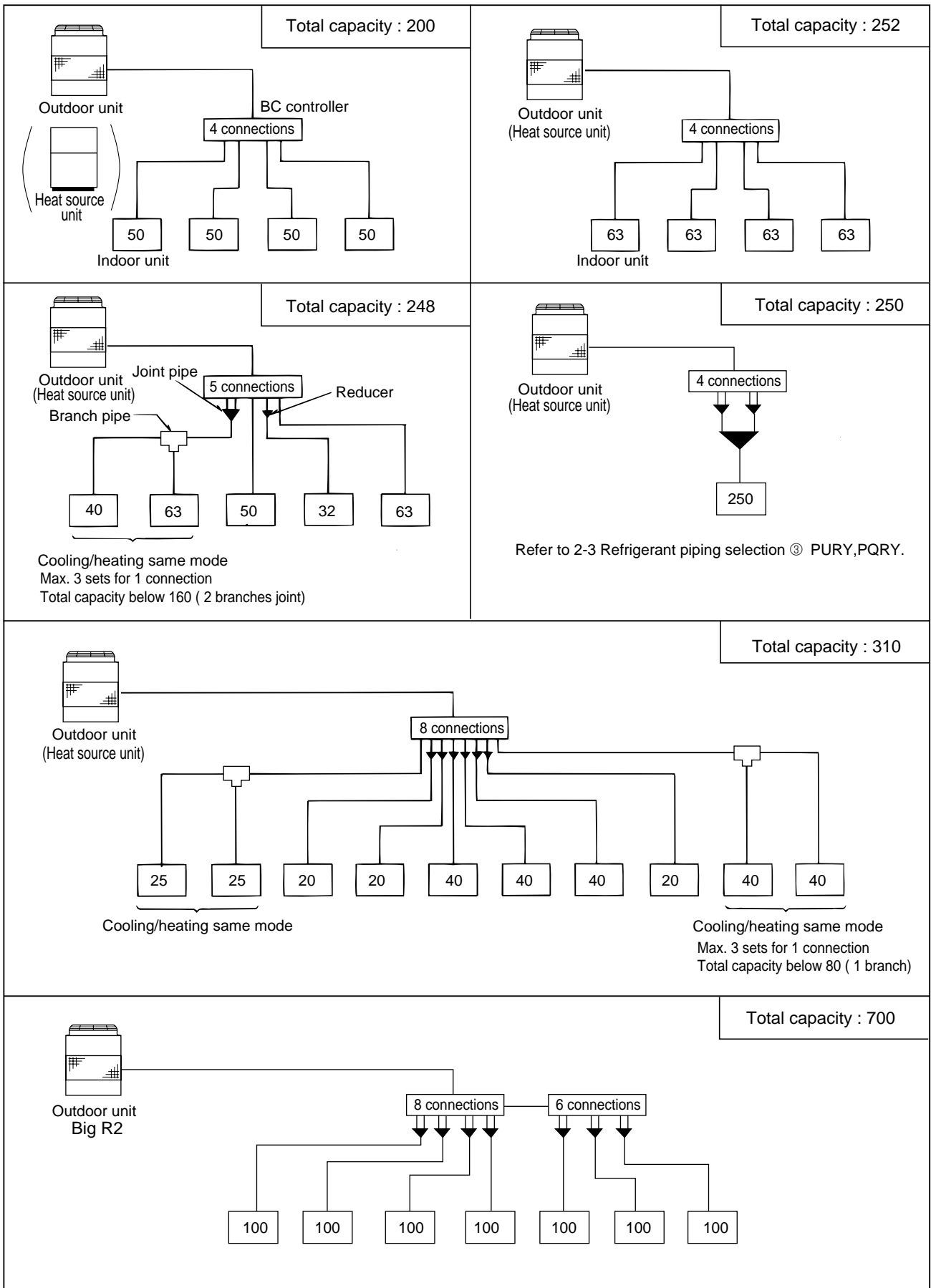

2-2 Restrictions on refrigerant piping lengths

① PUMY

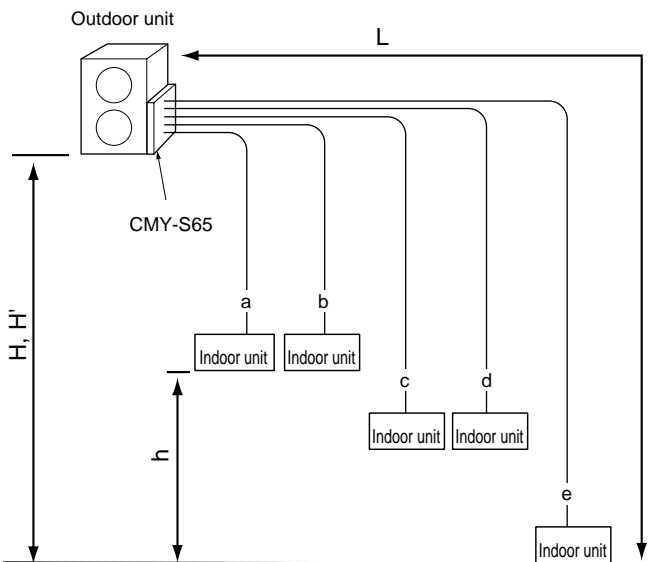
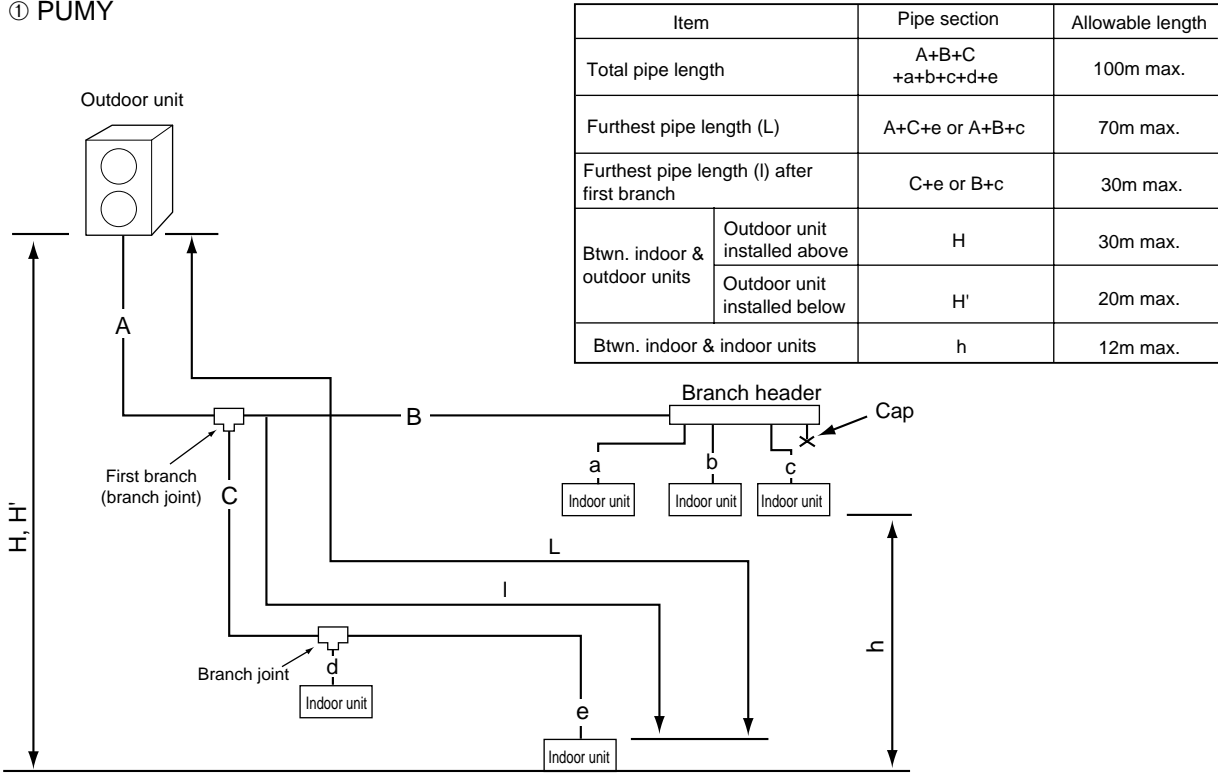

Item	Pipe section	Allowable length	
Total pipe length	a+b+c+d+e	100m max.	
Furthest pipe length (L)	e	30m max.	
Btwn. indoor & outdoor units	Outdoor unit installed above	H	30m max.
	Outdoor unit installed below	H'	20m max.
Btwn. indoor & indoor units	h	12m max.	

② PU(H)Y-(P)200-250-315

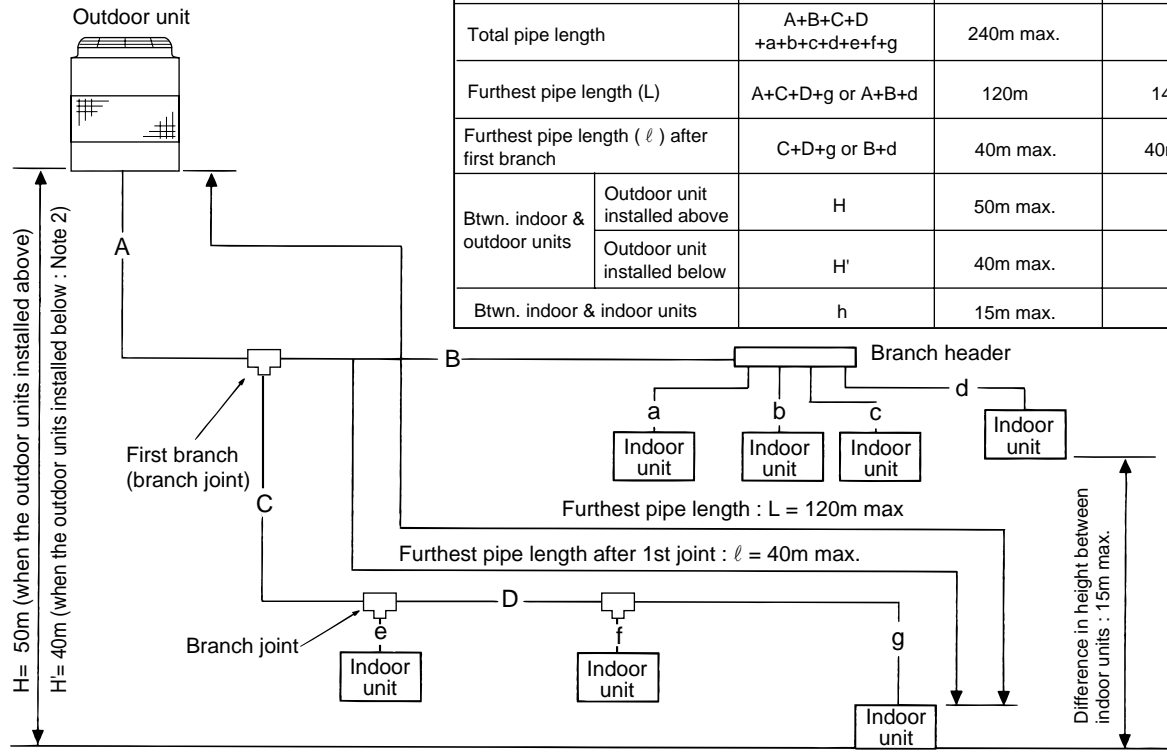

Item	Pipe section	Allowable length	Equivalent length
Total pipe length	A+B+C+D +a+b+c+d+e+f+g	240m max.	-
Furthest pipe length (L)	A+C+D+g or A+B+d	120m	140m
Furthest pipe length (ℓ) after first branch	C+D+g or B+d	40m max.	40m max.
Btwn. indoor & outdoor units	Outdoor unit installed above	H	50m max.
	Outdoor unit installed below	H'	40m max.
Btwn. indoor & indoor units	h	15m max.	-

- Notes: 1. No further branching in the pipes is possible after the header branch.
 2. When cooling operation is performed when the outdoor temp. is 10°C or lower (R407C units : 0°C or lower) : H'= 4m or less.
 3. Equivalent pipe length (m) : Actual pipe length + model 200 : 0.47
 model 250 : 0.50 X number of bent.
 model 315 : 0.70

③ PUHY-(P)400-500

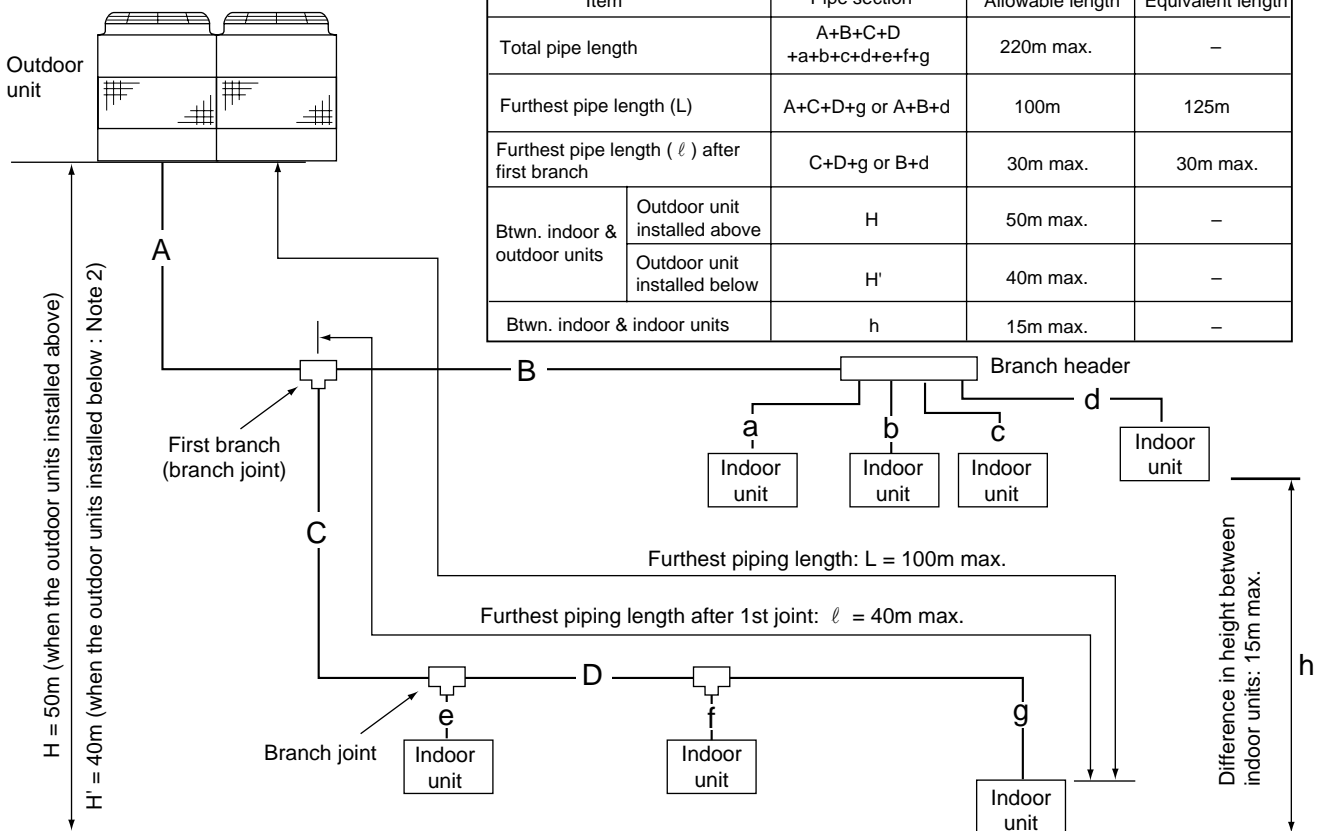

Item	Pipe section	Allowable length	Equivalent length
Total pipe length	A+B+C+D +a+b+c+d+e+f+g	220m max.	-
Furthest pipe length (L)	A+C+D+g or A+B+d	100m	125m
Furthest pipe length (ℓ) after first branch	C+D+g or B+d	30m max.	30m max.
Btwn. indoor & outdoor units	Outdoor unit installed above	H	50m max.
	Outdoor unit installed below	H'	40m max.
Btwn. indoor & indoor units	h	15m max.	-

- Notes: 1. No further branching in the pipes is possible after the header branch.
 2. When cooling operation is performed when the outdoor temp. is 10°C or lower : H'= 4m or less.
 3. Equivalent pipe length (m) : Actual pipe length + model 400 : 0.70
 model 500 : 0.80 X number of bent.

④ PUHY-(P)600-650-700-750

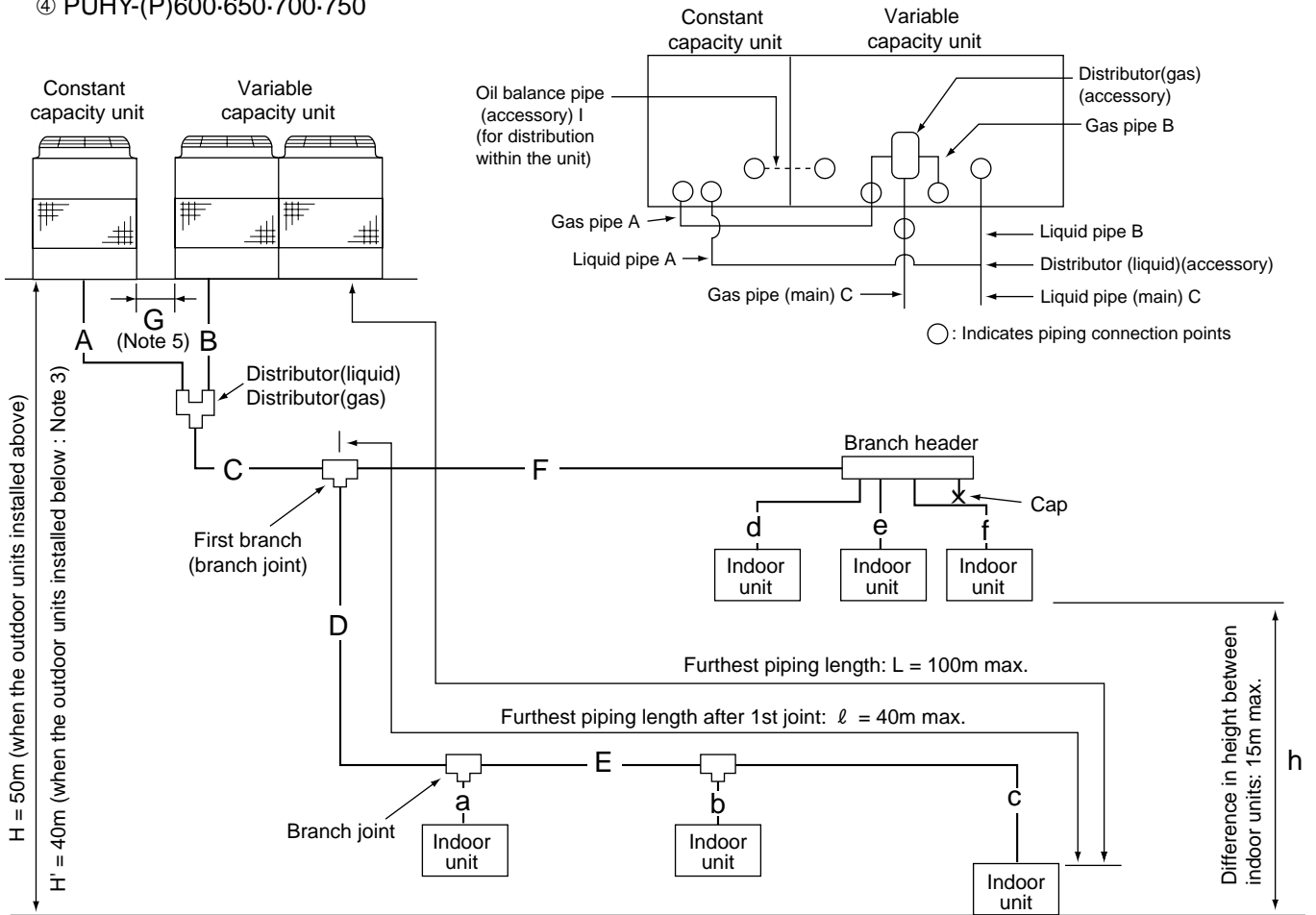

- Notes:
1. Connect the variable capacity unit and constant capacity unit with Distributor kit (accessory) in the filed.
 2. Distributor kit is attached with Constant capacity unit.
 3. Mount the constant capacity unit on the left and variable capacity unit on the right. (as seen from the front of the unit)
 4. When cooling operation is performed when the outdoor temp. is 10°C or lower : H'= 4m or less.
 - model 600 : 0.80
 - model 650 : 0.95
 - model 700 : 0.95
 - model 750 : 0.95
 5. Equivalent pipe length (m) : Actual pipe length + \times number of bent.
 6. Set the constant capacity unit and variable capacity unit in accordance with the G dimension given in the figure above. (G = 0.01m)
 7. No further branching in the pipes is possible after the header branch.

Item	Pipe section	Allowable length	Equivalent length
Total pipe length	A+B+C+D+E+F +a+b+c+d+e+f	220m max.	-
Furthest pipe length (L)	A(B)+C+D+E+c	100m max	125m
Furthest pipe length (ℓ) after first branch	D+E+c	40m max.	-
Oil balance pipe	I	The oil balance pipe (Distributor kit: accessory) must be used. If any other piping is used, the length of the oil balance pipe must be no more than 3m (max. equivalent length 4m), and height from the bottom of the unit must be no more than 0.1m.	-
Btwn. distributor (liquid) & variable capacity unit, constant capacity unit	A, B (Liquid line)	4m max.	5m
Btwn. distributor (gas) & constant capacity unit	A (Gas line)	4m max.	5m
Btwn. indoor & outdoor units	Outdoor unit installed above	H	50m max.
	Outdoor unit installed below	H'	40m max.
Btwn. indoor & indoor units	h	15m max.	-
Btwn. variable capacity unit & constant capacity unit	-	Must be installed on same frame, and there must be no high/low difference.	-

⑤ PURY-(P)200-250

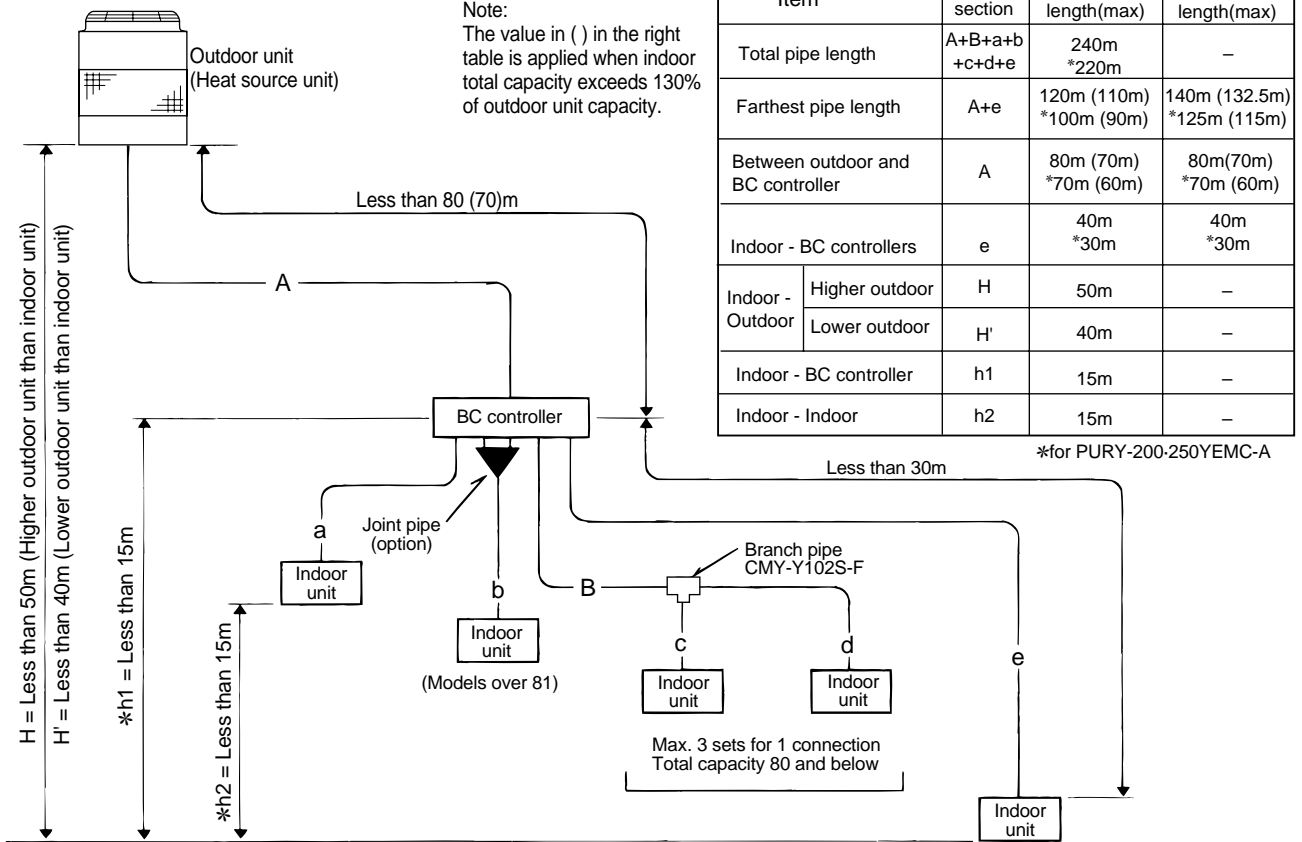

Note:
The value in () in the right table is applied when indoor total capacity exceeds 130% of outdoor unit capacity.

H = Less than 50m (Higher outdoor unit than indoor unit)
H' = Less than 40m (Lower outdoor unit than indoor unit)
*h1 = Less than 15m
*h2 = Less than 15m

Equivalent pipe length (m) : Actual pipe length + model 200 : 0.47
model 250 : 0.50 X number of bent.

*When over 125 capacity index of indoor unit is connected, it is less than 10m not only between indoor to indoor but also indoor and BC controller.

*For PURY-P200-250YEM-A

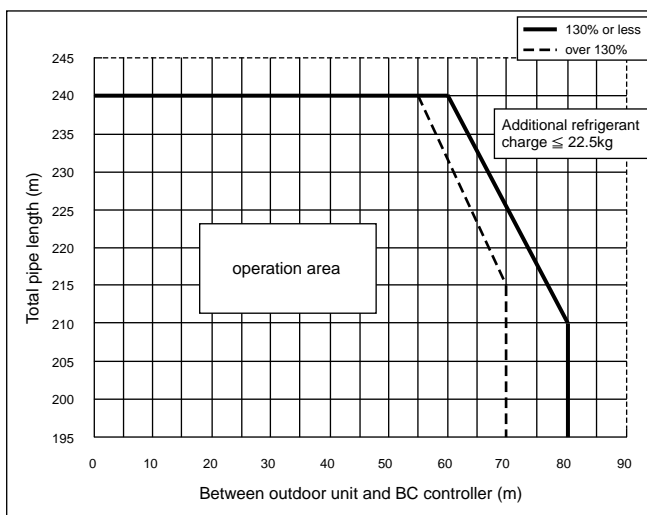

Please follow the following steps to ensure that piping lengths are within specified limits.

1. If a plot of piping lengths falls within the shaded area, piping lengths are within specification.

2. If a plot of piping lengths falls out of the shaded area then check the additional refrigerant charge amount.

*If the additional refrigerant charge amount is less than 22.5kg then the piping lengths are within specification.

*If the additional refrigerant charge amount is above 22.5kg then the piping lengths are out of specification and must be shortened or the indoor unit sizes must be reduced.

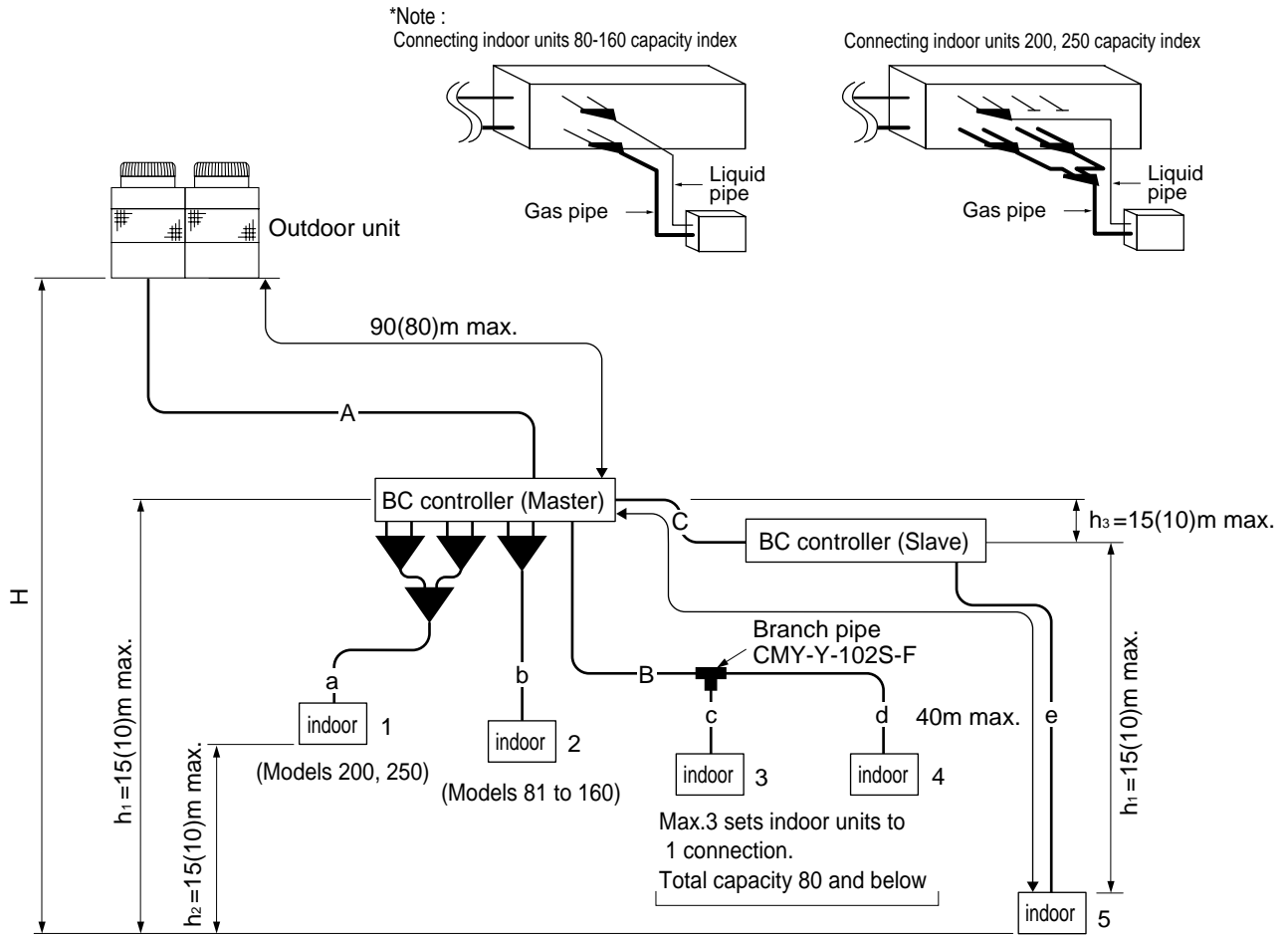

	Item	Pipe section	Allowable length
Length	Total pipe length	A+B+C+a+b+c+d+e	250m max. (220m max. when Outdoor to BC (Master) is over 70m)
	Furthest pipe length	A+C+e	100m max. (90m max. when over 130% connection) *
	Outdoor-BC (Master)	A	90m max. (80m max. when over 130% connection)
	BC(Master or Slave)-Indoor	B+d or C+e	40m max.
Height difference	Indoor-Outdoor	H	50m max. (Lower position of outdoor than indoor)
	Indoor-BC (Master, Slave)	h ₁	15m max. (10m max. on 125, 140 indoor)
	Indoor-Indoor	h ₂	15m max. (10m max. on 125, 140 indoor)
	BC (Master)-BC (Slave)	h ₃	15m max. (10m max. on 125, 140 indoor)

* Equivalent length 125m max. (115m max. when over 130% connection)

Equivalent pipe length : Allowable pipe length + model 400 : 0.7 X number of bent model 500 : 0.8

⑦ PQRV

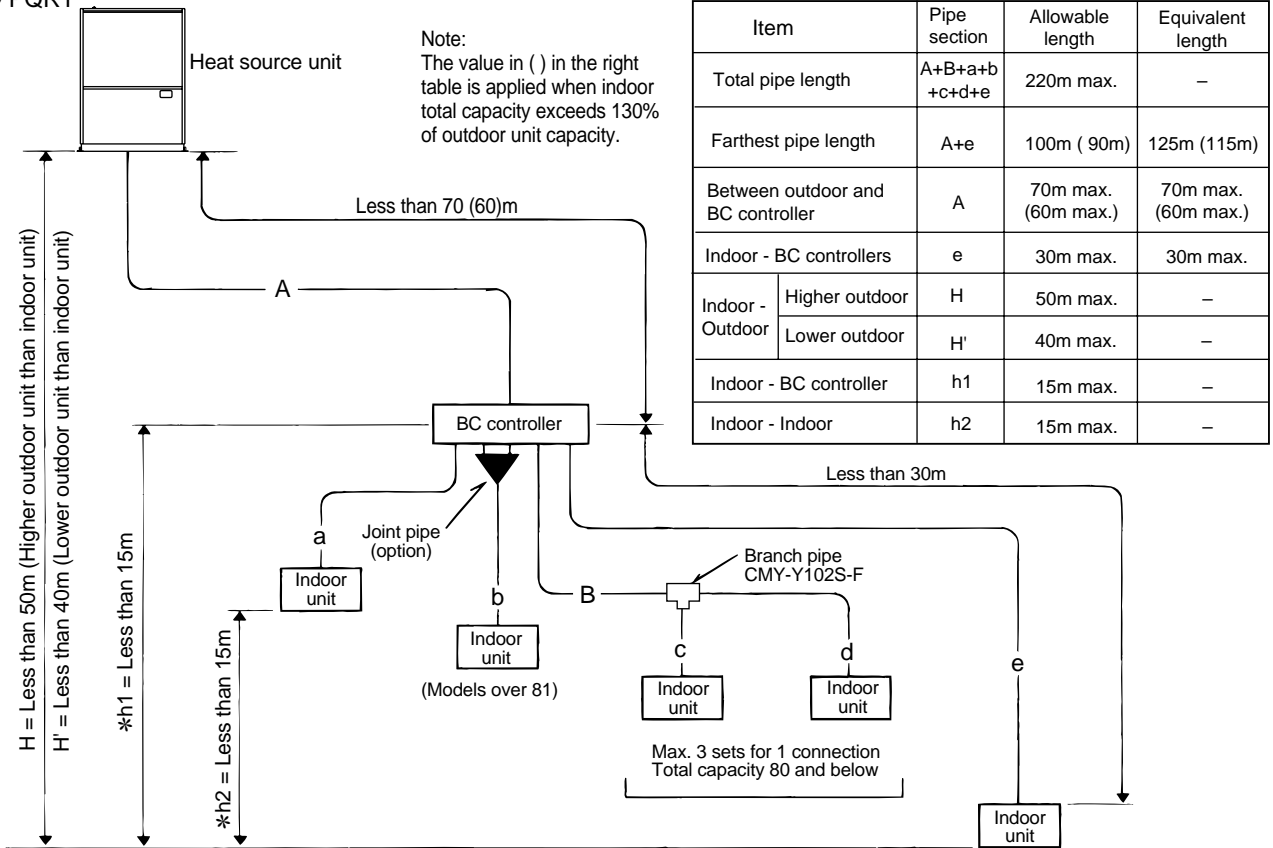

Equivalent pipe length (m) : Actual pipe length + $\frac{\text{model 200} : 0.47}{\text{model 250} : 0.50}$ X number of bent.

*When over 125 capacity index of indoor unit is connected, it is less than 10m not only between indoor to indoor but also indoor and BC controller.

⑧ PQHY

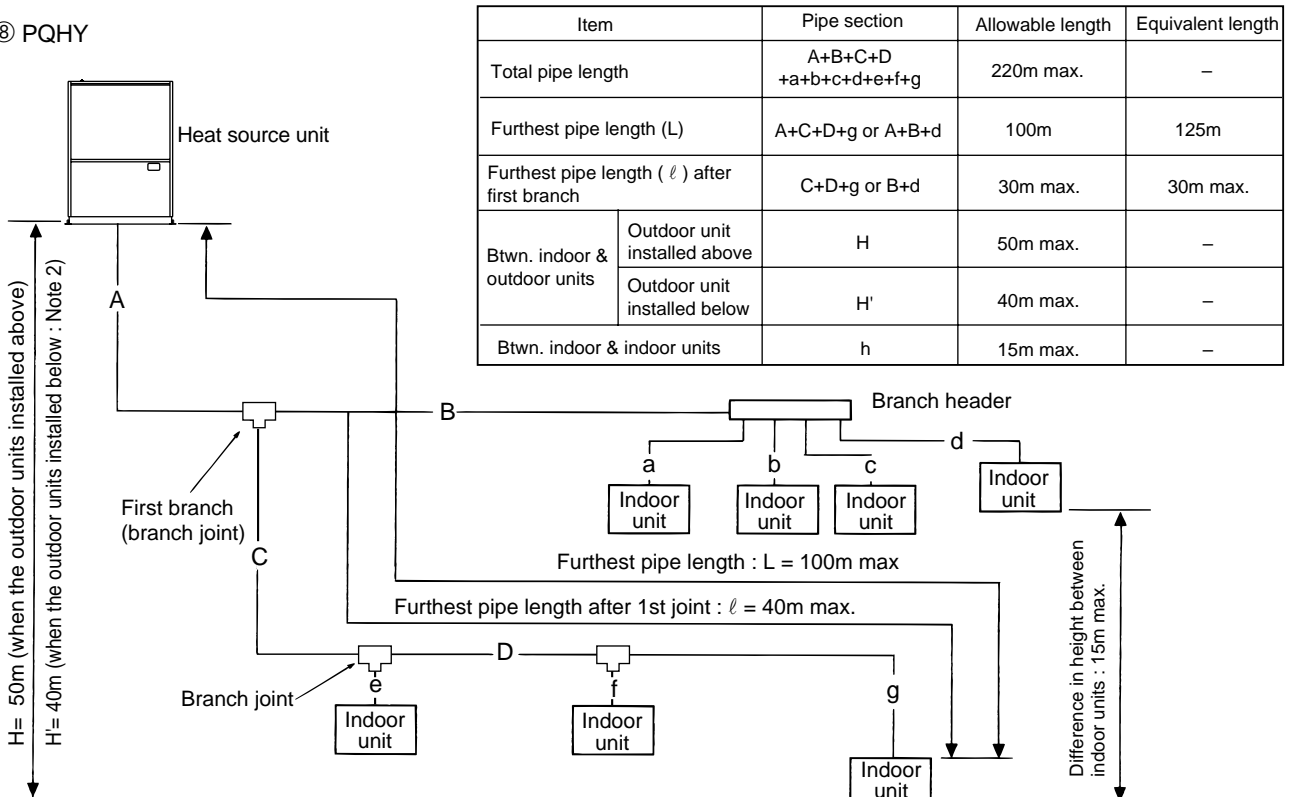

Notes: 1. No further branching in the pipes is possible after the header branch.

2. Equivalent pipe length (m) : Actual pipe length + $\frac{\text{model 200} : 0.47}{\text{model 250} : 0.50}$ X number of bent.

2-3 Refrigerant piping selection

① PUMY

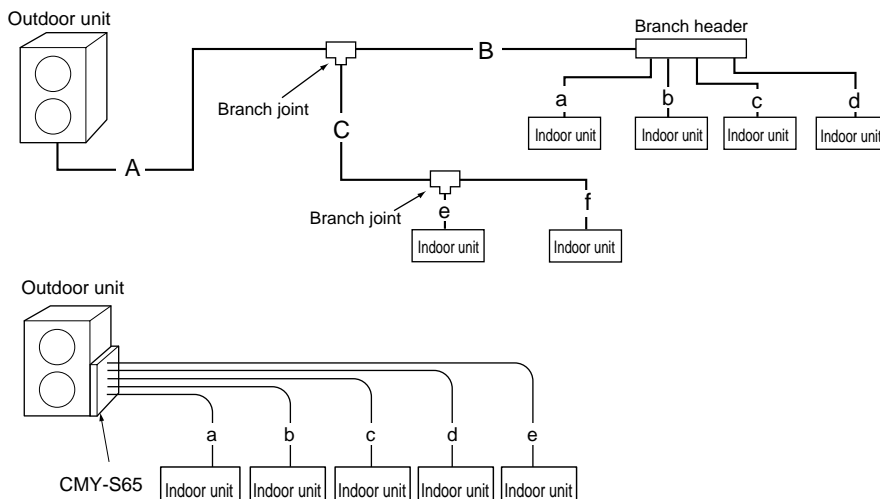

- Note :
- No further branching is possible after the header branch.
 - Model 100 and 125 of indoor unit can not be connected with CMY-Y68 and CMY-S65.

(1) Outdoor unit - 1st branch (Pipe A)

Outdoor unit model	Liquid pipe	Gas pipe
PUMY-125	φ 9.52 X 0.8t	φ 19.05 X 1.0t

(2) Branch joint / Header

Type of branch pipe	Branch number	Branch pipe model
Joint	-	CMY-Y62-C-E
Header	For 4 branches	CMY-Y64-C
	For 8 branches	CMY-Y68
Multi-distribution pipe	For 5 branches	CMY-S65

(3) Branch - Branch (Pipe B,C)

Total capacity of indoor units	Liquid pipe	Gas pipe
~ 80	φ9.52 X 0.8t	φ15.88 X 1.0t
81 ~	φ9.52 X 0.8t	φ19.05 X 1.0t

(4) Branch - Indoor unit (Pipe a, b, c, d, e, f)

Indoor unit model	Liquid pipe	Gas pipe
20,25,32,40	φ6.35 X 0.8t	φ12.7 X 0.8t
50,63,71,80	φ9.52 X 0.8t	φ15.88 X 1.0t
100,125	φ9.52 X 0.8t	φ19.05 X 1.0t

- Indoor unit capacities
The capacity of an indoor unit is the same as the number used for its type identification.
Examples:
PEFY-P63VM → Capacity = 63

* The thickness of pipe is Japanese Standard. Please choose the thickness according to your country standard referring to above chart.

②PUHY, PUY

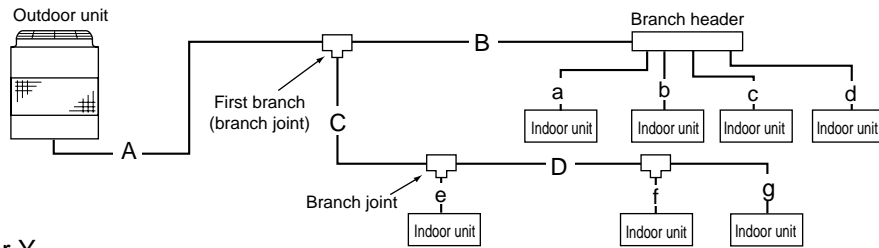

• Super Y

Constant capacity unit (PUHN-(P)200-250) Variable capacity unit (PUHY-(P)400-500)

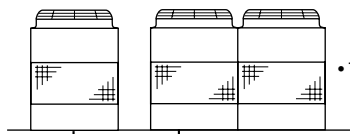

• This unit requires a Distributor kit (accessory).

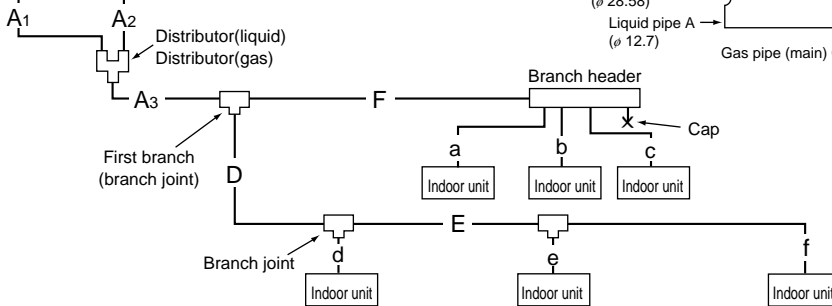

Note : • No further branching is possible after the header branch.

- Arrange the total capacity of the indoor units less than 330, connected on the downstream side by the header branch. It over that, branch pipes on the upstream side using the branch joint.
- Model 200 and 250 can not be connected with header branch.
- Model 20 can not be connected with PUHY-(P) 315, 400, 500.
- Always select CMY-302-F for the first branch of PUHY-(P) 600, 650, 700, 750.
- Distributor kit is attached with Constant capacity unit (PUHN).

(1) Outdoor unit - 1st branch (Pipe A,A1,A2,A3)

Outdoor unit model	Liquid pipe	Gas pipe
PU(H)Y-(P)200	φ 12.7 X 0.8t	*1 φ 25.4 X 1.3t
PUHN-(P)200	φ 12.7 X 0.8t	φ 28.58 X 1.45t
PU(H)Y-(P)250 PUHN-(P)250	φ 12.7 X 0.8t	φ 28.58 X 1.45t
PUHY-(P)315	φ 12.7 X 0.8t	*2 φ 31.75 X 1.6t
PUHY-(P)400	φ 15.88 X 1.0t	*3 φ 34.93 X 1.75t
PUHY-(P)500	φ 15.88 X 1.0t	*4 φ 34.93 X 1.75t
PUHY-(P)600	φ 19.05 X 1.0t	*5 φ 34.93 X 1.75t
PUHY-(P)650	φ 19.05 X 1.0t	φ 41.28 X 2.1t
PUHY-(P)700	φ 19.05 X 1.0t	φ 41.28 X 2.1t
PUHY-(P)750	φ 19.05 X 1.0t	φ 41.28 X 2.1t

- *1 The pipe of 28.58mm can be used for the gas pipe of PU(H)Y-(P)200.
- *2 The pipe of 34.93mm can be used for the gas pipe of PUHY-(P)315.
- *3 The pipe of 31.75mm can be used for the gas pipe of PUHY-(P)400.
- *4 The pipe of 38.1mm can be used for the gas pipe of PUHY-(P)500.
- *5 The pipe of 38.1mm can be used for the gas pipe of PUHY-(P)600.

(3) Branch - Branch (Pipe B,C,D,E,F)

Total capacity of indoor units	Liquid pipe	Gas pipe
~ 80	φ9.52 X 0.8t	φ15.88 X 1.0t
81 ~ 160	φ12.7 X 0.8t	φ19.05 X 1.0t
161 ~ 330	φ12.7 X 0.8t	** φ25.4 X 1.3t
331 ~ 480	φ15.88 X 1.0t	φ31.75 X 1.6t or φ34.93 X 1.75t
481 ~ 630	φ15.88 X 1.0t	φ38.1 X 1.9t or φ34.93 X 1.75t
631 ~	φ19.05 X 1.0t	φ41.28 X 2.1t

- ** The pipe of 28.58mm can be used for the gas pipe of PU(H)Y-(P)200.
- * The thickness of pipe is Japanese Standard. Please choose the thickness according to your country standard referring to above chart.

(2) Branch joint / Header

Type of branch pipe	Total capacity of indoor units	Branch pipe model
Joint	~ 160	CMY-Y102S-F
	161 ~ 330	CMY-Y102L-F
	331 ~ 630	CMY-Y202-F
	The 1st branch of PUHY-(P)315, 400, 500	
	631 or above	CMY-Y302-F
The 1st branch of PUHY-(P)600, 650, 700, 750		
Header	PUHY-(P)600, 650, 700, 750	Distributor kit (accessory)
	For 4 branches	CMY-Y104-F
	For 7 branches	CMY-Y107-F
	For 10 branches	CMY-Y1010-F

(4) Branch - Indoor unit (Pipe a, b, c, d, e, f, g)

Indoor unit model	Liquid pipe	Gas pipe
20,25,32,40	φ6.35 X 0.8t	φ12.7 X 0.8t
50,63,71,80	φ9.52 X 0.8t	φ15.88 X 1.0t
100,125,140	φ9.52 X 0.8t	φ19.05 X 1.0t
200	φ12.7 X 0.8t	φ25.4 X 1.3t
250	φ12.7 X 0.8t	φ28.58 X 1.3t

- Indoor unit capacities
The capacity of an indoor unit is the same as the number used for its type identification.
Examples:
PEFY-P63VM → Capacity = 63

③PURY, PQR
Outdoor unit
(Heat source unit)

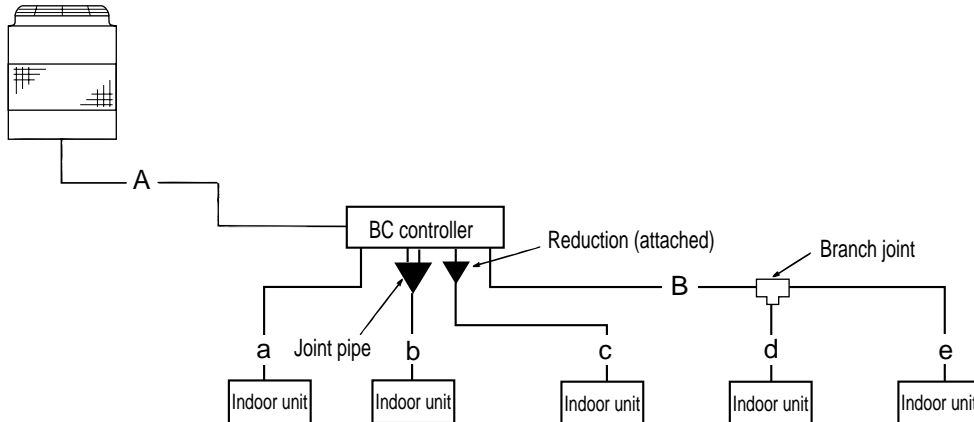

(1) Outdoor unit - BC controller (Pipe A)

Outdoor unit model	High press. pipe	Low press. pipe
PURY-(P)200 PQR-P200	φ 19.05 X 1.0t	*φ 25.4 X 1.3t
PURY-(P)250 PQR-P250	φ 19.05 X 1.0t	φ 28.58 X 1.45t

* The pipe of 28.58mm can be used for the gas pipe of (P)200.

(2) Branch joint

Total capacity of indoor units	Branch joint
~ 160	CMY-Y102S-F

• Joint pipe CMY-R160-H

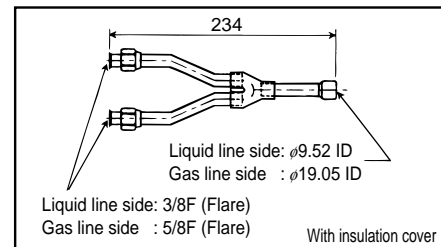

(3) BC controller - Branch (Pipe B)

Total capacity of indoor units	Liquid pipe	Gas pipe
~ 80	φ9.52 X 0.8t	φ15.88 X 1.0t
81 ~ 160	φ9.52 X 0.8t	φ19.05 X 1.0t

(4) Branch or BC controller - Indoor unit (Pipe a,b,c,d,e,f,g)

Indoor unit model	Liquid pipe	Gas pipe
20,25,32,40	φ6.35 X 0.8t	φ12.7 X 0.8t
50,63,71,80	φ9.52 X 0.8t	φ15.88 X 1.0t
100,125,140	φ9.52 X 0.8t	φ19.05 X 1.0t

* The thickness of pipe is Japanese Standard. Please choose the thickness according to your country standard referring to above chart.

• Indoor unit capacities

The capacity of an indoor unit is the same as the number used for its type identification.

Examples:PEFY-P63VM → Capacity = 63

Model number	Liquid pipe		Gas pipe		
	h	i	j	k	ℓ
200	φ12.7	φ9.52	φ25.4	φ19.05	φ15.88
250	φ12.7	φ9.52	φ28.58	φ19.05	φ15.88

④ PURY-P400-500

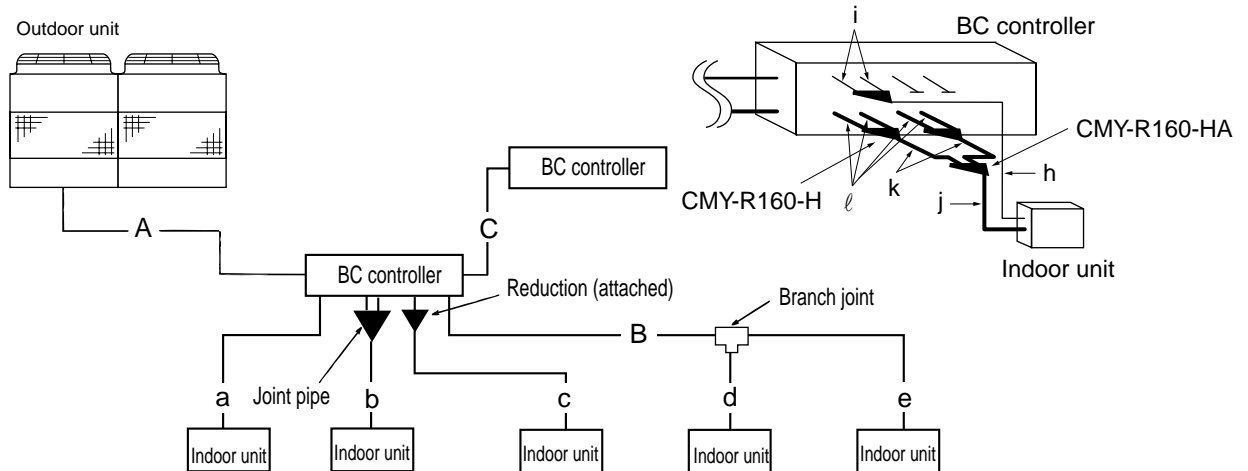

(1) Outdoor unit - BC controller (Pipe A)

Outdoor unit model	High press. pipe	Low press. pipe
PURY-P400	* ϕ 25.4	ϕ 34.93
PURY-P500	* ϕ 25.4	ϕ 34.93

* The pipe of ϕ 22.22 can be used for the high press pipe.

• Joint pipe CMY-R160-H

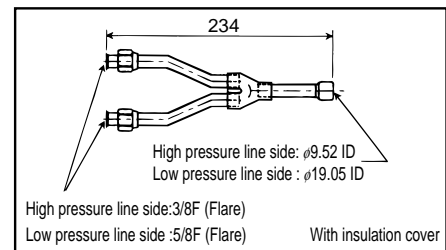

(2) Branch joint

Total capacity of indoor units	Branch joint
~ 160	CMY-Y102S-F
160 ~	CMY-Y102L-F

CMY-R160-HA

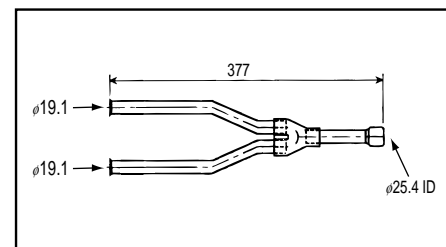

(3) BC controller - Branch (Pipe B)

Total capacity of indoor units	Liquid pipe	Gas pipe
~ 80	ϕ 9.52	ϕ 15.88
81 ~ 160	ϕ 9.52	ϕ 19.05

(4) BC controller - BC controller (Pipe C)

High press gas pipe	Low press gas pipe	Liquid pipe
ϕ 19.05	ϕ 28.58	ϕ 12.7

(5) Branch or BC controller - Indoor unit (Pipe a,b,c,d,e,f,g)

Indoor unit model	Liquid pipe	Gas pipe
20,25,32,40	ϕ 6.35	ϕ 12.7
50,63,71,80	ϕ 9.52	ϕ 15.88
100,125,140	ϕ 9.52	ϕ 19.05

* The thickness of pipe is Japanese Standard. Please choose the thickness according to your country standard referring to above chart.

• Indoor unit capacities

The capacity of an indoor unit is the same as the number used for its type identification.

Examples:PEFY-P63VM → Capacity = 63

Model number	Liquid pipe		Gas pipe		
	h	i	j	k	l
200	ϕ 12.7	ϕ 9.52	ϕ 25.4	ϕ 19.05	ϕ 15.88
250	ϕ 12.7	ϕ 9.52	ϕ 28.58	ϕ 19.05	ϕ 15.88

2-4 Example of refrigerant piping selection

① Example 1

Outdoor unit : PUHY-200

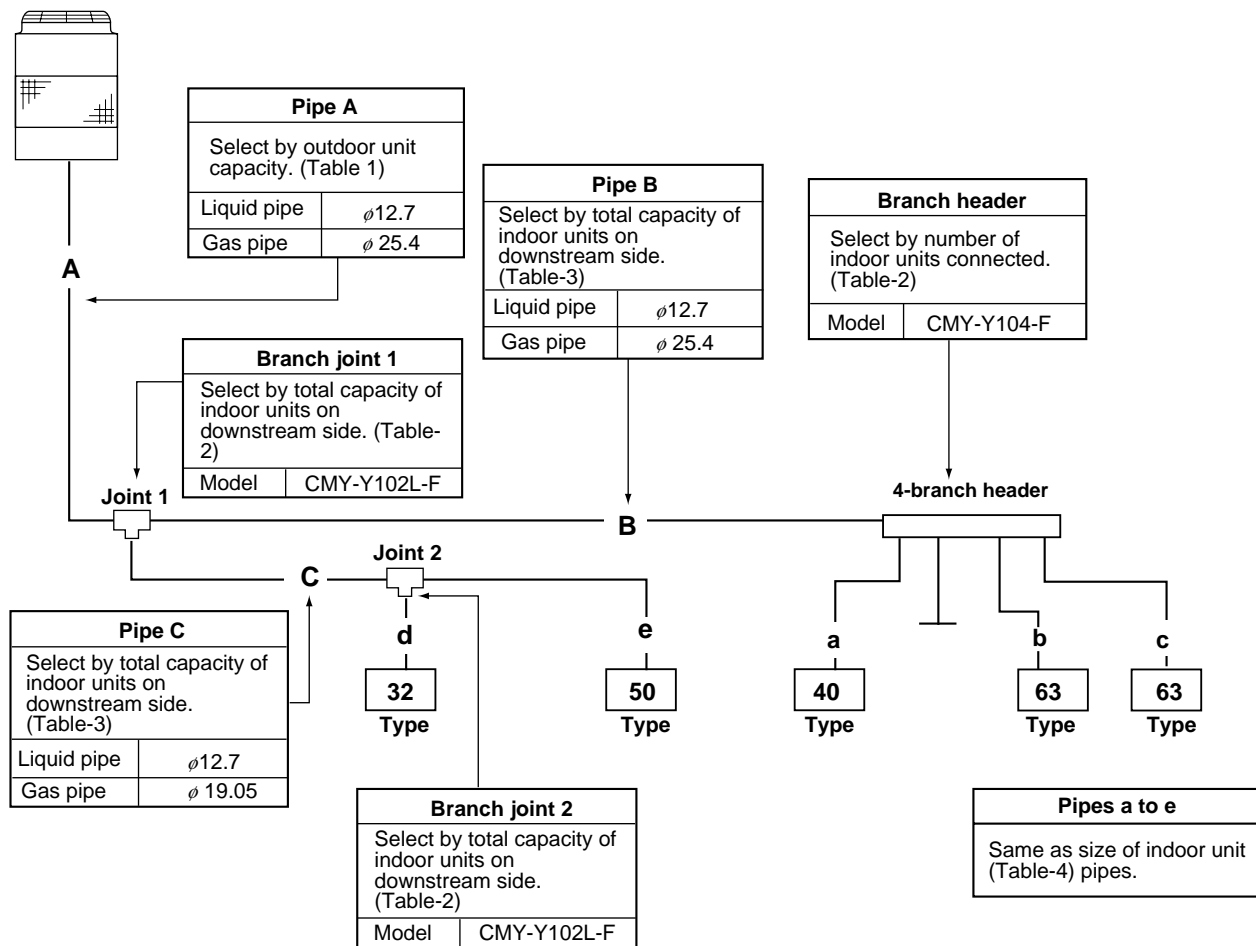

(1) Selection of branch pipe kit

Branch area	Branch pipe kit selection method	Branch pipe kit model
Joint 1	$32 + 40 + 50 + 63 + 63 = 248$ (161 or above)	CMY-Y102L-F
Joint 2	$32 + 50 = 82$ (160 or below)	CMY-Y102S-F
Header	For 4 branches with 8 HP outdoor unit	CMY-Y104-F

(2) Selection of pipe size

Pipe area	Refrigerant pipe selection method	Liquid pipe size	Gas pipe size
A	Same as size of outdoor unit's refrigerant pipe	$\phi 12.7$	$\phi 25.4$
B	$40 + 63 + 63 = 166$ (160 or above)	$\phi 12.7$	ϕ
C	$32 + 50 = 82$ (81 ~ 160)	ϕ	$\phi 19.05$
a	Same as size of indoor unit's refrigerant pipe	$\phi 6.35$	$\phi 12.7$
b	ϕ	$\phi 9.52$	$\phi 15.88$
c	ϕ	ϕ	ϕ
d	ϕ	$\phi 6.35$	$\phi 12.7$
e	ϕ	$\phi 9.52$	$\phi 15.88$

② Example 2

Outdoor unit : PUHY-400

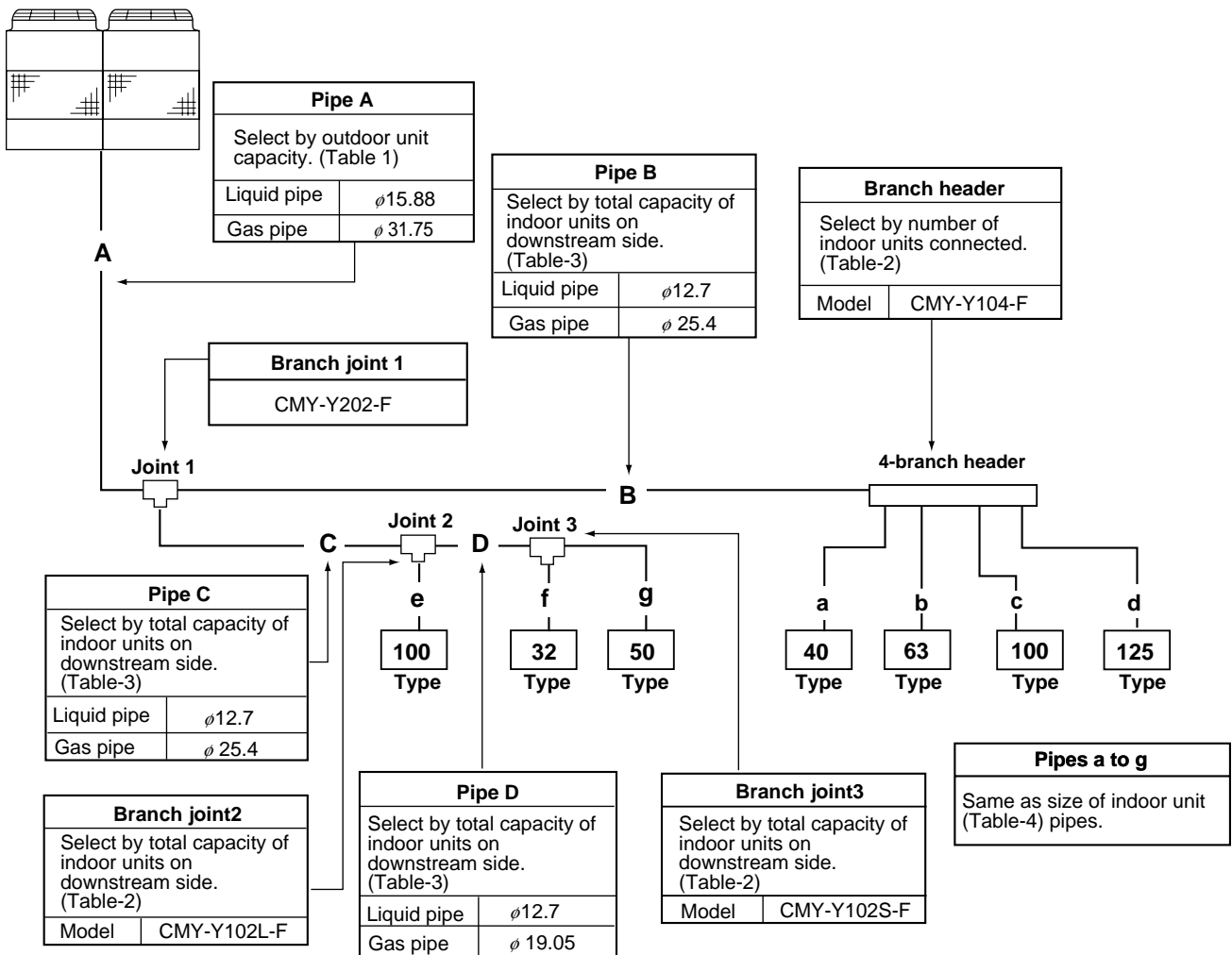

(1) Selection of branch pipe kit

Branch area	Branch pipe kit selection method	Branch pipe kit model
Joint 1	-	CMY-Y202-F
Joint 2	$32 + 50 + 100 = 182$ (160 or above)	CMY-Y102L-F
Joint 3	$32 + 50 = 82$ (160 or below)	CMY-Y102S-F
Header	For 4 branches with 8 HP outdoor unit	CMY-Y104-F

(2) Selection of pipe size

Pipe area	Refrigerant pipe selection method	Liquid pipe size	Gas pipe size
A	Same as size of outdoor unit's refrigerant pipe	$\phi 15.88$	$\phi 31.75$
B	$40 + 63 + 100 + 125 = 328$ (161 ~ 330)	$\phi 12.7$	$\phi 25.4$
C	$32 + 50 + 100 = 182$ (161 ~ 330)	∕	∕
D	$32 + 50 = 82$ (81 ~ 160)	∕	$\phi 19.05$
a	Same as size of indoor unit's refrigerant pipe	$\phi 6.35$	$\phi 12.7$
b	∕	$\phi 9.52$	$\phi 15.88$
c	∕	∕	$\phi 19.05$
d	∕	∕	∕
e	∕	∕	∕
f	∕	$\phi 6.35$	$\phi 12.7$
g	∕	$\phi 9.52$	$\phi 15.88$

③ Example 3

Outdoor unit : PUHY-750

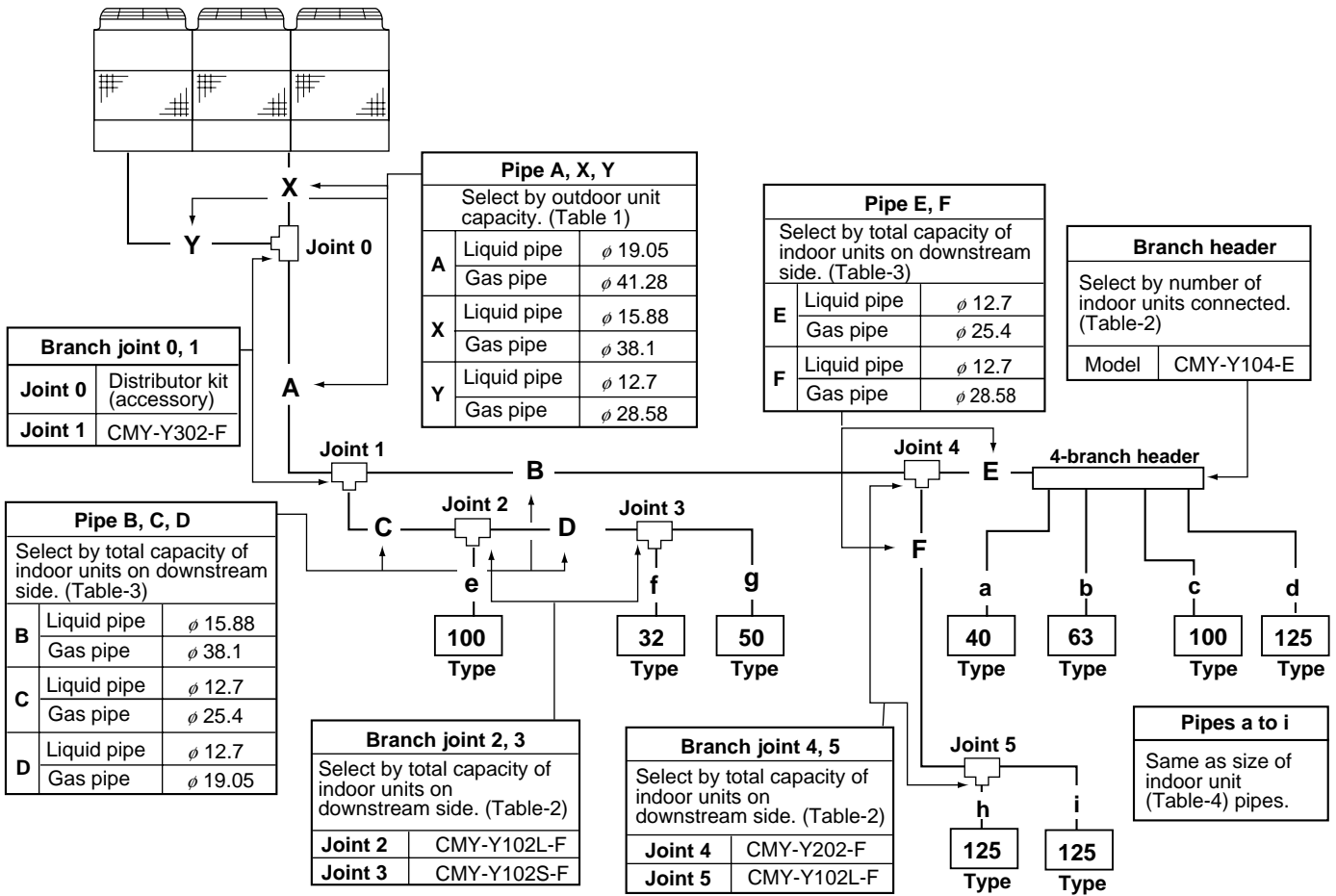

(1) Selection of branch pipe kit

Branch area	Branch pipe kit selection method	Branch pipe kit model
Joint 0	-	Distributor kit (accessory)
Joint 1	-	CMY-Y302-F
Joint 2	$32 + 50 + 100 = 182$ (161 ~ 330)	CMY-Y102L-F
Joint 3	$32 + 50 = 82$ (160 or below)	CMY-Y102S-F
Joint 4	$40 + 63 + 100 + 125 \times 3 = 578$ (331 ~ 630)	CMY-Y202-F
Joint 5	$125 \times 2 = 250$ (161 ~ 330)	CMY-Y102L-F
Header	For 4 branches with 8 HP outdoor unit	CMY-Y104-F

(2) Selection of pipe size

Pipe area	Refrigerant pipe selection method	Liquid pipe size	Gas pipe size
X	Same as size of outdoor unit's refrigerant pipe	φ15.88	φ38.1
Y	Same as size of outdoor unit's refrigerant pipe	φ12.7	φ28.58
A	Same as size of outdoor unit's refrigerant pipe	φ19.05	φ41.28
B	$40 + 63 + 100 + 125 \times 3 = 578$ (331 ~ 630)	φ15.88	φ38.1
C	$32 + 50 + 100 = 182$ (161 ~ 330)	φ12.7	φ25.4
D	$32 + 50 = 82$ (81 ~ 160)	"	φ19.05
E	$40 + 63 + 100 + 125 = 328$ (161 ~ 330)	"	φ34.93
F	$125 \times 2 = 250$ (161 ~ 330)	"	φ28.58
a	Same as size of outdoor unit's refrigerant pipe	φ6.35	φ12.7
b	"	φ9.52	φ15.88
c	"	"	φ19.05
d, h, i	"	"	"
e	"	"	"
f	"	φ6.35	φ12.7
g	"	φ9.52	φ15.88

④ Example 4

Outdoor unit : PURY-P250

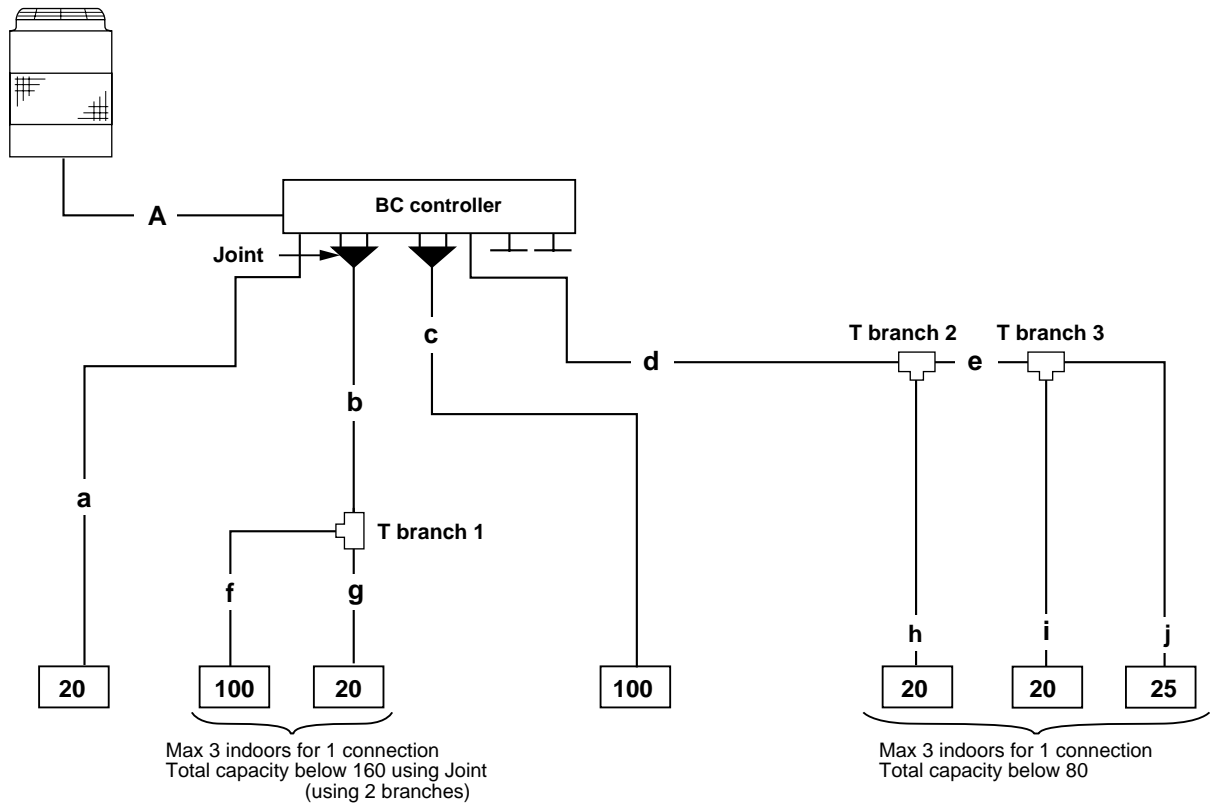

(1) Selection of branch pipe kit

Branch area	Branch pipe kit selection method	Branch pipe kit model
Joint	—	CMY-R160-H
T branch 1	Capacity Index = 100 + 20 = 120	CMY-Y102L-F
T branch 2	Capacity Index = 20 + 20 + 25 = 65	CMY-Y102S-F
T branch 3	Capacity Index = 20 + 25 = 45	CMY-Y102S-F

(2) Selection of pipe size

Pipe area	Refrigerant pipe selection method	High pressure	Low pressure
A	Outdoor unit pipe	ø19.05	ø28.58
a	Capacity Index = 20	ø6.35	ø12.7
b	Capacity Index = 120 (100+20)	ø12.7	ø19.05
c	Capacity Index = 100	ø9.52	ø19.05
d	Capacity Index = 65 (20+20+25)	ø9.52	ø15.88
e	Capacity Index = 45 (20+25)	ø9.52	ø15.88
f	Capacity Index = 100	ø9.52	ø19.05
g	Capacity Index = 20	ø6.35	ø12.7
h	Capacity Index = 20	ø6.35	ø12.7
i	Capacity Index = 20	ø6.35	ø12.7
j	Capacity Index = 25	ø6.35	ø12.7

⑤ Example 5

Outdoor unit : PURY-P500

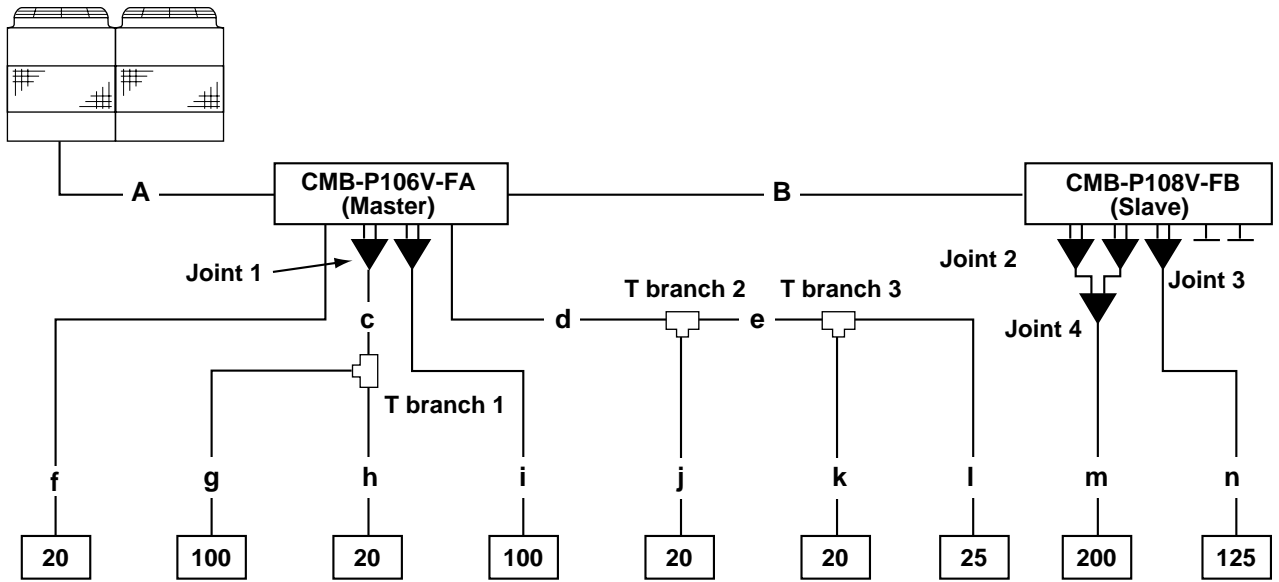

Max 3 indoors for 1 connection.
Total capacity below 160 using Joint.
(using 2 branches)

Max 3 indoors for 1 connection.
Total capacity below 80 for 1 branch.

(1) Selection of branch pipe kit

Branch area	Branch pipe kit selection method	Branch pipe kit model
Joint 1,2,3	-	CMY-R160-H
Joint 4	-	CMY-R160-HA
T branch 1	Capacity Index = 100 + 20 = 120	CMY-Y102L-F
T branch 2	Capacity Index = 20 + 20 + 25 = 65	CMY-Y102S-F
T branch 3	Capacity Index = 20 + 25 = 45	CMY-Y102S-F

(2) Selection of pipe size

Pipe area	Refrigerant pipe selection method	High pressure	Low pressure
A	Outdoor unit pipe	φ25.4	φ34.93

Pipe area	Refrigerant pipe selection method	Low pressure gas	High pressure gas	Liquid
B	BC-BC pipe	φ28.58	φ19.05	φ12.7

Pipe area	Refrigerant pipe selection method	Liquid pipe size	Gas pipe size
c	Capacity Index = 120 (100 + 20)	φ12.7	φ19.05
d	Capacity Index = 65 (20 + 20 + 25)	φ9.52	φ15.88
e	Capacity Index = 45 (20 + 25)	φ9.52	φ15.88
f	Capacity Index = 20	φ6.35	φ12.7
g	Capacity Index = 100	φ9.52	φ19.05
h	Capacity Index = 20	φ6.35	φ12.7
i	Capacity Index = 100	φ9.52	φ19.05
j	Capacity Index = 20	φ6.35	φ12.7
k	Capacity Index = 20	φ6.35	φ12.7
l	Capacity Index = 25	φ6.35	φ12.7
m	Capacity Index = 200	φ12.7	φ25.4
n	Capacity Index = 125	φ9.52	φ15.88

2-5 Calculation of additional refrigerant charge

① PUMY-(P)125YM(A)

(1) Refrigerant charge

The following amount of refrigerant is being charged into the outdoor unit at factory shipment. Refrigerant of 3kg equivalent to 50-m total extended piping length is already included when the outdoor unit is shipped. Thus, if the total extended piping length is 50m or less, there is no need to change with additional refrigerant.

If the total extended piping length exceeds 50m, calculate the required additional refrigerant charge using the procedure shown on the below.

If the calculated additional refrigerant charge is a negative amount, do not charge with any refrigerant.

Outdoor unit	PUMY-(P)125YM(A)
Refrigerant charge	8.5kg

(2) Formula to obtain an amount of additional refrigerant charge

The additional amount of refrigerant to be added is calculated from the size of the extended liquid pipes and their length (in meters).

$$\text{Additional amount (kg)} = (0.06 \times L_1) + (0.024 \times L_2) - 3\text{kg}$$

Where L₁ : Length of ϕ 9.52 liquid pipe (m)

L₂ : Length of ϕ 6.35 liquid pipe (m)

*1 : Any fractions below 0.01kg in the result of the calculation should be round up.

(Examples : 10.52 → 10.6kg)

Example: PUMY-125YM

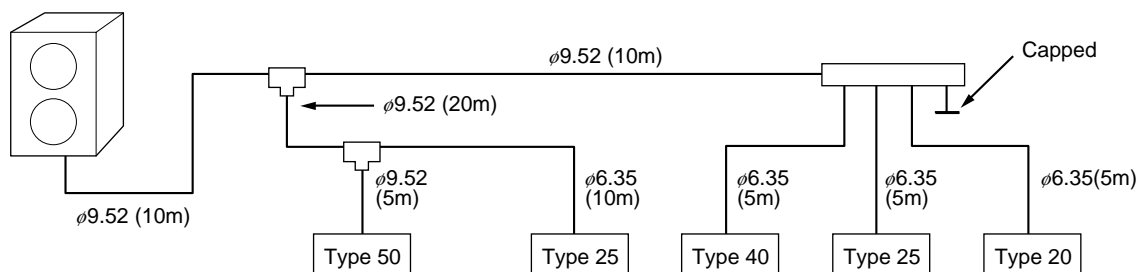

This calculation concerns only the liquid pipes.

$$\phi 9.52 : 10\text{m} + 20\text{m} + 10\text{m} + 5\text{m} = 45\text{m}$$

$$\phi 6.35 : 10\text{m} + 5\text{m} + 5\text{m} + 5\text{m} = 25\text{m}$$

Calculation of additional amount :

$$\text{Additional amount (kg)} = (0.06 \times 45) + (0.024 \times 25) - 3.0 = 0.3 \text{ kg (rounded up)}$$

② PU(HY-(P)200-250-315, PQHY-P200-250

(1) Refrigerant charge

The following amount of refrigerant is being charged into the outdoor unit at factory shipment. As the amount does not include that for extended piping, charge it additionally in the field.

Outdoor unit	PUHY-P200 PUY-P200	PUHY-P250 PUY-P250	PUHY-P315 PUY-P315	PUHY-200 PUY-200	PUHY-250 PUY-250	PUHY-315 PUY-315	PQHY-P200	PQHY-P250
Refrigerant charge	7.0kg	7.0kg	9.0kg	7.0kg	7.0kg	9.0kg	7.0kg	8.0kg

(2) Formula to obtain an amount of additional refrigerant charge

The additional amount of refrigerant to be added is calculated from the size of the extended liquid pipes and their length (in meters).

$$\text{Additional amount (kg)} = (0.25 \times L_1) + (0.12 \times L_2) + (0.06 \times L_3) + (0.024 \times L_4) + A$$

Where L₁ : Length of ϕ 15.88 liquid pipe (m)
 L₂ : Length of ϕ 12.7 liquid pipe (m)
 L₃ : Length of ϕ 9.52 liquid pipe (m)
 L₄ : Length of ϕ 6.35 liquid pipe (m)
 A: Additional refrigerant charge by total capacity of indoor units connected.

Total capacity of indoor units connected	Additional refrigerant charge (A)
~ 160	1.5
161 ~ 330	2.0
331 ~ 480	2.5
481 ~ 630	3.0
631 ~	4.0

*1 : Any fractions below 0.01kg in the result of the calculation should be round up.
 (Examples : 10.52 → 10.6kg)

Example: PUHY-200

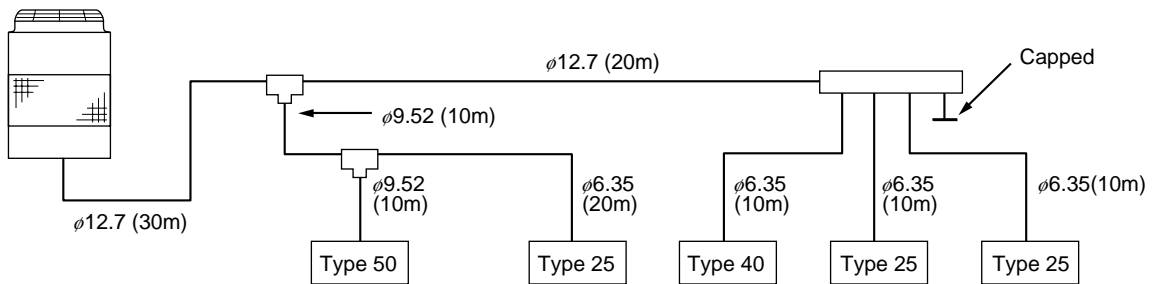

This calculation concerns only the liquid pipes.

$$\begin{aligned} \phi 12.7 & : 30\text{m} + 20\text{m} = 50\text{m} \\ \phi 9.52 & : 10\text{m} + 10\text{m} = 20\text{m} \\ \phi 6.35 & : 20\text{m} + 10\text{m} + 10\text{m} + 10\text{m} = 50\text{m} \end{aligned}$$

Total capacity of indoor units connected:
 $40 + 25 + 40 + 25 + 25 = 155$

Calculation of additional amount :

$$\text{Additional amount (kg)} = (0.12 \times 50) + (0.06 \times 20) + (0.024 \times 50) + 1.5 = 9.90 \text{ kg}$$

The result of 9.90 kg is rounded up to one decimal place (0.1kg). Therefore,

$$\text{Additional amount} = 9.9 \text{ kg}$$

③ PURY, PQRY

(1) Refrigerant charge

The following amount of refrigerant is being charged into the outdoor unit at factory shipment. As the amount does not include that for extended piping, charge it additionally in the field.

Outdoor unit	PURY-P200	PURY-P250	PURY-200	PURY-250	PQRY-P200	PQRY-P250	PURY-P400	PURY-P500
Refrigerant charge	10.5kg	10.5kg	10.0kg	11.0kg	7.5kg	8.5kg	20.0kg	22.0kg

(2) Formula to obtain an amount of additional refrigerant charge

The calculation of additional refrigerant charge is based on the size and length of extended high pressure side piping.

$$\text{Additional amount (kg)} = (0.31 \times L_0) + (0.25 \times L_0') + (0.16 \times L_1) + (0.12 \times L_2) + (0.06 \times L_3) + (0.024 \times L_4) + A + B$$

Where L_0 : Length of high pressure pipe $\phi 25.4$ (m)
 $*L_0'$: Length of high pressure pipe $\phi 22.22$ (m)
 L_1 : Length of high pressure pipe $\phi 19.05$ (m)
 L_2 : Length of liquid pipe $\phi 12.7$ (m)
 L_3 : Length of liquid pipe $\phi 9.52$ (m)
 L_4 : Length of liquid pipe $\phi 6.35$ (m)

A: Additional refrigerant charge by total capacity of indoor units connected.
 B: Additional refrigerant charge for BC controller. (Slave)

Total capacity of indoor units connected		Additional refrigerant charge
PURY-200 PURY-P200 PQRY-P200	PURY-250 PURY-P250 PQRY-P250	A
100 ~ 160	125 ~ 160	1.5
161 ~ 300	161 ~ 375	2.0

Total capacity of indoor units connected	Additional refrigerant charge	
PURY-P400, P500	A	B
~ 330	2.0	3.0
331 ~ 480	2.5	
481 ~ 630	3.0	
631 ~	4.0	

Note: Raise a fraction of the calculation result less than 0.01kg to a unit. (Examples : 10.52 → 10.6kg)
 * $\phi 22.22$ pipe can be used in place of $\phi 25.4$ pipe.

Example: PURY-200

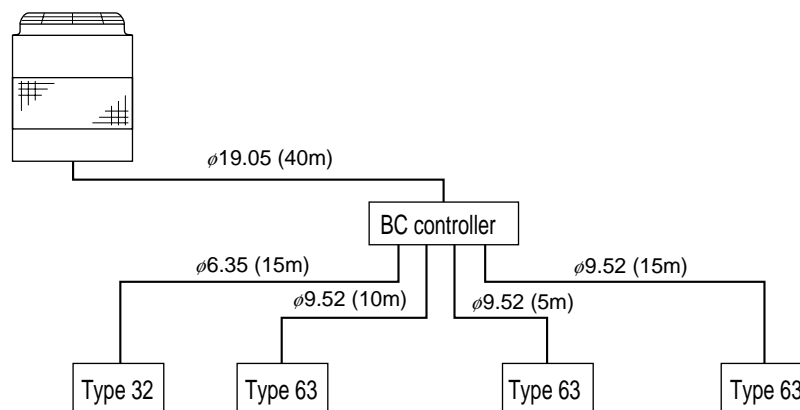

This calculation concerns only the liquid (high press) pipes.

$\phi 19.05$: 40m
 $\phi 9.52$: 10m + 15m = 25m
 $\phi 6.35$: 15m

Total capacity of indoor units connected:
 $32 + 63 + 63 + 63 = 221$

Calculation of additional amount :

$$\text{Additional amount (kg)} = (0.16 \times 40) + (0.06 \times 30) + (0.024 \times 15) + 2 = 10.56 \text{ kg}$$

The result of 10.56 kg is rounded up to one decimal place (0.1kg). Therefore,
 Additional amount = 10.6 kg

④ PUHY-(P)400-500

The amounts of refrigerant given in the table below are added in the outdoor units at the factory prior to shipment. However, they do not cover the requirements for piping extensions, and additional refrigerant must be added at the installation site.

Outdoor unit model	PUHY-(P)400	PUHY-(P)500
Amount of refrigerant being added at the factory prior to shipment	16kg	21kg

(1) Formula for calculation

The additional amount of refrigerant to be added is calculated from the size of the extended liquid pipes and their length (in meters).

$$\text{Additional amount (kg)} = (0.29 \times L1) + (0.25 \times L2) + (0.12 \times L3) + (0.06 \times L4) + (0.024 \times L5) + A$$

- Where
- L1 : Length of $\phi 19.05$ liquid pipe (m)
 - L2 : Length of $\phi 15.88$ liquid pipe (m)
 - L3 : Length of $\phi 12.7$ liquid pipe (m)
 - L4 : Length of $\phi 9.52$ liquid pipe (m)
 - L5 : Length of $\phi 6.35$ liquid pipe (m)
- A: Additional refrigerant charge by total capacity of indoor units connected.

Total capacity of indoor units connected	Additional refrigerant charge (A)
~ 160	1.5
161 ~ 330	2.0
331 ~ 480	2.5
481 ~ 630	3.0
631 ~	4.0

※1 : Any fractions below 0.01kg in the result of the calculation should be round up.
(Examples : 10.52 → 10.6kg)

(2) Example: PUHY-P500

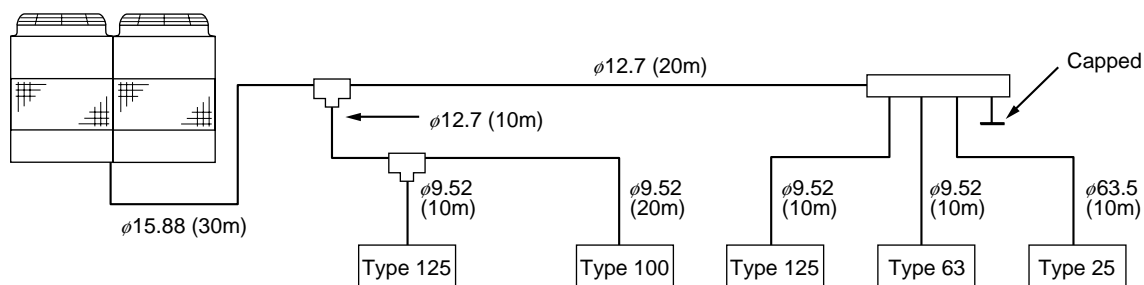

This calculation concerns only the liquid pipes.

- $\phi 15.88$: 30m
- $\phi 12.7$: 10m + 20m = 30m
- $\phi 9.52$: 10m + 20m + 10m + 10m = 50m
- $\phi 6.35$: 10m

Total capacity of indoor units connected:
125 + 100 + 125 + 63 + 25 = 438

Using the above formula:

$$\text{Additional amount (kg)} = (0.25 \times 30) + (0.12 \times 30) + (0.06 \times 50) + (0.024 \times 10) + 2.5 = 16.84 \text{ kg}$$

The result of 9.90 kg is rounded up to one decimal place (0.1kg). Therefore,

Additional amount = 1.69 kg

⑤ **PUHY-(P)600-650-700-750**

The amounts of refrigerant given in the table below are added in the outdoor units at the factory prior to shipment. However, they do not cover the requirements for piping extensions, and additional refrigerant must be added at the installation site.

Outdoor unit model	PUHN-(P)200	PUHN-(P)250	PUHY-(P)400	PUHY-(P)500
Amount of refrigerant being added at the factory prior to shipment	6.5kg	8.5kg	16kg	21kg

(1) Formula for calculation

The additional amount of refrigerant to be added is calculated from the size of the extended liquid pipes and their length (in meters).

$$\text{Additional amount (kg)} = (0.29 \times L_1) + (0.25 \times L_2) + (0.12 \times L_3) + (0.06 \times L_4) + (0.024 \times L_5) + A$$

- Where
- L₁ : Length of φ19.05 liquid pipe (m)
 - L₂ : Length of φ15.88 liquid pipe (m)
 - L₃ : Length of φ12.7 liquid pipe (m)
 - L₄ : Length of φ9.52 liquid pipe (m)
 - L₅ : Length of φ6.35 liquid pipe (m)

A: Additional refrigerant charge by total capacity of indoor units connected.

Total capacity of indoor units connected	Additional refrigerant charge (A)
~ 160	1.5
161 ~ 330	2.0
331 ~ 480	2.5
481 ~ 630	3.0
631 ~	4.0

*1 : Any fractions below 0.01kg in the result of the calculation should be round up.

(Examples : 10.52 → 10.6kg)

*2 : PUHY-(P)600-650-700-750

$$\text{Additional amount (kg)} \leq 73\text{kg} - (\text{Amount of refrigerant being added at the factory prior to shipment})$$

ex. PUHY-750YSMC

$$\begin{aligned} \text{Additional amount (kg)} &\leq 73\text{kg} - (22 + 8.5) \\ &\leq 42.5\text{kg} \end{aligned}$$

(2) Example: PUHY-750

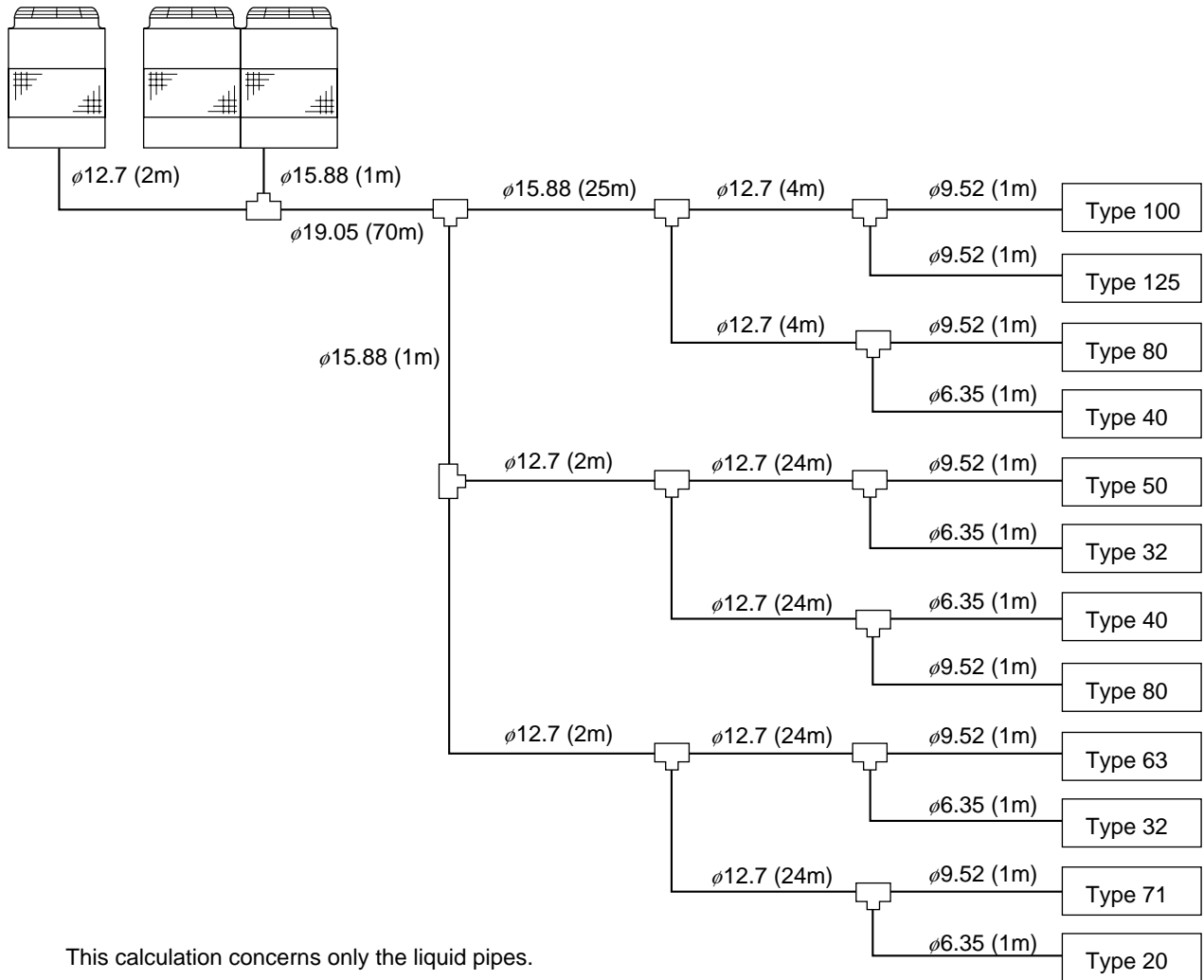

This calculation concerns only the liquid pipes.

- $\phi 19.05 : 70 + 1 = 71\text{m}$
- $\phi 15.88 : 1 + 25 = 26\text{m}$
- $\phi 12.7 : 2 + 4 + 4 + 2 + 24 + 24 + 2 + 24 + 24 = 110\text{m}$
- $\phi 9.52 : 1 + 1 + 1 + 1 + 1 + 1 + 1 = 7\text{m}$
- $\phi 6.35 : 1 + 1 + 1 + 1 + 1 = 5\text{m}$

Total capacity of indoor units connected:

$$125 + 100 + 80 \times 2 + 71 + 63 + 50 + 40 \times 2 + 32 \times 2 + 20 = 733$$

Using the above formula:

$$\text{Additional amount (kg)} = (0.29 \times 71) + (0.25 \times 26) + (0.12 \times 110) + (0.06 \times 7) + (0.024 \times 5) + 4 = 44.83\text{kg}$$

Additional amount $\leq 73\text{kg}$ - (Amount of refrigerant to be added). Therefore,

$$\text{Additional amount (kg)} = 73\text{kg} - (22 + 8.5) = 42.5\text{kg}$$

2-6 Electric characteristics

(1) Indoor unit

Symbols: MCA : Max. Circuit Amps (=1.25×FLA)
IFM : Indoor Fan Motor

FLA : Full Load Amps
Output : Fan motor rated output

Model	Units		Power supply	IFM								
	Volts / Hz	Voltage range		MCA(A)	Output(kW)	FLA(A)						
PMFY-P-VBM-A	20	220-240V / 50Hz 220V / 60Hz	Max.: 264V Min.: 198V	0.25	0.028	0.20						
	25-32			0.26	0.028	0.21						
	40			0.33	0.028	0.26						
PLFY-P-VKM-A	32-40			220-240V / 50Hz 220V / 60Hz	Max.: 264V Min.: 198V	0.75	0.030	0.60				
	50					0.80	0.030	0.64				
	63					0.85	0.030	0.68				
PLFY-P-VAM-A	80					220-240V / 50Hz	Max.: 264V Min.: 198V	1.08	0.070	0.86		
	100							1.79	0.120	1.43		
	125							2.05	0.120	1.64		
PLFY-P-VLMD-B	20-25							220-240V / 50Hz	Max.: 264V Min.: 198V	0.54	0.033	0.43
	32									0.60	0.033	0.48
	40									0.96	0.075	0.77
	50	0.96	0.075							0.77		
PLFY-P-VLMD-A	63	220-240V / 50Hz	Max.: 264V Min.: 198V							1.31	0.078	1.05
	80									1.38	0.078	1.10
	100			1.50	0.078 × 2					1.20		
	125			1.69	0.078 × 2					1.35		
PLFY-NLMD	20-25			220V / 60Hz	Max.: 264V Min.: 198V					0.63	0.033	0.50
	32					0.68	0.033			0.54		
	40					1.10	0.075			0.88		
	50					1.10	0.075			0.88		
	63					1.25	0.078	1.00				
	80					1.35	0.078	1.08				
	100					2.29	0.078 × 2	1.83				
	125					2.35	0.078 × 2	1.85				
PEFY-P-VML-A	20-25	220-240V / 50Hz 220-240V / 60Hz	Max.: 456V Min.: 342V	0.30/0.35	0.023	0.24/0.28						
	32			0.40/0.53	0.032	0.32/0.42						
PEFY-P-VMH-A	40-50			220-240V / 50Hz 220-240V / 60Hz	Max.: 456V Min.: 342V	1.21/1.61	0.08	0.97/1.29				
	63					1.49/1.95	0.12	1.19/1.56				
	71					1.58/2.18	0.14	1.26/1.74				
	80					1.85/2.40	0.18	1.48/1.92				
	100-125					3.03/3.93	0.26	2.42/3.14				
	140					3.10/3.98	0.26	2.48/3.18				
	200					2.03/2.33	0.54	1.62/1.86				
250	2.50/2.88					0.87	2.00/2.30					
PEFY-P-VMM-A	20-25					220-240V / 50Hz	Max.: 264V Min.: 198V	0.91	0.15	0.73		
	32							1.01	0.17	0.81		
	40	1.15	0.19					0.92				
	50	1.23	0.20					0.98				
	63	1.34	0.22	1.07								
	71-80	1.44	0.25	1.15								
	100	1.68	0.29	1.34								
	125	2.38	0.40	1.90								
	140	2.44	0.42	1.95								

Model		Units		Power supply	IFM			
		Volts / Hz	Voltage range	MCA(A)	Output(kW)	FLA(A)		
PDFY-P-VM-A	20-25-32	220-240V / 50Hz 220V / 60Hz	Max.: 264V Min.: 198V	0.66/0.73	0.075	0.53/0.58		
	40-50			0.75/0.89	0.075	0.60/0.71		
	63			0.85/1.03	0.078	0.68/0.82		
	71			0.90/1.10	0.078	0.72/0.88		
	80			1.03/1.26	0.078	0.82/1.01		
	100			1.60-1.68/1.70	0.140	1.28-1.34/1.36		
	125			1.94-2.04/2.30	0.190	1.55-1.63/1.84		
	PKFY-P-VAM-A			20-25	220-240V / 50Hz 220V / 60Hz	Max.: 264V Min.: 198V	0.25	0.017
PKFY-P-VGM-A	32-40-50	0.40	0.030	0.32				
PKFY-P-VFM-A	63	0.54	0.04	0.43				
	100	0.65	0.07	0.52				
PCFY-P-VGM-A	40	0.58	0.054	0.46				
	63	0.75	0.070	0.60				
	100	0.91	0.090	0.73				
	125	1.38	0.150	1.10				
PFFY-P-VLEM-A	20-25	220-240V / 50Hz	Max.: 264V Min.: 198V	0.24 / 0.31	0.020	0.19 / 0.25		
	32			0.36 / 0.38	0.030	0.29 / 0.30		
	40			0.40 / 0.41	0.035	0.32 / 0.33		
	50			0.50 / 0.51	0.035	0.40 / 0.41		
	63			0.58 / 0.59	0.045	0.46 / 0.47		
PFFY-P-VLRM-A	20-25			220-240V / 50Hz	Max.: 264V Min.: 198V	0.24 / 0.31	0.020	0.19 / 0.25
	32					0.36 / 0.38	0.030	0.29 / 0.30
	40					0.40 / 0.41	0.035	0.32 / 0.33
	50					0.50 / 0.51	0.035	0.40 / 0.41
	63					0.58 / 0.59	0.045	0.46 / 0.47
GUF-RD(H)2	50	220-240V / 50Hz	Max.: 264V Min.: 198V			1.85	0.081 X 2	1.48
	100					3.49	0.16 X 2	2.79

(50/60Hz)

(2) Outdoor unit (Cooling)

Refrigerant type : R407C

Symbols: MCA : Max.Circuit Amps
SC : Starting Current

RLA : Rated Load Amps

Model	Units			Power supply	Compressor		Fan	RLA(A)
	Hz	Volts	Voltage range	MCA(A)	Output(kW)	SC(A)	Output(kW)	
PUMY-P125VMA	50	220	Max.: 253V Min.: 188V	35.38	3.5	22	0.06 X 2	28.3
		230						27.1
		240						26.0
PUMY-P125YM(A)	50	380	Max.: 456V Min.: 342V	12.0	3.5	8	0.06 X 2	9.6
		400						9.1
		415						8.8
PUHY-P200YEM-A PUY-P200YEM-A	50	380	Max.: 456V Min.: 342V	16.01	5.3	8	0.38	10.6
		400						10.1
		415						9.7
PUHY-P250YEM-A PUY-P250YEM-A	50	380	Max.: 456V Min.: 342V	17.75	6.8	8	0.38	14.4
		400						13.6
		415						13.2
PUHY-P315YEM-A PUY-P315YEM-A	50	380	Max.: 456V Min.: 342V	25.38	8.6	8	0.38	20.3
		400						19.2
		415						18.5
PUHY-P400YEM-A	50	380	Max.: 456V Min.: 342V	33.38	4.5+7.5	103(50Hz) 96(60Hz)	0.38 X 2	26.7
		400						25.4
		415						24.5
PUHY-P500YEM-A	50	380	Max.: 456V Min.: 342V	41.88	7.5+7.5	138(50Hz) 125(60Hz)	0.38 X 2	33.5
		400						31.9
		415						30.7
PUHY-P600YSEM-A	50	380	Max.: 456V Min.: 342V	50.38	4.5+7.5+5.5	145(50Hz) 132(60Hz)	0.38 X 3	40.3
		400						38.3
		415						36.9
PUHY-P650YSEM-A	50	380	Max.: 456V Min.: 342V	54.25	4.5+7.5+7.5	150(50Hz) 137(60Hz)	0.38 X 3	43.4
		400						41.2
		415						39.7
PUHY-P700YSEM-A	50	380	Max.: 456V Min.: 342V	58.50	7.5+7.5+5.5	145(50Hz) 132(60Hz)	0.38 X 3	46.8
		400						44.5
		415						42.9
PUHY-P750YSEM-A	50	380	Max.: 456V Min.: 342V	62.38	7.5+7.5+7.5	150(50Hz) 137(60Hz)	0.38 X 3	49.9
		400						47.4
		415						45.7
PURY-P200YEM-A	60	380	Max.: 456V Min.: 342V	16.01	5.3	8	0.38	10.4
		400						9.9
		415						9.5
PURY-P250YEM-A	60	380	Max.: 456V Min.: 342V	17.75	6.8	8	0.38	14.1
		400						13.3
		415						12.9
PURY-P400YEM-A	60	380	Max.: 456V Min.: 342V	33.38	7.5+4.5	103(50Hz) 96(60Hz)	0.38 X 2	26.7
		400						25.4
		415						24.5
PURY-P500YEM-A	60	380	Max.: 456V Min.: 342V	41.88	7.5+7.5	138(50Hz) 125(60Hz)	0.38 X 2	33.5
		400						31.9
		415						30.7
PQHY-P200YEM-A	60	380	Max.: 456V Min.: 342V	16.01	5.5	12	--	12.1
		400						11.5
		415						11.1
PQHY-P250YEM-A	60	380	Max.: 456V Min.: 342V	19.00	7.5	12	-	15.2
		400						14.4
		415						13.9

Model	Units			Power supply	Compressor		Fan	RLA(A)
	Hz	Volts	Voltage range	MCA(A)	Output(kW)	SC(A)	Output(kW)	
PQRY-P200YEM-A	50 / 60	380	Max.: 456V Min.: 342V	16.01	5.5	12	-	12.1
		400						11.5
		415						11.1
PQRY-P250YEM-A		380		19.00	7.5	12	-	15.2
		400						14.4
		415						13.9

Symbols: MCA : Max.Circuit Amps

SC : Starting Current

RLA : Rated Load Amps

Refrigerant type : R22

Model	Units			Power supply	Compressor		Fan	RLA(A)
	Hz	Volts	Voltage range	MCA(A)	Output(kW)	SC(A)	Output(kW)	
PUMY-71VM	50	220	Max.: 253V Min.: 188V	23.00	2.6	15	0.04 X 2	17.5
		230						16.7
		240						16.0
	60	220						18.1
PUMY-125VMA	50	220		44.00	3.5	22	0.06 X 2	34.9
		230						33.5
		240						32.2
	60	220						33.6
PUHY-200TEM-A	60	208		16.01	5.3	15	0.38	19.0
PUHY-250TEM-A		220		17.63	6.8	15	0.38	18.0
				24.4				
				23.3				
PUHY-315TEM-A		230	24.88	8.6	15	0.38	36.3	
			34.3					
32.8								
PUMY-125YM PUMY-125YMA	50 / 60	380	12.00	3.5	8	0.06 X 2	9.6	
		400					9.1	
		415					8.8	
PUHY-200YEM-A PUY-200YEM-A		380	16.01	5.3	8	0.38	10.4	
		400					9.9	
		415					9.5	
PUHY-200YEMC-A		380	16.01	6.0	8	0.38	12.0	
		400					11.4	
		415					11.0	
PUHY-250YEM-A PUHY-250YEMC-A PUY-250YEM-A		380	17.75	6.8	8	0.38	14.1	
		400					13.3	
		415					12.9	
PUHY-250YEMK-A	380	24.50	7.9	8	0.38	19.6		
	400					18.6		
	415					18.0		
PUHY-315YEM-A PUHY-315YEMK-A PUHY-315YEMC-A PUY-315YEM-A	380	25.38	8.6	8	0.38	19.9		
	400					18.9		
	415					18.2		
PUHY-400YEM-A PUHY-400YEMK-A PUHY-400YEMC-A	380	33.38	7.5+4.5	103(50Hz) 96(60Hz)	0.38 X 2	26.7		
	400					25.4		
	415					24.5		

Model	Units			Power supply	Compressor		Fan	RLA(A)
	Hz	Volts	Voltage range	MCA(A)	Output(kW)	SC(A)	Output(kW)	
PUHY-500YEM-A PUHY-500YEMK-A PUHY-500YEMC-A	50 / 60	380	Max.: 456V Min.: 342V	40.00	7.5+7.5	138(50Hz) 125(60Hz)	0.38X 2	32.0
		400						30.4
		415						29.3
PUHY-600YSEM-A PUHY-600YSEM-K-A PUHY-600YSEMC-A		380		49.00	7.5+4.5+5.5	145(50Hz) 132(60Hz)	0.35 X 3	39.2
		400						37.2
		415						35.9
PUHY-650YSEM-A PUHY-650YSEM-K-A PUHY-650YSEMC-A		380		52.75	7.5+4.5+7.5	150(50Hz) 137(60Hz)	0.35 X 3	42.2
		400						40.1
		415						38.7
PUHY-700YSEM-A PUHY-700YSEM-K-A PUHY-700YSEMC-A		380		56.63	7.5+7.5+5.5	145(50Hz) 132(60Hz)	0.35 X 3	45.3
		400						43.0
		415						41.5
PUHY-750YSEM-A PUHY-750YSEM-K-A PUHY-750YSEMC-A		380		60.50	7.5+7.5+7.5	150(50Hz) 137(60Hz)	0.35 X 3	48.4
		400						46.0
		415						44.3
PURY-P200YEMC-A	380	20.25	5.5	12	0.38	16.2		
	400					15.4		
	415					14.9		
PURY-P250YEMC-A	380	22.25	7.5	12	0.38	17.8		
	400					16.9		
	415					16.3		

(3) BC controller

Model	Units			Power supply		RLA(A)				
	Hz	Volts	Voltage range	MCA(A)	MFA(A)					
CMB-P104V-F	50 / 60	220	Max.: 264V Min.: 198V	0.39	15	0.31				
		230				0.30				
		240				0.28				
CMB-P105V-F		220		Max.: 264V Min.: 198V	0.48	15	0.38			
		230					0.36			
		240					0.35			
CMB-P106V-F		220			Max.: 264V Min.: 198V	0.57	15	0.45		
		230						0.43		
		240						0.41		
CMB-P108V-F		220				Max.: 264V Min.: 198V	0.87	15	0.58	
		230							0.56	
		240							0.53	
CMB-P1010V-F		220					Max.: 264V Min.: 198V	0.90	15	0.72
		230								0.69
		240								0.66
CMB-P1013V-F	220	Max.: 264V Min.: 198V	1.17					15	0.92	
	230								0.88	
	240								0.85	
CMB-P1016V-F	220		Max.: 264V Min.: 198V	1.42				15	1.13	
	230								1.08	
	240								1.03	
CMB-P108V-FA	220			Max.: 264V Min.: 198V	0.79			15	0.63	
	230								0.60	
	240								0.58	
CMB-P1010V-FA	220				Max.: 264V Min.: 198V	0.95		15	0.76	
	230								0.73	
	240								0.70	
CMB-P1013V-FA	220					Max.: 264V Min.: 198V	1.22	15	0.97	
	230								0.93	
	240								0.89	
CMB-P1016V-FA	220	Max.: 264V Min.: 198V					1.47	15	1.17	
	230								1.12	
	240								1.08	
CMB-P108V-FB	220		Max.: 264V Min.: 198V				0.73	15	0.58	
	230								0.56	
	240								0.53	

Symbols

MCA : Max. Circuit Amps (=1.25 × max. RLA)

MFA : Max. Fuse Amps

RLA : Rated Load Amps

2-7 Installation

2-7-1 Selection of installation site

① PUMY, PUHY, PUY

Select space for installing outdoor unit, which will meet the following conditions:

- no direct thermal radiation from other heat sources
- no possibility of annoying neighbors by noise from unit
- no exposition to strong wind
- with strength which bears weight of unit
- note that drain flows out of unit when heating
- with space for air passage and service work shown 2-7-2 Space required around unit
Because of the possibility of fire, do not install unit to the space where generation, inflow, stagnation, and leak of combustible gas is expected.
- Avoid unit installation in a place where acidic solution and spray (sulfur) are often used.
- When having cooling operation at an outside air temperature of below 10°C, in order to obtain steady operation of unit, select an installation site not exposed directly to rain and snow, or install air outlet and inlet ducts. Install the outdoor unit at the same position on the same floor, or above, the indoor unit.
- Do not use unit in any special environment where oil, steam and sulfuric gas exist.

Installation restriction on outdoor unit when cooling operation is performed when the outdoor air temperature is 10°C or lower.

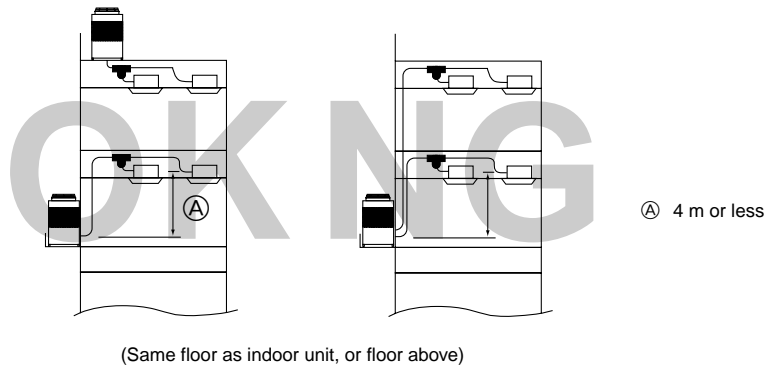

② PURY

Select space for installing heat source unit, which will meet the following conditions:

- no direct thermal radiation from other heat sources
- no possibility of annoying neighbors by noise from unit
- with strength which bears weight of unit
- note that drain flows out of unit when heating
- with space and service work shown 2-7-2 Space required around unit
Because of the possibility of fire, do not install unit to the space where generation, inflow, stagnation, and leak of combustible gas is expected.
- Avoid unit installation in a place where acidic solution and spray (sulfur) are often used.
- Do not use unit in any special environment where oil, steam and sulfuric gas exist.

③ PQHY, PQRV

Select space for installing heat source unit, which will meet the following conditions:

- no direct thermal radiation from other heat sources
- no possibility of annoying neighbors by noise from unit
- with strength which bears weight of unit
- note that drain flows out of unit when heating
- with space and service work shown 2-7-2 Space required around unit
Because of the possibility of fire, do not install unit to the space where generation, inflow, stagnation, and leak of combustible gas is expected.
- Avoid unit installation in a place where acidic solution and spray (sulfur) are often used.
- Do not use unit in any special environment where oil, steam and sulfuric gas exist.
- No exposure to rain or other moisture. (the heat source unit should only be used indoors)
- The declining gradient of the exhaust pipe should be higher than 1/100.

④ BC controller

- Place not exposed to rain. (BC controller is a special machine for indoor use.)
- Place with large enough service space.
- Place in which refrigerant pipes can be provided within the limitations.
- Place not exposed to direct radiant heat from other heat sources.
- Do not install the unit in any oily steamy place or near any machine that generates high frequencies. Doing so may cause a risk of fire, erroneous operation or dew drop.
- Place with less noise effect generated from other units.
- Place in which water piping, refrigerant piping and electrical wiring can be done easily.
- Avoid places exposed to the generation, inflow, accumulation or leakage of flammable and sulfuric gases.
- Place in which a downward pitch of more than 1/100 can be taken for drain piping.

1. For hanging from the ceiling

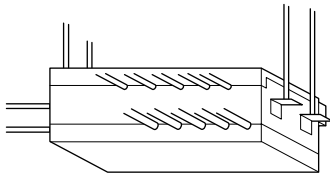

- Provide a inspection hole 450 mm square to the ceiling surface as shown in 2-7-2 Space required around unit.
- Above the ceiling of corridor, bath room, ., where persons are not regularly there
(Avoid installing at around center of the room.)
- Place with strength to the degree that hanging bolts can be mounted (that sustains a pull-out load of 60kg per bolt)
- Be sure to install BC controllers at level.

2. For stacking on a rack

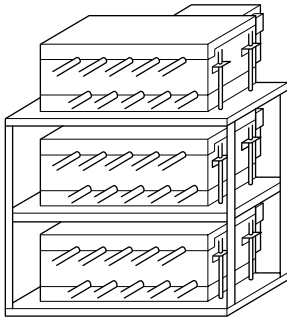

- Place in which sufficient space can be obtained around a rack
- Place with floor strength that sustains the entire weight

⚠ Warning:
Be sure to install the unit in a place that well sustains the entire weight.
If there is a lack of strength, it may cause the unit to fall down, resulting in an injury.

⚠ Caution:
Be sure to install the unit at level.

2-7-2 Space required around unit

① PUMY

Service space around the outdoor unit

- If an optional air guide is needed, install it according to the manual or technical documents supplied with the air guide.
- In the case of an optional branch pipe kit, the service space specified in the manual supplied with the kit is required around the outdoor unit, so refer to the manual when installing it.

(1) When installing a single outdoor unit

① Service space

Maintain an easily accessible service space in front of the unit as shown in the diagram.

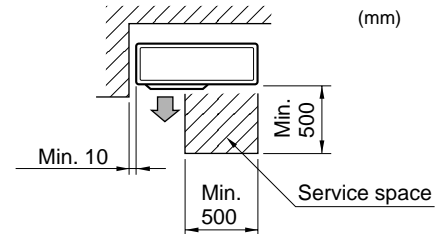

② Top obstacles

If there are no obstacles in front or at the left or right of the unit, obstacles above the unit are permitted as shown in the diagram.

- The front, right and left sides must be free of obstacles.

③ Unobstructed front (blowing side)

If the size of the space reserved for the unit is as shown in the diagram, the unit can be installed so that obstacles are at the right, left and rear.

- The front and top must be unobstructed.
- The height of obstacles on either side must be the same or lower than that of the outdoor unit.

④ Obstacles in the front (blowing side) only

If there are obstacles in front of the unit, keep the back, left/right, & top unobstructed.

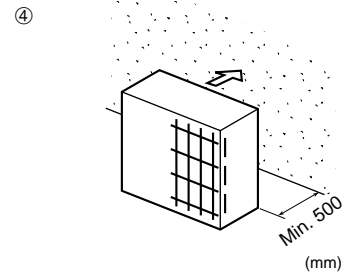
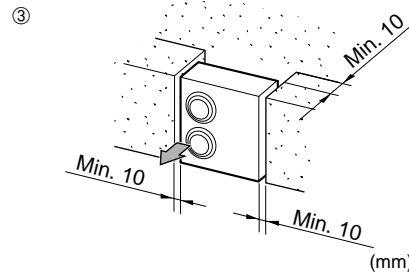
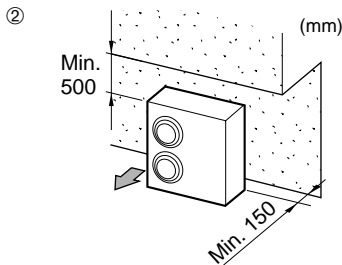

⑤ Obstacles at the front & rear only

The outdoor unit cannot be used except if the following conditions are met: An optional outdoor air outlet guide (left/right & top unobstructed) must be fitted.

Moreover, if there is no natural wind flowing between the obstacles, keep the height or width of the obstacles within the following range to prevent the risk of short cycling. (If either the front or rear satisfies the requirements, there is no special restriction on the remaining side).

Obstruction width: 1.5 times the width of outdoor unit or smaller

Obstruction height: Unit height or lower

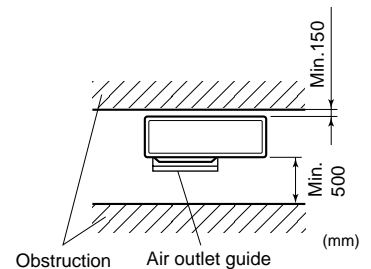

⑥ Obstacles on 4 surrounding sides

The unit cannot be used if there are obstacles on all 4 surrounding sides, even if there is more than the prescribed amount of space around the outdoor unit and if the top is unobstructed.

⑦ Obstacles at the front & rear

This unit cannot be used if the following conditions are met:

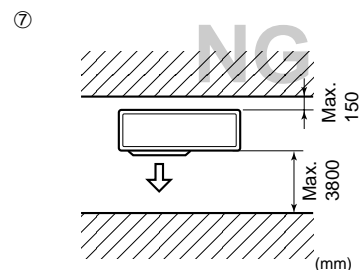
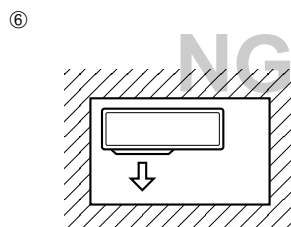

(2) When installing many outdoor units

① Side-by-side arrangement

Remove the side screw on the pipe cover.
Keep the top unobstructed.

- Refrigerant piping and electric wiring cannot be attached on the right side.

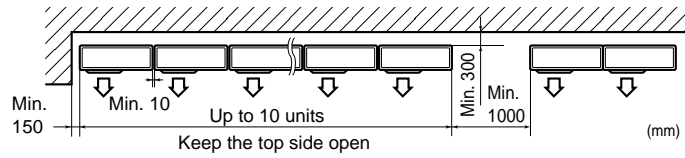

② Face-to-face arrangement (with air outlet guide)

Fit an optional outdoor air outlet guide on each unit and set them to "upward blow".

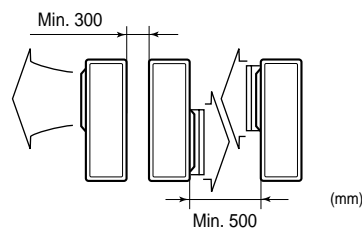

③ Face-to-face arrangement (without air outlet guides)

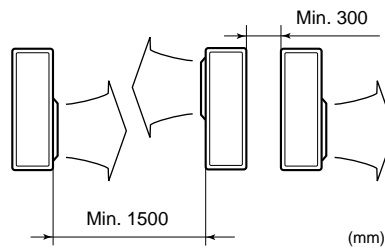

④ Parallel arrangement (with air outlet guides)

Fit an optional outdoor air outlet guide on each unit.

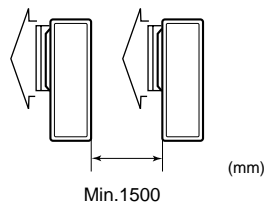

⑤ Parallel arrangement (without air outlet guides)

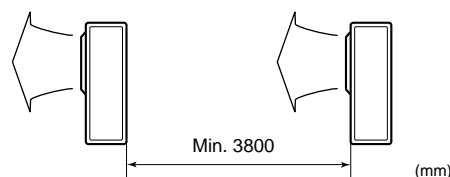

② PUHY, PUY
(1) Individual installation

Basic space required

A space of at least 250(450) mm is necessary at the back for inlet air. Taking servicing, etc. from the rear into account, a space of about 450 mm should be provided, the same as at the front.

< Model : 200-250-315 >

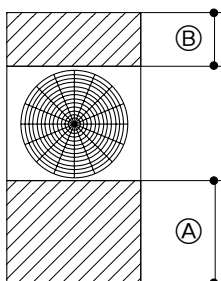

<Top view>

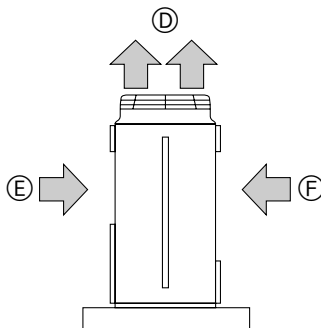

<Side view>

	L1	L2
R407C units	450mm	450mm
R22 units	450mm	100mm

- Ⓐ L₁ mm or more
- Ⓑ L₂ mm or more
- Ⓒ Front (outside of machine room)
- Ⓓ Top discharge (open in principle)
- Ⓔ Front inlet (open in principle)
- Ⓕ Rear inlet (open in principle)

< Model : 400-500 >

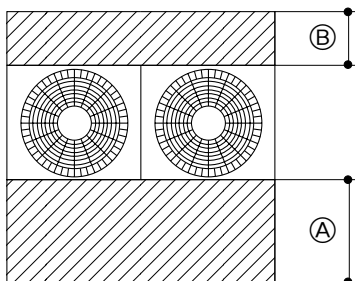

<Top view>

< Model : 600-650-700-750 >

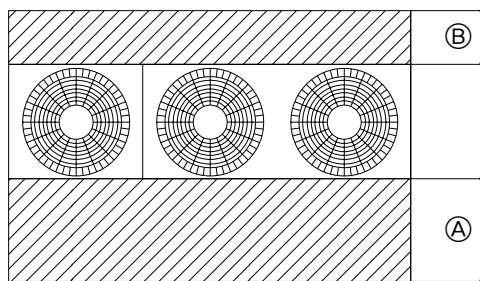

<Top view>

When inlet air enters from right and left sides of unit

< Model : 200-250-315 >

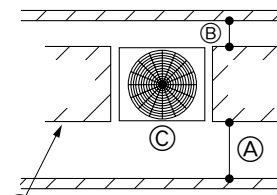

<Top view>

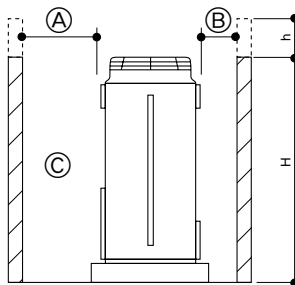

<Side view>

- Ⓐ L₁ or more
- Ⓑ L₂ or more
- Ⓒ Front
- Ⓓ No restrictions on wall height (left and right)

	L1	L2
R407C units	450mm	450mm
R22 units	450mm	100mm

< Model : 400-500 >

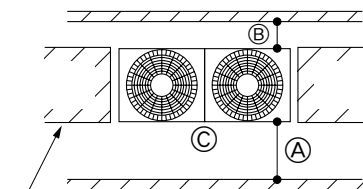

<Top view>

< Model : 600-650-700-750 >

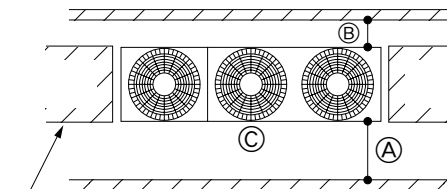

<Top view>

Note:

- Wall heights (H) of the front and the back sides shall be within overall height of unit.
- When the total height is exceeded, add the "h" dimension of the figure above to L₁ and L₂ in the table above.

When unit is surrounded by walls

< Model : 200-250-315 >

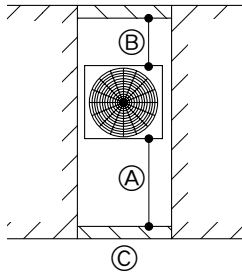

<Top view>

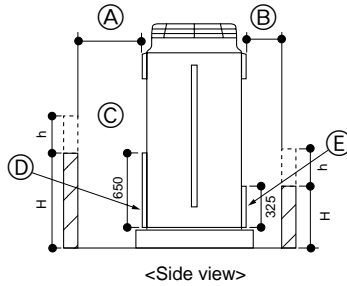

<Side view>

- Ⓐ L1 or more
- Ⓑ L2 or more
- Ⓒ Front
- Ⓓ Front panel
- Ⓔ Rear panel

	L1	L2
R407C units	450mm	450mm
R22 units	450mm	100mm

< Model : 400-500 >

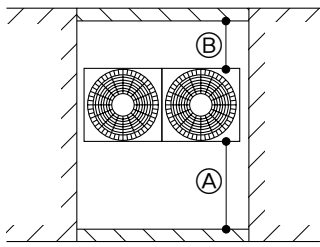

<Top view>

< Model : 600-650-700-750 >

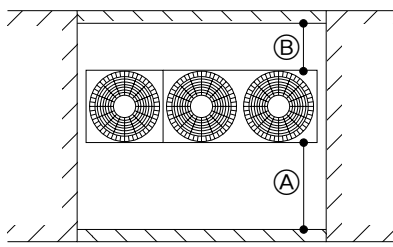

<Top view>

Note:

- Wall heights (H) of the front and the back sides shall be within height of front panel and rear panel.
- If the panel height is exceeded, add the "h" dimension of the figure above to L1 and L2 in the table

Example: When h is 100

The L1 dimension becomes

$$450 + 100 = 550 \text{ mm.}$$

When there is an obstruction above the unit

< Model : 200-250-315 >

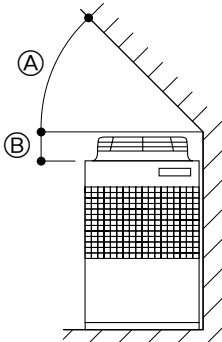

<Front view>

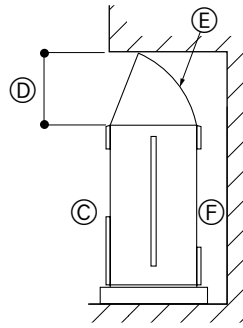

<Side view>

When there is little space up to an obstruction

- Ⓐ 45° or more
- Ⓑ 300 mm or more
- Ⓒ Front
- Ⓓ 1000 mm or more
- Ⓔ Air outlet guide (procured at the site)
- Ⓕ Rear

< Model : 400-500 >

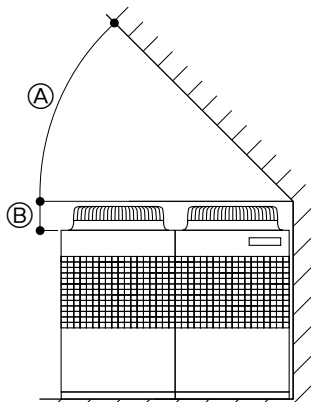

<Front view>

< Model : 600-650-700-750 >

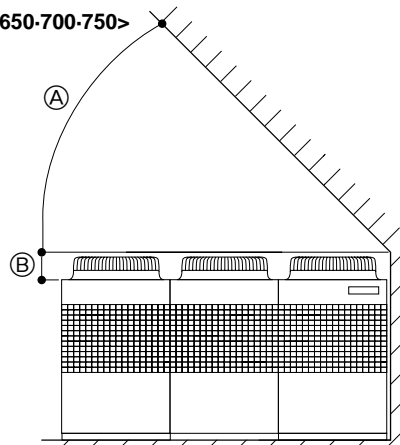

<Front view>

(2) Collective installation and continuous installation

Space required for collective installation and continuous installation: When installing several units, leave the space between each block as shown below considering passage for air and people.

< Model : 200-250-315 >

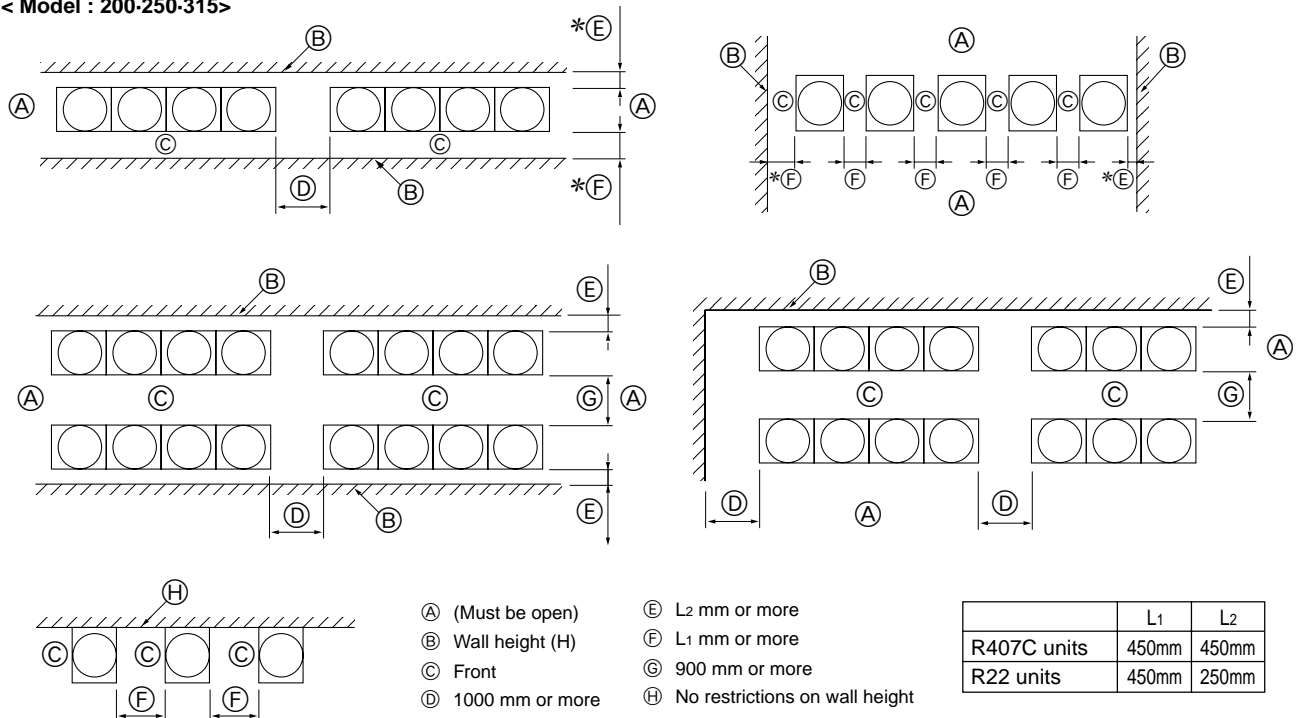

Note:

- Open in the two directions
- In case wall height (H) exceeds overall height of unit, add "h" dimension (h=wall height <H> – overall height of unit) to * marked dimension.
- If there is a wall at both the front and the rear of the unit, install up to three units consecutively in the side direction and provide a space of 1000 mm or more as inlet space/passage space for each three units.

< Model : 400-500 >

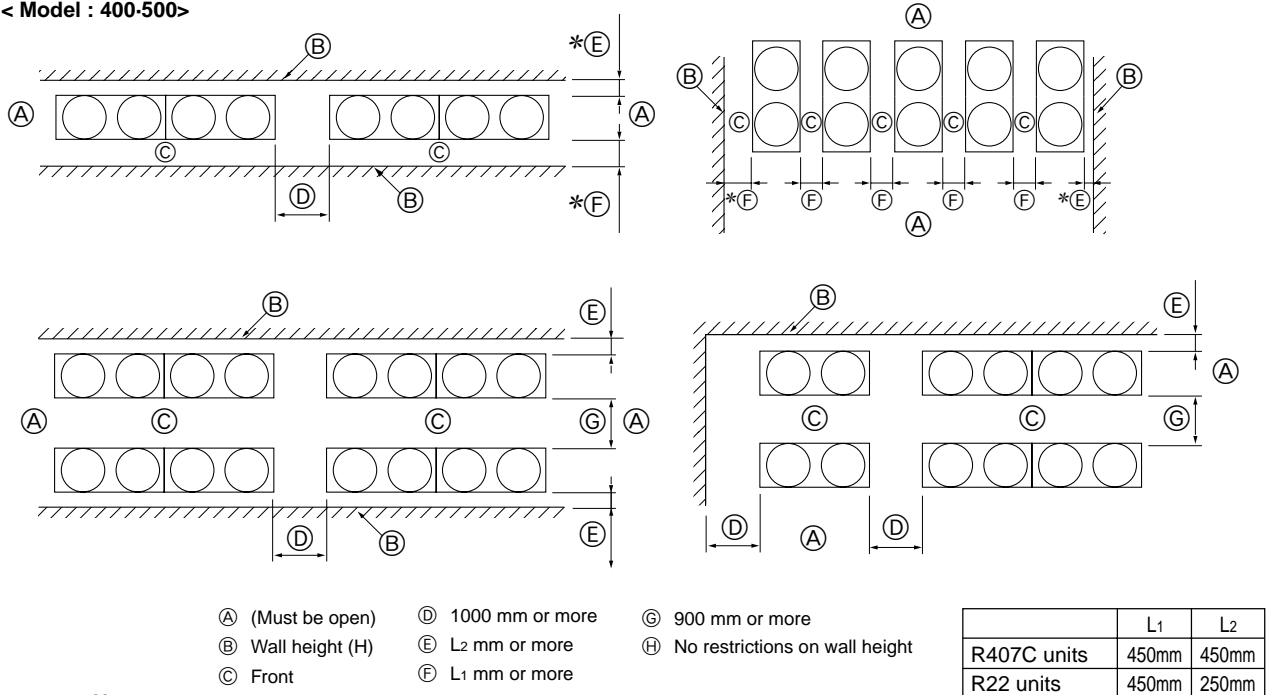

Note:

- Open in the two directions
- In case wall height (H) exceeds overall height of unit, add "h" dimension (h=wall height <H> – overall height of unit) to * marked dimension.
- If there is a wall at both the front and the rear of the unit, install up to three units consecutively in the side direction and provide a space of 1000 mm or more as inlet space/passage space for each three units.

< Model : 600-650-700-750 >

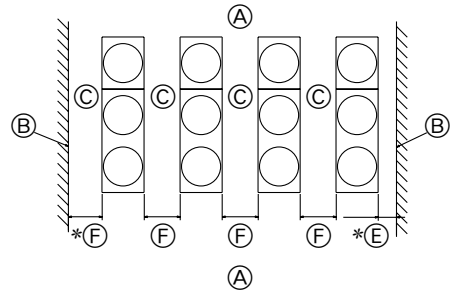
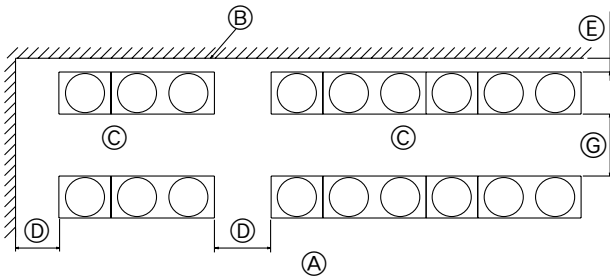
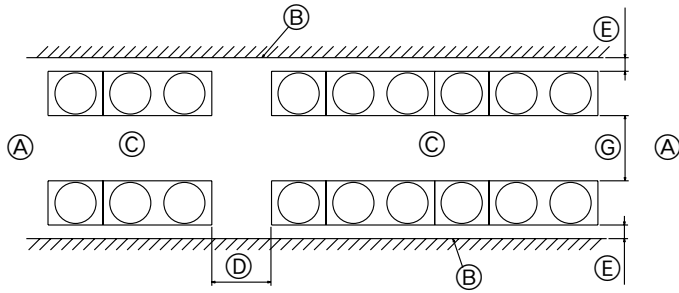
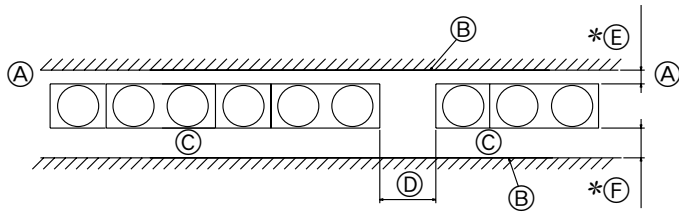

- (A) (Must be open)
- (B) Wall height (H)
- (C) Front
- (D) 1000 mm or more
- (E) L2 mm or more
- (F) L1 mm or more
- (G) 900 mm or more
- (H) No restrictions on wall height

	L1	L2
R407C units	450mm	450mm
R22 units	450mm	250mm

Note:

- Open in the two directions
- In case wall height (H) exceeds overall height of unit, add "h" dimension (h=wall height <H> – overall height of unit) to * marked dimension.
- If there is a wall at both the front and the rear of the unit, install up to three units consecutively in the side direction and provide a space of 1000 mm or more as inlet space/passage space for each three units.

③ PURY

(1) Individual installation

Basic space required

Taking servicing, etc. from the rear into account, a space of about 450 mm should be provided, the same as at the front.

< Model : 200-250 >

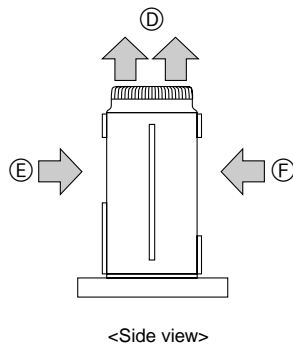
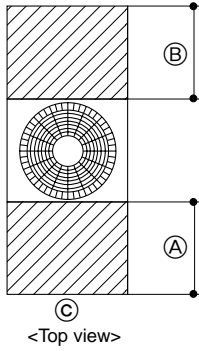

< Model : 400-500 >

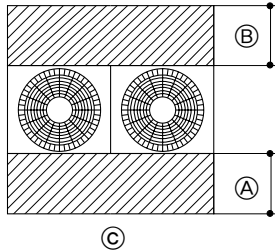

- (A) 450 mm or more
- (B) 450 mm or more
- (C) Front (outside of machine room)
- (D) Top discharge (open in principle)
- (E) Front inlet (open in principle)
- (F) Rear inlet (open in principle)

When unit is surrounded by walls

< Model : 200-250 >

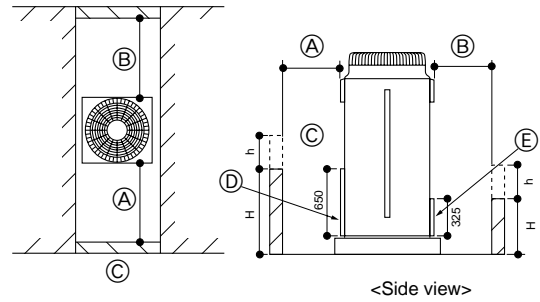

< Model : 400-500 >

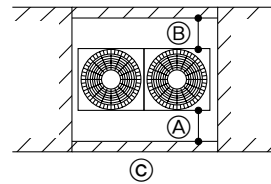

- (A) L1 or more
- (B) L2 or more
- (C) Front
- (D) Front panel
- (E) Rear panel

Note:

- Wall heights (H) of the front and the back sides shall be within height of front panel and rear panel.
- If the panel height is exceeded, add the "h" dimension of the figure above to L1 and L2 in the table above.

L1	L2
450	450

Example: When h is 100

The L dimension becomes 450+100 = 550 mm.

When inlet air enters from right and left sides of unit

< Model : 200-250 >

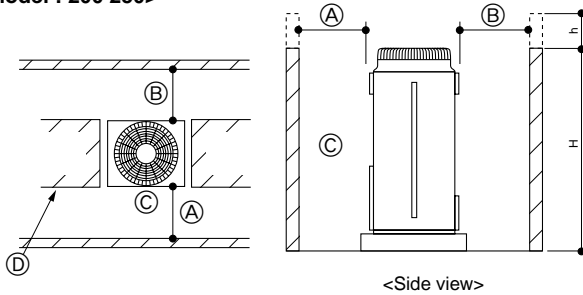

< Model : 400-500 >

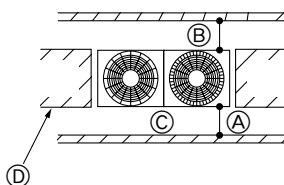

- (A) L1 or more
- (B) L2 or more
- (C) Front
- (D) No restrictions on wall height (left and right)

When there is an obstruction above the unit

< Model : 200-250 >

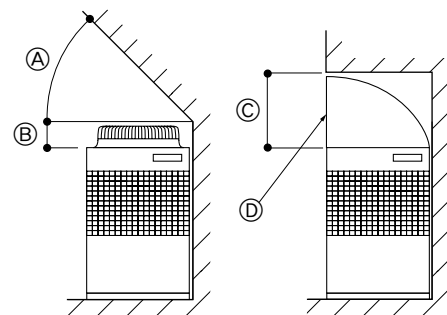

When there is little space up to an obstruction

< Model : 400-500 >

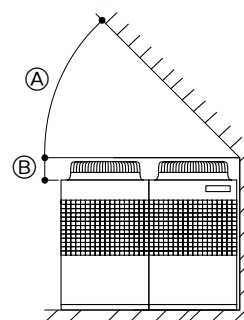

- (A) 45° or more
- (B) 300 mm or more
- (C) 1000 mm or more
- (D) Air outlet guide (Procured at the site)

Note:

- Wall heights (H) of the front and the back sides shall be within overall height of unit.
- When the total height is exceeded, add the "h" dimension of the figure above to L1 and L2 in the table above.

L1	L2
450	450

(2) Collective installation and continuous installation

Space required for collective installation and continuous installation: When installing several units, leave the space between each block as shown below considering passage for air and people.

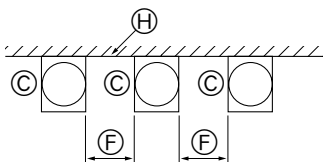
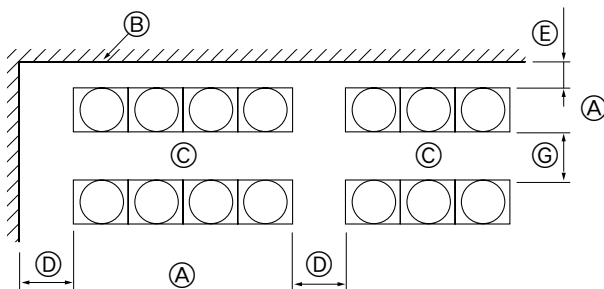
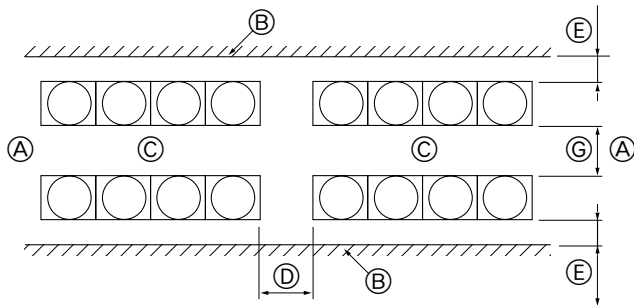
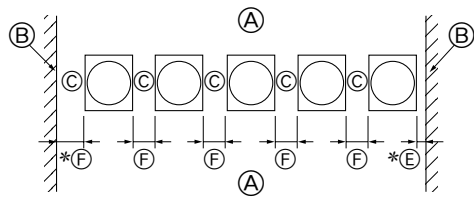
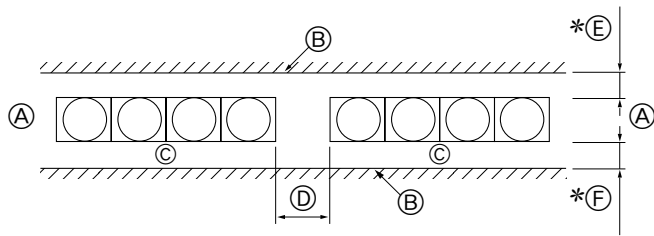

- Ⓐ (Must be open)
- Ⓑ Wall height (H)
- Ⓒ Front
- Ⓓ 1000 mm or more
- Ⓔ 450 mm or more
- Ⓕ 450 mm or more
- Ⓖ 900 mm or more
- Ⓗ No restrictions on wall height

Note:

- Open in the two directions
- In case wall height (H) exceeds overall height of unit, add "h" dimension (h=wall height <H> – overall height of unit) to * marked dimension.
- If there is a wall at both the front and the rear of the unit, install up to three units consecutively in the side direction and provide a space of 1000 mm or more as inlet space/passage space for each three units.

④ PQHY, PQR Y

- Please allow for the following service spaces after installation.
(All servicing can be performed from the front of the unit)

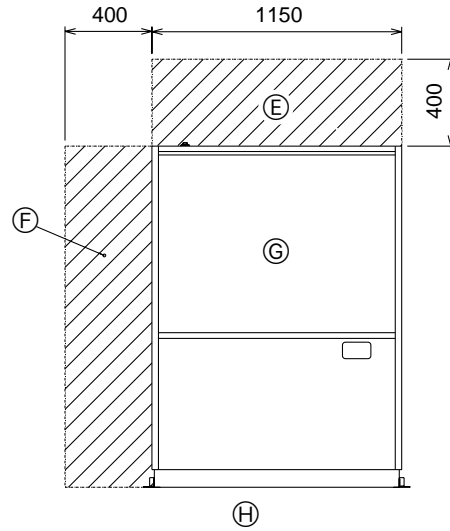
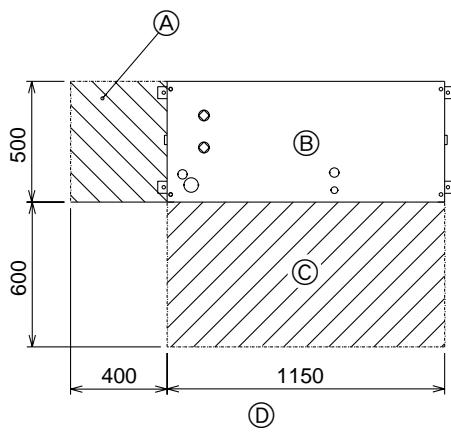

- Ⓐ Piping space (for left piping)
- Ⓑ Heat source unit
- Ⓒ Service space (front side)
- Ⓓ (Top view)

- Ⓔ Piping space (for top piping)
- Ⓕ Piping space (for left piping)
- Ⓖ Heat source unit
- Ⓗ (Front view)

⑤ BC controller

1. For hanging from the ceiling

<Front view> (when hanging to install)

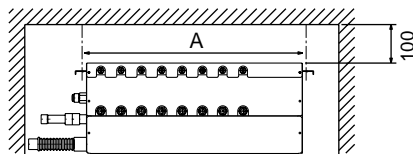

*1 Dimensions with which pipe connection can be handled at site

Model name	A
CMB-P104V-F	702
CMB-P105V-F	702
CMB-P106V-F	702
CMB-P108V-F	702
CMB-P1010V-F	702
CMB-P1013V-F	1152
CMB-P1016V-F	1152

Model name	A
CMB-P108V-FA	1164
CMB-P1010V-FA	1164
CMB-P1013V-FA	1164
CMB-P1016V-FA	1164
CMB-P108V-FB	702

2. When stacking on a rack

(This is a reference view showing the least installation space.)

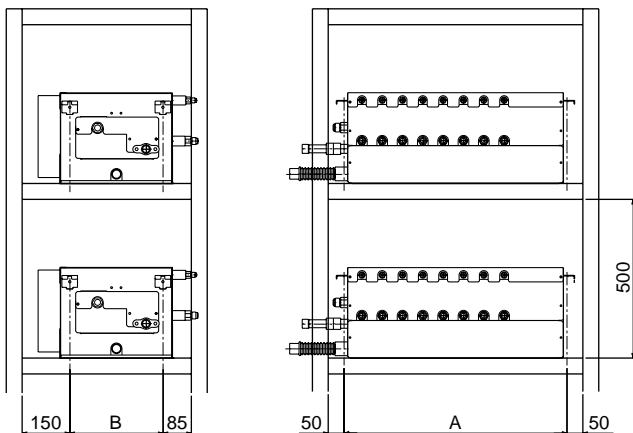

Model name	B
CMB-P104V-F	298
CMB-P105V-F	298
CMB-P106V-F	298
CMB-P108V-F	298
CMB-P1010V-F	298
CMB-P1013V-F	298
CMB-P1016V-F	298
CMB-P108V-FA	388
CMB-P1010V-FA	388
CMB-P1013V-FA	388
CMB-P1016V-FA	388
CMB-P108V-FB	298

2-7-3 Connecting direction for refrigerant piping

① PUMY

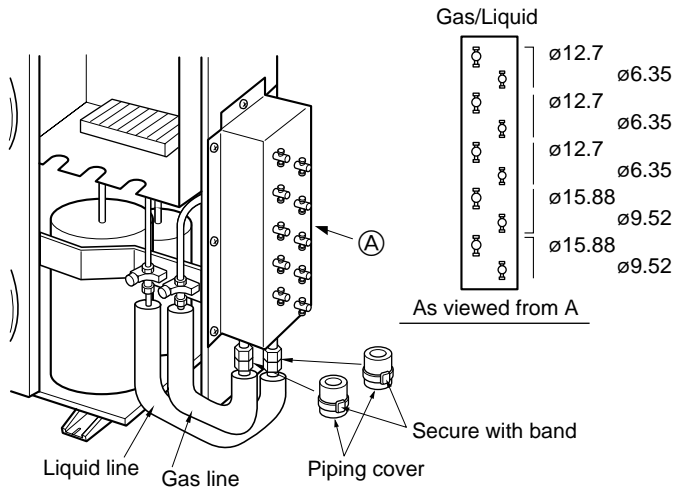
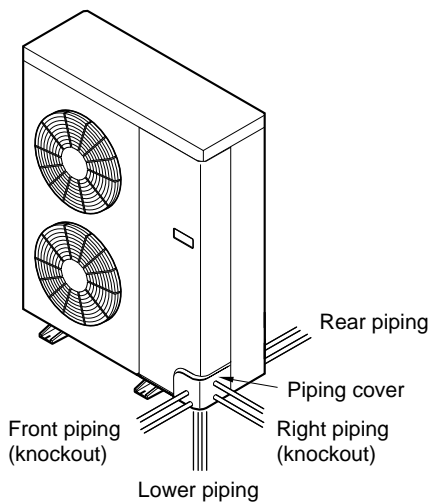

② PUHY, PURY

<Model : 200-250-315>

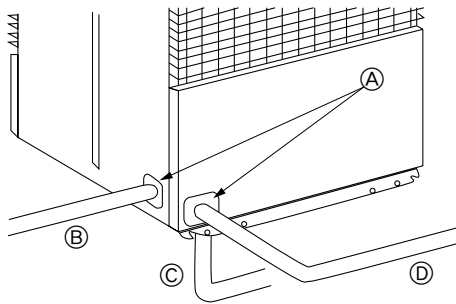

<Model : 400-500>

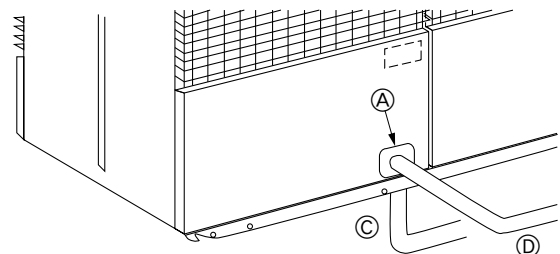

<Model : 600-650-700-750>

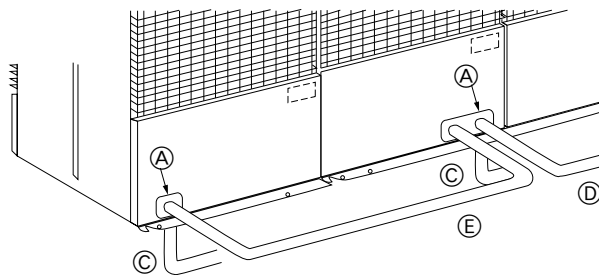

- (A) Knock-out hole
- (B) Left piping
- (C) Bottom piping
- (D) Front piping
- (E) Connect piping (to constant capacity unit)

Note:
In the case of bottom piping, build a 100 mm or higher foundation so that piping will go through the bottom of the unit.

③ PQHY, PQRY

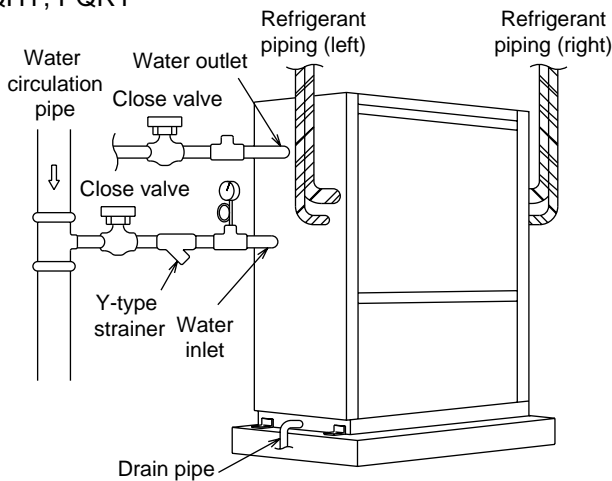

2-7-4 Caution for snow and seasonal wind

① PUMY

Precautions

Installation on a rooftop or other windy places

When installing the unit on a rooftop or other location unprotected from the wind, situate the unit's air outlet so that it is not directly exposed to strong winds. Strong wind entering the air outlet may impede the normal airflow and cause malfunctions.

The following shows three examples of precautions against strong winds.

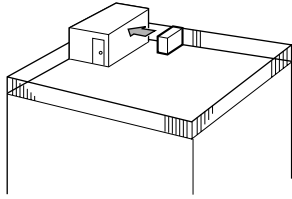

Face the outlet toward any available wall at least 50 cm away from the wall.

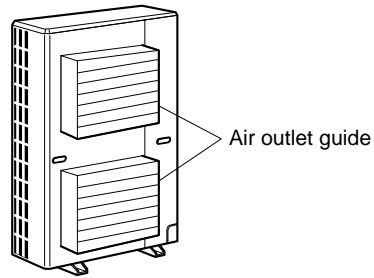

Install an optional air outlet guide and if the unit is installed at a place where the powerful blast of a typhoon, etc. comes directly into the air outlet.

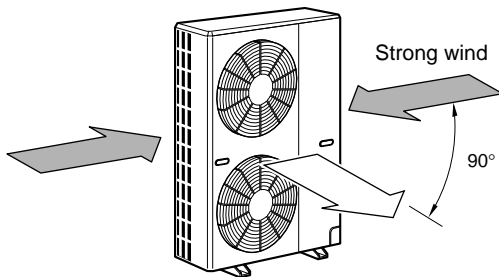

Position the unit so that the air outlet blows perpendicularly to the seasonal wind direction, if possible.

② PU(H)Y, PURY

In cold and/or snowy areas, sufficient countermeasures to wind and snow damages should be taken for operating unit in normal and good condition in winter time. Even in the other areas, full consideration is required for installation of unit in order to prevent abnormal operations caused by wind or snow. **When rain and snow directly fall on unit in the case of air-conditioning operations in 10 or less degrees centigrade outdoor air, mount inlet and outlet ducts on unit for assuring stable operations.**

(1) Snow and wind

Prevention of wind and snow damages in cold or snowy areas:
Refer to the figure of snow hood shown below:

- Snow hood

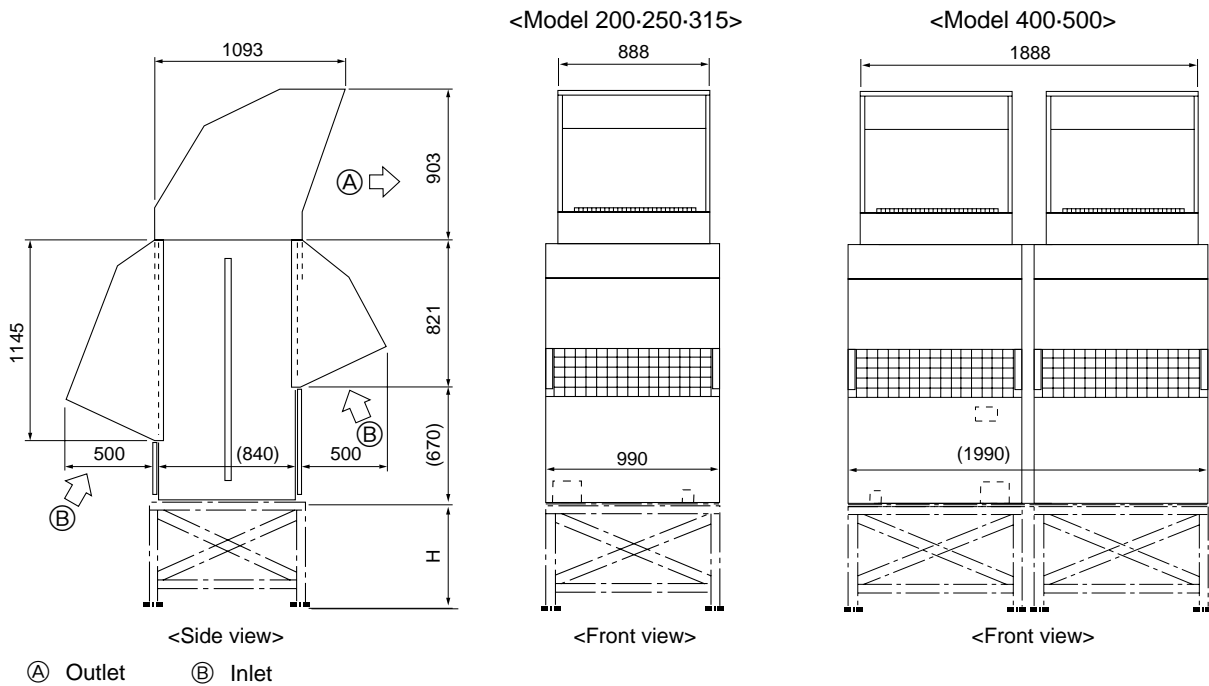

- Note:**
1. Height of frame base for snow damage prevention (H) shall be twice as high as expected snowfall. Width of frame base shall not exceed that of the unit. The frame base shall be made of angle steel, etc., and designed so that snow and wind slip through the structure. (If frame base is too wide, snow will be accumulated on it.)
 2. Install unit so that wind will not directly lash against openings of inlet and outlet ducts.
 3. Build frame base at customer referring to this figure.
 Material : Galvanized steel plate 1.2T
 Painting : Overall painting with polyester powder
 Color : Munsell 5Y8/1 (same as that of unit)
 4. When the unit is used in a cold region and the heating operation is continuously performed for a long time when the outside air temperature is below freezing, install a heater to the unit base or take other appropriate measures to prevent water from freezing on the base.

(2) Countermeasure to wind

Referring to the figure shown below, take appropriate measures which will suit the actual situation of the place for installation.

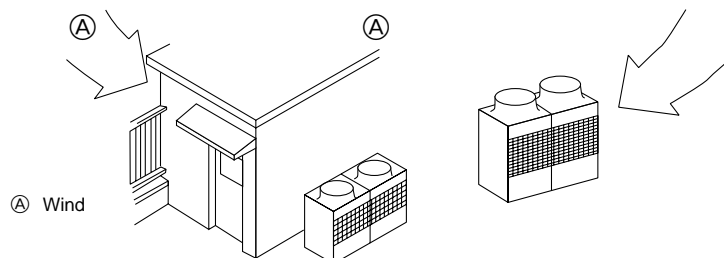

2-8 Joint / Header / Reduction

	Liquid side	Gas side
CMY-Y62C-E		
Reduction Use flare nut attached to BC controller		
CMY-R160-H		
CMY-R160-HA		
CMY-Y102S-F		
CMY-Y102L-F		
CMY-Y202-F		
CMY-Y302-F		

	Liquid side	Gas side										
CMY-Y64-C												
CMY-Y68												
CMY-Y104-F												
CMY-Y107-F												
CMY-Y1010-F												
CMC-30A												
CMY-S65 (PUMY only)	<p style="text-align: center;">Gas/Liquid</p> <table border="1" style="margin-left: auto; margin-right: auto;"> <tr><td>12.7</td><td>6.35</td></tr> <tr><td>12.7</td><td>6.35</td></tr> <tr><td>12.7</td><td>6.35</td></tr> <tr><td>15.88</td><td>9.52</td></tr> <tr><td>15.88</td><td>9.52</td></tr> </table> <p style="text-align: center;">As viewed from A</p>	12.7	6.35	12.7	6.35	12.7	6.35	15.88	9.52	15.88	9.52	
12.7	6.35											
12.7	6.35											
12.7	6.35											
15.88	9.52											
15.88	9.52											

OD:Outside Diameter

3. Caution For Refrigerant Leak

The installer and system specialist shall secure safety against leakage according to local regulations or standards. The following standards may be applicable if local regulations are not available.

3-1 Introduction

In addition to City Multi almost all air conditioners utilize R22 or R407C as refrigerant. Though the R22, R407C is harmless and incombustible in itself, the room to equip the air conditioner should be large to such an extent that the refrigerant gas will not exceed the limiting concentration even if the refrigerant gas leaks in the room.

• Limiting concentration

Limiting concentration is the limit of Freon gas concentration where immediate measures can be taken without hurting human body when refrigerant leaks in the air. The limiting concentration shall be described in the unit of kg/m³ (Freon gas weight in /m³ air) for facilitating calculation.

Limiting concentration: 0.3kg/m³(R22), 0.31kg/m³(R407C) (ISO5149, EN378-1)

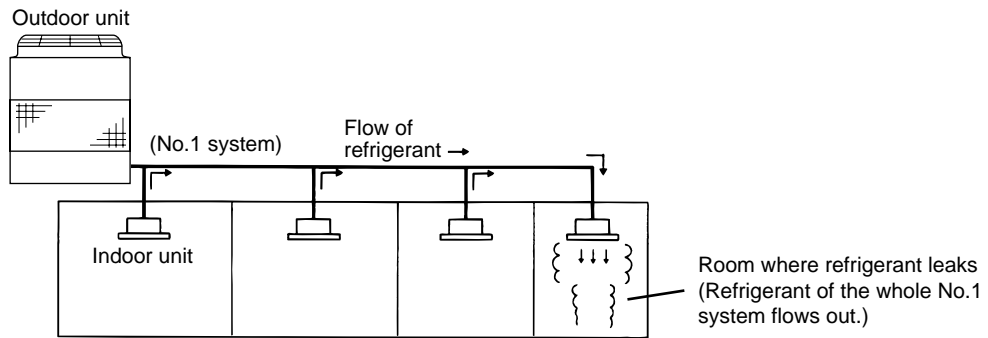

3-2 Checking procedure of limiting concentration

Check limiting concentration following step ①~④, and take appropriate measure depending on the situation.

① Calculate amount of all the replenished refrigerant (kg) per each refrigerant system.

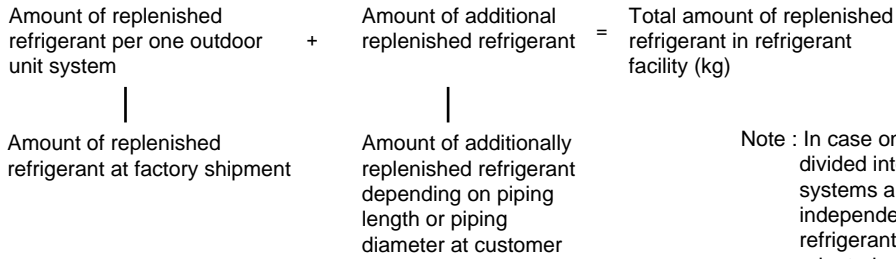

② Calculate minimum room capacity.

Calculate room capacity by regarding portion as one room or the smaller room.

(a) Without partition

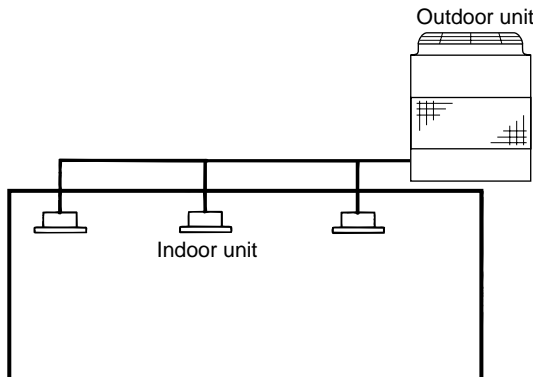

(b) With partition and with opening which serve as passage of air to adjoining room

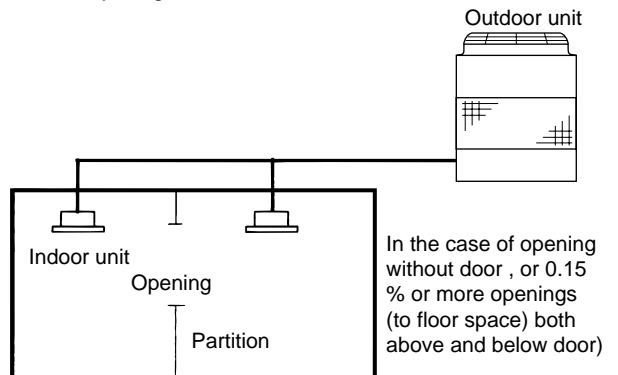

(c) With partition and without opening which serve as passage of air to adjoining room

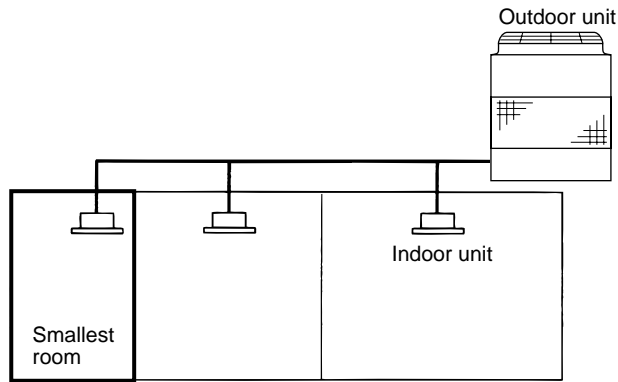

③ Calculate refrigerant concentration with the results of ①

$$\frac{\text{Total amount of replenished refrigerant in refrigerant facility (kg)}}{\text{Capacity of smallest room where indoor unit is installed (m}^3\text{)}} = \text{Refrigerant concentration (kg/m}^3\text{)} \quad \text{(R22 or R407C)}$$

In case the result of calculation exceeds the limiting concentration, perform the same calculations by shifting to the second smallest, and the third smallest rooms until at last the result is below the limiting concentration.

④ In case limiting concentration is exceeded

When limiting concentration is exceeded, change original plan or take one of the countermeasures shown below:

- Countermeasure 1
Provide opening for ventilation.
Provide 0.15% or more opening to floor space both above and below door, or provide opening without door.
- Countermeasure 2
Provide gas leak alarm linked with mechanical ventilator.

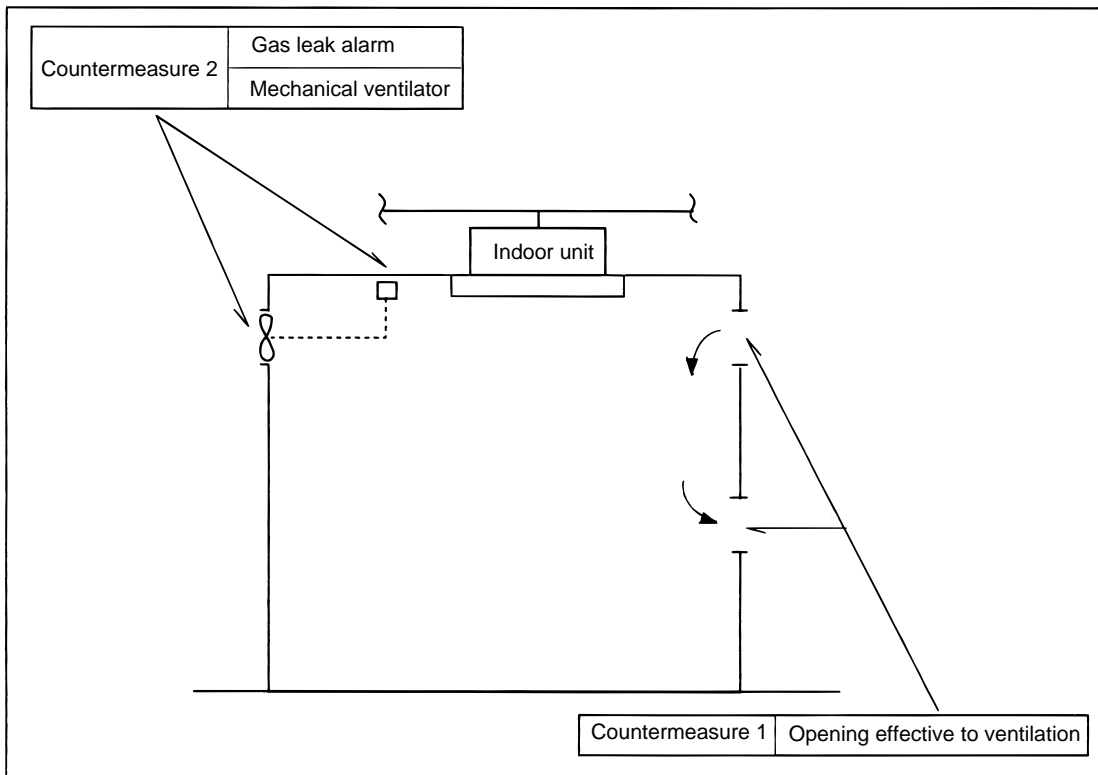

Pay a special attention to the place, such as a basement, etc. where refrigerant can stay, since refrigerant is heavier than air.



CITY MULTI
DATA BOOK
2003-2004

 **MITSUBISHI ELECTRIC CORPORATION**
HEAD OFFICE: 2-2-3, MARUNOUCHI, CHIYODA-KU, TOKYO 100-8310, JAPAN