

**2016**

**R410A**

# Service Handbook

**Model**

**PUHY-P200, P250, P300, P350, P400, P450, P500YKB-A1**

**PUHY-P400, P450, P500, P550, P600, P650, P700, P750, P800, P850, P900YSKB-A1**

**PUHY-P950, P1000, P1050, P1100, P1150, P1200, P1250, P1300, P1350YSKB-A1**

**2nd edition**

# Safety Precautions

•Please read the following safety precautions carefully before installing the unit to ensure safety.



## **WARNING**

Indicates a risk of death or serious injury.



## **CAUTION**

Indicates a risk of serious injury or structural damage.

- Make sure that this manual is passed on to the end user to retain for future reference.
- Retain this manual for future reference. When the unit is reinstalled or repaired, have this manual available to those who provide these services. Make sure that this manual is passed on to any future users.

**All electric work must be performed by qualified personnel.**

**Air tightness test must be performed by qualified personnel.**

## General Precautions



## **WARNING**

Do not use refrigerant other than the type indicated in the manuals provided with the unit and on the nameplate. Doing so may cause the unit or pipes to burst, or result in explosion or fire during use, during repair, or at the time of disposal of the unit. It may also be in violation of applicable laws. **MITSUBISHI ELECTRIC CORPORATION** cannot be held responsible for malfunctions or accidents resulting from the use of the wrong type of refrigerant.

Do not install the unit in a place where large amounts of oil, steam, organic solvents, or corrosive gases, such as sulfuric gas, are present or where acidic/alkaline solutions or sprays containing sulfur are used frequently. These substances can compromise the performance of the unit or cause certain components of the unit to corrode, which can result in refrigerant leakage, water leakage, injury, electric shock, malfunctions, smoke, or fire.

Do not try to defeat the safety features of the unit or make unauthorized setting changes. Forcing the unit to operate the unit by defeating the safety features of the devices such as the pressure switch or the temperature switch, making unauthorized changes to the switch settings, or using accessories other than the ones recommended by Mitsubishi Electric may result in smoke, fire, or explosion.

To reduce the risk of shorting, current leakage, electric shock, malfunctions, smoke, or fire, do not splash water on electric parts.

To reduce the risk of electric shock, malfunctions, smoke or fire, do not operate the switches/buttons or touch other electrical parts with wet hands.

To reduce the risk of pipe burst and explosion, do not allow gas refrigerant and refrigerant oil to be trapped in the refrigerant circuit.

To reduce the risk of burns or frost bites, do not touch the refrigerant pipes or refrigerant circuit components with bare hands during and immediately after operation.

To reduce the risk of burns, do not touch any electrical parts with bare hands during or immediately after stopping operation.

To reduce the risk of injury from falling tools, keep children away while installing, inspecting, or repairing the unit.

Keep the space well ventilated. Refrigerant can displace air and cause oxygen starvation. If leaked refrigerant comes in contact with a heat source, toxic gas may be generated.

Always replace a fuse with one with the correct current rating. The use of improperly rated fuses or a substitution of fuses with steel or copper wire may result in bursting, fire or explosion.

To reduce the risk of electric shock, smoke, and fire due to infiltration of dust and water, properly install all required covers and panels on the terminal box and control box.

## CAUTION

To reduce the risk of being caught in rotating parts, electric shock, and burns, do not operate the unit without all required panels and guards being installed.

To reduce the risk of injury, do not sit, stand, or place objects on the unit.

To reduce the risk of water leakage and malfunctions, do not turn off the power immediately after stopping operation. Leave the unit turned on for at least 5 minutes before turning off the power.

Do not install the unit over things that are vulnerable to water damage from condensation dripping.

To reduce the risk of injury, electric shock, and malfunctions, do not touch or allow cables to come in contact with the edges of components.

To reduce the risk of injury, do not touch the heat exchanger fins or sharp edges of components with bare hands.

To reduce the risk of injury from units falling or falling over, periodically check the installation base for damage.

Consult an authorized agency for the proper disposal of the unit. Refrigerant oil and refrigerant that may be left in the unit pose a risk of fire, explosion, or environmental pollution.

Always wear protective gears when touching electrical components on the unit. Several minutes after the power is switched off, residual voltage may still cause electric shock.

To reduce the risk of electric shock and burns, always wear protective gear when working on units.

To reduce the risk of injury, do not insert fingers or foreign objects into air inlet/outlet grills. If the unit is left on a damaged base, it may fall and cause injury.

To reduce the risk of injury, always wear protective gear when working on units.

Do not release refrigerant into the atmosphere. Collect and reuse the refrigerant, or have it properly disposed of by an authorized agency. Refrigerant poses environmental hazards if released into the air.

## Transportation and Installation

### WARNING

Lift the unit by placing the slings at designated locations. Support the outdoor unit securely at four points to keep it from slipping and sliding. If the unit is not properly supported, it may fall and cause personal injury.

### CAUTION

To reduce the risk of injury, do not carry the product by the PP bands that are used on some packages.

To reduce the risk of injury, products weighing 20 kg or more should be carried by two or more people.

## Installation

### WARNING

Do not install the unit where there is a risk of leaking flammable gas. If flammable gas accumulates around the unit, it may ignite and cause a fire or explosion.

To reduce the risk of injury from coming in contact with units, install units where they are not accessible to people other than maintenance personnel.

To reduce the risk of injury, properly dispose of the packing materials so that children will not play with them.

Properly dispose of the packing materials. Plastic bags pose suffocation hazard to children.

All drainage work should be performed by the dealer or qualified personnel according to the instructions detailed in the Installation Manual. Improper drainage work may cause water leakage and resultant damage to the furnishings.

Remove packing materials from the unit before operating the unit. Note that some accessories may be taped to the unit. Properly install all accessories that are required. Failing to remove the packing materials or failing to install required accessories may result in refrigerant leakage, oxygen deprivation, smoke, or fire.

Consult your dealer and take appropriate measures to safeguard against refrigerant leakage and resultant oxygen starvation. An installation of a refrigerant gas detector is recommended.

Any additional parts must be installed by the dealer or qualified personnel. Only use the parts specified by Mitsubishi Electric. Installation by unauthorized personnel or use of unauthorized parts or accessories may result in water leakage, electric shock, or fire.

Take appropriate safety measures against wind gusts and earthquakes to prevent the unit from toppling over and causing injury.

To reduce the risk of injury from units falling or falling over, install the unit on a surface that is strong enough to support its weight.

### CAUTION

Do not install the unit over things that are vulnerable to water damage. Provide an adequate collective drainage system for the drain water from unit as necessary.

To reduce the risk of damage to the unit and resultant electric leak and electric shock, keep small animals, snow, and rain water from entering the unit by closing the gap in the pipe and wire access holes.

To reduce the risk of rain water or drain water from entering the room and damaging the interior, drainage work must be performed by your dealer or qualified personnel according to the instructions detailed in the Installation Manual.

## Piping Work

### WARNING

To reduce the risk of injury, including frost bites, that may result from being blasted with refrigerant, use caution when operating the refrigerant service valve. If refrigerant leaks out and comes in contact with an open flame, toxic gases may be generated.

To reduce the risk of refrigerant catching fire and causing burns, remove the refrigerant gas and the residual refrigerant oil in the pipes before heating them.

To reduce the risk of pipe damage, refrigerant leakage, and oxygen deprivation, use pipes that meet the pipe thickness specifications, which vary by the type of refrigerant used, pipe diameter, and pipe material.

To reduce the risk of pipe burst or explosion, evacuate the refrigerant circuit using a vacuum pump, and do not purge the system with refrigerant.

To reduce the risk of explosion and deterioration of refrigerant oil caused by chloride, do not use oxygen, flammable gas, or refrigerant that contains chloride as a pressurizing gas.

To prevent explosion, do not heat the unit with refrigerant gas in the refrigerant circuit.

To reduce the risk of oxygen deprivation and gas poisoning, check for gas leakage and keep fire sources away.

Insulate pipe connections after completing the air tightness test. Performing an air tightness test with the pipe being insulated may lead to failure to detect refrigerant leakage and cause oxygen deprivation.

To reduce the risk of pipe damage and resultant refrigerant leakage and oxygen deprivation, keep the field-installed pipes out of contact with the edges of components.

## CAUTION

To reduce the risk of pipe bursting and explosion due to abnormal pressure rise, do not allow any substances other than R410A (such as air) to enter the refrigerant circuit.

To keep the ceiling and floor from getting wet due to condensation, properly insulate the pipes.

## Wiring Work

### WARNING

To reduce the risk of wire breakage, overheating, smoke, and fire, keep undue force from being applied to the wires.

To reduce the risk of wire breakage, overheating, smoke, or fire, properly secure the cables in place and provide adequate slack in the cables so as not to stress the terminals.

All electric work must be performed by a qualified electrician according to the local regulations, standards, and the instructions detailed in the Installation Manual. Capacity shortage to the power supply circuit or improper installation may result in malfunction, electric shock, smoke, or fire.

To reduce the risk of electric shock, smoke, or fire, install an inverter circuit breaker on the power supply to each unit.

Use properly rated breakers and fuses (inverter circuit breaker, local switch <switch + fuse>, no-fuse breaker). The use of a breaker with a breaking capacity greater than the specified capacity may cause electric shock, malfunctions, smoke, or fire.

To reduce the risk of current leakage, overheating, smoke, or fire, use properly rated cables with adequate current carrying capacity.

Proper grounding must be provided by a licensed electrician. Do not connect the grounding wire to a gas pipe, water pipe, lightning rod, or telephone wire. Improper grounding may result in electric shock, smoke, fire, or malfunction due to electrical noise interference.

### CAUTION

To reduce the risk of current leakage, wire breakage, smoke, or fire, keep the wiring out of contact with the refrigerant pipes and other parts, especially sharp edges.

## Relocation and Repairs

### WARNING

To reduce the risk of refrigerant leakage, water leakage, injury, electric shock, and fire, units should only be moved or repaired by your dealer or qualified personnel.

To reduce the risk of wire shorting, electric leak, electric shock, smoke, or fire, do not perform maintenance work in the rain.

To reduce the risk of injury, electric shock, and fire, properly reinstall all removed components after completing repair work.

### CAUTION

To reduce the risk of wire shorting, electric shock, malfunctions, or fire, keep circuit boards dust free, and do not touch them with your hands or tools.

To reduce the risk of refrigerant and water leakage, check the pipe supports and insulation for damage during inspection or repair, and replace or repair the ones that are found to be deteriorated.

## Additional Precautions

To avoid damage to the unit, use appropriate tools to install, inspect, or repair the unit.

Direct the blazing torch flame away from the adjacent cables and sheet metal to keep them from being overheated and damaged.

To reduce the risk of malfunction, turn on the power at least 12 hours before starting operation, and leave the power turned on throughout the operating season.

Prepare tools for exclusive use with R410A. Do not use the following tools if they have been used with the conventional refrigerant (R22): gauge manifold, charging hose, refrigerant leak detector, check valve, refrigerant charge spout, vacuum gauge, and refrigerant recovery equipment. R410A does not contain chloride, so leak detectors for use with older types of refrigerants will not detect an R410A leak. Infiltration of the residual refrigerant, refrigerant oil, or water on these tools may cause the refrigerant oil in the new system to deteriorate or damage the compressor.

Recover all refrigerant in the units, and dispose of it properly according to any applicable laws and regulations.

Provide a maintenance access to allow for the inspection of pipes above the ceiling or the buried pipes.

To reduce the risk of the vacuum pump oil backflowing into the refrigerant cycle and causing the refrigerant oil to deteriorate, use a vacuum pump with a check valve.

Take appropriate measures against electrical noise interference when installing the air conditioners in hospitals or facilities with radio communication capabilities. Inverter, high-frequency medical, or wireless communication equipment as well as power generators may cause the air conditioning system to malfunction. Air conditioning system may also adversely affect the operation of these types of equipment by creating electrical noise.

Have a set of tools for exclusive use with R410A. Consult your nearest Mitsubishi Electric Dealer.

To reduce the risk of damage to the unit, leave the valves on the unit closed until refrigerant charging is completed.

Keep dust, dirt, and water off charging hose and flare tool. Infiltration of dust, dirt, or water into the refrigerant circuit may cause the refrigerant oil to deteriorate or damage the compressor.

Place a wet towel on the refrigerant service valve before brazing the pipes to keep its temperature from rising above 120°C and damaging the surrounding equipment.

Use refrigerant piping and couplings that meet the applicable standards. For refrigerant pipes, use pipes made of phosphorus deoxidized copper. Keep the inner and outer surfaces of pipes and couplings clean and free of such contaminants as sulfur, oxides, dust, dirt, shaving particles, oil, and moisture. Failure to follow these directions may result in the deterioration of refrigerant oil or compressor damage.

Store the piping materials indoors, and keep both ends of the pipes sealed until immediately before brazing. Keep elbows and other joints in plastic bags. Infiltration of dust, dirt, or water into the refrigerant circuit may cause the refrigerant oil to deteriorate or damage the compressor.

Apply ester oil, ether oil, or a small amount of alkyl benzene to flares and flanges. The use and accidental infiltration of mineral oil into the system may cause the refrigerant oil to deteriorate or damage the compressor.

To reduce the risk of oxidized film from entering the refrigerant pipe and causing the refrigerant oil to deteriorate or damaging the compressor, braze pipes under nitrogen purge.

Do not use the existing refrigerant piping. A large amount of chloride that is contained in the residual refrigerant and refrigerant oil in the existing piping may cause the refrigerant oil in the new unit to deteriorate or damage the compressor.

Charge refrigerant in the liquid state. If refrigerant is charged in the gas phase, the composition of the refrigerant in the cylinder will change, compromising the unit's performance.

Do not use a charging cylinder. The use of a charging cylinder will change the composition of the refrigerant, compromising the unit's performance.

Charge the system with an appropriate amount of refrigerant in the liquid phase. Refer to the relevant sections in the manuals to calculate the appropriate amount of refrigerant to be charged. Refrigerant overcharge or undercharge may result in performance drop or abnormal stop of operation.

To reduce the risk of power capacity shortage, always use a dedicated power supply circuit.

To reduce the risk of both the breaker on the product side and the upstream breaker from tripping and causing problems, split the power supply system or provide protection coordination between the earth leakage breaker and no-fuse breaker.

Have a backup system, if failure of the unit has a potential for causing significant problems or damages.

# CONTENTS

---

## Chapter 1 Check Before Servicing

1-1	Preparation for Piping Work.....	3
1-2	Handling and Characteristics of Piping Materials, Refrigerant, and Refrigerant Oil .....	5
1-3	Working with Refrigerant Piping.....	10
1-4	Precautions for Wiring .....	14
1-5	Cautionary notes on installation environment and maintenance.....	16

## Chapter 2 Restrictions

2-1	System Configurations .....	19
2-2	Types and Maximum Allowable Length of Cables .....	20
2-3	Switch Settings.....	21
2-4	M-NET Address Settings .....	22
2-5	Demand Control Overview .....	28
2-6	System Connection Example .....	30
2-7	Example System with an MA Remote Controller .....	32
2-8	Example System with an ME Remote Controller.....	42
2-9	Example System with an MA and an ME Remote Controller.....	44
2-10	Restrictions on Refrigerant Pipes .....	46

## Chapter 3 Major Components, Their Functions and Refrigerant Circuits

3-1	External Appearance and Refrigerant Circuit Components of Outdoor Unit .....	53
3-2	Outdoor Unit Refrigerant Circuit Diagrams .....	59
3-3	Functions of the Major Components of Outdoor Unit .....	61
3-4	Functions of the Major Components of Indoor Unit .....	64

## Chapter 4 Electrical Components and Wiring Diagrams

4-1	Outdoor Unit Circuit Board Arrangement .....	67
4-2	Outdoor Unit Circuit Board Components .....	71
4-3	Outdoor Unit Electrical Wiring Diagrams.....	80
4-4	Transmission Booster Electrical Wiring Diagrams .....	82

## Chapter 5 Control

5-1	Dipswitch Functions and Factory Settings.....	85
5-2	Outdoor Unit Control .....	93
5-3	Operation Flowcharts .....	106

## Chapter 6 Test Run

6-1	Read before Test Run .....	113
6-2	MA and ME Remote Controller Functions and Specifications.....	114
6-3	Making the Group and Interlock Settings from an ME Remote Controller .....	115
6-4	Selecting Remote Controller Functions from an ME Remote Controller .....	119
6-5	Making Interlock Settings from an MA Remote Controller.....	121
6-6	Changing the Room Temperature Detection Position .....	127
6-7	Test Run Method .....	128
6-8	Operation Characteristics and Refrigerant Charge .....	131
6-9	Evaluating and Adjusting Refrigerant Charge.....	131
6-10	The Following Symptoms Are Normal .....	137
6-11	Standard Operation Data (Reference Data) .....	138

## Chapter 7 Troubleshooting Using Error Codes

7-1	Error Code and Preliminary Error Code Lists .....	165
7-2	Error Code Definitions and Solutions: Codes [0 - 999].....	169
7-3	Error Code Definitions and Solutions: Codes [1000 - 1999].....	171
7-4	Error Code Definitions and Solutions: Codes [2000 - 2999].....	175
7-5	Error Code Definitions and Solutions: Codes [3000 - 3999].....	181
7-6	Error Code Definitions and Solutions: Codes [4000 - 4999].....	182
7-7	Error Code Definitions and Solutions: Codes [5000 - 5999].....	198
7-8	Error Code Definitions and Solutions: Codes [6000 - 6999].....	206



# CONTENTS

---

7-9	Error Code Definitions and Solutions: Codes [7000 - 7999].....	226
<b>Chapter 8 Troubleshooting Based on Observed Symptoms</b>		
8-1	MA Remote Controller Problems .....	237
8-2	ME remote Controller Problems .....	241
8-3	Refrigerant Control Problems .....	245
8-4	Checking Transmission Waveform and for Electrical Noise Interference.....	250
8-5	Pressure Sensor Circuit Configuration and Troubleshooting Pressure Sensor Problems .....	253
8-6	Troubleshooting Solenoid Valve Problems .....	255
8-7	Troubleshooting Outdoor Unit Fan Problems .....	257
8-8	Troubleshooting LEV Problems.....	258
8-9	Troubleshooting Inverter Problems .....	264
8-10	Control Circuit .....	276
8-11	Measures for Refrigerant Leakage .....	281
8-12	Compressor Replacement Instructions .....	283
8-13	Troubleshooting Problems Using the LED Status Indicators on the Outdoor Unit.....	285
<b>Chapter 9 LED Status Indicators on the Outdoor Unit Circuit Board</b>		
9-1	LED Status Indicators .....	289
9-2	LED Status Indicators Table.....	292

---

## Chapter 1 Check Before Servicing

<b>1-1</b>	<b>Preparation for Piping Work</b> .....	<b>3</b>
1-1-1	Read before Servicing .....	3
1-1-2	Tool Preparation .....	4
<b>1-2</b>	<b>Handling and Characteristics of Piping Materials, Refrigerant, and Refrigerant Oil</b> .....	<b>5</b>
1-2-1	Piping Materials .....	5
1-2-2	Storage of Piping Materials .....	7
1-2-3	Pipe Processing .....	7
1-2-4	Characteristics of the New and Conventional Refrigerants .....	8
1-2-5	Refrigerant Oil .....	9
<b>1-3</b>	<b>Working with Refrigerant Piping</b> .....	<b>10</b>
1-3-1	Pipe Brazing.....	10
1-3-2	Air Tightness Test .....	11
1-3-3	Vacuum Drying .....	12
1-3-4	Refrigerant Charging.....	13
<b>1-4</b>	<b>Precautions for Wiring</b> .....	<b>14</b>
<b>1-5</b>	<b>Cautionary notes on installation environment and maintenance</b> .....	<b>16</b>



# 1-1 Preparation for Piping Work

## 1-1-1 Read before Servicing

**1. Check the type of refrigerant used in the system to be serviced.**

**Refrigerant Type**

Multi air conditioner for building application CITY MULTI YKB-A1 series:R410A

**2. Check the symptoms exhibited by the unit to be serviced.**

Refer to this service handbook for symptoms relating to the refrigerant cycle.

**3. Thoroughly read the safety precautions at the beginning of this manual.**

**4. Preparing necessary tools: Prepare a set of tools to be used exclusively with each type of refrigerant.**

For information about the correct use of tools, refer to the following page(s). [1-1-2 Tool Preparation](page 4)

**5. Verification of the connecting pipes: Verify the type of refrigerant used for the unit to be moved or replaced.**

- Use refrigerant pipes made of phosphorus deoxidized copper. Keep the inner and outer surfaces of the pipes clean and free of such contaminants as sulfur, oxides, dust, dirt, shaving particles, oil, and water.
- These types of contaminants inside the refrigerant pipes may cause the refrigerant oil to deteriorate.

**6. If there is a leak of gaseous refrigerant and the remaining refrigerant is exposed to an open flame, a poisonous gas hydrofluoric acid may form. Keep workplace well ventilated.**



**CAUTION**

- Install new pipes immediately after removing old ones to keep moisture out of the refrigerant circuit.
- The use of refrigerant that contains chloride, such as R22, will cause the refrigerating machine oil to deteriorate.

## 1-1-2 Tool Preparation

Prepare the following tools and materials necessary for installing and servicing the unit.

### Tools for use with R410A (Adaptability of tools that are for use with R22 or R407C)

#### 1. To be used exclusively with R410A (not to be used if used with R22 or R407C)

Tools/Materials	Use	Notes
Gauge Manifold	Evacuation and refrigerant charging	Higher than 5.09MPa[738psi] on the high-pressure side
Charging Hose	Evacuation and refrigerant charging	The hose diameter is larger than the conventional model.
Refrigerant Recovery Cylinder	Refrigerant recovery	
Refrigerant Cylinder	Refrigerant charging	The refrigerant type is indicated. The cylinder is pink.
Charging Port on the Refrigerant Cylinder	Refrigerant charging	The charge port diameter is larger than that of the current port.
Flare Nut	Connection of the unit with the pipes	Use Type-2 Flare nuts.

#### 2. Tools and materials that may be used with R410A with some restrictions

Tools/Materials	Use	Notes
Gas Leak Detector	Gas leak detection	The ones for use with HFC refrigerant may be used.
Vacuum Pump	Vacuum drying	May be used if a check valve adapter is attached.
Flare Tool	Flare processing	Flare processing dimensions for the piping in the system using the new refrigerant differ from those of R22. Refer to the following page(s). [1-2-1 Piping Materials](page 5)
Refrigerant Recovery Equipment	Refrigerant recovery	May be used if compatible with R410A.

#### 3. Tools and materials that are used with R22 or R407C that may also be used with R410A

Tools/Materials	Use	Notes
Vacuum Pump with a Check Valve	Vacuum drying	
Bender	Bending pipes	
Torque Wrench	Tightening flare nuts	Only the flare processing dimensions for pipes that have a diameter of $\varnothing 12.7$ (1/2") and $\varnothing 15.88$ (5/8") have been changed.
Pipe Cutter	Cutting pipes	
Welder and Nitrogen Cylinder	Welding pipes	
Refrigerant Charging Meter	Refrigerant charging	
Vacuum Gauge	Vacuum level check	

#### 4. Tools and materials that must not be used with R410A

Tools/Materials	Use	Notes
Charging Cylinder	Refrigerant charging	Prohibited to use

Tools for R410A must be handled with special care to keep moisture and dust from infiltrating the cycle.

# 1-2 Handling and Characteristics of Piping Materials, Refrigerant, and Refrigerant Oil

## 1-2-1 Piping Materials

**Do not use the existing piping!**

### 1. Copper pipe materials

O-material (Annealed)	Soft copper pipes (annealed copper pipes). They can easily be bent with hands.
1/2H-material (Drawn)	Hard copper pipes (straight pipes). They are stronger than the O-material (Annealed) at the same radial thickness.

- The distinction between O-materials (Annealed) and 1/2H-materials (Drawn) is made based on the strength of the pipes themselves.
- O-materials (Annealed) can easily be bent with hands.
- 1/2H-materials (Drawn) are considerably stronger than O-material (Annealed) at the same thickness.

### 2. Types of copper pipes

Maximum working pressure	Refrigerant type
3.45 MPa [500psi]	R22, R407C etc.
4.30 MPa [624psi]	R410A etc.

### 3. Piping materials/Radial thickness

Use refrigerant pipes made of phosphorus deoxidized copper.  
 The operation pressure of the units that use R410A is higher than that of the units that use R22.  
 Use pipes that have at least the radial thickness specified in the chart below.  
 (Pipes with a radial thickness of 0.7 mm or less may not be used.)

Pipe size (mm[in])	Radial thickness (mm)	Type
ø6.35 [1/4"]	0.8t	O-material (Annealed)
ø9.52 [3/8"]	0.8t	
ø12.7 [1/2"]	0.8t	
ø15.88 [5/8"]	1.0t	
ø19.05 [3/4"]	1.0t	1/2H-material, H-material (Drawn)
ø22.2 [7/8"]	1.0t	
ø25.4 [1"]	1.0t	
ø28.58 [1-1/8"]	1.0t	
ø31.75 [1-1/4"]	1.1t	
ø34.93 [1-3/8"]	1.2t	
ø41.28 [1-5/8"]	1.4t	

- Annealed pipes have been used for older model units when a diameter of the pipe is up to ø19.05 (3/4"). For a system that uses R410A, use pipes that are made with 1/2H-material (Drawn). (Annealed pipes may be used for pipes with a diameter of ø19.05 (3/4") and a radial thickness of 1.2 t).
- The figures in the radial thickness column are based on the Japanese standards and provided only as a reference. Use pipes that meet the local standards.

**4. Thickness and refrigerant type indicated on the piping materials**

Ask the pipe manufacturer for the symbols indicated on the piping material for new refrigerant.

**5. Flare processing (O-material (Annealed) and OL-material only)**

The flare processing dimensions for the pipes that are used in the R410A system are larger than those in the R22 system.

Flare processing dimensions (mm[in])

Pipe size (mm[in])	A dimension (mm)	
	R410A	R22, R407C
ø6.35 [1/4"]	9.1	9.0
ø9.52 [3/8"]	13.2	13.0
ø12.7 [1/2"]	16.6	16.2
ø15.88 [5/8"]	19.7	19.4
ø19.05 [3/4"]	24.0	23.3

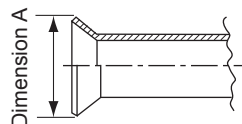

If a clutch-type flare tool is used to flare the pipes in the system using R410A, the length of the pipes must be between 1.0 and 1.5 mm. For margin adjustment, a copper pipe gauge is necessary.

**6. Flare nut**

The flare nut type has been changed to increase the strength. The size of some of the flare nuts have also been changed.

Flare nut dimensions (mm[in])

Pipe size (mm[in])	B dimension (mm)	
	R410A	R22, R407C
ø6.35 [1/4"]	17.0	17.0
ø9.52 [3/8"]	22.0	22.0
ø12.7 [1/2"]	26.0	24.0
ø15.88 [5/8"]	29.0	27.0
ø19.05 [3/4"]	36.0	36.0

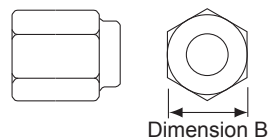

The figures in the radial thickness column are based on the Japanese standards and provided only as a reference. Use pipes that meet the local standards.

## 1-2-2 Storage of Piping Materials

### 1. Storage location



Store the pipes to be used indoors. (Warehouse at site or owner's warehouse)  
If they are left outdoors, dust, dirt, or moisture may infiltrate and contaminate the pipe.

### 2. Sealing the pipe ends

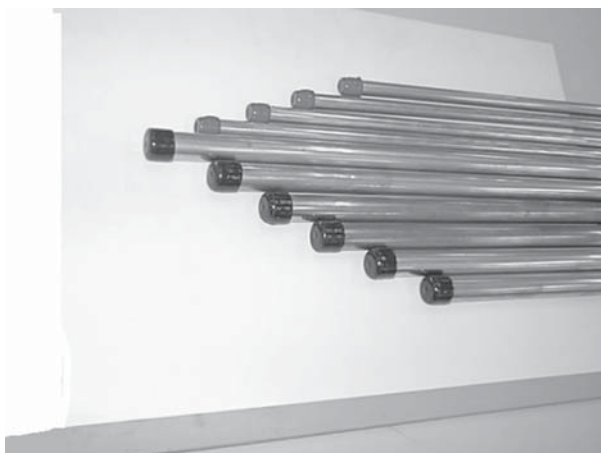

Both ends of the pipes should be sealed until just before brazing.  
Keep elbow pipes and T-joints in plastic bags.

The new refrigerator oil is 10 times as hygroscopic as the conventional refrigerating machine oil (such as Suniso) and, if not handled with care, could easily introduce moisture into the system. Keep moisture out of the pipes, for it will cause the oil to deteriorate and cause a compressor failure.

## 1-2-3 Pipe Processing

Use a small amount of ester oil, ether oil, or alkylbenzene to coat flares and flanges.

### Note

- Use a minimum amount of oil.
- Use only ester oil, ether oil, and alkylbenzene.



## 1-2-4 Characteristics of the New and Conventional Refrigerants

### 1. Chemical property

As with R22, the new refrigerant (R410A) is low in toxicity and chemically stable nonflammable refrigerant. However, because the specific gravity of vapor refrigerant is greater than that of air, leaked refrigerant in a closed room will accumulate at the bottom of the room and may cause hypoxia. If exposed to an open flame, refrigerant will generate poisonous gases. Do not perform installation or service work in a confined area.

	New Refrigerant (HFC type)		Conventional Refrigerant (HCFC type)
	R410A	R407C	R22
	R32/R125	R32/R125/R134a	R22
Composition (wt%)	(50/50)	(23/25/52)	(100)
Type of Refrigerant	Pseudo-azeotropic Refrigerant	Non-azeotropic Refrigerant	Single Refrigerant
Chloride	Not included	Not included	Included
Safety Class	A1/A1	A1/A1	A1
Molecular Weight	72.6	86.2	86.5
Boiling Point (°C/°F)	-51.4/-60.5	-43.6/-46.4	-40.8/-41.4
Steam Pressure (25°C,MPa/77°F,psi) (gauge)	1.557/226	0.9177/133	0.94/136
Saturated Steam Density (25°C,kg/m <sup>3</sup> /77°F,psi)	64.0	42.5	44.4
Flammability	Nonflammable	Nonflammable	Nonflammable
Ozone Depletion Coefficient (ODP) <sup>*1</sup>	0	0	0.055
Global Warming Coefficient (GWP) <sup>*2</sup>	2090	1774	1810
Refrigerant Charging Method	Refrigerant charging in the liquid state	Refrigerant charging in the liquid state	Refrigerant charging in the gaseous state
Replenishment of Refrigerant after a Refrigerant Leak	Available	Available	Available

\*1 When CFC11 is used as a reference

\*2 When CO<sub>2</sub> is used as a reference

### 2. Refrigerant composition

R410A is a pseudo-azeotropic HFC blend and can almost be handled the same way as a single refrigerant, such as R22. To be safe, however, draw out the refrigerant from the cylinder in the liquid phase. If the refrigerant in the gaseous phase is drawn out, the composition of the remaining refrigerant will change and become unsuitable for use.

If the refrigerant leaks out, it may be replenished. The entire refrigerant does not need to be replaced.

### 3. Pressure characteristics

The pressure in the system using R410A is 1.6 times as great as that in the system using R22.

Temperature (°C/°F)	Pressure (gauge)		
	R410A	R407C	R22
	MPa/psi	MPa/psi	MPa/psi
-20/-4	0.30/44	0.18/26	0.14/20
0/32	0.70/102	0.47/68	0.40/58
20/68	1.34/194	0.94/136	0.81/117
40/104	2.31/335	1.44/209	1.44/209
60/140	3.73/541	2.44/354	2.33/338
65/149	4.17/605	2.75/399	2.60/377

## 1-2-5 Refrigerant Oil

### 1. Refrigerating machine oil in the HFC refrigerant system

HFC type refrigerants use a refrigerating machine oil different from that used in the R22 system. Note that the ester oil used in the system has properties that are different from commercially available ester oil.

Refrigerant	Refrigerating machine oil
R22	Mineral oil
R407C	Ester oil
R410A	Ester oil

### 2. Effects of contaminants \*1

Refrigerating machine oil used in the HFC system must be handled with special care to keep contaminants out. The table below shows the effect of contaminants in the refrigerating machine oil on the refrigeration cycle.

### 3. The effects of contaminants in the refrigerating machine oil on the refrigeration cycle.

Cause		Symptoms	Effects on the refrigerant cycle
Water infiltration		Frozen expansion valve and capillary tubes	Clogged expansion valve and capillary tubes Poor cooling performance Compressor overheat Motor insulation failure Burnt motor Coppering of the orbiting scroll Lock Burn-in on the orbiting scroll
		Hydrolysis	
Air infiltration		Oxidization	
Infiltration of contaminants	Dust, dirt	Adhesion to expansion valve and capillary tubes	Clogged expansion valve, capillary tubes, and drier Poor cooling performance Compressor overheat
		Infiltration of contaminants into the compressor	Burn-in on the orbiting scroll
	Mineral oil etc.	Sludge formation and adhesion	Clogged expansion valve and capillary tubes Poor cooling performance Compressor overheat
		Oil degradation	Burn-in on the orbiting scroll

\*1. Contaminants is defined as moisture, air, processing oil, dust/dirt, wrong types of refrigerant, and refrigerating machine oil.

---

## 1-3 Working with Refrigerant Piping

---

### 1-3-1 Pipe Brazing

---

---

No changes have been made in the brazing procedures. Perform brazing with special care to keep foreign objects (such as oxide scale, water, and dust) out of the refrigerant system.

Example: Inside the brazed connection

Use of no inert gas during brazing

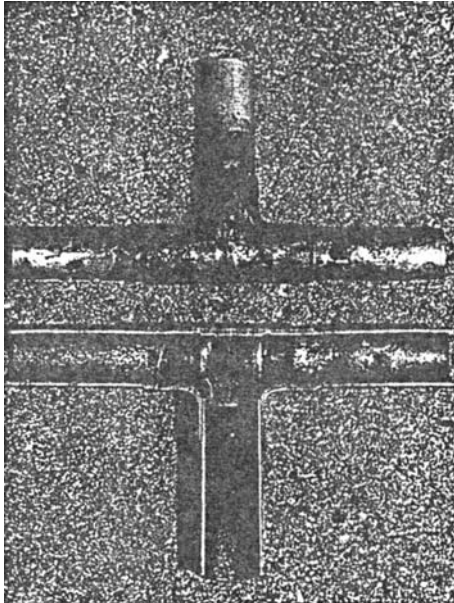

Use of inert gas during brazing

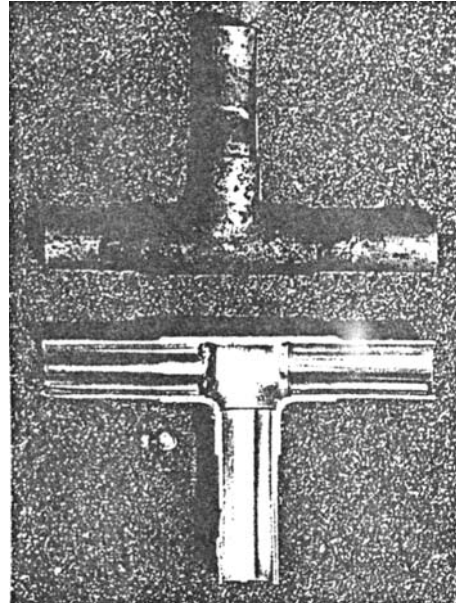

#### 1. Items to be strictly observed

- Do not conduct refrigerant piping work outdoors if raining.
- Use inert gas during brazing.
- Use a brazing material (BCuP-3) that requires no flux when brazing between copper pipes or between a copper pipe and copper coupling.
- If installed refrigerant pipes are not immediately connected to the equipment, then braze and seal both ends.

#### 2. Reasons

- The new refrigerating machine oil is 10 times as hygroscopic as the conventional oil and is more likely to cause unit failure if water infiltrates into the system.
- Flux generally contains chloride. Residual flux in the refrigerant circuit will cause sludge to form.

#### 3. Notes

Do not use commercially available antioxidants because they may cause the pipes to corrode or refrigerating machine oil to deteriorate.

## 1-3-2 Air Tightness Test

No changes have been made in the detection method. Note that a refrigerant leak detector for R22 will not detect an R410A leak.

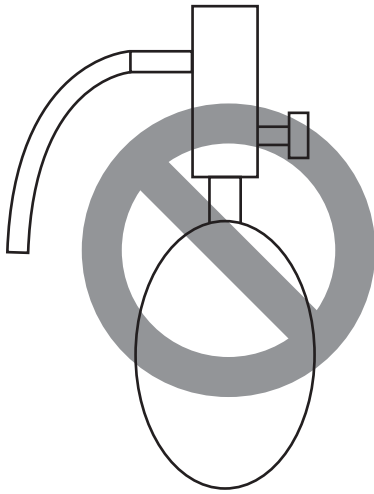

Halide torch

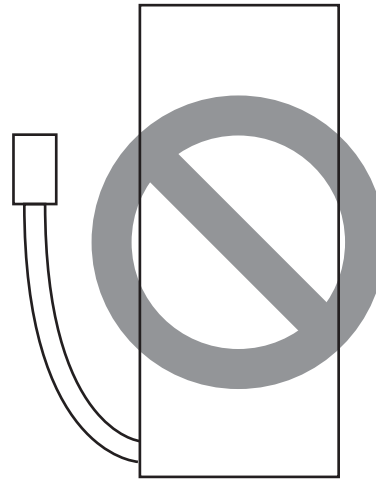

R22 leakage detector

### 1. Items to be strictly observed

- Pressurize the equipment with nitrogen up to the design pressure (4.15MPa[601psi]), and then judge the equipment's air tightness, taking temperature variations into account.
- Refrigerant R410A must be charged in its liquid state (vs. gaseous state).

### 2. Reasons

- Oxygen, if used for an air tightness test, poses a risk of explosion. (Only use nitrogen to check air tightness.)
- Refrigerant R410A must be charged in its liquid state. If gaseous refrigerant in the cylinder is drawn out first, the composition of the remaining refrigerant in the cylinder will change and become unsuitable for use.

### 3. Notes

Procure a leak detector that is specifically designed to detect an HFC leak. A leak detector for R22 will not detect an HFC(R410A) leak.

## 1-3-3 Vacuum Drying



(Photo1) 15010H



(Photo2) 14010

Recommended vacuum gauge:  
ROBINAIR 14010 Thermistor Vacuum Gauge

### 1. Vacuum pump with a reverse-flow check valve (Photo1)

To prevent the vacuum pump oil from flowing into the refrigerant circuit during power OFF or power failure, use a vacuum pump with a reverse-flow check valve.  
A reverse-flow check valve may also be added to the vacuum pump currently in use.

### 2. Standard of vacuum degree (Photo 2)

Use a vacuum pump that attains 0.5Torr(65Pa) or lower degree of vacuum after 5 minutes of operation, and connect it directly to the vacuum gauge. Use a pump well-maintained with an appropriate lubricant. A poorly maintained vacuum pump may not be able to attain the desired degree of vacuum.

### 3. Required precision of vacuum gauge

Use a vacuum gauge that registers a vacuum degree of 5Torr(650Pa) and measures at intervals of 1Torr(130Pa). (A recommended vacuum gauge is shown in Photo2.)  
Do not use a commonly used gauge manifold because it cannot register a vacuum degree of 5Torr(650Pa).

### 4. Evacuation time

- After the degree of vacuum has reached 5Torr(650Pa), evacuate for an additional 1 hour. (A thorough vacuum drying removes moisture in the pipes.)
- Verify that the vacuum degree has not risen by more than 1Torr(130Pa) 1hour after evacuation. A rise by less than 1Torr(130Pa) is acceptable.
- If the vacuum is lost by more than 1Torr(130Pa), conduct evacuation, following the instructions in section 6. Special vacuum drying.

### 5. Procedures for stopping vacuum pump

To prevent the reverse flow of vacuum pump oil, open the relief valve on the vacuum pump side, or draw in air by loosening the charge hose, and then stop the operation.  
The same procedures should be followed when stopping a vacuum pump with a reverse-flow check valve.

### 6. Special vacuum drying

- When 5Torr(650Pa) or lower degree of vacuum cannot be attained after 3 hours of evacuation, it is likely that water has penetrated the system or that there is a leak.
- If water infiltrates the system, break the vacuum with nitrogen. Pressurize the system with nitrogen gas to 0.5kgf/cm<sup>2</sup>G(0.05MPa) and evacuate again. Repeat this cycle of pressurizing and evacuation either until the degree of vacuum below 5Torr(650Pa) is attained or until the pressure stops rising.
- Only use nitrogen gas for vacuum breaking. (The use of oxygen may result in an explosion.)

**1-3-4 Refrigerant Charging**

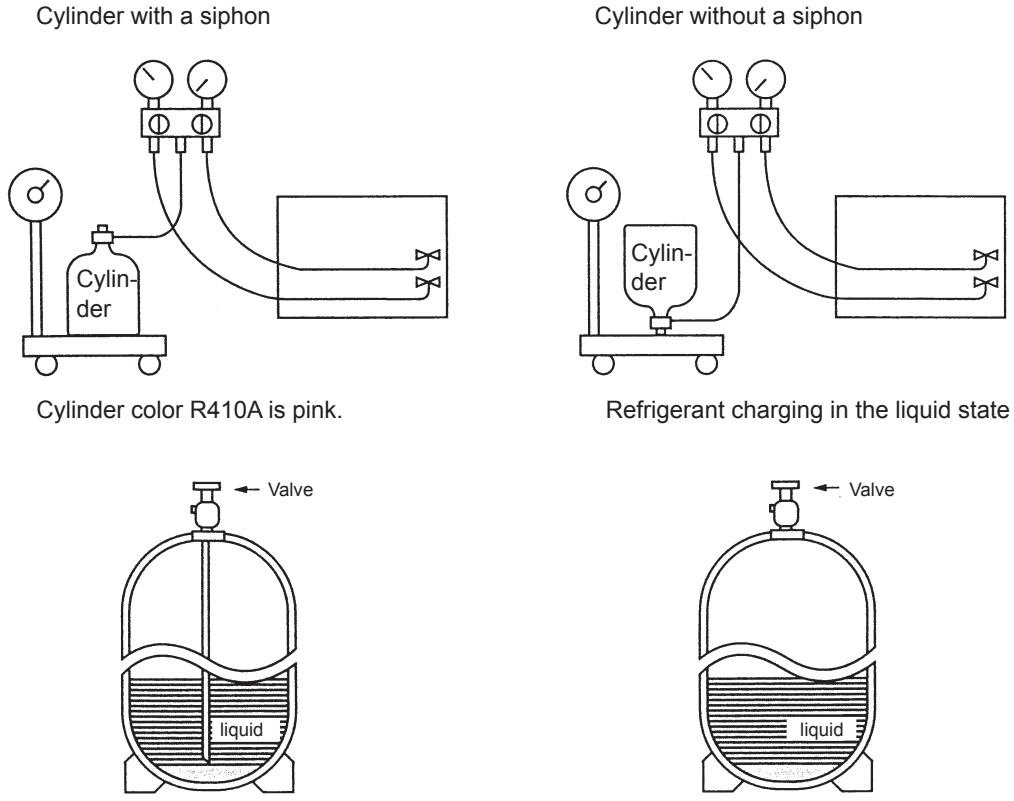

**1. Reasons**

R410A is a pseudo-azeotropic HFC blend (boiling point R32=-52°C[-62°F], R125=-49°C[-52°F]) and can almost be handled the same way as a single refrigerant, such as R22. To be safe, however, draw out the refrigerant from the cylinder in the liquid phase. If the refrigerant in the gaseous phase is drawn out, the composition of the remaining refrigerant will change and become unsuitable for use.

**2. Notes**

When using a cylinder with a siphon, refrigerant is charged in the liquid state without the need for turning it upside down. Check the type of the cylinder on the label before use.

If the refrigerant leaks out, it may be replenished. The entire refrigerant does not need to be replaced. (Charge refrigerant in the liquid state.)

Refer to the following page(s).[8-11 Measures for Refrigerant Leakage](page 281)

## 1-4 Precautions for Wiring

- Control boxes house high-voltage and high-temperature electrical parts.
- They may still remain energized or hot after the power is turned off.
- When opening or closing the front cover of the control box, keep out of contact with the internal parts.  
Before inspecting the inside of the control box, turn off the power, leave the unit turned off for at least 10 minutes, and check that the voltage of the electrolytic capacitor (inverter main circuit) has dropped to 20 VDC or less.  
It will take approximately 10 minutes until the voltage is discharged after power off.
- Disconnect the outdoor unit fan board connector (CNINV) before performing maintenance work.  
Before connecting or disconnecting the connector, check that the outdoor unit fan is stopped and that the voltage of the main circuit capacitor has dropped to 20 VDC or below.  
If the outdoor unit fan is rotated by external forces such as strong winds, the main circuit capacitor can be charged and cause an electric shock.  
Refer to the wiring nameplate for details.  
Reconnect the connector (CNINV) to the fan board after completion of maintenance work.
- When the power is on, the compressor or heater is energized even while the compressor is stopped.  
It is energized to evaporate the liquid refrigerant that has accumulated in the compressor.
- Before connecting wiring to TB7, check that the voltage has dropped below 20 VDC.
- When a system controller is connected to the centralized control transmission cable to which power is supplied from the outdoor unit (power jumper on the outdoor unit is connected to CN40), be aware that power can be supplied to the centralized control transmission and the system controller may detect an error and send an error notice if the outdoor unit fan is rotated by external forces, such as strong winds, even when power to the outdoor unit is turned off.
- When replacing the internal electrical components of the control box, tighten the screws to the recommended tightening torque as specified below.

Recommended tightening torque for the internal electrical components of the control box

Screw	Recommended tightening torque (N·m)
M3	0.69
M4	1.47
M5	2.55
M6	2.75
M8	6.20

\*1 When replacing semiconductor modules (e.g., diode stack, IPM, INV board (with IPM), fan board (with IPM)), apply heat-sink silicone evenly to the mounting surface of the semiconductor module (or the semiconductor module on the back of the circuit board). Next, tighten the screws holding the semiconductor module to one-third of the specified torque, and then tighten the screws to the specified torque.

\*2 Deviating from the recommended tightening torque may cause damage to the unit or its parts.

Take the following steps to ensure that the screws are properly tightened.

- 1) Ensure that the spring washers are parallel to the terminal block.

Even if the tightening torque is observed, if the washers are not parallel to the terminal block, then the semiconductor module is not installed properly.

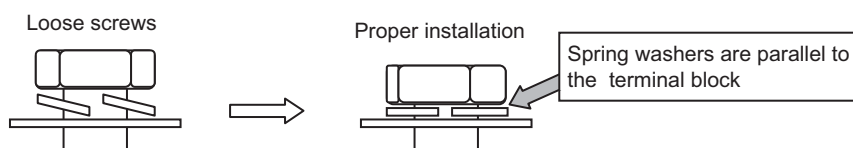

2) Check the wires are securely fastened to the screw terminals.

• **Screw the screws straight down so as not to damage the screw threads.**

Hold the two round terminals back to back to ensure that the screw will screw down straight.

• **After tightening the screw, mark a line through the screw head, washer, and terminals with a permanent marker.**

Example

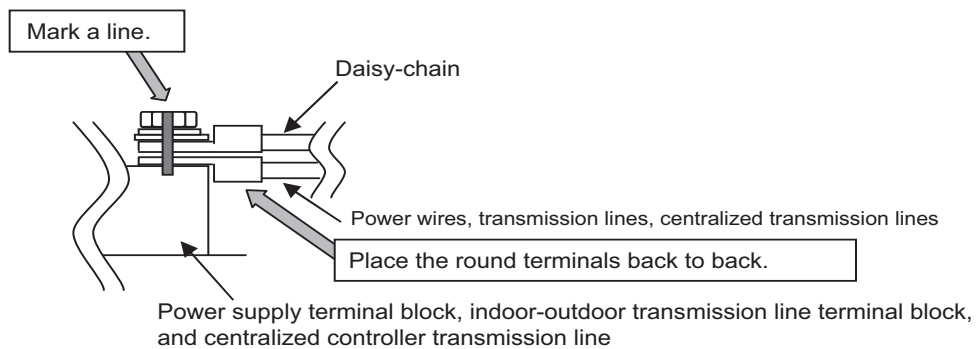

Poor contact caused by loose screws may result in overheating and fire.  
Continued use of the damaged circuit board may cause overheating and fire.



## **1-5 Cautionary notes on installation environment and maintenance**

---

Salt-resistant unit is resistant to salt corrosion, but not salt-proof. Please note the following when installing and maintaining outdoor units in marine atmosphere.

- 1) Install the salt-resistant unit out of direct exposure to sea breeze, and minimize the exposure to salt water mist.
- 2) Avoid installing a sun shade over the outdoor unit, so that rain will wash away salt deposits off the unit.
- 3) Install the unit horizontally to ensure proper water drainage from the base of the unit. Accumulation of water in the base of the outdoor unit will significantly accelerate corrosion.
- 4) Periodically wash salt deposits off the unit, especially when the unit is installed in a coastal area.
- 5) Repair all noticeable scratches after installation and during maintenance.
- 6) Periodically check the unit, and apply anti-rust agent and replace corroded parts as necessary.

---

## Chapter 2 Restrictions

<b>2-1</b>	<b>System Configurations</b> .....	<b>19</b>
<b>2-2</b>	<b>Types and Maximum Allowable Length of Cables</b> .....	<b>20</b>
<b>2-3</b>	<b>Switch Settings</b> .....	<b>21</b>
<b>2-4</b>	<b>M-NET Address Settings</b> .....	<b>22</b>
2-4-1	Address Settings List .....	22
2-4-2	Outdoor Unit Power Jumper Connector Connection.....	23
2-4-3	Outdoor Unit Centralized Controller Switch Setting .....	23
2-4-4	Room Temperature Detection Position Selection .....	23
2-4-5	Start/Stop Control of Indoor Units .....	24
2-4-6	Miscellaneous Settings .....	24
2-4-7	Various Control Methods Using the Signal Input/Output Connector on Outdoor Unit .....	25
<b>2-5</b>	<b>Demand Control Overview</b> .....	<b>28</b>
<b>2-6</b>	<b>System Connection Example</b> .....	<b>30</b>
<b>2-7</b>	<b>Example System with an MA Remote Controller</b> .....	<b>32</b>
2-7-1	Single Refrigerant System (Automatic Indoor/Outdoor Address Startup).....	32
2-7-2	Single Refrigerant System with Two or More LOSSNAY Units .....	34
2-7-3	Grouped Operation of Units in Separate Refrigerant Circuits.....	36
2-7-4	System with a Connection of System Controller to Centralized Control Transmission Line.....	38
2-7-5	System with a Connection of System Controller to Indoor-Outdoor Transmission Line .....	40
<b>2-8</b>	<b>Example System with an ME Remote Controller</b> .....	<b>42</b>
2-8-1	System with a Connection of System Controller to Centralized Control Transmission Line.....	42
<b>2-9</b>	<b>Example System with an MA and an ME Remote Controller</b> .....	<b>44</b>
2-9-1	System with a Connection of System Controller to Centralized Control Transmission Line.....	44
<b>2-10</b>	<b>Restrictions on Refrigerant Pipes</b> .....	<b>46</b>
2-10-1	Restrictions on Refrigerant Pipe Length .....	46
2-10-2	Restrictions on Refrigerant Pipe Size .....	49



## 2-1 System Configurations

### 1. Table of compatible indoor units

#### (1) High COP combinations

The table below summarizes the types of indoor units that are compatible with different types of outdoor units.

Outdoor units		Composing units			Maximum total capacity of connectable indoor units	Maximum number of connectable indoor units	Types of connectable indoor units
P200	YKB-A1	-	-	-	100 - 260	17	P15 - P250 models R410A series indoor units
P250	YKB-A1	-	-	-	125 - 325	21	
P300	YKB-A1	-	-	-	150 - 390	26	
P350	YKB-A1	-	-	-	175 - 455	30	
P400	YKB-A1	-	-	-	200 - 520	34	
P450	YKB-A1	-	-	-	225 - 585	39	
P500	YKB-A1	-	-	-	250 - 650	43	
P400	YSKB-A1	P200	P200	-	200 - 520	34	
P450	YSKB-A1	P250	P200	-	225 - 585	39	
P500	YSKB-A1	P250	P250	-	250 - 650	43	
P550	YSKB-A1	P300	P250	-	275 - 715	47	
P600	YSKB-A1	P350	P250	-	300 - 780	50	
P650	YSKB-A1	P350	P300	-	325 - 845		
P700	YSKB-A1	P350	P350	-	350 - 910		
P750	YSKB-A1	P400	P350	-	375 - 975		
P800	YSKB-A1	P450	P350	-	400 - 1040		
P850	YSKB-A1	P450	P400	-	425 - 1105		
P900	YSKB-A1	P450	P450	-	450 - 1170		
P950	YSKB-A1	P400	P300	P250	475 - 1235		
P1000	YSKB-A1	P400	P300	P300	500 - 1300		
P1050	YSKB-A1	P400	P350	P300	525 - 1365		
P1100	YSKB-A1	P400	P350	P350	550 - 1430		
P1150	YSKB-A1	P450	P350	P350	575 - 1495		
P1200	YSKB-A1	P450	P400	P350	600 - 1560		
P1250	YSKB-A1	P450	P450	P350	625 - 1625		
P1300	YSKB-A1	P450	P450	P400	650 - 1690		
P1350	YSKB-A1	P450	P450	P450	675 - 1755		

#### Note

- 1) "Maximum total capacity of connectable indoor units" refers to the sum of the numeric values in the indoor unit model names.
- 2) If the total capacity of the indoor units that are connected to a given outdoor unit exceeds the capacity of the outdoor unit, the indoor units will not be able to perform at the rated capacity when they are operated simultaneously. Select a combination of units so that the total capacity of the connected indoor units is at or below the capacity of the outdoor unit whenever possible.

## 2-2 Types and Maximum Allowable Length of Cables

### 1. Wiring work

#### (1) Notes

- 1) Have all electrical work performed by an authorized electrician according to the local regulations and instructions in this manual.
- 2) Install external transmission cables at least 5cm [1-31/32"] away from the power supply cable to avoid noise interference. (Do not put the control cable and power supply cable in the same conduit tube.)
- 3) Provide grounding for the outdoor unit as required.
- 4) Run the cable from the electric box of the indoor or outdoor unit in such way that the box is accessible for servicing.
- 5) Do not connect power supply wiring to the terminal block for transmission cable. Doing so will damage the electronic components on the terminal block.
- 6) Use 2-core shielded cables as transmission cables.

Do not use a single multiple-core cable to connect indoor units that belong to different refrigerant systems. Doing so may result in signal transmission errors and malfunctions..

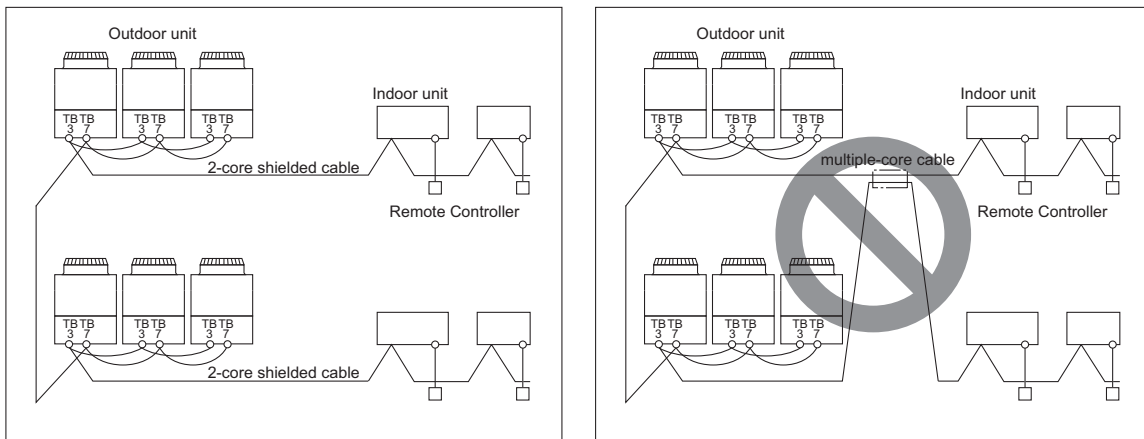

TB3: Terminal block for indoor-outdoor transmission line TB7: Terminal block for centralized control

- 7) When extending the transmission cable, be sure to extend the shield wire.

#### (2) Control wiring

Different types of control wiring are used for different systems. Before performing wiring work, refer to the following page(s).

[2-7 Example System with an MA Remote Controller](page 32)

[2-8 Example System with an ME Remote Controller](page 42)

[2-9 Example System with an MA and an ME Remote Controller](page 44)

#### Types and maximum allowable length of cables

Control lines are categorized into 2 types: transmission line and remote controller line.

Use the appropriate type of cables and observe the maximum allowable length specified for a given system. If a given system has a long transmission line or if a noise source is located near the unit, place the unit away from the noise source to reduce noise interference.

- 1) M-NET transmission line

Cable type	Facility type	All facility types
	Type	Shielded cable CVVS, CPEVS, MVVS
	Number of cores	2-core cable
	Cable size	Larger than 1.25mm <sup>2</sup> [AWG16]
Maximum transmission line distance between the outdoor unit and the farthest indoor unit		200 m [656ft] max.
Maximum transmission line distance for centralized control and Indoor/outdoor transmission line (Maximum line distance via outdoor unit)		500 m [1640ft] max. *The maximum overall line length from the power supply unit on the transmission lines for centralized control to each outdoor unit or to the system controller is 200m [656ft] max.

2) Remote controller wiring

		MA remote controller*1	ME remote controller*2
Cable type	Type	VCTF, VCTFK, CVV, CVS, VVR, VVF, VCT	Shielded cables CVVS, CPEVS, and MVVS
	Number of cores	2-core cable	2-core cable
	Cable size	0.3 to 1.25mm <sup>2</sup> *3 *5 [AWG22 to 16]	0.3 to 1.25mm <sup>2</sup> *3 [AWG22 to 16] (0.75 to 1.25mm <sup>2</sup> ) *4 [AWG18 to 16]
Maximum overall line length		200 m [656ft] max.	The section of the cable that exceeds 10m [32ft] must be included in the maximum indoor-outdoor transmission line distance.

- \*1 MA remote controller refers to MA remote controller (PAR-31MAA, PAR-21MAA), MA simple remote controller, and wireless remote controller.
- \*2 ME remote controller refers to ME remote controller, Compact ME remote controller, and LOSSNAY remote controller.
- \*3 The use of cables that are smaller than 0.75mm<sup>2</sup> (AWG18) is recommended for easy handling.
- \*4 When connected to the terminal block on the Simple remote controller, use cables that meet the cable size specifications shown in the parenthesis.
- \*5 When connecting PAR-31MAA or MA Simple remote controller, use sheathed cables with a minimum thickness of 0.3 mm<sup>2</sup>.

## 2-3 Switch Settings

### 1. Switch setting

The necessary switch settings depend on system configuration. Before performing wiring work, refer to the following page(s).  
 [2-7 Example System with an MA Remote Controller](page 32)  
 [2-8 Example System with an ME Remote Controller](page 42)  
 [2-9 Example System with an MA and an ME Remote Controller](page 44)  
 If the switch settings are changed while the unit is being powered, those changes will not take effect, and the unit will not function properly.

Units on which to set the switches		Symbol	Units to which the power must be shut off
CITY MULTI indoor unit	Main/sub unit	IC	Outdoor units *3 and Indoor units
LOSSNAY, OA processing unit *1		LC	Outdoor units *3 and LOSSNAY
ATW	Booster Unit	BU	Outdoor units and Booster Unit
	Water Hex Unit	AU	Outdoor units and Water Hex Unit
Air handling kit		IC	Outdoor units *3 or field supplied air handling unit
ME remote controller	Main/sub remote controller	RC	Outdoor units *3
MA remote controller *4	Main/sub remote controller	MA	Indoor units
CITY MULTI outdoor unit *2		OC, OS1, OS2	Outdoor units *3 *5

- \*1. Applicable when LOSSNAY units are connected to the indoor-outdoor transmission line.
- \*2. The outdoor units in the same refrigerant circuit are automatically designated as OC, OS1, and OS2 in the order of capacity from large to small (if two or more units have the same capacity, in the order of address from small to large).
- \*3. Turn off the power to all the outdoor units in the same refrigerant circuit.
- \*4. When setting the switch SW4 of the control board, set it with the outdoor unit power on. Refer to the following page(s).  
 [5-1-1 Outdoor Unit Switch Functions and Factory Settings](page 85)

## 2-4 M-NET Address Settings

### 2-4-1 Address Settings List

#### 1. M-NET Address settings

##### (1) Address settings table

The need for address settings and the range of address setting depend on the configuration of the system.

Unit or controller		Address setting range	Setting method	Factory setting
CITY MULTI indoor unit	Main/sub unit	00, 01 to 50 <sup>*1*6</sup>	Assign the smallest address to the main indoor unit in the group, and assign sequential address numbers to the rest of the indoor units in the same group. <sup>*4</sup>	00
M-NET adapter				
M-NET control interface				
Free Plan adapter				
LOSSNAY, OA processing unit Air handling kit		00, 01 to 50 <sup>*1*6</sup>	Assign an arbitrary but unique address to each of these units after assigning an address to all indoor units.	00
ATW	Booster Unit			
	Water Hex Unit			
ME remote controller	Main remote controller	101 to 150	Add 100 to the smallest address of all the indoor units in the same group.	101
	Sub remote controller	151 to 200 <sup>*2</sup>	Add 150 to the smallest address of all the indoor units in the same group.	
MA remote controller		No address settings required. (The main/sub setting must be made if 2 remote controllers are connected to the system.)		Main
CITY MULTI outdoor unit		00, 51 to 100 <sup>*1,*3,*6</sup>	Assign sequential addresses to the outdoor units in the same refrigerant circuit. The outdoor units in the same refrigerant circuit are automatically designated as OC and OS. <sup>*5</sup>	00
System controller	Group remote controller	201 to 250	Assign an address that equals the sum of the smallest group number of the group to be controlled and 200.	201
	System remote controller		Assign an arbitrary but unique address within the range listed on the left to each unit.	
	ON/OFF remote controller		Assign an address that equals the sum of the smallest group number of the group to be controlled and 200.	
	Schedule timer (compatible with M-NET)	Assign an arbitrary but unique address within the range listed on the left to each unit.	202	
	Central controller AE-200 AG-150A GB-50ADA G(B)-50A	000, 201 to 250	Assign an arbitrary but unique address within the range listed on the left to each unit. The address must be set to "000" to control the K-control unit.	000
	LM adapter	201 to 250	Assign an arbitrary but unique address within the range listed on the left to each unit.	247

\*1. Address setting is not required for a City Multi system that consists of a single refrigerant circuit (with some exceptions).

\*2. To set the ME remote controller address to "200", set the rotary switches to "00".

\*3. To set the outdoor unit address to "100," set the rotary switches to "50."

\*4. Some indoor units have 2 or 3 controller boards that require address settings.

No. 2 controller board address must be equal to the sum of the No. 1 controller board address and 1, and the No.3 controller board address must equal to the No. 1 controller address and 2.

\*5. The outdoor units in the same refrigerant circuit are automatically designated as OC, OS1, and OS2 in the order of capacity from large to small (if two or more units have the same capacity, in the order of address from small to large).

\*6. If a given address overlaps any of the addresses that are assigned to other units, use a different, unused address within the setting range.

### 2-4-2 Outdoor Unit Power Jumper Connector Connection

There are limitations on the total number of units that are connectable to each refrigerant system. Refer to the DATABOOK for details.

System configuration	Connection to the system controller	Power supply unit for transmission lines	Group operation of units in a system with multiple outdoor units	Power supply switch connector connection
System with one outdoor unit	–	–	–	Leave CN41 as it is (Factory setting)
System with multiple outdoor units	Not connected	–	Not grouped	Disconnect the male connector from the female power supply switch connector (CN41) and connect it to the female power supply switch connector (CN40) on only one of the outdoor units.*2  *Connect the S (shielded) terminal on the terminal block (TB7) on the outdoor unit whose CN41 was replaced with CN40 to the ground terminal (⌚) on the electric box.
		Not required	Grouped	
	With connection to the indoor unit system	Not required	Grouped/not grouped	
		Not required*1 (Powered from the outdoor unit)	Grouped/not grouped	
With connection to the centralized control system	Required *1	Grouped/not grouped	Leave CN41 as it is (Factory setting)	

\*1 The need for a power supply unit for transmission lines depends on the system configuration. Some controllers, such as GB-50ADA, have a function to supply power to the transmission lines.

\*2 The replacement of the power jumper connector from CN41 to CN40 must be performed on only one outdoor unit in the system.

### 2-4-3 Outdoor Unit Centralized Controller Switch Setting

System configuration	Centralized control switch (SW5-1) settings *1
Connection to the system controller Not connected	Leave it to OFF. (Factory setting)
Connection to the system controller Connected *2	ON

\*1 Set SW5-1 on all outdoor units in the same refrigerant circuit to the same setting.

\*2 When only the LM adapter is connected, leave SW5-1 to OFF (as it is).

### 2-4-4 Room Temperature Detection Position Selection

To stop the fan during heating Thermo-OFF (SW1-7 and 1-8 on the indoor units to be set to ON), use the built-in thermistor on the remote controller or an optional thermistor.

- 1) To use the built-in sensor on the remote controller, set the SW1-1 to ON.

(Factory setting: SW1-1 set to "OFF".)

♦Some models of remote controllers are not equipped with a built-in temperature sensor.

Use the built-in temperature sensor on the indoor unit instead.

♦When using the built-in sensor on the remote controller, install the remote controller where room temperature can be detected.

(Note) Factory setting for SW1-1 on the indoor unit of the All-Fresh Models is ON.

- 2) When an optional temperature sensor is used, set SW1-1 to OFF, and set SW3-8 to ON.

♦When using an optional temperature sensor, install it where room temperature can be detected.



## 2-4-5 Start/Stop Control of Indoor Units

Each indoor unit (or group of indoor units) can be controlled individually by setting SW 1-9 and 1-10.

Function	Operation of the indoor unit when the operation is resumed after the unit was stopped	Setting (SW1) <sup>*4 *5</sup>	
		9	10
Power ON/OFF by the plug <sup>*1,*2,*3</sup>	Indoor unit will go into operation regardless of its operation status before power off (power failure). (In approx. 5 minutes)	OFF	ON
Automatic restoration after power failure	Indoor unit will go into operation if it was in operation when the power was turned off (or cut off due to power failure). (In approx. 5 minutes)	ON	OFF
	Indoor unit will remain stopped regardless of its operation status before power off (power failure).	OFF	OFF

- \*1. Do not shut off power to the outdoor units. Doing so will cut off the power supply to the compressors and the heater on the outdoor units and may result in compressor malfunction when operation is restored after a power failure.
- \*2. Not applicable to units with a built-in drain pump or humidifier.
- \*3. Models with a built-in drain pump cannot be turned on/off by the plug individually. All the units in the same refrigerant circuits will be turned on or off by the plug.
- \*4. Requires that the dipswitch settings for all the units in the group be made.
- \*5. To control the external input to and output from the air conditioners with the PLC software for general equipment via the AE-200,AG-150A, GB-50ADA, or G(B)-50A, set SW1-9 and SW1-10 to ON. With these settings made, the power start-stop function becomes disabled. To use the auto recovery function after power failure while these settings are made, set SW1-5 to ON.

## 2-4-6 Miscellaneous Settings

Cooling-only setting for the indoor unit: Cooling only model (Factory setting: SW3-1 "OFF.")  
 When using indoor unit as a cooling-only unit, set SW3-1 to ON.

## 2-4-7 Various Control Methods Using the Signal Input/Output Connector on Outdoor Unit

### (1) Various connection options

Type	Usage	Function	Terminal to be used <sup>*1</sup>	Option
Input	Prohibiting cooling/heating operation (thermo OFF) by an external input to the outdoor unit. *It can be used as the DEMAND control device for each system.	DEMAND (level)	CN3D <sup>*2</sup>	Adapter for external input (PAC-SC36NA-E)
	Performs a low level noise operation of the outdoor unit by an external input to the outdoor unit. * It can be used as the silent operation device for each refrigerant system.	Low-noise mode (level) <sup>*3*4</sup>		
	Forces the outdoor unit to perform a fan operation by receiving signals from the snow sensor. <sup>*5*7</sup>	Snow sensor signal input (level)	CN3S	
	Cooling/heating operation can be changed by an external input to the outdoor unit.	Auto-changeover	CN3N	
	The operation mode of the unit can be changed from normal cooling operation (performance priority) to energy-saving cooling mode by an external signal input.	Energy-saving mode	CN3K	
Out-put	How to extract signals from the outdoor unit *It can be used as an operation status display device. *It can be used for an interlock operation with external devices.	Operation status of the compressor <sup>*5</sup>	CN51	Adapter for external output (PAC-SC37SA-E)
		Error status <sup>*6*8</sup>		

\*1 For details, refer to section (2) Example of wiring connection.

\*2 For details, refer to section (2) Example of wiring connection and other relevant sections in the manual. [2-5 Demand Control Overview](page 28)

\*3 Low-noise mode is valid when Dip SW6-8 on the outdoor unit is set to OFF. When DIP SW6-8 is set to ON, 4 levels of on-DEMAND are possible, using different configurations of low-noise mode input and DEMAND input settings. When 2 or more outdoor units exist in one refrigerant circuit system, 8 levels of on-DEMAND are possible. When 3 outdoor units exist in one refrigerant circuit system, 12 levels of on-DEMAND are possible.

\*4 By setting Dip SW6-7, the Low-noise mode can be switched between the Capacity priority mode and the Low-noise priority mode.  
When SW6-7 is set to ON: The Low-noise mode always remains effective.  
When SW6-7 is set to OFF: The Low-noise mode is cancelled when certain outside temperature or pressure criteria are met, and the unit goes into normal operation (capacity priority mode).

Low-noise mode is effective		Capacity priority mode becomes effective	
Cooling	Heating	Cooling	Heating
TH7 < 30°C [86°F] and 63HS1 < 32kg/cm <sup>2</sup>	TH7 > 3°C [37°F] and 63LS > 4.6kg/cm <sup>2</sup>	TH7 > 35°C [95°F] or 63HS1 > 35kg/cm <sup>2</sup>	TH7 < 0°C [32°F] or 63LS < 3.9kg/cm <sup>2</sup>

\*5 If multiple outdoor units are connected to the same refrigerant circuit, signal input/output settings need to be made for each outdoor unit.

\*6 Take out signals from the outdoor unit that is designated as OC if multiple outdoor units in the same system.

\*7 If the formula TH7>5 holds true, the fan will not go into operation when the contact receives signal input.

\*8 When using a base heater, change the setting using SW4. When using a base heater, error output will not be available.

**(2) Example of wiring connection**

**⚠ CAUTION**

- 1) Wiring should be covered by insulation tube with supplementary insulation.
- 2) Use relays or switches with IEC or equivalent standard.
- 3) The electric strength between accessible parts and control circuit should have 2750V or more.

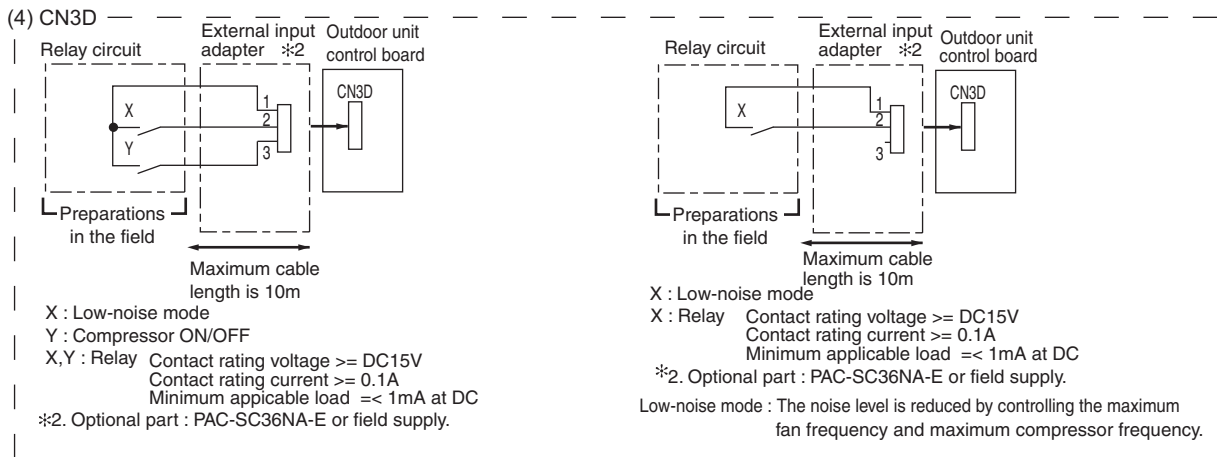
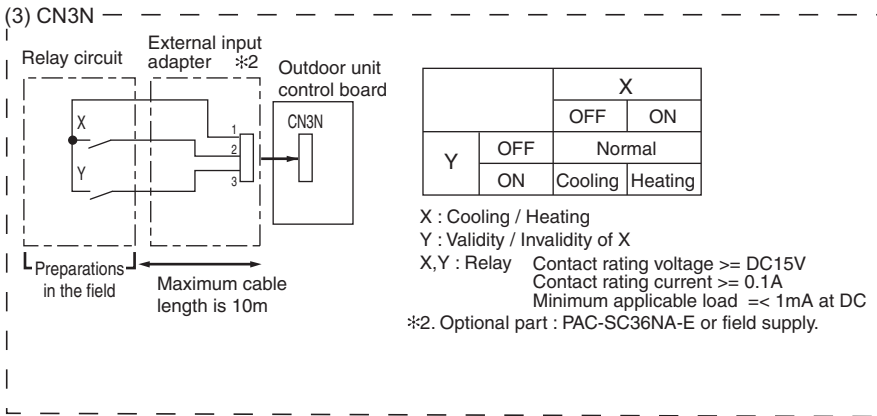
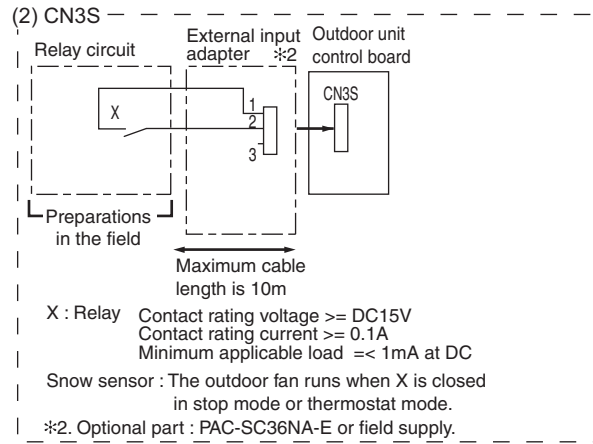
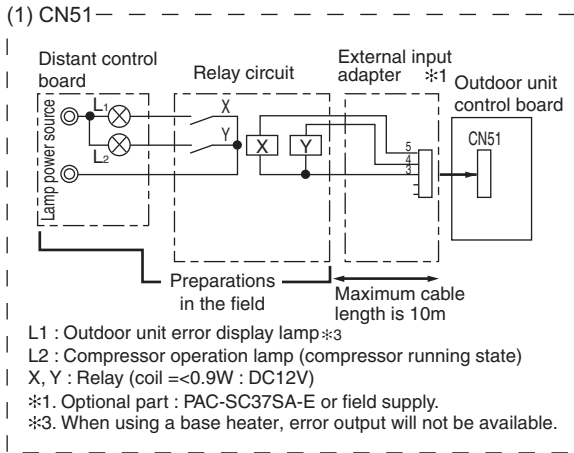

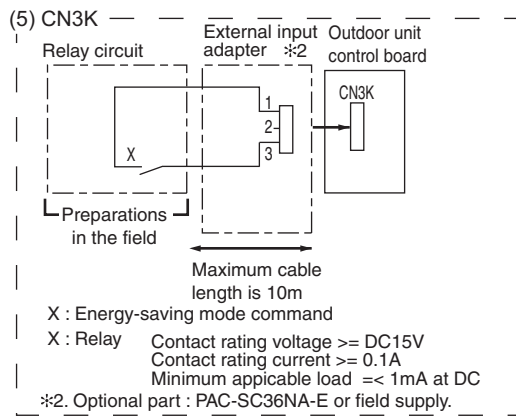

## 2-5 Demand Control Overview

### (1) General outline of control

Demand control is performed by using the external signal input to the 1-2 and 1-3 pins of CN3D on the outdoor units (OC, OS1, and OS2).

Between 2 and 12 steps of demand control is possible by setting DIP SW6-8 on the outdoor units (OC, OS1, and OS2).

No	Demand control switch	DipSW6-8			Input to CN3D *2
		OC	OS1	OS2	
(a)	2 steps(0-100%)	OFF	OFF	OFF	OC
(b)	4 steps(0-50-75-100%)	ON	OFF	OFF	OC
(c)		OFF	ON	OFF	OS1
(d)		OFF	OFF	ON	OS2
(e)	8 steps(0-25-38-50-63-75-88-100%)	ON	ON	OFF	OC and OS1
(f)		ON	OFF	ON	OC and OS2
(g)		OFF	ON	ON	OS1 and OS2
(h)	12 steps(0-17-25-34-42-50-59-67-75-84-92-100%)	ON	ON	ON	OC, OS1, and OS2

\*1. Available demand functions

P200-P500YKB models (single-outdoor-unit system): 2 and 4 steps shown in the rows (a) and (b) in the table above only.

P400-P900YSKB models (two-outdoor-unit system OC+OS1): 2-8 steps shown in the rows (a), (b), (c), and (e) in the table above only.

P950-P1350YSKB models (three-outdoor-unit system OC+OS1+OS2): 2-12 steps shown in the rows (a)-(h) in the table above.

\*2. External signal is input to CN3D on the outdoor unit whose SW6-8 is set to ON. When SW6-8 is set to OFF on all outdoor units, the signal is input to the CN3D on the OC.

Outdoor units whose SW6-8 is set to ON are selectable in a single refrigerant system.

\*3. If wrong sequence of steps are taken, the units may go into the Thermo-OFF (compressor stop) mode.

Ex) When switching from 100% to 50%

(Incorrect) 100% to 0% to 50% : The units may go into the Thermo-OFF mode.

(Correct) 100% to 75% to 50%

\*4. The percentage of the demand listed in the table above is an approximate value based on the compressor volume and does not necessarily correspond with the actual capacity.

\*5. Notes on using demand control in combination with the low-noise mode

To enable the low-noise mode, it is necessary to short-circuit 1-2 pin of CN3D on the outdoor unit whose SW6-8 is set to OFF.

When SW6-8 is set to ON on all outdoor units, the following operations cannot be performed.

- ♦Performing 4-step demand in combination with the low-noise operation in a single-outdoor-unit system.
- ♦Performing 8-step demand in combination with the low-noise operation in a two-outdoor-unit system.
- ♦Performing 12-step demand in combination with the low-noise operation in a three-outdoor-unit system.

### (2) Contact input and control content

1) SW6-8: OFF (Compressor ON/OFF, Low-noise mode)

CN3D 1-3P	Compressor ON/OFF *1
Open	Compressor ON
Close	Compressor OFF

CN3D 1-2P	Low-noise mode*2
Open	OFF
Close	ON

\*1. When SW6-8 on the outdoor unit in one refrigerant circuit system is set to ON , this function cannot be used.

\*2. This function and the 4 levels or 8 levels on-DEMAND function can be used together. Input the order to CN3D 1-2P on the outdoor unit whose SW6-8 is set to OFF.

2) When SW6-8 on one outdoor unit in one refrigerant circuit system is set to ON (4 levels of on-DEMAND) (\*3)

	CN3D 1-2P	
CN3D 1-3P	Open	Short-circuit
Open	100% (No DEMAND)	75%
Short-circuit	0% (Compressor OFF)	50%

\*3. Input the order to CN3D on the outdoor unit whose SW6-8 is set to ON.

Note the following steps to be taken when using the STEP DEMAND

(Example) When switching from 100% to 50%

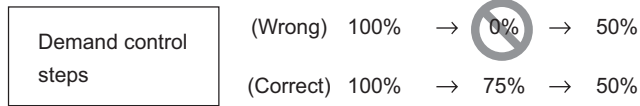

If the step listed as the wrong example above is taken, thermo may go off.  
 The percentage of the demand listed in the table above is an approximate value based on the compressor volume and does not necessarily correspond with the capacity.  
 When this function is enabled, the night mode cannot be enabled.

3) When SW6-8 on the two outdoor units in one refrigerant circuit system is set to ON (8 levels of on-DEMAND) (\*4, \*5)

8 levels of on-DEMAND		No.2 CN3D				
		1-2P	Open		Short-circuit	
No.1 CN3D	1-2P	1-3P	Open	Short-circuit	Open	Short-circuit
	Open	Open	100%	50%	88%	75%
		Short-circuit	50%	0%	38%	25%
	Short-circuit	Open	88%	38%	75%	63%
Short-circuit		75%	25%	63%	50%	

\*4. Input the order to CN3D on the outdoor unit whose SW6-8 is set to ON.

\*5. CN3D of No. 1, 2, 3 can be selected arbitrary with the outdoor unit whose SW6-8 is set to ON.

4) When SW6-8 on the all outdoor units in one refrigerant circuit system is set to ON (12 levels of on-DEMAND) (\*4)

12 levels of on-DEMAND	No.2 CN3D	1-2P	Open							
		1-3P	Open				Short-circuit			
	No.3 CN3D	1-2P	Open		Short-circuit		Open		Short-circuit	
No.1 CN3D	1-2P	1-3P	Open	Short-circuit	Open	Short-circuit	Open	Short-circuit	Open	Short-circuit
	Open	Open	100%	67%	92%	84%	67%	34%	59%	50%
		Short-circuit	67%	34%	59%	50%	34%	0%	25%	17%
	Short-circuit	Open	92%	59%	84%	75%	59%	25%	50%	42%
Short-circuit		84%	50%	75%	67%	50%	17%	42%	34%	

12 levels of on-DEMAND	No.2 CN3D	1-2P	Short-circuit							
		1-3P	Open				Short-circuit			
	No.3 CN3D	1-2P	Open		Short-circuit		Open		Short-circuit	
No.1 CN3D	1-2P	1-3P	Open	Short-circuit	Open	Short-circuit	Open	Short-circuit	Open	Short-circuit
	Open	Open	92%	59%	84%	75%	84%	50%	75%	67%
		Short-circuit	59%	25%	50%	42%	50%	17%	42%	34%
	Short-circuit	Open	84%	50%	75%	67%	75%	42%	67%	59%
Short-circuit		75%	42%	67%	59%	67%	34%	59%	50%	

\*3. Input the order to CN3D on the outdoor unit whose SW6-8 is set to ON.

\*4. CN3D of No. 1, 2, 3 can be selected arbitrary with the outdoor unit whose SW6-8 is set to ON.

## 2-6 System Connection Example

Examples of typical system connection are shown below.  
 Refer to the Installation Manual that came with each device or controller for details.

**(1) An example of a system to which an MA remote controller is connected**

	System configuration	Connection to the system controller	Address start up for indoor and outdoor units	Notes
1	System with one outdoor unit	NO	Automatic address setup	
2	System with one outdoor unit	NO	Manual address setup	Connection of multiple LOSS-NAY units
3	Grouping of units in a system with multiple outdoor units	NO	Manual address setup	
4	System with one outdoor unit	With connection to transmission line for centralized control	Manual address setup	
5	System with one outdoor unit	With connection to indoor-outdoor transmission line	Manual address setup	

**(2) An example of a system to which an ME remote controller is connected**

	System configuration	Connection to the system controller	Address start up for indoor and outdoor units	Notes
1	System with one outdoor unit	With connection to transmission line for centralized control	Manual address setup	

**(3) An example of a system to which both MA remote controller and ME remote controller are connected**

	System configuration	Connection to the system controller	Address start up for indoor and outdoor units	Notes
1	System with one outdoor unit	With connection to transmission line for centralized control	Manual address setup	

\*MA remote controller and ME remote controller cannot both be connected to the same group.





## 2-7 Example System with an MA Remote Controller

### 2-7-1 Single Refrigerant System (Automatic Indoor/Outdoor Address Startup)

#### (1) Sample control wiring

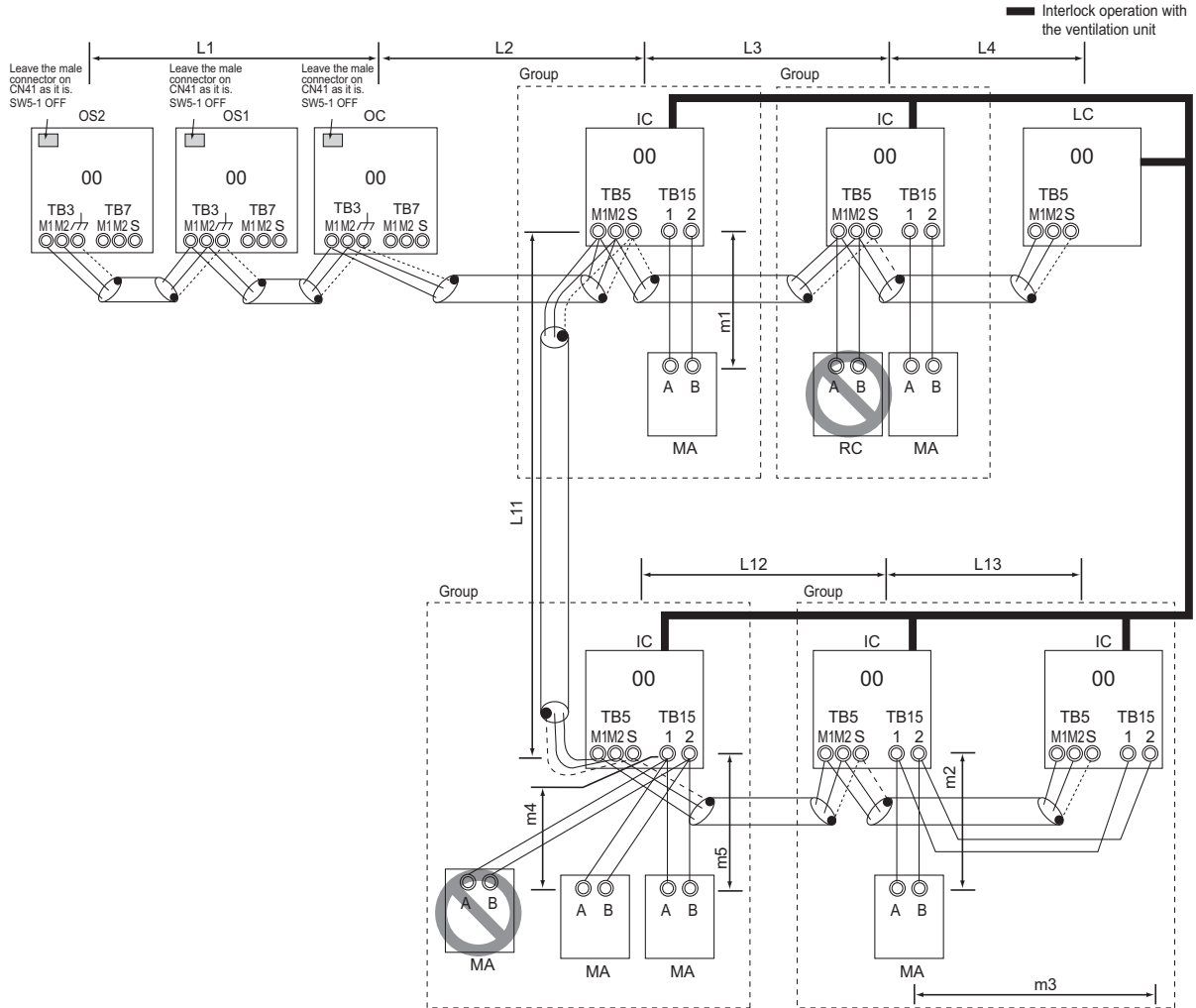

#### (2) Cautions

- 1) ME remote controller and MA remote controller cannot both be connected to the same group of indoor units.
- 2) No more than 2 MA remote controllers can be connected to a group of indoor units.
- 3) A transmission booster is required in a system to which more than 32 indoor units (26 units if one or more indoor units of the 200 model or above is connected) are connected.
- 4) Automatic address setup is not available if start-stop input (CN32, CN51, CN41) is used for a group operation of indoor units or when multiple indoor units with different functions are grouped in the same group. Refer to the following page(s). [2-7-2 Single Refrigerant System with Two or More LOSSNAY Units](page 34)
- 5) For information about connecting two or more LOSSNAY units to a system, refer to the following page(s). [2-7-2 Single Refrigerant System with Two or More LOSSNAY Units](page 34)

#### (3) Maximum allowable length

- 1) Indoor/outdoor transmission line  
 Maximum distance (1.25mm<sup>2</sup> [AWG16] or larger)  
 $L1 + L2 + L3 + L4 \leq 200\text{m} [656\text{ft}]$   
 $L1 + L2 + L11 + L12 + L13 \leq 200\text{m} [656\text{ft}]$
- 2) Transmission line for centralized control  
 No connection is required.
- 3) MA remote controller wiring  
 Maximum overall line length (0.3 to 1.25mm<sup>2</sup> [AWG22 to 16])  
 $m1 \leq 200\text{m} [656\text{ft}]$   
 $m2 + m3 \leq 200\text{m} [656\text{ft}]$   
 $m4 + m5 \leq 200\text{m} [656\text{ft}]$   
 \*When connecting PAR-31MAA or MA Simple remote controller, use sheathed cables with a minimum thickness of 0.3 mm<sup>2</sup>.

**(4) Wiring method**

1) Indoor/outdoor transmission line

Daisy-chain terminals M1 and M2 on the terminal block for indoor-outdoor transmission line (TB3) on the outdoor units (OC, OS1, OS2) (Note), and terminals M1 and M2 on the terminal block for indoor-outdoor transmission line (TB5) on each indoor unit (IC). (Non-polarized two-wire)

•Only use shielded cables.

**Note**

The outdoor units in the same refrigerant circuit are automatically designated as OC, OS1, and OS2 in the order of capacity from large to small (if two or more units have the same capacity, in the order of address from small to large).

**Shielded cable connection**

Daisy-chain the ground terminal (  $\overline{G}$  ) on the outdoor units (OC, OS1, OS2), and the S terminal on the terminal block (TB5) on the indoor unit (IC) with the shield wire of the shielded cable.

2) Transmission line for centralized control

No connection is required.

3) MA remote controller wiring

Connect terminals 1 and 2 on the terminal block for MA remote controller line (TB15) on the indoor unit (IC) to the terminal block on the MA remote controller (MA). (Non-polarized two-wire)

**When 2 remote controllers are connected to the system**

When 2 remote controllers are connected to the system, connect terminals 1 and 2 of the terminal block (TB15) on the indoor unit (IC) to the terminal block on the two MA remote controllers.

•Set one of the MA remote controllers to sub. (Refer to

**(5) Address setting method**

Procedures	Unit or controller			Address setting range	Setting method	Notes	Factory setting
1	Indoor unit	Main unit	IC	No settings required.	-	For information about how to perform a group operation of indoor units that feature different functions, refer to the following page(s). [2-7-2 Single Refrigerant System with Two or More LOSSNAY Units](page 34)	00
		Sub unit	IC				
2	LOSSNAY		LC	No settings required.	-		00
3	MA remote controller	Main remote controller	MA	No settings required.	-		Main
		Sub remote controller	MA	Sub remote controller	Settings to be made according to the remote controller function selection		
4	Outdoor unit (Note)		OC OS1 OS2	No settings required.	-		00

**Note**

The outdoor units in the same refrigerant circuit are automatically designated as OC, OS1, and OS2. The outdoor units are designated as OC, OS1, and OS2 in the order of capacity from large to small (if two or more units have the same capacity, in the order of address from small to large).

MA remote controller function selection or the installation manual for the MA remote controller for the setting method.)

**Group operation of indoor units**

To perform a group operation of indoor units (IC), daisy-chain terminals 1 and 2 on the terminal block (TB15) on all indoor units (IC) in the same group, and then connect terminals 1 and 2 on the terminal block (TB15) on the indoor unit on one end to the terminal block on the MA remote controller. (Non-polarized two-wire)

•When performing a group operation of indoor units that have different functions, "Automatic indoor/outdoor address setup" is not available.

4) LOSSNAY connection

Connect terminals M1 and M2 on the terminal block (TB5) on the indoor unit (IC) to the appropriate terminals on the terminal block (TB5) on LOSSNAY (LC). (Non-polarized two-wire)

•Interlock operation setting with all the indoor units in the same system will automatically be made. (It is required that the Lossnay unit be turned on before the outdoor unit.)

•For information about certain types of systems (1. Systems in which the LOSSNAY unit is interlocked with only part of the indoor units, 2. Systems in which the LOSSNAY unit is operated independently from the indoor units, 3. Systems in which more than 16 indoor units are interlocked with the LOSSNAY unit, and 4. Systems to which two or more LOSSNAY units are connected), refer to the following page(s). [2-7-2 Single Refrigerant System with Two or More LOSSNAY Units](page 34)

5) Switch setting

No address settings required.

## 2-7-2 Single Refrigerant System with Two or More LOSSNAY Units

### (1) Sample control wiring

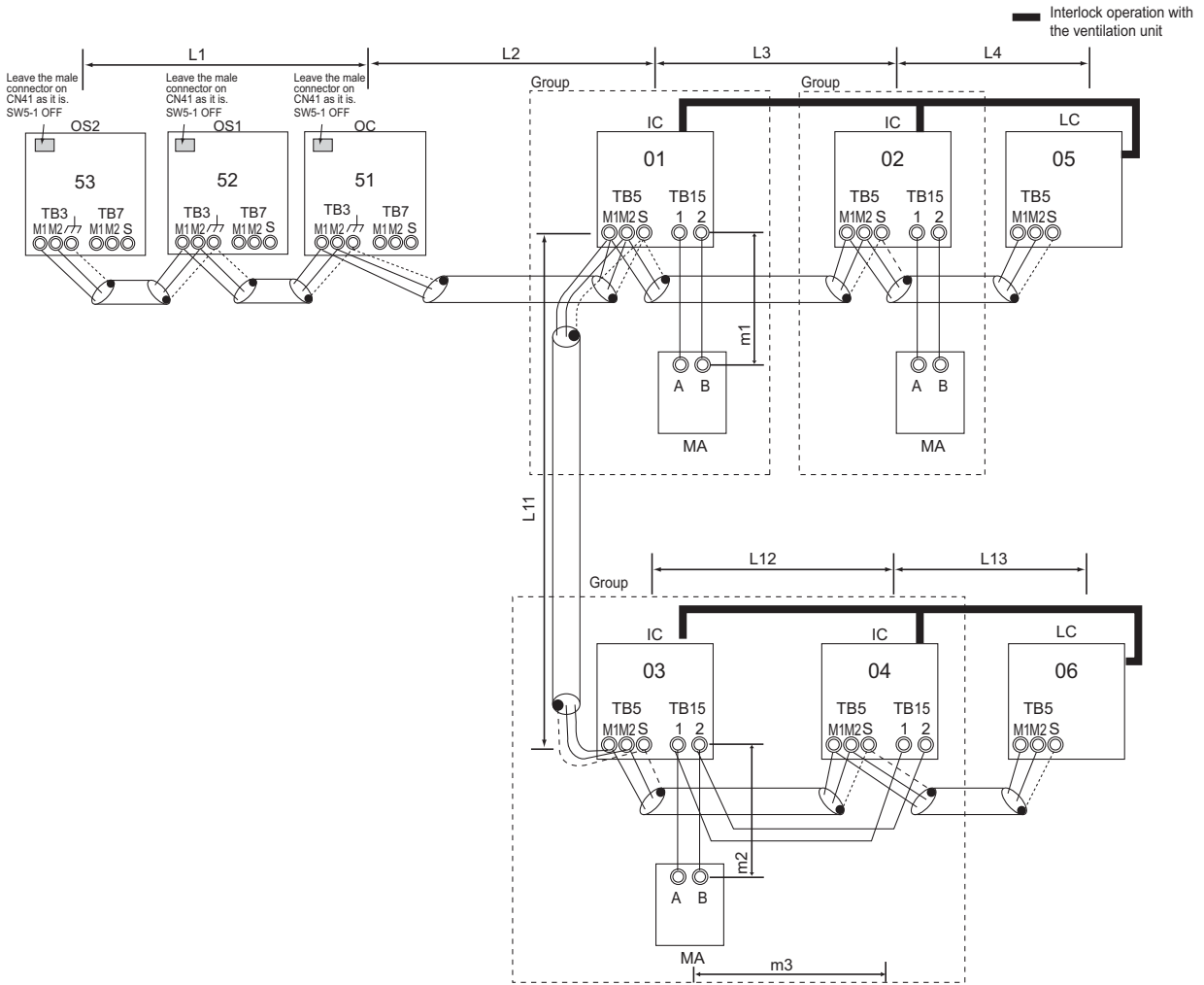

### (2) Cautions

- 1) ME remote controller and MA remote controller cannot both be connected to the same group of indoor units.
- 2) No more than 2 MA remote controllers can be connected to a group of indoor units.
- 3) A transmission booster is required in a system to which more than 32 indoor units (26 units if one or more indoor units of the 200 model or above is connected) are connected.

•Refer to the DATABOOK for further information about how many booster units are required for a given system.

### (3) Maximum allowable length

- 1) Indoor/outdoor transmission line  
Same as 2-7-1
- 2) Transmission line for centralized control  
No connection is required.
- 3) MA remote controller wiring  
Same as 2-7-1

**(4) Wiring method**

1) Indoor/outdoor transmission line

Same as 2-7-1

**Shielded cable connection**

Same as 2-7-1

2) Transmission line for centralized control

No connection is required.

3) MA remote controller wiring

Same as 2-7-1

**When 2 remote controllers are connected to the system**

Same as 2-7-1

**Group operation of indoor units**

Same as 2-7-1

4) LOSSNAY connection

**(5) Address setting method**

Connect terminals M1 and M2 on the terminal block (TB5) on the indoor unit (IC) to the appropriate terminals on the terminal block (TB5) on LOSSNAY (LC). (Non-polarized two-wire)

♦Interlock setting between the indoor units and LOSSNAY units must be entered on the remote controller. For information about how to interlock the operation of indoor and LOSSNAY units, refer to the remote controller Installation Manual and the following page(s) in this Service Handbook.

[6-5 Making Interlock Settings from an MA Remote Controller](page 121)

5) Switch setting

Address setting is required as follows.

Procedures	Unit or controller			Address setting range	Setting method	Notes	Factory setting
1	Indoor unit	Main unit	IC	01 to 50	Assign the smallest address to the main unit in the group.	To perform a group operation of indoor units that have different functions, designate the indoor unit in the group with the greatest number of functions as the main unit.	00
		Sub unit			Assign sequential numbers starting with the address of the main unit in the same group +1. (Main unit address +1, main unit address +2, main unit address +3, etc.)		
2	LOSSNAY		LC	01 to 50	Assign an arbitrary but unique address to each of these units after assigning an address to all indoor units.	None of these addresses may overlap any of the indoor unit addresses.	00
3	MA remote controller	Main remote controller	MA	No settings required.	-		Main
		Sub remote controller	MA	Sub remote controller	Settings to be made according to the remote controller function selection		
4	Outdoor unit		OC OS1 OS2	51 to 100	Assign sequential address to the outdoor units in the same refrigerant circuit. The outdoor units are automatically designated as OC, OS1, and OS2.(Note)	To set the address to 100, set the rotary switches to 50.	00

**Note**

The outdoor units in the same refrigerant circuit are automatically designated as OC, OS1, and OS2.

The outdoor units are designated as OC, OS1, and OS2 in the order of capacity from large to small (if two or more units have the same capacity, in the order of address from small to large).

## 2-7-3 Grouped Operation of Units in Separate Refrigerant Circuits

### (1) Sample control wiring

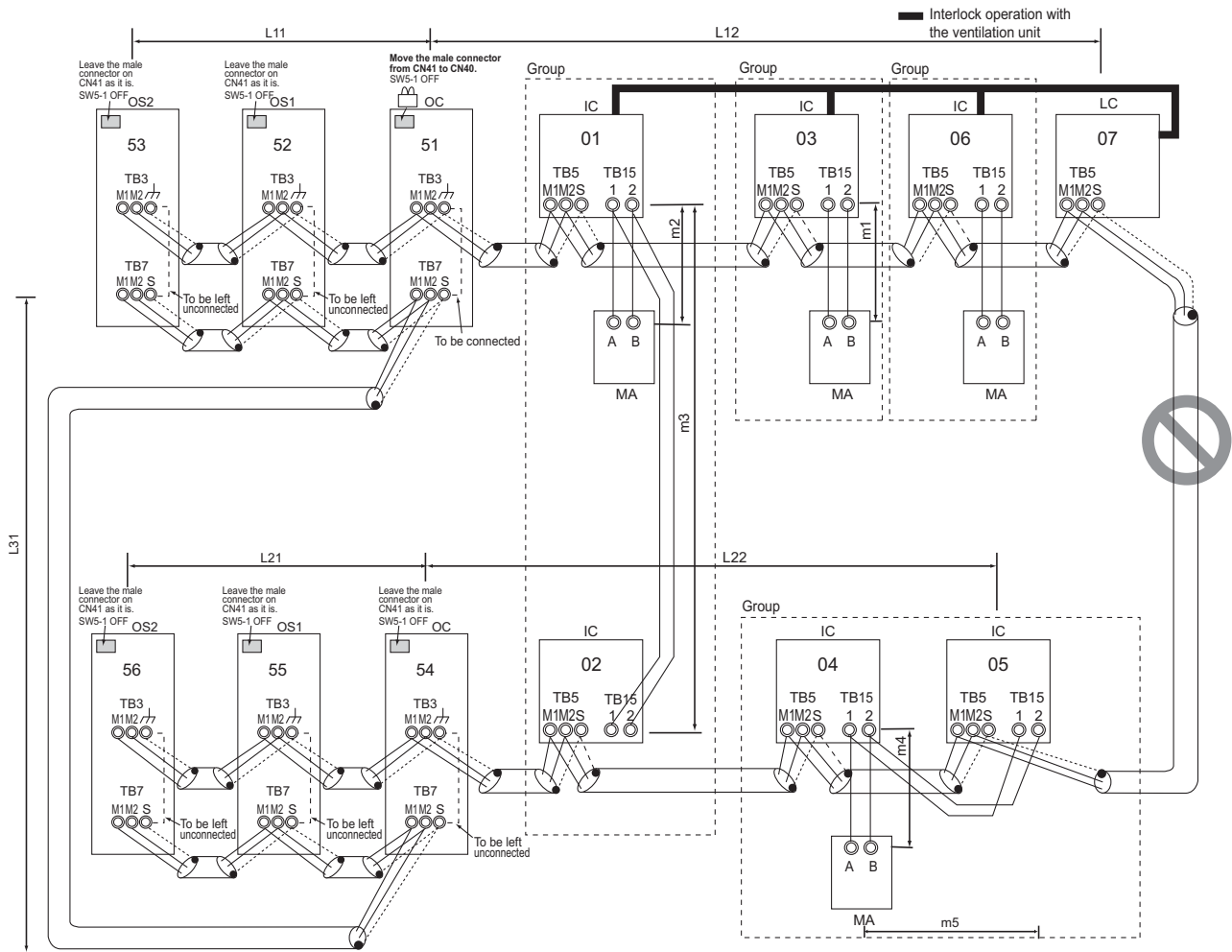

### (2) Cautions

- 1) ME remote controller and MA remote controller can not both be connected to the same group of indoor units.
- 2) No more than 2 MA remote controllers can be connected to a group of indoor units.
- 3) Do not connect the terminal blocks (TB5) on the indoor units that are connected to different outdoor units with each other.
- 4) Replacement of male power jumper connector (CN41) must be performed only on one of the outdoor units.
- 5) Provide grounding to S terminal on the terminal block for transmission line for centralized control (TB7) on only one of the outdoor units.
- 6) A transmission booster is required in a system to which more than 32 indoor units (26 units if one or more indoor units of the 200 model or above is connected) are connected.

•Refer to the DATABOOK for further information about how many booster units are required for a given system.

### (3) Maximum allowable length

- 1) Indoor/outdoor transmission line  
Maximum distance (1.25mm<sup>2</sup> [AWG16] or larger)  
L11+L12 ≤ 200m [656ft]  
L21+L22 ≤ 200m [656ft]
- 2) Transmission line for centralized control  
L21+L31 ≤ 200m [656ft]
- 3) MA remote controller wiring  
Same as 2-7-1
- 4) Maximum line distance via outdoor unit (1.25mm<sup>2</sup> [AWG16] or larger)  
L12(L11)+L31+L22(L21) ≤ 500m [1640ft]

**(4) Wiring method**

- 1) Indoor/outdoor transmission line  
Same as 2-7-1  
•Only use shielded cables.

**Shielded cable connection**

Same as 2-7-1

- 2) Transmission line for centralized control

Daisy-chain terminals M1 and M2 on the terminal block for transmission line for centralized control (TB7) on the outdoor units (OC) in different refrigerant circuits and on the OC, OS1, and OS2 (Note a) in the same refrigerant circuit

If a power supply unit is not connected to the transmission line for centralized control, replace the power jumper connector on the control board from CN41 to CN40 on only one of the outdoor units.

**Note**

- a) The outdoor units in the same refrigerant circuit are automatically designated as OC, OS1, and OS2 in the order of capacity from large to small (if two or more units have the same capacity, in the order of address from small to large).
- b) When not daisy-chaining TB7's on the outdoor units in the same refrigerant circuit, connect the transmission line for centralized control to TB7 on the OC (Note a). To maintain centralized control even during an OC failure or

**(5) Address setting method**

- a power failure, daisy-chain TB7 of OC, OS1, and OS2. (If there is a problem with the outdoor unit whose power jumper was moved from CN41 to CN40, centralized control is not possible, even if TB7's are daisy-chained).
- c) When connecting TB7, only commence after checking that the voltage is below 20 VDC.

•Only use shielded cables.

**Shielded cable connection**

Daisy-chain the S terminal on the terminal block (TB7) on the outdoor units (OC, OS1, OS2) with the shield wire of the shielded cable. Short-circuit the earth terminal (⌚) and the S terminal on the terminal block (TB7) on the outdoor unit whose power jumper connector is mated with CN40.

- 3) MA remote controller wiring

Same as 2-7-1

**When 2 remote controllers are connected to the system**

Same as 2-7-1

**Group operation of indoor units**

Same as 2-7-1

- 4) LOSSNAY connection

Same as 2-7-2

- 5) Switch setting

Address setting is required as follows.

Procedures	Unit or controller			Address setting range	Setting method	Notes	Factory setting
1	Indoor unit	Main unit	IC	01 to 50	Assign the smallest address to the main unit in the group.	To perform a group operation of indoor units that have different functions, designate the indoor unit in the group with the greatest number of functions as the main unit.	00
		Sub unit			Assign sequential numbers starting with the address of the main unit in the same group +1. (Main unit address +1, main unit address +2, main unit address +3, etc.)		
2	LOSSNAY		LC	01 to 50	Assign an arbitrary but unique address to each of these units after assigning an address to all indoor units.	None of these addresses may overlap any of the indoor unit addresses.	00
3	MA remote controller	Main remote controller	MA	No settings required.	-		Main
		Sub remote controller	MA	Sub remote controller	Settings to be made according to the remote controller function selection		
4	Outdoor unit		OC OS1 OS2	51 to 100	Assign sequential address to the outdoor units in the same refrigerant circuit. The outdoor units are automatically designated as OC, OS1, and OS2. (Note)	To set the address to 100, set the rotary switches to 50.	00

**Note**

The outdoor units in the same refrigerant circuit are automatically designated as OC, OS1, and OS2. The outdoor units are designated as OC, OS1, and OS2 in the order of capacity from large to small (if two or more units have the same capacity, in the order of address from small to large).

## 2-7-4 System with a Connection of System Controller to Centralized Control Transmission Line

### (1) Sample control wiring

An example of a system in which a system controller is connected to the transmission cable for the centralized control system and the power is supplied from the outdoor unit

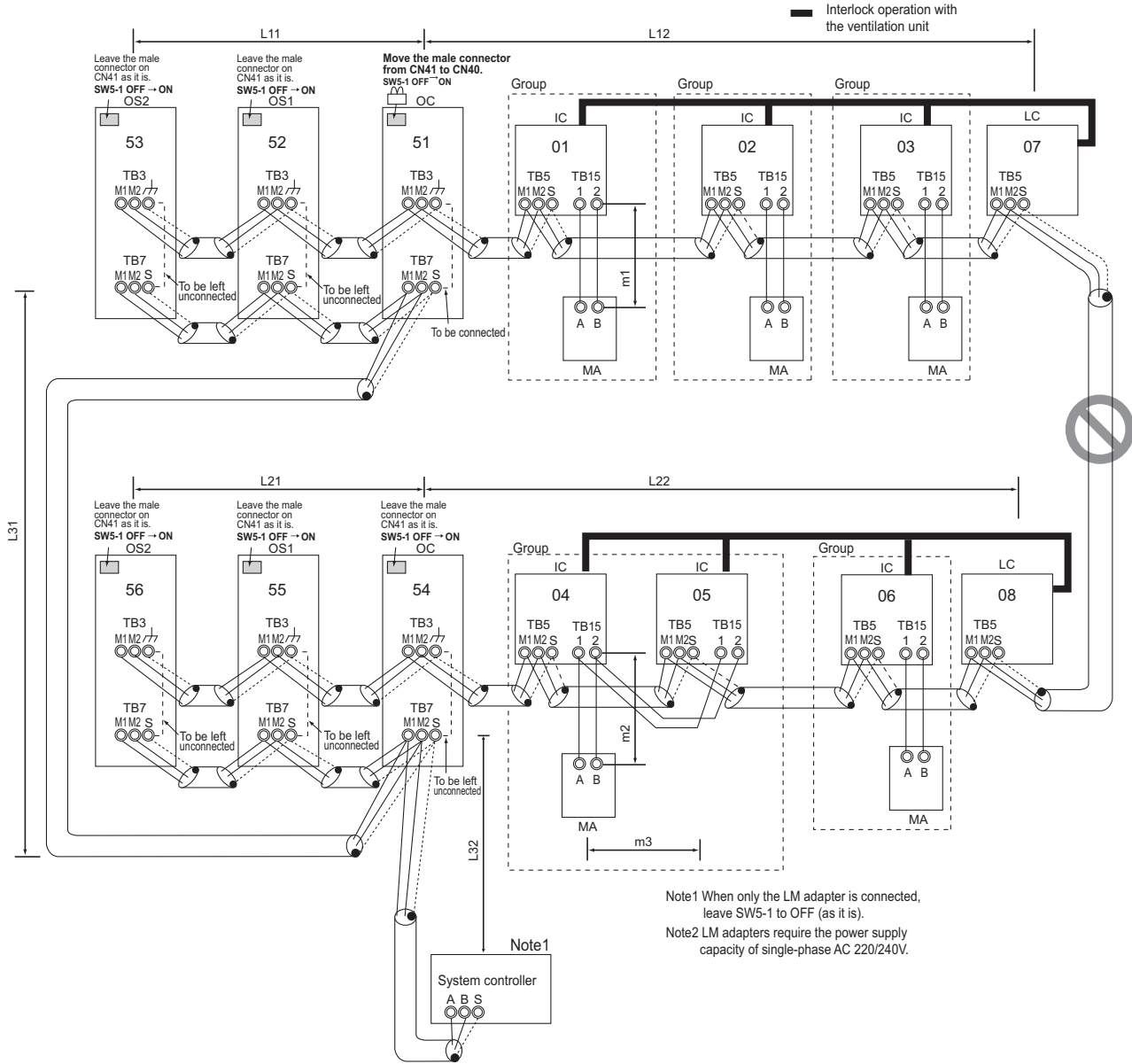

### (2) Cautions

- 1) ME remote controller and MA remote controller cannot both be connected to the same group of indoor units.
- 2) No more than 2 MA remote controllers can be connected to a group of indoor units.
- 3) Do not connect the terminal blocks (TB5) on the indoor units that are connected to different outdoor units with each other.
- 4) Replacement of male power jumper connector (CN41) must be performed only on one of the outdoor units (not required if power to the transmission line for centralized control is supplied from a controller with a power supply function, such as GB-50ADA).
- 5) Short-circuit the shield terminal (S terminal) and the earth terminal (E terminal) on the terminal block for transmission line for centralized control (TB7) on the outdoor unit whose power jumper connector is mated with CN40.
- 6) A transmission booster is required in a system to which more than 32 indoor units (26 units if one or more indoor units of the 200 model or above is connected) are connected.

•Refer to the DATABOOK for further information about how

- 7) many booster units are required for a given system. When a power supply unit is connected to the transmission line for centralized control, leave the power jumper connector on CN41 as it is (factory setting).

### (3) Maximum allowable length

- 1) Indoor/outdoor transmission line  
Same as 2-7-3
- 2) Transmission line for centralized control  
 $L31+L32(L21) \leq 200\text{m}$  [656ft]
- 3) MA remote controller wiring  
Same as 2-7-1
- 4) Maximum line distance via outdoor unit  
(1.25mm<sup>2</sup> [AWG16] or larger)  
 $L32+L31+L12(L11) \leq 500\text{m}$  [1640ft]  
 $L32+L22(L21) \leq 500\text{m}$  [1640ft]  
 $L12(L11)+L31+L22(L21) \leq 500\text{m}$  [1640ft]

**(4) Wiring method**

1) Indoor/outdoor transmission line

Same as 2-7-1

**Shielded cable connection**

Same as 2-7-1

2) Transmission line for centralized control

Daisy-chain terminals A and B on the system controller, terminals M1 and M2 on the terminal block for transmission line for centralized control (TB7) on the outdoor units (OC) in different refrigerant circuits and on the outdoor units (OC, OS1, and OS2) in the same refrigerant circuit. (Note b)

If a power supply unit is not connected to the transmission line for centralized control, replace the power jumper connector on the control board from CN41 to CN40 on only one of the outdoor units.

If a system controller is connected, set the central control switch (SW5-1) on the control board of all outdoor units to "ON."

**Note**

- a) The outdoor units in the same refrigerant circuit are automatically designated as OC, OS1, and OS2 in the order of capacity from large to small (if two or more units have the same capacity, in the order of address from small to large).
- b) When not daisy-chaining TB7's on the outdoor units in the same refrigerant circuit, connect the transmission line for centralized control to TB7 on the OC (Note a). To maintain centralized control even during an OC failure or a power failure, daisy-chain TB7 of OC, OS1, and OS2. (If there is a problem with the outdoor unit whose power jumper was moved from CN41 to CN40, centralized control is not possible, even if TB7's are daisy-chained).

- c) When connecting TB7, only commence after checking that the voltage is below 20 VDC.

•Only use shielded cables.

**Shielded cable connection**

Daisy-chain the S terminal on the terminal block (TB7) on the outdoor units (OC, OS1, OS2) with the shield wire of the shielded cable. Short-circuit the earth terminal (⏏) and the S terminal on the terminal block (TB7) on the outdoor unit whose power jumper connector is mated with CN40.

3) MA remote controller wiring

Same as 2-7-1

**When 2 remote controllers are connected to the system**

Same as 2-7-1

**Group operation of indoor units**

Same as 2-7-1

4) LOSSNAY connection

Connect terminals M1 and M2 on the terminal block (TB5) on the indoor unit (IC) to the appropriate terminals on the terminal block for indoor-outdoor transmission line (TB5) on LOSSNAY (LC). (Non-polarized 2-core cable)

•Indoor units must be interlocked with the LOSSNAY unit using the system controller. (Refer to the operation manual for the system controller for the setting method.) Interlock setting from the remote controller is required if the ON/OFF remote controller alone or the LM adapter alone is connected.

5) Switch setting

Address setting is required as follows.

**(5) Address setting method**

Procedures	Unit or controller			Address setting range	Setting method	Notes	Factory setting
1	Indoor unit	Main unit	IC	01 to 50	Assign the smallest address to the main unit in the group.	To perform a group operation of indoor units that have different functions, designate the indoor unit in the group with the greatest number of functions as the main unit.	00
		Sub unit			Assign sequential numbers starting with the address of the main unit in the same group +1. (Main unit address +1, main unit address +2, main unit address +3, etc.)		
2	LOSSNAY		LC	01 to 50	Assign an arbitrary but unique address to each of these units after assigning an address to all indoor units.	None of these addresses may overlap any of the indoor unit addresses.	00
3	MA remote controller	Main remote controller	MA	No settings required.	-	Enter the same indoor unit group settings on the system controller as the ones that were entered on the MA remote controller.	Main
		Sub remote controller	MA	Sub remote controller	Settings to be made according to the remote controller function selection		
4	Outdoor unit		OC OS1 OS2	51 to 100	Assign sequential address to the outdoor units in the same refrigerant circuit. The outdoor units are automatically designated as OC, OS1, and OS2. (Note)	To set the address to 100, set the rotary switches to 50.	00

**Note**

The outdoor units in the same refrigerant circuit are automatically designated as OC, OS1, and OS2. The outdoor units are designated as OC, OS1, and OS2 in the order of capacity from large to small (if two or more units have the same capacity, in the order of address from small to large).



## 2-7-5 System with a Connection of System Controller to Indoor-Outdoor Transmission Line

### (1) Sample control wiring

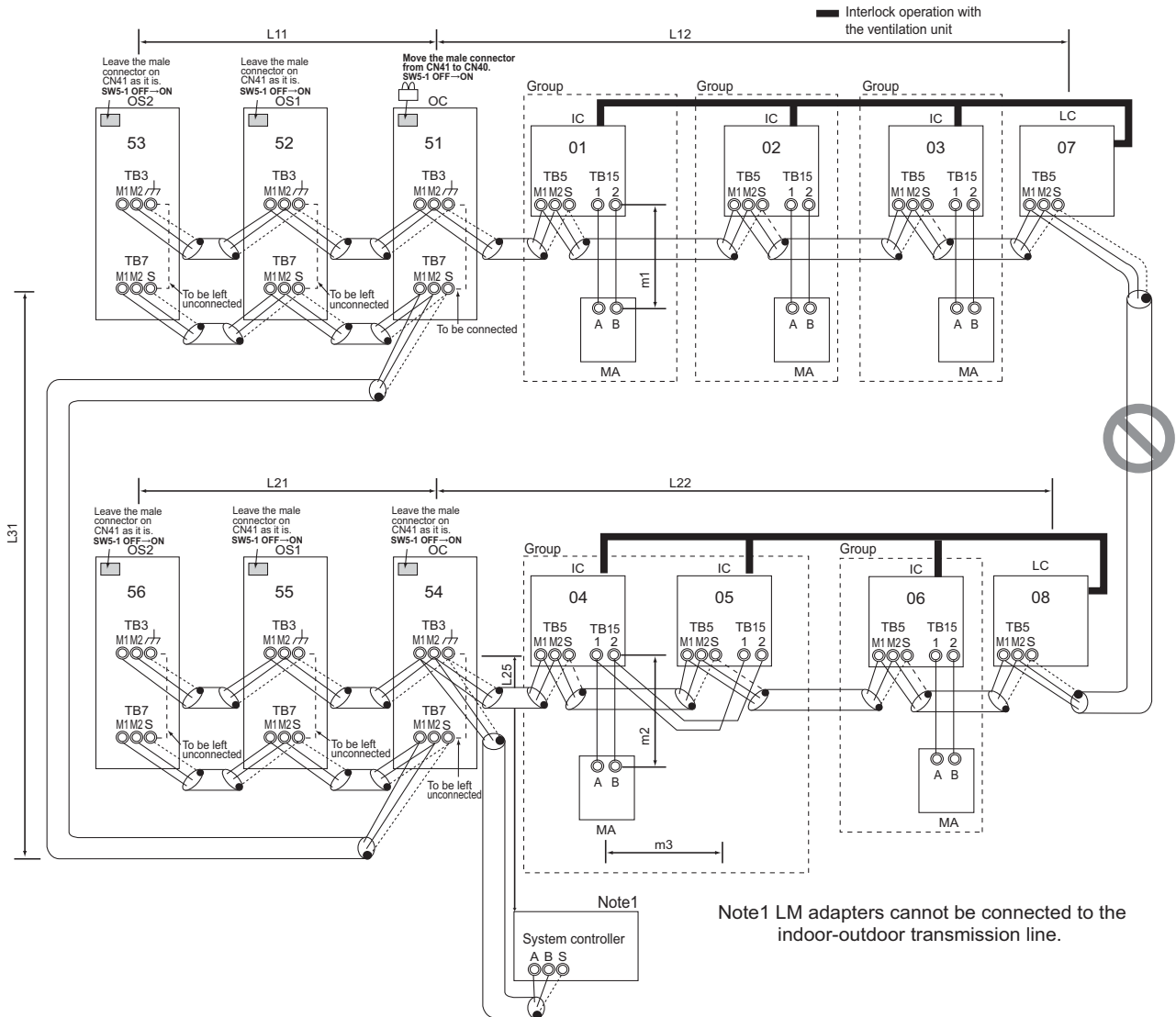

### (2) Cautions

- 1) ME remote controller and MA remote controller cannot both be connected to the same group of indoor units.
- 2) No more than 2 MA remote controllers can be connected to a group of indoor units.
- 3) Do not connect the terminal blocks (TB5) on the indoor units that are connected to different outdoor units with each other.
- 4) Replacement of male power jumper connector (CN41) must be performed only on one of the outdoor units (not required if power to the transmission line for centralized control is supplied from a controller with a power supply function, such as GB-50ADA).
- 5) Provide grounding to S terminal on the terminal block for transmission line for centralized control (TB7) on only one of the outdoor units.
- 6) A maximum of three system controllers can be connected to the indoor-outdoor transmission line. (AE-200, AG-150A, GB-50ADA, or G(B)-50A are not connectable.)
- 7) When the total number of indoor units exceeds 26, it may not be possible to connect a system controller on the indoor-outdoor transmission line.

In a system to which more than 18 indoor units including one or more indoor units of 200 model or above are connected, there may be cases in which the system controller cannot be

connected to the indoor-outdoor transmission line.

•Refer to the DATABOOK for further information about how many booster units are required for a given system.

### (3) Maximum allowable length

- 1) Indoor/outdoor transmission line  
 Maximum distance (1.25mm<sup>2</sup> [AWG16] or larger)  
 $L11+L12 \leq 200m$  [656ft]  
 $L21+L22 \leq 200m$  [656ft]  
 $L25 \leq 200m$  [656ft]
- 2) Transmission line for centralized control  
 $L31+L21 \leq 200m$  [656ft]
- 3) MA remote controller wiring  
 Same as 2-7-1
- 4) Maximum line distance via outdoor unit (1.25mm<sup>2</sup> [AWG16] or larger)  
 $L25+L31+L12(L11) \leq 500m$  [1640ft]  
 $L12(L11)+L31+L22(L21) \leq 500m$  [1640ft]

**(4) Wiring method**

1) Indoor/outdoor transmission line

Daisy-chain terminals M1 and M2 on the terminal block for indoor-outdoor transmission line (TB3) on the outdoor units (OC, OS1, OS2) (Note a), terminals M1 and M2 on the terminal block for indoor-outdoor transmission line (TB5) on each indoor unit (IC), and the S terminal on the system controller. (Non-polarized two-wire)

- Only use shielded cables.

**Note**

a) The outdoor units in the same refrigerant circuit are automatically designated as OC, OS1, and OS2. The outdoor units are designated as OC, OS1, and OS2 in the order of capacity from large to small (if two or more units have the same capacity, in the order of address from small to large).

**Shielded cable connection**

Daisy-chain the ground terminal (  $\text{⏏}$  ) on the outdoor units (OC, OS1, OS2), the S terminal on the terminal block (TB5) on the indoor unit (IC), and the S terminal on the system controller with the shield wire of the shielded cable.

2) Transmission line for centralized control

Daisy-chain terminals M1 and M2 on the terminal block for transmission line for centralized control (TB7) on the outdoor units (OC) in different refrigerant circuits and on the OC, OS1, and OS2 in the same refrigerant circuit. (Note b)

If a power supply unit is not connected to the transmission line for centralized control, replace the power jumper connector on the control board from CN41 to CN40 on only one of the outdoor units.

Set the central control switch (SW5-1) on the control board of all outdoor units to "ON."

**Note**

b) When not daisy-chaining TB7's on the outdoor units in the

**(5) Address setting method**

same refrigerant circuit, connect the transmission line for centralized control to TB7 on the OC (Note a). To maintain centralized control even during an OC failure or a power failure, daisy-chain TB7 of OC, OS1, and OS2. (If there is a problem with the outdoor unit whose power jumper was moved from CN41 to CN40, centralized control is not possible, even if TB7's are daisy-chained).

c) When connecting TB7, only commence after checking that the voltage is below 20 VDC.

- Only use shielded cables.

**Shielded cable connection**

Daisy-chain the S terminal on the terminal block (TB7) on the outdoor units (OC, OS1, OS2) with the shield wire of the shielded cable. Short-circuit the earth terminal (  $\text{⏏}$  ) and the S terminal on the terminal block (TB7) on the outdoor unit whose power jumper connector is mated with CN40.

3) MA remote controller wiring

Same as 2-7-1

**When 2 remote controllers are connected to the system**

Same as 2-7-1

**Group operation of indoor units**

Same as 2-7-1

4) LOSSNAY connection

Connect terminals M1 and M2 on the terminal block (TB5) on the indoor units (IC) to the appropriate terminals on the terminal block for indoor-outdoor transmission line (TB5) on LOSSNAY (LC). (Non-polarized two-wire)

- Indoor units must be interlocked with the LOSSNAY unit using the system controller. (Refer to the operation manual for the system controller for the setting method.) Interlock setting from the remote controller is required if the ON/OFF remote controller alone is connected.

5) Switch setting

Address setting is required as follows.

Procedures	Unit or controller			Address setting range	Setting method	Notes	Factory setting
1	Indoor unit	Main unit	IC	01 to 50	Assign the smallest address to the main unit in the group.	To perform a group operation of indoor units that have different functions, designate the indoor unit in the group with the greatest number of functions as the main unit.	00
		Sub unit			Assign sequential numbers starting with the address of the main unit in the same group +1. (Main unit address +1, main unit address +2, main unit address +3, etc.)		
2	LOSSNAY		LC	01 to 50	Assign an arbitrary but unique address to each of these units after assigning an address to all indoor units.	None of these addresses may overlap any of the indoor unit addresses.	00
3	MA remote controller	Main remote controller	MA	No settings required.	-	Enter the same indoor unit group settings on the system controller as the ones that were entered on the MA remote controller.	Main
		Sub remote controller	MA	Sub remote controller	Settings to be made according to the remote controller function selection		
4	Outdoor unit		OC OS1 OS2	51 to 100	Assign sequential address to the outdoor units in the same refrigerant circuit. The outdoor units are automatically designated as OC, OS1, and OS2. (Note)	To set the address to 100, set the rotary switches to 50.	00

**Note**

The outdoor units in the same refrigerant circuit are automatically designated as OC, OS1, and OS2. The outdoor units are designated as OC, OS1, and OS2 in the order of capacity from large to small (if two or more units have the same capacity, in the order of address from small to large).

## 2-8 Example System with an ME Remote Controller

### 2-8-1 System with a Connection of System Controller to Centralized Control Transmission Line

#### (1) Sample control wiring

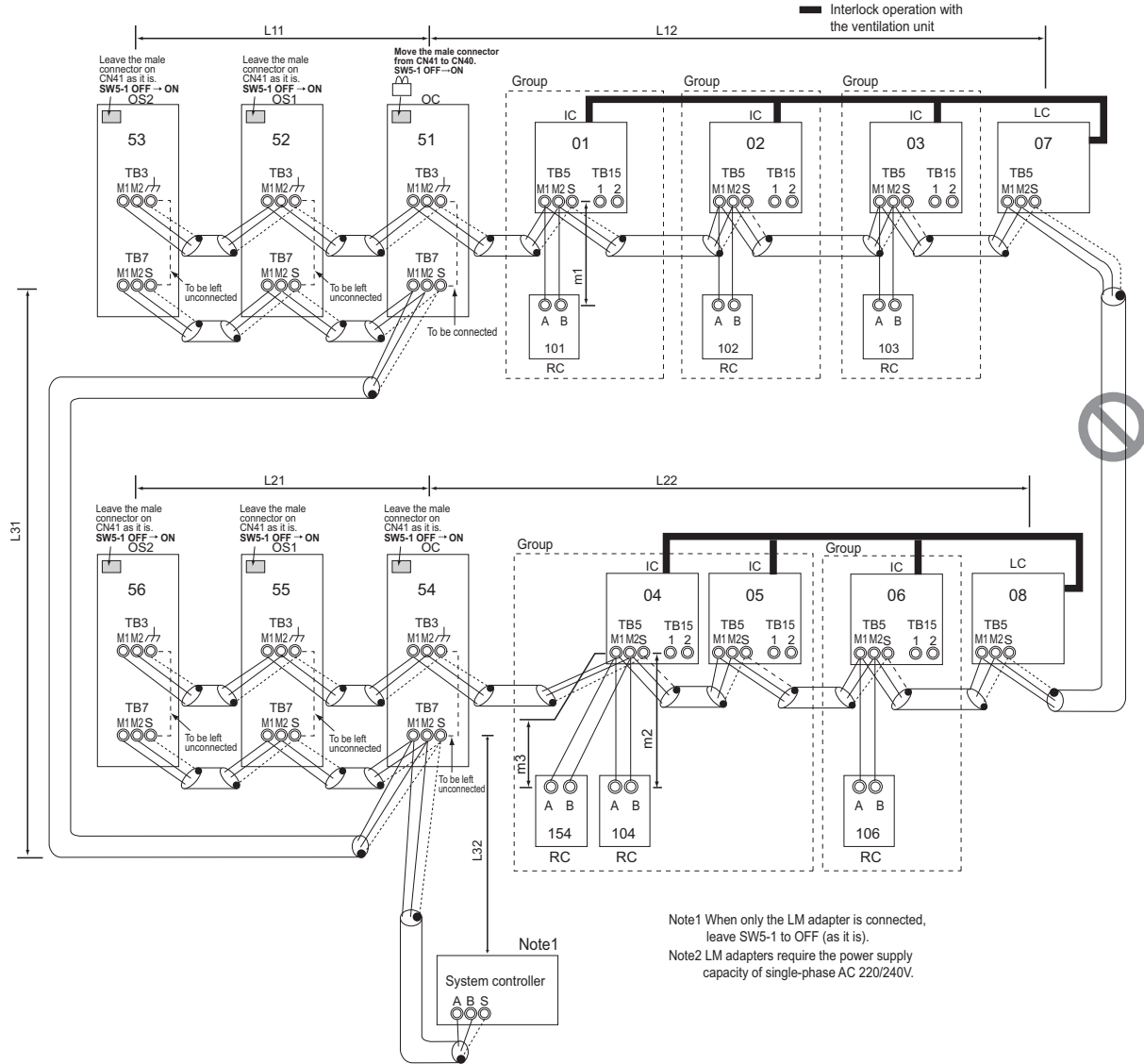

#### (2) Cautions

- ME remote controller and MA remote controller cannot both be connected to the same group of indoor units.
  - No more than 3 ME remote controllers can be connected to a group of indoor units.
  - Do not connect the terminal blocks (TB5) on the indoor units that are connected to different outdoor units with each other.
  - Replacement of male power jumper connector (CN41) must be performed only on one of the outdoor units (not required if power to the transmission line for centralized control is supplied from a controller with a power supply function, such as GB-50ADA).
  - Provide an electrical path to ground for the S terminal on the terminal block for centralized control on only one of the outdoor units.
  - A transmission booster must be connected to a system in which the total number of connected indoor units exceeds 20.
  - A transmission booster is required in a system to which more than 16 indoor including one or more indoor units of the 200 model or above are connected.
- \*Refer to the DATABOOK for further information about how many booster units are required for a given system.
- When a power supply unit is connected to the transmission line

for centralized control, leave the power jumper connector on CN41 as it is (factory setting).

#### (3) Maximum allowable length

- Indoor/outdoor transmission line  
Same as 2-7-3
- Transmission line for centralized control  
Same as 2-7-4
- M-NET remote controller wiring

Maximum overall line length  
(0.3 to 1.25mm<sup>2</sup> [AWG22 to 16])  
m1 ≤ 10m [32ft]

m2+m3 ≤ 10m [32ft]

If the standard-supplied cable must be extended, use a cable with a diameter of 1.25mm<sup>2</sup> [AWG16]. The section of the cable that exceeds 10m [32ft] must be included in the maximum indoor-outdoor transmission line distance described in 1).

\*When connected to the terminal block on the Simple remote controller, use cables that meet the following cable size specifications: 0.75 - 1.25 mm<sup>2</sup> [AWG18-14].

- Maximum line distance via outdoor unit  
(1.25 mm<sup>2</sup> [AWG16] min.)  
Same as 2-7-4

**(4) Wiring method**

- 1) Indoor/outdoor transmission line  
Same as 2-7-1  
**Shielded cable connection**  
Same as 2-7-1
- 2) Transmission line for centralized control  
Same as 2-7-4  
**Shielded cable connection**  
Same as 2-7-4
- 3) ME remote controller wiring  
ME remote controller is connectable anywhere on the indoor-outdoor transmission line.

**When 2 remote controllers are connected to the system**

- Refer to the section on Switch Setting.
- Performing a group operation (including the group operation of units in different refrigerant circuits).**  
Refer to the section on Switch Setting.
- 4) LOSSNAY connection  
Same as 2-7-4
- 5) Switch setting  
Address setting is required as follows.

**(5) Address setting method**

Procedures	Unit or controller			Address setting range	Setting method	Notes	Factory setting
1	Indoor unit	Main unit	IC	01 to 50	Assign the smallest address to the main unit in the group.	To perform a group operation of indoor units that have different functions, designate the indoor unit in the group with the greatest number of functions as the main unit.	00
		Sub unit			Assign sequential numbers starting with the address of the main unit in the same group +1. (Main unit address +1, main unit address +2, main unit address +3, etc.)		
2	LOSSNAY		LC	01 to 50	Assign an arbitrary but unique address to each of these units after assigning an address to all indoor units.	None of these addresses may overlap any of the indoor unit addresses.	00
3	ME remote controller	Main remote controller	RC	101 to 150	Add 100 to the main unit address in the group	<ul style="list-style-type: none"> <li>♦It is not necessary to set the 100s digit.</li> <li>♦To set the address to 200, set the rotary switches to 00.</li> </ul>	101
		Sub remote controller	RC	151 to 200	Add 150 to the main unit address in the group		
4	Outdoor unit		OC OS1 OS2	51 to 100	Assign sequential address to the outdoor units in the same refrigerant circuit. The outdoor units are automatically designated as OC, OS1, and OS2. (Note)	To set the address to 100, set the rotary switches to 50.	00

**Note**

The outdoor units in the same refrigerant circuit are automatically designated as OC, OS1, and OS2. The outdoor units are designated as OC, OS1, and OS2 in the order of capacity from large to small (if two or more units have the same capacity, in the order of address from small to large).

## 2-9 Example System with an MA and an ME Remote Controller

### 2-9-1 System with a Connection of System Controller to Centralized Control Transmission Line

#### (1) Sample control wiring

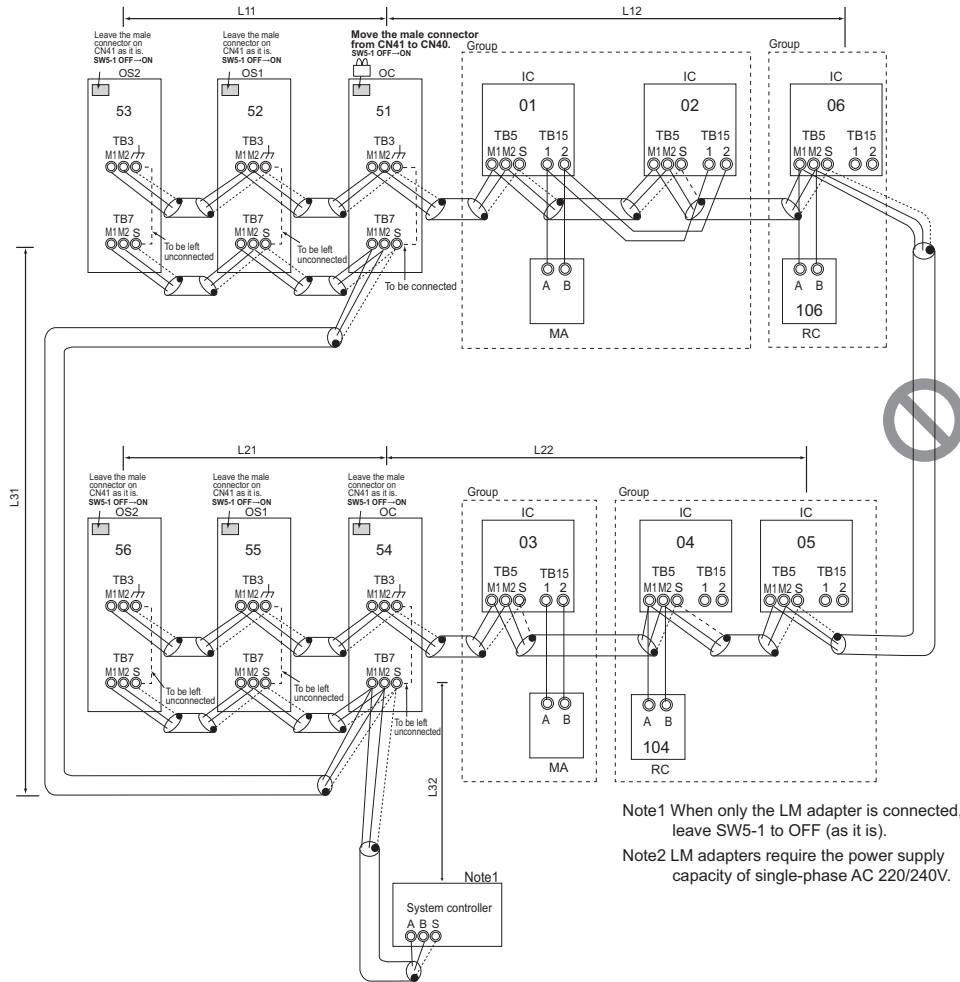

#### (2) Cautions

- 1) Be sure to connect a system controller.
- 2) ME remote controller and MA remote controller cannot both be connected to the same group of indoor units.
- 3) Assign to the indoor units connected to the MA remote controller addresses that are smaller than those of the indoor units that are connected to the ME remote controller.
- 4) No more than 2 ME remote controllers can be connected to a group of indoor units.
- 5) No more than 2 MA remote controllers can be connected to a group of indoor units.
- 6) Do not connect the terminal blocks (TB5) on the indoor units that are connected to different outdoor units with each other.
- 7) Replacement of male power jumper connector (CN41) must be performed only on one of the outdoor units (not required if power to the transmission line for centralized control is supplied from a controller with a power supply function, such as GB-50ADA).
- 8) Provide an electrical path to ground for the S terminal on the terminal block for centralized control on only one of the outdoor units.
- 9) A transmission booster must be connected to a system

in which the total number of connected indoor units exceeds 20.

- 10) A transmission booster is required in a system to which more than 16 indoor including one or more indoor units of the 200 model or above are connected.
  - Refer to the DATABOOK for further information about how many booster units are required for a given system.
- 11) When a power supply unit is connected to the transmission line for centralized control, leave the power jumper connector on CN41 as it is (factory setting).

#### (3) Maximum allowable length

- 1) Indoor/outdoor transmission line  
Same as 2-7-3
- 2) Transmission line for centralized control  
Same as 2-7-4
- 3) MA remote controller wiring  
Same as 2-7-1
- 4) M-NET remote controller wiring  
Same as 2-7-1
- 5) Maximum line distance via outdoor unit (1.25 mm<sup>2</sup> [AWG16] min. )  
Same as 2-7-4

**(4) Wiring method**

- 1) Indoor/outdoor transmission line  
Same as 2-7-1  
**Shielded cable connection**  
Same as 2-7-1
- 2) Transmission line for centralized control  
Same as 2-7-4  
**Shielded cable connection**  
Same as 2-7-4
- 3) MA remote controller wiring  
Same as 2-7-1  
**When 2 remote controllers are connected to the system**

- Same as 2-7-1  
**Group operation of indoor units**  
Same as 2-7-1
- 4) M-NET remote controller wiring  
Same as 2-7-1  
**When 2 remote controllers are connected to the system**  
Same as 2-7-1  
**Group operation of indoor units**  
Same as 2-7-1
- 5) LOSSNAY connection  
Same as 2-7-4
- 6) Switch setting  
Address setting is required as follows.

**(5) Address setting method**

Procedures	Unit or controller				Address setting range	Setting method	Notes	Factory setting	
1	Operation with the MA remote controller	Indoor unit	Main unit	IC	01 to 50	Assign the smallest address to the main unit in the group.	<ul style="list-style-type: none"> <li>•Assign an address smaller than that of the indoor unit that is connected to the ME remote controller.</li> <li>•Enter the same indoor unit group settings on the system controller as the ones that were entered on the MA remote controller.</li> <li>•To perform a group operation of indoor units that have different functions, designate the indoor unit in the group with the greatest number of functions as the main unit.</li> </ul>	00	
			Sub unit			Assign sequential numbers starting with the address of the main unit in the same group +1. (Main unit address +1, main unit address +2, main unit address +3, etc.)			
	MA remote controller	Main remote controller	MA	No settings required.	-				Main
		Sub remote controller	MA	Sub remote controller	Settings to be made according to the remote controller function selection				
2	Operation with the ME remote controller	Indoor unit	Main unit	IC	01 to 50	Assign the smallest address to the main unit in the group.	<ul style="list-style-type: none"> <li>•Enter the indoor unit group settings on the system controller (MELANS).</li> <li>•Assign an address larger than those of the indoor units that are connected to the MA remote controller.</li> <li>•To perform a group operation of indoor units that have different functions, designate the indoor unit in the group with the greatest number of functions as the main unit.</li> </ul>	00	
			Sub unit			Assign sequential numbers starting with the address of the main unit in the same group +1. (Main unit address +1, main unit address +2, main unit address +3, etc.)			
	ME remote controller	Main remote controller	RC	101 to 150	Add 100 to the main unit address in the group.	<ul style="list-style-type: none"> <li>•It is not necessary to set the 100s digit.</li> <li>•To set the address to 200, set the rotary switches to 00.</li> </ul>			101
		Sub remote controller	RC	151 to 200	Add 150 to the main unit address in the group.				
3	LOSSNAY			LC	01 to 50	Assign an arbitrary but unique address to each of these units after assigning an address to all indoor units.	None of these addresses may overlap any of the indoor unit addresses.	00	
4	Outdoor unit		OC OS1 OS2		51 to 100	Assign sequential address to the outdoor units in the same refrigerant circuit. The outdoor units are automatically designated as OC, OS1, and OS2. (Note)	To set the address to 100, set the rotary switches to 50.	00	

**Note**

The outdoor units in the same refrigerant circuit are automatically designated as OC, OS1, and OS2. The outdoor units are designated as OC, OS1, and OS2 in the order of capacity from large to small (if two or more units have the same capacity, in the order of address from small to large).

## 2-10 Restrictions on Refrigerant Pipes

### 2-10-1 Restrictions on Refrigerant Pipe Length

(1) P200 - P500YKB models

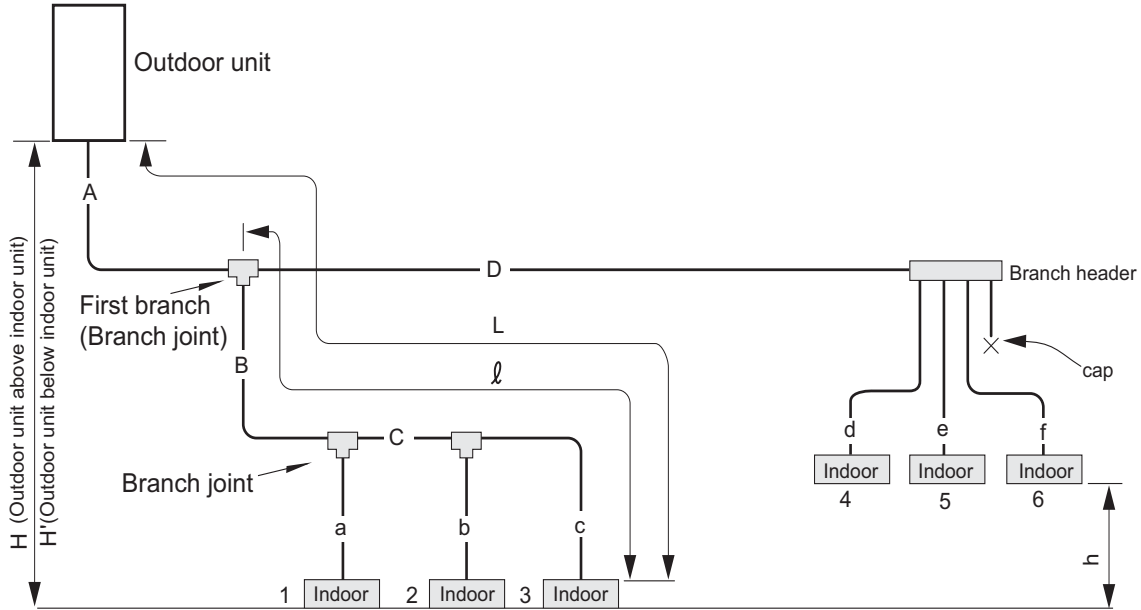

Unit: m [ft]

Operation		Pipe sections	Allowable length of pipes	
Length	Total pipe length	$A+B+C+D$ $+a+b+c+d+e+f$	1000 [3280] or less	
	Total pipe length (L) from the outdoor unit to the farthest indoor unit	$A+B+C+c$ or $A+D+f$	165 [541] or less (Equivalent length 190 [623] or less)	
	Total pipe length from the first branch to the farthest indoor unit ( $l$ )	$B+C+c$ or $D+f$	40 [131] or less <sup>*1</sup>	
Height difference	Between indoor and outdoor units	Outdoor unit above indoor unit	H	50 [164] or less
		Outdoor unit below indoor unit	H'	40 [131] or less
	Between indoor units	h	15 [49] or less <sup>*2</sup>	

\*1. If the piping length exceeds 40 meters (but does not exceed 90 meters), use one-size larger pipes for all the liquid pipes beyond 40 meters. In the figure above, the pipes whose size should be increased by one size are indicated by "C," "b," and "c" when the piping length exceeds 40 meters at point C.

\*2. If the vertical difference between indoor units exceeds 15 meters (but does not exceed 30 meters), use one-size larger liquid pipes for piping between the first branch and the relevant indoor units. In the figure above, the pipes whose size should be increased by one size are indicated by "B," "C," "a," "b," and "c" when the "h" exceeds 15 meters.

**(2) P400 - P1350YSKB models**

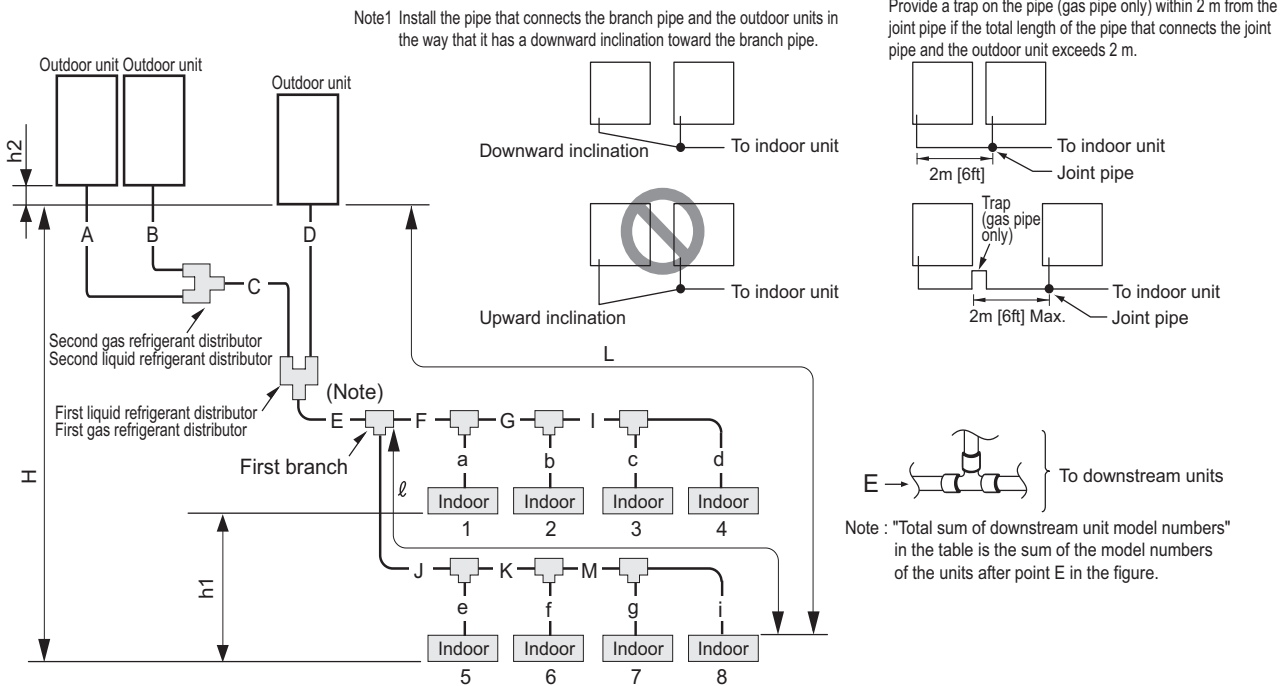

Operation		Pipe sections	Allowable length of pipes
Length	Between outdoor units	A+B+C+D	10 [32] or less
	Total pipe length	A+B+C+D+E+F+G+I+J+K+M+a+b+c+d+e+f+g+i	1000 [3280] or less
	Total pipe length (L) from the outdoor unit to the farthest indoor unit	A(B)+C+E+J+K+M+i	165 [541] or less (Equivalent length 190 [623] or less)
	Total pipe length from the first branch to the farthest indoor unit ( l )	G+I+J+i	40 [131] or less <sup>*1</sup>
Height difference	Between indoor and outdoor units	H	50 [164] or less (40 [131] or below if outdoor unit is below indoor unit)
	Between indoor units	h1	15 [49] or less <sup>*2</sup>
	Between outdoor units	h2	0.1[0.3] or less

\*1. If the piping length exceeds 40 meters (but does not exceed 90 meters), use one-size larger pipes for all the liquid pipes beyond 40 meters. In the figure above, the pipes whose size should be increased by one size are indicated by "l," "c," and "d" when the piping length exceeds 40 meters at point l.

\*2. If the vertical difference between indoor units exceeds 15 meters (but does not exceed 30 meters), use one-size larger liquid pipes for piping between the first branch and the relevant indoor units. In the figure above, the pipes whose size should be increased by one size are indicated by "J," "K," "M," "e," "f," "g," and "i" when the "h1" exceeds 15 meters.

See the next page for the detailed description of the sample application above.



**When the vertical separation between indoor units exceeds 15 m**

Outdoor unit above indoor unit

example 1

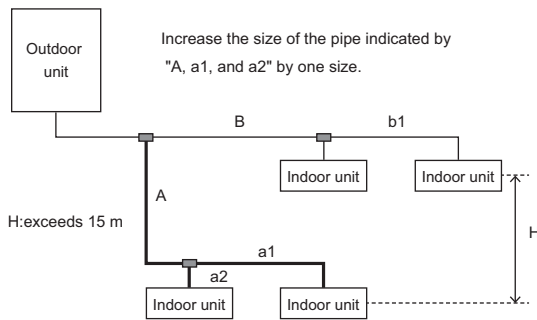

example 2

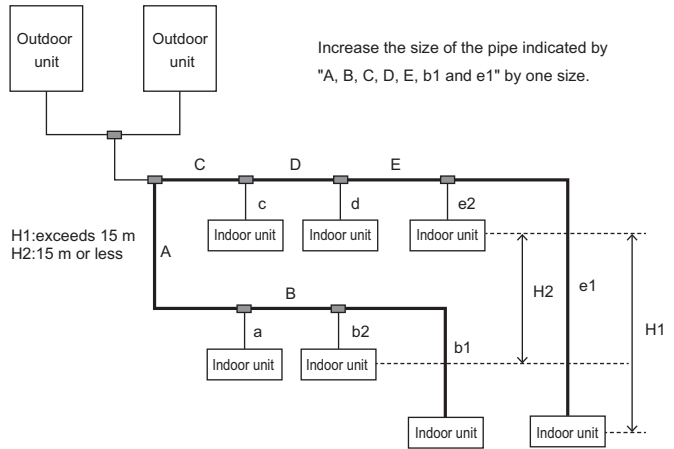

Outdoor unit below indoor unit

example 3

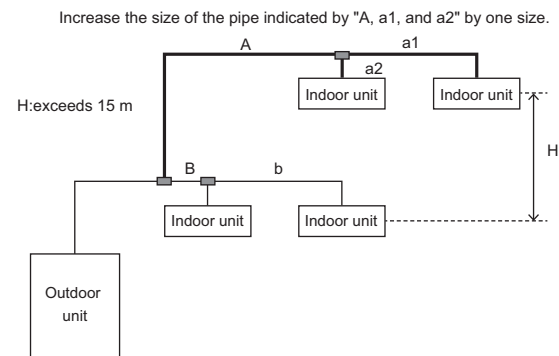

**When the distance from the first branch to the farthest indoor unit exceeds 40 m**

example 4

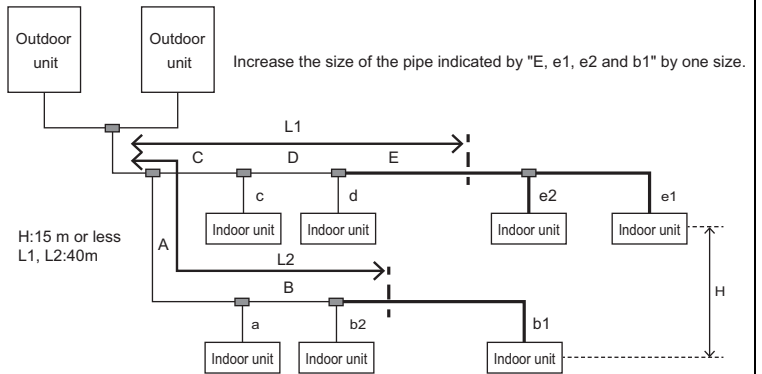

**When the distance from the first branch to the farthest indoor unit exceeds 40 m and the vertical separation between indoor units exceeds 15 m**

example 5

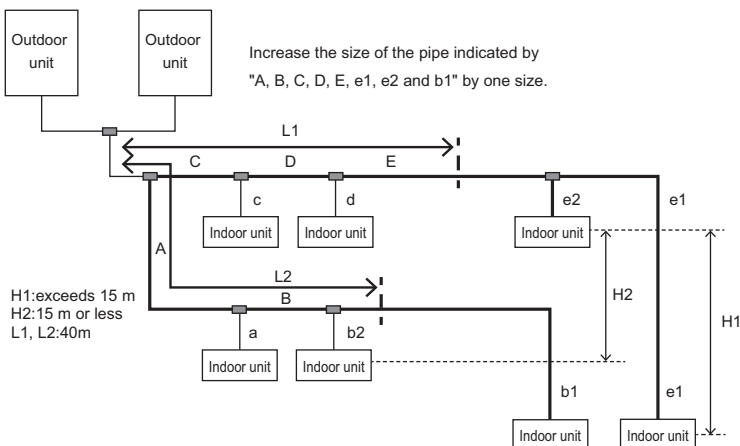

## 2-10-2 Restrictions on Refrigerant Pipe Size

### (1) Diameter of the refrigerant pipe between the outdoor unit and the first branch (outdoor unit pipe size)

Outdoor unit set name (total capacity)	Liquid pipe size (mm) [inch]	Gas pipe size (mm) [inch]
200 model	ø9.52 [3/8"]	ø22.2 [7/8"]
250 model	ø9.52 [3/8"] <sup>*1</sup>	ø22.2 [7/8"]
300 model	ø9.52 [3/8"] <sup>*2</sup>	ø22.2 [7/8"]
350 model	ø12.7 [1/2"]	ø28.58 [1-1/8"]
400 model	ø12.7 [1/2"]	ø28.58 [1-1/8"]
450 model	ø15.88 [5/8"]	ø28.58 [1-1/8"]
500 model	ø15.88 [5/8"]	ø28.58 [1-1/8"]
550 model	ø15.88 [5/8"]	ø28.58 [1-1/8"]
600 model	ø15.88 [5/8"]	ø28.58 [1-1/8"]
650 model	ø15.88 [5/8"]	ø28.58 [1-1/8"]
700 - 800 model	ø19.05 [3/4"]	ø34.93 [1-3/8"]
850 - 1350 model	ø19.05 [3/4"]	ø41.28 [1-5/8"]

\*1. Use ø12.7 [1/2"] pipes if the piping length to the farthest indoor unit exceeds 90 m [295 ft].

\*2. Use ø12.7 [1/2"] pipes if the piping length to the farthest indoor unit exceeds 40 m [131 ft].

### (2) Size of the refrigerant pipe between the first branch and the indoor unit (indoor unit pipe size)

model	Pipe diameter (mm) [inch]	
20 - 50 models	Liquid pipe	ø6.35 [1/4"]
	Gas pipe	ø12.7 [1/2"]
63 - 140 models	Liquid pipe	ø9.52 [3/8"]
	Gas pipe	ø15.88 [5/8"]
200 model	Liquid pipe	ø9.52 [3/8"]
	Gas pipe	ø19.05 [3/4"]
250 model	Liquid pipe	ø9.52 [3/8"]
	Gas pipe	ø22.2 [7/8"]
400 model	Liquid pipe	ø12.7 [1/2"]
	Gas pipe	ø28.58 [1-1/8"]
500 model	Liquid pipe	ø15.88 [5/8"]
	Gas pipe	ø28.58 [1-1/8"]

**(3) Size of the refrigerant pipe between the branches for connection to indoor units**

Total capacity of the downstream units	Liquid pipe size (mm) [inch]	Gas pipe size (mm) [inch]
- 140	ø9.52 [3/8"]	ø15.88 [5/8"]
P141 - P200	ø9.52 [3/8"]	ø19.05 [3/4"]
P201 - P300	ø9.52 [3/8"]	ø22.2 [7/8"]
P301 - P400	ø12.7 [1/2"]	ø28.58 [1-1/8"]
P401 - P650	ø15.88 [5/8"]	ø28.58 [1-1/8"]
P651 - P800	ø19.05 [3/4"]	ø34.93 [1-3/8"]
P801 -	ø19.05 [3/4"]	ø41.28 [1-5/8"]

**(4) Size of the refrigerant pipe between the first distributor and the second distributor**

Liquid pipe size (mm) [inch]	Gas pipe size (mm) [inch]
ø19.05 [3/4"]	ø34.93 [1-3/8"]

**(5) Size of the refrigerant pipe between the first distributor or the second distributor and outdoor units**

	Liquid pipe size (mm) [inch]	Gas pipe size (mm) [inch]
200 model	ø9.52 [3/8"]	ø22.2 [7/8"]
250 model		
300 model	ø12.7 [1/2"]	ø28.58 [1-1/8"]
350 model		
400 model		
450 model	ø15.88 [5/8"]	

---

## Chapter 3 Major Components, Their Functions and Refrigerant Circuits

<b>3-1</b>	<b>External Appearance and Refrigerant Circuit Components of Outdoor Unit.....</b>	<b>53</b>
3-1-1	External Appearance of Outdoor Unit.....	53
3-1-2	Outdoor Unit Refrigerant Circuits.....	56
<b>3-2</b>	<b>Outdoor Unit Refrigerant Circuit Diagrams.....</b>	<b>59</b>
<b>3-3</b>	<b>Functions of the Major Components of Outdoor Unit.....</b>	<b>61</b>
<b>3-4</b>	<b>Functions of the Major Components of Indoor Unit.....</b>	<b>64</b>



# 3-1 External Appearance and Refrigerant Circuit Components of Outdoor Unit

## 3-1-1 External Appearance of Outdoor Unit

(1) PUHY-P200, P250YKB-A1

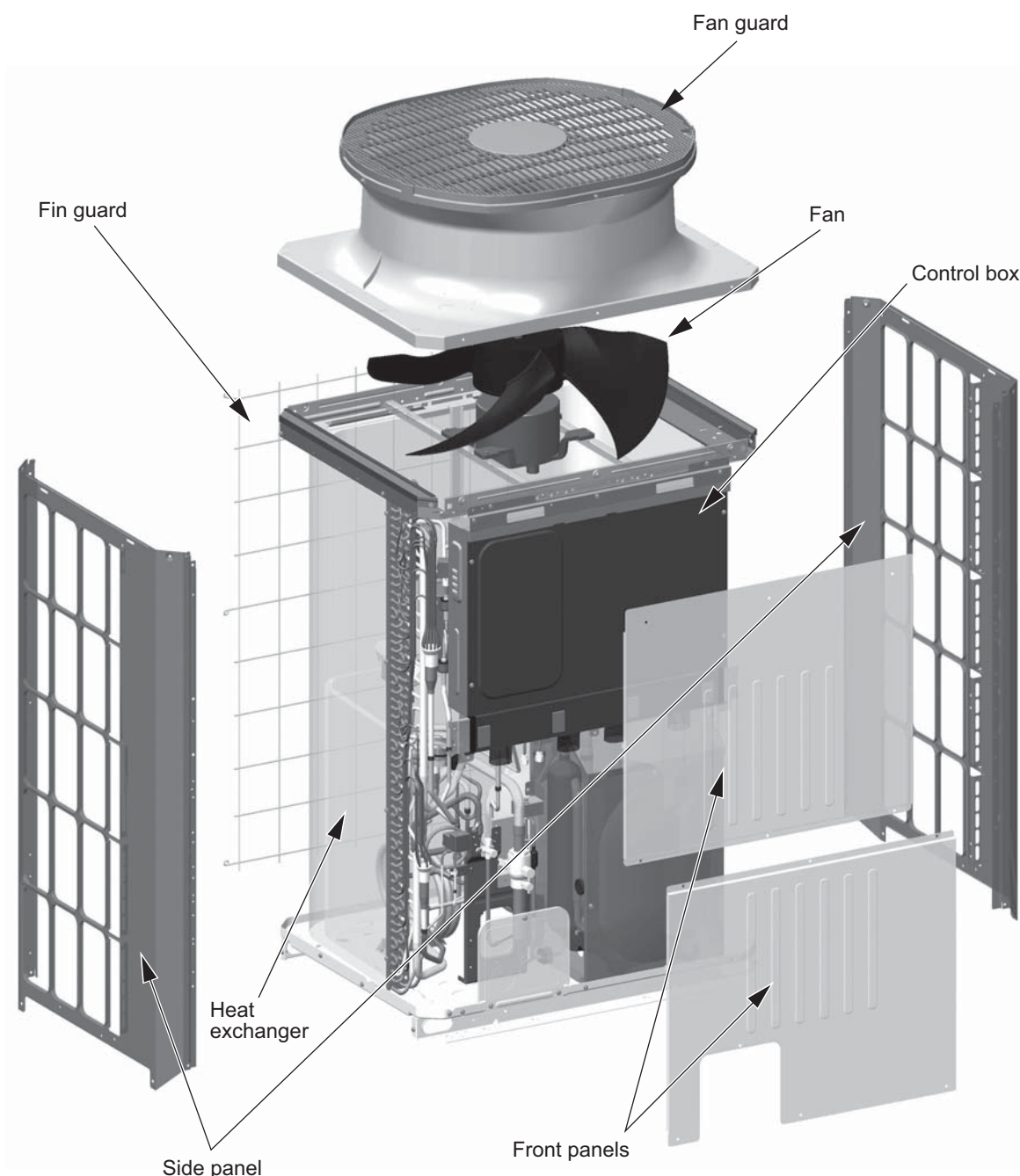

3 Major Components, Their Functions and Refrigerant Circuits

(2) PUHY-P300, P350, P400YKB-A1

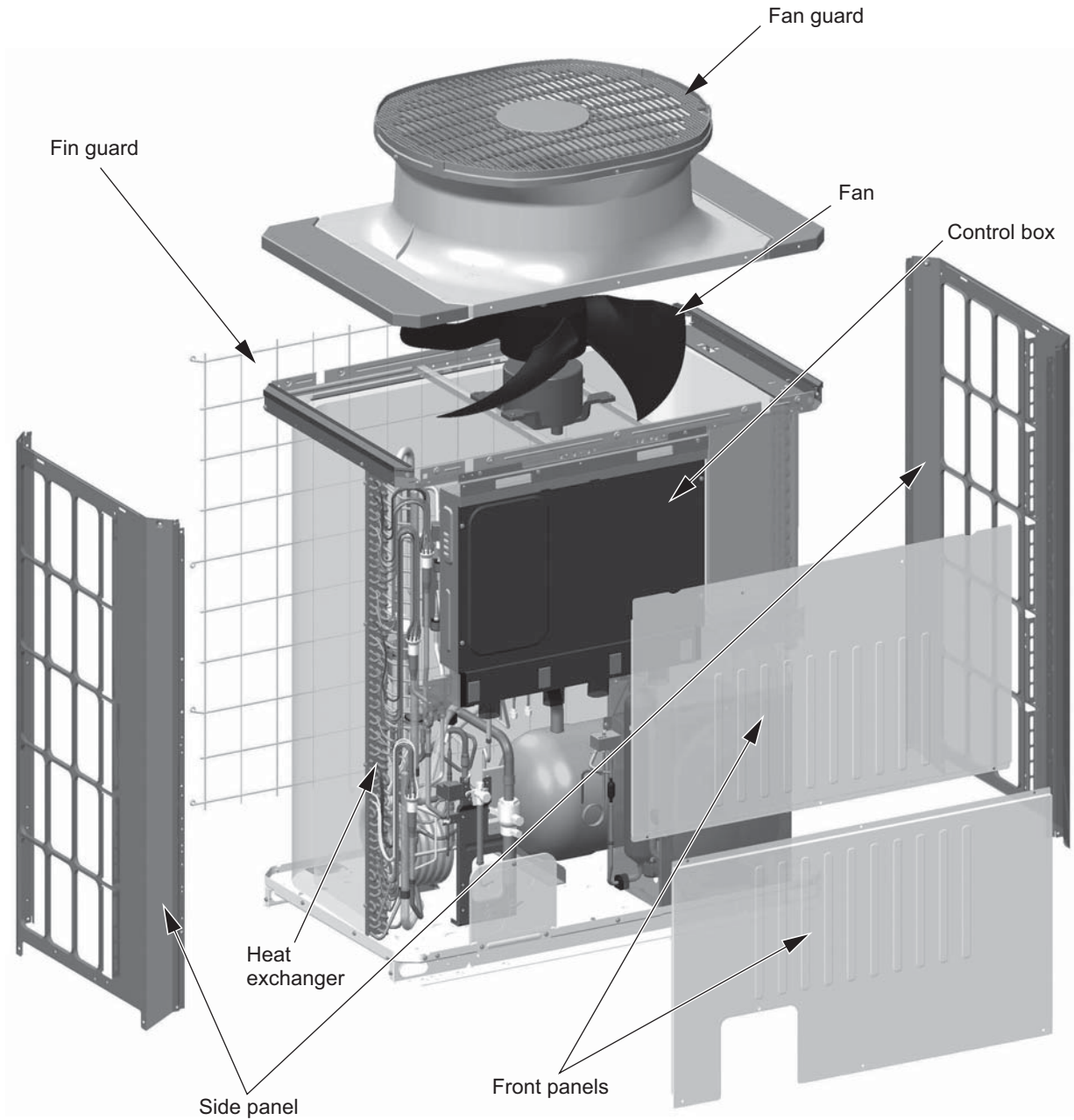

(3) PUHY-P450, P500YKB-A1

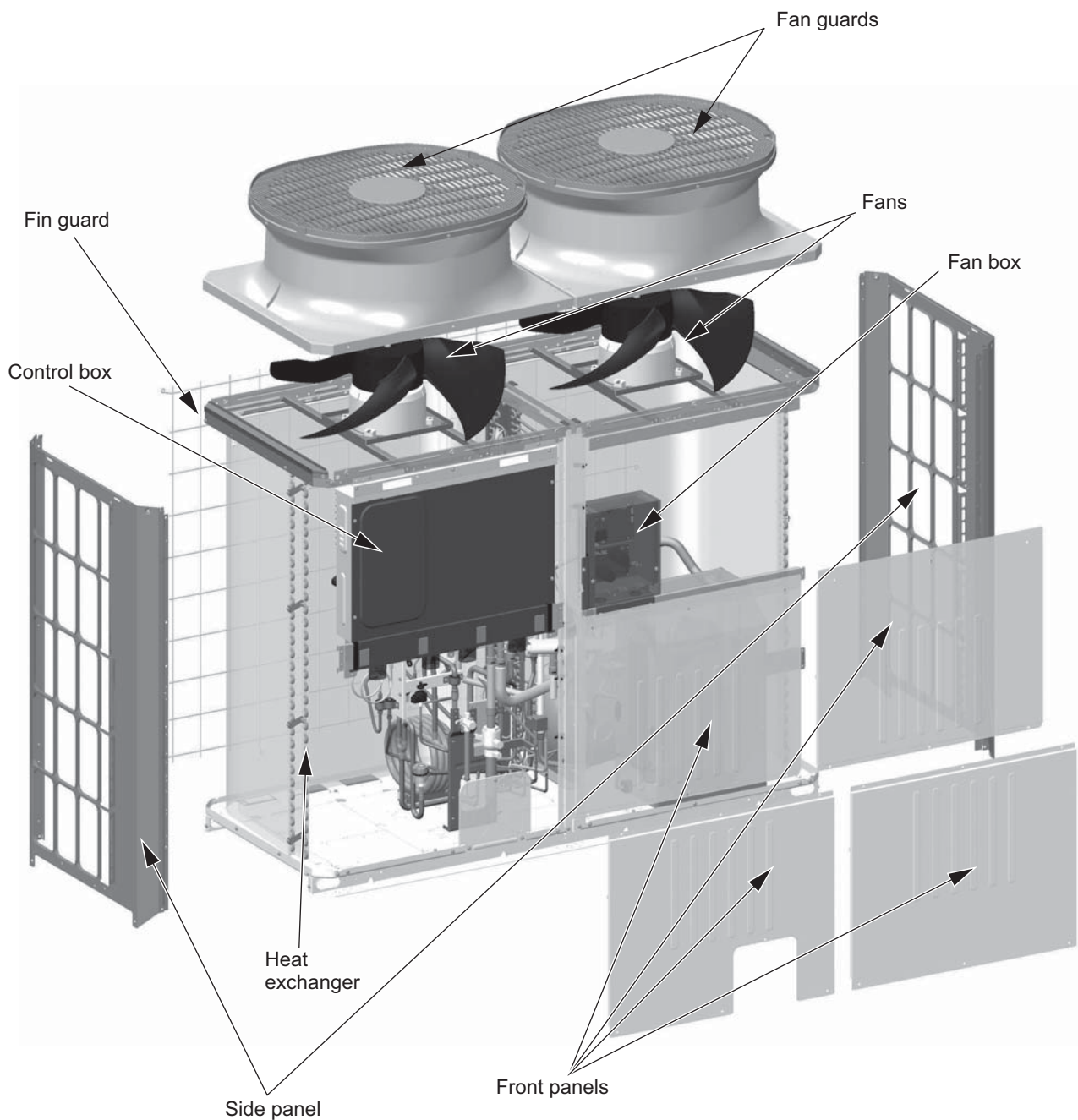



### 3-1-2 Outdoor Unit Refrigerant Circuits

(1) PUHY-P200, P250YKB-A1

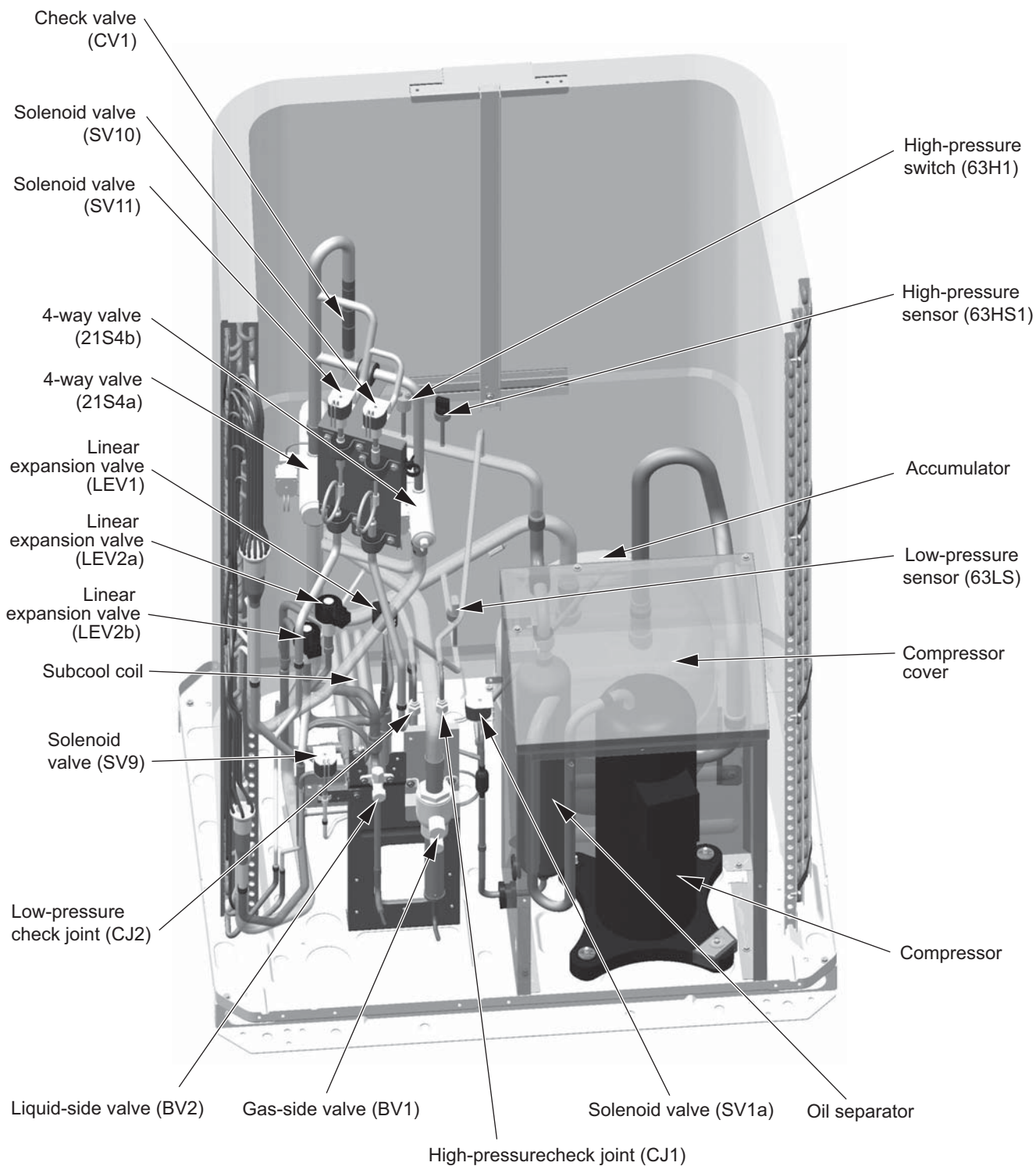

(2) PUHY-P300, P350, P400YKB-A1

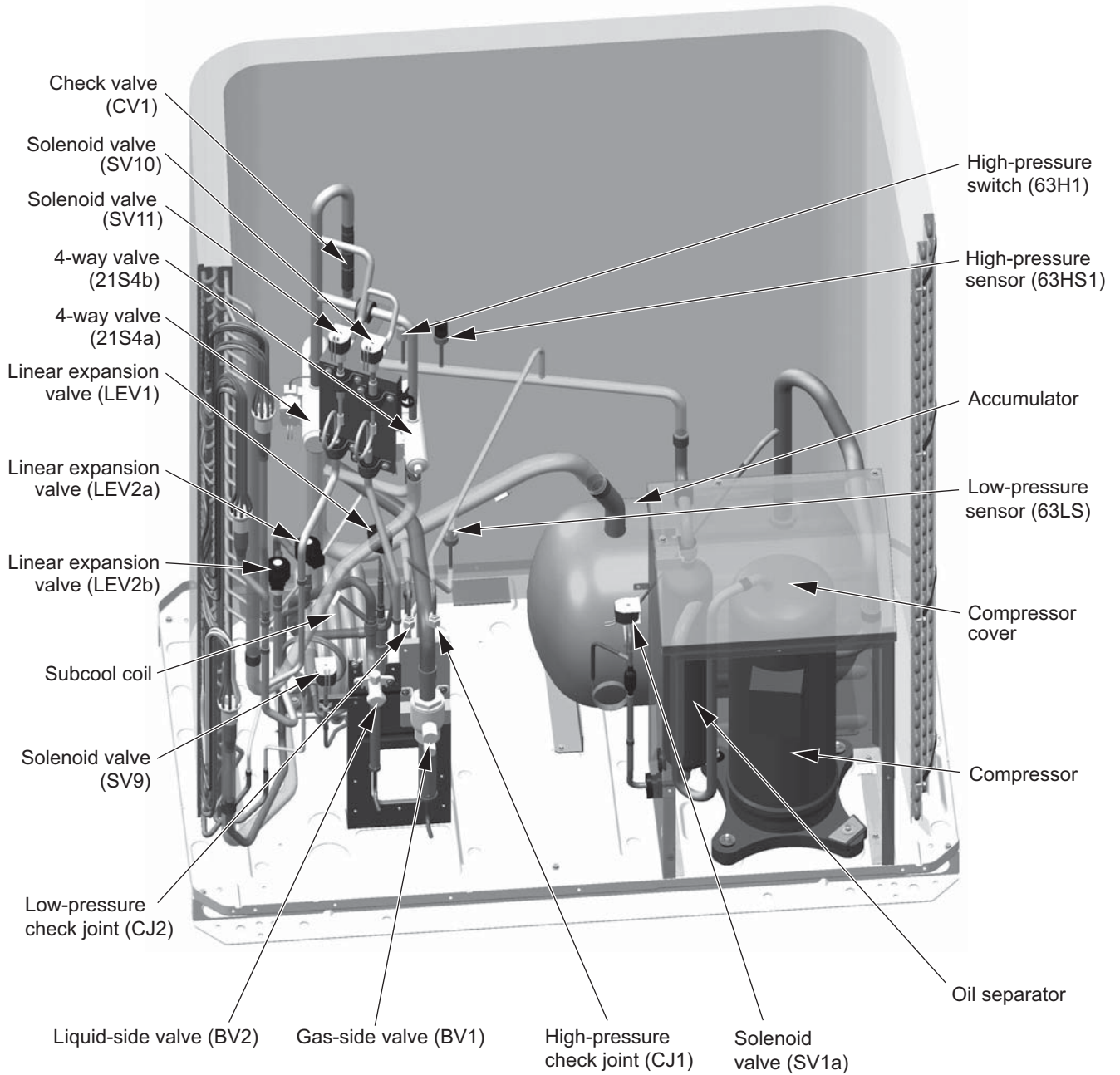

3 Major Components, Their Functions and Refrigerant Circuits

(3) PUHY-P450, P500YKB-A1

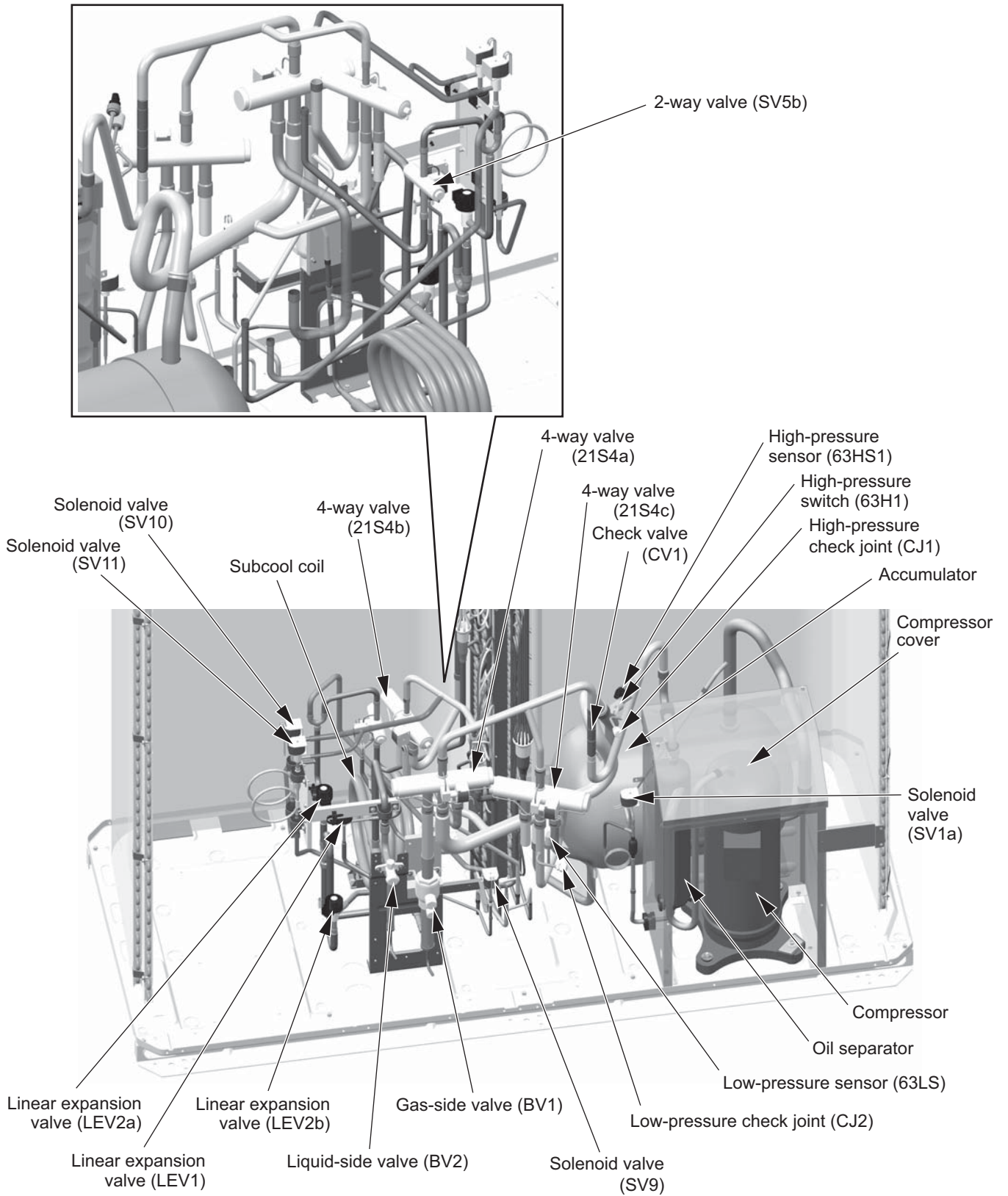

# 3-2 Outdoor Unit Refrigerant Circuit Diagrams

## (1) PUHY-P200, P250 models

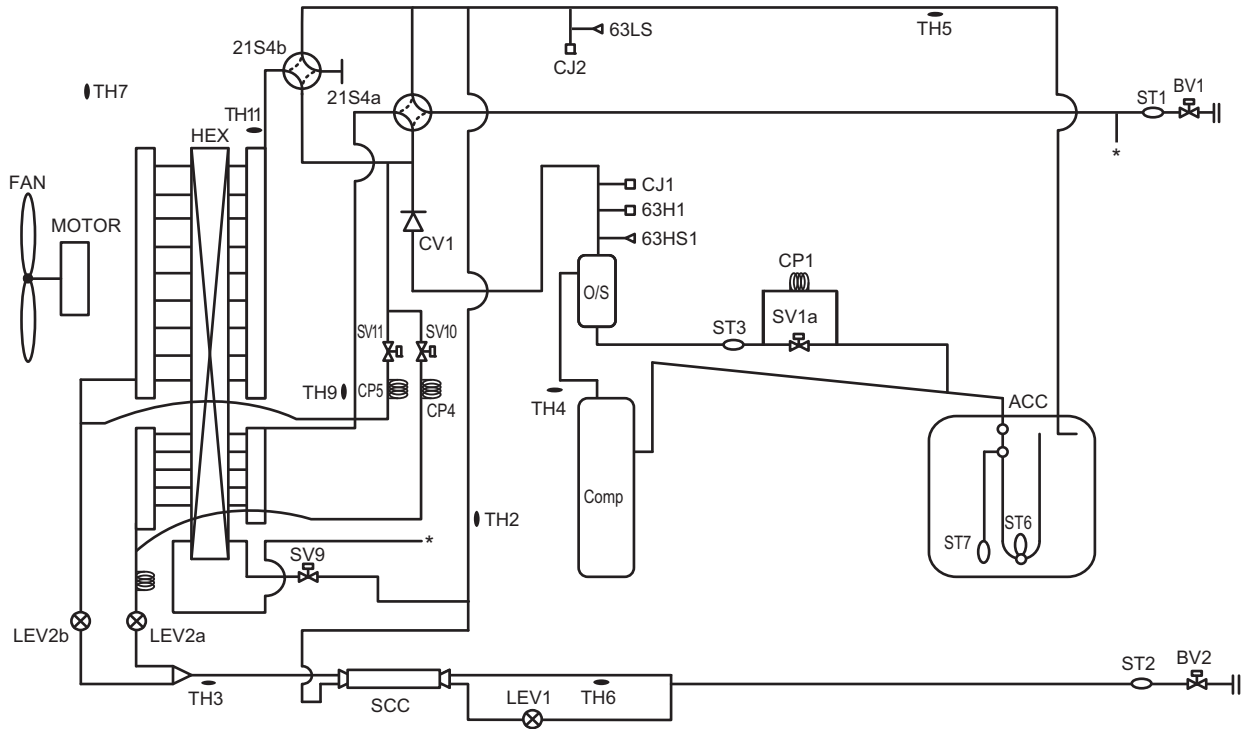

## (2) PUHY-P300, P350, P400 models

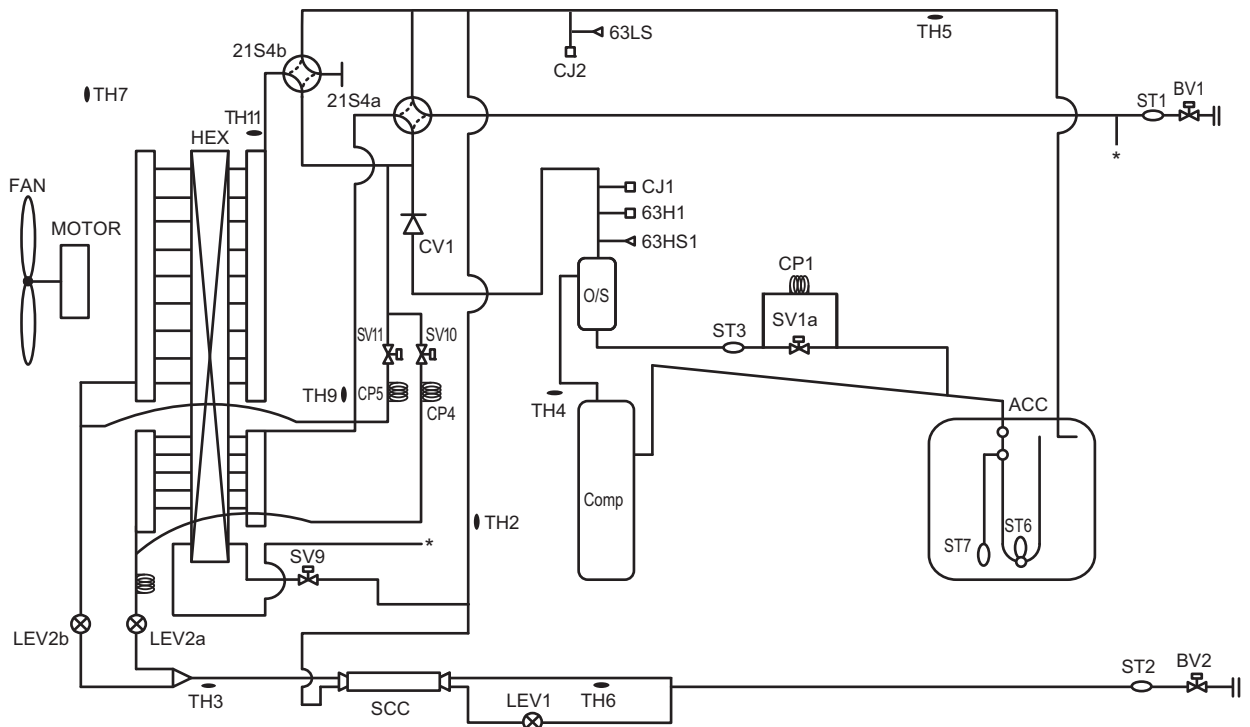

3 Major Components, Their Functions and Refrigerant Circuits

(3) PUHY-P450, P500 models

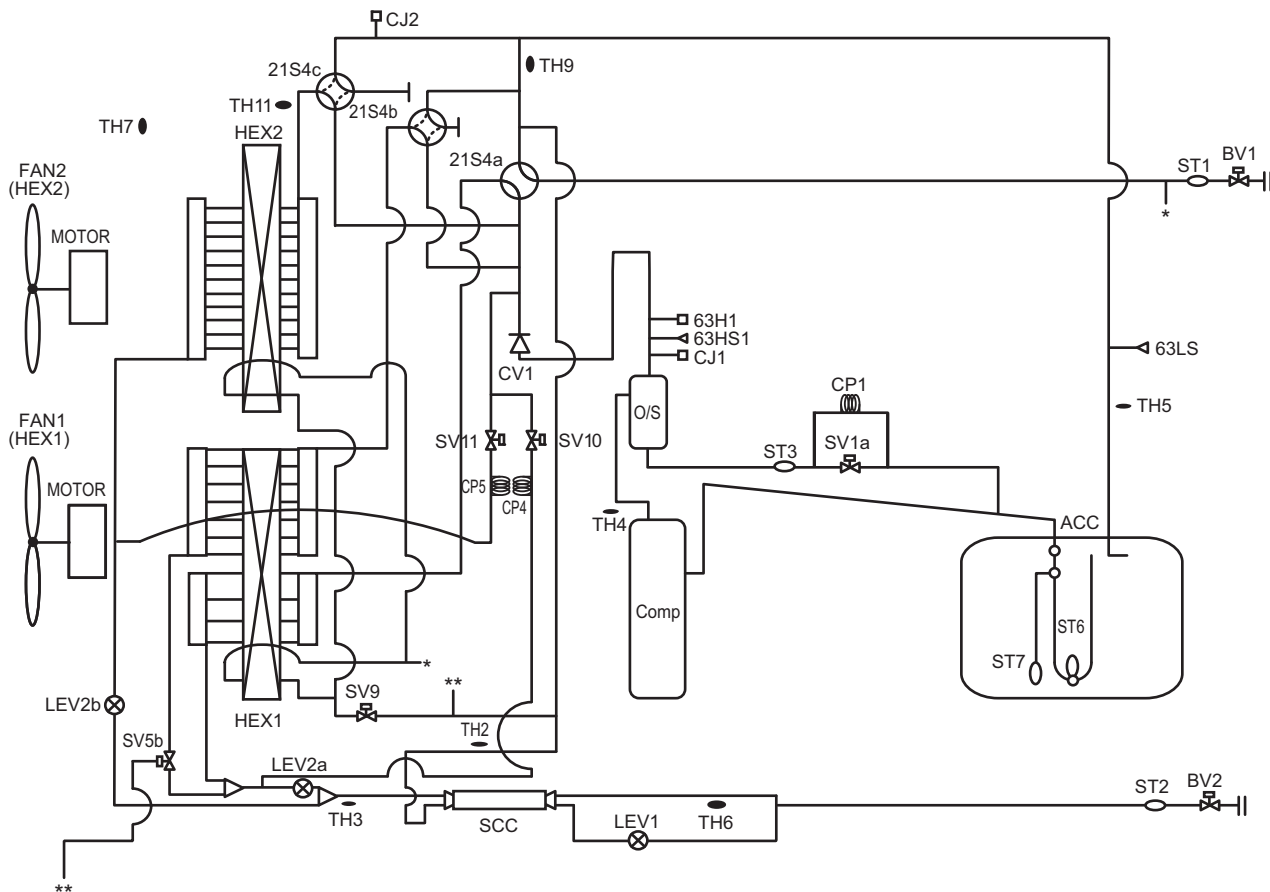

### 3-3 Functions of the Major Components of Outdoor Unit

Part name	Symbols (functions)	Notes	Usage	Specifications	Check method
Com-pressor	MC1 (Comp1)		Adjusts the amount of circulating refrigerant by adjusting the operating frequency based on the operating pressure data	P200, P250 models Low-pressure shell scroll compressor wirewound resistance 20°C [68°F] : 0.72 Ω P300, P350 models Low-pressure shell scroll compressor wirewound resistance 20°C [68°F] : 0.32 Ω P400 model Low-pressure shell scroll compressor wirewound resistance 20°C [68°F] : 0.30 Ω P450, P500 models Low-pressure shell scroll compressor wirewound resistance 20°C [68°F] : 0.43 Ω	
High pressure sensor	63HS1		1) Detects high pressure 2) Regulates frequency and provides high-pressure protection	<p>                         Pressure                          0~4.15 MPa [601psi]                          Vout 0.5~3.5V                          0.071V/0.098 MPa [14psi]                          Pressure [MPa]                          =1.38 x Vout [V]-0.69                          Pressure [psi]                          =(1.38 x Vout [V] - 0.69) x 145                          1 GND (Black)                          2 Vout (White)                          3 Vcc (DC5V) (Red)                     </p>	
Low pressure sensor	63LS		1) Detects low pressure 2) Provides low-pressure protection 3) Defrost control during heating operation	<p>                         Pressure                          0~1.7 MPa [247psi]                          Vout 0.5~3.5V                          0.173V/0.098 MPa [14psi]                          Pressure [MPa]                          =0.566 x Vout [V] - 0.283                          Pressure [psi]                          =(0.566 x Vout [V] - 0.283) x 145                          1 GND (Black)                          2 Vout (White)                          3 Vcc (DC5V) (Red)                     </p>	
Pressure switch	63H1		1) Detects high pressure 2) Provides high-pressure protection	4.15MPa[601psi] OFF setting	

[3-3 Functions of the Major Components of Outdoor Unit ]

Part name	Symbols (functions)	Notes	Usage	Specifications	Check method
Thermistor	TH4 (Discharge)		1) Detects discharge air temperature 2) Provides high-pressure protection	Degrees Celsius $R_{120} = 7.465k\Omega$ $R_{25/120} = 4057$ $R_t = 7.465 \exp\{4057(\frac{1}{273+t} - \frac{1}{393})\}$	Resistance check
			0°C[32°F] :698 kΩ 10°C[50°F] :413 kΩ 20°C[68°F] :250 kΩ 30°C[86°F] :160 kΩ 40°C[104°F] :104 kΩ 50°C[122°F] :70 kΩ 60°C[140°F] :48 kΩ 70°C[158°F] :34 kΩ 80°C[176°F] :24 kΩ 90°C[194°F] :17.5 kΩ 100°C[212°F] :13.0 kΩ 110°C[230°F] :9.8 kΩ		
	TH2		LEV 1 is controlled based on the TH2, TH3, and TH6 values.	Degrees Celsius $R_0 = 15k\Omega$ $R_{0/80} = 3460$ $R_t = 15 \exp\{3460 (\frac{1}{273+t} - \frac{1}{273})\}$	Resistance check
	TH3 (Pipe temperature)		1) Controls frequency 2) Controls defrosting during heating operation		
	TH7 (Outdoor temperature)		1) Detects outdoor air temperature 2) Controls fan operation	0°C[32°F] :15 kΩ 10°C[50°F] :9.7 kΩ 20°C[68°F] :6.4 kΩ 25°C[77°F] :5.3 kΩ 30°C[86°F] :4.3 kΩ 40°C[104°F] :3.1 kΩ	
	TH5		LEV2 are controlled based on the 63LS and TH5 values.		
	TH6		Controls LEV1 based on TH2, TH3, and TH6 data.		
	TH9,11		Determines the completion of Continuous heating cycle mode.		
THHS Inverter heat sink temperature		Controls inverter cooling fan based on THHS temperature	Degrees Celsius $R_{50} = 17k\Omega$ $R_{25/120} = 4016$ $R_t = 17 \exp\{4016 (\frac{1}{273+t} - \frac{1}{323})\}$		
			0°C[32°F] :161 kΩ 10°C[50°F] :97 kΩ 20°C[68°F] :60 kΩ 25°C[77°F] :48 kΩ 30°C[86°F] :39 kΩ 40°C[104°F] :25 kΩ		
THL DCL temperature		DCL overheat protection	Degrees Celsius $R_{100} = 3.3k\Omega$ $B_{0/100} = 3970$ $R_t = 3.3 \exp\{3970(\frac{1}{273+t} - \frac{1}{373})\}$		
			0°C[32°F] :162.2 kΩ 10°C[50°F] :98.3 kΩ 25°C[77°F] :49.1 kΩ 50°C[122°F] :17.6 kΩ 100°C[212°F] :3.3 kΩ		

[3-3 Functions of the Major Components of Outdoor Unit ]

Part name	Symbols (functions)	Notes	Usage	Specifications	Check method
Solenoid valve	SV1a Discharge-suction bypass		1) High/low pressure bypass at start-up and stopping, and capacity control during low-load operation 2) High-pressure-rise prevention	AC220-240V Open while being powered/ closed while not being powered	Continuity check with a tester
	SV5b Heat exchanger capacity control	P450, P500 models only	Controls outdoor unit heat exchanger capacity	AC220-240V Closed while being powered/ open while not being powered	
	SV9		High-pressure-rise prevention	Open while being powered/ closed while not being powered	
	SV10		Continuous heating cycle mode	Open while being powered/ closed while not being powered	
	SV11		Continuous heating cycle mode	Open while being powered/ closed while not being powered	
Linear expansion valve	LEV1 (SC control)		Adjusts the amount of bypass flow from the liquid pipe on the outdoor unit during cooling	DC12V Opening of a valve driven by a stepping motor 0-480 pulses (direct driven type)	Same as indoor LEV The resistance value differs from that of the indoor LEV. Refer to the following page(s). [8-8 Troubleshooting LEV Problems](page 258)
	LEV2a (Refrigerant flow adjustment)		Adjusts refrigerant flow during heating Cut off the refrigerant flow during continuous heating cycle	DC12V Opening of a valve driven by a stepping motor 2100 pulses (Max. 3000 pulses)	
	LEV2b (Refrigerant flow adjustment)				
4-way valve	21S4a		Changeover between heating and cooling	AC220-240V Dead: cooling cycle Live: heating cycle	Continuity check with a tester
	21S4b	P450, P500 models only	1) Changeover between heating and cooling 2) Controls outdoor unit heat exchanger capacity	AC220-240V Dead: cooling cycle Outdoor unit heat exchanger capacity at 100% Live: heating cycle Outdoor unit heat exchanger capacity at 25%, 50% or heating cycle	
	21S4c				
Fan motor	FAN motor 1,2	FAN motor 2 is only on the P450, P500 models.	Regulates the heat exchanger capacity by adjusting the operating frequency and operating the propeller fan based on the operating pressure.	AC380-400V, 920W *The P200-P400 models and the P450 model are equipped with different types of fan motors.	

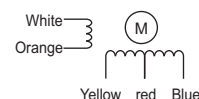

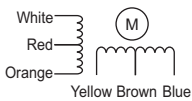

### 3-4 Functions of the Major Components of Indoor Unit

Part Name	Symbol (functions)	Notes	Usage	Specification	Check method
Linear expansion valve	LEV		1) Adjusts superheat at the indoor heat exchanger outlet during cooling 2) Adjusts subcool at the indoor unit heat exchanger outlet during heating	DC12V Opening of stepping motor driving valve 0-(1800) pulses	Refer to the section "Continuity Test with a Tester". Continuity between white, red, and orange. Continuity between yellow, brown, and blue. 
Thermistor	TH1 (Suction air temperature)		Indoor unit control (Thermo)	$R_0=15k\Omega$ $R_{0/80}=3460$ $R_t = 15 \exp\left\{3460\left(\frac{1}{273+t} - \frac{1}{273}\right)\right\}$ 0°C [32°F]:15 kΩ 10°C [50°F] :9.7 kΩ 20°C [68°F]:6.4 kΩ 25°C [77°F] :5.3 kΩ 30°C [86°F] :4.3 kΩ 40°C [104°F] :3.1 kΩ	Resistance check
	TH2 (Pipe temperature)		1) Indoor unit control (Frost prevention, Hot adjust) 2) LEV control during heating operation (subcool detection).		
	TH3 (Gas pipe temperature)		LEV control during cooling operation (superheat detection)		
	TH4 Outdoor air temperature*1		Indoor unit control (Thermo)		
	Temperature sensor (Indoor air temperature)		Indoor unit control (Thermo)		

\*1. Indicates gas pipe temperature on the PKFY-P VHM-E and PKFY-P VKM-E models.

---

## Chapter 4 Electrical Components and Wiring Diagrams

<b>4-1</b>	<b>Outdoor Unit Circuit Board Arrangement.....</b>	<b>67</b>
4-1-1	Outdoor Unit Control Box.....	67
4-1-2	Fan Box.....	70
<b>4-2</b>	<b>Outdoor Unit Circuit Board Components .....</b>	<b>71</b>
4-2-1	Control Board.....	71
4-2-2	M-NET Board (Transmission Power Supply Board) .....	72
4-2-3	INV Board .....	73
4-2-4	Fan Board .....	75
4-2-5	Noise Filter.....	76
4-2-6	Capacitor Board .....	78
4-2-7	Connect Board .....	79
<b>4-3</b>	<b>Outdoor Unit Electrical Wiring Diagrams .....</b>	<b>80</b>
<b>4-4</b>	<b>Transmission Booster Electrical Wiring Diagrams .....</b>	<b>82</b>



# 4-1 Outdoor Unit Circuit Board Arrangement

## 4-1-1 Outdoor Unit Control Box

**<HIGH VOLTAGE WARNING>**

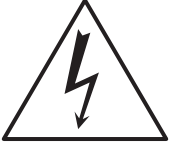

- Control box houses high-voltage parts.
- When opening or closing the front panel of the control box, do not let it come into contact with any of the internal components.
- Before inspecting the inside of the control box, turn off the power, keep the unit off for at least 10 minutes, and confirm that the voltage of the capacitor in the main circuit has dropped to 20 VDC or less.

**(1) PUHY-P200, P250, P300, P350, P400YKB-A1**

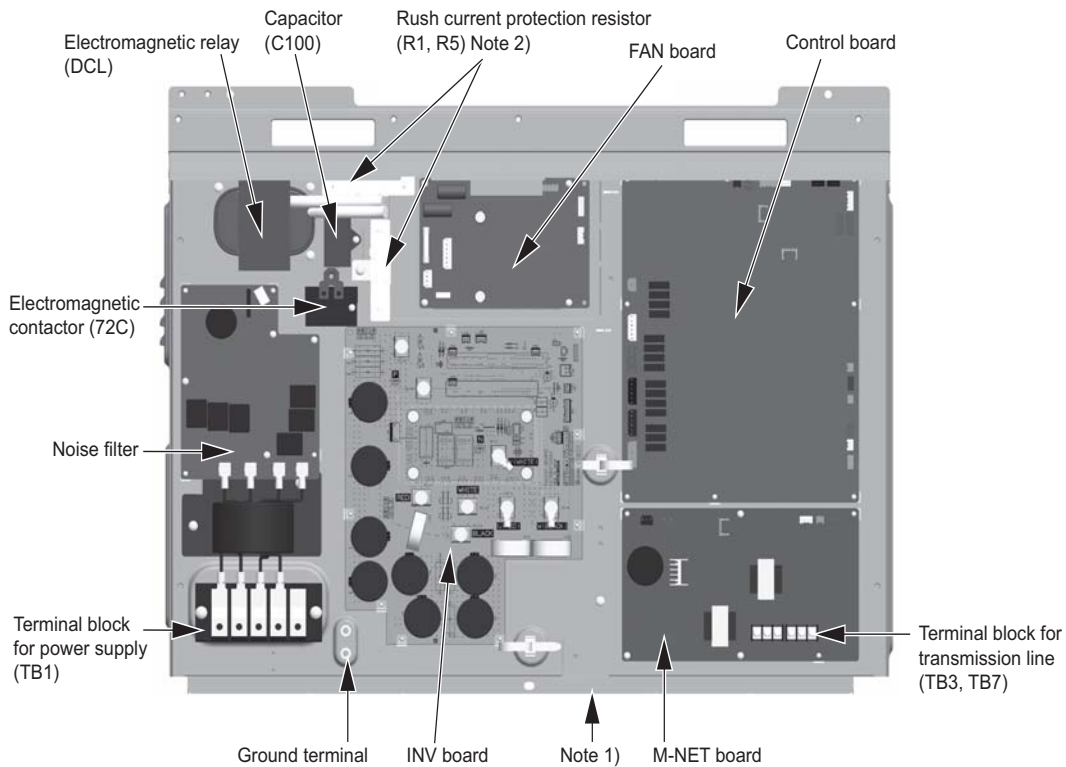

**Note**

- 1) Exercise caution not to damage the bottom and the front panel of the control box. Damage to these parts affect the water-proof and dust proof properties of the control box and may result in damage to its internal components.
- 2) Faston terminals have a locking function. Make sure the cable heads are securely locked in place. Press the tab on the terminals to remove them.
- 3) Control box houses high temperature parts. Be well careful even after turning off the power source.
- 4) **Perform the service after disconnecting the outdoor unit fan board connector (CNINV) and the inverter board connector (CN1). Before plugging in or unplugging connectors, check that the outdoor unit fan is not rotating and that the voltage between FT-P and FT-N on the INV board is 20 VDC or less. The capacitor may collect a charge and cause an electric shock when the outdoor unit fan rotates in windy conditions.** Refer to the wiring nameplate for details.
- 5) To connect wiring to TB7, check that the voltage is 20 VDC or below.
- 6) Reconnect the connector (CNINV) back to the fan board and reconnect the connector (CN1) back to the inverter board after servicing.
- 7) When opening or closing the front panel of the control box, do not let it come into contact with any of the internal components. Before plugging in or unplugging connectors, check that the outdoor unit fan is not rotating and that the voltage between FT-P and FT-N on the INV board is 20 VDC or less. It takes about 10 minutes to discharge electricity after the power supply is turned off.
- 8) When the power is on, the compressor or heater is energized even while the compressor is stopped. Before turning on the power, disconnect all power supply wires from the compressor terminal block, and measure the insulation resistance of the compressor. Check the compressor for a ground fault. If the insulation resistance is 1.0 MΩ or below, connect all power supply wires to the compressor and turn on the power to the outdoor unit. It is energized to evaporate the liquid refrigerant that has accumulated in the compressor.

(2) PUHY-P450, P500YKB-A1

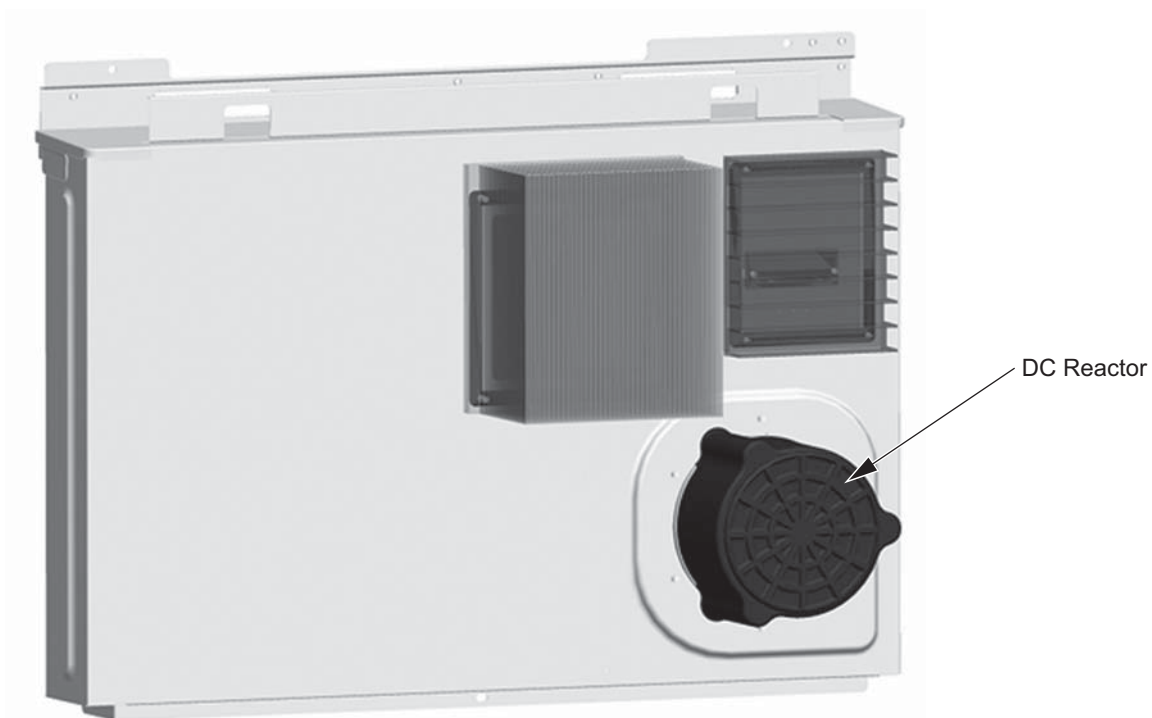
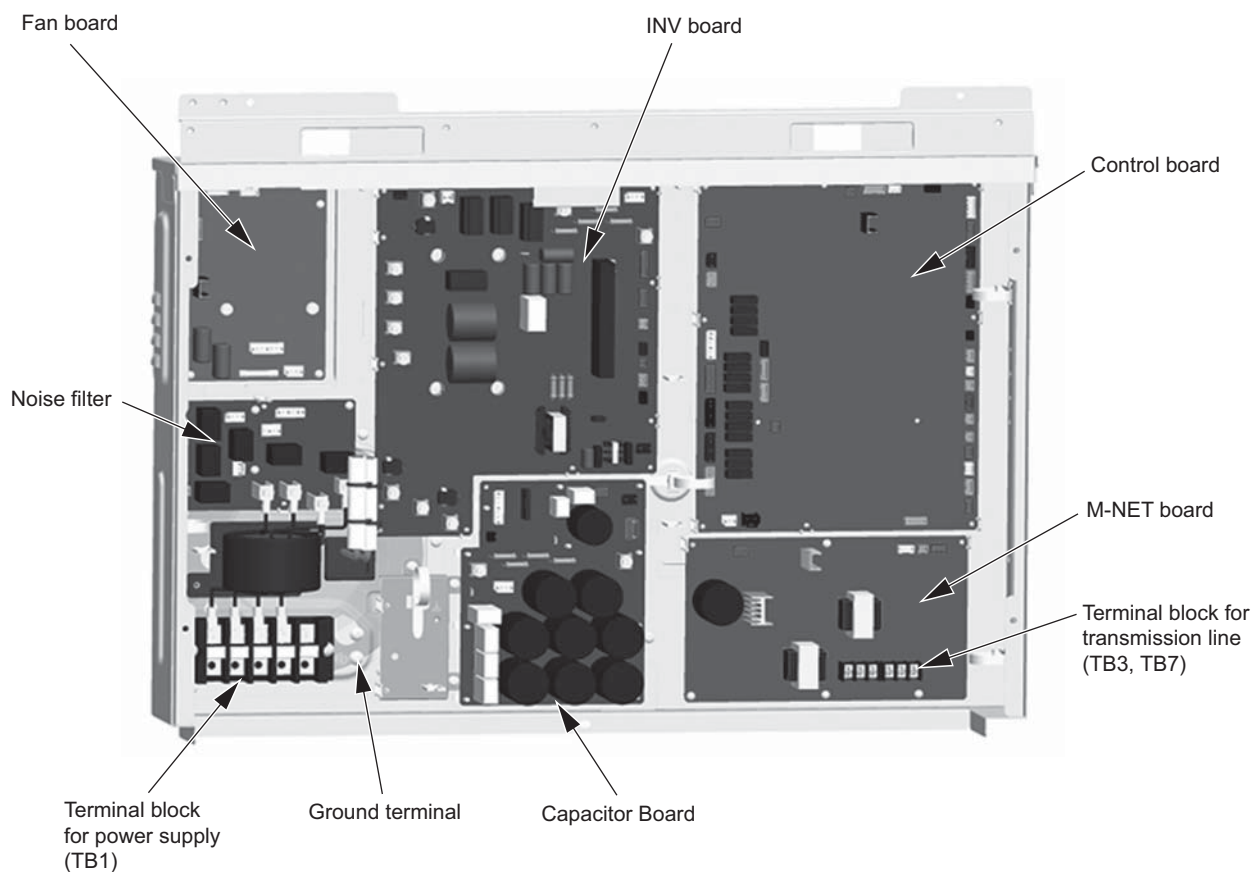

**Note**

- 1) Exercise caution not to damage the bottom and the front panel of the control box. Damage to these parts affect the water-proof and dust proof properties of the control box and may result in damage to its internal components.
- 2) Faston terminals have a locking function. Make sure the cable heads are securely locked in place. Press the tab on the terminals to remove them.
- 3) Control box houses high temperature parts. Be well careful even after turning off the power source.
- 4) **Perform the service after disconnecting the outdoor unit fan board connector (CNINV) and the inverter board connector (CN1). Before plugging in or unplugging connectors, check that the outdoor unit fan is not rotating and that the voltage between SC-P and SC-N on the capacitor board is 20 VDC or less. The capacitor may collect a charge and cause an electric shock when the outdoor unit fan rotates in windy conditions.** Refer to the wiring nameplate for details.
- 5) To connect wiring to TB7, check that the voltage is 20 VDC or below.
- 6) Reconnect the connector (CNINV) back to the fan board and reconnect the connector (CN1) back to the inverter board after servicing.
- 7) When opening or closing the front panel of the control box, do not let it come into contact with any of the internal components. Before inspecting the inside of the control box, turn off the power, keep the unit off for at least 10 minutes, and confirm that the capacitor voltage (inverter main circuit) has dropped to 20 V DC or less. It takes about 10 minutes to discharge electricity after the power supply is turned off.
- 8) When the power is on, the compressor or heater is energized even while the compressor is stopped. Before turning on the power, disconnect all power supply wires from the compressor terminal block, and measure the insulation resistance of the compressor. Check the compressor for a ground fault. If the insulation resistance is 1.0 MΩ or below, connect all power supply wires to the compressor and turn on the power to the outdoor unit. It is energized to evaporate the liquid refrigerant that has accumulated in the compressor.

## 4-1-2 Fan Box

(1) PUHY-P450, P500YKB-A1

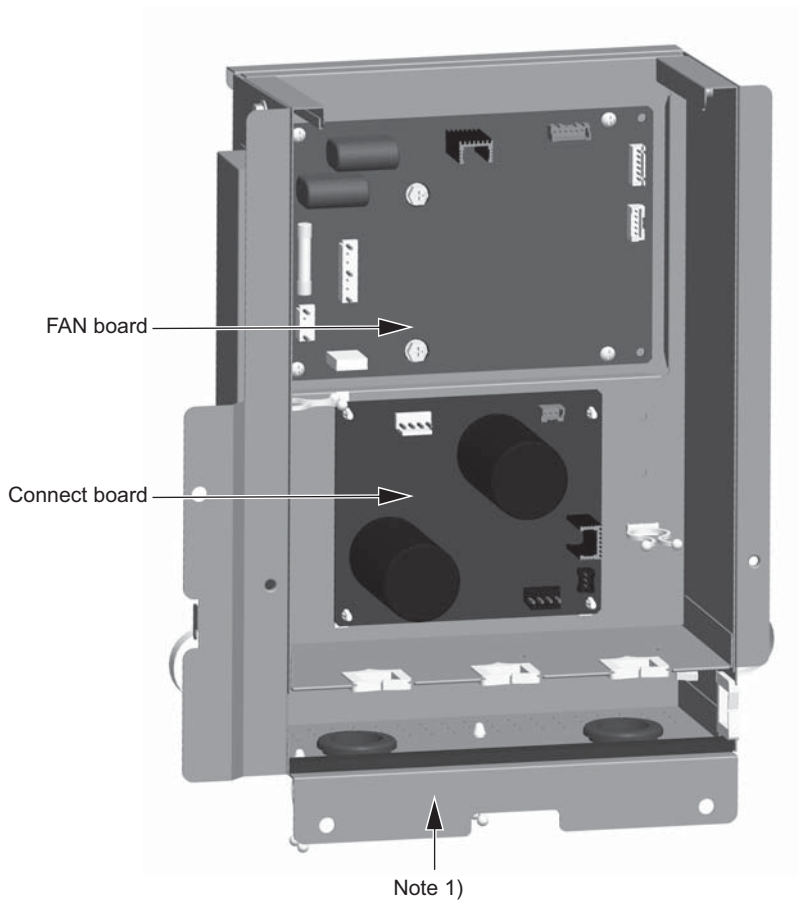

### Note

1. Handle the fan box with care. If the front or the bottom panel becomes damaged, water or dust may enter the fan box, damaging its internal parts.
2. **Perform the service after disconnecting the fan board connector (CNINV) and the connect board connector (CN103). Before plugging in or unplugging connectors, check that the outdoor unit fan is not rotating and that the voltage between FT-P and FT-N on the INV board or between SC-P and SC-N on the capacitor board is 20 VDC or less. The capacitor may collect a charge and cause an electric shock when the outdoor unit fan rotates in windy conditions.**
3. Reconnect the connector (CNINV) back to the fan board and reconnect the connector (CN103) back to the connect board after servicing.

# 4-2 Outdoor Unit Circuit Board Components

## 4-2-1 Control Board

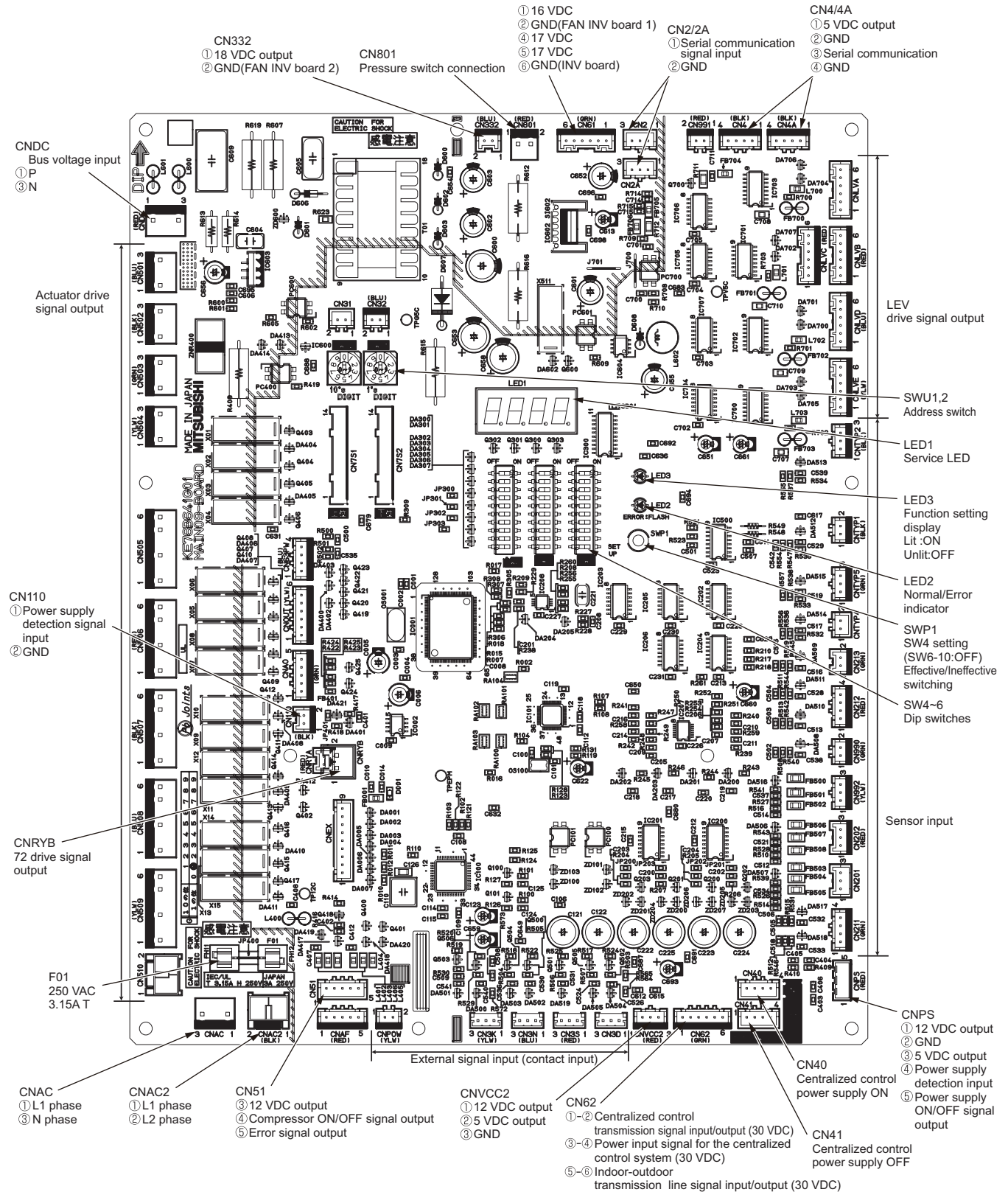

\*For information about the display of SW4 function settings, refer to the following page(s). [5-1-1 Outdoor Unit Switch Functions and Factory Settings](page 85)



### 4-2-2 M-NET Board (Transmission Power Supply Board)

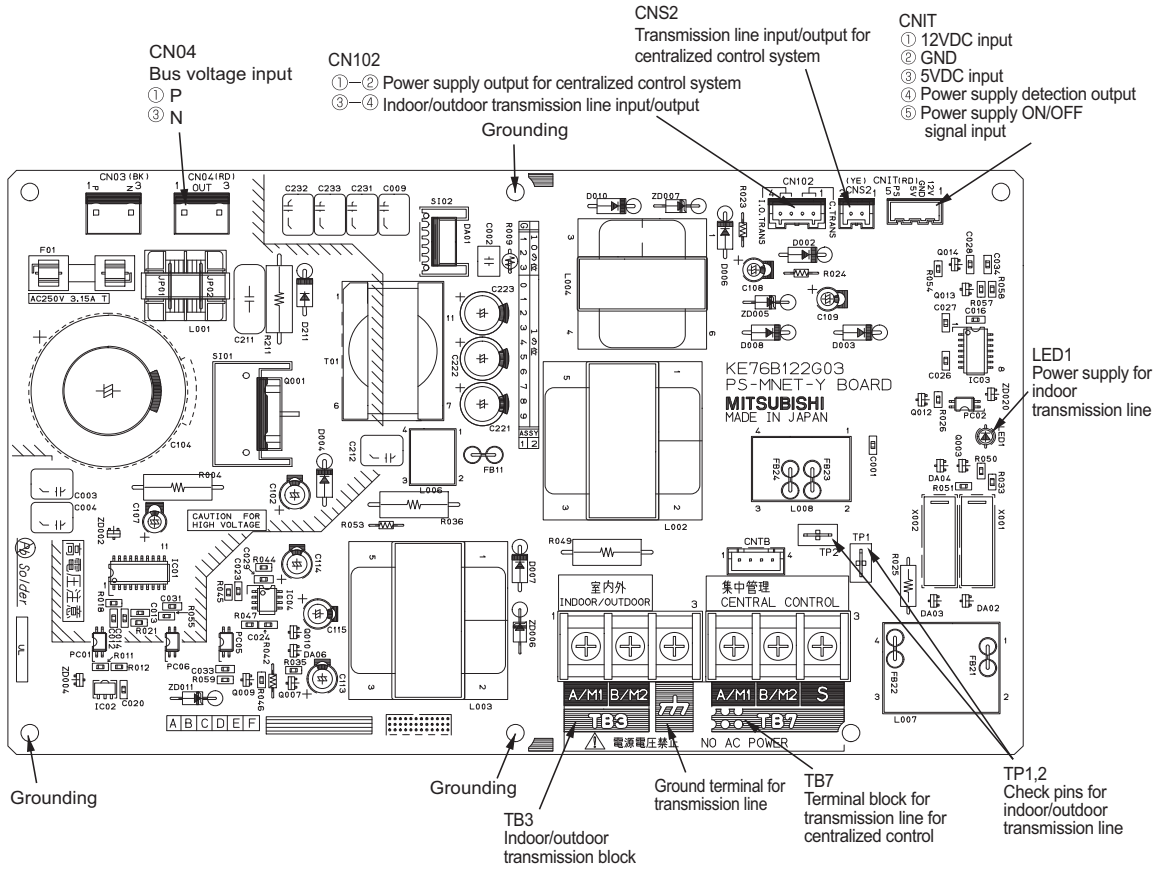

### 4-2-3 INV Board

#### (1) PUHY-P200, P250, P300, P350, P400YKB-A1

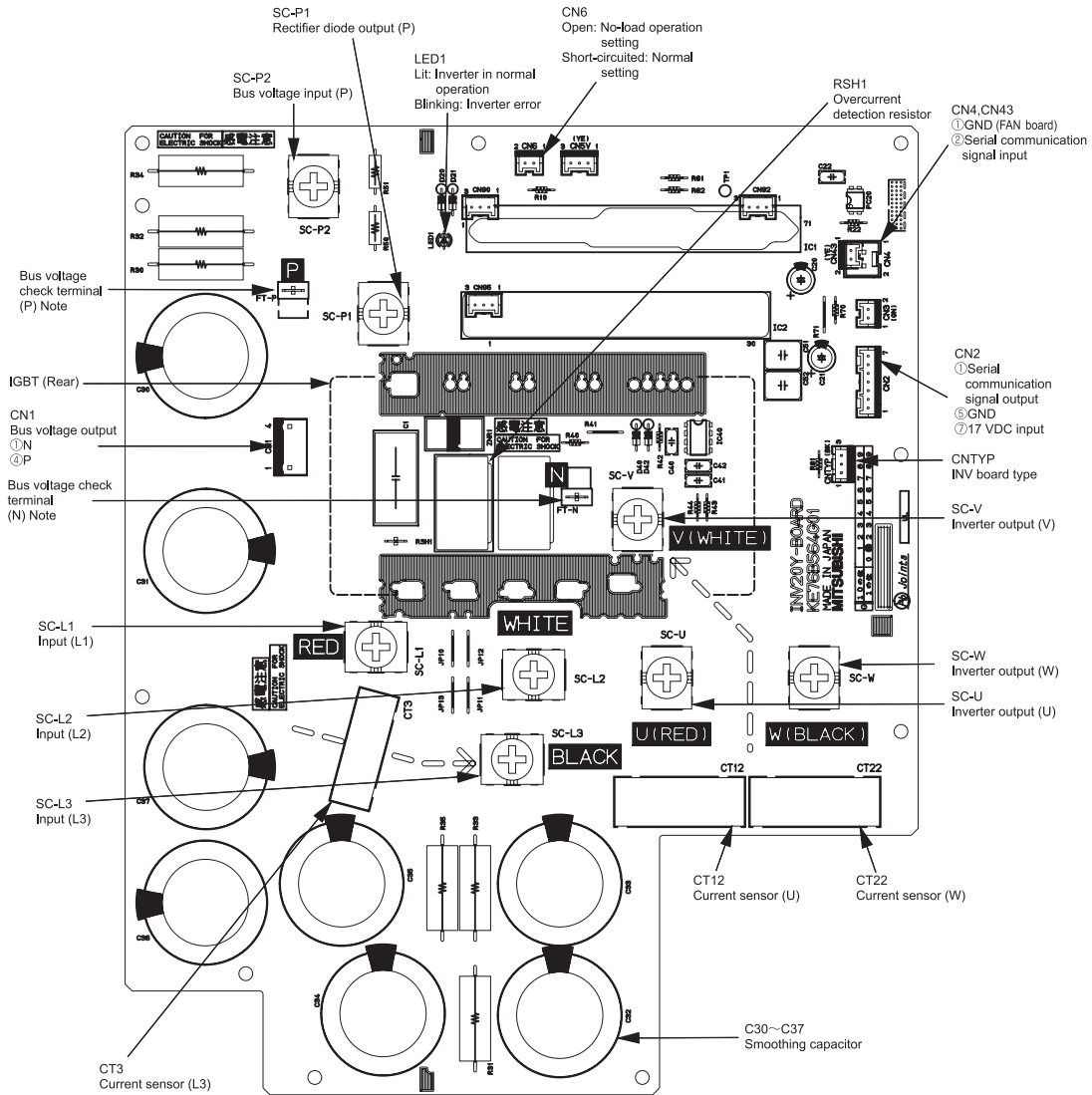

**Note**

- 1) When opening or closing the front panel of the control box, do not let it come into contact with any of the internal components. Before inspecting the inside of the control box, turn off the power, keep the unit off for at least 10 minutes, and confirm that the capacitor voltage (inverter main circuit) has dropped to 20 VDC or less. It takes about 10 minutes to discharge electricity after the power supply is turned off.
- 2) Faston terminals have a locking function. Make sure the cable heads are securely locked in place. Press the tab on the terminals to remove them.
- 3) Control box houses high temperature parts. Be well careful even after turning off the power source.
- 4) **Perform the service after disconnecting the outdoor unit fan board connector (CNINV) and the inverter board connector (CN1). Before plugging in or unplugging connectors, check that the outdoor unit fan is not rotating and that the voltage between FT-P and FT-N on the INV board is 20 VDC or less. The capacitor may collect a charge and cause an electric shock when the outdoor unit fan rotates in windy conditions. Refer to the wiring nameplate for details.**
- 5) To connect wiring to TB7, check that the voltage is 20 VDC or below.
- 6) Reconnect the connector (CNINV) back to the fan board and reconnect the connector (CN1) back to the inverter board after servicing.
- 7) When the power is turned on, the compressor is energized even while it is not operating. Before turning on the power, disconnect all power supply wires from the compressor terminal block, and measure the insulation resistance of the compressor. Check the compressor for a ground fault. If the insulation resistance is 1.0 MΩ or below, connect all power supply wires to the compressor and turn on the power to the outdoor unit. The liquid refrigerant in the compressor will evaporate by energizing the compressor.

(2) PUHY-P450, P500YKB-A1

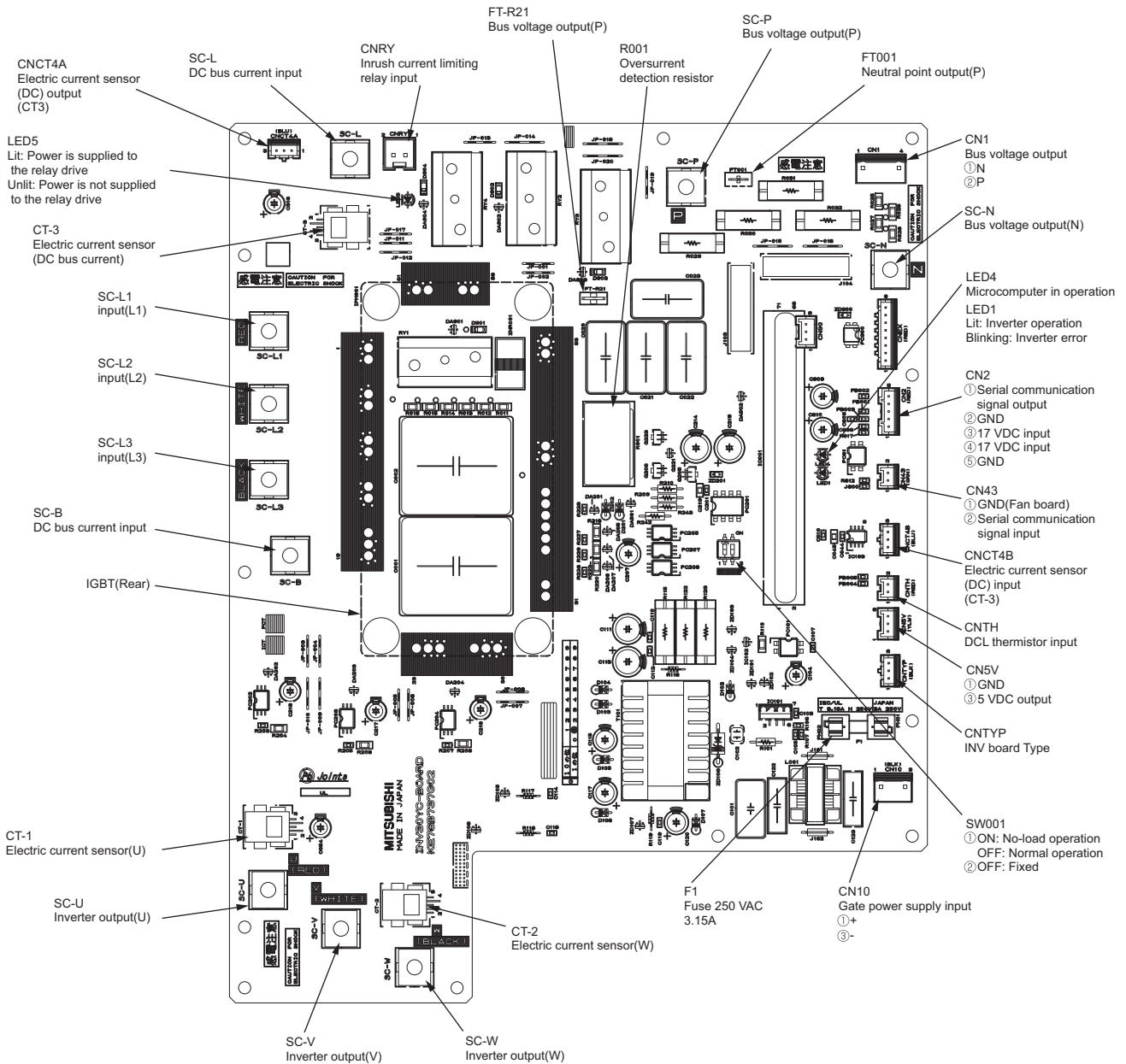

**Note**

- 1) When opening or closing the front panel of the control box, do not let it come into contact with any of the internal components. Before inspecting the inside of the control box, turn off the power, keep the unit off for at least 10 minutes, and confirm that the capacitor voltage (inverter main circuit) has dropped to 20 VDC or less. It takes about 10 minutes to discharge electricity after the power supply is turned off.
- 2) Faston terminals have a locking function. Make sure the cable heads are securely locked in place. Press the tab on the terminals to remove them.
- 3) Control box houses high temperature parts. Be well careful even after turning off the power source.
- 4) **Perform the service after disconnecting the outdoor unit fan board connector (CNINV) and the inverter board connector (CN1). Before plugging in or unplugging connectors, check that the outdoor unit fan is not rotating and that the voltage between SC-P and SC-N on the capacitor board is 20 VDC or less. The capacitor may collect a charge and cause an electric shock when the outdoor unit fan rotates in windy conditions. Refer to the wiring nameplate for details.**
- 5) To connect wiring to TB7, check that the voltage is 20 VDC or below.
- 6) Reconnect the connector (CNINV) back to the fan board and reconnect the connector (CN1) back to the inverter board after servicing.
- 7) When the power is on, the compressor or heater is energized even while the compressor is stopped. Before turning on the power, disconnect all power supply wires from the compressor terminal block, and measure the insulation resistance of the compressor. Check the compressor for a ground fault. If the insulation resistance is 1.0 MΩ or below, connect all power supply wires to the compressor and turn on the power to the outdoor unit. It is energized to evaporate the liquid refrigerant that has accumulated in the compressor.

### 4-2-4 Fan Board

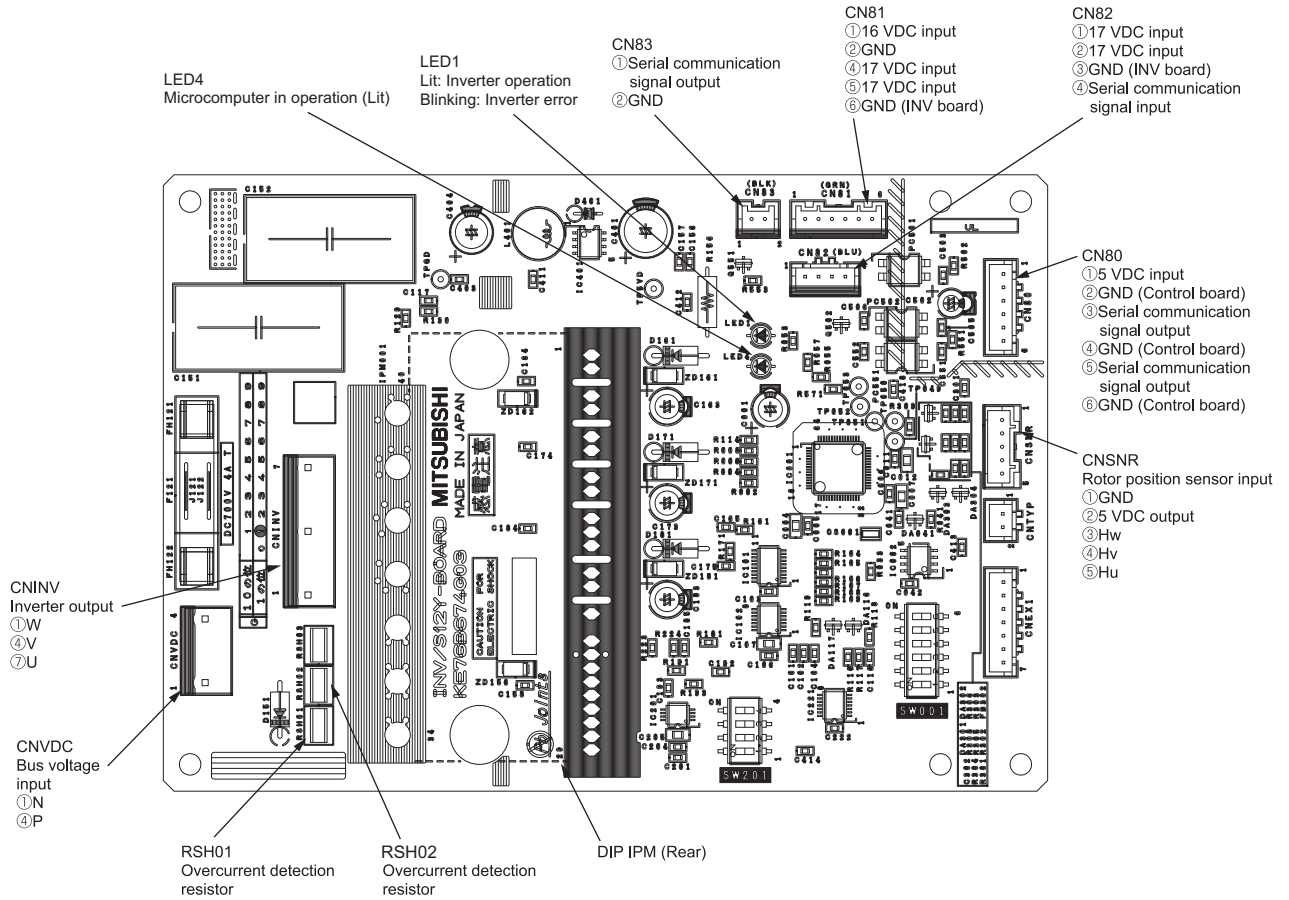

**Note**

- 1) When opening or closing the front panel of the control box, do not let it come into contact with any of the internal components. Before inspecting the inside of the control box, turn off the power, keep the unit off for at least 10 minutes, and confirm that the capacitor voltage (inverter main circuit) has dropped to 20 VDC or less. It takes about 10 minutes to discharge electricity after the power supply is turned off.
- 2) Control box houses high temperature parts. Be well careful even after turning off the power source.
- 3) **Perform the service after disconnecting the outdoor unit fan board connector (CNINV) and the inverter board connector (CN1). Before plugging in or unplugging connectors, check that the outdoor unit fan is not rotating and that the voltage between FT-P and FT-N on the INV board or between SC-P and SC-N on the capacitor board is 20 VDC or less. The capacitor may collect a charge and cause an electric shock when the outdoor unit fan rotates in windy conditions.** Refer to the wiring nameplate for details.
- 4) To connect wiring to TB7, check that the voltage is 20 VDC or below.
- 5) Reconnect the connector (CNINV) back to the fan board and reconnect the connector (CN1) back to the inverter board after servicing.

### 4-2-5 Noise Filter

(1) PUHY-P200, P250, P300, P350, P400YKB-A1

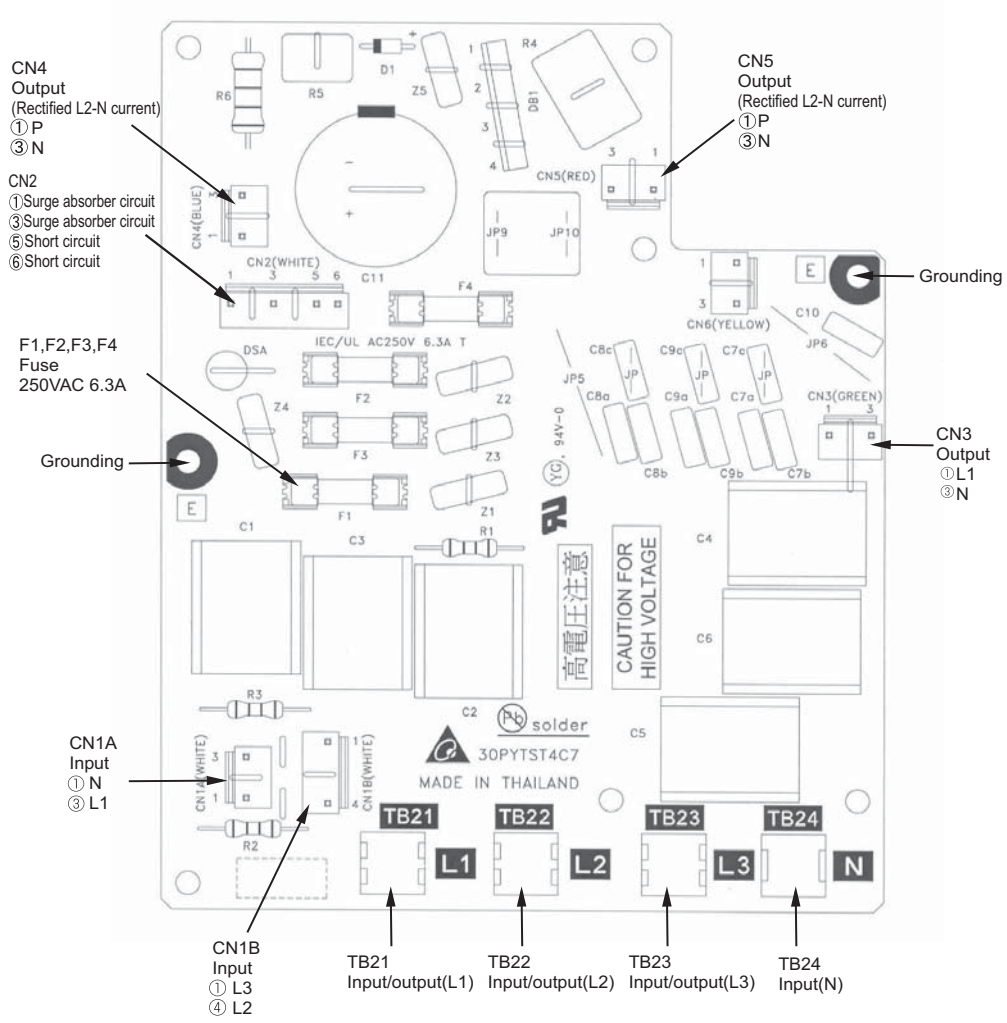

(2) PUHY-P450, P500YKB-A1

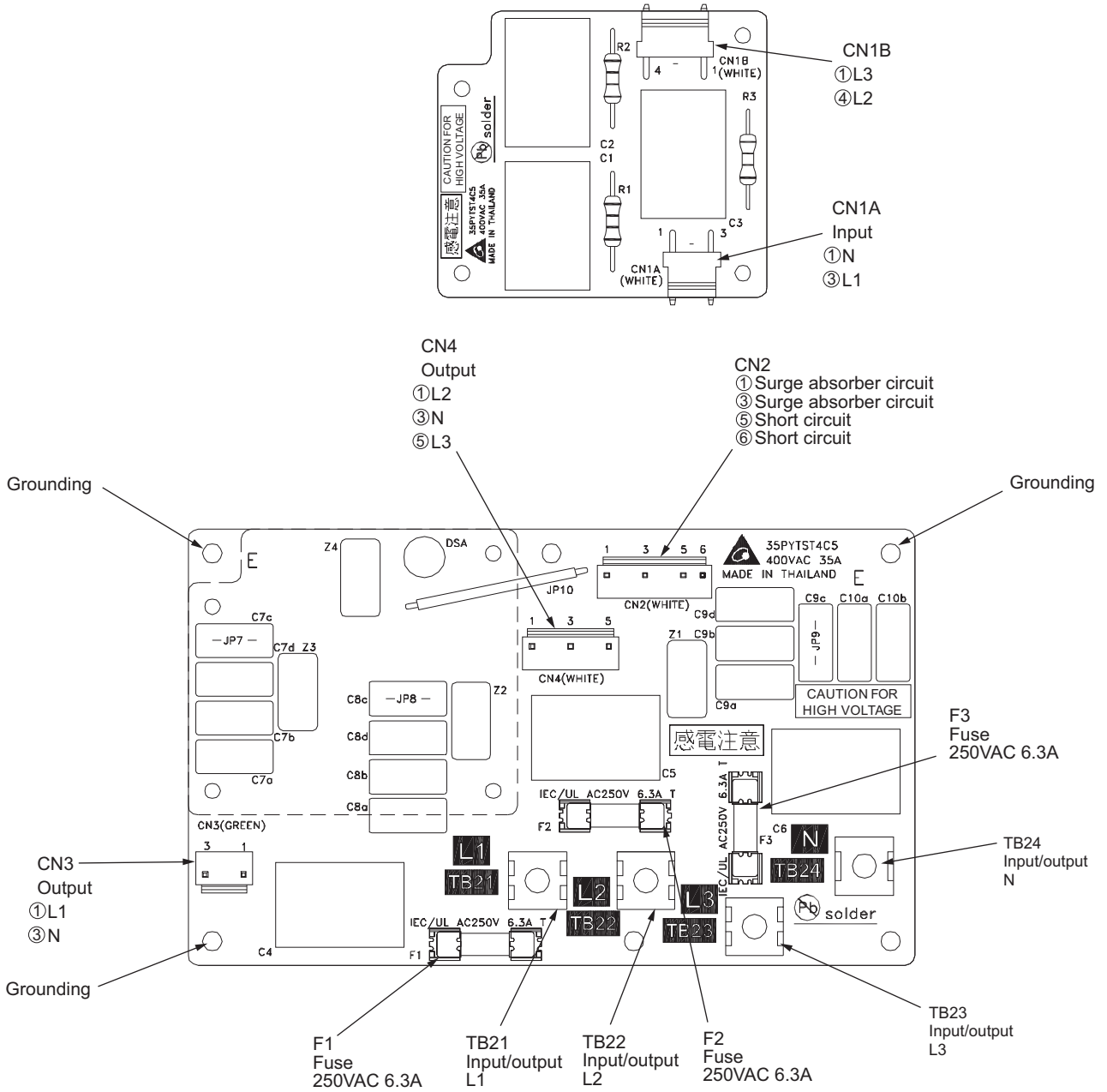

## 4-2-6 Capacitor Board

### (1) PUHY-P450, P500YKB-A1

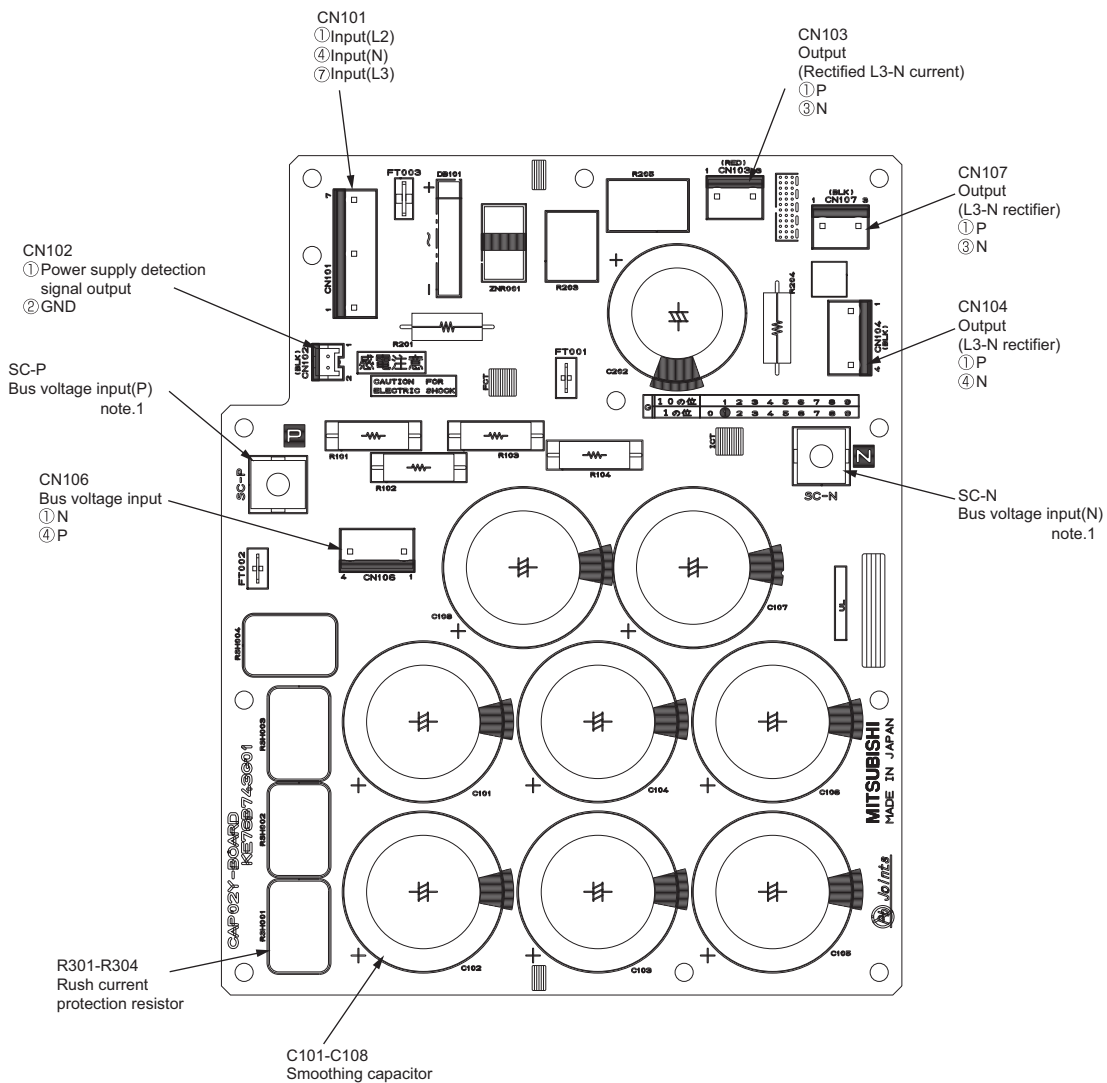

#### Note

- 1) When opening or closing the front panel of the control box, do not let it come into contact with any of the internal components. Before inspecting the inside of the control box, turn off the power, keep the unit off for at least 10 minutes, and confirm that the capacitor voltage (inverter main circuit) has dropped to 20 VDC or less. It takes about 10 minutes to discharge electricity after the power supply is turned off.
- 2) Control box houses high temperature parts. Be well careful even after turning off the power source.
- 3) **Perform the service after disconnecting the fan board connector (CNINV) and the connector board connector (CN103). Before plugging in or unplugging connectors, check that the outdoor unit fan is not rotating and that the voltage between SC-P and SC-N on the capacitor board is 20 VDC or less. The capacitor may collect a charge and cause an electric shock when the outdoor unit fan rotates in windy conditions.** Refer to the wiring nameplate for details.
- 4) To connect wiring to TB7, check that the voltage is 20 VDC or below.
- 5) Reconnect the connector (CNINV) back to the fan board and reconnect the connector (CN103) back to the connector board after servicing.

### 4-2-7 Connect Board

(1) PUHY-P450, P500YKB-A1

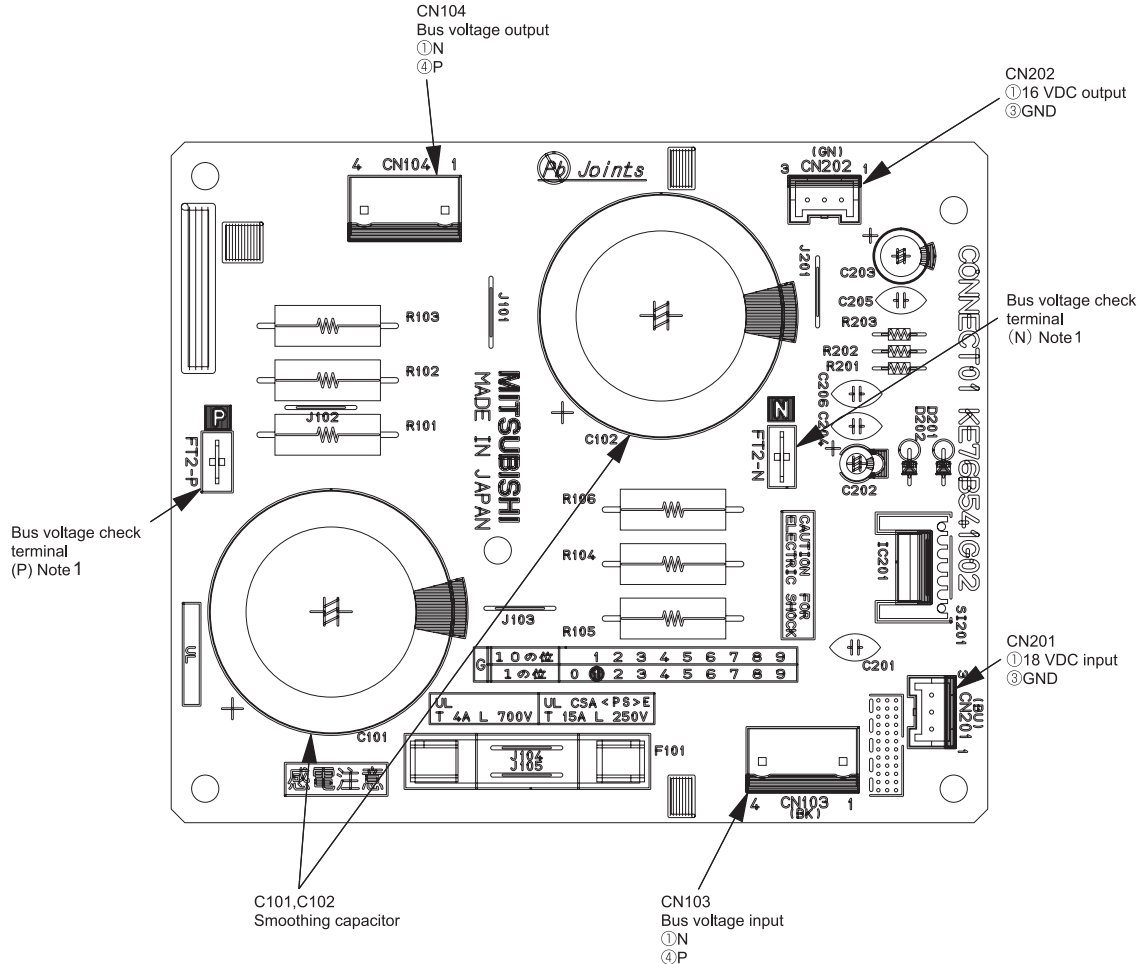

**Note**

- 1) When opening or closing the front panel of the control box, do not let it come into contact with any of the internal components. Before inspecting the inside of the control box, turn off the power, keep the unit off for at least 10 minutes, and confirm that the capacitor voltage (inverter main circuit) has dropped to 20 VDC or less. It takes about 10 minutes to discharge electricity after the power supply is turned off.
- 2) Control box houses high temperature parts. Be well careful even after turning off the power source.
- 3) **Perform the service after disconnecting the fan board connector (CNINV) and the connector board connector (CN103). Before plugging in or unplugging connectors, check that the outdoor unit fan is not rotating and that the voltage between FT-P and FT-N on the INV board or between SC-P and SC-N on the capacitor board is 20 VDC or less. The capacitor may collect a charge and cause an electric shock when the outdoor unit fan rotates in windy conditions. Refer to the wiring nameplate for details.**
- 4) To connect wiring to TB7, check that the voltage is 20 VDC or below.
- 5) Reconnect the connector (CNINV) back to the fan board and reconnect the connector (CN103) back to the connector board after servicing.



# 4-3 Outdoor Unit Electrical Wiring Diagrams

## (1) PUHY-P200, P250, P300, P350, P400 models

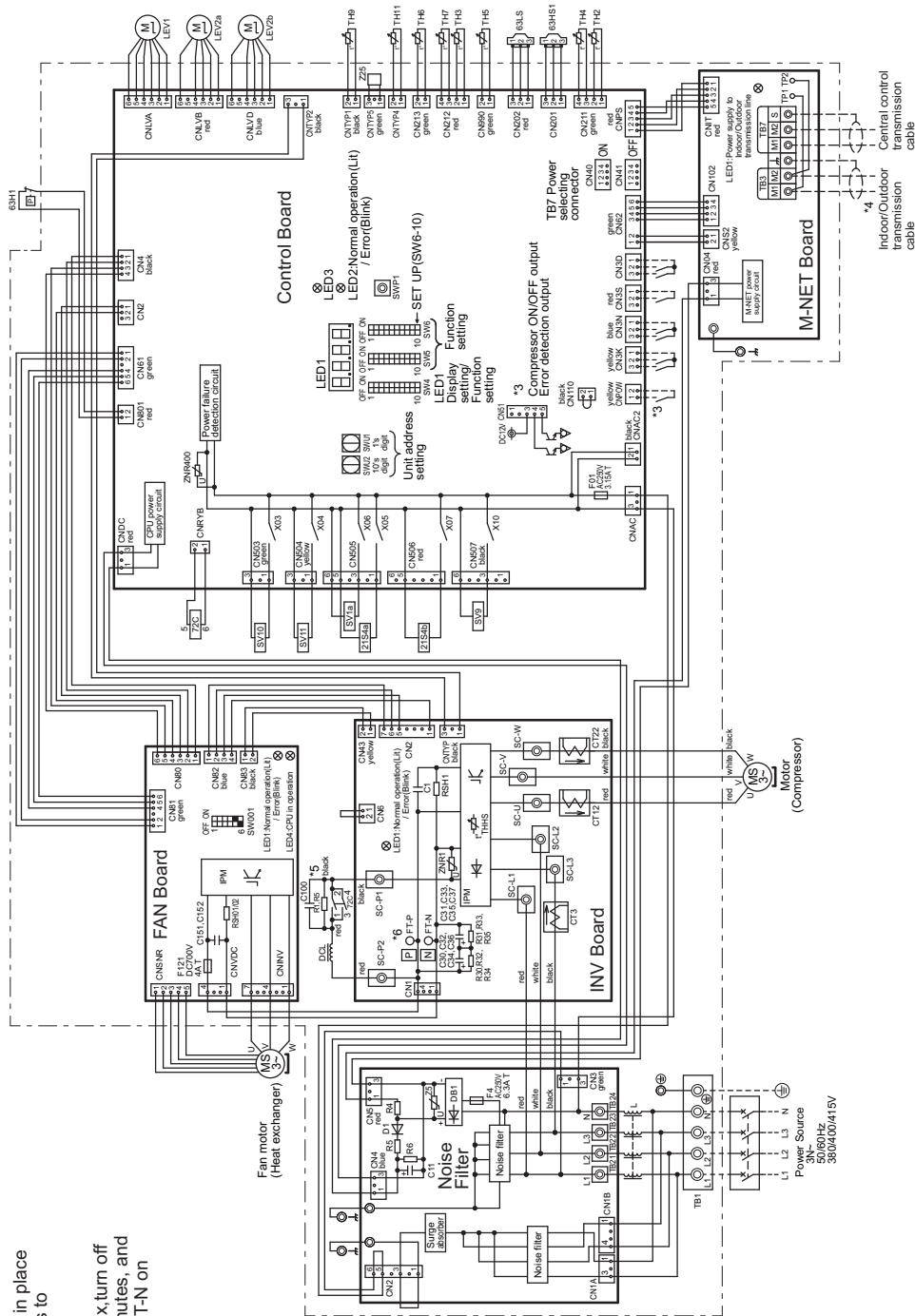

- \*1. Single-dotted lines indicate wiring not supplied with the unit.
- \*2. Dot-dash lines indicate the control box boundaries.
- \*3. Refer to the Data book for connecting input/output signal connectors.
- \*4. Daisy-chain terminals (TB3) on the outdoor units in the same refrigerant system together.
- \*5. Faston terminals have a locking function. Make sure the terminals are securely locked in place after insertion. Press the tab on the terminals to removed them.
- \*6. Control box houses high-voltage parts. Before inspecting the inside of the control box, turn off the power, keep the unit off for at least 10 minutes, and confirm that the voltage between FT-P and FT-N on INV Board has dropped to DC20V or less.

### <Symbol explanation>

Symbol	Explanation
Z1S4a	4-way valve (Cooling/Heating switching)
Z1S4b	Heat exchanger capacity control
63H1	Pressure switch
63HS1	Pressure sensor
63LS	Discharge pressure sensor
G30-C37	Low pressure sensor
G12/G12/G3	Magnetic relay (inverter main circuit)
DCL	Capacitor (inverter main circuit)
LEV1	DC reactor
LEV2a,b	Choke coil (for high frequency noise reduction)
R1.5	Linear expansion valve
RSW102/RS1	H/C bypass Controls refrigerant flow in H/C circuit
SV1a	Resistor
SV9	Pressure sensor
SV10.SV11	Temperature sensor
TB1	Terminal block
TB3	Terminal block
TB7	Terminal block
TH2	Thermistor
TH3	Thermistor
TH4	Thermistor
TH5	Thermistor
TH6	Thermistor
TH7	Thermistor
TH8	Thermistor
TH9	Thermistor
TH10	Thermistor
TH11	Thermistor
TH12	Thermistor
TH13	Thermistor
TH14	Thermistor
TH15	Thermistor
TH16	Thermistor
TH17	Thermistor
TH18	Thermistor
TH19	Thermistor
TH20	Thermistor
TH21	Thermistor
TH22	Thermistor
TH23	Thermistor
TH24	Thermistor
TH25	Thermistor
TH26	Thermistor
TH27	Thermistor
TH28	Thermistor
TH29	Thermistor
TH30	Thermistor
TH31	Thermistor
TH32	Thermistor
TH33	Thermistor
TH34	Thermistor
TH35	Thermistor
TH36	Thermistor
TH37	Thermistor
TH38	Thermistor
TH39	Thermistor
TH40	Thermistor
TH41	Thermistor
TH42	Thermistor
TH43	Thermistor
TH44	Thermistor
TH45	Thermistor
TH46	Thermistor
TH47	Thermistor
TH48	Thermistor
TH49	Thermistor
TH50	Thermistor
TH51	Thermistor
TH52	Thermistor
TH53	Thermistor
TH54	Thermistor
TH55	Thermistor
TH56	Thermistor
TH57	Thermistor
TH58	Thermistor
TH59	Thermistor
TH60	Thermistor
TH61	Thermistor
TH62	Thermistor
TH63	Thermistor
TH64	Thermistor
TH65	Thermistor
TH66	Thermistor
TH67	Thermistor
TH68	Thermistor
TH69	Thermistor
TH70	Thermistor
TH71	Thermistor
TH72	Thermistor
TH73	Thermistor
TH74	Thermistor
TH75	Thermistor
TH76	Thermistor
TH77	Thermistor
TH78	Thermistor
TH79	Thermistor
TH80	Thermistor
TH81	Thermistor
TH82	Thermistor
TH83	Thermistor
TH84	Thermistor
TH85	Thermistor
TH86	Thermistor
TH87	Thermistor
TH88	Thermistor
TH89	Thermistor
TH90	Thermistor
TH91	Thermistor
TH92	Thermistor
TH93	Thermistor
TH94	Thermistor
TH95	Thermistor
TH96	Thermistor
TH97	Thermistor
TH98	Thermistor
TH99	Thermistor
TH100	Thermistor
TH101	Thermistor
TH102	Thermistor
TH103	Thermistor
TH104	Thermistor
TH105	Thermistor
TH106	Thermistor
TH107	Thermistor
TH108	Thermistor
TH109	Thermistor
TH110	Thermistor
TH111	Thermistor
TH112	Thermistor
TH113	Thermistor
TH114	Thermistor
TH115	Thermistor
TH116	Thermistor
TH117	Thermistor
TH118	Thermistor
TH119	Thermistor
TH120	Thermistor
TH121	Thermistor
TH122	Thermistor
TH123	Thermistor
TH124	Thermistor
TH125	Thermistor
TH126	Thermistor
TH127	Thermistor
TH128	Thermistor
TH129	Thermistor
TH130	Thermistor
TH131	Thermistor
TH132	Thermistor
TH133	Thermistor
TH134	Thermistor
TH135	Thermistor
TH136	Thermistor
TH137	Thermistor
TH138	Thermistor
TH139	Thermistor
TH140	Thermistor
TH141	Thermistor
TH142	Thermistor
TH143	Thermistor
TH144	Thermistor
TH145	Thermistor
TH146	Thermistor
TH147	Thermistor
TH148	Thermistor
TH149	Thermistor
TH150	Thermistor
TH151	Thermistor
TH152	Thermistor
TH153	Thermistor
TH154	Thermistor
TH155	Thermistor
TH156	Thermistor
TH157	Thermistor
TH158	Thermistor
TH159	Thermistor
TH160	Thermistor
TH161	Thermistor
TH162	Thermistor
TH163	Thermistor
TH164	Thermistor
TH165	Thermistor
TH166	Thermistor
TH167	Thermistor
TH168	Thermistor
TH169	Thermistor
TH170	Thermistor
TH171	Thermistor
TH172	Thermistor
TH173	Thermistor
TH174	Thermistor
TH175	Thermistor
TH176	Thermistor
TH177	Thermistor
TH178	Thermistor
TH179	Thermistor
TH180	Thermistor
TH181	Thermistor
TH182	Thermistor
TH183	Thermistor
TH184	Thermistor
TH185	Thermistor
TH186	Thermistor
TH187	Thermistor
TH188	Thermistor
TH189	Thermistor
TH190	Thermistor
TH191	Thermistor
TH192	Thermistor
TH193	Thermistor
TH194	Thermistor
TH195	Thermistor
TH196	Thermistor
TH197	Thermistor
TH198	Thermistor
TH199	Thermistor
TH200	Thermistor

(2) PUHY-P450, P500 models

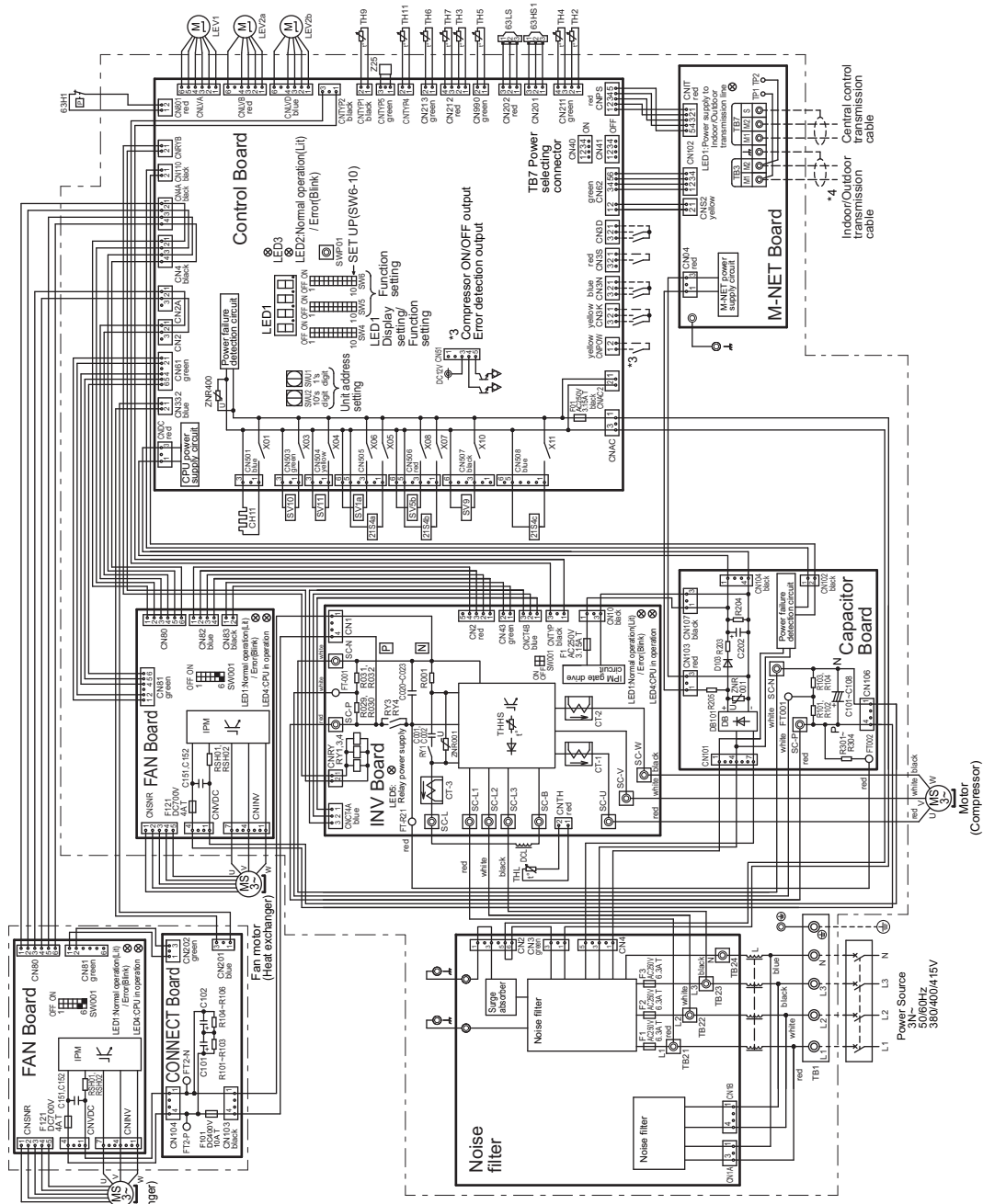

- \*1. Single-dotted lines indicate wiring not supplied with the unit.
- \*2. Dot-dash lines indicate the control box boundaries.
- \*3. Refer to the Data book for connecting input/output signal connectors.
- \*4. Daisy-chain terminals (TB3) on the outdoor units in the same refrigerant system together.
- \*5. Faston terminals have a locking function. Make sure the terminals are securely locked in place after insertion. Press the tab on the terminals to removed them.
- \*6. Control box houses high-voltage parts. Before inspecting the inside of the control box, turn off the power, keep the unit off for at least 10 minutes, and confirm that the voltage between SC-P and SC-N on Capacitor Board has dropped to DC20V or less.

Fan motor (Heat exchanger)

Motor (Compressor)

<<Symbol explanation>>

Symbol	Explanation
21S4a	4-way valve
21S4b,c	Cooling/Heating switching
63H1c	Heat exchanger capacity control
63H1	Pressure switch outdoor unit
63H51	Pressure sensor
63LS	Discharge pressure sensor
RY1	Magnetic relay
RY3, RY4	Filter circuit
C101-C108	Inverter main circuit
C001, C002	Inverter main circuit
CT-1, CT-2	Filter circuit
CT-3	AC sensor
CH1	DC reactor
DCL	Crankcase heater (for heating the compressor)
L	Choke coil (for high frequency noise reduction)
LEV1	Linear expansion valve
LEV2a,b	Pressure control, Refrigerant flow rate control
R301-R304	Resistor
RSH01, RSH02	For current detection
SV1a	Solenoid valve
SV5b	Outdoor unit heat exchanger capacity control
SV9	For opening/closing the bypass circuit
SV10, SV11	For opening/closing the defrost circuit
TB1	Terminal block
TB3	Indoor/Outdoor transmission cable
TB7	Central control transmission cable
TH2	Subcool bypass outlet temperature
TH3	Pipe temperature
TH4	Discharge pipe temperature
TH5	ACC inlet pipe temperature
TH6	Subcooled liquid refrigerant temperature
TH7	OA temperature
TH9, TH11	Heat exchanger outlet pipe temperature
THHS	IPM temperature
THL	DC reactor temperature
Z25	Function setting connector

# 4-4 Transmission Booster Electrical Wiring Diagrams

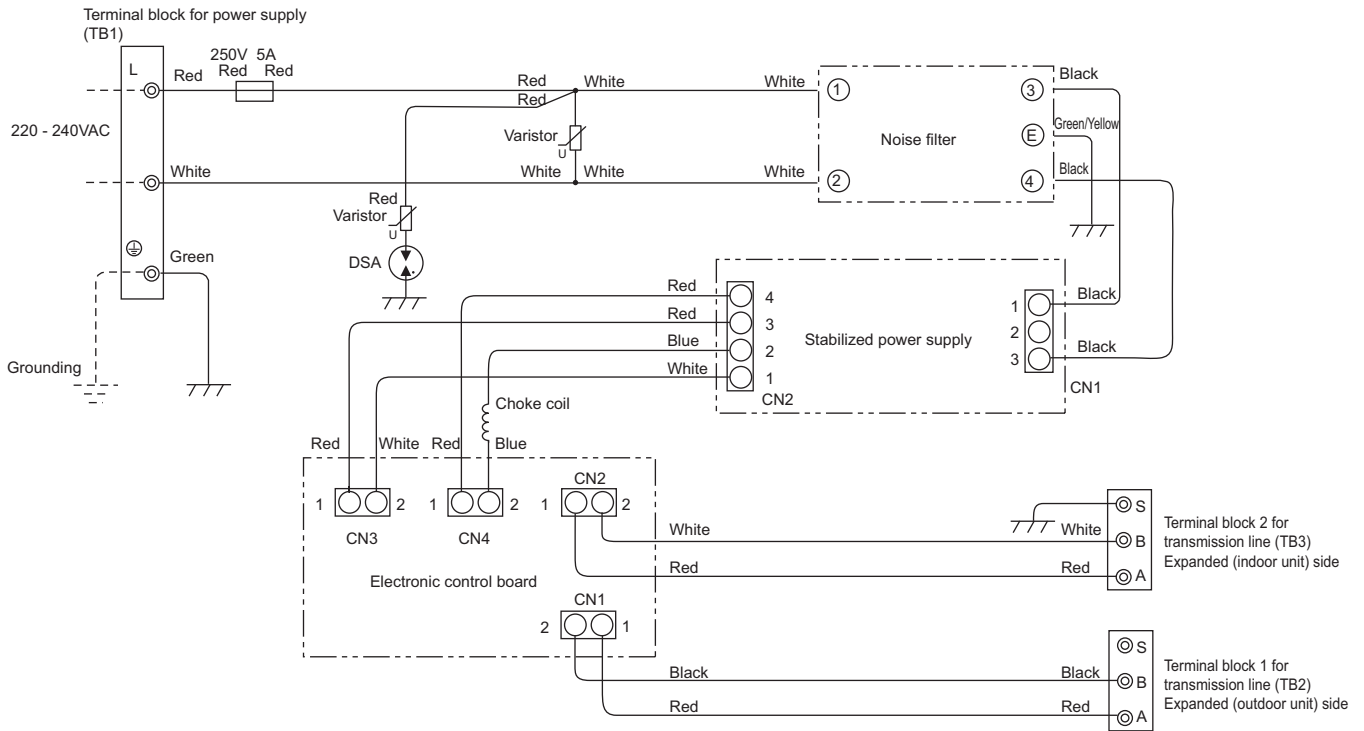

---

## Chapter 5 Control

<b>5-1</b>	<b>Dipswitch Functions and Factory Settings</b> .....	<b>85</b>
5-1-1	Outdoor Unit Switch Functions and Factory Settings .....	85
5-1-2	Indoor Unit Switch Functions and Factory Settings .....	89
5-1-3	Remote Controller Switch Functions and Factory Settings .....	91
<b>5-2</b>	<b>Outdoor Unit Control</b> .....	<b>93</b>
5-2-1	Overview .....	93
5-2-2	Rotation Control .....	93
5-2-3	Initial Control .....	93
5-2-4	Startup Control .....	93
5-2-5	Refrigerant Bypass Control .....	94
5-2-6	Frequency Control .....	95
5-2-7	Defrost Operation Control .....	96
5-2-8	Continuous heating mode control .....	97
5-2-9	Refrigerant Recovery Control .....	98
5-2-10	Outdoor Unit Fan Control .....	99
5-2-11	Subcool Coil Control (Linear Expansion Valve 1) .....	99
5-2-12	Refrigerant Flow Control (Linear Expansion Valves 2a and 2b) .....	99
5-2-13	Control at Initial Startup .....	99
5-2-14	Emergency Operation Mode .....	102
5-2-15	Operation Mode .....	105
5-2-16	Demand Control .....	105
5-2-17	Control of IH energization without the compressor in operation (not applicable to the P450 and P500 models)	105
5-2-18	Compressor heater control (P450 and P500 models) .....	105
<b>5-3</b>	<b>Operation Flowcharts</b> .....	<b>106</b>
5-3-1	Operation Sequence Flowchart .....	106
5-3-2	Actions Performed in Different Modes .....	108



# 5-1 Dipswitch Functions and Factory Settings

## 5-1-1 Outdoor Unit Switch Functions and Factory Settings

### (1) Control board

Switch		Function	Function according to switch setting		Switch setting timing	Units that require switch setting (Note 2)
			OFF	ON		
SWU	1-2	Unit address setting	Set to 00 or 51-100 with the dial switch		Before power on	C
SW5	1	Centralized control switch	Without connection to the centralized controller	With connection to the centralized controller	Before power on	B
	2	Deletion of connection information	Normal control	Deletion	Before power on	A
	3	-	Preset before shipment			-
	4	-				-
	5	-				-
	6	-				-
	7	-				-
	8	-				-
SW6	1	-	-	-	-	-
	2	COP priority setting (at low outside temperature)	Heating capacity priority control mode	Heating COP priority mode	Before power on	A
	3	-	-	-	-	-
	4	Model setting (outdoor unit/high static pressure setting)	Normal static pressure	High static pressure	Before power on	C
	5	Model setting (outdoor unit/high static pressure setting)	High (60 Pa)	High (30 Pa)	Before power on	C
	6	-	-	-	-	-
	7	Performance-priority/low-noise mode setting	Performance-priority mode (Note 3)	Quiet-priority mode (Note 5)	Anytime after power on	A
	8	Low-noise mode/step demand switching	Low-noise mode (Note 4)	Step demand mode	Before power on	C
	9	-	-	-	-	-
	10	Self-diagnosis monitor display / SW4 function setting mode switching	Self-diagnosis monitor display	SW4 function setting mode	Anytime after power on	C

5 Control

**Note**

- 1) Unless otherwise specified, leave the switch to OFF where indicated by "-", which may be set to OFF for a reason.
- 2) A: Only the switch on OC needs to be set for the setting to be effective.  
 B: The switches on both the OC and OS need to be set to the same setting for the setting to be effective.  
 C: The switches on both the OC and OS need to be set.
- 3) When set to the performance-priority mode, the low-noise mode will be terminated, and the units will operate in the normal mode.  
 Cooling: Ambient temperature or the high pressure is high.  
 Heating: When the outside air temperature is low or when the low pressure is low. Refer to the following page(s). [2-4-7 Various Control Methods Using the Signal Input/Output Connector on Outdoor Unit](page 25)
- 4) Operation noise is reduced by controlling the compressor frequencies and the rotation speed of the outdoor unit fans. CN3D needs to be set. Refer to the following page(s). [2-4-7 Various Control Methods Using the Signal Input/Output Connector on Outdoor Unit](page 25)
- 5) Operation noise is reduced by limiting the frequency of the compressor and rotation speed of the outdoor unit fan.

**(2) Additional dipswitch settings at time of shipment**

Switch		Function	Function according to switch setting		Switch setting timing	Units that require switch setting (Note 2)		
			OFF (LED3 Unlit)	ON (LED3 Lit)				
SW4 SW6-10: OFF	1-10 1:ON, 0:OFF	Self-diagnosis/operation monitor	Refer to the following page(s). [9 LED Status Indicators on the Outdoor Unit Circuit Board](page 289)		Anytime after power on	C		
SW4 1-10 [0:OFF, 1:ON] (Note 1) SW6-10:ON	No.769	1000000011	Test run mode: ON/OFF	Stops all ICs	Sends a test-run signal to all IC	Anytime after power on	A	
	No.832	0000001011	Cumulative compressor operation time deletion	Retained	Cleared	Any time after being energized (When changed from OFF to ON)	C	
	No.848	0000101011	Continuous heating cycle function	Disabled	Enabled	After being energized and while the compressor is stopped	B	
	No.896	0000000111	Clearance of error history	OC	Retained (IC/OC)	Deleted (IC/OC)	Anytime after power on (OFF→ON)	C
				OS	Retained (OS)	Deleted (OS)		
	No.897	1000000111	High sensible heat operation setting	Depends on the combined setting with No. 900 (Note 4)		After being energized and while the compressor is stopped	A	
	No.900	0010000111	High sensible heat operation setting	Depends on the combined setting with No. 897 (Note 4)		After being energized and while the compressor is stopped	A	
	No.912	0000100111	Pump down function	Normal control	Pump down operation	After being energized and while the compressor is stopped	A	
	No.913	1000100111	Forced defrost (Note 3)	Normal control	Forced defrost starts	10 minutes after the completion of defrost operation (OFF→ON) or 10 minutes after compressor start-up (OFF→ON)	D	
	No.915	1100100111	Defrost start temperature (Note 3)	P200 - P300: -13°C [9°F] P350 - P450: -11°C [12°F]	-8°C [18°F]	Anytime after power on	B	
	No.916	0010100111	Defrost end temperature (Note 3)	P200, P250: 10°C [50°F] P300 - P450: 7°C [45°F]	5°C [41°F]	Anytime after power on	B	
	No.918	0110100111	Changes the defrost timer setting (Note 3)	50 minutes	90 minutes	Anytime after power on (OFF→ON)	B	
	No.921	1001100111	Temperature unit display	°C	°F	Anytime after power on	C	
	No.922	0101100111	Refrigerant amount adjustment	Normal control	Refrigerant amount adjust mode	Anytime after power on (except during initial startup/becomes ineffective 90 minutes after compressor started up.)	A	
	No.932	0010010111	Heating backup	Disabled	Enabled	Anytime after power on	A	
	No.933	1010010111	Snow sensor setting	Effective only when TH7 ≤ 5 is true or the snow sensor contact input is on.	Effective when TH7 ≤ 5 is true	Anytime after power on	C	
	No.934	0110010111	Snow sensor setting	Continuous fan operation (FAN=50%)	Intermittent fan operation (The fan operates in the cycle of being in operation at 100% capacity for 5 minutes and then stops and remains stopped for 30 minutes.)	Anytime after power on	C	
	No.964	0010001111	Target evaporation temperature setting	Depends on the setting combination with No. 982 (Note 5)		Anytime after power on	A	
No.972	0011001111	Automatic cooling/heating mode (IC with the smallest address)	Normal control	Automatic cooling/heating mode	Before power on (After configuring the setting, perform a power reset.)	A		
No.982	0110101111	Target evaporation temperature setting	Depends on the setting combination with No. 964 (Note 5)		Anytime after power on	A		
No.988	0011101111	Refrigerant recovery/Evacuation (two-way valve/LEV1 open)	Disabled	Enabled	After being energized and when units are stopped	C		

**Note**

- 1) To change the settings, set SW6-10 to ON, set SW4, and press and hold SWP01 for 2 seconds or longer (OFF↔ON). LED3 will light up when the switch setting is ON, and lights off when OFF. Use the LED3 display to confirm that the settings are properly made. The settings will need to be set again when the control board is replaced. Write down the settings on the electrical wiring drawing label.
- 2) A: Only the switch on OC needs to be set for the setting to be effective.  
 B: The switches on both the OC and OS need to be set to the same seeing for the setting to be effective.  
 C: The switches on both the OC and OS need to be set.  
 D: The switch on either the OC or OS needs to be set.
- 3) For details, refer to the following page(s).[5-2-7 Defrost Operation Control](page 96)
- 4) The table below shows the combinations of the settings for items No. 897 and No. 900 and the target evaporating temperature setting that corresponds to each combination.

Switch		No.900	
		OFF	ON
No.897	OFF	0°C [32°F]	9°C [48°F]
	ON	4°C [39°F]	14°C [57°F]

- 5) The table below shows the combinations of the settings for items No. 964 and No. 982 and the target evaporating temperature setting that corresponds to each combination.

Switch		No.982	
		OFF	ON
No.964	OFF	0°C [32°F]	-4°C [25°F]
	ON	-2°C [28°F]	-6°C [21°F]

- 6) Unless otherwise specified, leave the switch to OFF where indicated by "-", which may be set to OFF for a reason.
- 7) The settings that are configured with SW4 (SW6-10: ON) will automatically be stored on the indoor units that support the new function\*. The stored settings will automatically be restored when the outdoor unit control board is replaced.

If none of the connected indoor units supports the new function, no configuration information will be saved. If this is the case, manually record the settings configuration on the control box panel.

\*The new function is supported on most units that are manufactured in December of 2012 and later. Depending on the model, this function may be added on later date. Ask your dealer for further details.

**(3) INV board**

Functions are switched with the following connector.

- 1) PUHY-P200, P250, P300, P350, P400YKB-A1

Connector	Function	Function according to connector		Setting timing
		Enabled	Disabled	
CN6 short-circuit connector	Detects or ignores the following errors ACCT sensor failure (5301 Detail No. 115) ACCT sensor circuit failure (5301 Detail No.117) IPM open/ACCT erroneous wiring (5301 Detail No. 119) Detection of ACCT erroneous wiring (5301 Detail No.120)	Error detection enabled	Error detection disable (No load operation is possible.)	Anytime after power on

**Note**

- CN6 short-circuit connector is mated with the mating connector.
- Leave the short-circuit connector on the mating connector during normal operation to enable error detection and protect the equipment from damage.



2) PUHY-P450, P500YKB-A1

Switch	Function	Function according to switch setting		Switch setting timing	
		OFF	ON		
SW001	1	Detects or ignores the following errors ACCT/DCCT sensor fault (5301 Detail No. 115 and 116) ACCT/DCCT sensor circuit fault (5301 Detail No. 117 and 118) Open-circuited IPM/Loose CNCT2 connector (5301 Detail No. 119) Detection of faulty wiring (5301 Detail No. 120)	Error detection enabled	Error detection disable (No load operation is possible.)	Anytime after power on
	2	-	-	-	-

**Note**

- The default settings for all switches are OFF. Unless otherwise specified, leave the switch that are indicated by "-" to OFF, which may be set to OFF for a reason.
- Leave SW001-1 to OFF during normal operation. Setting this switch to ON disables the error detection function and may result in equipment damage.

**(4) Fan board (Control box side, Fan box side)**

Switch	Function	Function according to switch setting		Switch setting timing	
		OFF	ON		
SW1	1	Enabling/Disabling no-load operation No-load operation will continue for approximately 30 seconds, and then the unit will come to an abnormal stop. For details, refer to the following page(s). [8-9-9 Checking the Fan Inverter for Damage at No Load](page 270)	No-load operation disabled	No-load operation enabled	Anytime after power on
	2	-	-	-	-
	3	-	-	-	-
	4	-	-	-	-
	5	Address setting (Control box side)	0	5	Before power on
	6	Address setting (Fan box side)	0	6	Before power on

**Note**

- Only the addresses are preset before shipment (All other switches are set to OFF.) Unless otherwise specified, leave the switch to OFF where indicated by "-", which may be set to OFF for a reason.
- Set SW1-5 on the control-box-side fan board to ON (address = 5). Set SW1-6 on the fan-box-side fan board to ON (address = 6).
- Leave SW1-1 to OFF during normal operation. Setting this switch to ON will disable the error detection function and may result in equipment damage.

## 5-1-2 Indoor Unit Switch Functions and Factory Settings

### (1) Dipswitches

#### 1) SW1,3

Switch	Function	Function according to switch setting		Switch setting timing	Notes
		OFF	ON		
SW1	1	Room temperature detection position	Indoor unit inlet	Built-in sensor on the remote controller	Set to ON (built-in sensor on the remote controller) on All Fresh (PEFY-VMH-F) model units
	2	Clogged filter detection	Not available	Available	
	3	Filter check reminder time setting	100h	2500h	
	4	Outside air intake	Disabled	Enabled	Always set to OFF on PKFY-VBM model units
	5	Remote display option	Fan output	Thermo-ON signal	
	6	Humidifier control	During heating operation	Always on while in the heating mode	
	7	Fan speed setting for Heating Thermo-OFF	Very Low	Low	
		Forced heating operation at OA temp of 5°C or below	Not available	Available	Applicable to All Fresh model units (PEFY-VMH-F) only
	8	Fan speed setting for Heating Thermo-OFF	According to the SW1-7 setting	Preset speed	
		-	-	-	Applicable to All Fresh model units (PEFY-VMH-F) only
9	Self-recovery after power failure	Disabled	Enabled	While the unit is stopped (Remote controller OFF)	
10	Power source start-stop	Disabled	Enabled		
SW3	1	Unit model selection	Heat pump	Cooling only	
	2	Louver	Not available	Available	
	3	Vane	Not available	Available	
	4	Vane swing function	Not available	Available	Always set to OFF on PKFY-VBM model units
	5	-	-	-	
	6	Vane angle limit setting for cooling operation	Downblow B,C	Horizontal	Always set to Downblow B or C on PKFY-VBM model units
		Initial vane position	Enabled	Disabled	PLFY-VLMD model only
	7	Automatic LEV value conversion function	Not available	Available	
	8	Heating 4°C [7.2°F] up	Enabled	Disabled	Set to OFF on floor-standing (PFFY) type units
	9	SHm setting	2°C [3.6°F]	5°C [9°F]	The setting depends on the model and type.
10	SCm setting	10°C [18°F]	15°C [27°F]	The setting depends on the model and type.	

Note 1. Settings in the shaded areas are factory settings.(Refer to the table below for the factory setting of the switches whose factory settings are not indicated by the shaded cells.)

Note 2. If both SW1-7 and SW1-8 are set to ON, the fan remains stopped during heating Thermo-OFF.

To prevent incorrect temperature detection due to a build-up of warm air around the indoor unit, use the built-in temperature sensor on the remote controller (SW1-1) instead of the one on the indoor unit inlet thermistor.

Note 3. By setting SW3-1, SW1-7, and SW1-8 to a certain configuration, the fan can be set to remain stopped during cooling Thermo-OFF. See the table below for details.

Switch setting			Fan speed during Thermo-OFF		Cooling-only/heat pump	
SW3-1	SW1-7	SW1-8	Heating	Cooling		
OFF	OFF	OFF	Very Low	Preset speed	Heat pump	
	ON		Low			
	OFF	ON	Preset speed			
	ON		Stop			
ON	OFF	OFF	-	Preset speed	Cooling-only	
	ON		-			
	OFF	ON	-			Stop
	ON		Stop			Stop

Note 4. Switch settings vary with indoor units models. Refer to the Service Handbook for indoor units for details.

2) SW2

Model	P15	P20	P25	P32	P40	P50	P63
Capacity (model) code	3	4	5	6	8	10	13
SW2 setting							
Model	P71	P80	P100	P125	P140	P200	P250
Capacity (model) code	14	16	20	25	28	40	50
SW2 setting							

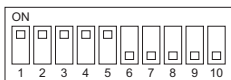

The figure at left shows that the switches 1 through 5 are set to ON and 6 through 10 are set to OFF.

**Note**

The setting timing for SW2 is before power is turned on.

**(2) Address switch**

Actual indoor unit address setting varies in different systems. Refer to the installation manual for the outdoor unit for details on how to make the address setting.

Each address is set with a combination of the settings for the 10's digit and 1's digit.

(Example)

When setting the address to "3", set the 1's digit to 3, and the 10's digit to 0.

When setting the address to "25", set the 1's digit to 5, and the 10's digit to 2.

### 5-1-3 Remote Controller Switch Functions and Factory Settings

#### (1) MA simple remote controller (PAC-YT52CRA)

There are switches on the back of the top case. Remote controller Main/Sub and other function settings are performed using these switches. Ordinarily, only change the Main/Sub setting of SW1. (The factory settings are ON for SW1, 2, and 3 and OFF for SW4.)

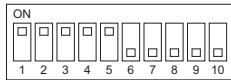
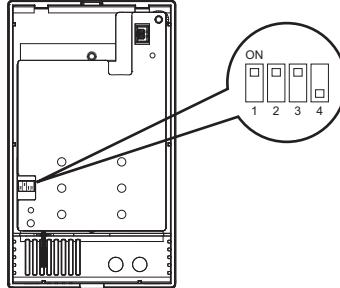

The figure at left shows that the switches 1 through 5 are set to ON and 6 through 10 are set to OFF.

SW No.	SW contents Main	ON	OFF	Comment	Switch setting timing
1	Remote controller Main/Sub setting	Main	Sub	Set one of the two remote controllers at one group to "ON".	Before power on
2	Temperature display units setting	Celsius	Fahrenheit	When the temperature is displayed in [Fahrenheit], set to "OFF".	Before power on
3	Cooling/heating display in AUTO mode	Yes	No	When you do not want to display "Cooling" and "Heating" in the AUTO mode, set to "OFF".	Before power on
4	Indoor temperature display	Yes	No	When you want to display the indoor temperature, set to "ON".	Before power on

**Note**

The MA remote controllers (PAR-31MAA and PAR-21MAA) do not have the switches listed above. Refer to the installation manual for the function setting.

**(2) ME remote controller (PAR-F27MEA)**

Set the address of the remote controller with the rotary switch.

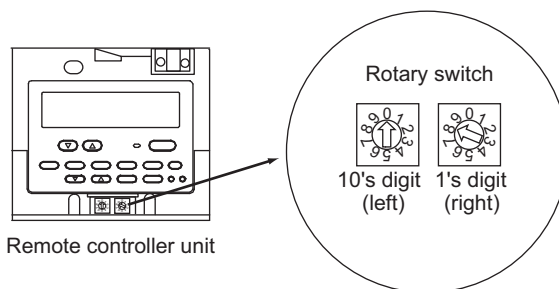

Example: In case of address 108

	Address setting range	Setting method
Main remote controller	101-150	Add 100 to the smallest address of all the indoor units in the same group.
Sub remote controller	151-200	Add 150 to the smallest address of all the indoor units in the same group.
Setting of rotary switch	Address No.	
01-99 <sup>*1</sup>	101-199 with the 100's digit automatically being set to 1 <sup>*2</sup>	
00	200	

\*1. At factory shipment, the rotary switch is set to 01.

\*2. The address range that can be set with the ME remote controller is between 101 and 200. When the dials are set to a number between 01 and 99, the 100's digit is automatically set to [1]. When the dials are set to 00, the 100's digit is automatically set to [2].

**Note**

To set addresses, use a precision slotted screw driver [2.0 mm [0.08 in] (w)], and do not apply than 19.6N. The use of any other tool or applying too much load may damage the switch.

## 5-2 Outdoor Unit Control

### 5-2-1 Overview

- The outdoor units are designated as OC, OS1 and OS2 in the order of capacity from large to small (if two or more units have the same capacity, in the order of address from small to large).
- The setting of outdoor unit can be verified by using the self-diagnosis switch (SW4).

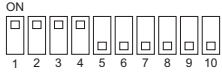
SW4 (SW6-10:OFF)	Display
	<ul style="list-style-type: none"> <li>•The unit is designated as the OC: "oc" appears on the display.</li> <li>•The unit is designated as OS1: "oS-1" appears on the display</li> <li>•The unit is designated as OS2: "oS-2" appears on the display.</li> </ul>

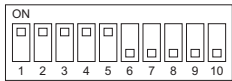

The figure at left shows that the switches 1 through 5 are set to ON and 6 through 10 are set to OFF.

- The OC determines the operation mode and the control mode, and it also communicates with the indoor units.
- The OS exercises autonomous distributed control (over defrost, error detection, and actuator control etc.) according to the operation/control mode signals that are sent from the OC.

### 5-2-2 Rotation Control

- At the initial startup, outdoor units start up in the order of "OC, OS1 and OS2." After two or more hours of operation, the startup sequence changes to "OS1, OS2 and OC" or "OS2, OC and OS1".
- Startup sequence rotation is performed while all the indoor units are stopped. (Even after two hours of operation, startup sequence rotation is not performed while the compressor is in operation.)
- For information about rotation control at initial startup, refer to the following page(s). [5-2-13 Control at Initial Startup](page 99)
- Performing startup sequence rotation does not change the basic operation of OC and OS. Only startup sequence is changed.
- Startup sequence of the outdoor units can be checked with the self-diagnosis switch (SW4) on the OC.

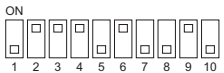
SW4 (SW6-10:OFF)	Display
	<ul style="list-style-type: none"> <li>•OC→OS1→OS2: "OC" and the OC address appear alternately on the display.</li> <li>•OS1→OS2→OC: "OS-1" and the OS1 address appear alternately on the display.</li> <li>•OS2→OC→OS1: "OS-2" and the OS2 address appear alternately on the display.</li> </ul>

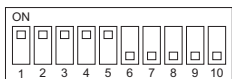

The figure at left shows that the switches 1 through 5 are set to ON and 6 through 10 are set to OFF.

### 5-2-3 Initial Control

- When the power is turned on, the initial processing of the microcomputer is given top priority.
- During the initial processing, control processing of the operation signal is suspended. (The control processing is resumed after the initial processing is completed. Initial processing involves data processing in the microcomputer and initial setting of each of the LEV opening. This process will take up to 5 minutes.)
- During the initial processing, the LED monitor on the outdoor unit's control board displays S/W version → refrigerant type → Model and capacity → and communication address in turn every second.

### 5-2-4 Startup Control

- The upper limit of frequency during the first 3 minutes of the operation is 50 Hz.
- When the power is turned on, normal operation will start after the initial start-up mode (to be described later) has been completed (with a restriction on the frequency).

## 5-2-5 Refrigerant Bypass Control

Bypass solenoid valves (SV1a), which bypass the high- and low- pressure sides, perform the following functions.

### (1) Bypass solenoid valve (SV1a) (ON = Open), (SV9) (ON = Open)

Operation	SV1a	
	ON	OFF
When starting-up the compressor of each outdoor unit	ON for 4 minutes.	
After the restoration of thermo or 3 minutes after restart	ON for 4 minutes.	
During cooling or heating operation with the compressor stopped	Always ON. Exception: OFF when 63HS1-63LS is 0.2 MPa [29 psi] or less	
After the operation has stopped	ON for 3 minutes. Exception: OFF when 63HS1-63LS is 0.2 MPa [29 psi] or less	
During defrost operation	ON	
During compressor operation at Fmin frequency in the cooling mode and when the low pressure (63LS) drops (three or more minutes after compressor startup)	When low pressure (63LS) drops below 0.23 MPa [33 psi].	When low pressure (63LS) exceeds 0.38 MPa [55 psi].
The following conditions are met during the heating mode: Compressor frequency after power on is greater than 0. The low pressure (63LS) drops (One or more minutes after compressor startup if the cumulative compressor operation time is one hour or less; three or more minutes if the cumulative compressor operation time is one hour or more)	When the low pressure (63LS) drops below 0.12 MPa [17 psi]	When the low pressure (63LS) rises above 0.16 MPa [23 psi]
When high pressure (63HS1) rises	When 63HS1 exceeds 3.62 MPa [525 psi]	When 63HS1 is or below 3.43 MPa [497 psi] and 30 seconds have passed

Operation	SV9	
	ON	OFF
When high pressure (63HS1) rises during the heating operation	When 63HS1 exceeds 3.50MPa [507psi]	When 63HS1 is or below 2.70Mpa [391psi]
When returning to normal operation after completion of the defrost cycle	If TH7>-15°C, stays ON for five minutes, then turns off If TH7< = -15°C, stays ON for 25 minutes, or stays ON until 63HS's reading is below 1.96 MPa [284 psi], then turns off	
Others	Always OFF	

Operation	SV10	
	ON	OFF
When Continuous heating mode	P200-P400: Lower part of heat exchanger is being defrosted. P450-P500: Left part of heat exchanger is being defrosted.	Other than on the left

Operation	SV11	
	ON	OFF
When Continuous heating mode	P200-P400: Top part of heat exchanger is being defrosted. P450-P500: Right part of heat exchanger is being defrosted.	Other than on the left

### 5-2-6 Frequency Control

- Depending on the capacity required, the frequency of the compressor is controlled to keep constant evaporation temperature (0°C [32°F] = 0.71 MPa [103 psi]) during cooling operation, and condensing temperature (49°C [120°F] = 2.88 MPa [418 psi]) during heating operation.
- The table below summarizes the operating frequency ranges of the inverter compressor during normal operation.
- The OS in the multiple-outdoor-unit system operates at the actual compressor frequency value that is calculated by the OS based on the preliminary compressor frequency value that the OC determines.

Model	Frequency/cooling (Hz)		Frequency/heating (Hz)	
	Max	Min	Max	Min
200 model	52	10	56	10
250 model	65	10	71	10
300 model	74	16	88	16
350 model	91	16	105	16
400 model	97	16	110	16
450 model	111	16	122	16
500 model	123	16	129	16

**Note**

The maximum frequency during heating operation is affected by the outdoor air temperature to a certain extent.

**(1) Pressure limit**

The upper limit of high pressure (63HS1) is preset, and when it exceeds the upper limit, the frequency is decreased every 15 seconds.

- The actuation pressure is when the high-pressure reading on 63HS1 is 3.58MPa[519psi].

**(2) Discharge temperature limit**

Discharge temperature (TH4) of the compressor in operation is monitored, and when it exceeds the upper limit, the frequency is decreased every minute.

- Operating temperature is 115°C [239°F].

**(3) Periodic frequency control**

Frequency control other than the ones performed at start-up, upon status change, and for protection is called periodic frequency control (convergent control) and is performed in the following manner.

**Periodic control cycle**

Periodic control is performed after the following time has passed

- 30 seconds after either compressor start-up or the completion of defrost operation
- 30 seconds after frequency control based on discharge temperature or pressure limit

**The amount of frequency change**

The amount of frequency change is controlled to approximate the target value based on the evaporation temperature (Te) and condensing temperature (Tc).



## 5-2-7 Defrost Operation Control

### (1) Starting the defrost operation

•The defrost cycle will start when all of the three conditions (outside temperature, cumulative compressor operation time, and pipe temperature) under <Condition 1>, <Condition 2>, or <Condition 3> are met.

	Condition 1	Condition 2	Condition 3
Outside temperature (TH7)	-5°C [23°F] or above	-5°C [23°F] or below	
Cumulative compressor operation time	50 minutes or more 90 minutes or more if the defrost prohibit timer is set to 90.		250 minutes or more
Evaporating temperature (Te)	The evaporating temperature has stayed below the temperature in the table below (Note1) for 3 minutes	( $T_e \leq 1.1 \times TH7 - 7.5$ ) continued for 3 minutes or [ $\{1.5 + 0.02 \times (20 + TH7)\} > 63LS$ ] continued for 3 minutes	The evaporating temperature has stayed below the temperature in the table below (Note1) for 3 minutes

**Note**

1) Evaporating temperature (Te)

	P200 - P400	P450- P500
SW4 (915) OFF	-13 °C	-11 °C
SW4 (915) ON	-8 °C	-8 °C

- The defrost cycle will not start if other outdoor units are in the defrost cycle or until a minimum of 10 minutes have passed since the completion of the last defrost cycle.
- If 10 minutes have passed since compressor startup or since the completion of a defrost cycle, a forced defrost cycle can be started by setting DIP SW4(913) to ON.
- Even if the defrost-prohibit timer is set to 90 minutes, the actual defrost-prohibit time for the next defrost cycle is 50 minutes if the last defrost cycle took 12 minutes.
- All units in the heating mode will simultaneously go into the defrost cycle in a system with multiple units. The units that are not in operation may or may not go into the defrost cycle, depending on the cumulative operation time of their compressors.

### (2) Defrost operation

Compressor frequency	Model	Compressor frequency
	P200 - P250 models	79 Hz
	P300 - P400 models	107Hz
	P450 - P500 models	129Hz
Outdoor unit fan	Stopped	
SV1a	ON	
SV5b	OFF (open)	
21S4a	OFF	
21S4b, 21S4c	OFF	
SV9	OFF	
SV10,SV11	OFF (Closed)	
LEV1	0 pulses <sup>*1</sup>	
LEV2	2000 pulses	

\*1. This value may be greater than 0 pulse depending on the 63LS and TH4 status.

**(3) Stopping the defrost operation**

- The defrost cycle ends when 12 minutes have passed since the beginning of the cycle, or when the pipe temperature (TH3) has been continuously detected for 4 minutes (when SW4 (916) is set to OFF) or 2 minutes (when SW4 (916) is set to ON) that exceeds the values in the table below.
- The defrost cycle will not end for two minutes once started unless one of the following conditions is met : Pipe temperature reaches 25°C [77°F] and SW4 (916) is set to OFF OR  $\alpha^{*1} = 25 + TH7^{\circ}C [77^{\circ}F + TH7]$  and SW4 (916) is set to ON.  
\*1 (5°C [41°F] ≤ α ≤ 25°C [77°F]).
- In the multiple-outdoor-unit system, defrosting is stopped on all units at the same time.

Model	TH3	
	SW4 (916) OFF	SW4 (916) ON
P200 -P250 models	10°C [50°F]	5°C [41°F]
P300 - P500 models	7°C [45°F]	5°C [41°F]

**(4) Problems during defrost operation**

- If a problem is detected during defrost operation, the operation will be stopped, and the defrost prohibition time based on the integrated compressor operation time will be set to 20 minutes.

**(5) Change in the number of operating indoor units during defrost operation**

- Even when there is a change in the number of operating indoor units during defrost operation, the operation will continue, and an adjustment will be made after the completion of the defrost operation.
- Defrost operation will be continued, even if the indoor units stop or under the Thermo-OFF conditions until it has run its course.

**5-2-8 Continuous heating mode control**

**(1) Continuous heating mode start conditions**

- Continuous heating mode will start when all the conditions listed in the table below are met (outside temperature, cumulative compressor operation time, and piping temperature).
- SW4 (848) must be set to ON to perform Continuous heating mode.

Outside temperature (TH7)	2.0 °C [35.6 °F] to 7.0 °C [44.6 °F]
Cumulative compressor operation time	After 10 minutes at 2.0 °C [35.6 °F] to 3.5 °C [38.3 °F] has elapsed After 20 minutes at 3.6 °C [38.5 °F] to 7.0 °C [44.6 °F] has elapsed
Evaporating temperature (Te)	After 3 minutes at 0°C [32°F] to -25 °C [-13°F] has elapsed

**(2) Valve operation during Continuous heating cycle**

	Top (right) HEX in defrost cycle	Bottom (left) HEX in defrost cycle
Outdoor unit fan	In operation	In operation
SV1a	OFF	
SV5b	OFF	
SV9	OFF	
SV10	OFF	ON
SV11	ON	OFF
21S4a,b,c	ON	

## 5-2-9 Refrigerant Recovery Control

Recovery of refrigerant is performed during heating operation to prevent the refrigerant from accumulating inside the unit while it is stopped (unit in fan mode), or inside the indoor unit that is in cooling mode or in heating mode with thermo off. It is also performed during cooling operation to prevent an excessive amount of refrigerant from accumulating in the outdoor heat exchanger.

It is also performed during cooling operation to prevent an excessive amount of refrigerant from accumulating in the outdoor heat exchanger.

### (1) During heating operation

#### Starting refrigerant recovery mode

The refrigerant recovery mode in heating starts when all of the following three conditions are met:

- 15 minutes have passed since the completion of previous refrigerant recovery.
- TH4 > 115°C [239°F]
- Frequencies below 50 Hz

#### Refrigerant recovery

- 1) Refrigerant is recovered with the LEV on the applicable indoor unit (unit under stopping mode, fan mode, cooling, heating with thermo off) being opened for 30 seconds.

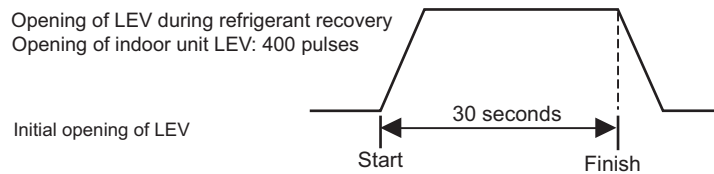

- 2) Periodic capacity control of the outdoor units and periodic LEV control of the indoor units will be suspended during refrigerant recovery operation; they will be performed after the recovery has been completed.

### (2) During cooling operation

#### Starting refrigerant recovery mode

The refrigerant recovery mode starts when all the following conditions are met:

- 30 minutes have passed since the completion of previous refrigerant recovery.
- When the unit keeps running for 3 minutes in a row or more with high discharge temperature
- TH4 > 105°C [221°F] or 63HS1 > 3.43 MPa [497 psi] (35 kg/cm<sup>2</sup>G) and SC0 > 10°C [18°F]

#### Refrigerant recovery

The opening of LEV1 is increased and periodic control begins again.

## 5-2-10 Outdoor Unit Fan Control

### (1) Control method

- Depending on the capacity required, the rotation speed of the outdoor unit fan is controlled by the inverter, targeting a constant evaporation temperature of (0°C [32°F]= 0.71 MPa [103 psi]) during cooling operation and constant condensing temperature of (49°C [120°F]= 2.88 MPa [418 psi]) during heating operation.
- The OS in the multiple-outdoor-unit system operates at the actual outdoor unit fan control value that is calculated by the OS based on the preliminary outdoor unit fan control value that the OC determines.

### (2) Control

- Outdoor unit fan stops while the compressor is stopped (except in the presence of input from snow sensor).
- The fan operates at full speed for 5 seconds after start-up. (Only when TH7<0°C [32°F])
- The outdoor unit fan stops during defrost operation.

## 5-2-11 Subcool Coil Control (Linear Expansion Valve 1)

- The OC, OS1, and OS2 controls the subcool coil individually.
- The LEV is controlled every 30 seconds to maintain constant the subcool at the outdoor unit heat exchanger outlet that is calculated from the values of high pressure (63HS1) and liquid piping temperature (TH3), or the superheat that is calculated from the values of low pressure (63LS) and the bypass outlet temperature (TH2) of the subcool coil.
- LEV opening is controlled based on the values of the inlet (TH6) and the outlet (TH3) temperatures of the subcool coil, high pressure (63HS1), and discharge temperature (TH4). In a single-outdoor-unit system, the LEV is closed (0) in the heating mode, while the compressor is stopped, and during cooling Thermo-OFF. In a multiple-outdoor-unit system, the LEV closes (0) during heating operation, while the compressor is stopped, or during cooling Thermo-OFF. The LEV opens to a specified position when 15 minutes have passed after Thermo-OFF. (65 pulses)
- During the defrost cycle, normally, the valve initially operates at 0 pulses, although it may operate at higher pulses depending on the 63LS and TH4 status.

## 5-2-12 Refrigerant Flow Control (Linear Expansion Valves 2a and 2b)

- Refrigerant flow is controlled by each unit in the combined models during heating. Refrigerant flow control is performed by the OC, OS1, and OS2 individually. The valve opens to a specified angle during cooling (Opening: 2100 pulses)
- Valve opening is controlled based on the values of high pressure (63HS1), discharge temperature (TH4), low pressure (63LS), and piping temperature (TH5).
- The valve moves to the predetermined position while the unit is stopped.
- The valve opening may increase to 3000 pulses during the defrost cycle or when the units are operated in unusual operating conditions.

## 5-2-13 Control at Initial Startup

- When started up for the first time before 12 hours have elapsed after power on, the unit goes into the initial startup mode.
- At the completion of the initial operation mode on the OC, OS1, and OS2, they will go into the normal control mode.

### (1) P200 - P500YKB models

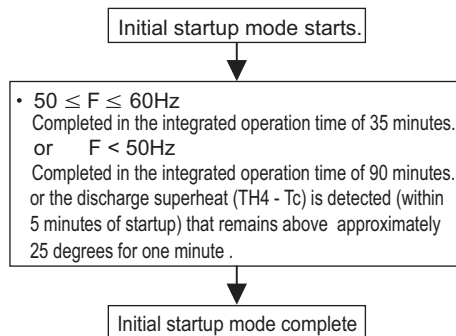

(2) P400 - P900YSKB models

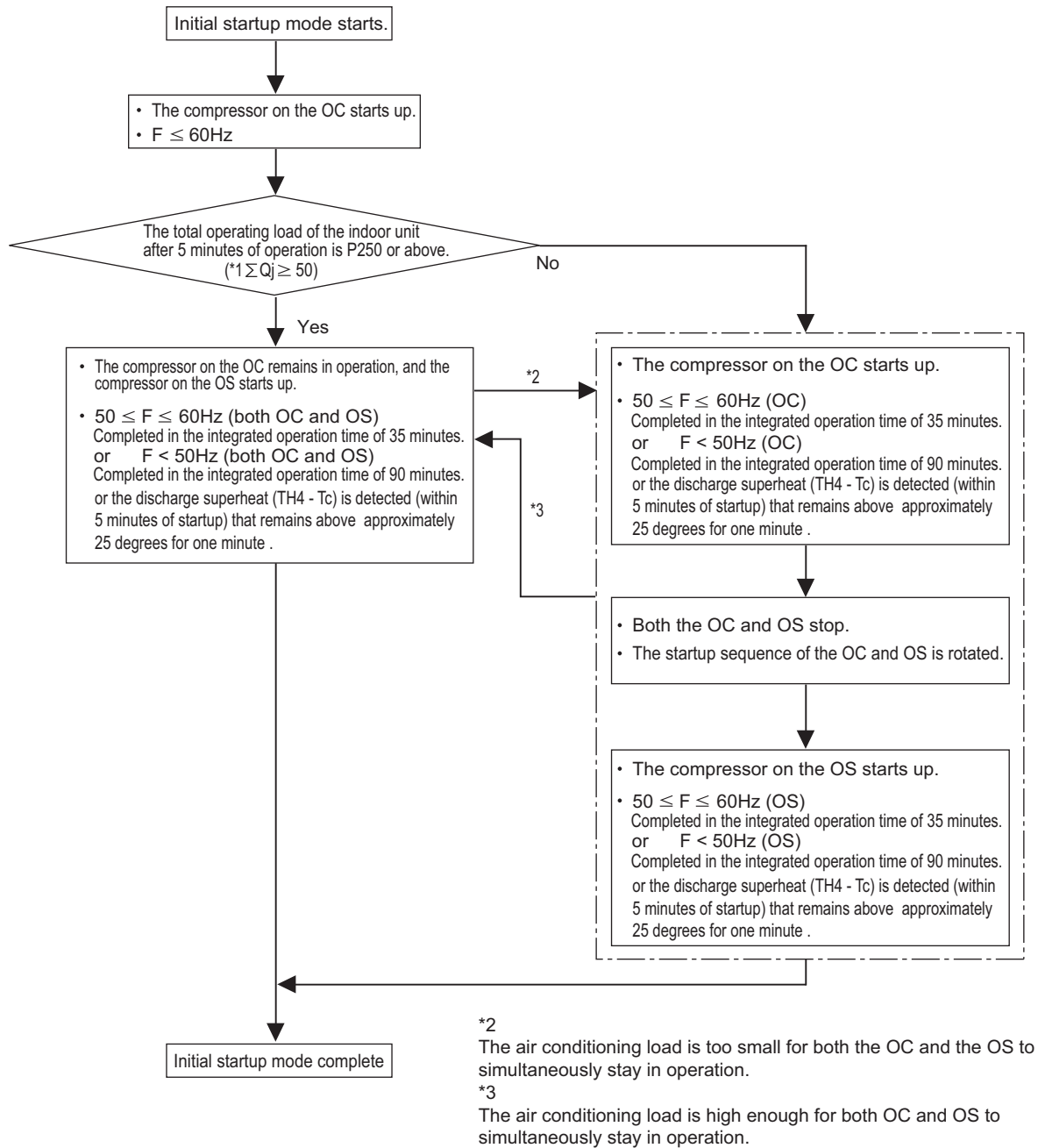

\*1 Σ Qj: Total capacity (models) code

For information about capacity codes, refer to the following page(s). [5-1-2 Indoor Unit Switch Functions and Factory Settings] (page 89)

**(3) P950 - P1350YSKB models**

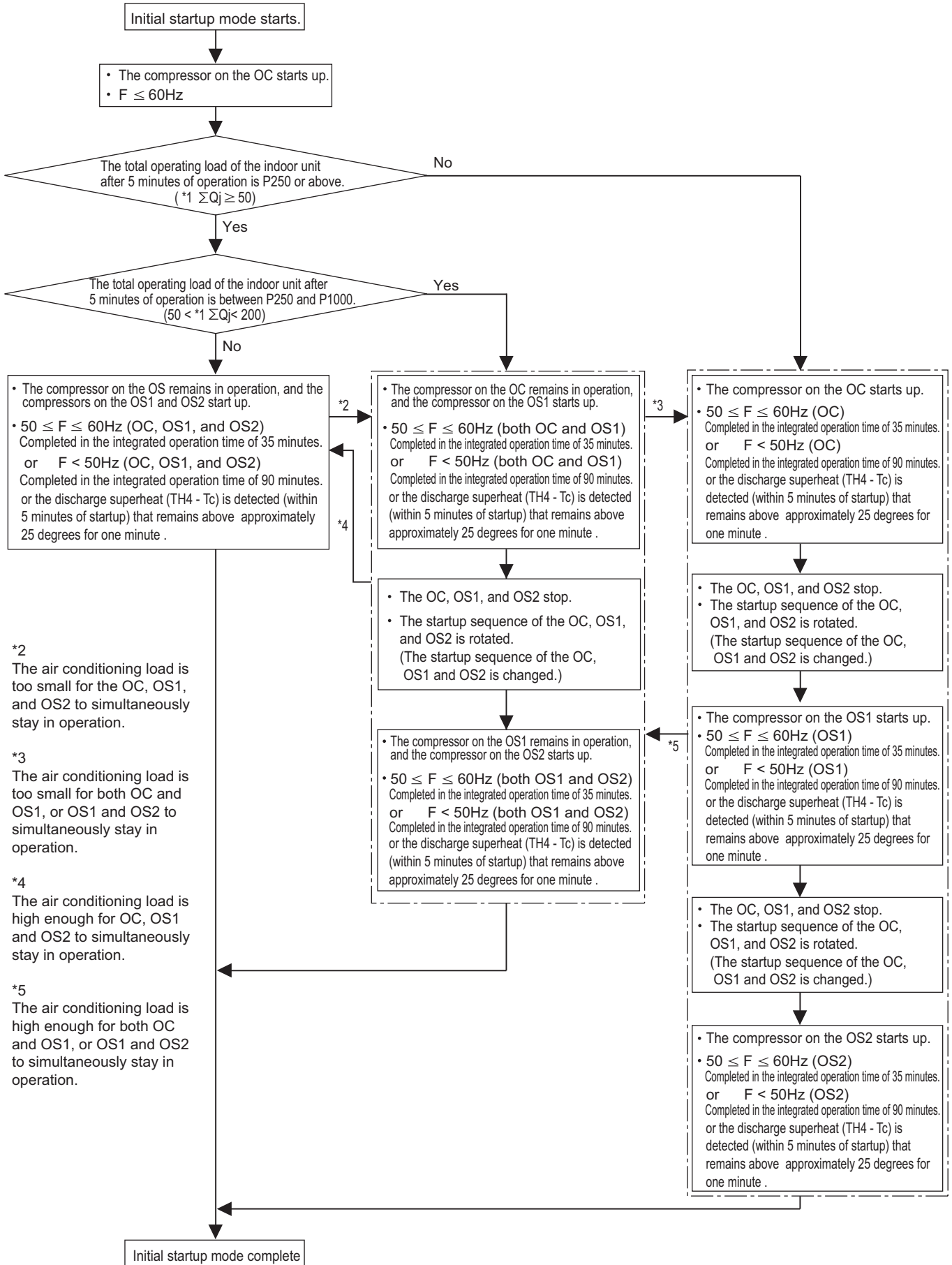

\*2  
The air conditioning load is too small for the OC, OS1, and OS2 to simultaneously stay in operation.

\*3  
The air conditioning load is too small for both OC and OS1, or OS1 and OS2 to simultaneously stay in operation.

\*4  
The air conditioning load is high enough for OC, OS1 and OS2 to simultaneously stay in operation.

\*5  
The air conditioning load is high enough for both OC and OS1, or OS1 and OS2 to simultaneously stay in operation.

\*1 ΣQj: Total capacity (models) code

For information about capacity codes, refer to the following page(s).[5-1-2 Indoor Unit Switch Functions and Factory Settings](page 89)

## 5-2-14 Emergency Operation Mode

### 1. Problems with the outdoor unit

- Emergency operation mode is a mode in which outdoor units that are operating normally take over the operation of the outdoor units that are experiencing problems. (P400-P900YSKB models go into an emergency operation mode when one outdoor unit is in trouble, and P950-P1350YSKB models go into an emergency operation mode when one or two outdoor units are in trouble.)
- This mode can be started by performing an error reset via the remote controller.

#### (1) Starting the emergency operation

- 1) When an error occurs, the error source and the error code will be displayed on the display on the remote controller.
- 2) The error is reset using the remote controller.
- 3) If an error code appears that permits an emergency operation in step 1) above, (See the table below.), the retry operation starts.
- 4) If the same error is detected during the retry operation (step 3 above), an emergency operation can be started by resetting the error via the remote controller.

Error codes that permit an emergency operation (Applicable to both OC and OS)

Trouble source		Error codes that permit an emergency operation	Error code description
Compressor Fan motor Inverter		0403	Serial communication error
		4220,4225,4226	Bus voltage drop
		4230,4235	Heatsink overheat protection
		4240,4245	Overload protection
		4250,4255,4256	Overcurrent relay trip
		5110	Heatsink temperature sensor failure (THHS)
		5120	DCL temperature sensor circuit fault
		5301	Current sensor/circuit failure
		5305,5306	Position error
Thermistor	TH2	5102	Subcool heat exchanger bypass outlet temperature sensor failure
	TH3	5103	Pipe temperature sensor failure
	TH4	5104	Discharge temperature sensor failure
	TH5	5105	Accumulator inlet temperature sensor failure
	TH6	5106	Subcool heat exchanger liquid outlet sensor failure
	TH7	5107	Outside air temperature sensor failure
	TH9	5109	Continuous heating temperature sensor fault
	TH11	5111	Continuous heating temperature sensor fault
Power		4102	Open phase
		4115	Power supply sync signal abnormality

Emergency operation pattern (2 outdoor units)

		OC failure pattern	OS failure pattern
OC		Trouble	Normal
OS		Normal	Trouble
Emergency operation	Cooling	Permitted	Permitted
	Heating	Permitted	Permitted
Maximum total capacity of indoor units (Note 1)		60%	

Emergency operation pattern (3 outdoor units)

		OC failure pattern	OS1 failure pattern	OS2 failure pattern	OC, OS1 failure pattern	OC, OS2 failure pattern	OS1, OS2 failure pattern
OC		Trouble	Normal	Normal	Trouble	Trouble	Normal
OS1		Normal	Trouble	Normal	Trouble	Normal	Trouble
OS2		Normal	Normal	Trouble	Normal	Trouble	Trouble
Emergency operation	Cooling	Permitted	Permitted	Permitted	Permitted	Permitted	Permitted
	Heating	Permitted	Permitted	Permitted	Permitted	Permitted	Permitted
Maximum total capacity of indoor units (Note 1)		60%			40%		

(Note 1) If an attempt is made to put into operation a group of indoor units whose total capacity exceeds the maximum allowable capacity, some of the indoor units will go into the same condition as Thermo-OFF.

**(2) Ending the emergency operation**

1) End conditions

When one of the following conditions is met, emergency operation stops, and the unit makes an error stop.

- When the integrated operation time of compressor in cooling mode has reached four hours.
- When the integrated operation time of compressor in heating mode has reached two hours.
- When an error is detected that does not permit the unit to perform an emergency operation.

2) Control at or after the completion of emergency operation

- At or after the completion of emergency operation, the compressor stops, and the error code reappears on the remote controller.
- If another error reset is performed at the completion of an emergency mode, the unit repeats the procedures in section (1) above.
- To stop the emergency mode and perform a current-carrying operation after correcting the error, perform a power reset.

**2. Communication circuit failure or when some of the outdoor units are turned off**

This is a temporary operation mode in which the outdoor unit that is not in trouble operates when communication circuit failure occurs or when some of the outdoor units are turned off.

**(1) Starting the emergency operation (When the OC is in trouble)**

- 1) When an error occurs, the error source and the error code appear on the display on the remote controller.
- 2) Reset the error via the remote controller to start an emergency operation.

**Precautions before servicing the unit**

- When the OC is in trouble, the OS temporarily takes over the OC's function and performs an emergency operation. When this happens, the indoor unit connection information are changed.
- In a system that has a billing function, a message indicating that the billing system information has an error may appear on the TG-2000A. Even if this message appears, do not change (or set) the refrigerant system information on the TG-2000A. After the completion of an emergency operation, the correct connection information will be restored.



**(2) Starting the emergency operation (When the OS is in trouble)**

1) A communication error occurs. → An emergency operation starts in approximately six minutes.

Error codes that permit an emergency operation (Applicable to both OC and OS)

Trouble source	Error codes that permit an emergency operation	Error code description
Circuit board failure or the power to the outdoor units is off	6607	No acknowledgement error
	6608	No response error

Emergency operation pattern (2 outdoor units)

		OC failure pattern	OS failure pattern
OC		Trouble	Normal
OS		Normal	Trouble
Emergency operation	Cooling	Permitted	Permitted
	Heating	Permitted	Permitted
Maximum total capacity of indoor units (Note 1)		Capacity that matches the total capacity of the operable outdoor units	

Emergency operation pattern (3 outdoor units)

		OC failure pattern	OS1 failure pattern	OS2 failure pattern	OC, OS1 failure pattern	OC, OS2 failure pattern	OS1, OS2 failure pattern
OC		Trouble	Normal	Normal	Trouble	Trouble	Normal
OS1		Normal	Trouble	Normal	Trouble	Normal	Trouble
OS2		Normal	Normal	Trouble	Normal	Trouble	Trouble
Emergency operation	Cooling	Permitted	Permitted	Permitted	Permitted	Permitted	Permitted
	Heating	Permitted	Permitted	Permitted	Permitted	Permitted	Permitted
Maximum total capacity of indoor units (Note 1)		Capacity that matches the total capacity of the operable outdoor units					

(Note 1) If an attempt is made to put into operation a group of indoor units whose total capacity exceeds the maximum allowable capacity, some of the indoor units will go into the same condition as Thermo-OFF.

**(3) Ending the emergency operation**

When communication is restored, the emergency mode is cancelled, and the units go into the normal operation mode.

## 5-2-15 Operation Mode

### (1) Indoor unit operation mode

The operation mode can be selected from the following 5 modes using the remote controller.

1	Cooling mode
2	Heating mode
3	Dry mode
4	Fan mode
5	Stopping mode

### (2) Outdoor unit operation mode

1	Cooling mode	All indoor units in operation are in cooling mode.
2	Heating mode	All indoor units in operation are in heating mode.
3	Stopping mode	All indoor units are in fan mode or stopping mode.

**Note**

When the outdoor unit is performing a cooling operation, the operation mode of the connected indoor units that are not in the cooling mode (Stopped, Fan, Thermo-OFF) cannot be changed to heating from the remote controller. If this attempt is made, "Heating" will flash on the remote controller. The opposite is true when the outdoor unit is performing a heating operation. (The first selection has the priority.)

## 5-2-16 Demand Control

Cooling/heating operation can be prohibited (Thermo-OFF) by an external input to the indoor units.

**Note**

When DIP SW6-8 is set to ON, the 4-step DEMAND control is enabled.  
 Eight-step demand control is possible in the system with two outdoor units.  
 Twelve-step demand control is possible in the system with three outdoor units.

For details, refer to the following page(s). [2-4-7 Various Control Methods Using the Signal Input/Output Connector on Outdoor Unit](page 25)

## 5-2-17 Control of IH energization without the compressor in operation (not applicable to the P450 and P500 models)

IH is used to heat the compressor motor on the stopped outdoor unit to make liquid refrigerant in the compressor evaporate or to keep liquid refrigerant from flooding the compressor.

- Initial power on after power is turned on: Stays on for 12 hours, and then transitions to the operation that is performed while the compressor is stopped
- When the compressor is stopped: Stays off for 30 minutes after the compressor stopped, and then repeats the on-off cycle at 30-minute intervals
- Lit LED1 on the INV board indicates that the INV board is energized by an IH.

## 5-2-18 Compressor heater control (P450 and P500 models)

When the outdoor unit is stopped, the heater wrapped around the compressor heats up the compressor to evaporate the accumulated liquid refrigerant and prevent liquid refrigerant accumulating in the compressor.

- It is always energized when the compressor is stopped.

# 5-3 Operation Flowcharts

## 5-3-1 Operation Sequence Flowchart

### (1) Indoor unit (cooling, heating, dry, fan mode)

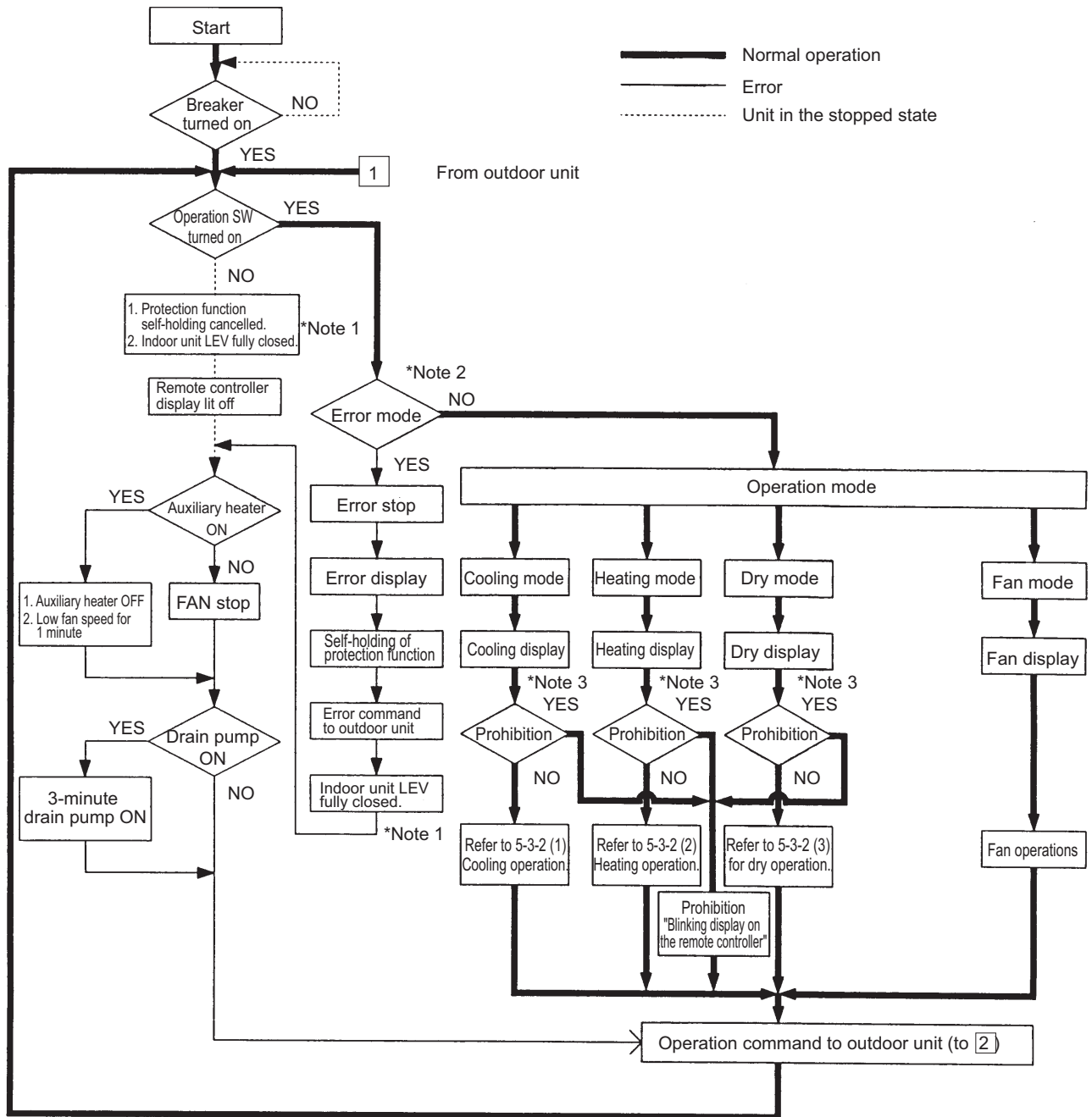

\*Note 1. Indoor unit LEV fully closed : Opening 41.

\*Note 2. The system may go into the error mode on either the indoor unit or the outdoor unit side. If some of the indoor units are experiencing a problem (except water leakage), only those indoor units that are experiencing the problems will stop. If the outdoor unit is experiencing a problem, all connected indoor units will stop.

\*Note 3. The operation will be prohibited when the set cooling/heating mode is different from that of the outdoor unit.

**(2) Outdoor unit (cooling and heating modes)**

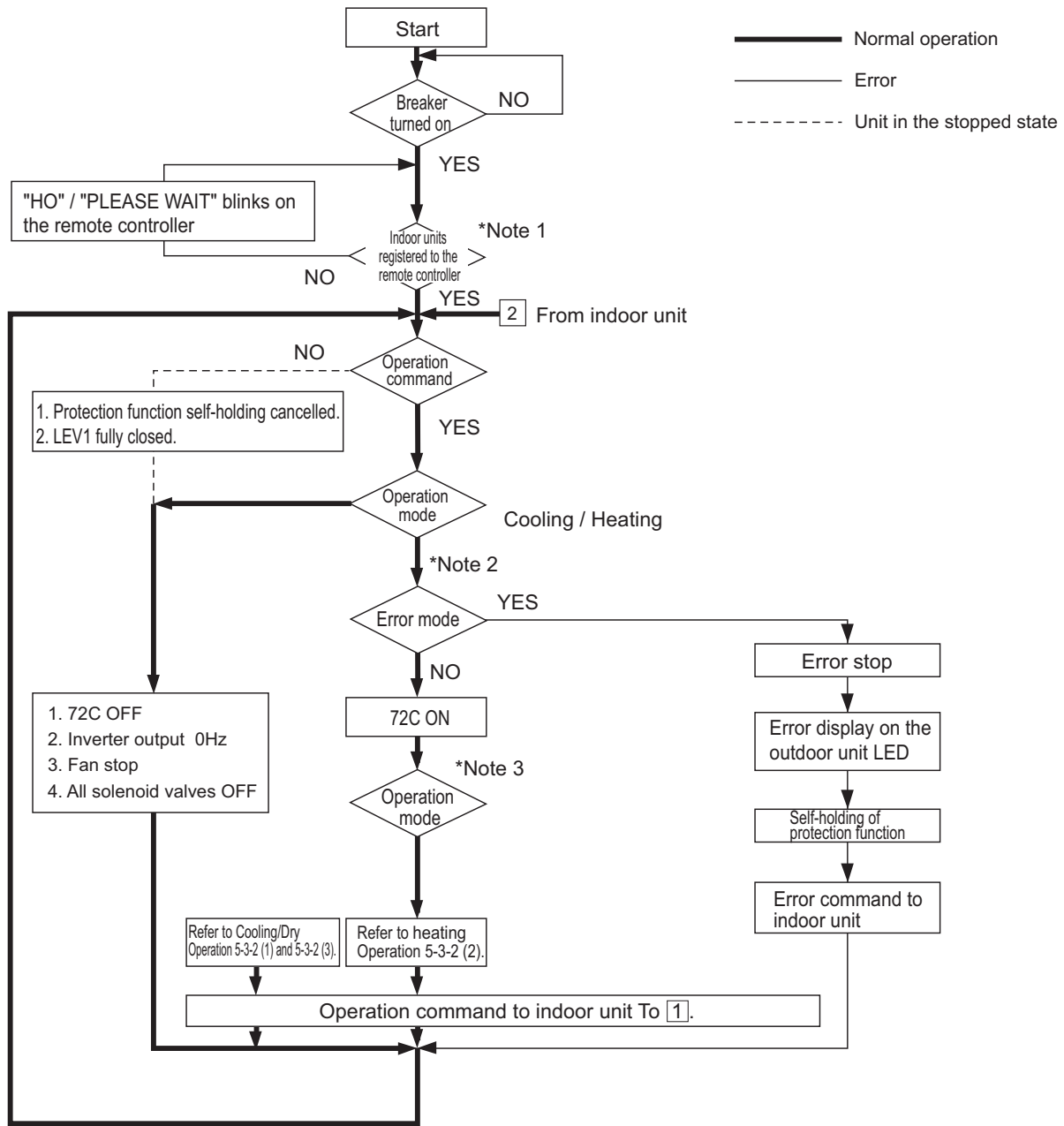

**5 Control**

- \*Note 1. For about 3 minutes after power on, search for the indoor unit address, for the remote controller address, and for the group information will start. During this, "HO" / "PLEASE WAIT" blinks on the display of the remote controller. When the indoor unit to be controlled by the remote controller is missing, "HO" / "PLEASE WAIT" keeps blinking on the display of the remote controller even after 3 or more minutes after power on.
- \*Note 2. The system may go into the error mode on either the indoor unit or the outdoor unit side. The outdoor stops only when all of the connected indoor units are experiencing problems. The operation of even a single indoor unit will keep the outdoor unit running. The error will be indicated on the LED display.
- \*Note 3. The outdoor unit operates according to the operation mode commanded by the indoor unit. However, when the outdoor unit is running a cooling operation, come of the operating indoor units will stop, or the operation of these indoor units will be prohibited even when the indoor unit mode is switched from fan mode to heating mode. This also applies when the outdoor unit is running a heating operation.

## 5-3-2 Actions Performed in Different Modes

### (1) Cooling operation

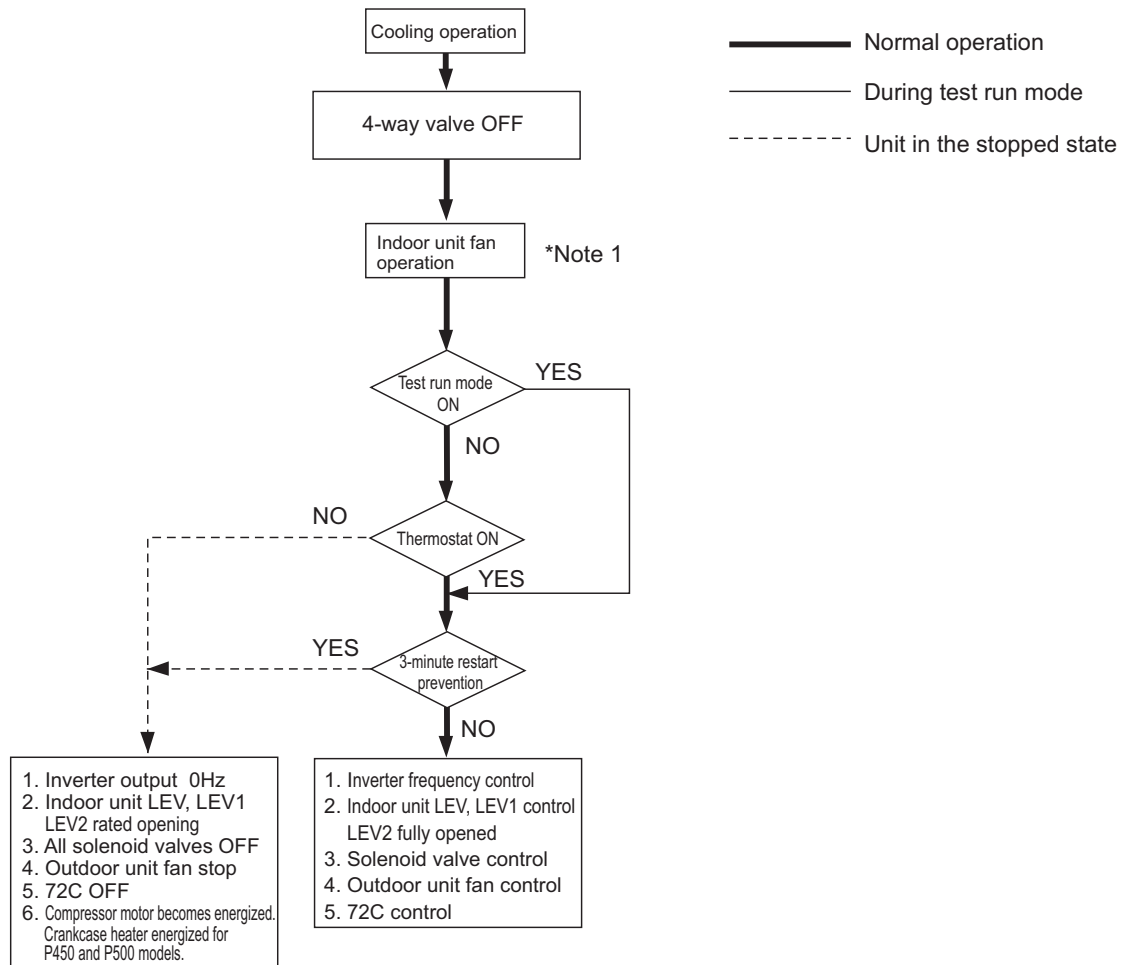

\*Note 1. The indoor fan operates at the set notch under cooling mode regardless of the ON/OFF state of the thermostat.

**(2) Heating operation**

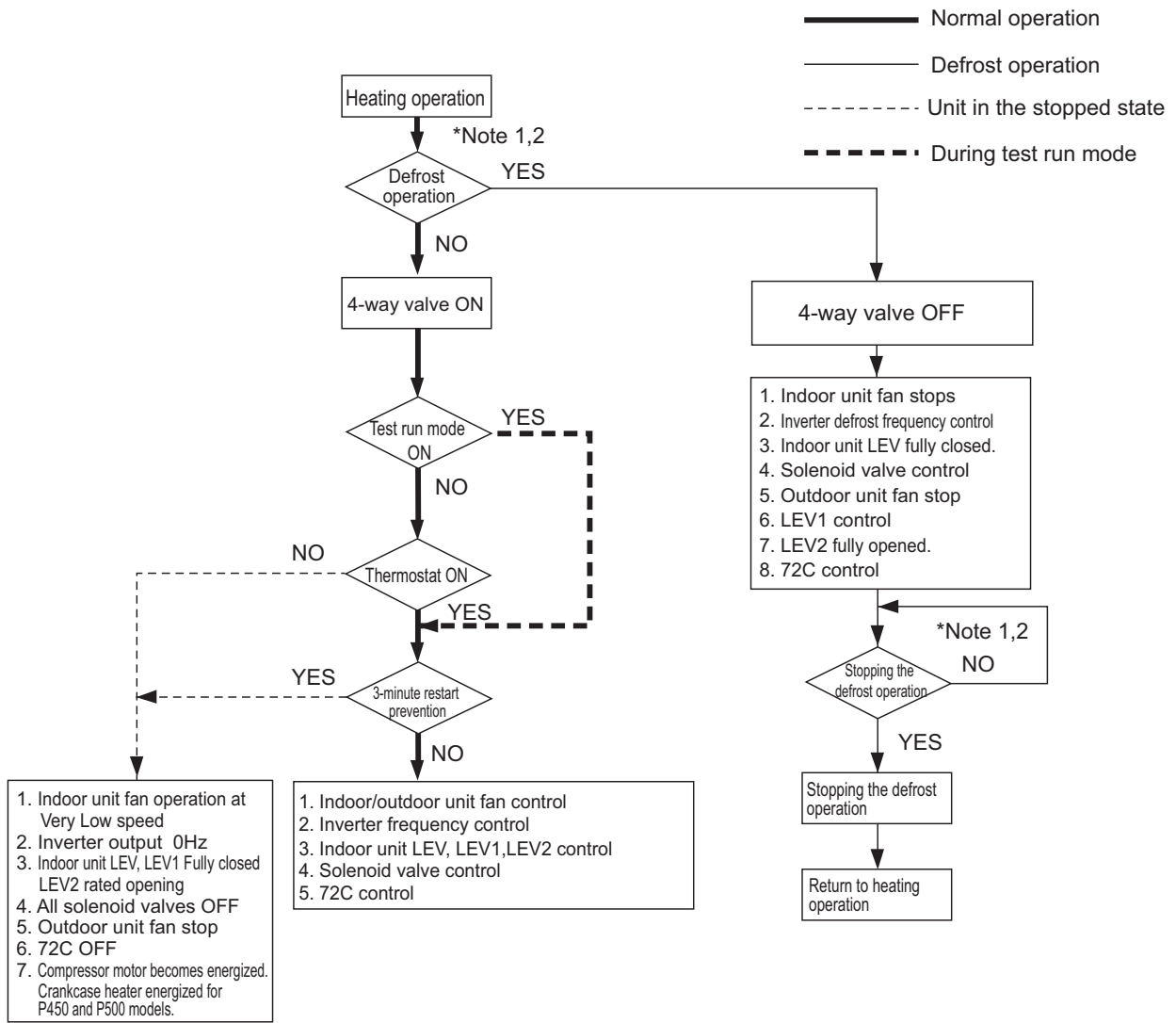

**Note**

- 1) When outdoor unit starts defrosting, it transmits defrost operations command to indoor unit, and the indoor unit start defrosting operations. Similarly when defrosting operation stops, indoor unit returns to heating operation after receiving defrost end command of outdoor unit.
- 2) Defrost end condition: 12 minutes have passed since defrost operation started.  
 Outdoor unit pipe temperature: Refer to the following page(s). [5-2-7 Defrost Operation Control](page 96)

**(3) Dry operation**

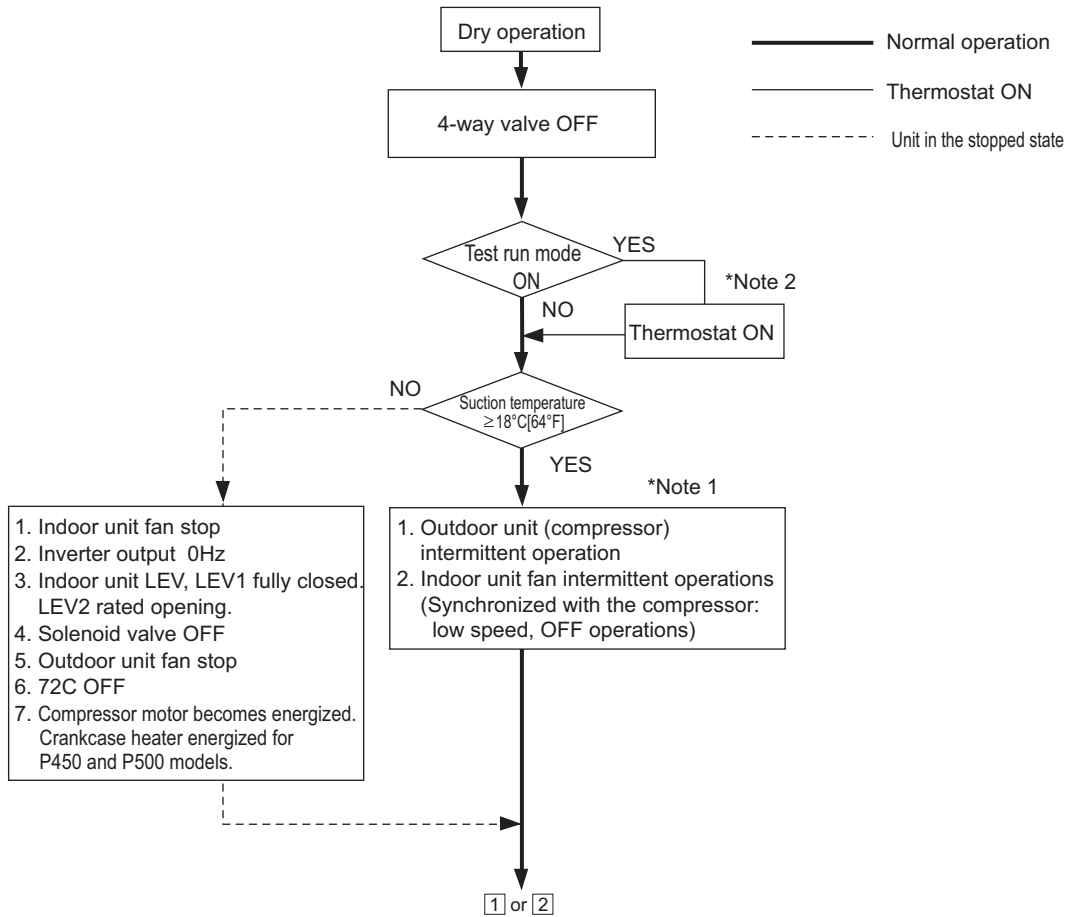

\*Note 1. When the indoor unit inlet temperature exceeds 18°C [64°F], the outdoor unit (compressor) and the indoor unit fan start the intermittent operation simultaneously. When the indoor unit inlet temperature becomes 18°C [64°F], or less, the fan always runs (at low speed). The outdoor unit, the indoor unit, and the solenoid valve operate in the same way as they do in the cooling operation when the compressor is turned on.

\*Note 2. Thermostat is always kept on during test run mode, and indoor and outdoor unit intermittent operation (ON) time is a little longer than that of normal operation.

---

## Chapter 6 Test Run

<b>6-1</b>	<b>Read before Test Run</b> .....	<b>113</b>
<b>6-2</b>	<b>MA and ME Remote Controller Functions and Specifications</b> .....	<b>114</b>
6-2-1	Function/Specification Comparison .....	114
6-2-2	Local Remote Controller Selection Tips.....	114
<b>6-3</b>	<b>Making the Group and Interlock Settings from an ME Remote Controller</b> .....	<b>115</b>
6-3-1	Overview .....	115
6-3-2	Address Registration.....	115
6-3-3	Address Search .....	117
6-3-4	Address Deletion.....	118
6-3-5	Making Group and Interlock Settings from Another Remote Controller .....	118
<b>6-4</b>	<b>Selecting Remote Controller Functions from an ME Remote Controller</b> .....	<b>119</b>
<b>6-5</b>	<b>Making Interlock Settings from an MA Remote Controller</b> .....	<b>121</b>
6-5-1	MA Remote Controller (PAR-31MAA).....	121
6-5-2	MA Remote Controller (PAR-21MAA).....	122
6-5-3	MA Simple Remote Controller .....	124
<b>6-6</b>	<b>Changing the Room Temperature Detection Position</b> .....	<b>127</b>
<b>6-7</b>	<b>Test Run Method</b> .....	<b>128</b>
6-7-1	MA Remote Controller (PAR-31MAA).....	128
6-7-2	MA Remote Controller (PAR-21MAA).....	130
<b>6-8</b>	<b>Operation Characteristics and Refrigerant Charge</b> .....	<b>131</b>
<b>6-9</b>	<b>Evaluating and Adjusting Refrigerant Charge</b> .....	<b>131</b>
6-9-1	Refrigerant Overcharge and undercharge .....	131
6-9-2	Checking the Refrigerant Charge during Operation.....	131
6-9-3	The Amount of Refrigerant to Be Added.....	132
6-9-4	Refrigerant Charge Adjustment Mode .....	135
<b>6-10</b>	<b>The Following Symptoms Are Normal</b> .....	<b>137</b>
<b>6-11</b>	<b>Standard Operation Data (Reference Data)</b> .....	<b>138</b>
6-11-1	Single Unit (Standard).....	138
6-11-2	Dual Unit Combination (Standard).....	142
6-11-3	Triple Unit Combination (Standard) .....	153





## 6-1 Read before Test Run

**(1) Check for refrigerant leak and loose cables and connectors.**

**(2) When opening or closing the front panel of the control box, do not let it come into contact with any of the internal components.**

**Note**

- Before inspecting the inside of the control box, turn off the power, keep the unit turned off for at least 10 minutes, and check that the voltage across FT-P and FT-N terminals and SCP and SC-N terminals have dropped to 20 VDC or below. (It takes approximately 10 minutes to discharge electricity after the power is turned off.)
- Control box houses high temperature parts. Be well careful even after turning off the power source.
- Before starting maintenance work, disconnect the connector (CNINV) on the outdoor unit fan board and CN1 on the inverter board (or CNFAN2 on the capacitor board). Before connecting or disconnecting connectors, make sure that the outdoor unit fans are stopped and that the voltage of the main circuit capacitor is 20 VDC or below. If the outdoor unit fan is turned by strong winds, the main circuit capacitor will be energized and poses an electric shock hazard. Refer to the wiring diagram name plate for details.
- To connect wiring to TB7, check that the voltage is 20 VDC or below.
- After completion of maintenance work, reconnect the connector (CNINV) on the fan board and connector (CN1) on the inverter board (or the connector (CNFAN2) on the capacitor board).

**(3) Measure the insulation resistance between the power supply terminal block and the ground with a 500V megger and make sure it reads at least 1.0Mohm.**

**Note**

- Do not operate the unit if the insulation resistance is below 1.0Mohm.
- Do not apply megger voltage to the terminal block for transmission line. Doing so will damage the controller board.
- The insulation resistance between the power supply terminal block and the ground could go down to close to 1Mohm immediately after installation or when the power is kept off for an extended period of time because of the accumulation of refrigerant in the compressor.
- If insulation resistance reads at least 1 MΩ, by turning on the main power and keeping it on for at least 12 hours, the refrigerant in the compressor will evaporate and the insulation resistance will go up.
- Do not measure the insulation resistance of the terminal block for transmission line for the unit remote controller.

**(4) When the power is turned on, the compressor is energized even while it is not operating. The crankcase heater is energized for the P450 and P500 models.**

**Note**

- Before turning on the power, disconnect all power supply wires from the compressor terminal block, and measure the insulation resistance of the compressor.
- Check the compressor for a ground fault. If the insulation resistance is 1.0 MΩ or below, connect all power supply wires to the compressor and turn on the power to the outdoor unit. (The liquid refrigerant in the compressor will evaporate by energizing the compressor.)

**(5) Check the phase sequence and the voltage of the power supply.**

When the voltage is out of the ±10% range, or when the phase voltage difference is more than 2%, please discuss the countermeasure with the customer.

**(6) [When a transmission booster is connected]**

**Turn on the transmission booster before turning on the outdoor units.**

**Note**

- If the outdoor units are turned on first, the connection information for the refrigerant circuit may not be properly recognized.
- In case the outdoor units are turned on before the transmission booster is turned on, perform a power reset on the outdoor units after turning on the power booster.

**(7) Turn on the main power at least 12 hours before test run.**

**Note**

Insufficient powering time may result in compressor damage.

**(8) When a power supply unit is connected to the transmission line for centralized control(\*), perform a test run with the power supply unit being energized. Leave the power jumper connector on CN41 as it is (factory setting).**

\*Includes the cases where power is supplied to the transmission line from a system controller with a power-supply function

## 6-2 MA and ME Remote Controller Functions and Specifications

There are two types of remote controllers: ME remote controller, which is connected on the indoor-outdoor transmission line, and MA remote controller, which is connected to each indoor unit.

### 6-2-1 Function/Specification Comparison

Functions/specifications	MA remote controller <sup>*1*2</sup>	ME remote controller <sup>*2*3</sup>
Remote controller address settings	Not required	Required
Indoor/outdoor unit address settings	Not required (required only by a system with one outdoor unit) <sup>*4</sup>	Required
Wiring method	Non-polarized 2-core cable *To perform a group operation, daisy-chain the indoor units using non-polarized 2-core cables.	Non-polarized 2-core cable
Remote controller connection	Connectable to any indoor unit in the group	Connectable anywhere on the indoor-outdoor transmission line
Interlock with the ventilation unit	Each indoor unit can individually be interlocked with a ventilation unit. (Set up via remote controller in the group.)	Each indoor unit can individually be interlocked with a ventilation unit. (Set up via remote controller.)
Changes to be made upon grouping change	MA remote controller wiring between indoor units requires rewiring.	Either the indoor unit address and remote controller address must both be changed, or the registration information must be changed via MELANS.

- \*1. MA remote controller refers to MA remote controller (PAR-31MAA, PAR-21MAA), MA simple remote controller, and wireless remote controller.
- \*2. Either the MA remote controller or the ME remote controller can be connected when a group operation of units in a system with multiple outdoor units is conducted or when a system controller is connected.
- \*3. ME remote controller refers to ME remote controller and ME simple remote controller.
- \*4. Depending on the system configuration, some systems with one outdoor unit may require address settings.

### 6-2-2 Local Remote Controller Selection Tips

MA remote controller and ME remote controller have different functions and characteristics. Choose the one that better suits the requirements of a given system. Use the following criteria as a reference.

MA remote controller <sup>*1*2</sup>	ME remote controller <sup>*1*2</sup>
<ul style="list-style-type: none"> <li>•There is little likelihood of system expansion and grouping changes.</li> <li>•Grouping (floor plan) has been set at the time of installation.</li> </ul>	<ul style="list-style-type: none"> <li>•There is a likelihood of centralized installation of remote controllers, system expansion, and grouping changes.</li> <li>•Grouping (floor plan) has not been set at the time of installation.</li> <li>•To connect the remote controller directly to the OA processing unit.</li> </ul>

- \*1. ME remote controller and MA remote controller cannot both be connected to the same group of indoor units.
- \*2. A system controller must be connected to a system to which both MA remote controller and ME remote controller are connected.

<System with MA remote controller>

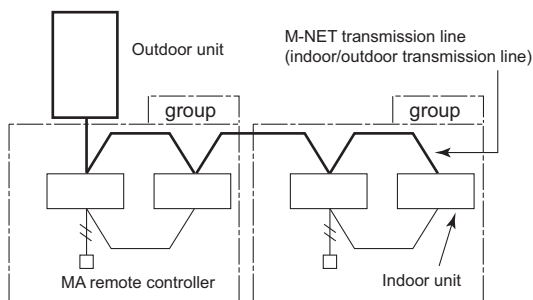

<System with ME remote controllers>

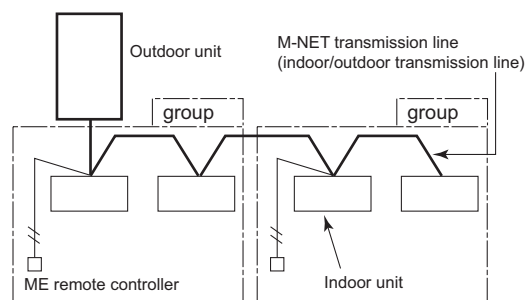

# 6-3 Making the Group and Interlock Settings from an ME Remote Controller

## 6-3-1 Overview

Make the following settings to perform a group operation of units that are connected to different outdoor units or to manually set up the indoor/outdoor unit address.

- (A) Group settings.....Registration of the indoor units to be controlled with the remote controller, and search and deletion of registered information.
- (B) Interlock settings.....Registration of LOSSNAY units to be interlocked with the indoor units, and search and deletion of registered information

## 6-3-2 Address Registration

Register the indoor unit to be controlled with the remote controller.

- ① **Bring up either the blinking display of “HO” by turning on the unit or the normal display by pressing the ON/OFF button.**

The display window must look like one of the two figures below to proceed to the next step.

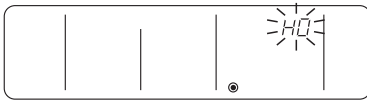

[Blinking display of “HO”]



[Normal display]

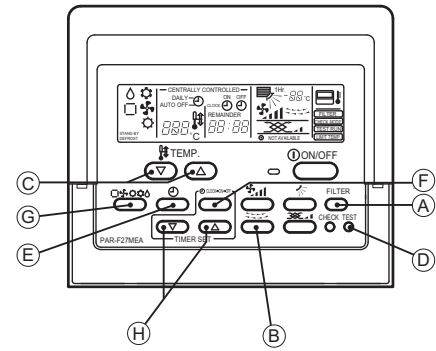

(A) Group Settings

② Bring up the "Group Setting" window.

- Press and hold buttons (A) [FILTER] and (B) [ ] simultaneously for 2 seconds to bring up the display as shown below.

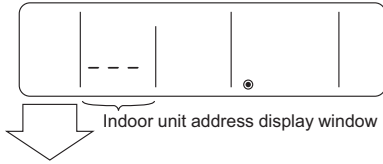

③ Select the unit address.

- Select the address of the indoor unit to be registered by pressing button (C) [TEMP. (▽) or (△)] to advance or go back through the addresses.

④ Register the indoor unit whose address appears on the display.

- Press button (D) [TEST] to register the indoor unit address whose address appears on the display.  
 - If registration is successfully completed, unit type will appear on the display as shown in the figure below.  
 - If the selected address does not have a corresponding indoor unit, an error message will appear on the display. Check the address, and try again.

<Successful completion of registration>

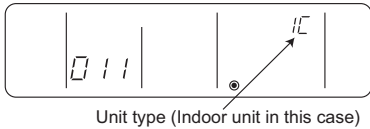

<Deletion error>



"BB" blinks to indicate a registration error. (Indicates that selected address does not have a corresponding unit.)

⑤ To register the addresses for multiple indoor units, repeat steps ③ and ④ above.

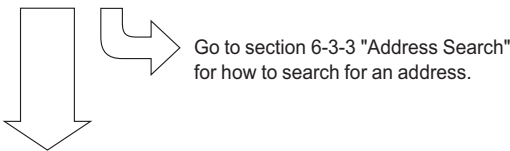

(B) Interlock Settings

⑥ Bring up the "Interlock Setting" window.

- Press button (E) [ ] to bring up the following display. Press again to go back to the "Group Setting" window as shown under step ②.

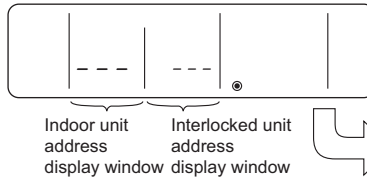

Both the "indoor unit address" and "interlocked unit address" will be displayed together.

Go to section 6-3-3 "Address Search" for how to search for an address.

⑦ Bring up the address of the indoor unit and the address of the LOSSNAY to be interlocked on the display.

- Select the address of the indoor unit to be registered by pressing button (C) [TEMP. (▽) or (△)] to advance or go back through the addresses.  
 - Select the address of the LOSSNAY unit to be interlocked by pressing button (H) [TIMER SET (▽) or (△)] to advance or go back through the "interlocked unit addresses."

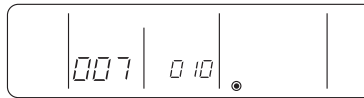

⑧ Make the settings to interlock LOSSNAY units with indoor units.

- Press button (D) [TEST] while both the indoor unit address and the address of the LOSSNAY units to be interlocked are displayed to enter the interlock setting.  
 - Interlock setting can also be made by bringing up the LOSSNAY address in the indoor unit address display window and the indoor unit address in the interlocked unit address display window.

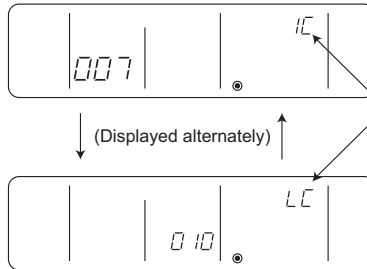

If registration is successfully completed, the two displays as shown on the left will appear alternately.  
 If the registration fails, "BB" will blink on the display. (Indicates that the selected address does not have a corresponding unit.)

NOTE : Interlock all the indoor units in the group with the LOSSNAY units; otherwise, the LOSSNAY units will not operate.

(C) To return to the normal display

When all the group settings and interlock settings are made, take the following step to go back to the normal display.

⑩ Press and hold buttons (A) [FILTER] and (B) [ ] simultaneously for 2 seconds to go back to the window as shown in step ①.

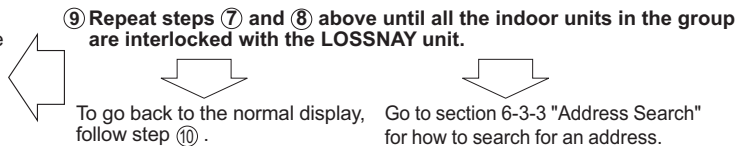

### 6-3-3 Address Search

To search for the address of indoor units that have been entered into the remote controller, follow steps ① and ②.

(A) To search group settings

⑪ Bring up the "Group Setting" window.

- Each pressing of button  $\text{E} [\ominus]$  will bring up the address of a registered indoor unit and its unit type on the display.

<Entry found>



Unit type  
(Indoor unit in this case)

<No entries found>



- When only one unit address is registered, the same address will remain on the display regardless of how many times the button is pressed.
- When the address of multiple units are registered (i.e. "011," "012," "013"), they will be displayed one at a time in an ascending order with each pressing of button  $\text{E} [\ominus]$ .

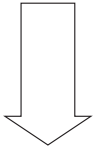

Refer to section 6-3-4 "Address Deletion" for how to delete an address.



To go back to the normal display, follow step ⑩.

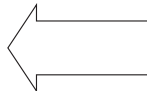

(B) Interlock setting search

After performing step ⑥, proceed as follows:

⑫ Bring up the address of the indoor unit to be searched on the display.

- Select the address of the indoor unit to be searched by pressing button  $\text{E} [\nabla]$  or  $\text{E} [\triangle]$  to advance or go back through the interlocked addresses.



LOSSNAY can be searched in the same manner by bringing up the LOSSNAY address in the Interlocked unit address display window.

⑬ Bring up on the display the address of the LOSSNAY unit that was interlocked with the indoor unit in step ⑫.

- With each pressing of button  $\text{E} [\ominus]$ , the address of the LOSSNAY and indoor unit that is interlocked with it will be displayed alternately.



Address of an interlocked LOSSNAY unit

(Displayed alternately)



⑭ Bring up the address of another registered unit on the display.

- After completing step ⑬, a subsequent pressing of button  $\text{E} [\ominus]$  will bring up the address of another registered unit.

(The display method is the same as the one in step ⑬.)

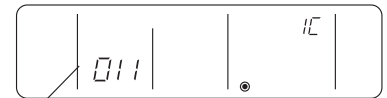

Address of another interlocked unit

(Displayed alternately)

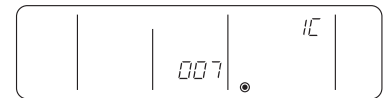

Refer to section 6-3-4 "Address Deletion" for how to delete an address.

### 6-3-4 Address Deletion

The addresses of the indoor units that have been entered into the remote controller can be deleted by deleting the group settings. The interlock settings between units can be deleted by deleting the interlock settings. Follow the steps in section 6-3-3 "Address Search" to find the address to be deleted and perform deletion with the address being displayed in the display window. To delete an address, the address must first be brought up on the display.

**15 Delete the registered indoor unit address or the interlock setting between units.**

- Press button (F) [CLOCK→ON→OFF] twice while either the indoor unit address or the address of the interlocked unit is displayed on the display to delete the interlock setting.

**(A) To delete group settings**

<Successful completion of deletion>



"--" will be displayed in the room temperature display window.

- If a transmission error occurs, the selected setting will not be deleted, and the display will appear as shown below. In this case, repeat the steps above.

<Deletion error>



"BB" will be displayed in the room temperature display window.

To go back to the normal display, follow step 10.

**(B) To delete interlock settings**



(Displayed alternately)

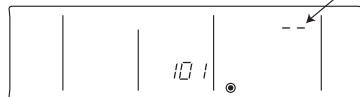

If deletion is successfully completed, "--" will appear in the unit type display window. If the deletion fails, "BB" will appear in the unit type display window. In this case, repeat the steps above.

### 6-3-5 Making Group and Interlock Settings from Another Remote Controller

(A) Group settings and (B) Interlock settings of a group can be made from any arbitrary remote controller. Refer to "(B) Interlock Settings" under section 6-3-1 "Overview" for operation procedures. Set the address as shown below.

**(A) To make group settings**

- Interlocked unit address display window...Remote controller address
- Indoor unit address display window.....The address of the indoor unit to be controlled with the remote controller

**(B) To make interlock settings**

- Interlocked unit address display window...LOSSNAY address
- Indoor unit address display window.....The address of the indoor unit to be interlocked with the LOSSNAY

# 6-4 Selecting Remote Controller Functions from an ME Remote Controller

In the remote controller function selection mode, the settings for four types of functions can be made or changed as necessary.

- 1) Skip-Auto-Mode setting  
The automatic operation mode that is supported by some simultaneous cooling/heating type units can be made unselectable via the ME remote controller.
- 2) Operation mode display selection mode (Display or non-display of COOL/HEAT during automatic operation mode)  
When the automatic operation mode is selected, the indoor unit will automatically perform a cooling or heating operation based on the room temperature. In this case, " " or " " will appear on the remote controller display. This setting can be changed so that only " " will appear on the display.
- 3) Room temperature display selection mode (Display or non-display of room temperature)  
Although the suction temperature is normally displayed on the remote controller, the setting can be changed so that it will not appear on the remote controller.
- 4) Narrowed preset temperature range mode  
The default temperature ranges are 19°C to 30°C in the cooling/dry mode and 17°C to 28°C in the heating mode and 19°C to 28°C in the auto mode. By changing these ranges (raising the lower limit for the cooling/dry mode and lowering the upper limit for the heating mode), energy can be saved.

**NOTE**

When making the temperature range setting on the simultaneous cooling/heating type units that supports the automatic operation mode to save on energy consumption, enable the Skip-Auto-Mode setting to make the automatic operation mode unselectable. If the automatic operation mode is selected, the energy-saving function may not work properly.

When connected to the air conditioning units that do not support the automatic operation mode, the setting for the Skip-Auto-Mode, restricted preset temperature range mode (AUTO), and operation mode display selection mode are invalid. If an attempt is made to change the preset temperature range, "LIMIT TEMP." appears on the display.

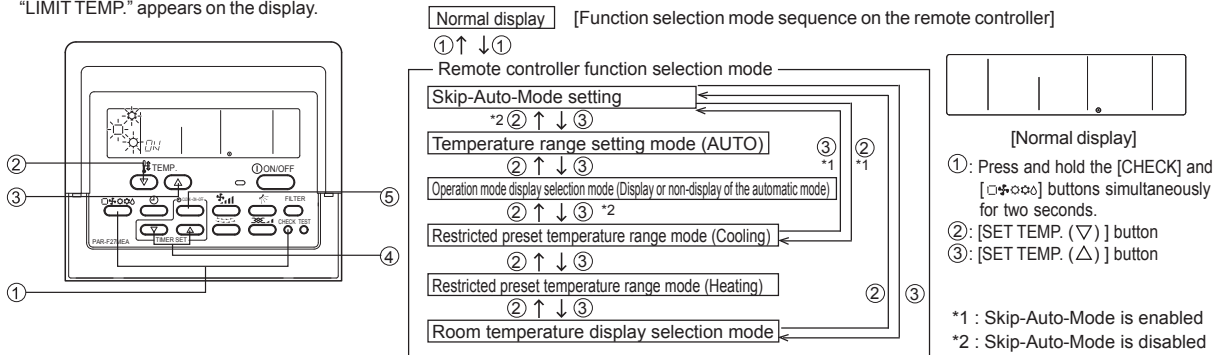



[6-4 Selecting Remote Controller Functions from an ME Remote Controller ]

[Operation Procedures]

1. Press the [ON/OFF] button on the remote controller to bring the unit to a stop. The display will appear as shown in the previous page (Normal display).
2. Press buttons ① [CHECK] and [ ] simultaneously for 2 seconds to go into the "Skip-Auto-Mode setting." under the remote controller function selection mode. Press button ② [SET TEMP. (∇)] or ③ [SET TEMP. (Δ)] to go into the other four modes under the remote controller function selection mode.

**Skip-Auto-Mode setting (Making the automatic operation mode unselectable)**

This setting is valid only when the controller is connected to the simultaneous cooling/heating type air conditioning units that support the automatic operation mode.

- " " blinks and either "ON" or "OFF" lights up on the controller. Pressing the ④ [TIMER SET (Δ) or (∇)] button switches between "ON" and "OFF."

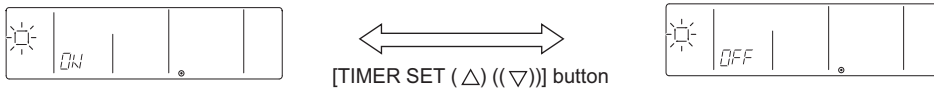

- When set to "ON," the automatic operation mode is available for selection in the function selection mode.
- When set to "OFF," the automatic operation mode is not available for selection in the function selection mode, and an automatic operation cannot be performed. (The automatic operation mode is skipped in the function selection mode sequence.)

**Operation mode display selection mode (Changing the type of display that appears during the automatic mode operation)**

- When connected to the air conditioning units that do not support the automatic operation mode, the setting for this mode is invalid.
- " " " " will blink, and either "ON" or "OFF" will light up. Press button ④ [TIMER SET (Δ) or (∇)] in this state to switch between "ON" and "OFF."

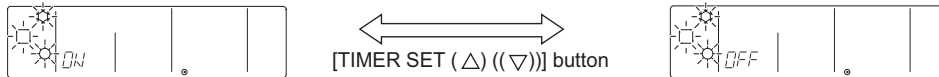

- When it is set to "ON," " " " " will appear on the display during automatic operation mode.
- When it is set to "OFF," only " " will appear on the display during automatic operation mode.

**Restricted preset temperature range mode (The range of preset temperature can be changed.)**

1) Temperature range setting for the cooling/dry mode

" / " will light up in the display window, and the temperature range for the cooling/dry mode will appear on the display.

[Lower limit temperature]: Appears in the preset temperature display window [Upper limit temperature: Appears in the time display window  
Switch between the Lower and Upper limit temperature setting by pressing the ⑤ [CLOCK-ON-OFF] button. The selected temperature setting blinks.

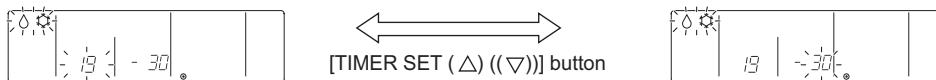

[The left figure shows the display that appears when the current temperature range setting is between 19°C and 30°C in the Cool/Dry mode, and the lower limit temperature is selected to be set.]

Press button ④ [TIMER SET (Δ) or (∇)] to set the lower limit temperature to the desired temperature.

[Settable range for the lower limit temperature] : 19°C ↔ 30°C (Settable up to the upper limit temperature that is shown on the display)  
[Settable range for the upper limit temperature] : 30°C ↔ 19°C (Settable up to the lower limit temperature that is shown on the display)

2) Temperature range setting for heating

" " and the settable temperature range for heating appear on the display.

As with the Cool/Dry mode, use the ⑤ [CLOCK-ON-OFF] button and the ④ [TIMER SET (Δ) or (∇)] to set the temperature range.

[Settable range for the lower limit temperature] : 17°C ↔ 28°C (Settable up to the upper limit temperature that is shown on the display)  
[Settable range for the upper limit temperature] : 28°C ↔ 17°C (Settable up to the lower limit temperature that is shown on the display)

3) Temperature range setting for the automatic mode

When connected to the air conditioning units that do not support the automatic operation mode, the setting for this mode is invalid.

" " and the temperature range for the automatic operation mode appear on the display.

As with the Cool/Dry mode, use the ⑤ [CLOCK-ON-OFF] button and the ④ [TIMER SET (Δ) or (∇)] to set the temperature range.

[Settable range for the lower limit temperature] : 19°C ↔ 28°C (Settable up to the upper limit temperature that is shown on the display)  
[Settable range for the upper limit temperature] : 28°C ↔ 19°C (Settable up to the lower limit temperature that is shown on the display)

**Room temperature display selection mode (Switching between the display or non-display of room temperature on the controller)**

- " 88°C " blinks and either "ON" or "OFF" lights up on the controller. Pressing the ④ [TIMER SET (Δ) or (∇)] button switches between "ON" and "OFF."

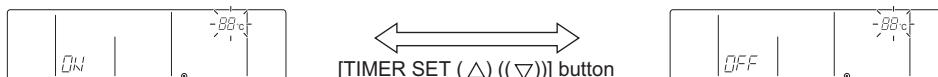

- When set to "ON," room temperature always appears on the display during operation.  
When set to "OFF," room temperature does not appear on the display during operation.

# 6-5 Making Interlock Settings from an MA Remote Controller

## LOSSNAY interlock setting (Make this setting only when necessary.)

### 6-5-1 MA Remote Controller (PAR-31MAA)

This setting is required only when the operation of City Multi units is interlocked with LOSSNAY units. This setting is not available for the Mr. Slim units. Interlock settings can be made for the indoor unit to which the remote controller is connected. (They can also be confirmed or deleted.)

Note:

- Use the centralized controller to make the settings if it is connected.
- To interlock the operation of the indoor units with the LOSSNAY units, be sure to interlock the addresses of ALL indoor units in the group and that of the LOSSNAY unit.

[Button operation]

[1] When "Lossnay" on the Service menu is selected, the remote controller will automatically begin searching for the registered LOSSNAY addresses of the currently connected indoor unit.

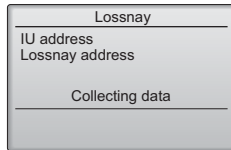

[2] When the search is completed, the smallest address of the indoor units that are connected to the remote controller and the address of the interlocked LOSSNAY unit will appear. "--" will appear if no LOSSNAY unit is interlocked with the indoor units.

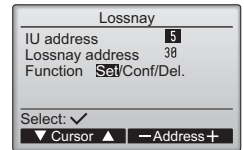

If no settings need to be made, press the RETURN button to go back to the Service menu.

To make LOSSNAY interlock setting

[3] Enter the addresses of the indoor unit and the LOSSNAY unit to be interlocked, with the F1 through F4 buttons, select "Set" in the "Function", and press the SELECT button to save the settings. "Sending data" will appear on the screen. If the setting is successfully completed, "Setting completed" will appear.

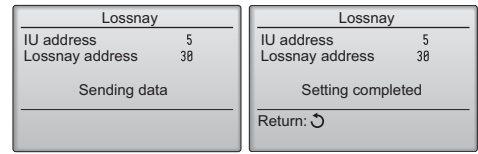

To search for the LOSSNAY address

[4] Enter the address of the indoor unit to which the remote controller is connected, select "Conf" in the "Function", and press the SELECT button. "Collecting data" will appear on the screen. If the signal is received correctly, the indoor unit address and LOSSNAY address will appear. "--" will appear when no LOSSNAY unit is found. "Unit not exist" will appear if no indoor units that correspond to the entered address are found.

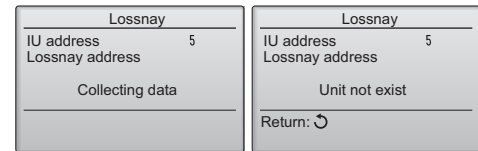

To delete the interlock setting

[5] To delete the interlocked setting between LOSSNAY unit and the indoor units to which the remote controller is connected, enter the indoor unit address and LOSSNAY address with the F1 through F4 buttons, select "Del." in the "Function", and press the SELECT button. "Deleting" will appear. The screen will return to the search result screen if the deletion is successfully completed. "Unit not exist" will appear if no indoor units that correspond to the entered address are found. If deletion fails, "Request rejected" will appear on the screen.

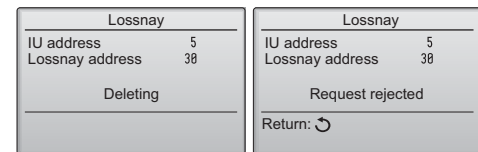

6 Test Run

## 6-5-2 MA Remote Controller (PAR-21MAA)

\* When the upper controller is connected, make the setting using the upper controller.

NOTE: When using LOSSNAY units in conjunction, interlock the addresses of all indoor units within the group and address of LOSSNAY units.

Perform this operation to enter the interlock setting between the LOSSNAY and the indoor units to which the remote controller is connected, or to search and delete registered information.

In the following example, the address of the indoor unit is 05 and the address of the LOSSNAY unit is 30.

### [Operation Procedures]

- Press the [ON/OFF] button on the remote controller to bring the unit to a stop.  
The display window on the remote controller must look like the figure below to proceed to step ②.



- Press and hold the [FILTER] and [ ] buttons simultaneously for two seconds to perform a search for the LOSSNAY that is interlocked with the indoor unit to which the remote controller is connected.



- Search result  
- The indoor unit address and the interlocked LOSSNAY address will appear alternately.

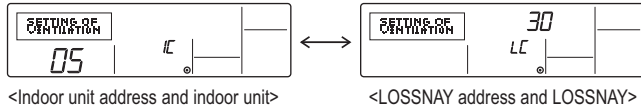

<Indoor unit address and indoor unit>

<LOSSNAY address and LOSSNAY>

- Without interlocked LOSSNAY settings

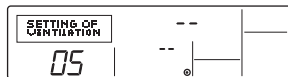

- If no settings are necessary, exit the window by pressing and holding the [FILTER] and [ ] buttons simultaneously for 2 seconds.  
Go to step 1. **Registration Procedures** to make the interlock settings with LOSSNAY units, or go to step 2. **Search Procedures** to search for a particular LOSSNAY unit.  
Go to step 3. **Deletion Procedures** to delete any LOSSNAY settings.

### < 1. Registration Procedures >

- To interlock an indoor unit with a LOSSNAY unit, press the [TEMP. (▽) or (△)] button on the remote controller that is connected to the indoor unit, and select its address (01 to 50).
- Press the [CLOCK (▽) or (△)] button to select the address of the LOSSNAY to be interlocked (01 to 50).

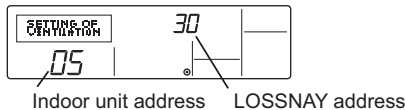

Indoor unit address

LOSSNAY address

- Press the [TEST] button to register the address of the selected indoor unit and the interlocked LOSSNAY unit.  
- Registration completed  
The registered indoor unit address and "IC," and the interlocked LOSSNAY address and "LC" will appear alternately.



- Registration error

If the registration fails, the indoor unit address and the LOSSNAY address will be displayed alternately.



Registration cannot be completed: The selected unit address does not have a corresponding indoor unit or a LOSSNAY unit.  
Registration cannot be completed: Another LOSSNAY has already been interlocked with the selected indoor unit.

< 2. Search Procedures >

⑧ To search for the LOSSNAY unit that is interlocked with a particular indoor unit, enter the address of the indoor unit into the remote controller that is connected to it.



<Indoor unit address>

⑨ Press the [MENU] button to search for the address of the LOSSNAY unit that is interlocked with the selected indoor unit.

- Search completed (With a LOSSNAY connection)

The indoor unit address and "IC," and the interlocked LOSSNAY address and "LC" will appear alternately.

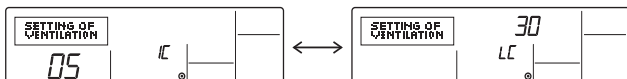

- Search completed (No interlocked settings with a LOSSNAY exist.)



- The selected address does not have a corresponding indoor unit.

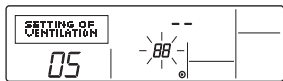

< 3. Deletion Procedures >

Take the following steps to delete the interlock setting between a LOSSNAY unit and the interlocked indoor unit from the remote controller that is connected to the indoor unit.

⑩ Find the address of the LOSSNAY to be deleted (See section 2. Search Procedures. ), and bring up the result of the search for both the indoor unit and LOSSNAY on the display.



⑪ Press the [ON/OFF] button twice to delete the address of the LOSSNAY unit that is interlocked with the selected indoor unit.

- Registration completed

The indoor unit address and "--," and the interlocked LOSSNAY address and "--" will appear alternately.

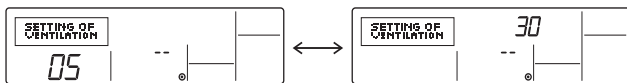

-Deletion error

If the deletion fails

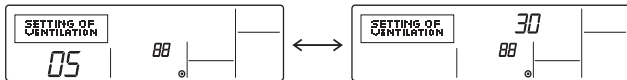



### 6-5-3 MA Simple Remote Controller

Make this setting only when interlocked operation with LOSSNAY is necessary with CITY MULTI models.

Perform this operation when you want to register the LOSSNAY, confirm the registered units, or delete the registered units controlled by the remote controller.  
The following uses indoor unit address 05 and LOSSNAY address 30 as an example to describe the setting procedure.

[Setting Procedure]

- ① Stop the air conditioner using the remote controller  button.
- ② Press and hold down the  and  buttons at the same time for two seconds. The display shown below appears. The remote controller confirms the registered LOSSNAY addresses of the currently connected indoor units.

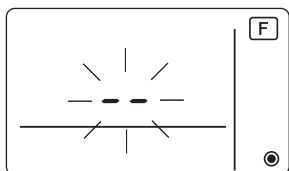

- ③ Registration confirmation result
  - The indoor unit address and registered LOSSNAY address are displayed alternately.



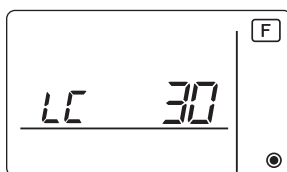

<Indoor unit address and indoor unit display>

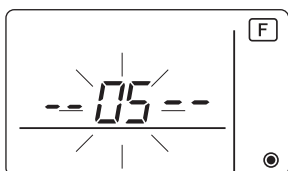

<LOSSNAY address display and LOSSNAY display>

- When LOSSNAY is not registered.



- ④ If registration is unnecessary, end registration by pressing and holding down the  and  buttons at the same time for two seconds.  
If a new LOSSNAY must be registered, go to step 1. **Registration procedure.**  
If you want to confirm another LOSSNAY, go to step 2. **Confirmation procedure.**  
To delete a registered LOSSNAY, go to step 3. **Deletion procedure.**

**<1. Registration procedure>**

- ⑤ Set the address of the indoor unit to be interlocked with the LOSSNAY unit using the **TEMP ▲** and **TEMP ▼** buttons. (01 to 50)
- ⑥ After setting, press the **LOSSNAY** button and set the Lossnay address you want to register by operating the **TEMP ▲** and **TEMP ▼** buttons. (01~50)

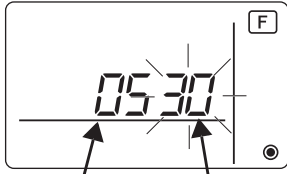

Indoor unit address      LOSSNAY or OA processing unit address

- ⑦ Press the **ON/OFF** button, and register the set indoor unit address and LOSSNAY address.  
 - Registration end display  
 The indoor unit address and “IC” and LOSSNAY address and “LC” are alternately displayed.

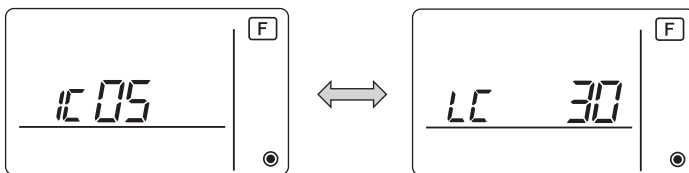

- Registration error display

If the address is not registered correctly, the indoor unit address and [ 88 ], and the registered LOSSNAY and [ 88 ] are alternately displayed.

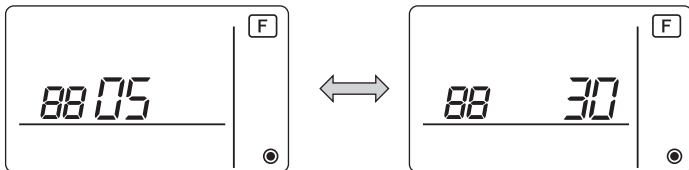

Cannot be registered because the registered indoor unit or LOSSNAY does not exist.

Cannot be registered because another LOSSNAY was registered at the registered indoor unit.

**<2. Confirmation procedure>**

- ⑧ Set the address of the indoor unit connected by the remote controller whose LOSSNAY you want to confirm using the **TEMP. ▲** and **TEMP. ▼** buttons. (01 to 50)
- ⑨ Press the **ON/OFF** button and **ON** button simultaneously for 2 seconds, and check the LOSSNAY address registered at the set indoor unit address.
  - Confirmation end display (When LOSSNAY is connected.)  
The indoor unit address and “IC” and registered LOSSNAY address and “LC” are alternately displayed.

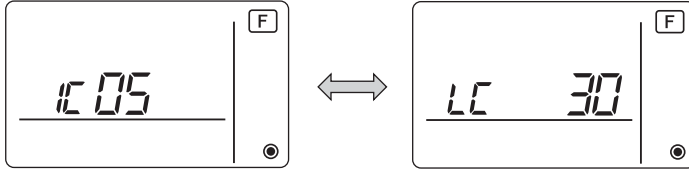

- Confirmation end display (When LOSSNAY is not connected.)

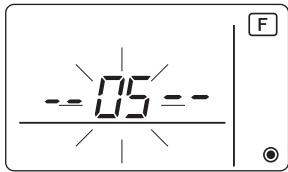

- Registered indoor unit address does not exist.



**<3. Deletion procedure>**

Use this procedure when you want to delete registration of indoor units connected by the remote controller and LOSSNAY.

- ⑩ Confirm (see 2. Confirmation procedure) the LOSSNAY you want to delete and display the indoor units and LOSSNAY confirmation results.
- ⑪ Press the **TEMP. ▲** and **TEMP. ▼** buttons simultaneously for 2 seconds, and delete registration of the LOSSNAY address registered at the set indoor unit.

- Deletion end display

Indoor unit address and “--” and registered LOSSNAY address and “--” are alternately displayed.

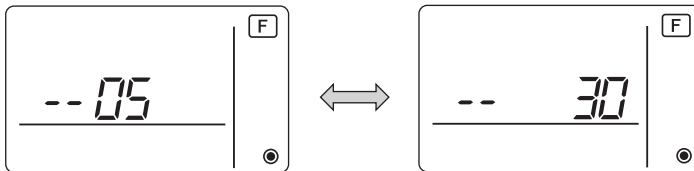

- Deletion error display

When deletion was not performed properly.

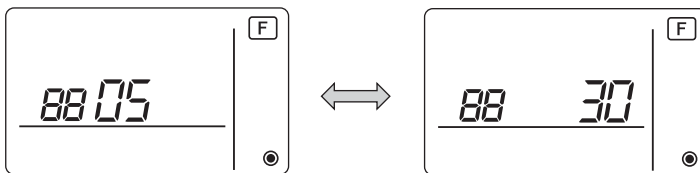

---

## 6-6 Changing the Room Temperature Detection Position

---

**1. Selecting the position of temperature detection (Factory setting: SW1-1 on the controller board on the indoor unit is set to OFF.)**

To use the built-in sensor on the remote controller, set the SW1-1 on the controller board on the indoor unit to ON.

- Some models of remote controllers are not equipped with a built-in temperature sensor. Use the built-in temperature sensor on the indoor unit instead.
- When using the built-in sensor on the remote controller, install the remote controller where room temperature can be detected.



# 6-7 Test Run Method

## 6-7-1 MA Remote Controller (PAR-31MAA)

### (1) Remote controller button functions

**Function button**  
The assignment of the function buttons varies depending on the screen. Follow the guide screen that will appear at the bottom of the screen (from the left, F1, F2, F3, and F4).

**F1 button**  
On the Main screen: Changes the operation mode.  
On the Main Menu screen: Scrolls the cursor down.

**F2 button**  
On the Main screen: Decreases the set temperature.  
On the Main Menu screen: Scrolls the cursor up.

**F3 button**  
On the Main screen: Increases the set temperature.  
On the Main Menu screen: Returns to the previous page.

**F4 button**  
On the Main menu screen: Changes the fan speed.  
On the Main Menu screen: Jumps to the next page.

**"Menu" button**  
Displays the Main Menu.

**"Return" button**  
Returns to the previous page.

**"Select" button**  
Confirms the selection.

**"On/Off" button**  
Turns on and off the controller.

### (2) Operation procedures

#### Step 1: Turn on the main power at least 12 hours before starting operation.

The green power indicator and "Please Wait" will blink on the remote controller for up to five minutes. While they are blinking, remote controller will not respond to button pressing. Wait until "Please Wait" goes off the screen.

#### Step 2: Set the remote controller to the "Test run" mode.

- On the Service Menu screen, select "Test run" and press the button.
- The test run menu will appear. Select "Test run" and press the button. Test run will begin, and the test run screen will appear.
- It may take up to 15 minutes to detect a system error. (\*Keep all the systems simultaneously operating for a minimum of 15 minutes.)

#### Step 3: Check the supply air temperatures and the auto vane functions.

- Press the F1 button to change the operation mode.  
Cooling: Check that the supply air is cold.  
Heating: Check that the supply air is warm.
- Press the button to bring up the screen to change the airflow direction, and check the auto vane with the F1 and F2 buttons. Press the button to return to the "Test run" screen.

#### Step 4: Check the outdoor unit fan for proper operation.

Outdoor units control the fan rotation to adjust the operation performance. Depending on the outside air conditions, the fan will rotate at low speed and maintains its rotation speed unless capacity shortage occurs. The fan may stop or rotate in the reverse direction, depending on the outside airflow; this is normal.

#### Step 5: Ending the test run

- Press the button to end the test run. (The screen will return to the Test run menu.)

### (3) Entering the maintenance information

Model name, serial number, and dealer's phone number can be registered to the remote controller to be displayed on the screen when an error occurs.

#### Step 1: Switching the remote controller screen to "Maintenance information" (Requires the maintenance password. This screen is not accessible while the controller is under centralized control.)

- 1 On the Service Menu screen, select "Input maintenance info." and press the button.
- 2 Select "Model name input" and press the button.

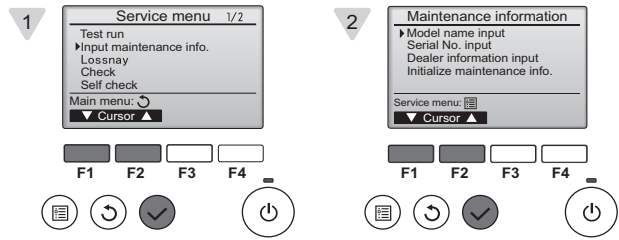

#### Step 2: Selecting the outdoor unit address and indoor unit address information to be registered

- 1 Select the address to be registered, using the F1 and F2 buttons, and then press the button.
  - Address: 0-255

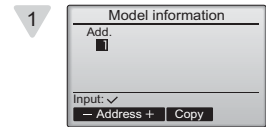

#### Step 3: Registering the model name

- 1 Enter the model name. The character string can be up to 18 characters in length.
  - Move the cursor left with the F1 button, and right with the F2 button.
  - Select a character with the F3 and F4 buttons.
  - Press the button when done entering characters. The screen will return to the one shown in Step 2.

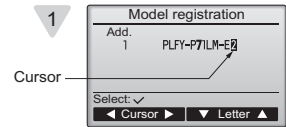

Repeat Steps 2 and 3 until all the model names of the units at the selected addresses have been entered. To change the address, press the button on the screen shown in Step 3 to return to the screen shown in Step 2, and then change the address. After changing the address, enter the model name.

Tips: the model name information of the unit at a given address can be copied and pasted to another unit at a different address.

- Press the F3 button in Step 2 to copy the model name information of the unit at the selected address.
- Press the F4 button in Step 2 to overwrite the model name information of the unit at the selected address.

#### Step 4: Registering the serial number

- 1 Select "Serial No. input" in Step 1-2 above, and then press the button.
- 2 Register the serial number by following steps 2 and 3 above. The serial number can be up to 8 characters in length.

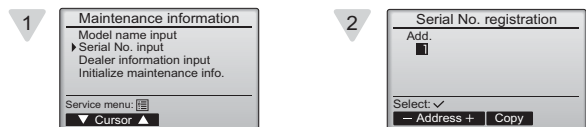

#### Step 5: Entering your dealer's phone number

- 1 Select "Dealer information input" on the Maintenance information screen, and press the button.
- 2 Press the button when "Dealer information" appears.

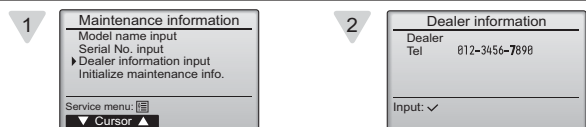

- 3 Enter your dealer's telephone number. Telephone number can be up to 13 characters.
  - Move the cursor left with the F1 button, and right with the F2 button.
  - Select a character with the F3 and F4 buttons.
  - Press the button when done entering characters.

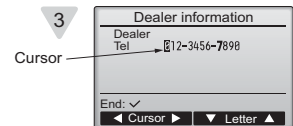

## 6-7-2 MA Remote Controller (PAR-21MAA)

The figure shows an MA remote controller (PAR-21MAA).

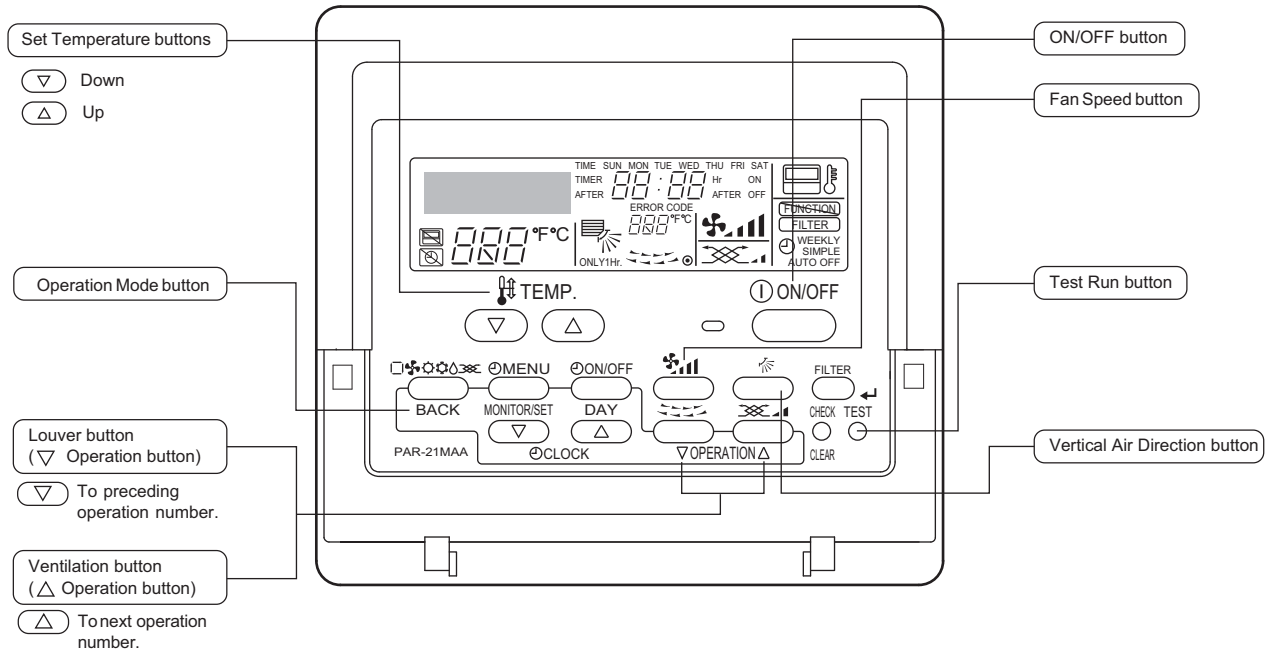

Operation procedures	
Turn on the main power.	→ "PLEASE WAIT" appears on the LCD for up to five minutes. Leave the power on for 12 hours. (Energize the belt heater.)
Press the <b>Test</b> button twice.	→ Operation mode display "TEST RUN" and OPERATION MODE are displayed alternately.
Press the Operation Mode button. □ ■ ● ○ ⊗ ⊕ ⊖ ⊗	→ Make sure that the air is blowing out.
Switch to cooling (or heating) operation by pressing the Operation Mode button. □ ■ ● ○ ⊗ ⊕ ⊖ ⊗	→ Make sure that cold (or warm) air blows out. On the same refrigerant system, make the operation mode the same.
Press the Fan Speed button. 🌀	→ Make sure that the fan speed changes with each pressing of the button.
Change the air flow direction by pressing the Vertical Air Direction button 🌀 or the Louver button. ▽	→ Make sure that the air flow direction changes with each pressing of the button.
	→ Confirm the operation of outdoor unit fan.
	Confirm the operation of all interlocked equipment, such as ventilation equipment.
Cancel the test run by pressing the <b>ON/OFF</b> button.	→ Stop
<p>Note 1: Refer to the following pages if an error code appears on the remote controller or when the unit malfunctions.</p> <p>2: The OFF timer will automatically stop the test run after 2 hours.</p> <p>3: The remaining time for the test run will be displayed in the time display during test run.</p> <p>4: The temperature of the liquid pipe on the indoor unit will be displayed in the room temperature display window on the remote controller during test run.</p> <p>5: On some models, "NOT AVAILABLE" may appear on the display when the Vane Control button is pressed. This is normal.</p> <p>6: If an external input is connected, perform a test run using the external input signal.</p> <p>7: Test run all systems for at least 15 minutes to detect possible system errors.</p>	

## 6-8 Operation Characteristics and Refrigerant Charge

It is important to have a clear understanding of the characteristics of refrigerant and the operating characteristics of air conditioners before attempting to adjust the refrigerant amount in a given system.

The following table shows items of particular importance.

- 1) During cooling operation, the amount of refrigerant in the accumulator is the smallest when all indoor units are in operation.
- 2) During heating operation, the amount of refrigerant in the accumulator is the largest when all indoor units are in operation.
- 3) General tendency of discharge temperature
  - Discharge temperature tends to rise when the system is short on refrigerant.
  - Changing the amount of refrigerant in the system while there is refrigerant in the accumulator has little effect on the discharge temperature.
  - The higher the pressure, the more likely it is for the discharge temperature to rise.
  - The lower the pressure, the more likely it is for the discharge temperature to rise.
- 4) When the amount of refrigerant in the system is adequate, the compressor shell temperature is 10 to 60°C [18 to 108°F] higher than the low pressure saturation temperature (Te).
  - If the temperature difference between the compressor shell temperature and low pressure saturation temperature (Te) is smaller than 5°C [9°F], an overcharging of refrigerant is suspected.

## 6-9 Evaluating and Adjusting Refrigerant Charge

### 6-9-1 Refrigerant Overcharge and undercharge

Overcharging or undercharging of refrigerant can cause the following symptoms:

Before attempting to adjust the amount of refrigerant in the system, thoroughly check the operating conditions of the system. Then, adjust the refrigerant amount by running the unit in the refrigerant amount adjust mode.

The system comes to an abnormal stop, displaying 1500 (overcharged refrigerant) on the controller.	Overcharged refrigerant
The operating frequency does not reach the set frequency, and there is a problem with performance.	Insufficient refrigerant amount
The system comes to an abnormal stop, displaying 1102 (abnormal discharge temperature) on the controller.	

### 6-9-2 Checking the Refrigerant Charge during Operation

Operate all indoor units in either cooling-only or heating-only mode, and check such items as discharge temperature, subcooling, low pressure, suction temperature, and shell bottom temperature to estimate the amount of refrigerant in the system.

Symptoms	Conclusion
Discharge temperature is high. (Normal discharge temperature is below 95°C [203°F].)	Slightly undercharged refrigerant
Low pressure is unusually low.	
Suction superheat is large. (Normal suction superheat is less than 20°C [36°F].)	
Compressor shell bottom temperature is high. (The difference between the compressor shell bottom temperature and low pressure saturation temperature (Te) is greater than 60°C [108°F].)	Slightly overcharged refrigerant
Discharge superheat is small. (Normal discharge superheat is greater than 10°C [18°F].)	
Compressor shell bottom temperature is low. (The difference between the compressor shell bottom temperature and low pressure saturation temperature (Te) is less than 5°C [9°F].)	

### 6-9-3 The Amount of Refrigerant to Be Added

The amount of refrigerant that is shown in the table below is factory-charged to the outdoor units. The amount necessary for extended pipe (field piping) is not included and must be added on site.

Outdoor unit model	P200	P250	P300	P350	P400	P450	P500
Amount of pre-charged refrigerant in the outdoor unit (kg)	6.5	8.0	11.5	11.5	11.5	11.8	11.8
Amount of pre-charged refrigerant in the outdoor unit [lbs-oz]	14-6	17-11	25-6	25-6	25-6	26-1	26-1

**(1) Calculation formula**

The amount of refrigerant to be added depends on the size and the length of field piping. (unit in m[ft])

•When the piping length to the farthest indoor unit is shorter than 30.5 meters (100 feet)

$\begin{aligned} \text{Amount of added refrigerant (kg)} &= (0.29 \times L_1) + (0.2 \times L_2) + (0.12 \times L_3) + (0.06 \times L_4) + (0.024 \times L_5) + \alpha \\ \text{Amount of added refrigerant (oz)} &= (3.1 \times L_1') + (2.15 \times L_2') + (1.29 \times L_3') + (0.65 \times L_4') + (0.26 \times L_5') + \alpha' \end{aligned}$
---

•When the piping length to the farthest indoor unit is 30.5 meters (100 feet) or longer

$\begin{aligned} \text{Amount of added refrigerant (kg)} &= (0.26 \times L_1) + (0.18 \times L_2) + (0.11 \times L_3) + (0.054 \times L_4) + (0.021 \times L_5) + \alpha \\ \text{Amount of added refrigerant (oz)} &= (2.80 \times L_1') + (1.94 \times L_2') + (1.19 \times L_3') + (0.58 \times L_4') + (0.23 \times L_5') + \alpha' \end{aligned}$
--

- L<sub>1</sub>: Length of ø19.05 [3/4"] liquid pipe (m)
- L<sub>2</sub>: Length of ø15.88 [5/8"] liquid pipe (m)
- L<sub>3</sub>: Length of ø12.7 [1/2"] liquid pipe (m)
- L<sub>4</sub>: Length of ø9.52 [3/8"] liquid pipe (m)
- L<sub>5</sub>: Length of ø6.35 [1/4"] liquid pipe (m)
- α, α': Refer to the table below.

- L<sub>1</sub>': Length of ø19.05 [3/4"] liquid pipe [ft]
- L<sub>2</sub>': Length of ø15.88 [5/8"] liquid pipe [ft]
- L<sub>3</sub>': Length of ø12.7 [1/2"] liquid pipe [ft]
- L<sub>4</sub>': Length of ø9.52 [3/8"] liquid pipe [ft]
- L<sub>5</sub>': Length of ø6.35 [1/4"] liquid pipe [ft]

Total capacity of connected indoor units	α (kg)	α' (oz)
- 80	2.0	71
81 - 160	2.5	89
161 - 330	3.0	106
331 - 390	3.5	124
391 - 480	4.5	159
481 - 630	5.0	177
631 - 710	6.0	212
711 - 800	8.0	283
801 - 890	9.0	318
891 - 1070	10.0	353
1071 - 1250	12.0	424
1251 -	14.0	494

Round up the calculation result to the nearest 0.1kg. (Example: 18.04kg to 18.1kg)

Round up the calculation result in increments of 4oz (0.1kg) or round it up to the nearest 1oz.

(Example: 178.21oz to 179oz)

When connecting PEFY-P20VMA3-E units, add 0.54 kg of refrigerant for each of these units.

When connecting PEFY-P25/32/40VMA3-E units, add 0.74 kg of refrigerant for each of these units.

When connecting PEFY-P50/63/71/80/100/125VMA3-E units, add 1.16 kg of refrigerant for each of these units.

1) Maximum refrigerant charge

There is a limit to the amount of refrigerant that can be charged into a unit. Regardless of the amount yielded by the formula above, observe the maximum refrigerant charge in the table below.

Total index of the outdoor units	P200	P250	P300	P350	P400	P450
Maximum refrigerant charge <sup>*1</sup> (kg)	22.3	29.7	32.7	33.6	37.2	45.0
Maximum refrigerant charge <sup>*1</sup> [lbs-oz]	49-3	65-8	72-2	74-2	82-1	99-4
Total index of the outdoor units	P500	P400S	P450S	P500S	P550S	P600S
Maximum refrigerant charge <sup>*1</sup> (kg)	45.9	45.0	45.9	47.0	51.3	53.9
Maximum refrigerant charge <sup>*1</sup> [lbs-oz]	101-4	99-4	101-4	103-10	113-2	118-14
Total index of the outdoor units	P650S	P700S	P750S	P800S	P850S	P900S
Maximum refrigerant charge <sup>*1</sup> (kg)	56.5	68.9	68.9	71.4	73.2	75.7
Maximum refrigerant charge <sup>*1</sup> [lbs-oz]	124-9	151-15	151-15	157-7	161-7	166-15
Total index of the outdoor units	P950S	P1000S	P1050S	P1100S	P1150S	P1200S
Maximum refrigerant charge <sup>*1</sup> (kg)	96.9	99.9	102.9	106	109	112
Maximum refrigerant charge <sup>*1</sup> [lbs-oz]	213-10	220-4	226-14	233-11	240-5	246-15
Total index of the outdoor units	P1250S	P1300S	P1350S			
Maximum refrigerant charge <sup>*1</sup> (kg)	112	112	112			
Maximum refrigerant charge <sup>*1</sup> [lbs-oz]	246-15	246-15	246-15			

\*1 Maximum refrigerant charge: the amount of factory-charged refrigerant and the amount of refrigerant to be added on site.

**(2) Example: PUHY-P350YKB-A1**

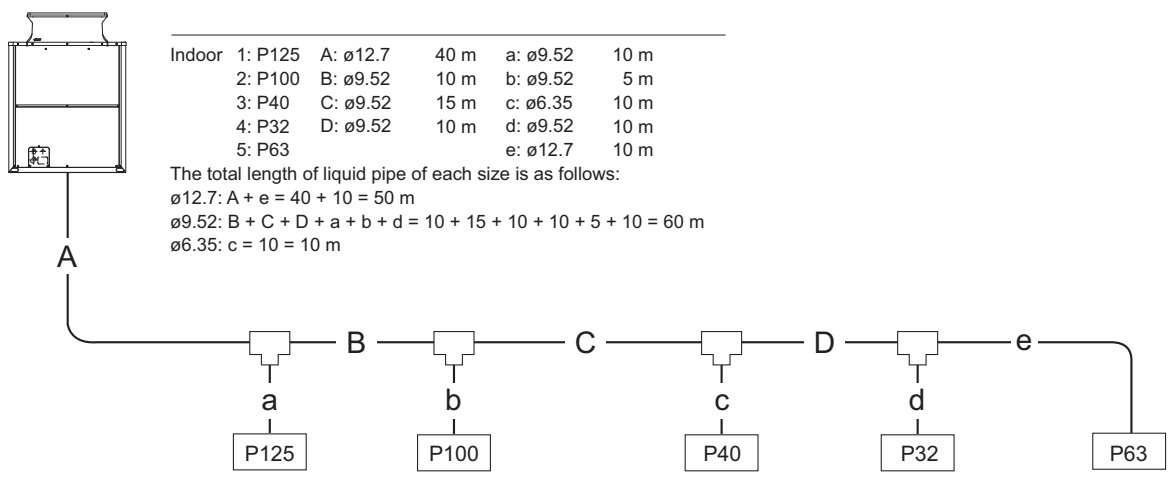

**(3) Sample calculation**

Additional refrigerant charge (kg)	=	Total length of liquid pipe sized ø19.05 x 0.26 (kg/m)	+	Total length of liquid pipe sized ø15.88 x 0.18 (kg/m)	+	Total length of liquid pipe sized ø12.7 x 0.11 (kg/m)	+	Total length of liquid pipe sized ø9.52 x 0.054 (kg/m)	+	Total length of liquid pipe sized ø6.35 x 0.021 (kg/m)	+ 0 + 3.5
		0 (m) x 0.26 (kg/m)		0 (m) x 0.18 (kg/m)		50 (m) x 0.11 (kg/m)		60 (m) x 0.054 (kg/m)		10 (m) x 0.021 (kg/m)	
	=	0	+	0	+	50 x 0.11	+	60 x 0.054	+	10 x 0.021	+ 0 + 3.5
	=	12.5 (12.45) kg									

**⚠ CAUTION**  
 Charge liquid refrigerant (as opposed to gaseous refrigerant) into the system.  
 •If gaseous refrigerant is charged into the system, the composition of the refrigerant in the cylinder will change and may result in performance loss.

## 6-9-4 Refrigerant Charge Adjustment Mode

Follow the procedures below to add or extract refrigerant as necessary depending on the operation mode.

When the function switch (SW4 (922)) on the main board on the outdoor unit (OC only) is turned to ON, the unit goes into the refrigerant amount adjust mode, and the following sequence is followed.

**Note**

The unit will not go into the refrigerant amount adjust mode when the switch on the OS is set to ON.

**Operation**

**When the unit is in the refrigerant amount adjust mode, the LEV on the indoor unit does not open as fully as it normally does during cooling operation to secure subcooling.**

**Note**

- 1) Using the flowchart on the next page, adjust the refrigerant charge. Check the TH4, TH3, TH2, TH6, Te, and Tc values of OC, OS1, and OS2 by setting the diagnostic switch (SW4 (SW6-10: OFF) first, and use these values to diagnose the refrigerant charge.
- 2) There may be cases when the refrigerant amount may seem adequate for a short while after starting the unit in the refrigerant amount adjust mode but turn out to be inadequate later on (when the refrigerant system stabilizes).

**When the amount of refrigerant is truly adequate.**

TH3-TH6 on the outdoor unit is 5°C [9°F] or above and SH on the indoor unit is between 5 and 15°C [9 and 27°F].

**The refrigerant amount may seem adequate at the moment, but may turn out to be inadequate later on.**

TH3-TH6 on the outdoor unit is 5°C [9°F] or less and SH on the indoor unit is 5°C [9°F] or less.

Wait until the TH3-TH6 reaches 5°C [9°F] or above and the SH of the indoor unit is between 5 and 15°C [9 and 27°F] to determine that the refrigerant amount is adequate.

- 3) If the high pressure is not at least 2.0 MPa [290 psi], a correct judgment will not be possible for refrigerant adjustment. Perform the adjustment when the outdoor air temperature is at least 20°C.
- 4) Refrigerant amount adjust mode automatically ends 90 minutes after beginning. When this happens, by turning off the SW4 (922) and turning them back on, the unit will go back into the refrigerant amount adjust mode.

SW4 settings

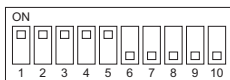
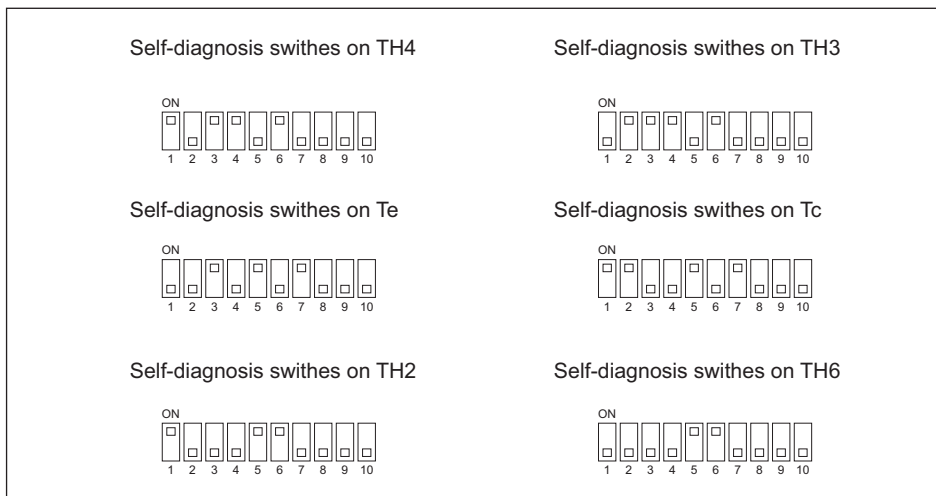

The figure at left shows that the switches 1 through 5 are set to ON and 6 through 10 are set to OFF.



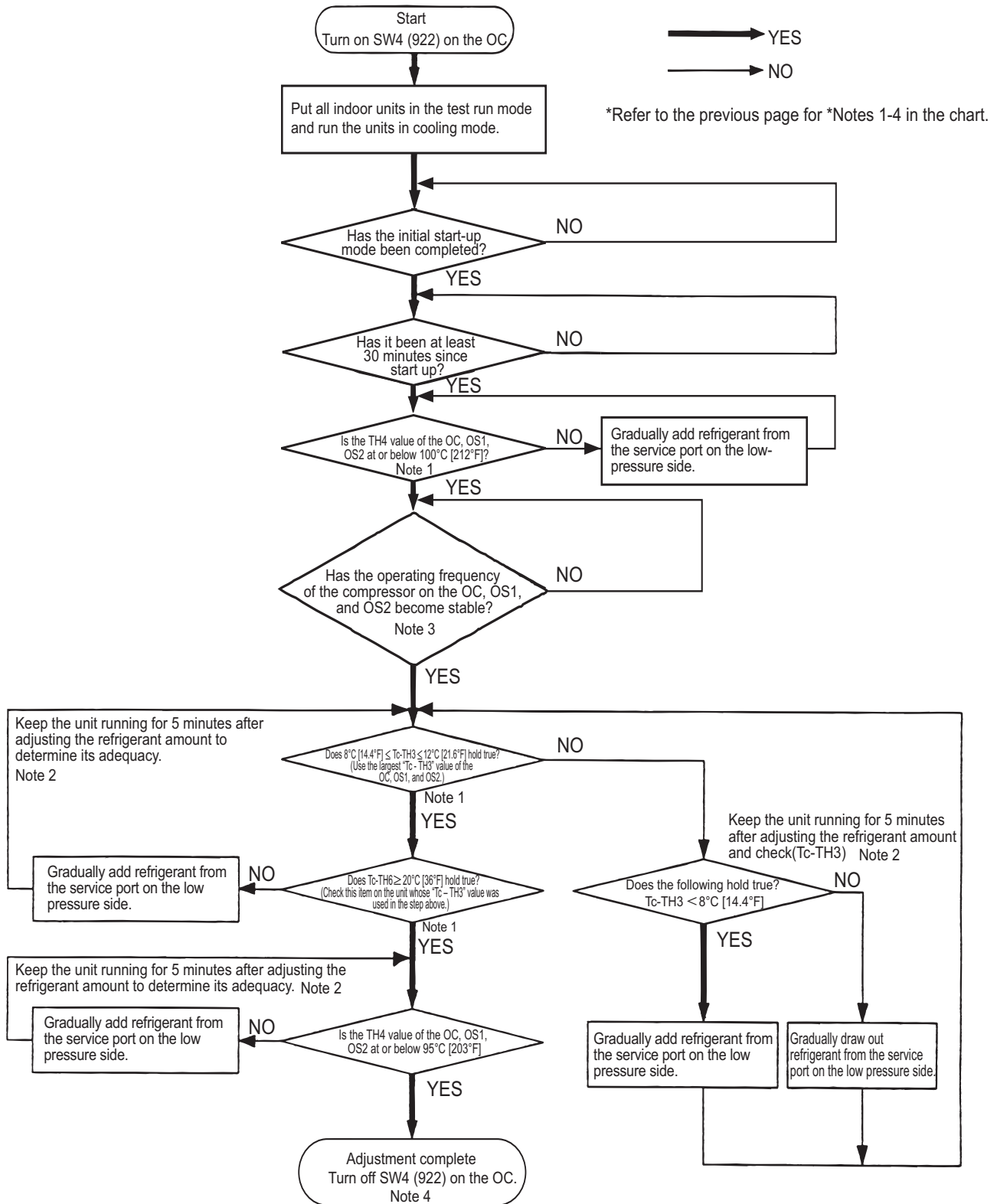

For information about Notes 1 through 4 in the flowchart, refer to items 1) through 4) on the previous page. [6-9-4 Refrigerant Charge Adjustment Mode](page 135)

**CAUTION**  
Do not release the extracted refrigerant into the air.

**CAUTION**  
Charge liquid refrigerant (as opposed to gaseous refrigerant) into the system.  
•If gaseous refrigerant is charged into the system, the composition of the refrigerant in the cylinder will change and may result in performance loss.

## 6-10 The Following Symptoms Are Normal

Symptoms	Remote controller display	Cause
The indoor unit does not start after starting cooling (heating) operation.	"Cooling (heating)" icon blinks on the display.	The unit cannot perform a heating (cooling) operation when other indoor units on the same refrigerant system, are performing a cooling (heating) operation.
The auto vane adjusts its position by itself.	Normal display	After an hour of cooling operation with the auto vane in the vertical position, the vane may automatically move into the horizontal position. Louver blades will automatically move into the horizontal position while the unit is in the defrost mode, pre-heating stand-by mode, or when the thermostat triggers unit off.
The fan speed changes during heating.	Normal display	Very Low fan speed when "Thermo-OFF." Changes from Very Low to pre-set fan speed when "Thermo-ON" depending on pipe temperature.
The fan stops during heating operation.	Defrost	The fan remains stopped during defrost operation.
The fan keeps running after the unit has stopped.	Unlit	When the auxiliary heater is turned on, the fan operates for one minute after stopping to dissipate heat.
The fan speed does not reach the set speed when operation switch is turned on.	STAND BY	The fan operates at extra low speed for 5 minutes after it is turned on or until the pipe temperature reaches 35°C[95°F], then it operates at low speed for 2 minutes, and finally it operates at the set speed. (Pre-heating stand-by)
When the main power is turned on, the display shown on the right appears on the indoor unit remote controller for 5 minutes.	"HO" or "PLEASE WAIT" icons blink on the display.	The system is starting up. Wait until the blinking display of "HO" or "PLEASE WAIT" go off.
The drain pump keeps running after the unit has stopped.	Unlit	The drain pump stays in operation for three minutes after the unit in the cooling mode is stopped.
The drain pump is running while the unit is stopped.	Unlit	When drain water is detected, the drain pump goes into operation even while the unit is stopped.
Indoor unit and BC controller make noise during cooling/heating changeover.	Normal display	This noise is made when the refrigerant circuit is reversed and is normal.
Sound of the refrigerant flow is heard from the indoor unit immediately after starting operation.	Normal display	This is caused by the transient instability of the refrigerant flow and is normal.
Warm air sometimes comes out of the indoor units that are not in the heating mode.	Normal display	This is due to the fact that the LEVs on some of the indoor units are kept slightly open to prevent the refrigerant in the indoor units that are not operating in the heating mode from liquefying and accumulating in the compressor. It is part of a normal operation.

# 6-11 Standard Operation Data (Reference Data)

## 6-11-1 Single Unit (Standard)

Outdoor unit model				PUHY-P200YKB-A1	PUHY-P250YKB-A1	
Conditions	Ambient temperature (cooling)	Indoor	DB/WB	26.7°C/19.4°C [80°F/67°F]	26.7°C/19.4°C [80°F/67°F]	
		Outdoor		35°C/- [95°F/-]	35°C/- [95°F/-]	
	Ambient temperature (heating)	Indoor	DB/WB	21.1°C/- [70°F/-]	21.1°C/- [70°F/-]	
		Outdoor		8.3°C/6.1°C [47°F/43°F]	8.3°C/6.1°C [47°F/43°F]	
	Indoor unit	Number of units connected		Unit	2	2
		Number of units in operation			2	2
		Model			-	100/100
	Piping	Main pipe	m [ft]	5 [16-3/8]	5 [16-3/8]	
		Branch pipe		10 [32-3/4]	10 [32-3/4]	
		Total pipe length		25 [82]	25 [82]	
	Fan speed			-	Hi	Hi
	Refrigerant charge			kg [lbs-oz]	11 [25]	13 [29]
	Outdoor unit	Voltage		V	400	400
<b>Cooling operation</b>						
Outdoor unit	Electric current		A	10.8	14.2	
	Compressor frequency		Hz	52	65	
LEV opening	Indoor unit		Pulse	325/325	325/325	
	SC (LEV1)			80	100	
	LEV2			2100	2100	
Pressure	High pressure (after O/S)/Low pressure (before accumulator)		MPa [psi]	2.59/0.96 [376/139]	2.83/0.84 [410/122]	
Section temperatures	Outdoor unit	Discharge (TH4)	°C [°F]	69 [156]	74 [165]	
		Heat exchanger outlet (TH3)		44 [111]	46 [115]	
		Accumulator inlet		10 [50]	10 [50]	
		Accumulator outlet		10 [50]	10 [50]	
		SCC outlet (TH6)		24 [75]	26 [79]	
		Compressor inlet		17 [63]	14 [57]	
		Compressor shell bottom		47 [117]	38 [100]	
	Indoor unit	LEV inlet		23 [73]	25 [77]	
		Heat exchanger outlet		10 [50]	10 [50]	
<b>Heating operation</b>						
Outdoor unit	Electric current		A	10.8	14.6	
	Compressor frequency		Hz	53	71	
LEV opening	Indoor unit		Pulse	332/332	332/332	
	SC (LEV1)			0	0	
	LEV2			2100	2100	
Pressure	High pressure (after O/S)/Low pressure (before accumulator)		MPa [psi]	2.59/0.67 [376/97]	2.85/0.64 [413/93]	
Section temperatures	Outdoor unit	Discharge (TH4)	°C [°F]	72 [162]	75 [167]	
		Heat exchanger outlet (TH3)		0 [32]	-2 [28]	
		Accumulator inlet		0 [32]	-2 [28]	
		Accumulator outlet		0 [32]	-2 [28]	
		Compressor inlet		0 [32]	-2 [28]	
		Compressor shell bottom		40 [104]	40 [104]	
	Indoor unit	LEV inlet		36 [97]	37 [99]	
		Heat exchanger inlet		70 [158]	73 [163]	

[6-11 Standard Operation Data (Reference Data) ]

Outdoor unit model				PUHY-P300YKB-A1	PUHY-P350YKB-A1	
Conditions	Ambient temperature (cooling)	Indoor	DB/WB	26.7°C/19.4°C [80°F/67°F]	26.7°C/19.4°C [80°F/67°F]	
		Outdoor		35°C/- [95°F/-]	35°C/- [95°F/-]	
	Ambient temperature (heating)	Indoor	DB/WB	21.1°C/- [70vF/?]	21.1°C/- [70°F/-]	
		Outdoor		8.3°C/6.1°C [47°F/43°F]	8.3°C/6.1°C [47°F/43°F]	
	Indoor unit	Number of units connected		Unit	3	3
		Number of units in operation			3	3
		Model			-	100/100/100
	Piping	Main pipe	m [ft]	5 [16-3/8]	5 [16-3/8]	
		Branch pipe		10 [32-3/4]	10 [32-3/4]	
		Total pipe length		35 [114-13/16]	35 [114-13/16]	
	Fan speed			-	Hi	Hi
	Refrigerant charge			kg [lbs-oz]	17 [38]	18 [40]
	Outdoor unit	Voltage		V	400	400
<b>Cooling operation</b>						
Outdoor unit	Electric current		A	16.7	20.8	
	Compressor frequency		Hz	74	95	
LEV opening	Indoor unit		Pulse	325/325/325	325/325/325	
	SC (LEV1)			100	190	
	LEV2			2100	2100	
Pressure	High pressure (after O/S)/Low pressure (before accumulator)		MPa [psi]	2.92/0.90 [424/131]	3.05/0.84 [442/122]	
Section temperatures	Outdoor unit	Discharge (TH4)	°C [°F]	73 [163]	82 [180]	
		Heat exchanger outlet (TH3)		40 [104]	45 [113]	
		Accumulator inlet		10 [50]	7 [45]	
		Accumulator outlet		10 [50]	7 [45]	
		SCC outlet (TH6)		20 [68]	25 [77]	
		Compressor inlet		15 [59]	19 [66]	
	Compressor shell bottom	42 [108]		38 [100]		
	Indoor unit	LEV inlet		19 [66]	17 [63]	
		Heat exchanger outlet		10 [50]	10 [50]	
<b>Heating operation</b>						
Outdoor unit	Electric current		A	17.4	23.3	
	Compressor frequency		Hz	81	102	
LEV opening	Indoor unit		Pulse	332/332/332	332/332/332	
	SC (LEV1)			0	0	
	LEV2			2100	2100	
Pressure	High pressure (after O/S)/Low pressure (before accumulator)		MPa [psi]	2.70/0.65 [392/94]	2.74/0.61 [397/88]	
Section temperatures	Outdoor unit	Discharge (TH4)	°C [°F]	70 [158]	89 [192]	
		Heat exchanger outlet (TH3)		-1 [30]	-3 [27]	
		Accumulator inlet		-1 [30]	-3 [27]	
		Accumulator outlet		-1 [30]	-3 [27]	
		Compressor inlet		-1 [30]	-3 [27]	
		Compressor shell bottom		40 [104]	40 [104]	
	Indoor unit	LEV inlet		36 [97]	37 [99]	
		Heat exchanger inlet		69 [156]	80 [176]	

6 Test Run

[6-11 Standard Operation Data (Reference Data) ]

Outdoor unit model			PUHY-P400YKB-A1	PUHY-P450YKB-A1		
Conditions	Ambient temperature (cooling)	Indoor	DB/WB	26.7°C/19.4°C [80°F/67°F]	26.7°C/19.4°C [80°F/67°F]	
		Outdoor		35°C/- [95°F/-]	35°C/- [95°F/-]	
	Ambient temperature (heating)	Indoor	DB/WB	21.1°C/- [70°F/-]	21.1°C/- [70°F/-]	
		Outdoor		8.3°C/6.1°C [47°F/43°F]	8.3°C/6.1°C [47°F/43°F]	
	Indoor unit	Number of units connected		Unit	4	4
		Number of units in operation			4	4
		Model			-	100/100/100/100
	Piping	Main pipe	m [ft]	5 [16-3/8]	5 [16-3/8]	
		Branch pipe		10 [32-3/4]	10 [32-3/4]	
		Total pipe length		45 [147-5/8]	45 [147-5/8]	
	Fan speed			-	Hi	Hi
	Refrigerant charge			kg [lbs-oz]	28 [62]	28 [62]
Outdoor unit	Voltage		V	400	400	
<b>Cooling operation</b>						
Outdoor unit	Electric current		A	27.6	34.6	
	Compressor frequency		Hz	97	111	
LEV opening	Indoor unit		Pulse	325/325/325	325/325/325/325	
	SC (LEV1)			100	190	
	LEV2			2100	2100	
Pressure	High pressure (after O/S)/Low pressure (before accumulator)		MPa [psi]	3.18/0.84 [461/122]	3.31/0.84 [480/122]	
Section temperatures	Outdoor unit	Discharge (TH4)	°C [°F]	84 [183]	86 [187]	
		Heat exchanger outlet (TH3)		45 [113]	45 [113]	
		Accumulator inlet		7 [45]	7 [45]	
		Accumulator outlet		7 [45]	7 [45]	
		SCC outlet (TH6)		25 [77]	25 [77]	
		Compressor inlet		19 [66]	19 [66]	
	Indoor unit	Compressor shell bottom		38 [100]	38 [100]	
		LEV inlet		17 [63]	17 [63]	
		Heat exchanger outlet		10 [50]	10 [50]	
<b>Heating operation</b>						
Outdoor unit	Electric current		A	29.0	36.4	
	Compressor frequency		Hz	108	120	
LEV opening	Indoor unit		Pulse	332/332/332/332	332/332/406/406	
	SC (LEV1)			0	0	
	LEV2			2100	2100	
Pressure	High pressure (after O/S)/Low pressure (before accumulator)		MPa [psi]	2.78/0.61 [403/88]	2.82/0.61 [409/88]	
Section temperatures	Outdoor unit	Discharge (TH4)	°C [°F]	90 [194]	90 [194]	
		Heat exchanger outlet (TH3)		-3 [27]	-3 [27]	
		Accumulator inlet		-3 [27]	-3 [27]	
		Accumulator outlet		-3 [27]	-3 [27]	
		Compressor inlet		-3 [27]	-3 [27]	
		Compressor shell bottom		40 [104]	40 [104]	
	Indoor unit	LEV inlet		37 [99]	37 [99]	
		Heat exchanger inlet		80 [176]	80 [176]	

Outdoor unit model				PUHY-P500YKB-A1	
Conditions	Ambient temperature (cooling)	Indoor	DB/WB	26.7°C/19.4°C [80°F/67°F]	
		Outdoor		35°C/- [95°F/-]	
	Ambient temperature (heating)	Indoor	DB/WB	21.1°C/- [70°F/-]	
		Outdoor		8.3°C/6.1°C [47°F/43°F]	
	Indoor unit	Number of units connected		Unit	4
		Number of units in operation			4
		Model		-	125/125/125/125
	Piping	Main pipe	m [ft]	5 [16-3/8]	
		Branch pipe		10 [32-3/4]	
		Total pipe length		45 [147-5/8]	
	Fan speed			-	Hi
	Refrigerant charge			kg [lbs-oz]	38 [84]
Outdoor unit	Voltage		V	400	
<b>Cooling operation</b>					
Outdoor unit	Electric current		A	43.5	
	Compressor frequency		Hz	120	
LEV opening	Indoor unit		Pulse	387/387/387/387	
	SC (LEV1)			100	
	LEV2			2100	
Pressure	High pressure (after O/S)/Low pressure (before accumulator)		MPa [psi]	2.76/0.93 [400/135]	
Section temperatures	Outdoor unit	Discharge (TH4)	°C [°F]	73 [163]	
		Heat exchanger outlet (TH3)		40 [104]	
		Accumulator inlet		10 [50]	
		Accumulator outlet		10 [50]	
		SCC outlet (TH6)		20 [68]	
		Compressor inlet		15 [59]	
		Compressor shell bottom		42 [108]	
	Indoor unit	LEV inlet		21 [70]	
		Heat exchanger outlet		10 [50]	
		<b>Heating operation</b>			
Outdoor unit	Electric current		A	46.2	
	Compressor frequency		Hz	129	
LEV opening	Indoor unit		Pulse	406/406/406/406	
	SC (LEV1)			0	
	LEV2			2100	
Pressure	High pressure (after O/S)/Low pressure (before accumulator)		MPa [psi]	2.65/0.66 [384/96]	
Section temperatures	Outdoor unit	Discharge (TH4)	°C [°F]	70 [158]	
		Heat exchanger outlet (TH3)		-1 [30]	
		Accumulator inlet		-1 [30]	
		Accumulator outlet		-1 [30]	
		Compressor inlet		-1 [30]	
		Compressor shell bottom		40 [104]	
	Indoor unit	LEV inlet		36 [97]	
		Heat exchanger inlet		70 [157]	

## 6-11-2 Dual Unit Combination (Standard)

Packaged unit model				PUHY-P400YSKB-A1	
Outdoor unit model				PUHY-P200YKB-A1	PUHY-P200YKB-A1
Conditions	Ambient temperature (cooling)	Indoor	DB/WB	26.7°C/19.4°C [80°F/67°F]	
		Outdoor		35°C/- [95°F/-]	
	Ambient temperature (heating)	Indoor	DB/WB	21.1°C/- [70°F/-]	
		Outdoor		8.3°C/6.1°C [47°F/43°F]	
	Indoor unit	Number of units connected		4	
		Number of units in operation		4	
		Model		100/100/100/100	
	Piping	Main pipe	m [ft]	5 [16-3/8]	
		Branch pipe		10 [32-3/4]	
		Total pipe length		45 [147-5/8]	
Fan speed			-		
Refrigerant charge			kg [lbs-oz]		
Outdoor unit			Voltage		
			V		
			400		
<b>Cooling operation</b>					
Outdoor unit	Electric current		A	21.6	
	Compressor frequency		Hz	52	52
LEV opening	Indoor unit		Pulse	325/325/325/325	
	SC (LEV1)			80	80
	LEV2			2100	2100
Pressure	High pressure (after O/S)/Low pressure (before accumulator)		MPa [psi]	2.59/0.96 [376/139]	2.59/0.96 [376/139]
Section temperatures	Outdoor unit	Discharge (TH4)	°C [°F]	69 [156]	69 [156]
		Heat exchanger outlet (TH3)		44 [111]	44 [111]
		Accumulator inlet		10 [50]	10 [50]
		Accumulator outlet		10 [50]	10 [50]
		SCC outlet (TH6)		24 [75]	24 [75]
		Compressor inlet		17 [63]	17 [63]
	Indoor unit	Compressor shell bottom		47 [117]	47 [117]
		LEV inlet		23 [73]	23 [73]
		Heat exchanger outlet		10 [50]	10 [50]
<b>Heating operation</b>					
Outdoor unit	Electric current		A	21.6	
	Compressor frequency		Hz	53	53
LEV opening	Indoor unit		Pulse	332/332/332/332	
	SC (LEV1)			0	
	LEV2			2100	2100
Pressure	High pressure (after O/S)/Low pressure (before accumulator)		MPa [psi]	2.59/0.67 [376/97]	2.59/0.67 [376/97]
Section temperatures	Outdoor unit	Discharge (TH4)	°C [°F]	72 [162]	72 [162]
		Heat exchanger outlet (TH3)		0 [32]	0 [32]
		Accumulator inlet		0 [32]	0 [32]
		Accumulator outlet		0 [32]	0 [32]
		Compressor inlet		0 [32]	0 [32]
		Compressor shell bottom		40 [104]	40 [104]
	Indoor unit	LEV inlet		36 [97]	36 [97]
		Heat exchanger inlet		70 [158]	70 [158]

[6-11 Standard Operation Data (Reference Data) ]

Packaged unit model				PUHY-P450YSKB-A1	
Outdoor unit model				PUHY-P200YKB-A1	PUHY-P250YKB-A1
Conditions	Ambient temperature (cooling)	Indoor	DB/WB	26.7°C/19.4°C [80°F/67°F]	
		Outdoor		35°C/- [95°F/-]	
	Ambient temperature (heating)	Indoor	DB/WB	21.1°C/- [70°F/-]	
		Outdoor		8.3°C/6.1°C [47°F/43°F]	
	Indoor unit	Number of units connected	Unit	4	
		Number of units in operation		4	
		Model		100/100/125/125	
	Piping	Main pipe	m [ft]	5 [16-3/8]	
		Branch pipe		10 [32-3/4]	
		Total pipe length		45 [147-5/8]	
Fan speed			-	Hi	
Refrigerant charge			kg [lbs-oz]	23 [51]	
Outdoor unit	Voltage		V	400	
<b>Cooling operation</b>					
Outdoor unit	Electric current		A	25.0	
	Compressor frequency		Hz	52	65
LEV opening	Indoor unit		Pulse	325/325/325/325	
	SC (LEV1)			80	100
	LEV2			2100	2100
Pressure	High pressure (after O/S)/Low pressure (before accumulator)		MPa [psi]	2.59/0.96 [376/139]	2.83/0.84 [410/122]
Section temperatures	Outdoor unit	Discharge (TH4)	°C [°F]	69 [156]	74 [165]
		Heat exchanger outlet (TH3)		44 [111]	46 [115]
		Accumulator inlet		10 [50]	10 [50]
		Accumulator outlet		10 [50]	10 [50]
		SCC outlet (TH6)		24 [75]	26 [79]
		Compressor inlet		17 [63]	14 [57]
		Compressor shell bottom		47 [117]	38 [100]
	Indoor unit	LEV inlet		23 [73]	25 [77]
		Heat exchanger outlet		10 [50]	10 [50]
<b>Heating operation</b>					
Outdoor unit	Electric current		A	25.4	
	Compressor frequency		Hz	53	71
LEV opening	Indoor unit		Pulse	332/332/332/332	
	SC (LEV1)			0	
	LEV2			2100	2100
Pressure	High pressure (after O/S)/Low pressure (before accumulator)		MPa [psi]	2.59/0.67 [376/97]	2.85/0.64 [413/93]
Section temperatures	Outdoor unit	Discharge (TH4)	°C [°F]	72 [162]	75 [167]
		Heat exchanger outlet (TH3)		0 [32]	-2 [28]
		Accumulator inlet		0 [32]	-2 [28]
		Accumulator outlet		0 [32]	-2 [28]
		Compressor inlet		0 [32]	-2 [28]
		Compressor shell bottom		40 [104]	40 [104]
		Indoor unit		LEV inlet	36 [97]
	Heat exchanger inlet			70 [158]	73 [163]

6 Test Run



[6-11 Standard Operation Data (Reference Data) ]

Packaged unit model				PUHY-P500YSKB-A1		
Outdoor unit model				PUHY-P250YKB-A1	PUHY-P250YKB-A1	
Conditions	Ambient temperature (cooling)	Indoor	DB/WB	26.7°C/19.4°C [80°F/67°F]		
		Outdoor		35°C/- [95°F/-]		
	Ambient temperature (heating)	Indoor	DB/WB	21.1°C/- [70°F/-]		
		Outdoor		8.3°C/6.1°C [47°F/43°F]		
	Indoor unit	Number of units connected		Unit	4	
		Number of units in operation			4	
		Model			-	
	Piping	Main pipe	m [ft]	5 [16-3/8]		
		Branch pipe		10 [32-3/4]		
		Total pipe length		45 [147-5/8]		
	Fan speed			-	Hi	
	Refrigerant charge			kg [lbs-oz]	25 [56]	
Outdoor unit	Voltage		V	400		
<b>Cooling operation</b>						
Outdoor unit	Electric current		A	28.4		
	Compressor frequency		Hz	65	65	
LEV opening	Indoor unit		Pulse	325/325/325/325		
	SC (LEV1)			100	100	
	LEV2			2100	2100	
Pressure	High pressure (after O/S)/Low pressure (before accumulator)		MPa [psi]	2.83/0.84 [410/122]		
Section temperatures	Outdoor unit	Discharge (TH4)	°C [°F]	74 [165]	74 [165]	
		Heat exchanger outlet (TH3)		46 [115]	46 [115]	
		Accumulator inlet		10 [50]	10 [50]	
		Accumulator outlet		10 [50]	10 [50]	
		SCC outlet (TH6)		26 [79]	26 [79]	
		Compressor inlet		14 [57]	14 [57]	
		Compressor shell bottom		38 [100]	38 [100]	
	Indoor unit	LEV inlet		25 [77]	25 [77]	
		Heat exchanger outlet		10 [50]	10 [50]	
<b>Heating operation</b>						
Outdoor unit	Electric current		A	29.3		
	Compressor frequency		Hz	71	71	
LEV opening	Indoor unit		Pulse	332/332/332/332		
	SC (LEV1)			0		
	LEV2			2100	2100	
Pressure	High pressure (after O/S)/Low pressure (before accumulator)		MPa [psi]	2.85/0.64 [413/93]		
Section temperatures	Outdoor unit	Discharge (TH4)	°C [°F]	75 [167]	75 [167]	
		Heat exchanger outlet (TH3)		-2 [28]	-2 [28]	
		Accumulator inlet		-2 [28]	-2 [28]	
		Accumulator outlet		-2 [28]	-2 [28]	
		Compressor inlet		-2 [28]	-2 [28]	
		Compressor shell bottom		40 [104]	40 [104]	
	Indoor unit	LEV inlet		37 [99]	37 [99]	
		Heat exchanger inlet		73 [163]	73 [163]	

[6-11 Standard Operation Data (Reference Data) ]

Packaged unit model				PUHY-P550YSKB-A1	
Outdoor unit model				PUHY-P250YKB-A1	PUHY-P300YKB-A1
Conditions	Ambient temperature (cooling)	Indoor	DB/WB	26.7°C/19.4°C [80°F/67°F]	
		Outdoor		35°C/- [95°F/-]	
	Ambient temperature (heating)	Indoor	DB/WB	21.1°C/- [70°F/-]	
		Outdoor		8.3°C/6.1°C [47°F/43°F]	
	Indoor unit	Number of units connected	Unit	5	
		Number of units in operation		5	
		Model		100/100/100/125/125	
	Piping	Main pipe	m [ft]	5 [16-3/8]	
		Branch pipe		10 [32-3/4]	
		Total pipe length		55 [180-7/16]	
Fan speed			-	Hi	
Refrigerant charge			kg [lbs-oz]	29 [64]	
Outdoor unit	Voltage		V	400	
<b>Cooling operation</b>					
Outdoor unit	Electric current		A	30.9	
	Compressor frequency		Hz	65	74
LEV opening	Indoor unit		Pulse	325/325/325/325/325	
	SC (LEV1)			100	100
	LEV2			2100	2100
Pressure	High pressure (after O/S)/Low pressure (before accumulator)		MPa [psi]	2.83/0.84 [410/122]	2.92/0.90 [424/131]
Section temperatures	Outdoor unit	Discharge (TH4)	°C [°F]	74 [165]	73 [163]
		Heat exchanger outlet (TH3)		46 [115]	40 [104]
		Accumulator inlet		10 [50]	10 [50]
		Accumulator outlet		10 [50]	10 [50]
		SCC outlet (TH6)		26 [79]	20 [68]
		Compressor inlet		14 [57]	15 [59]
		Compressor shell bottom		38 [100]	42 [108]
	Indoor unit	LEV inlet		25 [77]	19 [66]
		Heat exchanger outlet		10 [50]	10 [50]
<b>Heating operation</b>					
Outdoor unit	Electric current		A	32.0	
	Compressor frequency		Hz	71	81
LEV opening	Indoor unit		Pulse	332/332/332/332/332	
	SC (LEV1)			0	
	LEV2			2100	2100
Pressure	High pressure (after O/S)/Low pressure (before accumulator)		MPa [psi]	2.85/0.64 [413/93]	2.70/0.65 [392/94]
Section temperatures	Outdoor unit	Discharge (TH4)	°C [°F]	75 [167]	70 [158]
		Heat exchanger outlet (TH3)		-2 [28]	-1 [30]
		Accumulator inlet		-2 [28]	-1 [30]
		Accumulator outlet		-2 [28]	-1 [30]
		Compressor inlet		-2 [28]	-1 [30]
		Compressor shell bottom		40 [104]	40 [104]
	Indoor unit	LEV inlet		37 [99]	36 [97]
		Heat exchanger inlet		73 [163]	69 [156]

6 Test Run

[6-11 Standard Operation Data (Reference Data) ]

Packaged unit model				PUHY-P600YSKB-A1		
Outdoor unit model				PUHY-P250YKB-A1	PUHY-P350YKB-A1	
Conditions	Ambient temperature (cooling)	Indoor	DB/WB	26.7°C/19.4°C [80°F/67°F]		
		Outdoor		35°C/- [95°F/-]		
	Ambient temperature (heating)	Indoor	DB/WB	21.1°C/- [70°F/-]		
		Outdoor		8.3°C/6.1°C [47°F/43°F]		
	Indoor unit	Number of units connected		Unit	5	
		Number of units in operation			5	
		Model			100/125/125/125/125	
	Piping	Main pipe	m [ft]	5 [16-3/8]		
		Branch pipe		10 [32-3/4]		
		Total pipe length		55 [180-7/16]		
	Fan speed			-	Hi	
	Refrigerant charge			kg [lbs-oz]	29 [64]	
Outdoor unit	Voltage		V	400		
<b>Cooling operation</b>						
Outdoor unit	Electric current		A	35.0		
	Compressor frequency		Hz	65	95	
LEV opening	Indoor unit		Pulse	325/325/325/325/325		
	SC (LEV1)			100	190	
	LEV2			2100	2100	
Pressure	High pressure (after O/S)/Low pressure (before accumulator)		MPa [psi]	2.83/0.84 [410/122]	3.05/0.84 [442/122]	
Section temperatures	Outdoor unit	Discharge (TH4)	°C [°F]	74 [165]	82 [180]	
		Heat exchanger outlet (TH3)		46 [115]	45 [113]	
		Accumulator inlet		10 [50]	7 [45]	
		Accumulator outlet		10 [50]	7 [45]	
		SCC outlet (TH6)		26 [79]	25 [77]	
		Compressor inlet		14 [57]	19 [66]	
		Compressor shell bottom		38 [100]	38 [100]	
	Indoor unit	LEV inlet		25 [77]	17 [63]	
		Heat exchanger outlet		10 [50]	10 [50]	
<b>Heating operation</b>						
Outdoor unit	Electric current		A	38.0		
	Compressor frequency		Hz	71	102	
LEV opening	Indoor unit		Pulse	332/332/332/332/332		
	SC (LEV1)			0		
	LEV2			2100	2100	
Pressure	High pressure (after O/S)/Low pressure (before accumulator)		MPa [psi]	2.85/0.64 [413/93]	2.74/0.61 [397/88]	
Section temperatures	Outdoor unit	Discharge (TH4)	°C [°F]	75 [167]	89 [192]	
		Heat exchanger outlet (TH3)		-2 [28]	-3 [27]	
		Accumulator inlet		-2 [28]	-3 [27]	
		Accumulator outlet		-2 [28]	-3 [27]	
		Compressor inlet		-2 [28]	-3 [27]	
		Compressor shell bottom		40 [104]	40 [104]	
	Indoor unit	LEV inlet		37 [99]	37 [99]	
		Heat exchanger inlet		73 [163]	80 [176]	

[6-11 Standard Operation Data (Reference Data) ]

Packaged unit model				PUHY-P650YSKB-A1	
Outdoor unit model				PUHY-P300YKB-A1	PUHY-P350YKB-A1
Conditions	Ambient temperature (cooling)	Indoor	DB/WB	26.7°C/19.4°C [80°F/67°F]	
		Outdoor		35°C/- [95°F/-]	
	Ambient temperature (heating)	Indoor	DB/WB	21.1°C/- [70°F/-]	
		Outdoor		8.3°C/6.1°C [47°F/43°F]	
	Indoor unit	Number of units connected		6	
		Number of units in operation		6	
		Model		100/100/100/100/125/125	
	Piping	Main pipe	m [ft]	5 [16-3/8]	
		Branch pipe		10 [32-3/4]	
		Total pipe length		65 [213-1/4]	
	Fan speed			-	
	Refrigerant charge			kg [lbs-oz]	34 [75]
Outdoor unit	Voltage		V		
<b>Cooling operation</b>					
Outdoor unit	Electric current		A	37.5	
	Compressor frequency		Hz	74	95
LEV opening	Indoor unit		Pulse	325/325/325/325/325/325	
	SC (LEV1)			100	190
	LEV2			2100	2100
Pressure	High pressure (after O/S)/Low pressure (before accumulator)		MPa [psi]	2.92/0.90 [424/131]	3.05/0.84 [442/122]
Section temperatures	Outdoor unit	Discharge (TH4)	°C [°F]	73 [163]	82 [180]
		Heat exchanger outlet (TH3)		40 [104]	45 [113]
		Accumulator inlet		10 [50]	7 [45]
		Accumulator outlet		10 [50]	7 [45]
		SCC outlet (TH6)		20 [68]	25 [77]
		Compressor inlet		15 [59]	19 [66]
		Compressor shell bottom		42 [108]	38 [100]
	Indoor unit	LEV inlet		19 [66]	17 [63]
		Heat exchanger outlet		10 [50]	10 [50]
		<b>Heating operation</b>			
Outdoor unit	Electric current		A	40.7	
	Compressor frequency		Hz	81	102
LEV opening	Indoor unit		Pulse	332/332/332/332/332/332	
	SC (LEV1)			0	
	LEV2			2100	2100
Pressure	High pressure (after O/S)/Low pressure (before accumulator)		MPa [psi]	2.70/0.65 [392/94]	2.74/0.61 [397/88]
Section temperatures	Outdoor unit	Discharge (TH4)	°C [°F]	70 [158]	89 [192]
		Heat exchanger outlet (TH3)		-1 [30]	-3 [27]
		Accumulator inlet		-1 [30]	-3 [27]
		Accumulator outlet		-1 [30]	-3 [27]
		Compressor inlet		-1 [30]	-3 [27]
		Compressor shell bottom		40 [104]	40 [104]
	Indoor unit	LEV inlet		36 [97]	37 [99]
		Heat exchanger inlet		69 [156]	80 [176]

6 Test Run

[6-11 Standard Operation Data (Reference Data) ]

Packaged unit model				PUHY-P700YSKB-A1		
Outdoor unit model				PUHY-P350YKB-A1	PUHY-P350YKB-A1	
Conditions	Ambient temperature (cooling)	Indoor	DB/WB	26.7°C/19.4°C [80°F/67°F]		
		Outdoor		35°C/- [95°F/-]		
	Ambient temperature (heating)	Indoor	DB/WB	21.1°C/- [70°F/-]		
		Outdoor		8.3°C/6.1°C [47°F/43°F]		
	Indoor unit	Number of units connected		Unit	6	
		Number of units in operation			6	
		Model			100/100/125/125/125/125	
	Piping	Main pipe	m [ft]	5 [16-3/8]		
		Branch pipe		10 [32-3/4]		
		Total pipe length		65 [213-1/4]		
	Fan speed			-	Hi	
	Refrigerant charge			kg [lbs-oz]	35 [78]	
Outdoor unit	Voltage		V	400		
<b>Cooling operation</b>						
Outdoor unit	Electric current		A	41.6		
	Compressor frequency		Hz	95	95	
LEV opening	Indoor unit		Pulse	325/325/325/325/325/325		
	SC (LEV1)			190	190	
	LEV2			2100	2100	
Pressure	High pressure (after O/S)/Low pressure (before accumulator)		MPa [psi]	3.05/0.84 [442/122]	3.05/0.84 [442/122]	
Section temperatures	Outdoor unit	Discharge (TH4)	°C [°F]	82 [180]	82 [180]	
		Heat exchanger outlet (TH3)		45 [113]	45 [113]	
		Accumulator inlet		7 [45]	7 [45]	
		Accumulator outlet		7 [45]	7 [45]	
		SCC outlet (TH6)		25 [77]	25 [77]	
		Compressor inlet		19 [66]	19 [66]	
		Compressor shell bottom		38 [100]	38 [100]	
	Indoor unit	LEV inlet		17 [63]	17 [63]	
		Heat exchanger outlet		10 [50]	10 [50]	
<b>Heating operation</b>						
Outdoor unit	Electric current		A	46.6		
	Compressor frequency		Hz	102	102	
LEV opening	Indoor unit		Pulse	332/332/332/332/332/332		
	SC (LEV1)			0		
	LEV2			2100	2100	
Pressure	High pressure (after O/S)/Low pressure (before accumulator)		MPa [psi]	2.74/0.61 [397/88]	2.74/0.61 [397/88]	
Section temperatures	Outdoor unit	Discharge (TH4)	°C [°F]	89 [192]	89 [192]	
		Heat exchanger outlet (TH3)		-3 [27]	-3 [27]	
		Accumulator inlet		-3 [27]	-3 [27]	
		Accumulator outlet		-3 [27]	-3 [27]	
		Compressor inlet		-3 [27]	-3 [27]	
		Compressor shell bottom		40 [104]	40 [104]	
		Indoor unit		LEV inlet	37 [99]	37 [99]
	Heat exchanger inlet			80 [176]	80 [176]	

[6-11 Standard Operation Data (Reference Data) ]

Packaged unit model				PUHY-P750YSKB-A1	
Outdoor unit model				PUHY-P350YKB-A1	PUHY-P400YKB-A1
Conditions	Ambient temperature (cooling)	Indoor	DB/WB	26.7°C/19.4°C [80°F/67°F]	
		Outdoor		35°C/- [95°F/-]	
	Ambient temperature (heating)	Indoor	DB/WB	21.1°C/- [70°F/-]	
		Outdoor		8.3°C/6.1°C [47°F/43°F]	
	Indoor unit	Number of units connected	Unit	7	
		Number of units in operation		7	
		Model	-	100/100/100/100/100/125/125	
	Piping	Main pipe	m [ft]	5 [16-3/8]	
		Branch pipe		10 [32-3/4]	
		Total pipe length		75 [246-1/16]	
Fan speed			Hi		
Refrigerant charge			kg [lbs-oz]	37 [82]	
Outdoor unit	Voltage	V	400		
<b>Cooling operation</b>					
Outdoor unit	Electric current	A	46.5		
	Compressor frequency	Hz	95	97	
LEV opening	Indoor unit	Pulse	325/325/325/325/325/325/325		
	SC (LEV1)		190	100	
	LEV2		2100	2100	
Pressure	High pressure (after O/S)/Low pressure (before accumulator)	MPa [psi]	3.05/0.84 [442/122]	3.18/0.84 [461/122]	
Section temperatures	Outdoor unit	Discharge (TH4)	82 [180]	84 [183]	
		Heat exchanger outlet (TH3)	45 [113]	45 [113]	
		Accumulator inlet	7 [45]	7 [45]	
		Accumulator outlet	7 [45]	7 [45]	
		SCC outlet (TH6)	25 [77]	25 [77]	
		Compressor inlet	19 [66]	19 [66]	
		Compressor shell bottom	38 [100]	38 [100]	
	Indoor unit	LEV inlet	17 [63]	17 [63]	
		Heat exchanger outlet	10 [50]	10 [50]	
<b>Heating operation</b>					
Outdoor unit	Electric current	A	49.6		
	Compressor frequency	Hz	102	108	
LEV opening	Indoor unit	Pulse	332/332/332/332/332/332/332		
	SC (LEV1)		0		
	LEV2		2100	2100	
Pressure	High pressure (after O/S)/Low pressure (before accumulator)	MPa [psi]	2.74/0.61 [397/88]	2.78/0.61 [403/88]	
Section temperatures	Outdoor unit	Discharge (TH4)	89 [192]	90 [194]	
		Heat exchanger outlet (TH3)	-3 [27]	-3 [27]	
		Accumulator inlet	-3 [27]	-3 [27]	
		Accumulator outlet	-3 [27]	-3 [27]	
		Compressor inlet	-3 [27]	-3 [27]	
		Compressor shell bottom	40 [104]	40 [104]	
	Indoor unit	LEV inlet	37 [99]	37 [99]	
		Heat exchanger inlet	80 [176]	80 [176]	

6 Test Run

[6-11 Standard Operation Data (Reference Data) ]

Packaged unit model				PUHY-P800YSKB-A1	
Outdoor unit model				PUHY-P350YKB-A1	PUHY-P450YKB-A1
Conditions	Ambient temperature (cooling)	Indoor	DB/WB	26.7°C/19.4°C [80°F/67°F]	
		Outdoor		35°C/- [95°F/-]	
	Ambient temperature (heating)	Indoor	DB/WB	21.1°C/- [70°F/-]	
		Outdoor		8.3°C/6.1°C [47°F/43°F]	
	Indoor unit	Number of units connected	Unit	7	
		Number of units in operation		7	
		Model	-	100/100/100/125/125/125/125	
	Piping	Main pipe	m [ft]	5 [16-3/8]	
		Branch pipe		10 [32-3/4]	
		Total pipe length		75 [246-1/16]	
Fan speed			-	Hi	
Refrigerant charge			kg [lbs-oz]	37 [82]	
Outdoor unit	Voltage	V	400		
<b>Cooling operation</b>					
Outdoor unit	Electric current	A	49.7		
	Compressor frequency	Hz	95	111	
LEV opening	Indoor unit	Pulse	325/325/325/325/325/325/325		
	SC (LEV1)		190	190	
	LEV2		2100	2100	
Pressure	High pressure (after O/S)/Low pressure (before accumulator)	MPa [psi]	3.05/0.84 [442/122]	3.31/0.84 [480/122]	
Section temperatures	Outdoor unit	Discharge (TH4)	°C [°F]	82 [180]	86 [187]
		Heat exchanger outlet (TH3)		45 [113]	45 [113]
		Accumulator inlet		7 [45]	7 [45]
		Accumulator outlet		7 [45]	7 [45]
		SCC outlet (TH6)		25 [77]	25 [77]
		Compressor inlet		19 [66]	19 [66]
		Compressor shell bottom		38 [100]	38 [100]
	Indoor unit	LEV inlet		17 [63]	17 [63]
		Heat exchanger outlet		10 [50]	10 [50]
<b>Heating operation</b>					
Outdoor unit	Electric current	A	53.2		
	Compressor frequency	Hz	102	120	
LEV opening	Indoor unit	Pulse	332/332/332/332/332/332/332		
	SC (LEV1)		0		
	LEV2		2100	2100	
Pressure	High pressure (after O/S)/Low pressure (before accumulator)	MPa [psi]	2.74/0.61 [397/88]	2.82/0.61 [409/88]	
Section temperatures	Outdoor unit	Discharge (TH4)	°C [°F]	89 [192]	90 [194]
		Heat exchanger outlet (TH3)		-3 [27]	-3 [27]
		Accumulator inlet		-3 [27]	-3 [27]
		Accumulator outlet		-3 [27]	-3 [27]
		Compressor inlet		-3 [27]	-3 [27]
		Compressor shell bottom		40 [104]	40 [104]
	Indoor unit	LEV inlet		37 [99]	37 [99]
		Heat exchanger inlet		80 [176]	80 [176]

[6-11 Standard Operation Data (Reference Data) ]

Packaged unit model				PUHY-P850YSKB-A1	
Outdoor unit model				PUHY-P400YKB-A1	PUHY-P450YKB-A1
Conditions	Ambient temperature (cooling)	Indoor	DB/WB	26.7°C/19.4°C [80°F/67°F]	
		Outdoor		35°C/- [95°F/-]	
	Ambient temperature (heating)	Indoor	DB/WB	21.1°C/- [70°F/-]	
		Outdoor		8.3°C/6.1°C [47°F/43°F]	
	Indoor unit	Number of units connected	Unit	8	
		Number of units in operation		8	
		Model	-	100/100/100/100/100/100/125/125	
	Piping	Main pipe	m [ft]	5 [16-3/8]	
		Branch pipe		10 [32-3/4]	
		Total pipe length		85 [278-13/16]	
	Fan speed			-	Hi
Refrigerant charge			kg [lbs-oz]	39 [86]	
Outdoor unit	Voltage	V	400		
<b>Cooling operation</b>					
Outdoor unit	Electric current	A	54.7		
	Compressor frequency	Hz	97	111	
LEV opening	Indoor unit	Pulse	325/325/325/325/325/325/325		
	SC (LEV1)		100	190	
	LEV2		2100	2100	
Pressure	High pressure (after O/S)/Low pressure (before accumulator)	MPa [psi]	3.18/0.84 [461/122]	3.31/0.84 [480/122]	
Section temperatures	Outdoor unit	Discharge (TH4)	84 [183]	86 [187]	
		Heat exchanger outlet (TH3)	45 [113]	45 [113]	
		Accumulator inlet	7 [45]	7 [45]	
		Accumulator outlet	7 [45]	7 [45]	
		SCC outlet (TH6)	25 [77]	25 [77]	
		Compressor inlet	19 [66]	19 [66]	
		Compressor shell bottom	38 [100]	38 [100]	
	Indoor unit	LEV inlet	17 [63]	17 [63]	
		Heat exchanger outlet	10 [50]	10 [50]	
<b>Heating operation</b>					
Outdoor unit	Electric current	A	56.2		
	Compressor frequency	Hz	108	120	
LEV opening	Indoor unit	Pulse	332/332/332/332/332/332/332		
	SC (LEV1)		0		
	LEV2		2100	2100	
Pressure	High pressure (after O/S)/Low pressure (before accumulator)	MPa [psi]	2.78/0.61 [403/88]	2.82/0.61 [409/88]	
Section temperatures	Outdoor unit	Discharge (TH4)	90 [194]	90 [194]	
		Heat exchanger outlet (TH3)	-3 [27]	-3 [27]	
		Accumulator inlet	-3 [27]	-3 [27]	
		Accumulator outlet	-3 [27]	-3 [27]	
		Compressor inlet	-3 [27]	-3 [27]	
		Compressor shell bottom	40 [104]	40 [104]	
	Indoor unit	LEV inlet	37 [99]	37 [99]	
		Heat exchanger inlet	80 [176]	80 [176]	

6 Test Run



[6-11 Standard Operation Data (Reference Data) ]

Packaged unit model				PUHY-P900YSKB-A1		
Outdoor unit model				PUHY-P450YKB-A1	PUHY-P450YKB-A1	
Conditions	Ambient temperature (cooling)	Indoor	DB/WB	26.7°C/19.4°C [80°F/67°F]		
		Outdoor		35°C/- [95°F/-]		
	Ambient temperature (heating)	Indoor	DB/WB	21.1°C/- [70°F/-]		
		Outdoor		8.3°C/6.1°C [47°F/43°F]		
	Indoor unit	Number of units connected		Unit	8	
		Number of units in operation			8	
		Model			100/100/100/100/125/125/125/125	
	Piping	Main pipe	m [ft]	5 [16-3/8]		
		Branch pipe		10 [32-3/4]		
		Total pipe length		85 [278-13/16]		
	Fan speed			-	Hi	
	Refrigerant charge			kg [lbs-oz]	40 [89]	
Outdoor unit	Voltage		V	400		
<b>Cooling operation</b>						
Outdoor unit	Electric current		A	57.9		
	Compressor frequency		Hz	111	111	
LEV opening	Indoor unit		Pulse	325/325/325/325/325/325/325		
	SC (LEV1)			190	190	
	LEV2			2100	2100	
Pressure	High pressure (after O/S)/Low pressure (before accumulator)		MPa [psi]	3.31/0.84 [480/122]	3.31/0.84 [480/122]	
Section temperatures	Outdoor unit	Discharge (TH4)	°C [°F]	86 [187]	86 [187]	
		Heat exchanger outlet (TH3)		45 [113]	45 [113]	
		Accumulator inlet		7 [45]	7 [45]	
		Accumulator outlet		7 [45]	7 [45]	
		SCC outlet (TH6)		25 [77]	25 [77]	
		Compressor inlet		19 [66]	19 [66]	
		Compressor shell bottom		38 [100]	38 [100]	
	Indoor unit	LEV inlet		17 [63]	17 [63]	
		Heat exchanger outlet		10 [50]	10 [50]	
<b>Heating operation</b>						
Outdoor unit	Electric current		A	59.8		
	Compressor frequency		Hz	120	120	
LEV opening	Indoor unit		Pulse	332/332/332/332/332/332/332		
	SC (LEV1)			0		
	LEV2			2100	2100	
Pressure	High pressure (after O/S)/Low pressure (before accumulator)		MPa [psi]	2.82/0.61 [409/88]	2.82/0.61 [409/88]	
Section temperatures	Outdoor unit	Discharge (TH4)	°C [°F]	90 [194]	90 [194]	
		Heat exchanger outlet (TH3)		-3 [27]	-3 [27]	
		Accumulator inlet		-3 [27]	-3 [27]	
		Accumulator outlet		-3 [27]	-3 [27]	
		Compressor inlet		-3 [27]	-3 [27]	
		Compressor shell bottom		40 [104]	40 [104]	
	Indoor unit	LEV inlet		37 [99]	37 [99]	
		Heat exchanger inlet		80 [176]	80 [176]	

### 6-11-3 Triple Unit Combination (Standard)

Packaged unit model				PUHY-P950YSKB-A1			
Outdoor unit model				PUHY-P250YKB-A1	PUHY-P300YKB-A1	PUHY-P400YKB-A1	
Conditions	Ambient temperature (cooling)	Indoor	DB/WB	26.7°C/19.4°C [80°F/67°F]			
		Outdoor		35°C/- [95°F/-]			
	Ambient temperature (heating)	Indoor	DB/WB	21.1°C/- [70°F/-]			
		Outdoor		8.3°C/6.1°C [47°F/43°F]			
	Indoor unit	Number of units connected		Unit	9		
		Number of units in operation			9		
		Model			100/100/100/100/100/100/100/125/125		
	Piping	Main pipe	m [ft]	5 [16-3/8]			
		Branch pipe		10 [32-3/4]			
		Total pipe length		95 [311-5/8]			
Fan speed		-	Hi				
Refrigerant charge		kg [lbs-oz]	48 [106]				
Outdoor unit	Voltage		V	400			
<b>Cooling operation</b>							
Outdoor unit	Electric current		A	56.7			
	Compressor frequency		Hz	65	74	97	
LEV opening	Indoor unit		Pulse	325/325/325/325/325/325/325/325/325			
	SC (LEV1)			100	100	100	
	LEV2			2100	2100	2100	
Pressure	High pressure (after O/S)/Low pressure (before accumulator)		MPa [psi]	2.83/0.84 [410/122]	2.92/0.90 [424/131]	3.18/0.84 [461/122]	
Section temperatures	Outdoor unit	Discharge (TH4)	°C [°F]	74 [165]	73 [163]	84 [183]	
		Heat exchanger outlet (TH3)		46 [115]	40 [104]	45 [113]	
		Accumulator inlet		10 [50]	10 [50]	7 [45]	
		Accumulator outlet		10 [50]	10 [50]	7 [45]	
		SCC outlet (TH6)		26 [79]	20 [68]	25 [77]	
		Compressor inlet		14 [57]	15 [59]	19 [66]	
		Compressor shell bottom		38 [100]	42 [108]	38 [100]	
	Indoor unit	LEV inlet		25 [77]	19 [66]	17 [63]	
		Heat exchanger outlet		10 [50]	10 [50]	10 [50]	
<b>Heating operation</b>							
Outdoor unit	Electric current		A	58.3			
	Compressor frequency		Hz	71	81	108	
LEV opening	Indoor unit		Pulse	332/332/332/332/332/332/332/332/332			
	SC (LEV1)			0			
	LEV2			2100	2100	2100	
Pressure	High pressure (after O/S)/Low pressure (before accumulator)		MPa [psi]	2.85/0.64 [413/93]	2.70/0.65 [392/94]	2.78/0.61 [403/88]	
Section temperatures	Outdoor unit	Discharge (TH4)	°C [°F]	75 [167]	70 [158]	90 [194]	
		Heat exchanger outlet (TH3)		-2 [28]	-1 [30]	-3 [27]	
		Accumulator inlet		-2 [28]	-1 [30]	-3 [27]	
		Accumulator outlet		-2 [28]	-1 [30]	-3 [27]	
		Compressor inlet		-2 [28]	-1 [30]	-3 [27]	
		Compressor shell bottom		40 [104]	40 [104]	40 [104]	
	Indoor unit	LEV inlet		37 [99]	36 [97]	37 [99]	
		Heat exchanger inlet		73 [163]	69 [156]	80 [176]	

6 Test Run

[6-11 Standard Operation Data (Reference Data) ]

Packaged unit model				PUHY-P1000YSKB-A1			
Outdoor unit model				PUHY-P300YKB-A1	PUHY-P300YKB-A1	PUHY-P400YKB-A1	
Conditions	Ambient temperature (cooling)	Indoor	DB/WB	26.7°C/19.4°C [80°F/67°F]			
		Outdoor		35°C/- [95°F/-]			
	Ambient temperature (heating)	Indoor	DB/WB	21.1°C/- [70°F/-]			
		Outdoor		8.3°C/6.1°C [47°F/43°F]			
	Indoor unit	Number of units connected	Unit	10			
		Number of units in operation		10			
		Model	-	100/100/100/100/100/100/100/100/100/100			
	Piping	Main pipe	m [ft]	5 [16-3/8]			
		Branch pipe		10 [32-3/4]			
		Total pipe length		105 [344-7/16]			
Fan speed			-	Hi			
Refrigerant charge			kg [lbs-oz]	52 [115]			
Outdoor unit	Voltage			V	400		
<b>Cooling operation</b>							
Outdoor unit	Electric current			A	59.2		
	Compressor frequency			Hz	74	74	97
LEV opening	Indoor unit			Pulse	325/325/325/325/325/325/325/325/325/325		
	SC (LEV1)				100	100	100
	LEV2				2100	2100	2100
Pressure	High pressure (after O/S)/Low pressure (before accumulator)			MPa [psi]	2.92/0.90 [424/131]	2.92/0.90 [424/131]	3.18/0.84 [461/122]
Section temperatures	Outdoor unit	Discharge (TH4)	°C [°F]	73 [163]	73 [163]	84 [183]	
		Heat exchanger outlet (TH3)		40 [104]	40 [104]	45 [113]	
		Accumulator inlet		10 [50]	10 [50]	7 [45]	
		Accumulator outlet		10 [50]	10 [50]	7 [45]	
		SCC outlet (TH6)		20 [68]	20 [68]	25 [77]	
		Compressor inlet		15 [59]	15 [59]	19 [66]	
		Compressor shell bottom		42 [108]	42 [108]	38 [100]	
	Indoor unit	LEV inlet		19 [66]	19 [66]	17 [63]	
		Heat exchanger outlet		10 [50]	10 [50]	10 [50]	
<b>Heating operation</b>							
Outdoor unit	Electric current			A	61.1		
	Compressor frequency			Hz	81	81	108
LEV opening	Indoor unit			Pulse	332/332/332/332/332/332/332/332/332/332		
	SC (LEV1)				0		
	LEV2				2100	2100	2100
Pressure	High pressure (after O/S)/Low pressure (before accumulator)			MPa [psi]	2.70/0.65 [392/94]	2.70/0.65 [392/94]	2.78/0.61 [403/88]
Section temperatures	Outdoor unit	Discharge (TH4)	°C [°F]	70 [158]	70 [158]	90 [194]	
		Heat exchanger outlet (TH3)		-1 [30]	-1 [30]	-3 [27]	
		Accumulator inlet		-1 [30]	-1 [30]	-3 [27]	
		Accumulator outlet		-1 [30]	-1 [30]	-3 [27]	
		Compressor inlet		-1 [30]	-1 [30]	-3 [27]	
		Compressor shell bottom		40 [104]	40 [104]	40 [104]	
	Indoor unit	LEV inlet		36 [97]	36 [97]	37 [99]	
		Heat exchanger inlet		69 [156]	69 [156]	80 [176]	

[6-11 Standard Operation Data (Reference Data) ]

Packaged unit model				PUHY-P1050YSKB-A1		
Outdoor unit model				PUHY-P300YKB-A1	PUHY-P350YKB-A1	PUHY-P400YKB-A1
Conditions	Ambient temperature (cooling)	Indoor	DB/WB	26.7°C/19.4°C [80°F/67°F]		
		Outdoor		35°C/- [95°F/-]		
	Ambient temperature (heating)	Indoor	DB/WB	21.1°C/- [70°F/-]		
		Outdoor		8.3°C/6.1°C [47°F/43°F]		
	Indoor unit	Number of units connected	Unit	10		
		Number of units in operation		10		
		Model	-	100/100/100/100/100/100/100/100/125/125		
	Piping	Main pipe	m [ft]	5 [16-3/8]		
		Branch pipe		10 [32-3/4]		
		Total pipe length		105 [344-7/16]		
Fan speed			-	Hi		
Refrigerant charge			kg [lbs-oz]	52 [115]		
Outdoor unit	Voltage			V	400	
<b>Cooling operation</b>						
Outdoor unit	Electric current	A		63.3		
	Compressor frequency	Hz		74	95	97
LEV opening	Indoor unit	Pulse	325/325/325/325/325/325/325/325/325/325			
	SC (LEV1)		100	190	100	
	LEV2		2100	2100	2100	
Pressure	High pressure (after O/S)/Low pressure (before accumulator)	MPa [psi]	2.92/0.90 [424/131]	3.05/0.84 [442/122]	3.18/0.84 [461/122]	
Section temperatures	Outdoor unit	Discharge (TH4)	73 [163]	82 [180]	84 [183]	
		Heat exchanger outlet (TH3)	40 [104]	45 [113]	45 [113]	
		Accumulator inlet	10 [50]	7 [45]	7 [45]	
		Accumulator outlet	10 [50]	7 [45]	7 [45]	
		SCC outlet (TH6)	20 [68]	25 [77]	25 [77]	
		Compressor inlet	15 [59]	19 [66]	19 [66]	
		Compressor shell bottom	42 [108]	38 [100]	38 [100]	
	Indoor unit	LEV inlet	19 [66]	17 [63]	17 [63]	
		Heat exchanger outlet	10 [50]	10 [50]	10 [50]	
<b>Heating operation</b>						
Outdoor unit	Electric current	A		67.0		
	Compressor frequency	Hz		81	102	108
LEV opening	Indoor unit	Pulse	332/332/332/332/332/332/332/332/332/332			
	SC (LEV1)		0			
	LEV2		2100	2100	2100	
Pressure	High pressure (after O/S)/Low pressure (before accumulator)	MPa [psi]	2.70/0.65 [392/94]	2.74/0.61 [397/88]	2.78/0.61 [403/88]	
Section temperatures	Outdoor unit	Discharge (TH4)	70 [158]	89 [192]	90 [194]	
		Heat exchanger outlet (TH3)	-1 [30]	-3 [27]	-3 [27]	
		Accumulator inlet	-1 [30]	-3 [27]	-3 [27]	
		Accumulator outlet	-1 [30]	-3 [27]	-3 [27]	
		Compressor inlet	-1 [30]	-3 [27]	-3 [27]	
		Compressor shell bottom	40 [104]	40 [104]	40 [104]	
	Indoor unit	LEV inlet	36 [97]	37 [99]	37 [99]	
		Heat exchanger inlet	69 [156]	80 [176]	80 [176]	

6 Test Run

[6-11 Standard Operation Data (Reference Data) ]

Packaged unit model				PUHY-P1100YSKB-A1			
Outdoor unit model				PUHY-P350YKB-A1	PUHY-P350YKB-A1	PUHY-P400YKB-A1	
Conditions	Ambient temperature (cooling)	Indoor	DB/WB	26.7°C/19.4°C [80°F/67°F]			
		Outdoor		35°C/- [95°F/-]			
	Ambient temperature (heating)	Indoor	DB/WB	21.1°C/- [70°F/-]			
		Outdoor		8.3°C/6.1°C [47°F/43°F]			
	Indoor unit	Number of units connected	Unit	10			
		Number of units in operation		10			
		Model	-	100/100/100/100/100/100/125/125/125/125			
	Piping	Main pipe	m [ft]	5 [16-3/8]			
		Branch pipe		10 [32-3/4]			
		Total pipe length		105 [344-7/16]			
Fan speed			-	Hi			
Refrigerant charge			kg [lbs-oz]	54 [120]			
Outdoor unit	Voltage			V	400		
<b>Cooling operation</b>							
Outdoor unit	Electric current			A	67.3		
	Compressor frequency			Hz	95	95	97
LEV opening	Indoor unit			Pulse	325/325/325/325/325/325/325/325/325/325		
	SC (LEV1)				190	190	100
	LEV2				2100	2100	2100
Pressure	High pressure (after O/S)/Low pressure (before accumulator)			MPa [psi]	3.05/0.84 [442/122]	3.05/0.84 [442/122]	3.18/0.84 [461/122]
Section temperatures	Outdoor unit	Discharge (TH4)	°C [°F]	82 [180]	82 [180]	84 [183]	
		Heat exchanger outlet (TH3)		45 [113]	45 [113]	45 [113]	
		Accumulator inlet		7 [45]	7 [45]	7 [45]	
		Accumulator outlet		7 [45]	7 [45]	7 [45]	
		SCC outlet (TH6)		25 [77]	25 [77]	25 [77]	
		Compressor inlet		19 [66]	19 [66]	19 [66]	
		Compressor shell bottom		38 [100]	38 [100]	38 [100]	
	Indoor unit	LEV inlet	17 [63]	17 [63]	17 [63]		
		Heat exchanger outlet	10 [50]	10 [50]	10 [50]		
	<b>Heating operation</b>						
Outdoor unit	Electric current			A	72.9		
	Compressor frequency			Hz	102	102	108
LEV opening	Indoor unit			Pulse	332/332/332/332/332/332/332/332/332/332		
	SC (LEV1)				0		
	LEV2				2100	2100	2100
Pressure	High pressure (after O/S)/Low pressure (before accumulator)			MPa [psi]	2.74/0.61 [397/88]	2.74/0.61 [397/88]	2.78/0.61 [403/88]
Section temperatures	Outdoor unit	Discharge (TH4)	°C [°F]	89 [192]	89 [192]	90 [194]	
		Heat exchanger outlet (TH3)		-3 [27]	-3 [27]	-3 [27]	
		Accumulator inlet		-3 [27]	-3 [27]	-3 [27]	
		Accumulator outlet		-3 [27]	-3 [27]	-3 [27]	
		Compressor inlet		-3 [27]	-3 [27]	-3 [27]	
		Compressor shell bottom		40 [104]	40 [104]	40 [104]	
	Indoor unit	LEV inlet	37 [99]	37 [99]	37 [99]		
		Heat exchanger inlet	80 [176]	80 [176]	80 [176]		

[6-11 Standard Operation Data (Reference Data) ]

Packaged unit model				PUHY-P1150YSKB-A1		
Outdoor unit model				PUHY-P350YKB-A1	PUHY-P350YKB-A1	PUHY-P450YKB-A1
Conditions	Ambient temperature (cooling)	Indoor	DB/WB	26.7°C/19.4°C [80°F/67°F]		
		Outdoor		35°C/- [95°F/-]		
	Ambient temperature (heating)	Indoor	DB/WB	21.1°C/- [70°F/-]		
		Outdoor		8.3°C/6.1°C [47°F/43°F]		
	Indoor unit	Number of units connected	Unit	10		
		Number of units in operation		10		
		Model	-	100/100/100/100/125/125/125/125/125/125		
	Piping	Main pipe	m [ft]	5 [16-3/8]		
		Branch pipe		10 [32-3/4]		
		Total pipe length		105 [344-7/16]		
Fan speed			-	Hi		
Refrigerant charge			kg [lbs-oz]	55 [122]		
Outdoor unit	Voltage	V		400		
<b>Cooling operation</b>						
Outdoor unit	Electric current	A		70.5		
	Compressor frequency	Hz		95	95	111
LEV opening	Indoor unit	Pulse	325/325/325/325/325/325/325/325/325/325			
	SC (LEV1)		190	190	190	
	LEV2		2100	2100	2100	
Pressure	High pressure (after O/S)/Low pressure (before accumulator)	MPa [psi]		3.05/0.84 [442/122]	3.05/0.84 [442/122]	3.31/0.84 [480/122]
Section temperatures	Outdoor unit	Discharge (TH4)	°C [°F]	82 [180]	82 [180]	86 [187]
		Heat exchanger outlet (TH3)		45 [113]	45 [113]	45 [113]
		Accumulator inlet		7 [45]	7 [45]	7 [45]
		Accumulator outlet		7 [45]	7 [45]	7 [45]
		SCC outlet (TH6)		25 [77]	25 [77]	25 [77]
		Compressor inlet		19 [66]	19 [66]	19 [66]
		Compressor shell bottom		38 [100]	38 [100]	38 [100]
	Indoor unit	LEV inlet		17 [63]	17 [63]	17 [63]
		Heat exchanger outlet		10 [50]	10 [50]	10 [50]
<b>Heating operation</b>						
Outdoor unit	Electric current	A		76.6		
	Compressor frequency	Hz		102	102	120
LEV opening	Indoor unit	Pulse	332/332/332/332/332/332/332/332/332/332			
	SC (LEV1)		0			
	LEV2		2100	2100	2100	
Pressure	High pressure (after O/S)/Low pressure (before accumulator)	MPa [psi]		2.74/0.61 [397/88]	2.74/0.61 [397/88]	2.82/0.61 [409/88]
Section temperatures	Outdoor unit	Discharge (TH4)	°C [°F]	89 [192]	89 [192]	90 [194]
		Heat exchanger outlet (TH3)		-3 [27]	-3 [27]	-3 [27]
		Accumulator inlet		-3 [27]	-3 [27]	-3 [27]
		Accumulator outlet		-3 [27]	-3 [27]	-3 [27]
		Compressor inlet		-3 [27]	-3 [27]	-3 [27]
		Compressor shell bottom		40 [104]	40 [104]	40 [104]
	Indoor unit	LEV inlet		37 [99]	37 [99]	37 [99]
		Heat exchanger inlet		80 [176]	80 [176]	80 [176]

6 Test Run

[6-11 Standard Operation Data (Reference Data) ]

Packaged unit model				PUHY-P1200YSKB-A1			
Outdoor unit model				PUHY-P350YKB-A1	PUHY-P400YKB-A1	PUHY-P450YKB-A1	
Conditions	Ambient temperature (cooling)	Indoor	DB/WB	26.7°C/19.4°C [80°F/67°F]			
		Outdoor		35°C/- [95°F/-]			
	Ambient temperature (heating)	Indoor	DB/WB	21.1°C/- [70°F/-]			
		Outdoor		8.3°C/6.1- [47°F/43°F]			
	Indoor unit	Number of units connected		Unit	11		
		Number of units in operation			11		
		Model			100/100/100/100/100/100/100/100/125/125/125/125		
	Piping	Main pipe	m [ft]	5 [16-3/8]			
		Branch pipe		10 [32-3/4]			
		Total pipe length		115 [377-1/4]			
Fan speed			-	Hi			
Refrigerant charge			kg [lbs-oz]	55 [122]			
Outdoor unit	Voltage		V	400			
<b>Cooling operation</b>							
Outdoor unit	Electric current		A	75.5			
	Compressor frequency		Hz	95	97	111	
LEV opening	Indoor unit		Pulse	325/325/325/325/325/325/325/325/325/325/325			
	SC (LEV1)			190	100	190	
	LEV2			2100	2100	2100	
Pressure	High pressure (after O/S)/Low pressure (before accumulator)		MPa [psi]	3.05/0.84 [442/122]	3.18/0.84 [461/122]	3.31/0.84 [480/122]	
Section temperatures	Outdoor unit	Discharge (TH4)	°C [°F]	82 [180]	84 [183]	86 [187]	
		Heat exchanger outlet (TH3)		45 [113]	45 [113]	45 [113]	
		Accumulator inlet		7 [45]	7 [45]	7 [45]	
		Accumulator outlet		7 [45]	7 [45]	7 [45]	
		SCC outlet (TH6)		25 [77]	25 [77]	25 [77]	
		Compressor inlet		19 [66]	19 [66]	19 [66]	
		Compressor shell bottom		38 [100]	38 [100]	38 [100]	
	Indoor unit	LEV inlet		17 [63]	17 [63]	17 [63]	
		Heat exchanger outlet		10 [50]	10 [50]	10 [50]	
<b>Heating operation</b>							
Outdoor unit	Electric current		A	79.5			
	Compressor frequency		Hz	102	108	120	
LEV opening	Indoor unit		Pulse	332/332/332/332/332/332/332/332/332/332/332			
	SC (LEV1)			0			
	LEV2			2100	2100	2100	
Pressure	High pressure (after O/S)/Low pressure (before accumulator)		MPa [psi]	2.74/0.61 [397/88]	2.78/0.61 [403/88]	2.82/0.61 [409/88]	
Section temperatures	Outdoor unit	Discharge (TH4)	°C [°F]	89 [192]	90 [194]	90 [194]	
		Heat exchanger outlet (TH3)		-3 [27]	-3 [27]	-3 [27]	
		Accumulator inlet		-3 [27]	-3 [27]	-3 [27]	
		Accumulator outlet		-3 [27]	-3 [27]	-3 [27]	
		Compressor inlet		-3 [27]	-3 [27]	-3 [27]	
		Compressor shell bottom		40 [104]	40 [104]	40 [104]	
	Indoor unit	LEV inlet		37 [99]	37 [99]	37 [99]	
		Heat exchanger inlet		80 [176]	80 [176]	80 [176]	

[6-11 Standard Operation Data (Reference Data) ]

Packaged unit model				PUHY-P1250YSKB-A1			
Outdoor unit model				PUHY-P350YKB-A1	PUHY-P450YKB-A1	PUHY-P450YKB-A1	
Conditions	Ambient temperature (cooling)	Indoor	DB/WB	26.7°C/19.4°C [80°F/67°F]			
		Outdoor		35°C/- [95°F/-]			
	Ambient temperature (heating)	Indoor	DB/WB	21.1°C/- [70°F/-]			
		Outdoor		8.3°C/6.1°C [47°F/43°F]			
	Indoor unit	Number of units connected	Unit	11			
		Number of units in operation		11			
		Model	-	100/100/100/100/100/125/125/125/125/125/125			
	Piping	Main pipe	m [ft]	5 [16-3/8]			
		Branch pipe		10 [32-3/4]			
		Total pipe length		115 [377-1/4]			
Fan speed			-	Hi			
Refrigerant charge			kg [lbs-oz]	56 [124]			
Outdoor unit	Voltage			V	400		
<b>Cooling operation</b>							
Outdoor unit	Electric current			A	78.7		
	Compressor frequency			Hz	95	111	111
LEV opening	Indoor unit			Pulse	325/325/325/325/325/325/325/325/325/325/325		
	SC (LEV1)				190	190	190
	LEV2				2100	2100	2100
Pressure	High pressure (after O/S)/Low pressure (before accumulator)			MPa [psi]	3.05/0.84 [442/122]	3.31/0.84 [480/122]	3.31/0.84 [480/122]
Section temperatures	Outdoor unit	Discharge (TH4)	°C [°F]	82 [180]	86 [187]	86 [187]	
		Heat exchanger outlet (TH3)		45 [113]	45 [113]	45 [113]	
		Accumulator inlet		7 [45]	7 [45]	7 [45]	
		Accumulator outlet		7 [45]	7 [45]	7 [45]	
		SCC outlet (TH6)		25 [77]	25 [77]	25 [77]	
		Compressor inlet		19 [66]	19 [66]	19 [66]	
		Compressor shell bottom		38 [100]	38 [100]	38 [100]	
	Indoor unit	LEV inlet		17 [63]	17 [63]	17 [63]	
		Heat exchanger outlet		10 [50]	10 [50]	10 [50]	
<b>Heating operation</b>							
Outdoor unit	Electric current			A	83.2		
	Compressor frequency			Hz	102	120	120
LEV opening	Indoor unit			Pulse	332/332/332/332/332/332/332/332/332/332/332		
	SC (LEV1)				0		
	LEV2				2100	2100	2100
Pressure	High pressure (after O/S)/Low pressure (before accumulator)			MPa [psi]	2.74/0.61 [397/88]	2.82/0.61 [409/88]	2.82/0.61 [409/88]
Section temperatures	Outdoor unit	Discharge (TH4)	°C [°F]	89 [192]	90 [194]	90 [194]	
		Heat exchanger outlet (TH3)		-3 [27]	-3 [27]	-3 [27]	
		Accumulator inlet		-3 [27]	-3 [27]	-3 [27]	
		Accumulator outlet		-3 [27]	-3 [27]	-3 [27]	
		Compressor inlet		-3 [27]	-3 [27]	-3 [27]	
		Compressor shell bottom		40 [104]	40 [104]	40 [104]	
	Indoor unit	LEV inlet		37 [99]	37 [99]	37 [99]	
		Heat exchanger inlet		80 [176]	80 [176]	80 [176]	

6 Test Run



[6-11 Standard Operation Data (Reference Data) ]

Packaged unit model				PUHY-P1300YSKB-A1			
Outdoor unit model				PUHY-P400YKB-A1	PUHY-P450YKB-A1	PUHY-P450YKB-A1	
Conditions	Ambient temperature (cooling)	Indoor	DB/WB	26.7°C/19.4°C [80°F/67°F]			
		Outdoor		35°C/- [95°F/-]			
	Ambient temperature (heating)	Indoor	DB/WB	21.1°C/- [70°F/-]			
		Outdoor		8.3°C/6.1°C [47°F/43°F]			
	Indoor unit	Number of units connected		Unit	12		
		Number of units in operation			12		
		Model		-	100/100/100/100/100/100/100/100/125/125/125/125		
	Piping	Main pipe	m [ft]	5 [16-3/8]			
		Branch pipe		10 [32-3/4]			
		Total pipe length		125 [410-1/16]			
Fan speed			-	Hi			
Refrigerant charge			kg [lbs-oz]	58 [128]			
Outdoor unit	Voltage		V	400			
<b>Cooling operation</b>							
Outdoor unit	Electric current		A	83.6			
	Compressor frequency		Hz	97	111	111	
LEV opening	Indoor unit		Pulse	325/325/325/325/325/325/325/325/325/325/325			
	SC (LEV1)			100	190	190	
	LEV2			2100	2100	2100	
Pressure	High pressure (after O/S)/Low pressure (before accumulator)		MPa [psi]	3.18/0.84 [461/122]	3.31/0.84 [480/122]	3.31/0.84 [480/122]	
Section temperatures	Outdoor unit	Discharge (TH4)	°C [°F]	84 [183]	86 [187]	86 [187]	
		Heat exchanger outlet (TH3)		45 [113]	45 [113]	45 [113]	
		Accumulator inlet		7 [45]	7 [45]	7 [45]	
		Accumulator outlet		7 [45]	7 [45]	7 [45]	
		SCC outlet (TH6)		25 [77]	25 [77]	25 [77]	
		Compressor inlet		19 [66]	19 [66]	19 [66]	
		Compressor shell bottom		38 [100]	38 [100]	38 [100]	
	Indoor unit	LEV inlet		17 [63]	17 [63]	17 [63]	
		Heat exchanger outlet		10 [50]	10 [50]	10 [50]	
<b>Heating operation</b>							
Outdoor unit	Electric current		A	86.1			
	Compressor frequency		Hz	108	120	120	
LEV opening	Indoor unit		Pulse	332/332/332/332/332/332/332/332/332/332/332			
	SC (LEV1)			0			
	LEV2			2100	2100	2100	
Pressure	High pressure (after O/S)/Low pressure (before accumulator)		MPa [psi]	2.78/0.61 [403/88]	2.82/0.61 [409/88]	2.82/0.61 [409/88]	
Section temperatures	Outdoor unit	Discharge (TH4)	°C [°F]	90 [194]	90 [194]	90 [194]	
		Heat exchanger outlet (TH3)		-3 [27]	-3 [27]	-3 [27]	
		Accumulator inlet		-3 [27]	-3 [27]	-3 [27]	
		Accumulator outlet		-3 [27]	-3 [27]	-3 [27]	
		Compressor inlet		-3 [27]	-3 [27]	-3 [27]	
		Compressor shell bottom		40 [104]	40 [104]	40 [104]	
	Indoor unit	LEV inlet		37 [99]	37 [99]	37 [99]	
		Heat exchanger inlet		80 [176]	80 [176]	80 [176]	

[6-11 Standard Operation Data (Reference Data) ]

Packaged unit model				PUHY-P1350YSKB-A1			
Outdoor unit model				PUHY-P450YKB-A1	PUHY-P450YKB-A1	PUHY-P450YKB-A1	
Conditions	Ambient temperature (cooling)	Indoor	DB/WB	26.7°C/19.4°C [80°F/67°F]			
		Outdoor		35°C/- [95°F/-]			
	Ambient temperature (heating)	Indoor	DB/WB	21.1°C/- [70°F/-]			
		Outdoor		8.3°C/6.1°C [47°F/43°F]			
	Indoor unit	Number of units connected		Unit	12		
		Number of units in operation			12		
		Model			100/100/100/100/100/100/125/125/125/125/125/125		
	Piping	Main pipe	m [ft]	5 [16-3/8]			
		Branch pipe		10 [32-3/4]			
		Total pipe length		125 [410-1/16]			
Fan speed			-	Hi			
Refrigerant charge			kg [lbs-oz]	59 [131]			
Outdoor unit	Voltage		V	400			
<b>Cooling operation</b>							
Outdoor unit	Electric current		A	86.8			
	Compressor frequency		Hz	111	111	111	
LEV opening	Indoor unit		Pulse	325/325/325/325/325/325/325/325/325/325/325/325			
	SC (LEV1)			190	190	190	
	LEV2			2100	2100	2100	
Pressure	High pressure (after O/S)/Low pressure (before accumulator)		MPa [psi]	3.31/0.84 [480/122]	3.31/0.84 [480/122]	3.31/0.84 [480/122]	
Section temperatures	Outdoor unit	Discharge (TH4)	°C [°F]	86 [187]	86 [187]	86 [187]	
		Heat exchanger outlet (TH3)		45 [113]	45 [113]	45 [113]	
		Accumulator inlet		7 [45]	7 [45]	7 [45]	
		Accumulator outlet		7 [45]	7 [45]	7 [45]	
		SCC outlet (TH6)		25 [77]	25 [77]	25 [77]	
		Compressor inlet		19 [66]	19 [66]	19 [66]	
		Compressor shell bottom		38 [100]	38 [100]	38 [100]	
	Indoor unit	LEV inlet		17 [63]	17 [63]	17 [63]	
		Heat exchanger outlet		10 [50]	10 [50]	10 [50]	
<b>Heating operation</b>							
Outdoor unit	Electric current		A	89.8			
	Compressor frequency		Hz	120	120	120	
LEV opening	Indoor unit		Pulse	332/332/332/332/332/332/332/332/332/332/332/332			
	SC (LEV1)			0			
	LEV2			2100	2100	2100	
Pressure	High pressure (after O/S)/Low pressure (before accumulator)		MPa [psi]	2.82/0.61 [409/88]	2.82/0.61 [409/88]	2.82/0.61 [409/88]	
Section temperatures	Outdoor unit	Discharge (TH4)	°C [°F]	90 [194]	90 [194]	90 [194]	
		Heat exchanger outlet (TH3)		-3 [27]	-3 [27]	-3 [27]	
		Accumulator inlet		-3 [27]	-3 [27]	-3 [27]	
		Accumulator outlet		-3 [27]	-3 [27]	-3 [27]	
		Compressor inlet		-3 [27]	-3 [27]	-3 [27]	
		Compressor shell bottom		40 [104]	40 [104]	40 [104]	
	Indoor unit	LEV inlet		37 [99]	37 [99]	37 [99]	
		Heat exchanger inlet		80 [176]	80 [176]	80 [176]	

6 Test Run



---

## Chapter 7 Troubleshooting Using Error Codes

<b>7-1</b>	<b>Error Code and Preliminary Error Code Lists</b> .....	<b>165</b>
<b>7-2</b>	<b>Error Code Definitions and Solutions: Codes [0 - 999]</b> .....	<b>169</b>
7-2-1	Error Code [0403] .....	169
7-2-2	Error Code [0404] .....	170
<b>7-3</b>	<b>Error Code Definitions and Solutions: Codes [1000 - 1999]</b> .....	<b>171</b>
7-3-1	Error Code [1102] .....	171
7-3-2	Error Code [1301] .....	172
7-3-3	Error Code [1302] (during operation) .....	173
7-3-4	Error Code [1302] (at startup) .....	174
7-3-5	Error Code [1500] .....	174
<b>7-4</b>	<b>Error Code Definitions and Solutions: Codes [2000 - 2999]</b> .....	<b>175</b>
7-4-1	Error Code [2500] (Models with a drain sensor) .....	175
7-4-2	Error Code [2500] (Models with a float switch) .....	176
7-4-3	Error Code [2502] (Models with a drain sensor) .....	177
7-4-4	Error Code [2502] (Models with a float switch) .....	178
7-4-5	Error Code [2503] .....	179
7-4-6	Error Code [2600] .....	180
7-4-7	Error Code [2601] .....	180
<b>7-5</b>	<b>Error Code Definitions and Solutions: Codes [3000 - 3999]</b> .....	<b>181</b>
7-5-1	Error Code [3121] .....	181
<b>7-6</b>	<b>Error Code Definitions and Solutions: Codes [4000 - 4999]</b> .....	<b>182</b>
7-6-1	Error Code [4102] .....	182
7-6-2	Error Code [4106] .....	183
7-6-3	Error Code [4109] .....	183
7-6-4	Error Code [4115] .....	184
7-6-5	Error Code [4116] .....	184
7-6-6	Error Code [4121] .....	185
7-6-7	Error Code [4124] .....	186
7-6-8	Error Codes [4220, 4225, 4226] Detail Code 108 .....	187
7-6-9	Error Codes [4220, 4225, 4226] Detail Code 109 .....	188
7-6-10	Error Code [4220] Detail Code 110 .....	189
7-6-11	Error Codes [4220, 4225, 4226] Detail Code 111, 112 .....	189
7-6-12	Error Code [4220] Detail Code 123 .....	190
7-6-13	Error Code [4220] Detail Code 124 .....	190
7-6-14	Error Codes [4220, 4225, 4226] Detail Code 131 .....	191
7-6-15	Error Code [4230] Detail Code 125 .....	191
7-6-16	Error Code [4230] Detail Code 126 .....	192
7-6-17	Error Code [4240] .....	193
7-6-18	Error Codes [4250, 4255, 4256] Detail Code 101 .....	194
7-6-19	Error Codes [4250, 4255, 4256] Detail Code 104 .....	195
7-6-20	Error Codes [4250, 4255, 4256] Detail Code 105 .....	196
7-6-21	Error Code [4250] Detail Codes 106 and 107 .....	196
7-6-22	Error Code [4250] Detail Codes 121, 128, and 122 .....	197
7-6-23	Error Code [4260] .....	197
<b>7-7</b>	<b>Error Code Definitions and Solutions: Codes [5000 - 5999]</b> .....	<b>198</b>
7-7-1	Error Codes [5101, 5102, 5103, 5104] .....	198
7-7-2	Error Codes [5102, 5103, 5104, 5105, 5106, 5107, 5109, 5111] .....	199

7-7-3	Error Code [5110]	200
7-7-4	Error Code [5120]	201
7-7-5	Error Code [5201]	201
7-7-6	Error Code [5301] Detail Code 115	202
7-7-7	Error Code [5301] Detail Code 117	202
7-7-8	Error Code [5301] Detail Code 119	203
7-7-9	Error Code [5301] Detail Code 120	203
7-7-10	Error Code [5301] Detail Code 127	204
7-7-11	Error Codes [5305, 5306] Detail Code 132	204
7-7-12	Error Codes [5305, 5306] Detail Code 133	205
7-7-13	Error Codes [5305, 5306] Detail Code 134	205
7-7-14	Error Code [5701]	205
<b>7-8</b>	<b>Error Code Definitions and Solutions: Codes [6000 - 6999]</b>	<b>206</b>
7-8-1	Error Code [6201]	206
7-8-2	Error Code [6202]	206
7-8-3	Error Code [6600]	207
7-8-4	Error Code [6601]	207
7-8-5	Error Code [6602]	208
7-8-6	Error Code [6603]	209
7-8-7	Error Code [6606]	209
7-8-8	Error Code [6607] Error Source Address = Outdoor Unit (OC)	210
7-8-9	Error Code [6607] Error Source Address = Indoor Unit (IC)	211
7-8-10	Error Code [6607] Error Source Address = LOSSNAY (LC)	212
7-8-11	Error Code [6607] Error Source Address = ME Remote Controller	213
7-8-12	Error Code [6607] Error Source Address = System Controller	214
7-8-13	Error Code [6607] All Error Source Addresses	215
7-8-14	Error Code [6607] No Error Source Address	216
7-8-15	Error Code [6608]	217
7-8-16	Error Code [6831]	218
7-8-17	Error Code [6832]	219
7-8-18	Error Code [6833]	220
7-8-19	Error Code [6834]	221
7-8-20	Error Code [6840]	222
7-8-21	Error Code [6841]	222
7-8-22	Error Code [6842]	223
7-8-23	Error Code [6843]	224
7-8-24	Error Code [6846]	225
<b>7-9</b>	<b>Error Code Definitions and Solutions: Codes [7000 - 7999]</b>	<b>226</b>
7-9-1	Error Code [7100]	226
7-9-2	Error Code [7101]	227
7-9-3	Error Code [7102]	228
7-9-4	Error Code [7105]	229
7-9-5	Error Code [7106]	229
7-9-6	Error Code [7110]	230
7-9-7	Error Code [7111]	230
7-9-8	Error Code [7113]	231
7-9-9	Error Code [7117]	232
7-9-10	Error Code [7130]	233

## 7-1 Error Code and Preliminary Error Code Lists

Error Code	Preliminary error code	Error (preliminary) detail code	Error code definition	Searched unit				Notes
				Outdoor unit	Indoor unit	LOSSNAY	Remote controller	
0403	4300 4305 4306	1 5 6 (Note)	Serial communication error/Panel communication error	O	O			(page 169)
0404	-	-	Indoor unit EEPROM abnormality		O			(page 170)
0900	-	-	Test run			O		
1102	1202	-	Discharge temperature fault	O				(page 171)
1301	-	-	Low pressure fault	O				(page 172)
1302	1402	-	High pressure fault	O				(page 173)
1500	1600	-	Refrigerant overcharge	O				(page 174)
-	1605	-	Preliminary suction pressure fault	O				
2500	-	-	Drain sensor submergence		O			(page 175)
2502	-	-	Drain pump fault		O			(page 177)
2503	-	-	Drain sensor (Thd) fault		O	O		(page 179)
2600	-	-	Water leakage			O		(page 180)
2601	-	-	Water supply cutoff			O		(page 180)
3121	-	-	Out-of-range outside air temperature	O				(page 181)
4102	4152	-	Open phase	O				(page 182)
4106	-	-	Transmission power supply fault	O				(page 183)
4109	-	-	Fan operation status detection error		O			(page 183)
4115	-	-	Power supply signal sync error	O				(page 184)
4116	-	-	RPM error/Motor error		O	O		(page 184)
4121	4171	-	Function setting error	O				(page 185)
4124	-	-	Electric system not operate due to damper abnormality		O			(page 186)
4220 4225 4226 (Note)	4320 4325 4326 (Note)	[0]	Backup operation	O				
		[108]	Abnormal bus voltage drop (Software detection)	O				(page 187)
		[109]	Abnormal bus voltage rise (Software detection)	O				(page 188)
		[110]	BUS voltage error (Hardware detection)	O				(page 189)
		[111]	Logic error	O				(page 189)
		[112]	Logic error	O				(page 189)
		[123]	Voltage boost control error	O				(page 190)
		[124]	BUS circuit fault	O				(page 190)
4230	4330	[131]	Low bus voltage at startup	O				(page 191)
		[125]	Heatsink overheat protection	O				(page 191)
		[126]	DCL temperature fault	O				(page 192)
4240	4340	-	Overload protection	O				(page 193)

[7-1 Error Code and Preliminary Error Code Lists ]

Error Code	Preliminary error code	Error (preliminary) detail code	Error code definition		Searched unit				Notes
					Outdoor unit	Indoor unit	LOSSNAY	Remote controller	
4250 4255 4256 (Note)	4350 4355 4356 (Note)	[0]	Backup operation		O				
		[101]	IPM error		O				(page 194)
		[104]	Short-circuited IPM/Ground fault		O				(page 195)
		[105]	Overcurrent error due to short-circuited motor		O				(page 196)
		[106]	Instantaneous overcurrent (S/W detection)		O				(page 196)
		[107]	Overcurrent (effective value)(S/W detection)		O				(page 196)
		[121]	DCL overcurrent breaker error (hardware detection)		O				(page 197)
		[122]	DCL overcurrent breaker error (software detection)		O				(page 197)
		[128]	DCL overcurrent breaker error (hardware detection)		O			(page 197)	
4260	-	-	Heatsink overheat protection at startup		O				(page 197)
5101	1202	-	Temperature sensor fault	Return air temperature (TH21)		O			(page 198)
				OA processing unit inlet temperature (TH4)			O		(page 198)
5102	1217	-	Temperature sensor fault	Indoor unit pipe temperature (TH22)		O			(page 198)
				OA processing unit pipe temperature (TH2)			O		(page 198)
				HIC bypass circuit outlet temperature (TH2)	O				(page 199)
5103	1205	00	Temperature sensor fault	Indoor unit gas-side pipe temperature (TH23)		O			(page 198)
				OA processing unit gas-side pipe temperature (TH3)			O		(page 198)
				Pipe temperature at heatexchanger outlet (TH3)	O				(page 199)
5104	1202	-	Temperature sensor fault	OA processing unit intake air temperature (TH1)			O		(page 198)
				Outside temperature (TH24)		O			(page 198) Detectable only by the All-Fresh type indoor units
				Outdoor unit discharge temperature (TH4)	O				(page 199)
5105	1204	-	Temperature sensor fault	Accumulator inlet temperature (TH5)	O				(page 199)
5106	1216	-	Temperature sensor fault	HIC circuit outlet temperature (TH6)	O				(page 199)
5107	1221	-	Temperature sensor fault	Outside temperature (TH7)	O				(page 199)
5109	1273	-	Temperature sensor fault	Heat exchanger outlet pipe temperature (TH9)	O				(page 199)
5110	1214	[0]	Backup operation		O				
		01	Temperature sensor fault	Heatsink temperature (THHS)	O				(page 200)

Error Code	Preliminary error code	Error (preliminary) detail code	Error code definition		Searched unit				Notes
					Outdoor unit	Indoor unit	LOSSNAY	Remote controller	
5111	1274	-	Temperature sensor fault	Heat exchanger outlet pipe temperature (TH11)	O				(page 199)
5120	1248	[0]	Backup operation		O				
		01	Temperature sensor fault	DCL(THL)	O				
5201	-	-	High-pressure sensor fault (63HS1)		O				(page 201)
5301	4300	[0]	Backup operation		O				
		[115]	ACCT sensor fault		O				(page 202)
		[117]	ACCT sensor circuit fault		O				(page 202)
		[119]	Open-circuited IPM/Loose ACCT connector		O				(page 203)
		[120]	Faulty ACCT wiring		O				(page 203)
		[127]	DCL electric current circuit error		O				(page 204)
5305 5306	4305 4306	[0]	Backup operation		O				
		[132]	Position detection error at startup		O				(page 204)
		[133]	Position detection error during operation		O				(page 205)
		[134]	RPM error before startup		O				(page 205)
5701	-	-	Loose float switch connector			O			(page 205)
6201	-	-	Remote controller board fault (nonvolatile memory error)					O	(page 206)
6202	-	-	Remote controller board fault (clock IC error)					O	(page 206)
6600	-	-	Address overlap		O	O	O	O	(page 207)
6601	-	-	Polarity setting error					O	(page 207)
6602	-	-	Transmission processor hardware error		O	O	O	O	(page 208)
6603	-	-	Transmission line bus busy error		O	O	O	O	(page 209)
6606	-	-	Communication error between device and transmission processors		O	O	O	O	(page 209)
6607	-	-	No ACK error		O	O	O	O	(page 210)
6608	-	-	No response error		O	O	O	O	(page 217)
6831	-	-	MA controller signal reception error (No signal reception)			O		O	(page 218)
6832	-	-	MA remote controller signal transmission error (Synchronization error)			O		O	(page 219)
6833	-	-	MA remote controller signal transmission error (Hardware error)			O		O	(page 220)
6834	-	-	MA controller signal reception error (Start bit detection error)			O		O	(page 221)
6840	-	-	A control communication reception error			O			(page 222)
6841	-	-	A control communication synchronism not recover			O			(page 222)
6842	-	-	A control communication transmission/reception hardware trouble			O			(page 223)
6843	-	-	A control communication start bit detection error			O			(page 224)
6846	-	-	Start-up time over			O			(page 225)
7100	-	-	Total capacity error		O				(page 226)



[7-1 Error Code and Preliminary Error Code Lists ]

Error Code	Preliminary error code	Error (preliminary) detail code	Error code definition	Searched unit				Notes
				Outdoor unit	Indoor unit	LOSSNAY	Remote controller	
7101	-	-	Capacity code setting error	O	O	O		(page 227)
7102	-	-	Wrong number of connected units	O				(page 228)
7105	-	-	Address setting error	O				(page 229)
7106	-	-	Attribute setting error			O		(page 229)
7110	-	-	Connection information signal transmission/reception error	O				(page 230)
7111	-	-	Remote controller sensor fault		O	O		(page 230)
7113	-	-	Function setting error (improper connection of CNTYP)	O				(page 231)
7117	-	-	Model setting error	O				(page 232)
7130	-	-	Incompatible unit combination	O				(page 233)

**Note**

The last digit in the check error codes in the 4000's and 5000's and two-digit detail codes indicate if the codes apply to compressor inverter on fan inverter.

Example

Code 4225 (detail code 108): Bus voltage drop in the fan inverter system

Code 4230 : Heatsink overheat protection in the compressor inverter system

The last digit	Inverter system
0 or 1	Compressor inverter system
5 or 6	Fan inverter system

INV board	Series name	Outdoor units	Overload protection I <sub>max</sub> (Arms)	Current effective value error (Arms)	Current peak value error (A <sub>peak</sub> )	Temperature protection TOL (°C)
INV20Y	Standard	PUHY-P200YKB-A1	15	23	38	100
		PUHY-P250YKB-A1	15	23	38	100
		PUHY-P300YKB-A1	27	33	56	100
		PUHY-P350YKB-A1	27	33	56	100
		PUHY-P400YKB-A1	27	33	56	100
INV30YC		PUHY-P450YKB-A1	22	26	44	89
		PUHY-P500YKB-A1	22	26	44	89

## 7-2 Error Code Definitions and Solutions: Codes [0 - 999]

### 7-2-1 Error Code [0403]

**1. Error code definition**

**Serial communication error**

**2. Error definition and error detection method**

Serial communication error between the control board and the INV board on the compressor, and between the control board and the Fan board

Detail code 1: Between the control board and the INV board

Detail code 5, 6: Between the control board and the Fan board

**3. Cause, check method and remedy**

**(1) Faulty wiring**

Check the following wiring connections.

1) Between Control board and Fan board

Control board	FAN board
CN2,CN2A	CN80
CN4,CN4A	CN80

2) Between Fan board and INV board

FAN board	INV board
CN82	CN2
CN83	CN43

**(2) INV board failure, Fan board failure and Control board failure**

Replace the INV board or the Fan board or control board when the power turns on automatically, even if the power source is reset.

**(3) Incorrect setting of the medium pressure sensor kit**

See the medium pressure sensor installation manual for how to reset the setting.

**1. Error code definition**

**Panel communication error (Indoor unit)**

**2. Error definition and detection method**

This error is detected when indoor units cannot successfully receive the signals from the Auto filter cleaning unit for one minute.

**3. Cause, check method and remedy**

Cause	Check method and remedy
(1) Incorrect switch setting on the indoor unit circuit board	Check SW3-3 on the indoor unit circuit board Set SW3-3 to ON only when connecting an auto filter cleaning unit.
(2) Power wire that connects the circuit board on the indoor unit and the circuit board on the cleaning unit is loose.	Check the LED1 (cleaning unit circuit board (microcomputer power)). Lit: Power is supplied properly. Unlit: Check for loose or disconnected power wire between the indoor unit circuit board (CNAC) and the cleaning unit circuit board (CN3A).
(3) Communication wire that connects the circuit board on the indoor unit and the circuit board on the cleaning unit is loose.	Check the LED4 (cleaning unit circuit board (communication)). Blinking: Normal communication Unlit: Check for loose or disconnected communication wire between the indoor unit circuit board (CN3G) and the cleaning unit circuit board (CN3G).
(4) Panel transceiver circuit fault (cleaning unit)	If the LED blinks at irregular intervals (normally blinks at 0.5-second intervals), electrical interference is suspected. Check the items above, turn the power off, and turn the power back on. If the error persists, replace either the cleaning unit circuit board or the indoor unit circuit board.
(5) Panel transceiver circuit fault (indoor unit)	
(6) Electrical interference on the cleaning unit's communication cable	

**Note**

For inverter-related error codes, refer to the following page(s). [8-9 Troubleshooting Inverter Problems](page 264)

## 7-2-2 **Error Code [0404]**

---

### 1. Error code definition

**A control communication reception error**

### 2. Error definition and error detection method

Indoor controller board

Abnormal if data cannot be read normally from the nonvolatile memory of the indoor controller board.

### 3. Cause, check method and remedy

Cause	Check method and remedy
Defective indoor controller board	Replace indoor controller board.

Note: Refer also to the Service Handbook for the indoor units.

## 7-3 Error Code Definitions and Solutions: Codes [1000 - 1999]

### 7-3-1 Error Code [1102]

#### 1. Error code definition

**Discharge temperature fault**

#### 2. Error definition and error detection method

- 1) If the discharge temperature of 120 °C [248°F] or more is detected during the above operation (the first detection), the outdoor unit stops once, turns to anti-restart mode for 3 minutes, and restarts after 3 minutes automatically.
- 2) If the discharge temperature of 120° C [248°F] or more is detected again (the second detection) within 30 minutes after the second stop of the outdoor unit described above, the mode will be changed to 3 - minute restart mode, then the outdoor unit will restart in 3 minutes.
- 3) If the discharge temperature of 120°C [248°F] or more is detected (the 30th detection) within 30 minutes after the stop of the outdoor unit described above (regardless of the first or the 29th stop), the outdoor unit will make an error stop, and the error code "1102" will be displayed.
- 4) If the discharge temperature of 120°C [248°F] or more is detected more than 30 minutes after the previous stop of the outdoor unit, the detection is regarded as the first detection, and the operation described in step 1 above will start.
- 5) For 30 minutes after the stop (the first stop or the second stop) of the outdoor unit, preliminary errors will be displayed on the LED display.

#### 3. Cause, check method and remedy

Cause	Check method and remedy
(1) Gas leak, gas shortage	Refer to the following page(s).[6-9 Evaluating and Adjusting Refrigerant Charge](page 131)
(2) Overload operation	Check operating conditions and operation status of indoor/ outdoor units.
(3) LEV failure on the indoor unit (4) Outdoor unit LEV1 actuation failure Outdoor unit LEV2 actuation failure	Perform a cooling or heating operation to check the operation. Cooling: Indoor unit LEV, LEV1, LEV2 Heating: Indoor unit LEV, LEV2 Refer to the following page(s). [8-8 Troubleshooting LEV Problems](page 258)
(5) Closed refrigerant service valve	Confirm that the refrigerant service valve is fully open.
(6) Outdoor fan (including fan parts) failure, motor failure, or fan controller malfunction Rise in discharge temp. by low pressure drawing for (3) - (6).	Check the fan on the outdoor unit. Refer to the following page(s). [8-7 Troubleshooting Outdoor Unit Fan Problems](page 257)
(7) Gas leak between low and high pressures (4-way valve failure, Compressor failure, Solenoid valve (SV1a) failure)	Perform a cooling or heating operation and check the operation.
(8) Thermistor failure (TH4)	Refer to the following page(s).
(9) Input circuit failure on the controller board thermistor	Check the inlet air temperature on the LED monitor.

## 7-3-2 **Error Code [1301]**

### 1. Error code definition

**Low pressure fault**

### 2. Error definition and error detection method

When starting the compressor from Stop Mode for the first time if low pressure reads 0.098MPa [14psi] immediately before start-up, the operation immediately stops.

### 3. Cause, check method and remedy

Cause	Check method and remedy
(1) Inner pressure drop due to a leakage.	Refer to the following page(s). [8-5-3 Comparing the Low-Pressure Sensor Measurement and Gauge Pressure](page 254)
(2) Low pressure sensor failure	
(3) Short-circuited pressure sensor cable due to torn outer rubber	
(4) A pin on the male connector is missing.	
(5) Disconnected wire	
(6) Failure of the low pressure input circuit on the controller board	

## 7-3-3 Error Code [1302] (during operation)

### 1. Error code definition

**High pressure fault 1 (Outdoor unit)**

### 2. Error definition and error detection method

- 1) If the pressure of 3.78MPa [548psi] or higher is detected by the pressure sensor during operation (the first detection), the outdoor stops once, turns to antirestart mode for 3 minutes, and restarts after 3 minutes automatically.
- 2) If the pressure of 3.78MPa [548psi] or higher is detected by the pressure sensor again (the second detection) within 30 minutes after the first stop of the outdoor unit, the outdoor unit stops once, turns to anti-restart mode for 3 minutes, and restarts after 3 minutes automatically.
- 3) If the pressure of 3.87MPa [561psi] or higher is detected by the pressure sensor (the third detection) within 30 minutes of the second stop of the outdoor unit, the outdoor unit will make an error stop, and the error code "1302" will be displayed.
- 4) If the pressure of 3.78MPa [548psi] or higher is detected more than 30 minutes after the stop of the outdoor unit, the detection is regarded as the first detection, and the operation described in step 1 above will start.
- 5) For 30 minutes after the stop of the outdoor unit, preliminary errors will be displayed on the LED display.
- 6) The outdoor unit makes an error stop immediately when not only the pressure sensor but also the pressure switch detects  $4.15^{+0,-0.15}$  MPa [ $601^{+0,-22}$  psi]
- 7) Open phase due to unstable power supply voltage may cause the pressure switch to malfunction or cause the units to come to an abnormal stop.

### 3. Cause, check method and remedy

Cause	Check method and remedy
(1) Indoor unit LEV2 actuation failure -> Cooling Indoor unit LEV actuation failure -> Heating	Perform a cooling or heating operation to check the operation. Cooling: Indoor unit LEV2 Heating: Indoor unit LEV Refer to the following page(s). [8-8 Troubleshooting LEV Problems](page 258)
(2) Closed refrigerant service valve	Confirm that the refrigerant service valve is fully open.
(3) Short cycle on the indoor unit side (4) Clogged filter on the indoor unit (5) Reduced air flow due to dirty fan on the indoor unit fan (6) Dirty heat exchanger of the indoor unit (7) Indoor fan (including fan parts) failure or motor failure Rise in high pressure caused by lowered condensing capacity in heating operation for (2) - (7).	Check the indoor units for problems and correct them, if any.
(8) Short cycle on the outdoor unit (9) Dirty heat exchanger of the outdoor unit	Check the outdoor units for problems and correct them, if any.
(10) Outdoor fan (including fan parts) failure, motor failure, or fan controller malfunction Rise in discharge temp. by low pressure drawing for (8) - (10).	Check the fan on the outdoor unit. Refer to the following page(s). [8-7 Troubleshooting Outdoor Unit Fan Problems](page 257)
(11) Solenoid valve (SV1a) malfunction (The by-pass valve (SV1a) can not control rise in high pressure).	Refer to the following page(s). [8-6 Troubleshooting Solenoid Valve Problems](page 255)
(12) Thermistor failure (TH3, TH7)	Refer to the following page(s).
(13) Pressure sensor failure	Refer to the following page(s). [8-5-1 Comparing the High-Pressure Sensor Measurement and Gauge Pressure](page 253)
(14) Failure of the thermistor input circuit and pressure sensor input circuit on the controller board	Check the temperature and the pressure of the sensor with LED monitor.
(15) Thermistor mounting problem (TH3, TH7) (16) Disconnected male connector on the pressure switch (63H1) or disconnected wire	Check the temperature and the pressure of the sensor with LED monitor.
(17) Voltage drop caused by unstable power supply voltage	Check the input voltage at the power supply terminal block (TB1).

### 7-3-4 Error Code [1302] (at startup)

**1. Error code definition**

**High pressure fault 2 (Outdoor unit)**

**2. Error definition and error detection method**

If the pressure of 0.098MPa [14psi] or lower is registered on the pressure sensor immediately before start-up, it will trigger an abnormal stop, and error code "1302" will be displayed.

**3. Cause, check method and remedy**

Cause		Check method and remedy
(1)	Inner pressure drop due to a leakage.	Refer to the following page(s). [8-5-1 Comparing the High-Pressure Sensor Measurement and Gauge Pressure](page 253)
(2)	Pressure sensor failure	
(3)	Shorted-circuited pressure sensor cable due to torn outer rubber	
(4)	A pin on the male connector on the pressure sensor is missing or contact failure	
(5)	Disconnected pressure sensor cable	
(6)	Failure of the pressure sensor input circuit on the controller board	

### 7-3-5 Error Code [1500]

**1. Error code definition**

**Refrigerant overcharge**

**2. Error definition and error detection method**

An error can be detected by the discharge temperature superheat.

- 1) If the formula " $TdSH \leq 10^{\circ}C [18^{\circ}F]$ " is satisfied during operation (first detection), the outdoor unit stops, goes into the 3-minute restart mode, and starts up in three minutes.
- 2) If the formula " $TdSH \leq 10^{\circ}C [18^{\circ}F]$ " is satisfied again within 30 minutes of the fifth stoppage of the outdoor unit (sixth detection), the unit comes to an abnormal stop, and the error code "1500" appears.
- 3) If the formula " $TdSH \leq 10^{\circ}C [18^{\circ}F]$ " is satisfied 30 minutes or more after the first stoppage of the outdoor unit, the same sequence as Item "1" above (first detection) is followed.
- 4) For 30 minutes after the stop of the outdoor unit, preliminary errors will be displayed on the LED display.

**3. Cause, check method and remedy**

Cause		Check method and remedy
(1)	Overcharged refrigerant	Refer to the following page(s). [6-9 Evaluating and Adjusting Refrigerant Charge](page 131)
(2)	Thermistor input circuit failure on the control board	Check the temperature and pressure readings on the sensor that are displayed on the LED monitor.
(3)	Faulty mounting of thermistor (TH4)	Check the temperature and pressure readings on the thermistor that are displayed on the LED monitor.
(4)	Outdoor unit LEV2 actuation failure -> Heating	Refer to the following page(s). [8-8 Troubleshooting LEV Problems](page 258)

## 7-4 Error Code Definitions and Solutions: Codes [2000 - 2999]

### 7-4-1 Error Code [2500] (Models with a drain sensor)

**1. Error code definition**

**Drain sensor submergence**

**2. Error definition and error detection method**

- 1) If an immersion of the drain sensor in the water is detected while the unit is in any mode other than the Cool/Dry mode and when the drain pump goes from OFF to ON, this condition is considered preliminary water leakage. While this error is being detected, humidifier output cannot be turned on.
- 2) If the immersion of the sensor in the water is detected four consecutive times at an hour interval, this is considered water leakage, and "2500" appears on the monitor.
- 3) Detection of water leakage is also performed while the unit is stopped.
- 4) Preliminary water leakage is cancelled when the following conditions are met:
  - ♦One hour after the preliminary water leakage was detected, it is not detected that the drain pump goes from OFF to ON.
  - ♦The operation mode is changed to Cool/Dry.
  - ♦The liquid pipe temperature minus the inlet temperature is -10°C [-18°F] or less.

**3. Cause, check method and remedy**

Cause	Check method and remedy
(1) Drain water drainage problem ♦Clogged drain pump ♦Clogged drain piping ♦Backflow of drain water from other units	Check for proper drainage.
(2) Adhesion of water drops to the drain sensor ♦Trickling of water along the lead wire ♦Rippling of drain water caused by filter clogging	1) Check for proper lead wire installation. 2) Check for clogged filter.
(3) Failure of the relay circuit for the solenoid valve	Replace the relay.
(4) Indoor unit control board failure ♦Drain sensor circuit failure	If the above item checks out OK, replace the indoor unit control board.



## 7-4-2 Error Code [2500] (Models with a float switch)

### 1. Error code definition

#### Drain sensor submergence

### 2. Error definition and error detection method

- 1) If an immersion of the float switch in the water is detected while the unit is in any mode other than the Cool/Dry mode and when the drain pump goes from OFF to ON, this condition is considered preliminary water leakage. While this error is being detected, humidifier output cannot be turned on.
- 2) If the drain pump turns on within one hour after preliminary water leakage is detected and the above-mentioned condition is detected two consecutive times, water leakage error water leakage is detected, and "2500" appears on the monitor.
- 3) Detection of water leakage is also performed while the unit is stopped.
- 4) Preliminary water leakage is cancelled when the following conditions are met:
  - One hour after the preliminary water leakage was detected, it is not detected that the drain pump goes from OFF to ON.
  - The operation mode is changed to Cool/Dry.
  - The liquid pipe temperature minus the inlet temperature is - 10°C [ -18°F] or less.

### 3. Cause, check method and remedy

Cause	Check method and remedy
(1) Drain water drainage problem •Clogged drain pump •Clogged drain piping •Backflow of drain water from other units	Check for proper drainage.
(2) Stuck float switch Check for slime in the moving parts of the float switch.	Check for normal operation of the float switch.
(3) Float switch failure	Check the resistance with the float switch turned on and turned off.

<Reference>

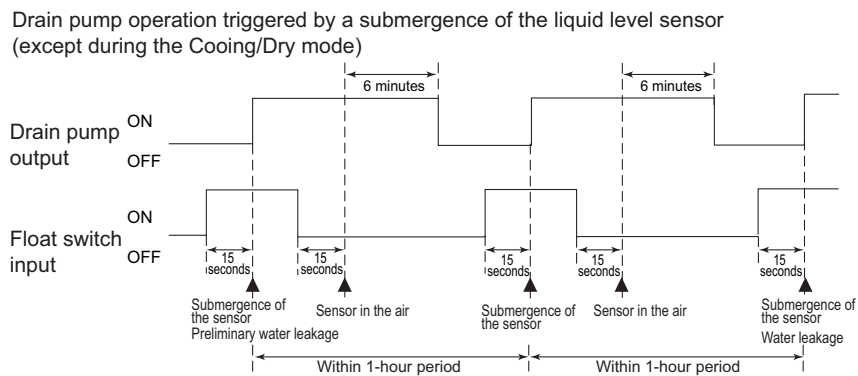

### 7-4-3 Error Code [2502] (Models with a drain sensor)

**1. Error code definition**

**Drain pump fault**

**2. Error definition and error detection method**

- 1) Make the drain sensor thermistor self-heat. If the temperature rise is small, it is interpreted that the sensor is immersed in water. This condition is considered to be a preliminary error, and the unit goes into the 3-minute restart delay mode.
- 2) If another episode of the above condition is detected during the preliminary error, this is considered a drain pump error, and "2502" appears on the monitor.
- 3) This error is always detected while the drain pump is in operation.
- 4) The following criteria are met when the criteria for the forced stoppage of outdoor unit (system stoppage) are met.
  - \*"Liquid pipe temperature-inlet temperature  $\leq -10^{\circ}\text{C}$  [ $-18^{\circ}\text{F}$ ]" has been detected for 30 minutes.
  - \*The immersion of drain sensor is detected 10 consecutive times.
  - \*The conditions that are listed under items 1) through 3) above are always met before the criteria for the forced stoppage of the outdoor unit.
- 5) The indoor unit that detected the conditions that are listed in item 4) above brings the outdoor unit in the same refrigerant circuit to an error stop (compressor operation prohibited), and the outdoor unit brings all the indoor units in the same refrigerant circuit that are in any mode other than Fan or Stop to an error stop. "2502" appears on the monitor of the units that came to an error stop.
- 6) Forced stoppage of the outdoor unit  
 Detection timing: The error is detected whether the unit is in operation or stopped.
- 7) Ending criteria for the forced stoppage of outdoor unit  
 Power reset the indoor unit that was identified as the error source and the outdoor unit that is connected to the same refrigerant circuit.  
 Forced stoppage of the outdoor unit cannot be cancelled by stopping the unit via the remote controller.  
 (Note) Items 1) - 3) and 4) - 7) are detected independently from each other.

**Note**

The address and attribute that appear on the remote controller are those of the indoor unit (or OA processing unit) that caused the error.

**3. Cause, check method and remedy**

Cause	Check method and remedy
(1) Drain pump failure	Check for proper functioning of the drain pump.
(2) Drain water drainage problem ♦Clogged drain pump ♦Clogged drain piping	Check for proper drainage.
(3) Adhesion of water drops to the drain sensor ♦Trickling of water along the lead wire ♦Rippling of drain water caused by filter clogging	1) Check for proper lead wire installation. 2) Check for clogged filter.
(4) Indoor unit control board failure ♦Drain pump drive circuit failure ♦Drain heater output circuit failure	If the above item checks out OK, replace the indoor unit control board.
(5) Items (1) through (4) above and an indoor unit electronic valve closure failure (leaky valve) occurred simultaneously.	Check the solenoid valves on the indoor unit for leaks.

## 7-4-4 Error Code [2502] (Models with a float switch)

### 1. Error code definition

#### Drain pump fault

### 2. Error definition and error detection method

- 1) The immersion of sensor tip in water is detected by the ON/OFF signal from the float switch.
  - \*Submergence of the sensor  
When it is detected that the float switch has been ON for 15 seconds, it is interpreted that the sensor tip is immersed in water.
  - \*Sensor in the air  
When it is detected that the float switch has been OFF for 15 seconds, it is interpreted that the sensor tip is not immersed in water.
- 2) If it is detected that the float switch has been ON for 3 minutes after the immersion of the sensor tip was detected, this is considered a drain pump failure, and "2502" appears on the monitor.
  - \*The total time it takes for this error to be detected is 3 minutes and 15 seconds, including the time it takes for the first immersion of the sensor tip to be detected.
- 3) Detection of drain pump failure is performed while the unit is stopped.
- 4) The following criteria are met when the criteria for the forced stoppage of outdoor unit (system stoppage) are met.
  - \*"Liquid pipe temperature-inlet temperature  $\leq -10^{\circ}\text{C}$  [ $-18^{\circ}\text{F}$ ]" has been detected for 30 minutes.
  - \*It is detected by the float switch that the sensor tip has been immersed in water for 15 minutes or more.
  - \*The conditions that are listed under items 1) through 3) above are always met before the criteria for the forced stoppage of the outdoor unit.
- 5) The indoor unit that detected the conditions that are listed in item 4) above brings the outdoor unit in the same refrigerant circuit to an error stop (compressor operation prohibited), and the outdoor unit brings all the indoor units in the same refrigerant circuit that are in any mode other than Fan or Stop to an error stop.
- 6) Forced stoppage of the outdoor unit  
Detection timing: The error is detected whether the unit is in operation or stopped.  
This error is detected whether the unit is in operation or stopped.
- 7) Ending criteria for the forced stoppage of outdoor unit  
Power reset the indoor unit that was identified as the error source and the outdoor unit that is connected to the same refrigerant circuit.  
Forced stoppage of the outdoor unit cannot be cancelled by stopping the unit via the remote controller.  
(Note) Items 1) - 3) and 4) - 7) are detected independently from each other.

#### Note

The address and attribute that appear on the remote controller are those of the indoor unit (or OA processing unit) that caused the error.

### 3. Cause, check method and remedy

Cause	Check method and remedy
(1) Drain pump failure	Check for proper functioning of the drain pump mechanism
(2) Drain water drainage problem •Clogged drain pump •Clogged drain piping	Check for proper drainage.
(3) Stuck float switch Check for slime in the moving parts of the float switch.	Check for normal operation of the float switch.
(4) Float switch failure	Check the resistance with the float switch turned on and turned off.
(5) Indoor unit control board failure •Drain pump drive circuit failure •Float switch input circuit failure	Replace indoor unit control board.
(6) Items (1) through (5) above and an indoor unit electronic valve closure failure (leaky valve) occurred simultaneously.	Check the solenoid valves on the indoor unit for leaks.

## 7-4-5 Error Code [2503]

### 1. Error code definition

**Drain sensor (Thd) fault**

### 2. Error definition and error detection method

- ♦If the open or short circuit of the thermistor has been detected for 30 seconds, this condition is considered to be a preliminary error, and the unit goes into the 3-minute restart delay mode.
- ♦If another episode of the above condition is detected during the preliminary error, this is considered a drain sensor error.(If the short or open circuit of the thermistor is no longer detected, normal operation will be restored in 3 minutes.)
- ♦This error is detected when one of the following conditions are met.
  - \*During Cool/Dry operation
  - \*Liquid pipe temperature minus inlet temperature is equal to or smaller than -10°C [-18°F] (except during the defrost cycle)
  - \*When the liquid temperature thermistor or suction temperature thermistor or short or open circuited.
  - \*Drain pump is in operation.
  - \*One hour has elapsed since the drain sensor went off.
    - Short: 90°C [194 °F] or above
    - Open: - 20°C [-4 °F] or below

### 3. Cause, check method and remedy

Cause	Check method and remedy
(1) Faulty connector (CN31) insertion.	1) Check for connector connection failure. Reinsert the connector, restart the operation, and check for proper operation.
(2) Broken or semi-broken thermistor wire	2) Check for a broken thermistor wire.
(3) Thermistor failure	3) Check the resistance of the thermistor. 0°C[32 °F]:6.0 kΩ 10°C[50 °F]:3.9 kΩ 20°C[68°F]:2.6 kΩ 30°C[86°F]:1.8 kΩ 40°C[104 °F]:1.3 kΩ
(4) Indoor unit control board (error detection circuit) failure	4) Replace the indoor unit control board if the problem recurs when the unit is operated with the No.-1 and No.-2 pins on the drain sensor connector (CN31) being short-circuited. If the above item checks out OK, there are no problems with the drain sensor. Turn off the power and turn it back on.

### 7-4-6 **Error Code [2600]**

---

**1. Error code definition**

**Water leakage**

**2. Cause, check method and remedy**

Check that water does not leak from the pipes in such as the humidifier.

### 7-4-7 **Error Code [2601]**

---

**1. Error code definition**

**Water supply cutoff**

**2. Cause, check method and remedy**

Cause		Check method and remedy
(1)	The water tank of the humidifier is empty.	Check the amount of supply water. Check for the solenoid valve and for the connection.
(2)	The solenoid valve for humidification is OFF.	Check the connector.
(3)	Disconnected float switch	Check the connecting part.
(4)	Poor operation of float switch	Check for the float switch.
(5)	Frozen water tank	Turn off the power source of the water tank to defrost, and turn it on again.

## 7-5 Error Code Definitions and Solutions: Codes [3000 - 3999]

### 7-5-1 Error Code [3121]

**1. Error code definition**

**Out-of-range outside air temperature**

**2. Error definition and error detection method**

- When the thermistor temperature of -28°C[-18°F] or below has continuously been detected for 3 minutes during heating operation (during compressor operation), the unit makes an error stop and "3121" appears on the display. (Use the OC thermistor temperature to determine when two outdoor units are in operation.)
- The compressor restarts when the thermistor temperature is -26°C[-15°F] or above (both OC and OS) during error stop. (The error display needs to be canceled by setting the remote controller.)
- Outdoor temperature error is canceled if the units stop during error stop. (The error display needs to be canceled by setting the remote controller.)

**3. Cause, check method and remedy**

Check the following factors if an error is detected, without drop in the outdoor temperature.

Cause	Check method and remedy
(1) Thermistor failure	Check thermistor resistance.
(2) Pinched lead wire	Check for pinched lead wire.
(3) Torn wire coating	Check for wire coating.
(4) A pin on the male connector is missing or contact failure	Check connector.
(5) Disconnected wire	Check for wire.
(6) Thermistor input circuit failure on the control board	Check the intake temperature of the sensor with the LED monitor. When the temperature is far different from the actual temperature, replace the control board.

<Reference>

Short detection
Open detection  
 TH7 110 °C [230 °F] and above (0.4 kΩ)    -40 °C [-40 °F] and below (130 kΩ)

## 7-6 Error Code Definitions and Solutions: Codes [4000 - 4999]

### 7-6-1 Error Code [4102]

#### 1. Error code definition

Open phase

#### 2. Error definition and error detection method

- An open phase of the power supply (L1 phase, N phase) was detected at power on.
- The L3 phase current is outside of the specified range.
- When an open phase is detected (L2-phase or N-phase in the power supply) is detected at the start of operation.

#### Note

The open phase of the power supply may not always be detected if a power voltage from another circuit is applied.

#### 3. Cause, check method and remedy

Cause		Check method and remedy
(1)	Power supply problem •Open phase voltage of the power supply •Power supply voltage drop	Check the input voltage to the power supply terminal block TB1.
(2)	Noise filter problem •Coil problem •Circuit board failure	<ul style="list-style-type: none"> <li>•Check the coil connections.</li> <li>•Check for coil burnout.</li> <li>•Confirm that the voltage at the CN3 connector is 198 V or above.</li> <li>•Check that the voltage across pins 3 and 5 on the noise filter CN4 connector is equal to or greater than 198 volts.</li> </ul>
(3)	Wiring failure	<p>Confirm that the voltage at the control board connector CNAC is 198 V or above.</p> <p>If the voltage is below 198V, check the wiring connection between the noise filter board CN3, noise filter board CN2 and control board CNAC.</p> <p>Confirm that the wiring between noise filter TB23 and INV board SC-L3 is put through CT3.</p> <p>Check the connections of the wire between capacitor board connector CN102 and control board connector CN110.</p>
(4)	Blown fuse	<p>Check for a blown fuse (F01) on the control board.</p> <p>→If a blown fuse is found, check for a short-circuiting or earth fault of the actuator.</p> <p>Check that F1 and F2 on the noise filter are not blown.</p> <p>→If a blown fuse is found, check for a short-circuiting or earth fault of the actuator.</p>
(5)	CT3 failure	Replace the inverter board if this problem is detected after the compressor has gone into operation.
(6)	Control board failure	Replace the control board if none of the above is causing the problem.

## 7-6-2 Error Code [4106]

### 1. Error code definition

<Transmission power supply fault Error detail code FF (Outdoor unit)>

### 2. Error definition and error detection method

Transmission power output failure

### 3. Cause

- 1) Wiring failure
- 2) Transmission power supply cannot output voltage because overcurrent was detected.
- 3) Voltage cannot be output due to transmission power supply problem.
- 4) Transmission voltage detection circuit failure

### 4. Check method and remedy

Check the transmission power supply circuit on all outdoor units in a given refrigerant circuit for problems. [8-10-2 Troubleshooting Problems with Outdoor Unit Transmission Power Supply Circuit](page 278)

### 1. Error code definition

<Transmission power supply fault other than error detail code FF (Outdoor unit)>

### 2. Error definition and error detection method

Transmission power reception failure

### 3. Cause

One of the outdoor units stopped supplying power, but no other outdoor units start supplying power.

### 4. Check method and remedy

Check the transmission power supply circuit on all outdoor units in a given refrigerant circuit for problems. [8-10-2 Troubleshooting Problems with Outdoor Unit Transmission Power Supply Circuit](page 278)

## 7-6-3 Error Code [4109]

### 1. Error code definition

Indoor unit fan operation error

### 2. Error definition and error detection method

- 1) Connector CN28 has remained open-circuited for 100 consecutive seconds during operation.

### 3. Cause, check method and remedy

Cause	Check method and remedy
(1) Auxiliary relay (X13) fault	The coil or the wiring of the auxiliary relay connected to CN28 is faulty.
(2) Connector (CN28) is disconnected.	Check the connector for proper connection.
(3) Blown fuse	Check the fuse on the control circuit board.
(4) Motor error (thermistor error inside the motor)	Check the unit fan for proper operation in the test run mode. If no problems are found with items 1 through 3 above and the fan does not operate, replace the motor.



### 7-6-4 Error Code [4115]

**1. Error code definition**

**Power supply signal sync error**

**2. Error definition and error detection method**

The frequency cannot be determined when the power is switched on.

**3. Cause, check method and remedy**

Cause		Check method and remedy
(1)	Power supply error	Check the voltage of the power supply terminal block (TB1).
(2)	Noise filter problem •Coil problem •Circuit board failure	•Check the coil connections. •Check for coil burnout. •Confirm that the voltage at the CN3 connector is 198 V or above.
(3)	Faulty wiring	Check fuse F01 on the control board.
(4)	Wiring failure Between noise filter CN3 and noise filter CN2 and control board CNAC	Confirm that the voltage at the control board connector CNAC is 198 V or above.
(5)	Control board failure	If none of the items described above is applicable, and if the trouble reappears even after the power is switched on again, replace the control board.

### 7-6-5 Error Code [4116]

**1. Error code definition**

**RPM error/Motor error**

**2. Error definition and error detection method**

•LOSSNAY

\*The motor keep running even if the power is OFF.

\*The thermal overload relay is ON. (Only for the three-phase model)

•Indoor unit

If detected less than 180rpm or more than 2000rpm, the indoor unit will restart and keep running for 3 minutes.If detected again, the display will appear.

**3. Cause, check method and remedy**

Cause		Check method and remedy
(1)	Board failure	Replace the board.
(2)	Motor malfunction	Check for the motor and the solenoid switch.
(3)	Solenoid switch malfunction	

## 7-6-6 **Error Code [4121]**

**1. Error code definition**  
**Function setting error**

**2. Error source, cause, check method and remedy**

Error source	Cause	Check method and remedy
Outdoor unit	(1) Dip switch setting error on the control board	Check the SW6-1 setting on the control board
	(2) Connector connection error on the control board	Check that nothing is connected to the connector CNAF on the control board.
	(3) Control board failure	Replace the control board if no problems are found with the two items above.

## 7-6-7 Error Code [4124]

### 1. Error code definition

**Electric system not operate due to damper abnormality**

### 2. Error definition and error detection method

When the damper is not located at the designated position.

### 3. Cause, check method and remedy

When the damper is not located at the designated position.

- 1) Check there is something that interferes the opening or closing movement of the damper.
- 2) If damper does not open or close, turn OFF the power supply and measure the resistance of the damper lock motors (ML1, ML2) and the damper motor (MV2).  
The resistance value is normal each. →Replace the indoor electronic control P.C. board.  
The resistance value is not normal each. →Replace the motor that indicates the abnormal value.

Part name	Check method and criteria		Figure
Damper lock motor Right(ML1)	Measure the resistance between the terminals with a tester. (Part temperature: 10°C ~ 30°C)		
Damper lock motor Left(ML2)	Color of the lead wire	Normal	
	BRN-other one	235Ω~255Ω	
Damper motor (MV2)	Measure the resistance between the terminals with a tester. (Part temperature: 10°C ~ 30°C)		
	Color of the lead wire	Normal	
	BRN-other one	282Ω~306Ω	

- 3) If damper opens or closes, measure the voltage between CN1X1 (+) and (-) and the voltage between CN1Y1 (+) and (-) during the damper open by pressing VANE CONTROL button.  
There is not 0V DC between CN1X1 (+) and (-). →Replace the damper limit switch (open)  
There is not 5V DC between CN1X1 (+) and (-). →Replace the damper limit switch (close)
- 4) If damper opens or closes and voltages in 3) are normal, measure the voltage between CN1X1 (+) and (-) and the voltage between CN1Y1 (+) and (-) during the damper close by pressing VANE CONTROL button.  
There is not 5V DC between CN1X1 (+) and (-). →Replace the damper limit switch (open)  
There is not 0V DC between CN1X1 (+) and (-). →Replace the damper limit switch (close)  
There is 5V DC between CN1X1 (+) and (-) and 0V DC between CN1X1 (+) and (-). →Replace the indoor electronic control P.C. board.

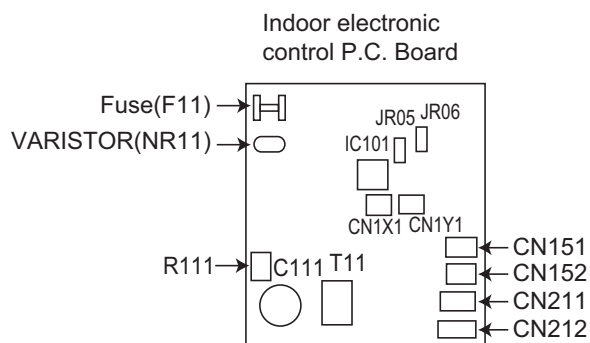

Note: Refer also to the Service Handbook for the indoor units.

## 7-6-8 Error Codes [4220, 4225, 4226] Detail Code 108

### 1. Error code definition

**Abnormal bus voltage drop (Detail code 108)**

### 2. Error definition and error detection method

If Vdc 289V or less is detected during Inverter operation. (S/W detection)

### 3. Cause, check method and remedy

#### (1) Power supply environment

Find out if there was a (momentary) power failure.

Check whether the power voltage (Between L1 and L2, L2 and L3, and L1 and L3) is 342V or less across all phases.

#### (2) Voltage drop detected

##### 4220

INV20Y

•Check the voltage between the FT-P and FT-N terminals on the INV board while the inverter is stopped and if it is 420 V or above, check the following items.

- 1) Confirm on the LED monitor that the bus voltage is above 289V.

Replace the INV board if it is below 289 V.

- 2) Check the voltage at CN72 on the control board. →Go to (3).
- 3) Check the noise filter coil connections and for coil burnout.
- 4) Check the wiring connections between the following sections

Between the noise filter board and INV board. Between the INV board and DCL.

Replace 72C if no problems are found.

- 5) Check the IGBT module resistance on the INV board. Refer to the following page(s). [8-9-15 Troubleshooting Problems with IGBT Module](page 273)

•Check the voltage between the FT-P and FT-N terminals on the INV board while the inverter is stopped and if it is less than 420 V, check the following items.

- 1) Check the coil connections and for coil burnout on the noise filter.
- 2) Check the wiring between the noise filter board and INV board.
- 3) Check the connection to SCP1 and SC-P2 on the INV board.
- 4) Check the in-rush current resistor value.
- 5) Check the 72C resistance value.
- 6) Check the DCL resistance value.

Replace the INV board if no problems are found.

INV30YC

•Check the voltage across SC-P and SC-N on the inverter board while the inverter is stopped.

If the voltage is 420 volts or above, check the following.

- 1) Check on the LED monitor that the BUS voltage is greater than 289 volts. If it is equal to or below 289 volts, replace the inverter board.
- 2) Check the coli (L) for proper connection, and check for broken wiring.
- 3) Check the wiring between the following parts.  
Between the noise filter board and inverter board, and between the inverter board and the capacitor board.
- 4) If the problem persists after restart, replace the inverter board.

If the voltage is below 420 volts, check the following.

- 1) Check the coli (L) for proper connection, and check for broken wiring.
- 2) Check the wiring between the following parts.  
Between the noise filter board and inverter board, and between the inverter board and the capacitor board.
- 3) Check the inrush current resistor value. Refer to section [8-9-14 Simple Check on Inverter Circuit Components](page 273)
- 4) If the problem persists after restart, replace the inverter board.

#### **4225**

•Check the voltage at CNVDC on the Fan board while the inverter is stopped and if it is 420 V or above, check the following items.

- 1) Check the voltage at CN72 on the control board. →Go to 3).
- 2) Check the noise filter coil connections and for coil burnout.
- 3) Check the wiring connections between the following sections  
Between the noise filter board INV board and the Fan board.
- 4) Check contents 4220

Replace the Fan board if no problems are found.

•Check the voltage at CNVDC on the Fan board while the inverter is stopped and if it is less than 420 V, check the following items.

- 1) Check the state of the wiring connections between the INV board and the Fan board.
- 2) Check contents 4220

Replace the Fan board if no problems are found.

#### **In case of 4226 (On the P450 and P500 models, this error code relates to the fan board in the fan box.)**

•Check the voltage at CNVDC on the Fan board while the inverter is stopped and if it is 420 V or above, check the following items.

- 1) Check the voltage at CN72 on the control board. →Go to 3).
- 2) Check the noise filter coil connections and for coil burnout.
- 3) Check the wiring connections between the following sections  
Between the noise filter board INV board and the Fan board.
- 4) Check contents 4220

Replace the Fan board if no problems are found.

•Check the voltage at CNVDC on the Fan board while the inverter is stopped and if it is less than 420 V, check the following items.

- 1) Check between noise filter board, inverter board, connector board, and fan board.
- 2) Check contents 4220

Replace the Fan board if no problems are found.

### **(3) Control board failure**

Check that 12VDC is applied to connector CN72 on the control board while the inverter is operating. If voltage is absent or the wrong voltage is applied, check the fuse F01. Replace the control board if no problems are found with the fuse.

#### **Note**

For inverter-related error codes, refer to the following page(s). [8-9 Troubleshooting Inverter Problems](page 264)

---

## **7-6-9 Error Codes [4220, 4225, 4226] Detail Code 109**

---

### **1. Error code definition**

**Abnormal bus voltage rise (Detail code 109)**

### **2. Error definition and error detection method**

If Vdc  $\geq$  830V is detected during inverter operation.

### **3. Cause, check method and remedy**

#### **(1) Different voltage connection**

Check the power supply voltage on the power supply terminal block (TB1).

#### **(2) INV board failure**

If the problem recurs, replace the INV board or fan board.

In the case of 4220: INV board

In the case of 4225: Fan board

In the case of 4226: Fan board (Fan box side)

#### **Note**

For inverter-related error codes, refer to the following page(s). [8-9 Troubleshooting Inverter Problems](page 264)

## 7-6-10 Error Code [4220] Detail Code 110

**1. Error code definition**

**VDC error (Detail code 110)**

**2. Error definition and error detection method**

BUS voltage error When Vdc is equal to or greater than 814 volts (hardware detection)  
 If a voltage drop of the 12 V power supply (CNRY) of the relay on the INV board is detected (INV30YC only)

**3. Cause, check method and remedy**

Details of 4220 error: See No. 108 and 109.  
 Also see error details No. 124 of 4220 error (applicable to INV30YC only).

**Note**

For inverter-related error codes, refer to the following page(s). [8-9 Troubleshooting Inverter Problems](page 264)

## 7-6-11 Error Codes [4220, 4225, 4226] Detail Code 111, 112

**1. Error code definition**

**Logic error (Detail code 111, 112)**

**2. Error definition and error detection method**

H/W error  
 If only the H/W error logic circuit operates, and no identifiable error is detected.

**3. Cause, Check method and remedy**

**In the case of 4220**

Cause	Check method and remedy
(1) External noise	Refer to the following page(s). [8-9-2 Checking the Inverter Board Error Detection Circuit](page 266)
(2) INV board failure	

**In the case of 4225 and 4226**

Cause	Check method and remedy
(1) External noise	Refer to the following page(s). [8-9-8 Checking the Fan Board Error Detection Circuit at No Load](page 269) [8-9-9 Checking the Fan Inverter for Damage at No Load](page 270) [8-9-10 Checking the Fan Inverter for Damage with Load](page 271)
(2) Fan board failure	

**Note**

For inverter-related error codes, refer to the following page(s). [8-9 Troubleshooting Inverter Problems](page 264)

## 7-6-12 Error Code [4220] Detail Code 123

**1. Error code definition**

**Voltage boost control error (Detail code 123)(outdoor unit)**

**2. Error definition and error detection method**

When a drop in power supply voltage or a malfunction in the booster circuit is detected

**3. Cause, check method and remedy**

Cause	Check method and remedy
(1) Inverter-output-related items	Refer to the following page(s). [8-9-2 Checking the Inverter Board Error Detection Circuit](page 266)  Refer to the following page(s). [8-9-3 Checking the Compressor for Ground Fault and Coil Resistance Problems](page 266)  Refer to the following page(s). [8-9-4 Checking the Inverter for Damage at No-Load](page 266)  Refer to the following page(s). [8-9-5 Checking the Inverter for Damage during Compressor Operation](page 267)  Refer to the following page(s). [8-9-11 Checking the Installation Conditions](page 271)

**Note**

For inverter-related error codes, refer to the following page(s). [8-9 Troubleshooting Inverter Problems](page 264)

## 7-6-13 Error Code [4220] Detail Code 124

**1. Error code definition**

**BUS circuit fault (Detail code 124)(outdoor unit)**

**2. Error definition and error detection method**

When a malfunction of the relay (RY 2, 3, or 4) on the inverter board is detected

**3. Cause, check method and remedy**

Cause	Check method and remedy
(1) Contact failure	Refer to the following page(s). [8-9-4 Checking the Inverter for Damage at No-Load](page 266)  Refer to the following page(s). [8-9-5 Checking the Inverter for Damage during Compressor Operation](page 267)
(2) Inverter-output-related items	Refer to the following page(s). [8-9-2 Checking the Inverter Board Error Detection Circuit](page 266)  Refer to the following page(s). [8-9-3 Checking the Compressor for Ground Fault and Coil Resistance Problems](page 266)  Refer to the following page(s). [8-9-4 Checking the Inverter for Damage at No-Load](page 266)  Refer to the following page(s). [8-9-5 Checking the Inverter for Damage during Compressor Operation](page 267)  Refer to the following page(s). [8-9-11 Checking the Installation Conditions](page 271)

**Note**

For inverter-related error codes, refer to the following page(s). [8-9 Troubleshooting Inverter Problems](page 264)

## 7-6-14 Error Codes [4220, 4225, 4226] Detail Code 131

### 1. Error code definition

**Low bus voltage at startup (Detail code 131)**

### 2. Error definition and error detection method

When  $V_{dc} \leq 160$  V is detected just before the inverter operation.

### 3. Cause, check method and remedy

#### (1) Inverter main circuit failure

Same as detail code 108 of 4220 error

#### Note

For inverter-related error codes, refer to the following page(s). [8-9 Troubleshooting Inverter Problems](page 264)

## 7-6-15 Error Code [4230] Detail Code 125

### 1. Error code definition

**Heatsink overheat protection (Detail code 125)**

### 2. Error definition and error detection method

When the heat sink temperature (THHS) remains at or above TOH is detected.

models	TOH
INV20Y	105°C
INV30YC	94°C

### 3. Cause, check method and remedy

Cause	Check method and remedy
(1) Fan board failure	Refer to the following page(s). [8-9-8 Checking the Fan Board Error Detection Circuit at No Load](page 269) [8-9-9 Checking the Fan Inverter for Damage at No Load](page 270) [8-9-10 Checking the Fan Inverter for Damage with Load](page 271)
(2) Outdoor unit fan failure	Check the outdoor unit fan operation. If any problem is found with the fan operation, check the fan motor. Refer to the following page(s). [8-9-7 Checking the Fan Motor for Ground Fault and Coil Resistance Problems](page 269)
(3) Air passage blockage	Check that the heat sink cooling air passage is not blocked
(4) THHS failure	1) Check for proper installation of the INV board IGBT. (Check for proper installation of the IGBT heatsink.) 2) Check the THHS sensor reading on the LED monitor. →If an abnormal value appears, replace the INV board.

#### Note

For inverter-related error codes, refer to the following page(s). [8-9 Troubleshooting Inverter Problems](page 264)



## 7-6-16 **Error Code [4230] Detail Code 126**

### 1. Error code definition

**DCL temperature fault (Detail code 126)(outdoor unit)**

### 2. Error definition and error detection method

When DCL temperature that equals or exceeds 170°C is detected (applicable to INV30YC only)

### 3. Cause, check method and remedy

Cause	Check method and remedy
(1) Fan inverter board fault	Refer to the following page(s). [8-9-8 Checking the Fan Board Error Detection Circuit at No Load](page 269)  Refer to the following page(s). [8-9-9 Checking the Fan Inverter for Damage at No Load](page 270)  Refer to the following page(s). [8-9-10 Checking the Fan Inverter for Damage with Load](page 271)
(2) Outdoor unit fan fault	Check the outdoor unit fan for proper operation. If there is a problem with fan operation, check the fan motor. Refer to the following page(s). [8-9-7 Checking the Fan Motor for Ground Fault and Coil Resistance Problems](page 269)
(3) DCL temperature sensor connector contact failure	Check the connector (CNTH) on the inverter board for proper connection.
(4) DCL error	If the problem persists after restart, replace the DCL.

#### **Note**

For inverter-related error codes, refer to the following page(s). [8-9 Troubleshooting Inverter Problems](page 264)

## 7-6-17 Error Code [4240]

### 1. Error code definition Overload protection

### 2. Error definition and error detection method

If the output current of " $I_{ac} > I_{max} (A_{rms})$ " or " $THHS > TOL$ " is continuously detected for 10 minutes during inverter operation, refer to the following page(s). [7-1 Error Code and Preliminary Error Code Lists](page 168)

### 3. Cause, check method and remedy

Cause	Check method and remedy
(1) Air passage blockage	Check that the heat sink cooling air passage is not blocked
(2) Power supply environment	Power supply voltage is 342 V or above.
(3) Inverter failure	Refer to the following page(s). [8-9 Troubleshooting Inverter Problems](page 264)
(4) Compressor failure	Check that the compressor has not overheated during operation. → Check the refrigerant circuit (oil return section). Refer to the following page(s). [8-9-3 Checking the Compressor for Ground Fault and Coil Resistance Problems](page 266)
(5) The model selection switches (SW5-3 - 5-8) on the outdoor unit are set incorrectly.	Check the setting for the model selection switch on the outdoor unit (Dipswitches SW5-3 - 5-8 on the outdoor unit control board). For switch settings, refer to the following page(s). [7-9-2 Error Code [7101]](page 227)

#### Note

For inverter-related error codes, refer to the following page(s). [8-9 Troubleshooting Inverter Problems](page 264)

## 7-6-18 Error Codes [4250, 4255, 4256] Detail Code 101

### 1. Error code definition

**IPM error (Detail code 101)**

### 2. Error definition and error detection method

**In the case of 4250**

If an overcurrent is detected by the overcurrent detection resistor RSH (R001 when INV30YC) on the INV board.

**In the case of 4255 and 4256**

IPM error signal is detected.

### 3. Cause, check method and remedy

**In the case of 4250**

Cause	Check method and remedy
(1) Inverter output related	Refer to the following page(s). [8-9-2 Checking the Inverter Board Error Detection Circuit](page 266) [8-9-3 Checking the Compressor for Ground Fault and Coil Resistance Problems](page 266) [8-9-4 Checking the Inverter for Damage at No-Load](page 266) [8-9-5 Checking the Inverter for Damage during Compressor Operation](page 267) [8-9-11 Checking the Installation Conditions](page 271) Check the IGBT module resistance value of the INV board, if no problems are found. [8-9-15 Troubleshooting Problems with IGBT Module](page 273)
(2) The model selection switches (SW5-3 - 5-8) on the outdoor unit are set incorrectly.	Check the setting for the model selection switch on the outdoor unit (Dipswitches SW5-3 - 5-8 on the outdoor unit control board). For switch settings, refer to the following page(s). [7-9-2 Error Code [7101]](page 227)

**In the case of 4255 and 4256**

Cause	Check method and remedy
(1) Fan motor abnormality	Refer to the following page(s). [8-9-7 Checking the Fan Motor for Ground Fault and Coil Resistance Problems](page 269)
(2) Fan board failure	Refer to the following page(s). [8-9-8 Checking the Fan Board Error Detection Circuit at No Load](page 269) [8-9-9 Checking the Fan Inverter for Damage at No Load](page 270) [8-9-10 Checking the Fan Inverter for Damage with Load](page 271)

**Note**

For inverter-related error codes, refer to the following page(s). [8-9 Troubleshooting Inverter Problems](page 264)

## 7-6-19 Error Codes [4250, 4255, 4256] Detail Code 104

### 1. Error code definition

**Short-circuited IPM/Ground fault (Detail code 104)**

### 2. Error definition and error detection method

When IPM/IGBT short damage or grounding on the load side is detected just before starting the inverter.

### 3. Cause, check method and remedy

**In the case of 4250**

Cause	Check method and remedy
(1) Grounding fault compressor	Refer to the following page(s). [8-9-3 Checking the Compressor for Ground Fault and Coil Resistance Problems](page 266)
(2) Inverter output related	Refer to the following page(s). [8-9-2 Checking the Inverter Board Error Detection Circuit](page 266) [8-9-3 Checking the Compressor for Ground Fault and Coil Resistance Problems](page 266) [8-9-4 Checking the Inverter for Damage at No-Load](page 266) [8-9-5 Checking the Inverter for Damage during Compressor Operation](page 267) [8-9-11 Checking the Installation Conditions](page 271)

**In the case of 4255 and 4256**

Cause	Check method and remedy
(1) Grounding fault of fan motor	Refer to the following page(s). [8-9-7 Checking the Fan Motor for Ground Fault and Coil Resistance Problems](page 269)
(2) Fan board failure	Refer to the following page(s). [8-9-8 Checking the Fan Board Error Detection Circuit at No Load](page 269) [8-9-9 Checking the Fan Inverter for Damage at No Load](page 270) [8-9-10 Checking the Fan Inverter for Damage with Load](page 271)

#### Note

For inverter-related error codes, refer to the following page(s). [8-9 Troubleshooting Inverter Problems](page 264)

## 7-6-20 Error Codes [4250, 4255, 4256] Detail Code 105

**1. Error code definition**

**Overcurrent error due to short-circuited motor (Detail code 105)**

**2. Error definition and error detection method**

When a short is detected on the load side just before starting the inverter operation.

**3. Cause, Check method and remedy**

**In the case of 4250**

Cause	Check method and remedy
(1) Short - circuited compressor	Refer to the following page(s). [8-9-3 Checking the Compressor for Ground Fault and Coil Resistance Problems](page 266)
(2) Output wiring	Check for a short circuit.

**In the case of 4255 and 4256**

Cause	Check method and remedy
(1) Short - circuited fan motor	Refer to the following page(s). [8-9-7 Checking the Fan Motor for Ground Fault and Coil Resistance Problems](page 269)
(2) Output wiring	Check for a short circuit.

**Note**

For inverter-related error codes, refer to the following page(s). [8-9 Troubleshooting Inverter Problems](page 264)

## 7-6-21 Error Code [4250] Detail Codes 106 and 107

**1. Error code definition**

**Instantaneous overcurrent (Detail code 106)**

**Overcurrent (effective value) (Detail code 107)**

**2. Error definition and error detection method**

When a current above the specified value is detected by the electric current sensor.

Refer to the relevant pages for the details of model names and the specified values.

**3. Cause, check method and remedy**

Cause	Check method and remedy
(1) Inverter output related	Refer to the following page(s). [8-9-2 Checking the Inverter Board Error Detection Circuit](page 266) [8-9-3 Checking the Compressor for Ground Fault and Coil Resistance Problems](page 266) [8-9-4 Checking the Inverter for Damage at No-Load](page 266) [8-9-5 Checking the Inverter for Damage during Compressor Operation](page 267) [8-9-11 Checking the Installation Conditions](page 271) Check the IGBT module resistance value of the INV board, if no problems are found. [8-9-15 Troubleshooting Problems with IGBT Module](page 273)
(2) The model selection switches (SW5-3 - 5-8) on the outdoor unit are set incorrectly.	Check the setting for the model selection switch on the outdoor unit (Dipswitches SW5-3 - 5-8 on the outdoor unit control board). For switch settings, refer to the following page(s). [7-9-2 Error Code [7101]](page 227)

**Note**

For inverter-related error codes, refer to the following page(s). [8-9 Troubleshooting Inverter Problems](page 264)

## 7-6-22 Error Code [4250] Detail Codes 121, 128, and 122

**1. Error code definition**

DCL overcurrent error (H/W) (Detail code 121 and 128)(outdoor unit) DCL overcurrent error (S/W) (Detail code 122) (outdoor unit)

**2. Error definition and error detection method**

When a DCL overcurrent is detected by the electric current sensor

**3. Cause, check method and remedy**

Cause	Check method and remedy
(1) Inverter-output-related items	Refer to the following page(s). [8-9-2 Checking the Inverter Board Error Detection Circuit](page 266)  Refer to the following page(s). [8-9-3 Checking the Compressor for Ground Fault and Coil Resistance Problems](page 266)  Refer to the following page(s). [8-9-4 Checking the Inverter for Damage at No-Load](page 266)  Refer to the following page(s). [8-9-5 Checking the Inverter for Damage during Compressor Operation](page 267)  Refer to the following page(s). [8-9-11 Checking the Installation Conditions](page 271)

**Note**

For inverter-related error codes, refer to the following page(s). [8-9 Troubleshooting Inverter Problems](page 264)

## 7-6-23 Error Code [4260]

**1. Error code definition**

Heatsink overheat protection at startup

**2. Error definition and error detection method**

When heatsink temperature (THHS) remains at or above TOH for 10 minutes or longer after inverter startup

models	TOH
INV20Y	105°C
INV30YC	94°C

**3. Cause, check method and remedy**

Same as 4230 error

## 7-7 Error Code Definitions and Solutions: Codes [5000 - 5999]

### 7-7-1 Error Codes [5101, 5102, 5103, 5104]

#### 1. Error code definition

##### 5101

Return air temperature sensor (TH21) fault (Indoor unit)  
Return air temperature sensor (TH4) fault (OA processing unit)

##### 5102

Pipe temperature sensor (TH22) fault (Indoor unit)  
Pipe temperature sensor (TH2) fault (OA processing unit)

##### 5103

Gas-side pipe temperature sensor (TH23) fault (Indoor unit)  
Gas-side pipe temperature sensor (TH3) fault (OA processing unit)

##### 5104

Intake air temperature sensor (TH1) fault (OA processing unit)  
Intake air temperature sensor (TH24) fault (All-fresh (100% outdoor air) type indoor unit)

#### 2. Error definition and error detection method

•If a short or an open is detected during thermostat ON, the outdoor unit turns to anti-restart mode for 3 minutes. When the error is not restored after 3 minutes (if restored, the outdoor unit runs normally), the outdoor unit makes an error stop.

Short: detectable at 90°C [194°F] or higher

Open: detectable at -40°C [-40°F] or lower

•Sensor error at gas-side cannot be detected under the following conditions.

\*During heating operation

\*During cooling operation for 3 minutes after the compressor turns on.

#### 3. Cause, check method and remedy

Cause		Check method and remedy
(1)	Thermistor failure	Check the thermistor resistor.
(2)	Connector contact failure	0°C [32°F]: 15 kΩ
(3)	Disconnected wire or partial disconnected thermistor wire	10°C [50°F]: 9.7 kΩ
(4)	Unattached thermistor or contact failure	20°C [68°F]: 6.4 kΩ
(5)	Indoor board (detection circuit) failure	30°C [86°F]: 4.3 kΩ
		40°C [104°F]: 3.1 kΩ
		Check the connector contact.
		When no fault is found, the indoor board is a failure.

## **7-7-2 Error Codes [5102,5103,5104,5105,5106,5107,5109,5111]**

---

### **1. Error code definition**

**5102**

**HIC bypass circuit outlet temperature sensor (TH2) fault (Outdoor unit)**

**5103**

**Heat exchanger outlet temperature sensor (TH3) fault (Outdoor unit)**

**5104**

**Discharge temperature sensor (TH4) fault (Outdoor unit)**

**5105**

**Accumulator inlet temperature sensor (TH5) fault (Outdoor unit)**

**5106**

**HIC circuit outlet temperature sensor (TH6) fault (Outdoor unit)**

**5107**

**Outside temperature sensor (TH7) fault (Outdoor unit)**

**5109**

**Continuous heating temperature sensor (TH9) fault (outdoor unit)**

**5111**

**Continuous heating temperature sensor (TH11) fault (outdoor unit)**

### **2. Error definition and error detection method**

- When a short (high temperature intake) or an open (low temperature intake) of the thermistor is detected (the first detection), the outdoor unit stops, turns to anti-restart mode for 3 minutes, and restarts when the detected temperature of the thermistor.
- When a short or an open is detected again (the second detection) after the first restart of the outdoor unit, the outdoor unit stops, turns to anti-restart mode for 3 minutes, and restarts in 3 minutes when the detected temperature is within the normal range.
- When a short or an open is detected again (the third detection) after the previous restart of the outdoor unit, the outdoor unit makes an error stop.
- When a short or an open of the thermistor is detected just before the restart of the outdoor unit, the outdoor unit makes an error stop, and the error code "5102", "5103", "5104", "5105", "5106" or "5107" will appear.
- During 3-minute antirestart mode, preliminary errors will be displayed on the LED display.
- A short or an open described above is not detected for 10 minutes after the compressor start, during defrost mode, or for 3 minutes after defrost mode.



**3. Cause, check method and remedy**

Cause	Check method and remedy
(1) Thermistor failure	Check thermistor resistance.
(2) Pinched lead wire	Check for pinched lead wire.
(3) Torn wire coating	Check for wire coating.
(4) A pin on the male connector is missing or contact failure	Check connector.
(5) Disconnected wire	Check for wire.
(6) Thermistor input circuit failure on the control board	Check the intake temperature of the sensor with the LED monitor. When the temperature is far different from the actual temperature, replace the control board.

<Reference>

	Short detection	Open detection
TH2	70°C [158°F] and above (0.4kΩ)	-40°C [-40°F] and below (130kΩ)
TH3	110°C [230°F] and above (0.4kΩ)	-40°C [-40°F] and below (130kΩ)
TH4	240°C [464°F] and above (0.57kΩ)	0°C [32°F] and below (698kΩ)
TH5	70°C [158°F] and above (0.4kΩ)	-40°C [-40°F] and below (130kΩ)
TH6	70°C [158°F] and above (1.14kΩ)	-40°C [-40°F] and below (130kΩ)
TH7	110°C [230°F] and above (0.4kΩ)	-40°C [-40°F] and below (130kΩ)
TH9	160°C [320°F] and above (0.18kΩ)	-40°C [-40°F] and below (130kΩ)
TH11	160°C [320°F] and above (0.18kΩ)	-40°C [-40°F] and below (130kΩ)

**7-7-3 Error Code [5110]**

**1. Error code definition**

**Heatsink temperature sensor (THHS) fault (Detail code 01)**

**2. Error definition and error detection method**

When a short or an open of THHS is detected just before or during the inverter operation.

**3. Cause, check method and remedy**

Cause	Check method and remedy
(1) INV board failure	If the problem recurs when the unit is put into operation, replace the INV board.

**Note**

For inverter-related error codes, refer to the following page(s). [8-9 Troubleshooting Inverter Problems](page 264)

## 7-7-4 Error Code [5120]

### 1. Error code definition

**DCL temperature sensor circuit fault (Detail code 01)(outdoor unit)**

### 2. Error definition and error detection method

When an open phase or a short circuit of the temperature sensor is detected immediately before inverter startup or during operation (applicable to INV30YC only)

### 3. Cause, check method and remedy

INV30YC

Cause	Check method and remedy
(1) Contact failure	Check the connector (CNTH) on the inverter board for proper connection.
(2) DCL temperature sensor	Disconnect the connector (CNTH), check the resistance value of the DCL temperature sensor, and replace the DCL if the difference is significant.[3-3 Functions of the Major Components of Outdoor Unit](page 61)
(3) INV board failure	If the problem persists after restart operation, replace the inverter board.

#### Note

For inverter-related error codes, refer to the following page(s). [8-9 Troubleshooting Inverter Problems](page 264)

## 7-7-5 Error Code [5201]

### 1. Error code definition

**High-pressure sensor fault (63HS1)**

### 2. Error definition and error detection method

- If the high pressure sensor detects 0.098MPa [14psi] or less during the operation, the outdoor unit stops once, turns to anti-restart mode for 3 minutes, and restarts after 3 minutes when the detected high pressure sensor is 0.098MPa [14psi] or more.
- If the high pressure sensor detects 0.098MPa [14psi] or less just before the restart, the outdoor unit makes an error stop, and the error code "5201" will appear.
- During 3-minute antirestart mode, preliminary errors will be displayed on the LED display.
- A error is not detected for 3 minutes after the compressor start, during defrost operation, or 3 minutes after defrost operation.

### 3. Cause, check method and remedy

Cause	Check method and remedy
(1) High pressure sensor failure	Refer to the following page(s). [8-5-1 Comparing the High-Pressure Sensor Measurement and Gauge Pressure](page 253)
(2) Pressure drop due to refrigerant leak	
(3) Torn wire coating	
(4) A pin on the male connector is missing or contact failure	
(5) Disconnected wire	
(6) High pressure sensor input circuit failure on the control board	

## 7-7-6 Error Code [5301] Detail Code 115

### 1. Error code definition

**ACCT sensor fault (Detail code 115)**

### 2. Error definition and error detection method

When the formula "output current < 1.5 Arms" remains satisfied for 10 seconds while the inverter is in operation.

### 3. Cause, check method and remedy

Cause	Check method and remedy
(1) Inverter open output phase	Check the output wiring connections.
(2) Compressor failure	Refer to the following page(s). [8-9-3 Checking the Compressor for Ground Fault and Coil Resistance Problems](page 266)
(3) INV board failure	Refer to the following page(s). [8-9-2 Checking the Inverter Board Error Detection Circuit](page 266) [8-9-4 Checking the Inverter for Damage at No-Load](page 266) [8-9-5 Checking the Inverter for Damage during Compressor Operation](page 267)

#### Note

For inverter-related error codes, refer to the following page(s). [8-9 Troubleshooting Inverter Problems](page 264)

## 7-7-7 Error Code [5301] Detail Code 117

### 1. Error code definition

**ACCT sensor circuit fault (Detail code 117)**

### 2. Error definition and error detection method

When an error value is detected with the ACCT detection circuit just before the inverter starts

### 3. Cause, check method and remedy

Cause	Check method and remedy
(1) INV board failure	Refer to the following page(s). [8-9-2 Checking the Inverter Board Error Detection Circuit](page 266) [8-9-4 Checking the Inverter for Damage at No-Load](page 266) [8-9-5 Checking the Inverter for Damage during Compressor Operation](page 267)
(2) Compressor failure	Refer to the following page(s). [8-9-3 Checking the Compressor for Ground Fault and Coil Resistance Problems](page 266)

#### Note

For inverter-related error codes, refer to the following page(s). [8-9 Troubleshooting Inverter Problems](page 264)

## 7-7-8 Error Code [5301] Detail Code 119

**1. Error code definition**

**Open-circuited IPM/Loose ACCT connector (Detail code 119)**

**2. Error definition and error detection method**

Presence of enough current cannot be detected during the self-diagnostic operation immediately before inverter startup.

**3. Cause, check method and remedy**

Cause	Check method and remedy
(1) Inverter output wiring problem	Check output wiring connections. Confirm that the U- and W-phase output cables are put through CT12 and CT22 on the INV board respectively.
(2) Inverter failure	Refer to the following page(s). [8-9-4 Checking the Inverter for Damage at No-Load](page 266) [8-9-5 Checking the Inverter for Damage during Compressor Operation](page 267)
(3) Compressor failure	Refer to the following page(s). [8-9-3 Checking the Compressor for Ground Fault and Coil Resistance Problems](page 266)
(4) Connector contact failure (INV30YC only)	Check the connection of connector CN10.

**Note**

For inverter-related error codes, refer to the following page(s). [8-9 Troubleshooting Inverter Problems](page 264)

## 7-7-9 Error Code [5301] Detail Code 120

**1. Error code definition**

**Faulty ACCT wiring (Detail code 120)**

**2. Error definition and error detection method**

Presence of target current cannot be detected during the self-diagnostic operation immediately before startup. (Detection of improperly mounted ACCT sensor)

**3. Cause, check method and remedy**

Cause	Check method and remedy
(1) Inverter output wiring problem	Check output wiring connections. Confirm that the U- and W-phase output cables are put through CT12 and CT22 on the INV board respectively.
(2) Inverter failure	Refer to the following page(s). [8-9-4 Checking the Inverter for Damage at No-Load](page 266) [8-9-5 Checking the Inverter for Damage during Compressor Operation](page 267)
(3) Compressor failure	Refer to the following page(s). [8-9-3 Checking the Compressor for Ground Fault and Coil Resistance Problems](page 266)

**Note**

For inverter-related error codes, refer to the following page(s). [8-9 Troubleshooting Inverter Problems](page 264)

## 7-7-10 **Error Code [5301] Detail Code 127**

### 1. Error code definition

**DCL electric current circuit error (Detail code 127)(outdoor unit)**

### 2. Error definition and error detection method

When an abnormal value in the DCL electric current sensor detection circuit is detected

### 3. Cause, check method and remedy

Cause	Check method and remedy
(1) Contact failure	Check the wiring between CNCT4A and CNCT4B.
(2) Incorrect installation	Check the wiring on the SC-L terminal.
(3) INV board failure	If the problem persists after restart operation, replace the inverter board.

#### Note

For inverter-related error codes, refer to the following page(s). [8-9 Troubleshooting Inverter Problems](page 264)

## 7-7-11 **Error Codes [5305, 5306] Detail Code 132**

### 1. Error code definition

**Position detection error at startup (Detail code 132)**

### 2. Error definition and error detection method

When a motor sensor has detected an error within 10 seconds after the fan motor has gone into operation.

### 3. Cause, check method and remedy

Cause	Check method and remedy
(1) Contact failure and faulty fan motor wiring	Check the fan board connector CNINV and CNSNR for proper contacts. Check the wirign between the fan motor and fan board.
(2) Fan board failure	Refer to the following page(s). [8-9-10 Checking the Fan Inverter for Damage with Load](page 271)
(3) Fan motor error	Refer to the following page(s). [8-9-7 Checking the Fan Motor for Ground Fault and Coil Resistance Problems](page 269)

#### Note

For inverter-related error codes, refer to the following page(s). [8-9 Troubleshooting Inverter Problems](page 264)

## 7-7-12 Error Codes [5305, 5306] Detail Code 133

**1. Error code definition**  
**Position detection error during operation (Detail code 133)**

**2. Error definition and error detection method**  
 An error from a motor sensor is detected during fan moter operation.

**3. Cause, check method and remedy**

Cause	Check method and remedy
(1) Outdoor factors	Check that there is no wind (gust or strong wind).
(2) Contact failure and faulty fan motor wiring	Check the fan board connector CNINV and CNSNR for proper contacts. Check the wirign between the fan motor and fan board.
(3) Fan board failure	Refer to the following page(s). [8-9-9 Checking the Fan Inverter for Damage at No Load](page 270) [8-9-10 Checking the Fan Inverter for Damage with Load](page 271)
(4) Fan motor error	Refer to the following page(s). [8-9-7 Checking the Fan Motor for Ground Fault and Coil Resistance Problems](page 269)

**Note**  
 For inverter-related error codes, refer to the following page(s). [8-9 Troubleshooting Inverter Problems](page 264)

## 7-7-13 Error Codes [5305, 5306] Detail Code 134

**1. Error code definition**  
**RPM error before start up (Detail code 134)**

**2. Error definition and error detection method**  
 The fan RPM will not drop to the set RPM.

**3. Cause, check method and remedy**

Cause	Check method and remedy
(1) Outdoor factors	Check that there is no wind (gust or strong wind).
(2) Fan board failure	Refer to the following page(s). [8-9-9 Checking the Fan Inverter for Damage at No Load](page 270) [8-9-10 Checking the Fan Inverter for Damage with Load](page 271)
(3) Fan motor error	Refer to the following page(s). [8-9-7 Checking the Fan Motor for Ground Fault and Coil Resistance Problems](page 269)

**Note**  
 For inverter-related error codes, refer to the following page(s). [8-9 Troubleshooting Inverter Problems](page 264)

## 7-7-14 Error Code [5701]

**1. Error code definition**  
**Loose float switch connector**

**2. Error definition and error detection method**  
 Detection of the disconnected float switch (open-phase condition) during operation

**3. Cause, check method and remedy**

**(1) CN4F disconnection or contact failure**  
 Check for disconnection of the connector (CN4F) on the indoor unit control board.

---

## **7-8 Error Code Definitions and Solutions: Codes [6000 - 6999]**

---

### **7-8-1 Error Code [6201]**

---

---

**1. Error code definition**

**Remote controller board fault (nonvolatile memory error)**

**2. Error definition and error detection method**

This error is detected when the data cannot be read out from the built-in nonvolatile memory on the remote controller.

**3. Cause, check method and remedy**

**(1) Remote controller failure**

Replace the remote controller.

### **7-8-2 Error Code [6202]**

---

---

**1. Error code definition**

**Remote controller board fault (clock IC error)**

**2. Error definition and error detection method**

This error is detected when the built-in clock on the remote controller is not properly functioning.

**3. Cause, check method and remedy**

**(1) Remote controller failure**

Replace the remote controller.

### 7-8-3 Error Code [6600]

1. Error code definition  
Address overlap

2. Error definition and error detection method

An error in which signals from more than one indoor units with the same address are received

**Note**

The address and attribute that appear on the remote controller indicate the controller that detected the error.

3. Cause, check method and remedy

Cause	Check method and remedy
(1) Two or more of the following have the same address: Outdoor units, indoor units, LOSSNAY units, controllers such as ME remote controllers. <Example> 6600 "01" appears on the remote controller Unit #01 detected the error. Two or more units in the system have 01 as their address.	♦Find the unit that has the same address as that of the error source. <b>Once the unit is found, correct the address. Then, turn off the outdoor units, indoor units, and LOSSNAY units, keep them all turned off for at least five minutes, and turn them back on.</b> ♦When air conditioning units are operating normally despite the address overlap error Check the transmission wave shape and noise on the transmission line. See the section "Investigation of Transmission Wave Shape/Noise."
(2) Signals are distorted by the noise on the transmission line.	

### 7-8-4 Error Code [6601]

1. Error code definition  
Polarity setting error

2. Error definition and error detection method

The error detected when transmission processor cannot distinguish the polarities of the M-NET transmission line.

3. Cause, check method and remedy

Cause	Check method and remedy
(1) No voltage is applied to the M-NET transmission line that AG-150A/GB-50ADA/PAC-YG50ECA/BAC-HD150 are connected to.	Check if power is supplied to the M-NET transmission line of the AG-150A/GB-50ADA/PAC-YG50ECA/BAC-HD150, and correct any problem found.
(2) M-NET transmission line to which AG-150A/GB-50ADA/PAC-YG50ECA/BAC-HD150 are connected is short-circuited.	
(3) When two or more power supplies are connected to the M-NET	



## 7-8-5 Error Code [6602]

### 1. Error code definition

Transmission processor hardware error

### 2. Error definition and error detection method

Although "0" was surely transmitted by the transmission processor, "1" is displayed on the transmission line.

#### Note

The address/attribute appeared on the display on the remote controller indicates the controller where an error occurred.

### 3. Cause

- 1) When the wiring work of or the polarity of either the indoor or outdoor transmission line is performed or is changed while the power is on, the transmitted data will collide, the wave shape will be changed, and an error will be detected.
- 2) Grounding fault of the transmission line
- 3) When grouping the indoor units that are connected to different outdoor units, the male power supply connectors on the multiple outdoor units are connected to the female power supply switch connector (CN40).
- 4) When the power supply unit for transmission lines is used in the system connected with MELANS, the male power supply connector is connected to the female power supply switch connector (CN40) on the outdoor unit.
- 5) Controller failure of the source of the error
- 6) When the transmission data is changed due to the noise on the transmission line
- 7) Voltage is not applied on the transmission line for centralized control (in case of grouped indoor units connected to different outdoor units or in case of the system connected with MELANS)

### 4. Check method and remedy

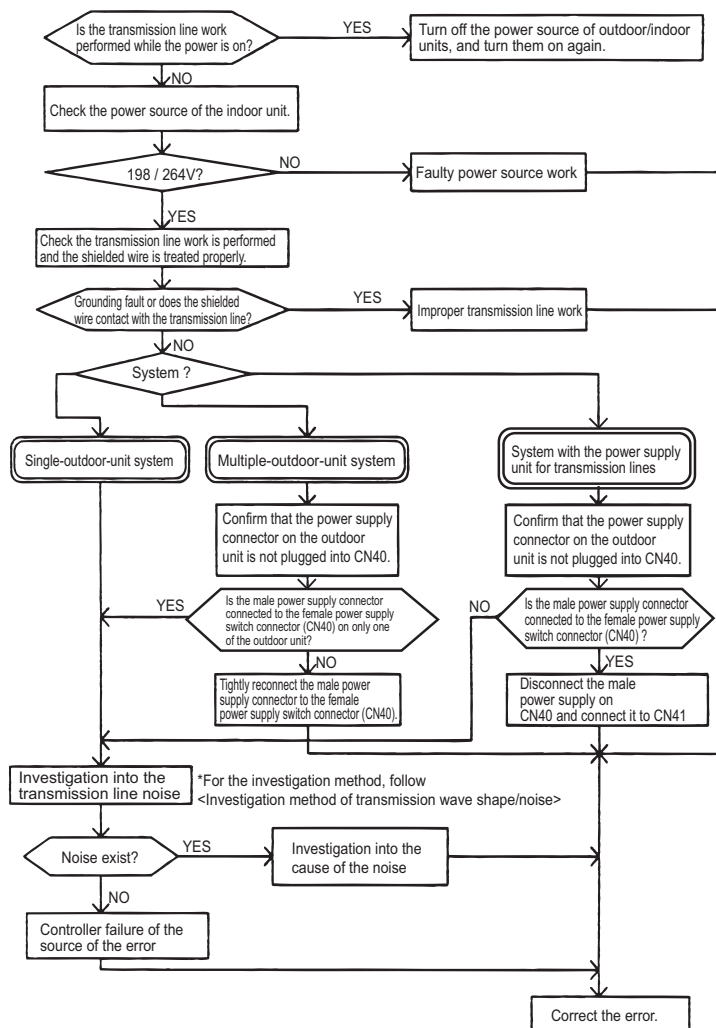

## 7-8-6 Error Code [6603]

### 1. Error code definition

Transmission line bus busy error

### 2. Error definition and error detection method

- Generated error when the command cannot be transmitted for 4-10 minutes in a row due to bus-busy
- Generated error when the command cannot be transmitted to the transmission line for 4-10 minutes in a row due to noise

#### Note

The address/attribute appeared on the display on the remote controller indicates the controller where an error occurred.

### 3. Cause, check method and remedy

Cause		Check method and remedy
(1)	The transmission processor cannot be transmitted as the short-wavelength voltage like noise exists consecutively on the transmission line.	Check the transmission wave shape and noise on the transmission line. See the section "Investigation of Transmission Wave Shape/Noise." → No noise indicates that the error source controller is a failure. → If noise exists, investigate the noise.
(2)	Error source controller failure	

## 7-8-7 Error Code [6606]

### 1. Error code definition

Communication error between device and transmission processors

### 2. Error definition and error detection method

Communication error between the main microcomputer on the indoor unit board and the microcomputer for transmission

#### Note

The address/attribute appeared on the display on the remote controller indicates the controller where an error occurred.

### 3. Cause, check method and remedy

Cause		Check method and remedy
(1)	Data is not properly transmitted due to accidental erroneous operation of the controller of the error source.	Turn off the power source of the outdoor and the indoor units. (When the power source is turned off separately, the microcomputer will not be reset, and the error will not be corrected.) → If the same error occurs, the error source controller is a failure.
(2)	Error source controller failure	

## 7-8-8 Error Code [6607] Error Source Address = Outdoor Unit (OC)

### 1. Error code definition

No ACK error

### 2. Error definition and error detection method

The error is detected when no acknowledgement (ACK signal) is received after the transmission. (eg. When the data is transmitted six times in a row with 30 seconds interval, the error is detected on the transmission side.)

#### Note

The address/attribute appeared on the display on the remote controller indicates the controller which did not provide the response (ACK).

### 3. Cause, check method and remedy

Cause		Check method and remedy	
(1)	Incidental cause	1)	Turn off the power source of the outdoor unit, and turn it on again.
(2)	Contact failure of transmission line of OC or IC	2)	If the error is accidental, it will run normally. If not, check the causes (2) - (5).
(3)	Decrease of transmission line voltage/signal by exceeding acceptable range of transmission wiring. Farthest: 200 m [656ft] or less Remote controller wiring: 10m [32ft] or less		
(4)	Erroneous sizing of transmission line (Not within the range below). Wire diameter: 1.25mm <sup>2</sup> [AWG16] or more		
(5)	Outdoor unit control board failure		

## 7-8-9 Error Code [6607] Error Source Address = Indoor Unit (IC)

### 1. Error code definition No ACK error

### 2. Error definition and error detection method

The error is detected when no acknowledgement (ACK signal) is received after the transmission. (eg. When the data is transmitted six times in a row with 30 seconds interval, the error is detected on the transmission side.)

**Note**

The address/attribute appeared on the display on the remote controller indicates the controller which did not provide the response (ACK).

### 3. Cause, check method and remedy

**Error display**

ME remote controller (RC), MA remote controller (MA)

**Types of refrigerant systems**

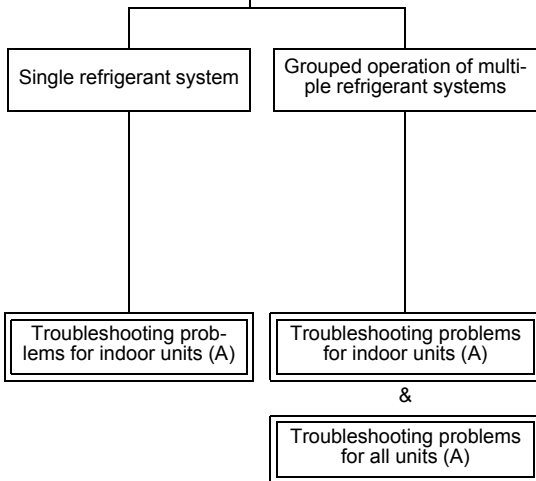

System controller (SC)

**Types of indoor units experiencing problems**

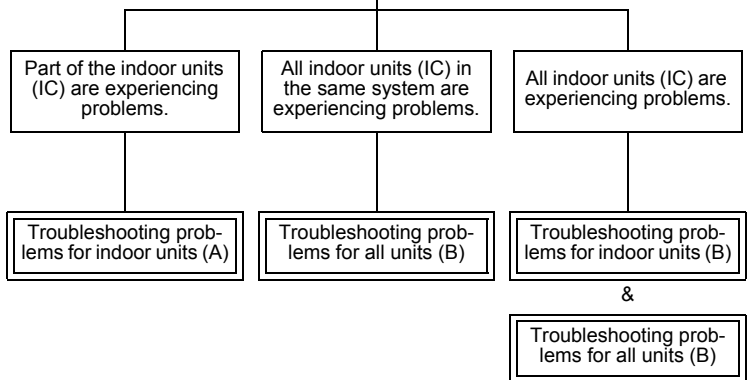

#### (1) Troubleshooting problems for indoor units (A)

Cause	Check method and remedy
(1) Incidental cause	1) Turn off the outdoor/indoor units for 5 or more minutes, and turn them on again.
(2) When IC unit address is changed or modified during operation.	2) If the error is accidental, it will run normally. If not, check the causes (2) - (6).
(3) Faulty or disconnected IC transmission wiring	
(4) Disconnected IC connector (CN2M)	
(5) Indoor unit controller failure	
(6) ME remote controller failure	

#### (2) Troubleshooting problems for indoor units (B)

Cause	Check method and remedy
(1) When the power supply unit for transmission lines is used and the male power supply connector is connected to the female power supply switch connector (CN40) for the transmission line for centralized control	1) Check voltage of the transmission line for centralized control. •20 V or more: Check (1) on the left. •Less than 20 V: Check (2) on the left.
(2) Disconnection or shutdown of the power source of the power supply unit for transmission line	
(3) System controller (MELANS) malfunction	2) Check the causes of the error indicated by the error codes listed in items (1) through (3) in the "Cause" column.

## 7-8-10 Error Code [6607] Error Source Address = LOSSNAY (LC)

### 1. Error code definition No ACK error

### 2. Error definition and error detection method

The error is detected when no acknowledgement (ACK signal) is received after the transmission. (eg. When the data is transmitted six times in a row with 30 seconds interval, the error is detected on the transmission side.)

#### Note

The address/attribute appeared on the display on the remote controller indicates the controller which did not provide the response (ACK).

### 3. Cause, check method and remedy

#### Error display

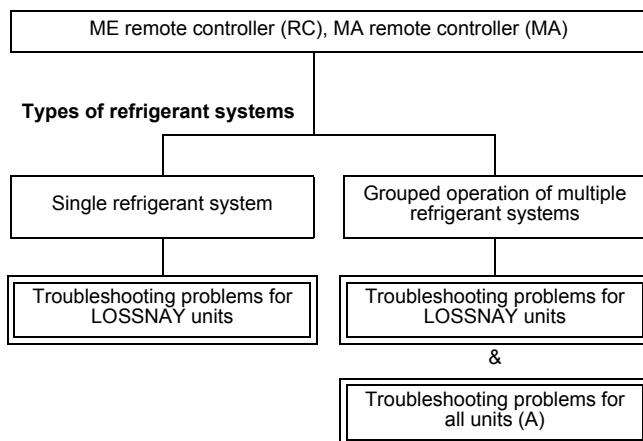

#### (1) Troubleshooting problems for LOSSNAY units

Cause	Check method and remedy
(1) Incidental cause	1) Turn off the power source of LOSSNAY and turn it on again.
(2) The power source of LOSSNAY has been shut off.	2) If the error is accidental, it will run normally.
(3) When the address of LOSSNAY is changed in the middle of the operation	If not, check the causes (2) - (6).
(4) Faulty or disconnected transmission wiring of LOSSNAY	
(5) Disconnected connector (CN1) on LOSSNAY	
(6) Controller failure of LOSSNAY	

## 7-8-11 Error Code [6607] Error Source Address = ME Remote Controller

### 1. Error code definition No ACK error

### 2. Error definition and error detection method

The error is detected when no acknowledgement (ACK signal) is received after the transmission. (eg. When the data is transmitted six times in a row with 30 seconds interval, the error is detected on the transmission side.)

**Note**

The address/attribute appeared on the display on the remote controller indicates the controller which did not provide the response (ACK).

### 3. Cause, check method and remedy

**Error display**

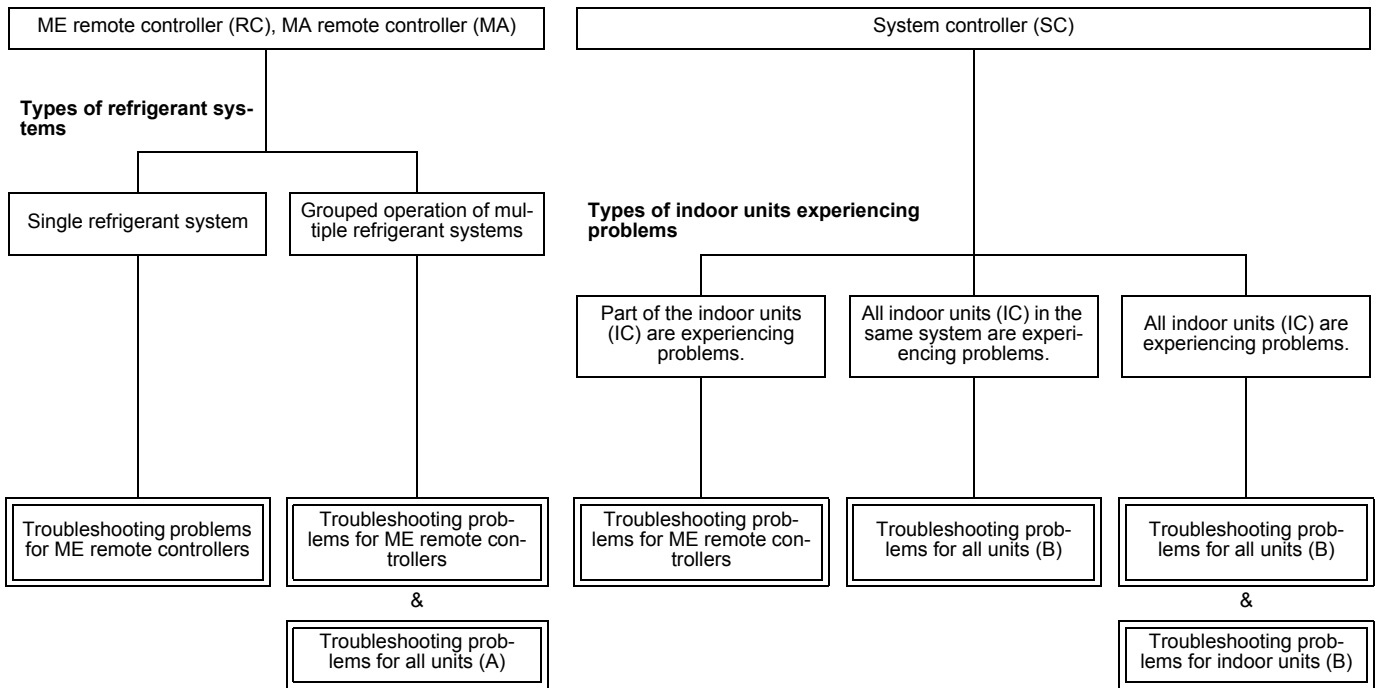

#### (1) Troubleshooting problems for ME remote controllers

Cause	Check method and remedy
(1) Incidental cause	1) Turn off the power source of the outdoor unit for 5 minutes or more, and turn it on again.
(2) Faulty transmission wiring at IC unit side.	2) If not, check the causes (2) - (5).
(3) Faulty wiring of the transmission line for ME remote controller	
(4) When the address of ME remote controller is changed in the middle of the operation	
(5) ME remote controller failure	

## 7-8-12 Error Code [6607] Error Source Address = System Controller

### 1. Error code definition

**No ACK error**

### 2. Error definition and error detection method

The error is detected when no acknowledgement (ACK signal) is received after the transmission. (eg. When the data is transmitted six times in a row with 30 seconds interval, the error is detected on the transmission side.)

#### Note

The address/attribute appeared on the display on the remote controller indicates the controller which did not provide the response (ACK).

### 3. Cause, check method and remedy

#### Error display

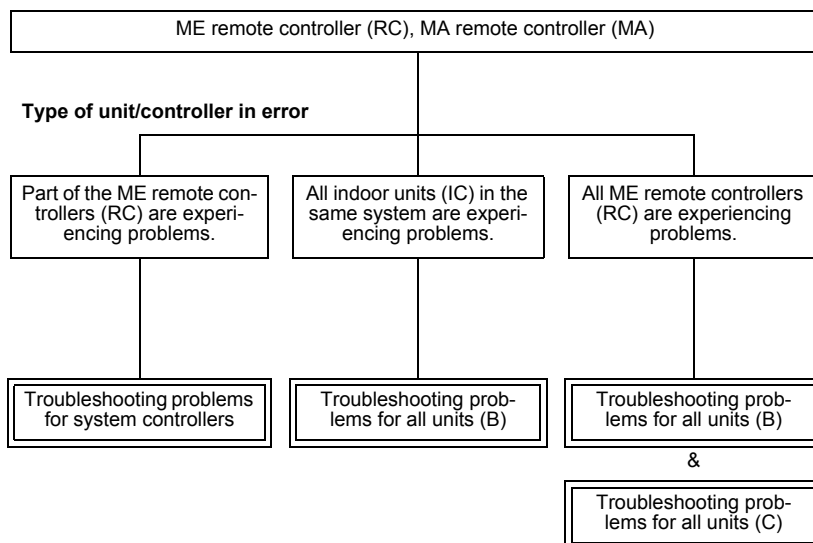

#### (1) Troubleshooting problems for system controllers

Cause		Check method and remedy	
(1)	Incidental cause	1)	Turn off the power source of the outdoor unit for 5 minutes or more, and turn it on again.
(2)	Faulty wiring of the transmission line for ME remote controller	2)	If not, check the causes (2) - (4).
(3)	When the address of ME remote controller is changed in the middle of the operation		
(4)	ME remote controller failure		

## 7-8-13 Error Code [6607] All Error Source Addresses

### 1. Error code definition

**No ACK error**

### 2. Error definition and error detection method

The error is detected when no acknowledgement (ACK signal) is received after the transmission. (eg. When the data is transmitted six times in a row with 30 seconds interval, the error is detected on the transmission side.)

#### Note

The address/attribute appeared on the display on the remote controller indicates the controller which did not provide the response (ACK).

### 3. Cause, check method and remedy

#### (1) Troubleshooting problems for all units (A)

Cause	Check method and remedy
(1) Disconnection or short circuit of the transmission line for the outdoor unit on the terminal block for centralized control line connection (TB7) (2) When multiple outdoor units are connected and the power source of one of the outdoor units has been shut off. (3) The male power supply connector of the outdoor unit is not connected to the female power supply switch connector (CN40). (4) The male power supply connectors on 2 or more outdoor units are connected to the female power supply switch connector (CN40) for centralized control.  If an error occurs, after the unit runs normally once, the following causes may be considered. ♦Total capacity error (7100) ♦Capacity code error (7101) ♦Error in the number of connected units (7102) ♦Address setting error (7105)	1) Check the causes of (1) - (4). If the cause is found, correct it. If no cause is found, check 2).  2) Check the LED displays for troubleshooting on other remote controllers whether an error occurs.  ♦When an error is present Check the causes of the error indicated by the error codes listed in item (4) in the "Cause" column.  ♦When no errors are present Indoor unit circuit board failure

#### (2) Troubleshooting problems for all units (B)

Cause	Check method and remedy
(1) Total capacity error (7100) (2) Capacity code error (7101) (3) Error in the number of connected units (7102) (4) Address setting error (7105) (5) Disconnection or short circuit of the transmission line for the outdoor unit on the terminal block for centralized control line connection (TB7) (6) Turn off the power source of the outdoor unit (7) Malfunction of electrical system for the outdoor unit	1) Check the LED display for troubleshooting on the outdoor unit.  ♦When an error is present Check the causes of the error indicated by the error codes listed in items (1) through (4) in the "Cause" column.  ♦When no errors are present Check the causes of the error indicated by the error codes listed in items (5) through (7) in the "Cause" column.

#### (3) Troubleshooting problems for all units (C)

Cause	Check method and remedy
(1) When the power supply unit for transmission lines is used and the male power supply connector is connected to the female power supply switch connector (CN40) for the transmission line for centralized control (2) Disconnection or shutdown of the power source of the power supply unit for transmission line (3) System controller (MELANS) malfunction	Check the causes of the error indicated by the error codes listed in items (1) through (3) in the "Cause" column.



## 7-8-14 Error Code [6607] No Error Source Address

### 1. Error code definition

**No ACK error**

### 2. Error definition and error detection method

The error is detected when no acknowledgement (ACK signal) is received after the transmission. (eg. When the data is transmitted six times in a row with 30 seconds interval, the error is detected on the transmission side.)

#### Note

**The address/attribute appeared on the display on the remote controller indicates the controller which did not provide the response (ACK).**

### 3. Cause, check method and remedy

Cause	Check method and remedy
<p>(1) Although the address of ME remote controller has been changed after the group is set using ME remote controller, the indoor unit is keeping the memory of the previous address. The same symptom will appear for the registration with SC.</p> <p>(2) Although the address of LOSSNAY has been changed after the interlock registration of LOSSNAY is made using ME remote controller, the indoor unit is keeping the memory of the previous address.</p>	<p>Delete unnecessary information of non-existing address which some indoor units have. Use either of the following two methods for deletion.</p> <p>1) Address deletion by ME remote controller Delete unnecessary address information using the manual setting function of ME remote controller. For details, refer to the following page(s). [6-3-4 Address Deletion](page 118)</p> <p>2) Deletion of connection information of the outdoor unit by the deleting switch</p> <p>Note that the above method will delete all the group settings set via the ME remote controller and all the interlock settings between LOSSNAY units and indoor units.</p> <p>Procedures</p> <ol style="list-style-type: none"> <li>1) Turn off the power source of the outdoor unit, and wait for 5 minutes.</li> <li>2) Turn on the dip switch (SW5-2) on the outdoor unit control board.</li> <li>3) Turn on the power source of the outdoor unit, and wait for 5 minutes.</li> <li>4) Turn off the power source of the outdoor unit, and wait for 5 minutes.</li> <li>5) Turn off the dip switch (SW5-2) on the outdoor unit control board.</li> <li>6) Turn on the power source of the outdoor unit.</li> </ol>

## 7-8-15 **Error Code [6608]**

---

### 1. Error code definition

**No response error**

### 2. Error definition and error detection method

- When no response command is returned although acknowledgement (ACK) is received after transmission, an error is detected.
- When the data is transmitted 10 times in a row with 3 seconds interval, an error is detected on the transmission side.

#### Note

**The address/attribute appeared on the display on the remote controller indicates the controller where an error occurred.**

### 3. Cause

- 1) The transmission line work is performed while the power is on, the transmitted data will collide, and the wave shape will be changed.
- 2) The transmission is sent and received repeatedly due to noise.
- 3) Decrease of transmission line voltage/signal by exceeding acceptable range of transmission wiring.  
Farthest: 200m [656ft] or less  
Remote controller wiring: 12m [39ft] or less
- 4) The transmission line voltage/signal is decreased due to erroneous sizing of transmission line.  
Wire diameter: 1.25mm<sup>2</sup>[AWG16] or more

### 4. Check method and remedy

- 1) When an error occurs during commissioning, turn off the power sources for the outdoor unit, indoor unit, and LOSSNAY for 5 or more minutes, and then turn them on again.
  - When they return to normal operation, the cause of the error is the transmission line work performed with the power on.
  - If an error occurs again, check the cause 2).
- 2) Check 3) and 4) above.
  - If the cause is found, correct it.
  - If no cause is found, check 3).
- 3) Check the transmission waveform, and check the transmission line for electrical noise. For details, refer to the following page(s). [8-4 Checking Transmission Waveform and for Electrical Noise Interference](page 250)  
**Noise is the most possible cause of the error "6608".**

## 7-8-16 **Error Code [6831]**

---

### 1. Error code definition

**MA controller signal reception error (No signal reception)**

### 2. Error definition and error detection method

- Communication between the MA remote controller and the indoor unit is not done properly.
- No proper data has been received for 3 minutes.

### 3. Cause

- 1) Contact failure of the remote controller lines of MA remote controller or the indoor unit.
- 2) All the remote controllers are set to SUB.
- 3) Failure to meet wiring regulations
  - Wire length
  - Wire size
  - Number of remote controllers
  - Number of indoor units
- 4) The remote controller is removed after the installation without turning the power source off.
- 5) Noise interference on the remote controller transmission lines
- 6) Faulty circuit that is on the indoor board and performs transmission/ reception of the signal from the remote controller
- 7) Problems with the circuit on the remote controller that sends or receives the signals from the remote controller

### 4. Check method and remedy

- 1) Check for disconnected or loose transmission lines for the indoor units or MA remote controllers.
- 2) Confirm that the power is supplied to the main power source and the remote controller line.
- 3) Confirm that MA remote controller's capacity limit is not exceeded.
- 4) Check the sub/main setting of the MA remote controllers. One of them must be set to MAIN.
- 5) Diagnose the remote controller (described in the remote controller installation manual).
  - [OK]: no problems with the remote controller (check the wiring regulations)
  - [NG]: Replace the MA remote controller.
  - [6832, 6833, ERC]: Due to noise interference <Go to 6>
- 6) Check the transmission waveform, and check the MA remote controller line for electrical noise. For details, refer to the following page(s). [8-4 Checking Transmission Waveform and for Electrical Noise Interference](page 250)
- 7) When no problems are found with items 1) through 6), replace the indoor unit board or the MA remote controller.

The following status can be confirmed on LED1 and 2 on the indoor unit board.

  - If LED1 is lit, the main power source of the indoor unit is turned on.
  - If LED2 is lit, the MA remote controller line is being powered.

## 7-8-17 **Error Code [6832]**

---

### 1. Error code definition

**MA remote controller signal transmission error (Synchronization error)**

### 2. Error definition and error detection method

- MA remote controller and the indoor unit is not done properly.
- Failure to detect opening in the transmission path and unable to send signals
  - \*Indoor unit: 3 minutes
  - \*Remote controller: 6 seconds

### 3. Cause

- 1) Contact failure of the remote controller lines of MA remote controller or the indoor unit
- 2) 2 or more remote controllers are set to MAIN
- 3) Overlapped indoor unit address
- 4) Noise interference on the remote controller lines
- 5) Failure to meet wiring regulations
  - Wire length
  - Wire size
  - Number of remote controllers
  - Number of indoor units
- 6) Problems with the circuit on the remote controller that sends or receives the signals from the remote controller

### 4. Check method and remedy

- 1) Check for disconnected or loose transmission lines for the indoor units or MA remote controllers.
- 2) Confirm that the power is supplied to the main power source and the remote controller line.
- 3) Confirm that MA remote controller's capacity limit is not exceeded.
- 4) Check the sub/main setting of the MA remote controllers. One of them must be set to MAIN.
- 5) Diagnose the remote controller (described in the remote controller installation manual).
  - [OK]: no problems with the remote controller (check the wiring regulations)
  - [NG]: Replace the MA remote controller.
  - [6832, 6833, ERC]: Due to noise interference <Go to 6>
- 6) Check the transmission waveform, and check the MA remote controller line for electrical noise. For details, refer to the following page(s). [8-4 Checking Transmission Waveform and for Electrical Noise Interference](page 250)
- 7) When no problems are found with items 1) through 6), replace the indoor unit board or the MA remote controller. The following status can be confirmed on LED1 and 2 on the indoor unit board.
  - If LED1 is lit, the main power source of the indoor unit is turned on.
  - If LED2 is lit, the MA remote controller line is being powered.

## 7-8-18 **Error Code [6833]**

---

### 1. Error code definition

**MA remote controller signal transmission error (Hardware error)**

### 2. Error definition and error detection method

- Communication between the MA remote controller and the indoor unit is not done properly.
- An error occurs when the transmitted data and the received data differ for 30 times in a row.

### 3. Cause

- 1) Contact failure of the remote controller lines of MA remote controller or the indoor unit
- 2) 2 or more remote controllers are set to MAIN
- 3) Overlapped indoor unit address
- 4) Noise interference on the remote controller lines
- 5) Failure to meet wiring regulations
  - Wire length
  - Wire size
  - Number of remote controllers
  - Number of indoor units
- 6) Problems with the circuit on the remote controller that sends or receives the signals from the remote controller

### 4. Check method and remedy

- 1) Check for disconnected or loose transmission lines for the indoor units or MA remote controllers.
- 2) Confirm that the power is supplied to the main power source and the remote controller line.
- 3) Confirm that MA remote controller's capacity limit is not exceeded.
- 4) Check the sub/main setting of the MA remote controllers. One of them must be set to MAIN.
- 5) Diagnose the remote controller (described in the remote controller installation manual).  
[OK]: no problems with the remote controller (check the wiring regulations)  
[NG]: Replace the MA remote controller.  
[6832, 6833, ERC]: Due to noise interference <Go to 6>
- 6) Check the transmission waveform, and check the MA remote controller line for electrical noise. For details, refer to the following page(s). [8-4 Checking Transmission Waveform and for Electrical Noise Interference](page 250)
- 7) When no problems are found with items 1) through 6), replace the indoor unit board or the MA remote controller.  
The following status can be confirmed on LED1 and 2 on the indoor unit board.
  - If LED1 is lit, the main power source of the indoor unit is turned on.
  - If LED2 is lit, the MA remote controller line is being powered.

## 7-8-19 **Error Code [6834]**

---

### 1. Error code definition

**MA controller signal reception error (Start bit detection error)**

### 2. Error definition and error detection method

- Communication between the MA remote controller and the indoor unit is not done properly.
- No proper data has been received for 2 minutes.

### 3. Cause

- 1) Contact failure of the remote controller lines of MA remote controller or the indoor unit.
- 2) All the remote controllers are set to SUB.
- 3) Failure to meet wiring regulations
  - Wire length
  - Wire size
  - Number of remote controllers
  - Number of indoor units
- 4) The remote controller is removed after the installation without turning the power source off.
- 5) Noise interference on the remote controller transmission lines
- 6) Faulty circuit that is on the indoor board and performs transmission/ reception of the signal from the remote controller
- 7) Problems with the circuit on the remote controller that sends or receives the signals from the remote controller

### 4. Check method and remedy

- 1) Check for disconnected or loose transmission lines for the indoor units or MA remote controllers.
- 2) Confirm that the power is supplied to the main power source and the remote controller line.
- 3) Confirm that MA remote controller's capacity limit is not exceeded.
- 4) Check the sub/main setting of the MA remote controllers. One of them must be set to MAIN.
- 5) Diagnose the remote controller (described in the remote controller installation manual).  
[OK]: no problems with the remote controller (check the wiring regulations)  
[NG]: Replace the MA remote controller.  
[6832, 6833, ERC]: Due to noise interference <Go to 6>
- 6) Check the transmission waveform, and check the MA remote controller line for electrical noise. For details, refer to the following page(s). [8-4 Checking Transmission Waveform and for Electrical Noise Interference](page 250)
- 7) When no problems are found with items 1) through 6), replace the indoor unit board or the MA remote controller.  
The following status can be confirmed on LED1 and 2 on the indoor unit board.
  - If LED1 is lit, the main power source of the indoor unit is turned on
  - If LED2 is lit, the MA remote controller line is being powered.

## 7-8-20 **Error Code [6840]**

### 1. Error code definition

**A control communication reception error**

### 2. Error definition and error detection method

Indoor/outdoor unit communication error (Signal receiving error)

- Abnormal if indoor controller board could not receive any signal normally for 6 minutes after turning the power on
- Abnormal if indoor controller board could not receive any signal normally for 3 minutes.
- Consider the unit as abnormal under the following condition. When 2 or more indoor units are connected to an outdoor unit, indoor controller board could not receive a signal for 3 minutes from outdoor controller circuit board, a signal which allows outdoor controller circuit board to transmit signals.

### 3. Cause, check method and remedy

Cause		Check method and remedy
(1)	Contact failure, short circuit or miswiring (converse wiring) of indoor/outdoor unit connecting wire.	Check disconnecting or looseness of indoor /outdoor unit connecting wire of indoor unit or outdoor unit. Check all the units in case of twin/triple/quadruple indoor unit system.
(2)	Defective transmitting receiving circuit of outdoor controller circuit board.	Turn the power off, and on again to check. If abnormality generates again, replace indoor controller board or outdoor controller circuit board.
(3)	Defective transmitting receiving circuit of indoor controller board.	
(4)	Noise has entered into indoor/outdoor unit connecting wire.	
(5)	Defective fan motor	Turn the power off, and detach fan motor from connector (CNF1, 2). Then turn the power on again. If abnormality is not displayed, replace fan motor. If abnormality is displayed, replace outdoor controller circuit board.
(6)	Defective rush current resistor of outdoor power circuit board	Check the rush current resistor on outdoor power circuit board with tester. If open is detected, replace the power circuit board.

Note: Refer also to the Service Handbook for the indoor units.

## 7-8-21 **Error Code [6841]**

### 1. Error code definition

**A control communication synchronism not recover**

### 2. Error definition and error detection method

Indoor/outdoor unit communication error (Transmitting error) (Outdoor unit)

- Abnormal if "0" receiving is detected 30 times continuously though outdoor controller circuit board has transmitted "1".
- Abnormal if outdoor controller circuit board could not find blank of transmission path for 3 minutes.

### 3. Cause, check method and remedy

Cause		Check method and remedy
(1)	Indoor/outdoor unit connecting wire has contact failure.	Check disconnection or looseness of indoor/ outdoor unit connecting wire.
(2)	Defective communication circuit of outdoor controller circuit board.	Turn the power off, and on again to check. Replace outdoor controller circuit board if abnormality is displayed again.
(3)	Noise has entered power supply.	
(4)	Noise has entered indoor/outdoor unit connecting wire.	

Note: Refer also to the Service Handbook for the indoor units.

## 7-8-22 **Error Code [6842]**

---

**1. Error code definition**

**A control communication transmission/reception hardware trouble**

**2. Error definition and error detection method**

Indoor/outdoor unit communication error (Transmitting error)

Abnormal if "1" receiving is detected 30 times continuously though indoor controller board has transmitted "0".

**3. Cause, check method and remedy**

Cause		Check method and remedy
(1)	Defective transmitting receiving circuit of indoor controller board	Turn the power off, and on again to check. If abnormality generates again, replace indoor controller board.
(2)	Noise has entered into power supply.	
(3)	Noise has entered into outdoor control wire.	

Note: Refer also to the Service Handbook for the indoor units.



## 7-8-23 Error Code [6843]

### 1. Error code definition

**A control communication start bit detection error**

### 2. Error definition and error detection method

Indoor/outdoor unit communication error (Signal receiving error)

- Abnormal if indoor controller board could not receive any signal normally for 6 minutes after turning the power on.
- Abnormal if indoor controller board could not receive any signal normally for 3 minutes.
- Consider the unit as abnormal under the following condition. When 2 or more indoor units are connected to an outdoor unit, indoor controller board could not receive a signal for 3 minutes from outdoor controller circuit board, a signal which allows outdoor controller circuit board to transmit signals.

### 3. Cause, check method and remedy

Cause	Check method and remedy
(1) Contact failure, short circuit or miswiring (converse wiring) of indoor/outdoor unit connecting wire	Check disconnecting or looseness of indoor /outdoor unit connecting wire of all indoor units or outdoor units.
(2) Defective transmitting receiving circuit of outdoor controller circuit board.	Turn the power off, and on again to check. If abnormality generates again, replace indoor controller board or outdoor controller circuit board. Note: other indoor controller board may have defect.
(3) Defective transmitting receiving circuit of indoor controller board.	
(4) Noise has entered into indoor/outdoor unit connecting wire.	
(5) Defective fan motor	Turn the power off, and detach fan motor from connector (CNF1, 2). Then turn the power on again. If abnormality is not displayed, replace fan motor. If abnormality is displayed, replace outdoor controller circuit board.
(6) Defective rush current resistor of outdoor power circuit board	Check the rush current resistor on outdoor power circuit board with tester. If open is detected, replace the power circuit board.

### 1. Error code definition

**A control communication start bit detection error**

### 2. Error definition and error detection method

Indoor/outdoor unit communication error (Signal receiving error)

(Outdoor unit)

Abnormal if outdoor controller circuit board could not receive anything normally for 3 minutes.

### 3. Cause, check method and remedy

Cause	Check method and remedy
(1) Contact failure of indoor/outdoor unit connecting wire	Check disconnection or looseness of indoor/outdoor unit connecting wire of indoor or outdoor units.
(2) Defective communication circuit of outdoor controller circuit board	Turn the power off, and on again to check. Replace indoor controller board or outdoor controller circuit board if abnormality is displayed again.
(3) Defective communication circuit of indoor controller board	
(4) Noise has entered into indoor/outdoor unit connecting wire.	

Note: Refer also to the Service Handbook for the indoor units.

## 7-8-24 **Error Code [6846]**

### 1. Error code definition

**Start-up time over**

### 2. Error definition and error detection method

Start-up time over The unit cannot finish start-up process within 4 minutes after power on.

### 3. Cause, check method and remedy

Cause	Check method and remedy
(1) Contact failure of indoor/outdoor unit connecting wire	Check disconnection or looseness or polarity of indoor/outdoor unit connecting wire of indoor and outdoor units.
(2) Diameter or length of indoor/outdoor unit connecting wire is out of specified capacity.	Check diameter and length of indoor/outdoor unit connecting wire. Total wiring length: 80 m (including wiring connecting each indoor unit and between indoor and outdoor unit) Also check if the connection order of flat cable is S1, S2, S3.
(3) 2 or more outdoor units have refrigerant address "0". (In case of group control)	Check if refrigerant addresses are overlapping in case of group control system.
(4) Noise has entered into power supply or indoor/outdoor unit connecting wire.	Check transmission path, and remove the cause. Note: The descriptions above, 1)-4), are for EA, Eb and EC. *The check code in the parenthesis indicates PAR-30MAA model.

Note: Refer also to the Service Handbook for the indoor units.

## 7-9 Error Code Definitions and Solutions: Codes [7000 - 7999]

### 7-9-1 Error Code [7100]

**1. Error code definition**

**Total capacity error**

**2. Error definition and error detection method**

The model total of indoor units in the system with one outdoor unit exceeds limitations.

**3. Error source, cause, check method and remedy,**

Error source	Cause	Check method and remedy																																																																																
Outdoor unit	<p>(1) The model total of indoor units in the system with one outdoor unit exceeds the following table.</p> <table border="1"> <thead> <tr> <th>Model</th> <th>Qj Total</th> </tr> </thead> <tbody> <tr><td>200 model</td><td>53</td></tr> <tr><td>250 model</td><td>69</td></tr> <tr><td>300 model</td><td>86</td></tr> <tr><td>350 model</td><td>96</td></tr> <tr><td>400 model</td><td>108</td></tr> <tr><td>450 model</td><td>121</td></tr> <tr><td>500 model</td><td>138</td></tr> <tr><td>550 model</td><td>155</td></tr> <tr><td>600 model</td><td>172</td></tr> <tr><td>650 model</td><td>177</td></tr> <tr><td>700 model</td><td>190</td></tr> <tr><td>750 model</td><td>207</td></tr> <tr><td>800 model</td><td>224</td></tr> <tr><td>850 model</td><td>241</td></tr> <tr><td>900 model</td><td>248</td></tr> <tr><td>950 model</td><td>254</td></tr> <tr><td>1000 model</td><td>270</td></tr> <tr><td>1050 model</td><td>284</td></tr> <tr><td>1100 model</td><td>296</td></tr> <tr><td>1150 model</td><td>312</td></tr> <tr><td>1200 model</td><td>324</td></tr> <tr><td>1250 model</td><td>338</td></tr> <tr><td>1300 model</td><td>351</td></tr> <tr><td>1350 model</td><td>365</td></tr> </tbody> </table>	Model	Qj Total	200 model	53	250 model	69	300 model	86	350 model	96	400 model	108	450 model	121	500 model	138	550 model	155	600 model	172	650 model	177	700 model	190	750 model	207	800 model	224	850 model	241	900 model	248	950 model	254	1000 model	270	1050 model	284	1100 model	296	1150 model	312	1200 model	324	1250 model	338	1300 model	351	1350 model	365	<p>1) Check the Qj total (capacity code total) of indoor units connected.</p> <p>2) Check the Qj setting (capacity code) of the connected indoor unit set by the switch (SW2 on indoor unit board).</p> <p>When the model name set by the switch is different from that of the unit connected, turn off the power source of the outdoor and the indoor units, and change the setting of the Qj (capacity code).</p> <p>3) Indoor unit Qj table</p> <table border="1"> <thead> <tr> <th>Model</th> <th>Qj</th> </tr> </thead> <tbody> <tr><td>15</td><td>3</td></tr> <tr><td>20</td><td>4</td></tr> <tr><td>25</td><td>5</td></tr> <tr><td>32</td><td>6</td></tr> <tr><td>40</td><td>8</td></tr> <tr><td>50</td><td>10</td></tr> <tr><td>63</td><td>13</td></tr> <tr><td>71</td><td>14</td></tr> <tr><td>80</td><td>16</td></tr> <tr><td>100</td><td>20</td></tr> <tr><td>125</td><td>25</td></tr> <tr><td>140</td><td>28</td></tr> <tr><td>200</td><td>40</td></tr> <tr><td>250</td><td>50</td></tr> </tbody> </table>	Model	Qj	15	3	20	4	25	5	32	6	40	8	50	10	63	13	71	14	80	16	100	20	125	25	140	28	200	40	250	50
	Model	Qj Total																																																																																
	200 model	53																																																																																
250 model	69																																																																																	
300 model	86																																																																																	
350 model	96																																																																																	
400 model	108																																																																																	
450 model	121																																																																																	
500 model	138																																																																																	
550 model	155																																																																																	
600 model	172																																																																																	
650 model	177																																																																																	
700 model	190																																																																																	
750 model	207																																																																																	
800 model	224																																																																																	
850 model	241																																																																																	
900 model	248																																																																																	
950 model	254																																																																																	
1000 model	270																																																																																	
1050 model	284																																																																																	
1100 model	296																																																																																	
1150 model	312																																																																																	
1200 model	324																																																																																	
1250 model	338																																																																																	
1300 model	351																																																																																	
1350 model	365																																																																																	
Model	Qj																																																																																	
15	3																																																																																	
20	4																																																																																	
25	5																																																																																	
32	6																																																																																	
40	8																																																																																	
50	10																																																																																	
63	13																																																																																	
71	14																																																																																	
80	16																																																																																	
100	20																																																																																	
125	25																																																																																	
140	28																																																																																	
200	40																																																																																	
250	50																																																																																	
	<p>(2) The model selection switches (SW5-3 - 5-8) on the outdoor unit are set incorrectly.</p> <table border="1"> <thead> <tr> <th rowspan="2">Model</th> <th colspan="6">SW5</th> </tr> <tr> <th>3</th> <th>4</th> <th>5</th> <th>6</th> <th>7</th> <th>8</th> </tr> </thead> <tbody> <tr><td>P200 model</td><td>OFF</td><td>ON</td><td>OFF</td><td>OFF</td><td>ON</td><td>OFF</td></tr> <tr><td>P250 model</td><td>ON</td><td>ON</td><td>OFF</td><td>OFF</td><td>ON</td><td>OFF</td></tr> <tr><td>P300 model</td><td>OFF</td><td>OFF</td><td>ON</td><td>OFF</td><td>ON</td><td>OFF</td></tr> <tr><td>P350 model</td><td>OFF</td><td>ON</td><td>ON</td><td>OFF</td><td>ON</td><td>OFF</td></tr> <tr><td>P400 model</td><td>ON</td><td>ON</td><td>ON</td><td>OFF</td><td>ON</td><td>OFF</td></tr> <tr><td>P450 model</td><td>OFF</td><td>OFF</td><td>OFF</td><td>ON</td><td>ON</td><td>OFF</td></tr> <tr><td>P500 model</td><td>ON</td><td>OFF</td><td>OFF</td><td>ON</td><td>ON</td><td>OFF</td></tr> </tbody> </table>	Model	SW5						3	4	5	6	7	8	P200 model	OFF	ON	OFF	OFF	ON	OFF	P250 model	ON	ON	OFF	OFF	ON	OFF	P300 model	OFF	OFF	ON	OFF	ON	OFF	P350 model	OFF	ON	ON	OFF	ON	OFF	P400 model	ON	ON	ON	OFF	ON	OFF	P450 model	OFF	OFF	OFF	ON	ON	OFF	P500 model	ON	OFF	OFF	ON	ON	OFF	<p>Check the setting for the model selection switch on the outdoor unit (Dipswitches SW5-3 - 5-8 on the outdoor unit control board).</p>																		
Model	SW5																																																																																	
	3	4	5	6	7	8																																																																												
P200 model	OFF	ON	OFF	OFF	ON	OFF																																																																												
P250 model	ON	ON	OFF	OFF	ON	OFF																																																																												
P300 model	OFF	OFF	ON	OFF	ON	OFF																																																																												
P350 model	OFF	ON	ON	OFF	ON	OFF																																																																												
P400 model	ON	ON	ON	OFF	ON	OFF																																																																												
P450 model	OFF	OFF	OFF	ON	ON	OFF																																																																												
P500 model	ON	OFF	OFF	ON	ON	OFF																																																																												
	<p>(3) The outdoor unit and the auxiliary unit (OS) that is connected to the same system are not properly connected.</p>	<p>Confirm that the TB3 on the OC and OS are properly connected.</p>																																																																																

## 7-9-2 Error Code [7101]

### 1. Error code definition

Capacity code setting error

### 2. Error definition and error detection method

Connection of incompatible (wrong capacity code) indoor unit or outdoor unit

### 3. Error source, cause, check method and remedy

Error source	Cause	Check method and remedy																																																														
Outdoor unit Indoor unit	(1) The model name (capacity code) set by the switch (SW2) is wrong.  *The capacity of the indoor unit can be confirmed by the self-diagnosis function (SW1 operation) of the outdoor unit.	1) Check the model name (capacity code) of the indoor unit which has the error source address set by the switch (SW2 on indoor unit board). When the model name set by the switch is different from that of the unit connected, turn off the power source of the outdoor and the indoor units, and change the setting of the capacity code.																																																														
Outdoor unit	(2) The model selection switches (SW5-3 - 5-8) on the outdoor unit are set incorrectly.  <table border="1" style="margin-left: 40px;"> <thead> <tr> <th rowspan="2">Model</th> <th colspan="6">SW5</th> </tr> <tr> <th>3</th> <th>4</th> <th>5</th> <th>6</th> <th>7</th> <th>8</th> </tr> </thead> <tbody> <tr> <td>P200 model</td> <td>OFF</td> <td>ON</td> <td>OFF</td> <td>OFF</td> <td>ON</td> <td>OFF</td> </tr> <tr> <td>P250 model</td> <td>ON</td> <td>ON</td> <td>OFF</td> <td>OFF</td> <td>ON</td> <td>OFF</td> </tr> <tr> <td>P300 model</td> <td>OFF</td> <td>OFF</td> <td>ON</td> <td>OFF</td> <td>ON</td> <td>OFF</td> </tr> <tr> <td>P350 model</td> <td>OFF</td> <td>ON</td> <td>ON</td> <td>OFF</td> <td>ON</td> <td>OFF</td> </tr> <tr> <td>P400 model</td> <td>ON</td> <td>ON</td> <td>ON</td> <td>OFF</td> <td>ON</td> <td>OFF</td> </tr> <tr> <td>P450 model</td> <td>OFF</td> <td>OFF</td> <td>OFF</td> <td>ON</td> <td>ON</td> <td>OFF</td> </tr> <tr> <td>P500 model</td> <td>ON</td> <td>OFF</td> <td>OFF</td> <td>ON</td> <td>ON</td> <td>OFF</td> </tr> </tbody> </table>	Model	SW5						3	4	5	6	7	8	P200 model	OFF	ON	OFF	OFF	ON	OFF	P250 model	ON	ON	OFF	OFF	ON	OFF	P300 model	OFF	OFF	ON	OFF	ON	OFF	P350 model	OFF	ON	ON	OFF	ON	OFF	P400 model	ON	ON	ON	OFF	ON	OFF	P450 model	OFF	OFF	OFF	ON	ON	OFF	P500 model	ON	OFF	OFF	ON	ON	OFF	Check the setting for the model selection switch on the outdoor unit (Dipswitches SW5-3 - 5-8 on the outdoor unit control board).
Model	SW5																																																															
	3	4	5	6	7	8																																																										
P200 model	OFF	ON	OFF	OFF	ON	OFF																																																										
P250 model	ON	ON	OFF	OFF	ON	OFF																																																										
P300 model	OFF	OFF	ON	OFF	ON	OFF																																																										
P350 model	OFF	ON	ON	OFF	ON	OFF																																																										
P400 model	ON	ON	ON	OFF	ON	OFF																																																										
P450 model	OFF	OFF	OFF	ON	ON	OFF																																																										
P500 model	ON	OFF	OFF	ON	ON	OFF																																																										

### 7-9-3 **Error Code [7102]**

**1. Error code definition**

**Wrong number of connected units**

**2. Error definition and error detection method**

The number of connected indoor units is "0" or exceeds the allowable value.

**3. Error source, cause, check method and remedy**

Error source	Cause	Check method and remedy								
Outdoor unit	<p>(1) Number of indoor units connected to the outdoor terminal block (TB3) for indoor/ outdoor transmission lines exceeds limitations described below.</p> <table border="1" data-bbox="469 667 906 1249"> <thead> <tr> <th data-bbox="469 667 628 701">Number of units</th> <th data-bbox="628 667 906 701">Restriction on the number of units</th> </tr> </thead> <tbody> <tr> <td data-bbox="469 701 628 1003">Total number of indoor units</td> <td data-bbox="628 701 906 1003">                     17 : 200 model                      21 : 250 models                      26 : 300 models                      30 : 350 models                      34 : 400 models                      39 : 450 models                      43 : 500 models                      47 : 550 models                      50 : 600 - 1350 models                 </td> </tr> <tr> <td data-bbox="469 1003 628 1144">Total number of LOSSNAY units (During auto address start-up only)</td> <td data-bbox="628 1003 906 1144">0 or 1</td> </tr> <tr> <td data-bbox="469 1144 628 1249">Total number of outdoor units</td> <td data-bbox="628 1144 906 1249">                     1 : P200 - P500YKB models                      2 : P400 - P900 YSKB models                      3 : P950 - P1350 YSKB models                 </td> </tr> </tbody> </table> <p>(2) Disconnected transmission line of the outdoor unit</p> <p>(3) Short-circuited transmission line When (2) and (3) apply, the following display will appear.</p> <ul style="list-style-type: none"> <li>◆ME remote controller Nothing appears on the remote controller because it is not powered.</li> <li>◆MA remote controller "HO" or "PLEASE WAIT" blinks.</li> </ul> <p>(4) The model selection switch (SW5-7) on the outdoor unit is set to OFF. (Normally set to ON)</p> <p>(5) Outdoor unit address setting error The outdoor units in the same refrigerant circuit do not have sequential address numbers.</p>	Number of units	Restriction on the number of units	Total number of indoor units	17 : 200 model 21 : 250 models 26 : 300 models 30 : 350 models 34 : 400 models 39 : 450 models 43 : 500 models 47 : 550 models 50 : 600 - 1350 models	Total number of LOSSNAY units (During auto address start-up only)	0 or 1	Total number of outdoor units	1 : P200 - P500YKB models 2 : P400 - P900 YSKB models 3 : P950 - P1350 YSKB models	<p>1) Check whether the number of units connected to the outdoor terminal block (TB3) for indoor/ outdoor transmission lines does not exceed the limitation. (See (1) and (2) on the left.)</p> <p>2) Check (2) - (3) on the left.</p> <p>3) Check whether the transmission line for the terminal block for centralized control (TB7) is not connected to the terminal block for the indoor/outdoor transmission line (TB3).</p> <p>4) Check the setting for the model selection switch on the outdoor unit (Dipswitches SW5-7 on the outdoor unit control board).</p>
Number of units	Restriction on the number of units									
Total number of indoor units	17 : 200 model 21 : 250 models 26 : 300 models 30 : 350 models 34 : 400 models 39 : 450 models 43 : 500 models 47 : 550 models 50 : 600 - 1350 models									
Total number of LOSSNAY units (During auto address start-up only)	0 or 1									
Total number of outdoor units	1 : P200 - P500YKB models 2 : P400 - P900 YSKB models 3 : P950 - P1350 YSKB models									

### 7-9-4 **Error Code [7105]**

1. **Error code definition**  
Address setting error
2. **Error definition and error detection method**  
Erroneous setting of OC unit address
3. **Cause, check method and remedy**

Error source	Cause	Check method and remedy
Outdoor unit	Erroneous setting of OC unit address The address of outdoor unit is not being set to 51 - 100.	Check that the address of OC unit is set to 51-100. Reset the address if it stays out of the range, while shutting the power source off.

### 7-9-5 **Error Code [7106]**

1. **Error code definition**  
Attribute setting error
2. **Error definition and error detection method**

Error source	Cause	Check method and remedy						
-	A remote controller for use with indoor units, such as the MA remote controller, is connected to the OA processing unit whose attribute is FU.	To operate the OA processing unit directly via a remote controller for use with indoor units, such as the MA remote controller, set the DIP SW 3-1 on the OA processing unit to ON. <table border="1" style="margin-left: auto; margin-right: auto;"> <tr> <td>Operation Method</td> <td>SW3-1</td> </tr> <tr> <td>Interlocked operation with the indoor unit</td> <td>OFF</td> </tr> <tr> <td>Direct operation via the MA remote controller</td> <td>ON</td> </tr> </table>	Operation Method	SW3-1	Interlocked operation with the indoor unit	OFF	Direct operation via the MA remote controller	ON
Operation Method	SW3-1							
Interlocked operation with the indoor unit	OFF							
Direct operation via the MA remote controller	ON							

## 7-9-6 Error Code [7110]

### 1. Error code definition

**Connection information signal transmission/reception error**

### 2. Error definition and error detection method

The given indoor unit is inoperable because it is not properly connected to the outdoor unit in the same system.

### 3. Error source, cause, check method and remedy

Error source	Cause	Check method and remedy
Outdoor unit	(1) Power to the transmission booster is cut off.	1) Confirm that the power to the transmission booster is not cut off by the booster being connected to the switch on the indoor unit. (The unit will not function properly unless the transmission booster is turned on.) →Reset the power to the outdoor unit.
	(2) Power resetting of the transmission booster and outdoor unit.	
	(3) Wiring failure between OC and OS	2) Confirm that the TB3 on the OC and OS are properly connected. 3) Check the model selection switch on the outdoor unit (Dipswitch SW5-7 on the control board.).
	(4) Broken wire between OC and OS.	
	(5) The model selection switch (SW5-7) on the outdoor unit is set to OFF. (Normally set to ON)	

## 7-9-7 Error Code [7111]

### 1. Error code definition

**Remote controller sensor fault**

### 2. Error definition and error detection method

This error occurs when the temperature data is not sent although the remote controller sensor is specified.

### 3. Error source, cause, check method and remedy

Error source	Cause	Check method and remedy
Indoor unit OA processing unit	The remote controller without the temperature sensor (the wireless remote controller or the ME compact remote controller (mounted type)) is used and the remote controller sensor for the indoor unit is specified. (SW1-1 is ON.)	Replace the remote controller with the one with built-in temperature sensor.

## 7-9-8 Error Code [7113]

### 1. Error code definition

Function setting error (improper connection of CNTYP)

### 2. Error source, cause, check method and remedy

Error source	Cause	Check method and remedy
Outdoor unit	(1) Wiring fault	(Detail code 15)
	(2) Loose connectors, short-circuit, contact failure	1) Check the connector CNTYP5 on the control board for proper connection.
	(3) Incompatible control board and INV board (replacement with a wrong circuit board)	(Detail code 14) 1) Check the connector CNTYP5 on the control board for proper connection.
	(4) DIP SW setting error on the control board	2) Check the settings of SW5-3 through SW5-6 on the control board.
		(Detail code 12) 1) Check the connector CNTYP2 on the control board for proper connection. 2) Check the connector CNTYP5 on the control board for proper connection. 3) Check the settings of SW5-3 through SW5-6 on the control board.
		(Detail code 16) 1) Check the connector CNTYP on the INV board for proper connection. 2) Check the connector CNTYP5 on the control board for proper connection. 3) Check the settings of SW5-3 through SW5-6 on the control board. 4) Check the wiring between the control board and INV board. Refer to the following page(s). [7-2-1 Error Code [0403]](page 169)
		(Detail code 0, 1, 5, 6) 1) Check the wiring between the control board and INV board. Refer to the following page(s). [7-2-1 Error Code [0403]](page 169) 2) Check the settings of SW5-3 through SW5-6 on the control board. 3) Check the connector CNTYP5 on the control board for proper connection.
	(Detail code Miscellaneous)  *If a set-model-name identification error occurs, check the detail code on the unit on which the error occurred. The detail code that appears on other units will be different from the ones shown above.	



## 7-9-9 Error Code [7117]

### 1. Error code definition Model setting error

### 2. Error source, cause, check method and remedy

Error source	Cause	Check method and remedy
Outdoor unit	(1) Wiring fault	(Detail code 15)
	(2) Loose connectors, short-circuit, contact failure	1) Check the connector CNTYP5 on the control board for proper connection.
		(Detail code 12)
		1) Check the connector CNTYP2 on the control board for proper connection.
		2) Check the connector CNTYP5 on the control board for proper connection.
(Detail code 16)	1) Check the connector CNTYP on the INV board for proper connection. 2) Check the connector CNTYP5 on the control board for proper connection. 3) Check the wiring between the control board and INV board. Refer to the following page(s). [7-2-1 Error Code [0403]](page 169)	
(Detail code 0, 1, 5, 6)	1) Check the wiring between the control board and INV board. Refer to the following page(s). [7-2-1 Error Code [0403]](page 169) 2) Check the settings of SW5-3 through SW5-6 on the control board. 3) Check the connector CNTYP5 on the control board for proper connection.	
(Detail code Miscellaneous)	*If a set-model-name identification error occurs, check the detail code on the unit on which the error occurred. The detail code that appears on other units will be different from the ones shown above.	

## 7-9-10 **Error Code [7130]**

**1. Error code definition**

**Incompatible unit combination**

**2. Error definition and error detection method**

The check code will appear when the indoor units with different refrigerant systems are connected.

**3. Error source, cause, check method and remedy**

Error source	Cause	Check method and remedy
Outdoor unit	The connected indoor unit is for use with R22 or R407C. Incorrect type of indoor units are connected. The M-NET connection adapter is connected to the indoor unit system in a system in which the Slim Model (A control) of units are connected to the M-NET.	Check the connected indoor unit model. Check whether the connecting adapter for M-NET is not connected to the indoor unit. (Connect the connecting adapter for M-NET to the outdoor unit.)



---

## Chapter 8 Troubleshooting Based on Observed Symptoms

<b>8-1</b>	<b>MA Remote Controller Problems</b> .....	<b>237</b>
8-1-1	The LCD Does Not Light Up. ....	237
8-1-2	The LCD Momentarily Lights Up and Then Goes Off. ....	238
8-1-3	"HO" and "PLEASE WAIT" Do Not Go Off the Screen. ....	239
8-1-4	Air Conditioning Units Do Not Operate When the ON Button Is Pressed. ....	240
<b>8-2</b>	<b>ME remote Controller Problems</b> .....	<b>241</b>
8-2-1	The LCD Does Not Light Up. ....	241
8-2-2	The LCD Momentarily Lights Up and Then Goes Off. ....	242
8-2-3	"HO" Does Not Go Off the Screen. ....	243
8-2-4	"88" Appears on the LCD. ....	244
<b>8-3</b>	<b>Refrigerant Control Problems</b> .....	<b>245</b>
8-3-1	Units in the Cooling Mode Do Not Operate at Expected Capacity.....	245
8-3-2	Units in the Heating Mode Do Not Operate at Expected Capacity. ....	247
8-3-3	Outdoor Units Stop at Irregular Times. ....	249
<b>8-4</b>	<b>Checking Transmission Waveform and for Electrical Noise Interference</b> .....	<b>250</b>
8-4-1	M-NET.....	250
8-4-2	MA Remote Controller .....	252
<b>8-5</b>	<b>Pressure Sensor Circuit Configuration and Troubleshooting Pressure Sensor Problems</b> .....	<b>253</b>
8-5-1	Comparing the High-Pressure Sensor Measurement and Gauge Pressure .....	253
8-5-2	High-Pressure Sensor Configuration (63HS1).....	253
8-5-3	Comparing the Low-Pressure Sensor Measurement and Gauge Pressure.....	254
8-5-4	Low-Pressure Sensor Configuration (63LS).....	254
<b>8-6</b>	<b>Troubleshooting Solenoid Valve Problems</b> .....	<b>255</b>
<b>8-7</b>	<b>Troubleshooting Outdoor Unit Fan Problems</b> .....	<b>257</b>
<b>8-8</b>	<b>Troubleshooting LEV Problems</b> .....	<b>258</b>
8-8-1	General Overview on LEV Operation.....	258
8-8-2	Possible Problems and Solutions .....	261
8-8-3	Coil Removal Instructions .....	262
<b>8-9</b>	<b>Troubleshooting Inverter Problems</b> .....	<b>264</b>
8-9-1	Inverter-Related Problems and Solutions .....	264
8-9-2	Checking the Inverter Board Error Detection Circuit.....	266
8-9-3	Checking the Compressor for Ground Fault and Coil Resistance Problems .....	266
8-9-4	Checking the Inverter for Damage at No-Load .....	266
8-9-5	Checking the Inverter for Damage during Compressor Operation.....	267
8-9-6	Checking the Converter for Damage during Compressor Operation .....	269
8-9-7	Checking the Fan Motor for Ground Fault and Coil Resistance Problems .....	269
8-9-8	Checking the Fan Board Error Detection Circuit at No Load .....	269
8-9-9	Checking the Fan Inverter for Damage at No Load .....	270
8-9-10	Checking the Fan Inverter for Damage with Load .....	271
8-9-11	Checking the Installation Conditions.....	271
8-9-12	Solutions for the Main No-Fuse Breaker Trip.....	272
8-9-13	Solutions for the Main Earth Leakage Breaker Trip .....	272
8-9-14	Simple Check on Inverter Circuit Components .....	273
8-9-15	Troubleshooting Problems with IGBT Module .....	273
<b>8-10</b>	<b>Control Circuit</b> .....	<b>276</b>
8-10-1	Control Power Supply Function Block.....	276
8-10-2	Troubleshooting Problems with Outdoor Unit Transmission Power Supply Circuit .....	278

---

<b>8-11</b>	<b>Measures for Refrigerant Leakage .....</b>	<b>281</b>
<b>8-12</b>	<b>Compressor Replacement Instructions .....</b>	<b>283</b>
<b>8-13</b>	<b>Troubleshooting Problems Using the LED Status Indicators on the Outdoor Unit .....</b>	<b>285</b>

---

## 8-1 MA Remote Controller Problems

---

### 8-1-1 The LCD Does Not Light Up.

---

#### 1. Phenomena

Even if the operation button on the remote controller is pressed, the display remains unlit and the unit does not start running. (Power indicator (  ) is unlit and no lines appear on the remote controller.)

#### 2. Cause

- 1) The power is not supplied to the indoor unit.
  - The main power of the indoor unit is not on.
  - The connector on the indoor unit board has come off.
  - The fuse on the indoor unit board has melted.
  - Transformer failure and disconnected wire of the indoor unit.
- 2) Incorrect wiring for the MA remote controller
  - Disconnected wire for the MA remote controller or disconnected line to the terminal block.
  - Short-circuited MA remote controller wiring
  - Incorrect wiring of the MA remote controller cables
  - Incorrect connection of the MA remote wiring to the terminal block for transmission line (TB5) on the indoor unit
  - Wiring mixup between the MA remote controller cable and 220-240 VAC power supply cable
  - Reversed connection of the wire for the MA remote controller and the M-NET transmission line on the indoor unit
- 3) The number of the MA remote controllers that are connected to an indoor unit exceeds the allowable range (2 units). Two PAR-31MAA controllers are connected.
- 4) The length or the diameter of the wire for the MA remote controller are out of specification.
- 5) Short circuit of the wire for the remote display output of the outdoor unit or reversed polarity connection of the relay.
- 6) The indoor unit board failure
- 7) MA remote controller failure

#### 3. Check method and remedy

- 1) Check the voltage at the MA remote controller terminals.
  - If the voltage is between DC 9 and 12V, the remote controller is a failure.
  - If no voltage is applied, check the causes 1) and 3) and if the cause is found, correct it.  
If no cause is found, refer to 2).
- 2) Disconnect the remote controller cable from TB15 (MA remote controller terminal) on the indoor unit, and check the voltage across the terminals on TB15.
  - If the voltage is between DC 9 and 12 V, check the causes 2) and 4) and if the cause is found, correct it.
  - If no voltage is applied, check the cause 1) and if the cause is found, correct it.  
If no cause is found, check the wire for the remote display output (relay polarity).  
If no further cause is found, replace the indoor unit board.

## 8-1-2 The LCD Momentarily Lights Up and Then Goes Off.

### 1. Phenomena

When the remote controller operation SW is turned on, the operation status briefly appears on the display, then it goes off, and the display lights out immediately, and the unit stops.

### 2. Cause

- 1) The power for the M-NET transmission line is not supplied from the outdoor unit. For details, refer to the following page(s).[8-10-2 Troubleshooting Problems with Outdoor Unit Transmission Power Supply Circuit](page 278)
- 2) Short circuit of the transmission line.
- 3) Incorrect wiring of the M-NET transmission line on the outdoor unit.

- Disconnected wire for the MA remote controller or disconnected line to the terminal block.
- The indoor transmission line is connected incorrectly to the transmission terminal block for centralized controller (TB7).
- The male power supply connectors on the multiple outdoor units are connected to the female power supply switch connector (CN40).

In the system to which the power supply unit for transmission lines is connected, the male power supply connector is connected to the female power supply switch connector (CN40) on the outdoor unit.

- 4) Disconnected M-NET transmission line on the indoor unit side.
- 5) Disconnected wire between the terminal block for M-NET line (TB5) of the indoor unit and the indoor unit board (CN2M) or disconnected connector.

### 3. Check method and remedy

When 2) and 3) above apply, check code 7102 will be displayed on the self-diagnosis LED.

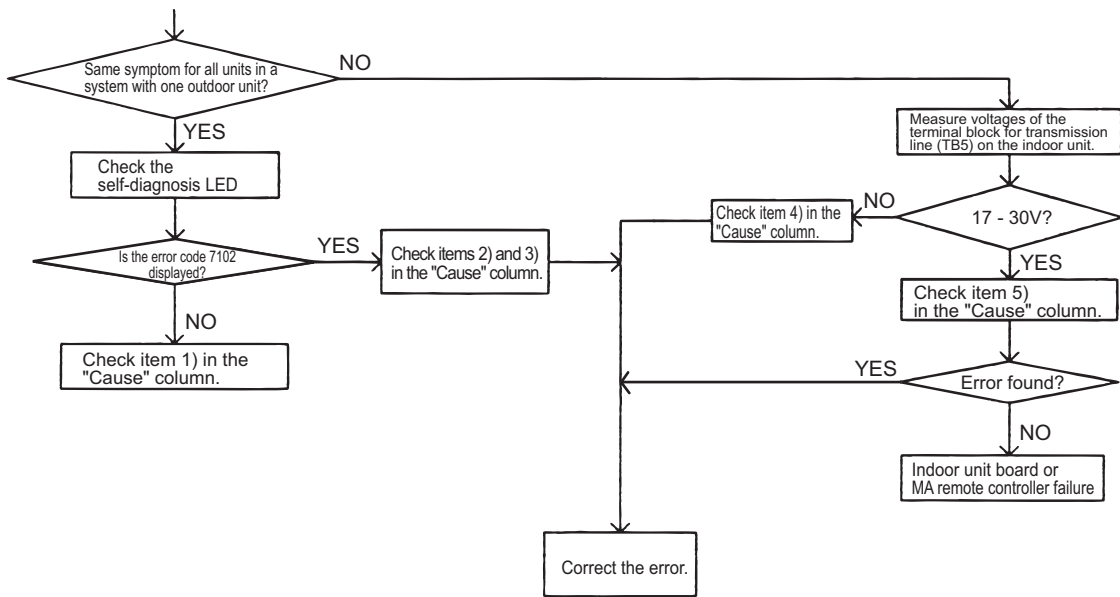

### 8-1-3 "HO" and "PLEASE WAIT" Do Not Go Off the Screen.

**1. Phenomena**

"HO" or "PLEASE WAIT" display on the remote controller does not disappear, and no operation is performed even if the button is pressed. ("HO" or "PLEASE WAIT" display will normally turn off 5 minutes later after the power on.)

**2. Cause**

- 1) The power for the M-NET transmission line is not supplied from the outdoor unit. For details, refer to the following page(s).[8-10-2 Troubleshooting Problems with Outdoor Unit Transmission Power Supply Circuit](page 278)
- 2) Short-circuited transmission line
- 3) Incorrect wiring of the M-NET transmission line on the outdoor unit.
  - Disconnected wire for the MA remote controller or disconnected line to the terminal block.
  - The indoor transmission line is connected incorrectly to the transmission terminal block for centralized controller (TB7).
  - The male power supply connectors on the multiple outdoor units are connected to the female power supply switch connector (CN40).

In the system to which the power supply unit for transmission lines is connected, the male power supply connector is connected to the female power supply switch connector (CN40) on the outdoor unit
- 4) Disconnected M-NET transmission line on the indoor unit.
- 5) Disconnected wire between the terminal block for M-NET line (TB5) of the indoor unit and the indoor unit board (CN2M) or disconnected connector.
- 6) Incorrect wiring for the MA remote controller
  - Short-circuited wire for the MA remote controller
  - Disconnected wire for the MA remote controller (No.2) and disconnected line to the terminal block.
  - Reversed daisy-chain connection between groups
  - Incorrect wiring for the MA remote controller to the terminal block for transmission line connection (TB5) on the indoor unit
  - The M-NET transmission line is connected incorrectly to the terminal block (TB15) for the MA remote controller.
- 7) The sub/main setting of the MA remote controller is set to sub. Two PAR-31MAA controllers are connected.
- 8) 2 or more main MA remote controllers are connected.
- 9) Indoor unit board failure (MA remote controller communication circuit)
- 10) Remote controller failure
- 11) Outdoor unit failure (Refer to the following page(s). [8-13 Troubleshooting Problems Using the LED Status Indicators on the Outdoor Unit](page 285))

**3. Check method and remedy**

When 2) and 3) above apply, check code 7102 will be displayed on the self-diagnosis LED.

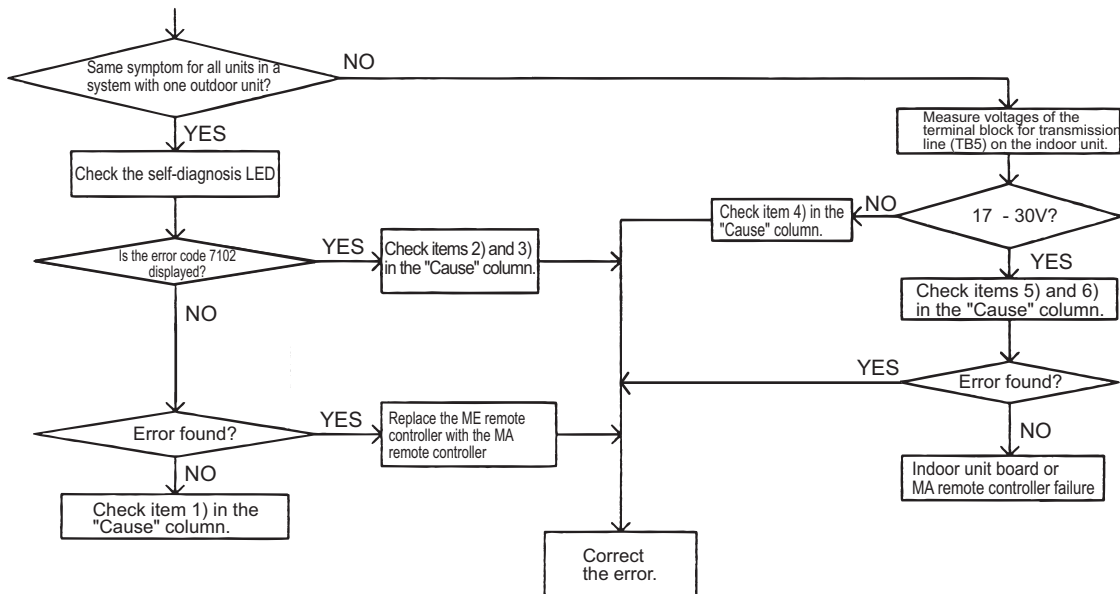





---

## 8-2 ME remote Controller Problems

---

### 8-2-1 The LCD Does Not Light Up.

---

---

#### 1. Phenomena

Even if the operation button on the remote controller is pressed, the display remains unlit and the unit does not start running. (Power indicator ☉ does not appear on the screen.)

#### 2. Cause

- 1) The power for the M-NET transmission line is not supplied from the outdoor unit.
- 2) Short circuit of the transmission line.
- 3) Incorrect wiring of the M-NET transmission line on the outdoor unit.
  - Disconnected wire for the MA remote controller or disconnected line to the terminal block.
  - The indoor transmission line is connected incorrectly to the transmission terminal block for centralized controller (TB7).
- 4) Disconnected transmission line on the remote controller.
- 5) Remote controller failure
- 6) Outdoor unit failure (For details, refer to the following page(s). [8-13 Troubleshooting Problems Using the LED Status Indicators on the Outdoor Unit](page 285))

#### 3. Check method and remedy

- 1) Check voltage of the transmission terminal block for of the ME remote controller.
  - If voltage between is 17V and 30V → ME remote controller failure
  - When voltage is 17V or less → For details, refer to the following page(s). [8-10-2 Troubleshooting Problems with Outdoor Unit Transmission Power Supply Circuit](page 278)
- 2) **When 2) and 3) above apply, check code 7102 will be displayed on the self-diagnosis LED.**

## 8-2-2 The LCD Momentarily Lights Up and Then Goes Off.

### 1. Phenomena

When the remote controller operation SW is turned on, a temporary operation display is indicated, and the display lights out immediately.

### 2. Cause

1) The power is not supplied to the indoor unit.

- The main power of the indoor unit (AC220V) is not on.
- The connector on the indoor unit board has come off.
- The fuse on the indoor unit board has melted.
- Transformer failure and disconnected wire of the indoor unit
- The indoor unit board failure

2) The outdoor control board failure

As the indoor unit does not interact with the outdoor unit, the outdoor unit model cannot be recognized.

### 3. Check method and remedy

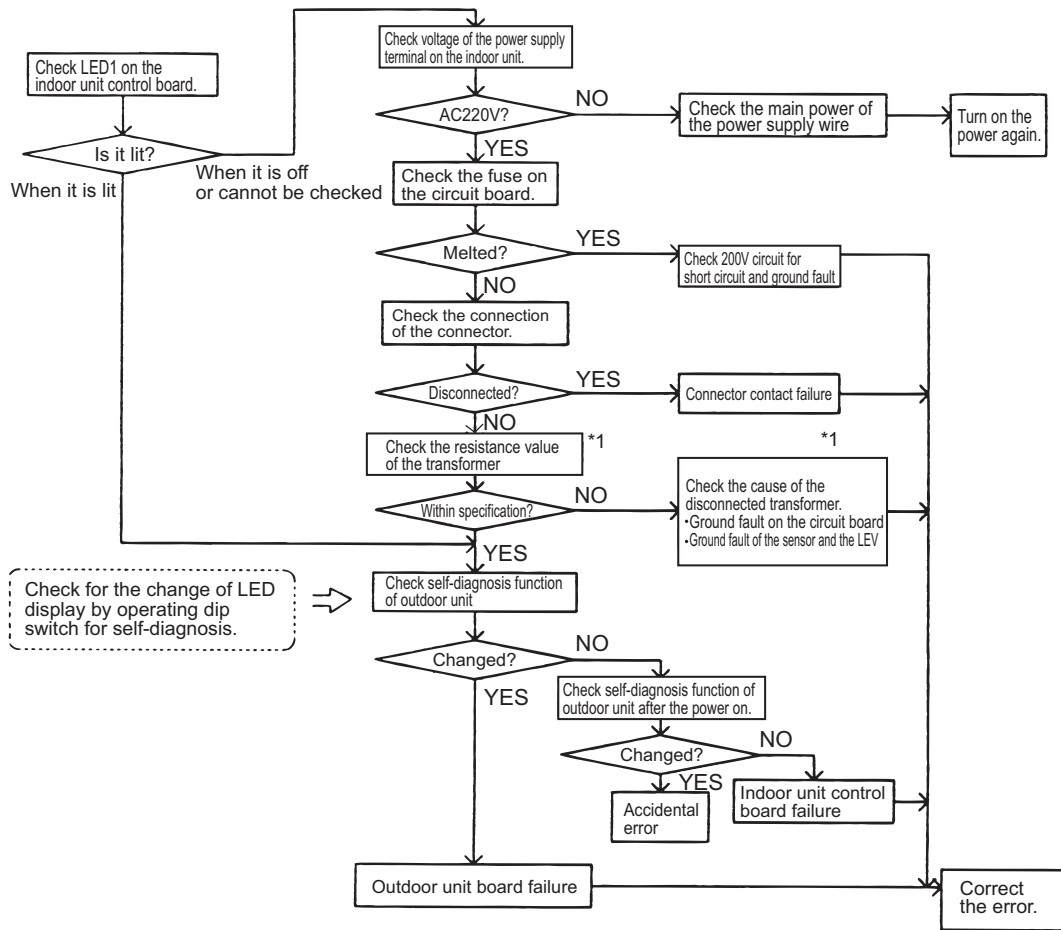

\*1. Refer to the parts catalog "transformer check".

## 8-2-3 "HO" Does Not Go Off the Screen.

### 1. Phenomena

"HO" display on the remote controller does not disappear, and no operation is performed even if the button is pressed.

### 2. Cause

#### Without using MELANS

- 1) Outdoor unit address is set to "00"
- 2) A wrong address is set.
  - The address of the indoor unit that is connected to the remote controller is incorrect. (It should equal the ME remote controller address plus 100.)
  - A wrong address is set to the ME remote controller. (100 must be added to the address of the indoor unit.)
- 3) Faulty wiring of the terminal block for transmission line (TB5) of the indoor unit in the same group with the remote controller.
- 4) The centralized control switch (SW5-1) on the outdoor unit is set to ON.
- 5) Disconnection or faulty wiring of indoor unit transmission line.
- 6) Disconnection between the terminal block for M-NET line connection (TB5) of the indoor unit and the male connector (CN2M)
- 7) The male power supply connectors on 2 or more outdoor units are connected to the female power supply switch connector (CN40) for the transmission line for centralized control.
- 8) Outdoor unit control board failure
- 9) Indoor unit control board failure
- 10) Remote controller failure

#### Interlocking control with MELANS

- 1) No group registration is made using MELANS. (The indoor unit and the ME remote controller are not grouped.)
- 2) Disconnected transmission line for centralized control (TB7) of the outdoor unit
- 3) The male power supply connector is connected to CN40 on more than one outdoor unit, or the connector is connected to CN40 on the outdoor unit in the system to which a power supply unit for transmission line is connected.

#### Using MELANS

- 1) When MELANS is used, "HO" display on the remote controller will disappear when the indoor unit and the local remote controller (ME remote controller) are grouped.  
If "HO" does not disappear after the registration, check items 1) through 3) in the "Cause" column of the section on interlocked control with MELANS.

### 3. Check method and remedy

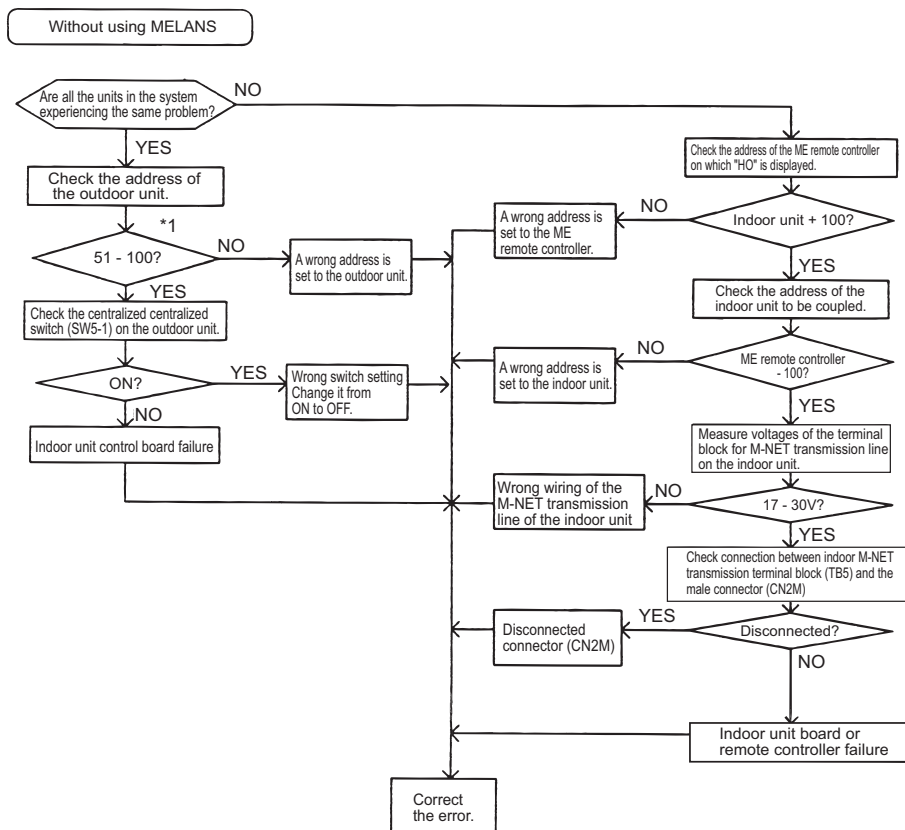

\*1. When the indoor unit address is set to 1 - 50, the address will be forcibly set to 100.

## 8-2-4 "88" Appears on the LCD.

### 1. Phenomena

"88" appears on the remote controller when the address is registered or confirmed.

### 2. Cause, check method and remedy

Cause	Check method and remedy
<b>An error occurs when the address is registered or confirmed. (common)</b>	
1. A wrong address is set to the unit to be coupled.	(1) Confirm the address of unit to be coupled.
2. The transmission line of the unit to be coupled is disconnected or is not connected.	(2) Check the connection of transmission line.
3. Circuit board failure of the unit to be coupled	(3) Check voltage of the terminal block for transmission line of the unit to be coupled.
4. Improper transmission line work	1) Normal if voltage is between DC17 and 30V. 2) Check (5) in case other than 1).
<b>Generates at interlocking registration between LOSSNAY and the indoor unit</b>	
5. The power of LOSSNAY is OFF.	(4) Check for the main power of LOSSNAY.
<b>Generates at confirmation of controllers used in the system in which the indoor units connected to different outdoor units are grouped</b>	
6. The power of the outdoor unit to be confirmed has been cut off.	(5) Check the power supply of the outdoor unit which is coupled with the unit to be confirmed.
7. Transmission line is disconnected from the terminal block for central control system connection (TB7) on the outdoor unit.	(6) Check that the transmission line for centralized control (TB7) of the outdoor unit is not disconnected.
8. When the indoor units connected to different outdoor units are grouped without MELANS, the male power supply connector is not connected to the female power supply switch connector (CN40) for the transmission line for centralized control.	(7) Check voltage of the transmission line for centralized control.
9. The male power supply connectors on 2 or more outdoor units are connected to the female power supply switch connector (CN40) for the transmission line for centralized control.	1) Normal when voltage is between 10V and 30V
10. In the system to which MELANS is connected, the male power supply connector is connected to the female power supply switch connector (CN40) for the transmission line for centralized control.	2) Check 8 - 11 described on the left in case other than 1).
11. Short circuit of the transmission line for centralized control	



## 8-3 Refrigerant Control Problems

### 8-3-1 Units in the Cooling Mode Do Not Operate at Expected Capacity.

**1. Phenomena**

Although cooling operation starts with the normal remote controller display, the capacity is not enough

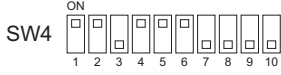
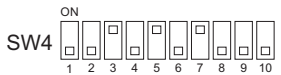
**2. Cause, check method and remedy**

Cause	Check method and remedy
<p>1. Compressor frequency does not rise sufficiently.</p> <ul style="list-style-type: none"> <li>♦Faulty detection of pressure sensor.</li> <li>♦Protection works and compressor frequency does not rise due to high discharge temperature</li> <li>♦Protection works and compressor frequency does not rise due to high pressure</li> <li>♦Pressure drops excessively.</li> </ul>	<p>(1) Check pressure difference between the detected pressure by the pressure sensor and the actual pressure with self-diagnosis LED.                      → If the accurate pressure is not detected, check the pressure sensor.                      Refer to the following page(s). [8-5-1 Comparing the High-Pressure Sensor Measurement and Gauge Pressure](page 253)</p> <p>Note: Lower inlet pressure by the low pressure sensor than the actual pressure causes insufficient capacity.                      SW4 setting (SW6-10: OFF)</p> <p>High pressure sensor                      SW4 </p> <p>Low pressure sensor                      SW4 </p> <p>(2) Check temperature difference between the evaporating temperature (Te) and the target evaporating temperature (Tem) with self-diagnosis LED.</p> <p>Note: Higher Te than Tem causes insufficient capacity.                      SW4 setting (SW6-10: OFF)</p> <p>Evaporating temperature Te                      SW4 </p> <p>Target evaporating temperature Tem                      SW4 </p> <p>Note: Protection works and compressor frequency does not rise even at higher Te than Tem due to high discharge temperature and high pressure.                      At high discharge temperature:                      Refer to the following page(s).[7-3-1 Error Code [1102]](page 171)                      At high pressure:                      Refer to the following page(s). [7-3-3 Error Code [1302] (during operation)](page 173)</p>
<p>2. Indoor unit LEV malfunction</p> <ul style="list-style-type: none"> <li>♦Insufficient refrigerant flows due to LEV malfunction (not enough opening) or protection works and compressor frequency does not rise due to pressure drop.</li> <li>♦Refrigerant leak from LEV on the stopping unit causes refrigerant shortage on the running unit.</li> </ul>	<p>Refer to the following page(s).[8-8 Troubleshooting LEV Problems](page 258)</p>



The figure at left shows that the switches 1 through 5 are set to ON and 6 through 10 are set to OFF.





Cause	Check method and remedy
<p>3. RPM error of the outdoor unit FAN</p> <ul style="list-style-type: none"> <li>◆Motor failure or board failure, or airflow rate decrease due to clogging of the heat exchanger</li> <li>◆The fan is not properly controlled as the outdoor temperature cannot be precisely detected by the temperature sensor.</li> <li>◆The fan is not properly controlled as the pressure cannot be precisely detected by the pressure sensor.</li> </ul>	<p>Refer to the following page(s). [8-7 Troubleshooting Outdoor Unit Fan Problems](page 257)</p> <p>[7-3-3 Error Code [1302] (during operation)](page 173)</p>
<p>4. Long piping length The cooling capacity varies greatly depending on the pressure loss. (When the pressure loss is large, the cooling capacity drops.)</p>	<p>Check the piping length to determine if it is contributing to performance loss. Piping pressure loss can be estimated from the temperature difference between the indoor unit heat exchanger outlet temperature and the saturation temperature (Te) of 63LS. →Correct the piping.</p>
<p>5. Piping size is not proper (thin)</p>	
<p>6. Insufficient refrigerant amount Protection works and compressor frequency does not rise due to high discharge temperature.</p>	<p>Refer to item 1 (Compressor frequency does not rise sufficiently.) on the previous page. (page 245) Refer to the following page(s).[6-9 Evaluating and Adjusting Refrigerant Charge](page 131)</p>
<p>7. Clogging by foreign object</p>	<p>Check the temperature difference between in front of and behind the place where the foreign object is clogging the pipe (upstream side and downstream side). When the temperature drops significantly, the foreign object may clog the pipe. → Remove the foreign object inside the pipe.</p>
<p>8. The indoor unit inlet temperature is excessively. (Less than 15°C [59°F] WB)</p>	<p>Check the inlet air temperature and for short cycling. Change the environment where the indoor unit is used.</p>
<p>9. Compressor failure The amount of circulating refrigerant decreases due to refrigerant leak in the compressor.</p>	<p>Check the discharge temperature to determine if the refrigerant leaks, as it rises if there is a leak.</p>
<p>10. LEV1 malfunction Sufficient liquid refrigerant is not be supplied to the indoor unit as sufficient sub cool cannot be secured due to LEV1 malfunction.</p>	<p>Refer to the following page(s).[8-8 Troubleshooting LEV Problems](page 258) It most likely happens when there is little difference or no difference between TH3 and TH6.</p>
<p>11. TH3, TH6 and 63HS1 sensor failure or faulty wiring LEV1 is not controlled normally.</p>	<ul style="list-style-type: none"> <li>◆Check the thermistor.</li> <li>◆Check wiring.</li> </ul>
<p>12. LEV2 actuation failure A drop in the low pressure that is caused either by a blockage of liquid pipe or by a pressure loss and the resultant slowing of refrigerant flow causes a tendency for the discharge temperature to rise.</p>	<p>Refer to the following page(s).[8-8 Troubleshooting LEV Problems](page 258)</p>

## 8-3-2 Units in the Heating Mode Do Not Operate at Expected Capacity.

### 1. Phenomena

Although heating operation starts with the normal remote controller display, the capacity is not enough.

### 2. Cause, check method and remedy

Cause	Check method and remedy
<p>1. Compressor frequency does not rise sufficiently.</p> <ul style="list-style-type: none"> <li>♦Faulty detection of pressure sensor.</li> <li>♦Protection works and compressor frequency does not rise due to high discharge temperature</li> <li>♦Protection works and compressor frequency does not rise due to high pressure.</li> </ul>	<p>(1) Check pressure difference between the detected pressure by the pressure sensor and the actual pressure with self-diagnosis LED.                      → If the accurate pressure is not detected, check the pressure sensor.                      Refer to the following page(s). [8-3-1 Comparing the High-Pressure Sensor Measurement and Gauge Pressure](page 253)</p> <p>Note: Higher inlet pressure by the high pressure sensor than the actual pressure causes insufficient capacity.                      SW4 setting (SW6-10: OFF)</p> <p>High pressure sensor                      SW4 </p> <p>Low pressure sensor                      SW4 </p> <p>(2) Check the difference between the condensing temperature (Tc) and the target condensing temperature (Tcm) with self-diagnosis LED.</p> <p>Note: Higher Tc than Tcm causes insufficient capacity.                      SW4 setting (SW6-10: OFF)</p> <p>Condensing temperature Tc                      SW4 </p> <p>Target condensing temperature Tcm                      SW4 </p> <p>Note: Protection works and compressor frequency does not rise even at lower Tc than Tcm due to high discharge temperature and high pressure.                      At high discharge temperature:                      Refer to the following page(s).[7-3-1 Error Code [1102]](page 171)                      At high pressure:                      Refer to the following page(s).[7-3-3 Error Code [1302] (during operation)](page 173)</p>

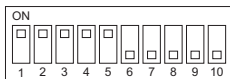

The figure at left shows that the switches 1 through 5 are set to ON and 6 through 10 are set to OFF.



Cause	Check method and remedy
2. Indoor unit LEV malfunction Insufficient refrigerant flows due to LEV malfunction (not enough opening).	Refer to the following page(s).[8-8 Troubleshooting LEV Problems](page 258)
3. Temperature reading error on the indoor unit piping temperature sensor If the temperature reading on the sensor is higher than the actual temperature, it makes the subcool seem smaller than it is, and the LEV opening decreases too much.	Check the thermistor.
4. RPM error of the outdoor unit FAN ♦Motor failure or board failure, or airflow rate decrease, pressure drop due to clogging of the heat exchanger leading to high discharge temperature ♦The fan is not properly controlled as the temperature cannot be precisely detected with the piping sensor.	Refer to the following page(s). [8-7 Troubleshooting Outdoor Unit Fan Problems](page 257)
5. Insulation failure of the refrigerant piping	
6. Long piping length Excessively long piping on the high pressure side causes pressure loss leading to increase in the high pressure.	Confirm that the characteristic of capacity drop due to piping length. → Change the pipe
7. Piping size is not proper (thin)	
8. Clogging by foreign object	Check the temperature difference between the upstream and the downstream of the pipe section that is blocked. Since blockage in the extended section is difficult to locate, operate the unit in the cooling cycle, and follow the same procedures that are used to locate the blockage of pipe during cooling operation. → Remove the blockage in the pipe.
9. The indoor unit inlet temperature is excessively high.(exceeding 28°C [82°F])	Check the inlet air temperature and for short cycling. Change the environment where the indoor unit is used.
10. Insufficient refrigerant amount Protection works and compressor frequency does not rise due to low discharge temperature Refrigerant recovery operation is likely to start.	Refer to item 1 (Compressor frequency does not rise sufficiently.) on the previous page. (page 247) Refer to the following page(s).[6-9 Evaluating and Adjusting Refrigerant Charge](page 131)
11. Compressor failure (same as in case of cooling)	Check the discharge temperature.
12. LEV2 actuation failure A drop in the low pressure that is caused either by a blockage of liquid pipe or by a pressure loss and the resultant slowing of refrigerant flow causes a tendency for the discharge temperature to rise.	Refer to the following page(s).[8-8 Troubleshooting LEV Problems](page 258)

### 8-3-3 Outdoor Units Stop at Irregular Times.

**1. Phenomena**

Outdoor unit stops at times during operation.

**2. Cause, check method and remedy**

Cause	Check method and remedy
<p>The first stop is not considered as an error, as the unit turns to anti-restart mode for 3 minutes as a preliminary error.</p> <p><b>Error mode</b></p> <p>1) Abnormal high pressure</p> <p>2) Abnormal discharge air temperature</p> <p>3) Heatsink thermistor failure</p> <p>4) Thermistor failure</p> <p>5) Pressure sensor failure</p> <p>6) Over-current break</p> <p>7) Refrigerant overcharge</p> <p>Note1: Frost prevention tripping only under cooling mode may be considered in addition to the above. (Freeze protection is detected by one or all indoor units.)</p> <p>Note2: Even the second stop is not considered as an error when some specified errors occur. (eg. The third stop is considered as an error when the thermistor error occurs.)</p>	<p>(1) Check the mode operated in the past by displaying preliminary error history on LED display with SW4.</p> <p>(2) Reoperate the unit to find the mode that stops the unit by displaying preliminary error history on LED display with SW4. Refer to the reference page for each error mode.</p> <p>*Display the indoor piping temperature table with SW4 to check whether the freeze proof operation runs properly, and check the temperature.</p> <p>Refer to the following page(s).9 LED Status Indicators on the Outdoor Unit Circuit Board(page 289)</p>

## 8-4 Checking Transmission Waveform and for Electrical Noise Interference

### 8-4-1 M-NET

Control is performed by exchanging signals between the outdoor unit and the indoor unit (ME remote controller) through M-NET transmission. Noise interference on the transmission line will interrupt the normal transmission, leading to erroneous operation.

#### (1) Symptoms caused by noise interference on the transmission line

Cause	Erroneous operation	Error code	Error code definition
Noise interference on the transmission line	Signal is transformed and will be misjudged as the signal of another address.	6600	Address overlap
	Transmission wave pattern is transformed due to the noise creating a new signal	6602	Transmission processor hardware error
	Transmission wave pattern is transformed due to the noise, and will not be received normally leading to no acknowledgement (ACK).	6607	No ACK error
	Transmission cannot be performed due to the fine noise.	6603	Transmission line bus busy error
	Transmission is successful; however, the acknowledgement (ACK) or the response cannot be received normally due to the noise.	6607 6608	No ACK error No response error

#### (2) Wave shape check

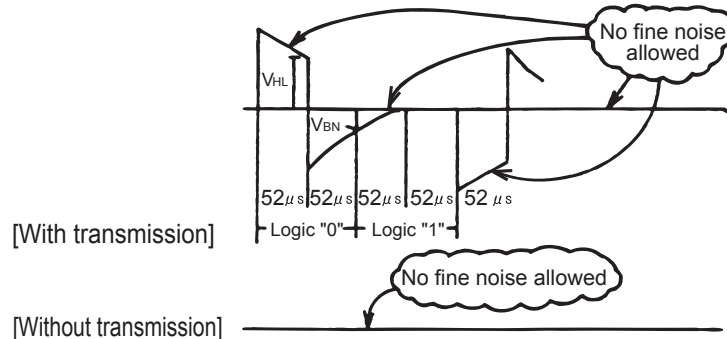

#### Wave shape check

Check the wave pattern of the transmission line with an oscilloscope. The following conditions must be met.

- Small wave pattern (noise) must not exist on the transmission signal. (Minute noise (approximately 1V) can be generated by DC-DC converter or the inverter operation; however, such noise is not a problem when the shield of the transmission line is grounded.)
- The sectional voltage level of transmission signal should be as follows.

Logic	Voltage level of the transmission line
0	$V_{HL} = 2.5V$ or higher
1	$V_{BN} = 1.3V$ or below

**(3) Check method and remedy**

1) Measures against noise

Check the followings when noise exists on the wave or the errors described in (1) occur.

	Error code definition	Remedy
Check that the wiring work is performed according to wiring specifications.	1. The transmission line and the power line are not wired too closely.	Isolate the transmission line from the power line (5cm [1-31/32"] or more). Do not insert them in the same conduit.
	2. The transmission line is not bundled with that for another systems.	The transmission line must be isolated from another transmission line. When they are bundled, erroneous operation may be caused.
	3. The specified wire is used for the transmission line.	Use the specified transmission line. Type: Shielded wire CVVS/CPEVS/MVVS (For ME remote controller) Diameter: 1.25mm <sup>2</sup> [AWG16] or more (Remote controller wire: 0.3 - 1.25mm <sup>2</sup> [AWG22-16])
	4. When the transmission line is daisy-chained on the indoor unit terminals, are the shields daisy-chained on the terminals, too?	The transmission is two-wire daisy-chained. The shielded wire must be also daisy-chained. When the shielded cable is not daisy-chained, the noise cannot be reduced enough.
Check that the grounding work is performed according to grounding specifications.	5. Is the shield of the indoor-outdoor transmission cable grounded to the earth terminal on the outdoor unit?	Connect the shield of the indoor-outdoor transmission cable to the earth terminal (E) on the outdoor unit. If no grounding is provided, the noise on the transmission line cannot escape leading to change of the transmission signal.
	6. Check the treatment method of the shield of the transmission line (for centralized control).	The transmission cable for centralized control is less subject to noise interference if it is grounded to the outdoor unit whose power jumper cable was moved from CN41 to CN40 or to the power supply unit. The environment against noise varies depending on the distance of the transmission lines, the number of the connected units, the type of the controllers to be connected, or the environment of the installation site. Therefore, the transmission line work for centralized control must be performed as follows.  1. When no grounding is provided: Ground the shield of the transmission cable by connecting to the outdoor unit whose power jumper connector was moved from CN41 to CN40 or to the power supply unit.  2. When an error occurs even though one point grounding is provided: Ground the shield on all outdoor units.

2) Check the followings when the error "6607" occurs, or "HO" appears on the display on the remote controller.

Error code definition	Remedy
7. The farthest distance of transmission line is 200m [656ft] or longer.	Check that the farthest distance from the outdoor unit to the indoor unit and to the remote controller is within 200m [656ft].
8. The types of transmission lines are different.	Use the specified transmission line. Type: Shielded wire CVVS/CPEVS/MVVS (For ME remote controller) Diameter: 1.25mm <sup>2</sup> [AWG16] or more (Remote controller wire: 0.3-1.25mm <sup>2</sup> [AWG22-16])
9. Outdoor unit circuit board failure	Replace the outdoor unit control board or the power supply board for the transmission line.
10. Indoor unit circuit board failure or remote controller failure	Replace the indoor unit circuit board or the remote controller.
11. The MA remote controller is connected to the M-NET transmission line.	Connect the MA remote controller to the terminal block for MA remote controller (TB15).

## 8-4-2 MA Remote Controller

The communication between the MA remote controller and the indoor unit is performed with current tone burst.

### (1) Symptoms caused by noise interference on the transmission line

If noise is generated on the transmission line, and the communication between the MA remote controller and the indoor unit is interrupted for 3 minutes in a row, MA transmission error (6831) will occur.

### (2) Confirmation of transmission specifications and wave pattern

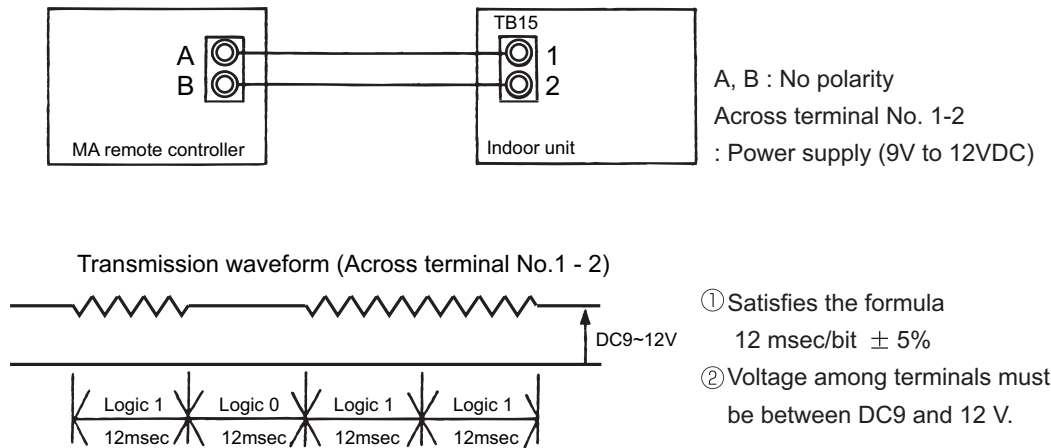

# 8-5 Pressure Sensor Circuit Configuration and Troubleshooting Pressure Sensor Problems

## 8-5-1 Comparing the High-Pressure Sensor Measurement and Gauge Pressure

By configuring the digital display setting switch (SW4 (when SW6-10 is set to OFF)) as shown in the figure below, the pressure as measured by the high-pressure sensor appears on the LED1 on the control board.

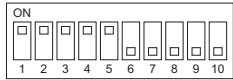
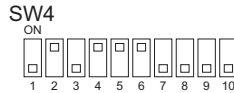

The figure at left shows that the switches 1 through 5 are set to ON and 6 through 10 are set to OFF.

- (1) While the sensor is stopped, compare the gauge pressure and the pressure displayed on self-diagnosis LED1.**
  - 1) When the gauge pressure is between 0 and 0.098MPa [14psi], internal pressure is caused due to gas leak.
  - 2) When the pressure displayed on self-diagnosis LED1 is between 0 and 0.098MPa [14psi], the connector may be defective or be disconnected. Check the connector and go to (4).
  - 3) When the pressure displayed on self-diagnosis LED1 exceeds 4.15MPa [601psi], go to (3).
  - 4) If other than 1), 2) or 3), compare the pressures while the sensor is running. Go to (2).
- (2) Compare the gauge pressure and the pressure displayed on self-diagnosis LED1 while the sensor is running. (Compare them by MPa [psi] unit.)**
  - 1) When the difference between both pressures is within 0.098MPa [14psi], both the high pressure sensor and the control board are normal.
  - 2) When the difference between both pressures exceeds 0.098MPa [14psi], the high pressure sensor has a problem. (performance deterioration)
  - 3) When the pressure displayed on self-diagnosis LED1 does not change, the high pressure sensor has a problem.
- (3) Remove the high pressure sensor from the control board to check the pressure on the self-diagnosis LED1.**
  - 1) When the pressure displayed on self-diagnosis LED1 is between 0 and 0.098MPa [14psi], the high pressure sensor has a problem.
  - 2) When the pressure displayed on self-diagnosis LED1 is approximately 4.15MPa [601psi], the control board has a problem.
- (4) Remove the high pressure sensor from the control board, and short-circuit between the No.2 and 3 connectors (63HS1) to check the pressure with self-diagnosis LED1.**
  - 1) When the pressure displayed on the self-diagnosis LED1 exceeds 4.15MPa [601psi], the high pressure sensor has a problem.
  - 2) If other than 1), the control board has a problem.

## 8-5-2 High-Pressure Sensor Configuration (63HS1)

The high pressure sensor consists of the circuit shown in the figure below. If DC 5V is applied between the red and the black wires, voltage corresponding to the pressure between the white and the black wires will be output, and the value of this voltage will be converted by the microcomputer. The output voltage is 0.071V per 0.098MPa [14psi].

**Note**

The pressure sensor on the body side is designed to connect to the connector. The connector pin number on the body side is different from that on the control board side.

	Body side	Control board side
Vcc	Pin 1	Pin 3
Vout	Pin 2	Pin 2
GND	Pin 3	Pin 1

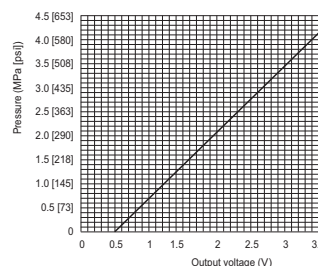
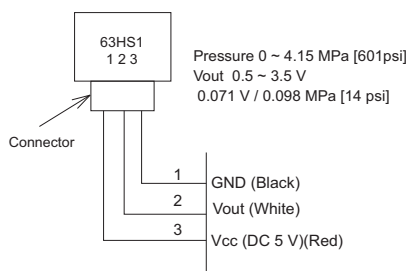

### 8-5-3 Comparing the Low-Pressure Sensor Measurement and Gauge Pressure

By configuring the digital display setting switch (SW4 (when SW6-10 is set to OFF)) as shown in the figure below, the pressure as measured by the low-pressure sensor appears on the LED1 on the control board.

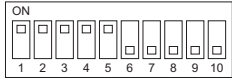
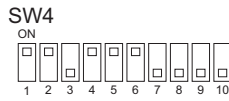

The figure at left shows that the switches 1 through 5 are set to ON and 6 through 10 are set to OFF.

- (1) While the sensor is stopped, compare the gauge pressure and the pressure displayed on self-diagnosis LED1.**
  - 1) When the gauge pressure is between 0 and 0.098MPa [14psi], internal pressure is caused due to gas leak.
  - 2) When the pressure displayed on self-diagnosis LED1 is between 0 and 0.098MPa [14psi], the connector may be defective or be disconnected. Check the connector and go to (4).
  - 3) When the pressure displayed on self-diagnosis LED1 exceeds 1.7MPa [247psi], go to (3).
  - 4) If other than 1), 2) or 3), compare the pressures while the sensor is running. Go to (2).
- (2) Compare the gauge pressure and the pressure displayed on self-diagnosis LED1 while the sensor is running.(Compare them by MPa [psi] unit.)**
  - 1) When the difference between both pressures is within 0.03MPa [4psi], both the low pressure sensor and the control board are normal.
  - 2) When the difference between both pressures exceeds 0.03MPa [4psi], the low pressure sensor has a problem. (performance deterioration)
  - 3) When the pressure displayed on the self-diagnosis LED1 does not change, the low pressure sensor has a problem.
- (3) Remove the low pressure sensor from the control board to check the pressure with the self-diagnosis LED1 display.**
  - 1) When the pressure displayed on the self-diagnosis LED1 is between 0 and 0.098MPa [14psi], the low pressure sensor has a problem.
  - 2) When the pressure displayed on self-diagnosis LED1 is approximately 1.7MPa [247psi], the control board has a problem.
    - When the outdoor temperature is 30°C [86°F] or less, the control board has a problem.
    - When the outdoor temperature exceeds 30°C [86°F], go to (5).
- (4) Remove the low pressure sensor from the control board, and short-circuit between the No.2 and 3 connectors (63LS:CN202) to check the pressure with the self-diagnosis LED1.**
  - 1) When the pressure displayed on the self-diagnosis LED1 exceeds 1.7MPa [247psi], the low pressure sensor has a problem.
  - 2) If other than 1), the control board has a problem.
- (5) Remove the high pressure sensor (63HS1) from the control board, and insert it into the connector for the low pressure sensor (63LS) to check the pressure with the self-diagnosis LED1.**
  - 1) When the pressure displayed on the self-diagnosis LED1 exceeds 1.7MPa [247psi], the control board has a problem.
  - 2) If other than 1), the control board has a problem.

### 8-5-4 Low-Pressure Sensor Configuration (63LS)

The low pressure sensor consists of the circuit shown in the figure below. If DC5V is applied between the red and the black wires, voltage corresponding to the pressure between the white and the black wires will be output, and the value of this voltage will be converted by the microcomputer. The output voltage is 0.173V per 0.098MPa [14psi].

**Note**

The pressure sensor on the body side is designed to connect to the connector. The connector pin number on the body side is different from that on the control board side.

	Body side	Control board side
Vcc	Pin 1	Pin 3
Vout	Pin 2	Pin 2
GND	Pin 3	Pin 1

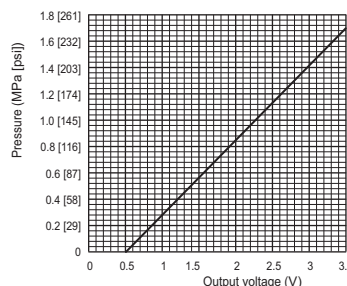
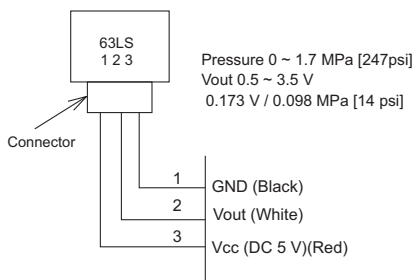



## 8-6 Troubleshooting Solenoid Valve Problems

Check whether the output signal from the control board and the operation of the solenoid valve match. Setting the self-diagnosis switch (SW4) as shown in the figure below causes the ON signal of each relay to be output to the LED's. Each LED shows whether the relays for the following parts are ON or OFF. LEDs light up when relays are ON.

**Note**

The circuits on some parts are closed when the relays are ON. Refer to the following instructions.

SW4 (SW6-10:OFF)		Display							
		LD1	LD2	LD3	LD4	LD5	LD6	LD7	LD8
	Upper	21S4a	SV10	CH11		SV1a			SV11
	Lower			21S4b	SV5b				
	Upper					21S4c		SV9	
	Lower								



The figure at left shows that the switches 1 through 5 are set to ON and 6 through 10 are set to OFF.

- When a valve malfunctions, check if the wrong solenoid valve coil is not attached the lead wire of the coil is not disconnected, the connector on the board is not inserted wrongly, or the wire for the connector is not disconnected.

**(1) In case of 21S4a (4-way switching valve)**

About this 4-way valve

When not powered:

Conducts electricity between the oil separator outlet and heat exchanger, and between the gas ball valve (BV1) and the accumulator to complete the circuit for the cooling cycle.

When powered:

The electricity runs between the oil separator and the gas ball valve, and between the heat exchanger and the accumulator. This circulation is for heating.

Check the LED display and the intake and the discharge temperature for the 4-way valve to check whether the valve has no faults and the electricity runs between where and where. Do not touch the pipe when checking the temperature, as the pipe on the oil separator side will be hot.

**Note**

Do not give an impact from outside, as the outer hull will be deformed leading to the malfunction of the inner valve.

**(2) In case of 21S4b (4-way switching valve), 21S4c (4-way switching valve) (only for P450 and P500 models)**

About this 4-way valve

When not powered:

Conducts electricity between the oil separator outlet and the heat exchanger1 (the top heat exchanger) and opens and closes the heat exchanger circuit for the heating and cooling cycles.

When powered:

The electricity runs between the heat exchanger and the accumulator, and the valve opens or closes the heat exchanger circuit when cooling or heating.

Whether the valve has no fault can be checked by checking the LED display and the switching sound; however, it may be difficult to check by the sound, as the switching coincides with 21S4b or 21S4c. In this case, check the intake and the discharge temperature for the 4-way valve to check that the electricity runs between where and where.

**Note**

- Do not touch the valve when checking the temperature, as it will be hot.
- Do not give an impact from outside, as the outer hull will be deformed leading to the malfunction of the inner valve.



**(3) In case of SV1a (Bypass valve)**

This solenoid valve opens when powered (Relay ON).

- 1) At compressor start-up, the SV1a turns on for 4 minutes, and the operation can be checked by the self-diagnosis LED display and the closing sound.
- 2) To check whether the valve is open or closed, check the change of the SV1a downstream piping temperature while the valve is being powered. Even when the valve is closed, high-temperature refrigerant flows inside the capillary next to the valve. (Therefore, temperature of the downstream piping will not be low with the valve closed.)

**(4) In the case of SV5b (2-way valve) , SV5c (2-way valve) (only for P450 and P500 models)**

This solenoid valve is a switching valve that closes when energized. Proper operation of this valve can be checked on the LED and by the switching sound. During the cooling mode, SV5b and 21S4b, SV5c and 21S4c, are switched simultaneously, which may make it difficult to check for proper operation of the SV5b or SV5c by listening for the switching sound. If this is the case, the temperature before and after SV5b or SV5c can be used to determine if the refrigerant is the pipe.

**(5) In the case of SV9 (Solenoid valve)**

This solenoid valve is a switching valve that opens when energized. Proper operation of this valve can be checked on the LED display and by the switching sound.

**(6) In the case of SV10 (Solenoid valve)**

This solenoid valve is a switching valve that opens when energized. Proper operation of this valve can be checked on the LED display and by the switching sound.

**(7) In the case of SV11 (Solenoid valve)**

This solenoid valve is a switching valve that opens when energized. Proper operation of this valve can be checked on the LED display and by the switching sound.

**Note**

Do not give an impact from outside, as the outer hull will be deformed leading to the malfunction of the inner valve.

# 8-7 Troubleshooting Outdoor Unit Fan Problems

## (1) Fan motor (common items)

- To check the revolution of the fan, check the inverter output state on the self-diagnosis LED, as the inverter on the outdoor fan controls the revolutions of the fan.
- When starting the fan, the fan runs at full speed for 5 seconds.
- When setting the DIP SW4 (when SW6-10 is set to OFF) as shown in the figure below, the inverter output [%] will appear. 100% indicates the full speed and 0% indicates the stopping. (Fan #2 is only on the P450 and P500 models.)

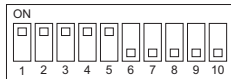
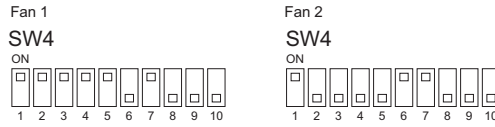

The figure at left shows that the switches 1 through 5 are set to ON and 6 through 10 are set to OFF.

- As the revolution of the fan changes under control, at the interphase or when the indoor unit operation capacity is low, the revolution of the fan may change.
- If the fan does not move or it vibrates, Fan board problem or fan motor problem is suspected. When checking the fan motor for problems by shutting down the power, be sure to disconnect the motor wire from the fan board. If a short-circuited fan board malfunctions, it will keep the fan motor from rotating smoothly. For details, refer to the following page(s).
  - [8-9-7 Checking the Fan Motor for Ground Fault and Coil Resistance Problems](page 269)
  - [8-9-8 Checking the Fan Board Error Detection Circuit at No Load](page 269)
  - [8-9-9 Checking the Fan Inverter for Damage at No Load](page 270)
  - [8-9-10 Checking the Fan Inverter for Damage with Load](page 271)

# 8-8 Troubleshooting LEV Problems

## 8-8-1 General Overview on LEV Operation

LEV (Indoor unit: Linear expansion valve) and LEV2 (Outdoor unit: Linear expansion valve) are stepping-motor-driven valves that operate by receiving the pulse signals from the indoor and outdoor unit control boards.

### (1) Indoor LEV and Outdoor LEV (LEV2)

The valve opening changes according to the number of pulses.

#### 1) Indoor unit control board and the LEV (Indoor unit: Linear expansion valve)

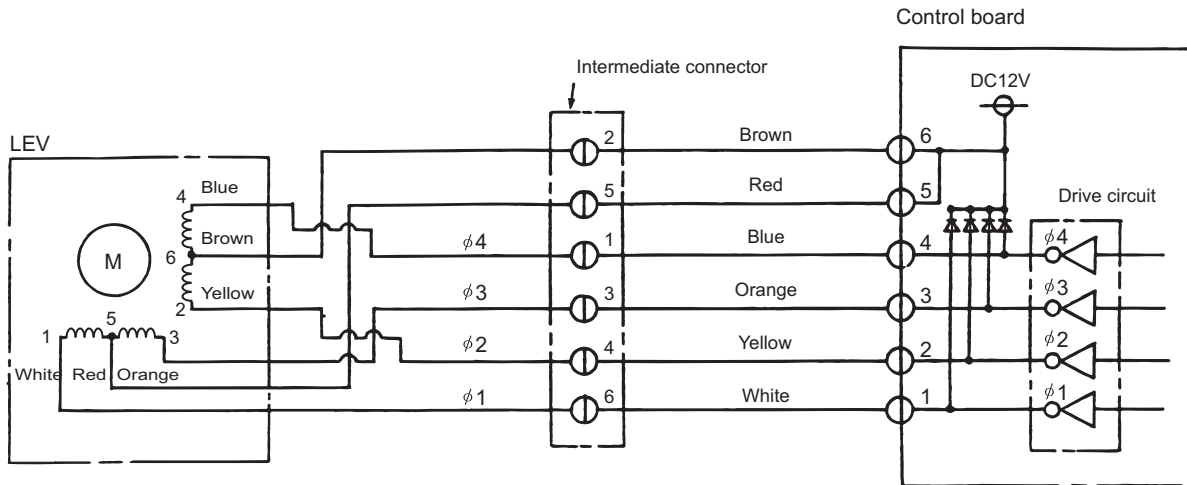

Note. The connector numbers on the intermediate connector and the connector on the control board differ. Check the color of the lead wire to judge the number.

#### 2) Outdoor unit control board and the LEV (Outdoor unit: Linear expansion valve)

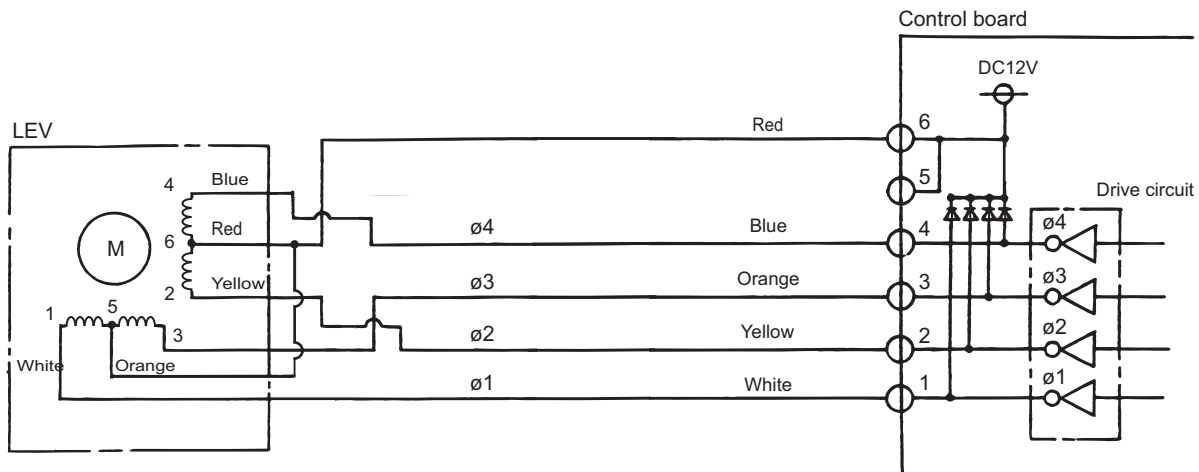

3) Pulse signal output and valve operation

Output (phase) number	Output state			
	1	2	3	4
φ 1	ON	OFF	OFF	ON
φ 2	ON	ON	OFF	OFF
φ 3	OFF	ON	ON	OFF
φ 4	OFF	OFF	ON	ON

Output pulses change in the following orders when the  
 Valve is closed; 1 → 2 → 3 → 4 → 1  
 Valve is open; 4 → 3 → 2 → 1 → 4

- \*1. When the LEV opening angle does not change, all the output phases will be off.
- \*2. When the output is open phase or remains ON, the motor cannot run smoothly, and rattles and vibrates.

4) LEV closing and opening operation

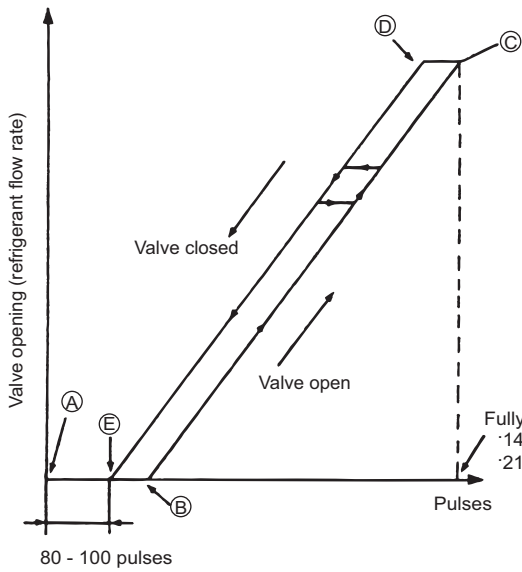

\*Upon power on, the indoor unit circuit board sends a 2200 pulse signal to the indoor unit LEV and a 3200 pulse signal to the outdoor unit LEV to determine the valve position and always brings the valve to the position as indicated by "A" in the diagram.

When the valve operates smoothly, no sound from LEV or no vibration occurs, however, when the pulses change from E to A in the chart or the valve is locked, a big sound occurs.

\*Whether a sound is generated or not can be determined by holding a screwdriver against it, then placing your ear against the handle.

\*1 The LEV opening may become greater depending on the operation status.

**(2) Outdoor LEV (LEV1)**

The valve opening changes according to the number of pulses.

1) Connections between the outdoor control board and LEV1 (outdoor expansion valve)

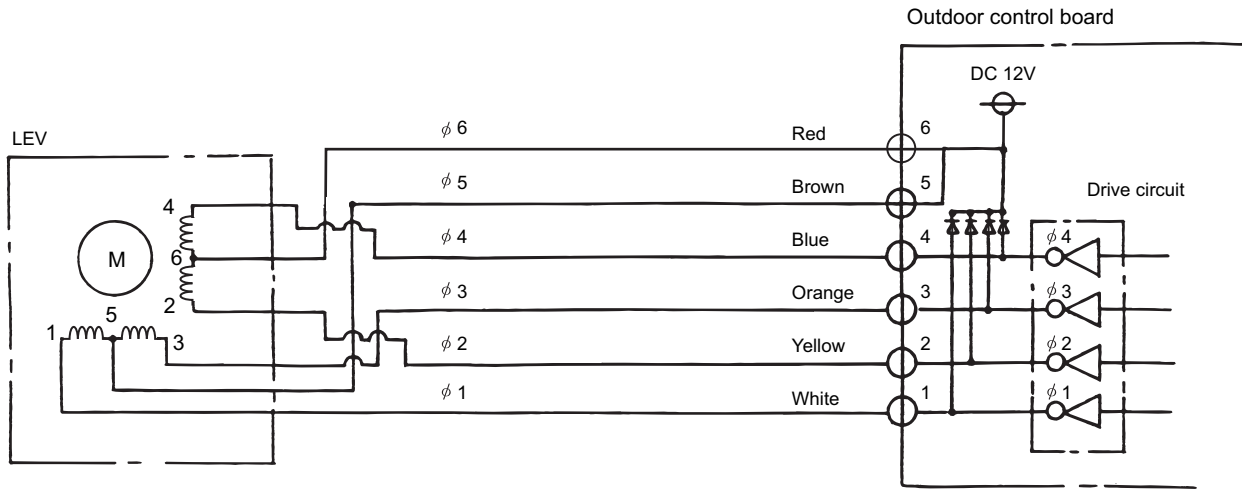

2) Pulse signal output and valve operation

Output (phase) number	Output state							
	1	2	3	4	5	6	7	8
φ 1	ON	OFF	OFF	OFF	OFF	OFF	ON	ON
φ 2	ON	ON	ON	OFF	OFF	OFF	OFF	OFF
φ 3	OFF	OFF	ON	ON	ON	OFF	OFF	OFF
φ 4	OFF	OFF	OFF	OFF	ON	ON	ON	OFF

Output pulses change in the following orders when the  
 Valve is open; 1 → 2 → 3 → 4 → 5 → 6 → 7 → 8 → 1  
 Valve is closed; 8 → 7 → 6 → 5 → 4 → 3 → 2 → 1 → 8

- \*1. When the LEV opening angle does not change, all the output phases will be off.
- \*2. When the output is open phase or remains ON, the motor cannot run smoothly, and rattles and vibrates.

3) LEV valve closing and opening operation

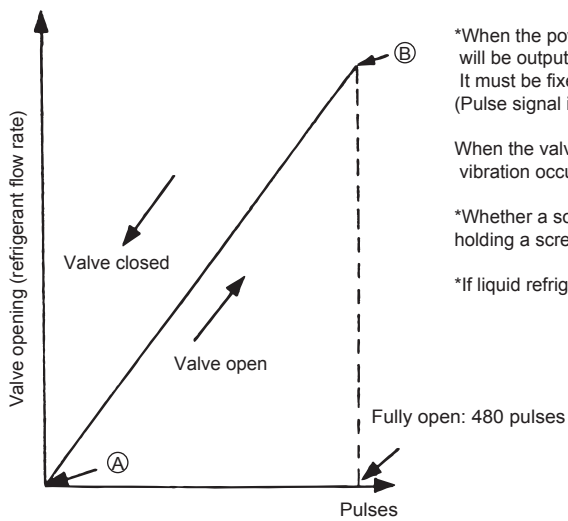

\*When the power is turned on, the valve closing signal of 520 pulses will be output from the indoor board to LEV to fix the valve position. It must be fixed at point (A)  
 (Pulse signal is output for approximately 17 seconds.)

When the valve operates smoothly, there is no sound from the LEV and no vibration occurs, but when the valve is locked, noise is generated.

\*Whether a sound is generated or not can be determined by holding a screwdriver against it, then placing your ear against the handle.

\*If liquid refrigerant flows inside the LEV, the sound may become smaller.

## 8-8-2 Possible Problems and Solutions

**Note**

The specifications of the outdoor unit (outdoor LEV) and the indoor unit (indoor LEV) differ. Therefore, remedies for each failure may vary. Check the remedy specified for the appropriate LEV as indicated in the right column.

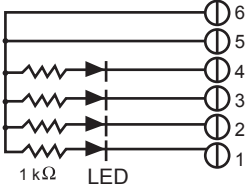
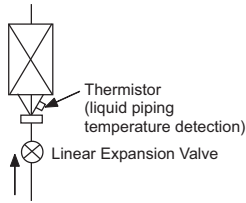
Malfunction mode	Judgment method	Remedy	Target LEV
Microcomputer driver circuit failure	<p>Disconnect the control board connector and connect the check LED as shown in the figure below.</p>  <p>resistance : 0.25W 1kΩ LED : DC15V 20mA or more</p> <p>When the main power is turned on, the indoor unit circuit board outputs pulse signals to the indoor unit LEV for 10 seconds, and the outdoor unit circuit board outputs pulse signals to the outdoor unit LEV for 17 seconds. If any of the LED remains lit or unlit, the drive circuit is faulty.</p>	When the drive circuit has a problem, replace the control board.	Indoor Outdoor
LEV mechanism is locked	If the LEV is locked, the drive motor runs idle, and makes a small clicking sound. When the valve makes a closing and opening sound, the valve has a problem.	Replace the LEV.	Indoor Outdoor
Disconnected or short-circuited LEV motor coil	Measure the resistance between coils (red-white, red-orange, brown-yellow, brown-blue) with a tester. When the resistance is in the range of 150Ω ± 10%, the LEV is normal.	Replace the LEV coils.	Indoor
	Measure the resistance between coils (red-white, red-orange, red-yellow, red-blue) with a tester. When the resistance is in the range of 100Ω ± 10%, the LEV is normal.	Replace the LEV coils.	Outdoor (LEV2a, LEV2b)
	Measure resistance between the coils (red - white, red -orange, brown - yellow, brown - blue) using a tester. They are normal if resistance is 46Ω ± 3%.	Replace the LEV coils.	Outdoor (LEV1)
Incomplete sealing (leak from the valve)	<p>When checking the refrigerant leak from the indoor LEV, run the target indoor unit in the fan mode, and the other indoor units in the cooling mode. Then, check the liquid temperature (TH22) with the self-diagnosis LED. When the unit is running in the fan mode, the LEV is fully closed, and the temperature detected by the thermistor is not low. If there is a leak, however, the temperature will be low. If the temperature is extremely low compared with the inlet temperature displayed on the remote controller, the LEV is not properly sealed, however, if there is a little leak, it is not necessary to replace the LEV when there are no effects to other parts.</p> 	If there is a large amount of leakage, replace the LEV.	Indoor
Faulty wire connections in the connector or faulty contact	<ol style="list-style-type: none"> <li>Check for loose pins on the connector and check the colors of the lead wires visually</li> <li>Disconnect the control board's connector and conduct a continuity check using a tester.</li> </ol>	Check the continuity at the points where an error occurs.	Indoor Outdoor

### 8-8-3 Coil Removal Instructions

**(1) Outdoor unit LEV (LEV1)**

1) LEV component

As shown in the figure, the outdoor LEV is made in such a way that the coils and the body can be separated.

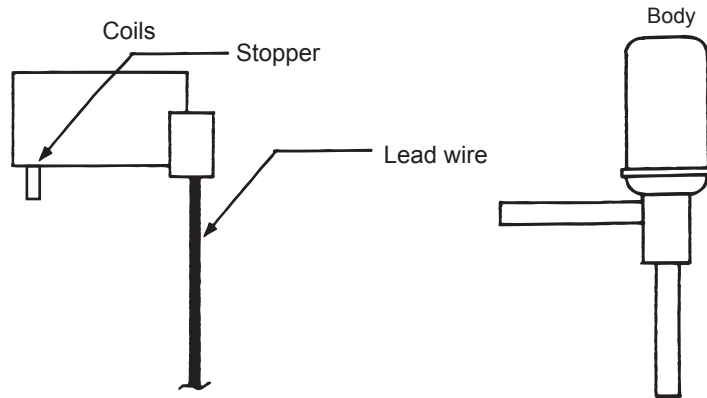

2) Removing the coils

Fasten the body tightly at the bottom (Part A in the figure) so that the body will not move, then pull out the coils toward the top. If the coils are pulled out without the body gripped, undue force will be applied and the pipe will be bent.

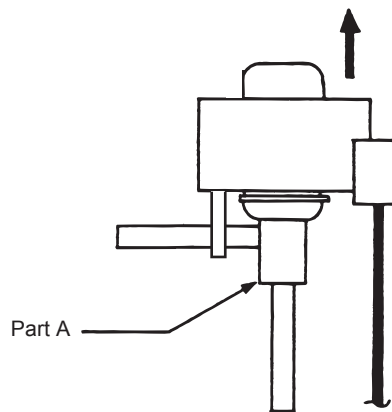

3) Installing the coils

Fix the body tightly at the bottom (Part A in the figure) so that the body will not move, then insert the coils from the top, and insert the coil stopper securely in the pipe on the body. Hold the body when pulling out the coils to prevent so that the pipe will not be bent.

If the coils are pushed without the body gripped, undue force will be applied and the pipe will be bent. Hold the body when pulling out the coils to prevent so that the pipe will not be bent.

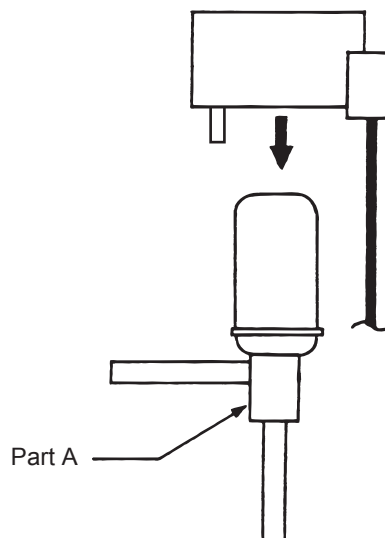

**(2) Outdoor unit LEV (LEV2a, LEV2b)**

1) Components

The outdoor unit LEV consists of a coil and a valve body that can be separated from each other.

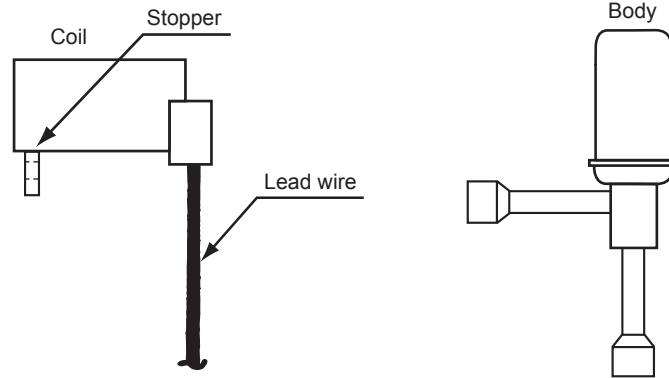

2) Removing the coil

Securely hold the LEV at the bottom (as indicated by A in the figure), and turn the coil. After checking that the stopper is removed, pull up and out the coil. When removing the coil, hold the LEV body securely to prevent undue force from being placed on the pipe and bending the pipe.

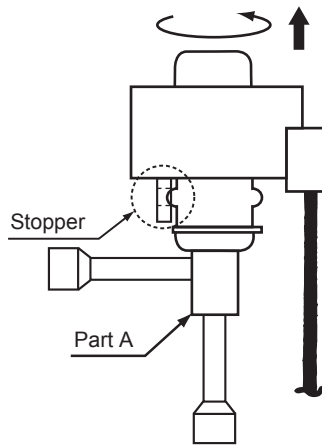

3) Installing the coil

Securely hold the bottom of the LEV (section A in the figure), insert the coil from above, and turn the coil until the coil stopper is properly installed on the LEV body. When removing the coil, hold the LEV body securely to prevent undue force from being placed on the pipe and bending the pipe.

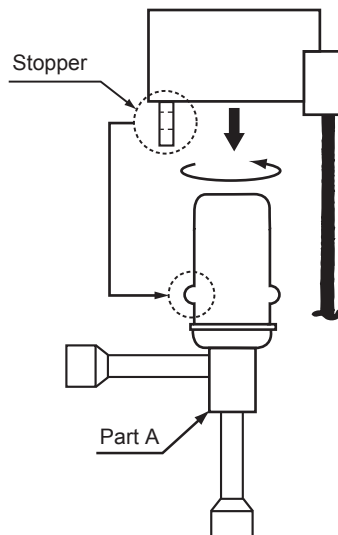



## 8-9 Troubleshooting Inverter Problems

### 8-9-1 Inverter-Related Problems and Solutions

- Replace only the compressor if only the compressor is found to be defective. (Overcurrent will flow through the inverter if the compressor is damaged, however, the power supply is automatically cut when overcurrent is detected, protecting the inverter from damage. Make sure that the model selection switches on the outdoor unit (Dip switches SW5-3 through 5-8 on the outdoor unit control board) are set correctly. For switch settings, refer to the following page(s). [7-9-2 Error Code [7101]](page 227))
- Replace only the fan motor if only the fan motor is found to be defective. (Overcurrent will flow through the inverter if the fan motor is damaged, however, the power supply is automatically cut when overcurrent is detected, protecting the inverter from damage.)
- Replace the defective components if the inverter is found to be defective.
- If both the compressor and the inverter are found to be defective, replace the defective component(s) of both devices.

#### (1) Inverter-related problems: Troubleshooting and remedies

- 1) Inside the inverter is a large capacity electrolytic capacitor, and the residual voltage that remains after the main power is turned off presents a risk of electric shock. Before inspecting the inside of the control box, turn off the power, leave the unit turned off for at least 10 minutes, and check that the voltage across FT-P and FT-N terminals or SC-P and SC-N terminals on the inverter board has dropped to 20 VDC or less. (It takes approximately 10 minutes to discharge electricity after the power is turned off.)
- 2) Before starting maintenance work, disconnect the connector (CNINV) on the outdoor unit fan board and CN1 on the inverter board (or CNFAN2 on the capacitor board). Before connecting or disconnecting connectors, make sure that the outdoor unit fans are stopped and that the voltage of the main circuit capacitor is 20 VDC or below. If the outdoor unit fan is turned by strong winds, the main circuit capacitor will be energized and poses an electric shock hazard. Refer to the wiring diagram name plate for details.
- 3) To connect wiring to TB7, check that the voltage is 20 VDC or below.
- 4) After completion of maintenance work, reconnect the connector (CNINV) on the fan board and connector (CN1) on the inverter board (or the connector (CNFAN2) on the capacitor board).
- 5) The IPM on the inverter becomes damaged if there are loose screws or connectors. If a problem occurs after replacing some of the parts, mixed up wiring is often the cause of the problem. Check for proper connection of the wiring, screws, connectors, and Faston terminals.
- 6) To avoid damage to the circuit board, do not connect or disconnect the inverter-related connectors with the main power turned on.
- 7) Faston terminals have a locking function. Make sure the terminals are securely locked in place after insertion.

Press the tab on the terminals to remove them.

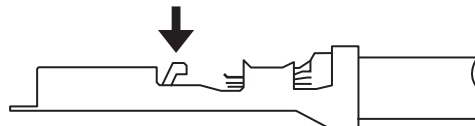

- 8) When the IPM or IGBT is replaced, apply a thin layer of heat radiation grease that is supplied evenly to these parts. Wipe off any grease that may get on the wiring terminal to avoid terminal contact failure.
- 9) Faulty wiring to the compressor damages the compressor. Connect the wiring in the correct phase sequence.
- 10) When the power is turned on, the compressor and the heater are energized even while they are not operating. Before turning on the power, disconnect all power supply wires from the compressor terminal block, and measure the insulation resistance of the compressor. Check the compressor for a ground fault. If the insulation resistance is 1.0 MΩ or below, connect all power supply wires to the compressor or the heater, and turn on the power to the outdoor unit. (The liquid refrigerant in the compressor will evaporate by energizing the compressor.)

	Error display/failure condition	Measure/inspection item
[1]	Inverter related errors 4250, 4255, 4256, 4220, 4225, 4226, 4230, 4240, 4260, 5301, 5305, 5306, 0403	Implement solutions that correspond to the error codes or preliminary error codes.[7-1 Error Code and Preliminary Error Code Lists](page 165)
[2]	Main power breaker trip	Refer to the following page(s). [8-9-12 Solutions for the Main No-Fuse Breaker Trip](page 272)
[3]	Main power earth leakage breaker trip	Refer to the following page(s). [8-9-13 Solutions for the Main Earth Leakage Breaker Trip](page 272)
[4]	Only the compressor does not operate.	Check the inverter frequency on the LED monitor. If the frequency indicates that the units are in operation, refer to the following page(s). [8-9-5 Checking the Inverter for Damage during Compressor Operation](page 267)
[5]	The compressor vibrates violently at all times or makes an abnormal sound.	Refer to the following page(s). [8-9-5 Checking the Inverter for Damage during Compressor Operation](page 267)
[6]	Compressor rotation speed does not reach the specified speed.	<1> Check for problems with compressor current and heatsink temperature. <2> Check for imbalance in power supply voltage. *Approximate target: 3% or less.
[7]	Only the fan motor does not operate.	Check the inverter frequency on the LED monitor. If the frequency indicates that the units are in operation, refer to the following page(s). [8-9-8 Checking the Fan Board Error Detection Circuit at No Load](page 269) [8-9-9 Checking the Fan Inverter for Damage at No Load](page 270) [8-9-10 Checking the Fan Inverter for Damage with Load](page 271)
[8]	The fan motor shakes violently at all times or makes an abnormal sound.	Check the inverter frequency on the LED monitor. If the frequency indicates that the units are in operation, refer to the following page(s). [8-9-8 Checking the Fan Board Error Detection Circuit at No Load](page 269) [8-9-9 Checking the Fan Inverter for Damage at No Load](page 270) [8-9-10 Checking the Fan Inverter for Damage with Load](page 271)
[9]	Noise is picked up by the peripheral device	<1> Check that power supply wiring of the peripheral device does not run close to the power supply wiring of the outdoor unit. <2> Check if the inverter output wiring is not running parallel to the power supply wiring and the transmission lines. <3> Check that the shielded wire is used as the transmission line when it is required, and check that the grounding work is performed properly on the shielded wire. <4> Meg failure for electrical system other than the inverter <5> Attach a ferrite core to the inverter output wiring. (Contact the factory for details of the service part settings.) <6> Provide separate power supply to the air conditioner and other electric appliances. <7> If the problem suddenly appeared, inverter output may have had a ground fault. For details, refer to the following page(s). [8-9-5 Checking the Inverter for Damage during Compressor Operation](page 267) *Contact the factory for cases other than those listed above.
[10]	Sudden malfunction (as a result of external noise.)	<1> Check that the grounding work is performed properly. <2> Check that the shielded wire is used as the transmission line when it is required, and check that the grounding work is performed properly on the shielded wire. <3> Check that neither the transmission line nor the external connection wiring does not run close to another power supply system or does not run through the same conduit pipe. * Contact the factory for cases other than those listed above.

### 8-9-2 Checking the Inverter Board Error Detection Circuit

Items to be checked	Phenomena	Remedy
(1) Remove power supply.	1) Overcurrent error Error code: 4250 Detail code: No. 101, 104, 105, 106, and 107	Replace the INV board.
(2) Disconnect the inverter output wire from the terminals of the INV board (SC-U, SC-V, SC-W).	2) Logic error Error code: 4220 Detail code: No. 111	Replace the INV board.
(3) Apply power supply.	3) ACCT sensor circuit failure Error code: 5301 Detail code: No.117	Replace the INV board.
(4) Put the outdoor unit into operation.	4) IPM open Error code: 5301 Detail code: No.119	Normal

### 8-9-3 Checking the Compressor for Ground Fault and Coil Resistance Problems

Items to be checked	Phenomena	Remedy
Disconnect the compressor wiring, and check the compressor Meg, and coil resistance.	1) Compressor Meg failure Error if less than 1 MΩ.	Check that there is no liquid refrigerant in the compressor. If there is none, replace the compressor.
	2) Compressor coil resistance failure Coil resistance value of 0.72 Ω (20°C [68°F]): P200, P250 models Coil resistance value of 0.32 Ω (20°C [68°F]): P300, P350 models Coil resistance value of 0.30 Ω (20°C [68°F]): P400, model Coil resistance value of 0.43 Ω (20°C [68°F]): P450, P500 models	Replace the compressor.

### 8-9-4 Checking the Inverter for Damage at No-Load

Items to be checked	Phenomena	Remedy
(1) Remove power supply.	1) Inverter-related problems are detected.	Connect the short-circuit connector to CN6 or set SW001-1 to ON, and go to 8-9-2.
(2) Disconnect the inverter output wire from the terminals of the INV board (SC-U, SC-V, SC-W).	2) Inverter voltage is not output at the terminals (SC-U, SC-V, and SC-W)	Replace the INV board.
(3) Disconnect the short-circuit connector from CN6 on the INV board.	3) There is an voltage imbalance between the wires. Greater than 5% imbalance or 5V	Replace the INV board.
(4) Apply power supply.	4) There is no voltage imbalance between the wires.	Normal * Reconnect the short-circuit connector to CN6 or restore SW001 to its original setting after checking the voltage.
(5) Put the outdoor unit into operation. Check the inverter output voltage after the inverter output frequency has stabilized.		

### 8-9-5 Checking the Inverter for Damage during Compressor Operation

Items to be checked	Phenomena	Remedy
Put the outdoor unit into operation. Check the inverter output voltage after the inverter output frequency has stabilized. <INV20Y>	1) Overcurrent-related problems occur immediately after compressor startup. Error code : 4250 Detail code : 101, 102, 106, 107	a. Check items 8-9-2 through 8-9-4 for problems. b. Check that high and low pressures are balanced. c. Check that no liquid refrigerant is present in the compressor and that there is no liquid backflow. →Go to "d." when the problem persists after compressor startup was repeated several times. d. Check that there is a pressure difference between high and low pressures after compressor start-up. →Check the high pressure with LED monitor for changes. Replace the compressor if there is no pressure difference. (the compressor may be locked.)
	2) There is a voltage imbalance between the wires after the inverter output voltage is stabilized. Greater than the larger of the following values: imbalance of 5% or 5V	Replace the INV board if there is a voltage imbalance. Check the belt heater for problems if there is no voltage imbalance. →When the error occurred, liquid refrigerant may have been present in the compressor.

Items to be checked	Phenomena	Remedy
<p>&lt;INV30YC&gt;</p>	<p>3) A BUS circuit error occurs immediately after compressor startup. Error code : 4220 Detail code : 124</p>	<p>a. Check that 12 VDC is supplied to the relay at startup (Check that LED5 lights up.)Between pins 1 (+) and 2 (-) on the CNRY connector</p>
	<p>4) An overcurrent error occurs during operation. Error code : 4250 Detail code : 121,122</p>	<p>b. Replace the inverter board if no problems were found with item a.  [8-9-6 Checking the Converter for Damage during Compressor Operation](page 269)</p>
	<p>5) An overcurrent error occurs immediately after compressor startup. Error code : 4250 Detail code :101,106,107,128</p>	<p>a. Check for refrigerant flooding. →When the problem persists after compressor startup was repeated several times, go to "d" after a certain time after energizing the compressor or the heater. If normal operation is restored, check the belt heater for problems.</p> <p>b. Check that there is a pressure difference between high and low pressures after compressor start-up. →Check the high pressure with LED monitor for changes. Replace the compressor if there is no pressure difference. (the compressor may be locked.)</p> <p>c. Check for interphase voltage imbalance.</p> <p>d. Replace the INV board if no problems were found with the items a or c.</p> <p>e. If the problem persists after replacing the inverter board,[8-9-3 Checking the Compressor for Ground Fault and Coil Resistance Problems](page 266)</p>
	<p>6) An overvoltage error occurs during operation. Error code : 4220 Detail code :109,110,112</p>	<p>[8-9-6 Checking the Converter for Damage during Compressor Operation](page 269)</p>
	<p>7) No problems were found with items 1) through 6).</p>	<p>Normal[8-9-6 Checking the Converter for Damage during Compressor Operation](page 269)</p>

**8-9-6 Checking the Converter for Damage during Compressor Operation**

Items to be checked	Phenomena	Remedy
(1) Operate the outdoor unit.	1) BUS voltage does not boost (does not change)BUS voltage does not boost to approximately between 650 and 750 VDC, or the following errors are detected. Error code : 4220 Detail code : 123	Replace the inverter board.
(2) Check the BUS voltage after the converter circuit went into operation and the BUS voltage has boost. *The voltage generally boost at or above 60 rps, depending on the power source voltage.	2) An overcurrent error occurs after converter circuit goes into operation. Error code : 4250 Detail code : 121,122	a.If the problem persists after startup, replace the inverter board. b.If the problem persists after replacing the inverter board, replace the DCL.
	3) An overvoltage error occurs after converter circuit goes into operation. Error code : 4220 Detail code : 109,110,112	a.If the problem persists after startup, replace the inverter board. b.If the problem persists after replacing the inverter board, replace the DCL.
	4) No problems were found with items 1) through 3).	Normal

**8-9-7 Checking the Fan Motor for Ground Fault and Coil Resistance Problems**

Items to be checked	Phenomena	Remedy
Remove fan motor winding. Check insulation resistance and coil resistance.	1) Fan motor insulation failure. If < 1 MΩ, Defect.	Change fan motor.
	2) Fan motor wire failure. Target coil resistance: Approx. 10 Ω. (Changes with temperature)	Change fan motor.

**8-9-8 Checking the Fan Board Error Detection Circuit at No Load**

Items to be checked	Phenomena	Remedy
(1) Turn off breaker. *Turn power off without fail.	1) Electrical current over load error. Check code: 4255, 4256 Detail code: 101, 104	Change fan board.
(2) Remove fan board CNINV and CNSNR connectors.	2) Logic error Check code: 4225, 4256 Detail code:111	Change fan board.
(3) Turn on breaker. (4) Operate unit.	3) Position error on start up Check code: 5305, 5306 Detail code: 132	Normal *After checking, return connector CNINV & CNSNR. The startup position error will not be cleared unless the CNINV and CNSNR connectors are reconnected as they were.

### 8-9-9 Checking the Fan Inverter for Damage at No Load

Items to be checked	Phenomena	Remedy
(1) Turn off breaker. *Turn power off without fail.	1) Within 30 seconds from the start of operation, an error other than a position error (5305, 5306) (detail code 132) is detected.	Change fan board.
(2) Disconnect the connector CNINV from the fan board.	2) Less than 5V unbalance in the wiring.	Change fan board.
(3) Set fan board switch SW1-1 to ON.  (4) Turn on breaker.  (5) Operate unit. After about 30 seconds under no load with constant voltage output, the code below will be displayed indicating a position error (5305, 5306). Detail code: 132 Also, running with no load produces constant voltage of about 160V.	3) No unbalanced voltage in the wiring. After 30 second, detail code 132 is produced and the system stops.	Normal *After checking, return SW1&CNINV. The startup position error will not be cleared unless the CNINV and CNSNR connectors are reconnected as they were.

### 8-9-10 Checking the Fan Inverter for Damage with Load

Items to be checked	Phenomena	Remedy
(1) Turn off breaker.	1) After operation, electrical overload error or position detection error and unit stops within 10 seconds. Check code: 4255, 4256, 5305, 5306 Detail code: 101, 132	Check for fan motor lock. →If locked, change for fan motor. If the same error is still present after changing fan motor, change Fan board. →If not locked, refer to 3) & 4).
(2) Turn on breaker.	2) RPM error before stat-up Check code: 5305, 5306 Detail code: 134	Change Fan board if the same error occurs after restart.
(3) Operate unit.	3) Electrical current overload error during operation Check code: 4255, 4256 Detail code: 101	a. Check for gusts or windy conditions. b. Go to 8-9-6 if not windy. c. After checking 8-9-6, and there is no problem, change Fan board. d. If replacing Fan board doesn't resolve issue, change fan motor.
	4) Sensor error during operation Check code: 5305, 5306 Detail code: 132, 133	a. Check for gusts or windy conditions. b. If no issues with wind, but the error is still present, change Fan board. c. Change fan motor if Fan board change doesn't resolve issue.
	5) Voltage overload error Check code: 4225, 4226 Detail code: 109	a. Check for gusts or windy conditions. b. Change Fan board if it is not windy.
	6) Load short circuit Check code: 4255, 4256. Detail code: 105	a. Check 8-9-7 and 8-9-8. If no problem, then check wiring for short circuit. b. If there is no problem with item a. above, change fan motor. c. If same error after motor change, change Fan board.
	7) After RPM has stabilized, voltage unbalance of 5%, or 5V.	a. If voltage is unbalanced, go to 8-9-6 b. After checking 8-9-6, and there is no problem, change Fan board. c. If replacing Fan board doesn't resolve issue, change fan motor.

### 8-9-11 Checking the Installation Conditions

Items to be checked	Phenomena	Remedy
(1) Check refrigerant charge.	Overcharge of refrigerant	Return to correct refrigerant charge.
(2) Check outdoor unit branch installation.	The branch approach <500 mm.	Make branch approach >500mm
	Is the branch angle < ±15° to horizontal?	Make branch angle < ±15°



### 8-9-12 Solutions for the Main No-Fuse Breaker Trip

	Items to be checked	Phenomena	Remedy
[1]	Check the breaker capacity.	Use of a non-specified breaker	Replace it with a specified breaker.
[2]	Perform Meg check between the terminals on the power terminal block TB1.	Zero to several ohm, or Meg failure	Check each part and wiring. Refer to the following page(s).[8-9-14 Simple Check on Inverter Circuit Components](page 273)
[3]	Turn on the power again and check again.	1) Main power breaker trip 2) No remote control display	<ul style="list-style-type: none"> <li>♦IGBT module</li> <li>♦Rush current protection resistor</li> <li>♦Electromagnetic relay</li> <li>♦DC reactor</li> </ul>
[4]	Turn on the outdoor unit and check that it operates normally.	1) Operates normally without tripping the main breaker. 2) Main power breaker trip	a) The wiring may have been short-circuited. Search for the wire that short-circuited, and repair it. b) If item a) above is not the cause of the problem, refer to 8-9-2 - 8-9-10

### 8-9-13 Solutions for the Main Earth Leakage Breaker Trip

	Items to be checked	Phenomena	Remedy
[1]	Check the earth leakage breaker capacity and the sensitivity current.	Use of a non-specified earth leakage breaker	Replace with a regulation earth leakage breaker.
[2]	Check the resistance at the power supply terminal block with a megger.	Failure resistance value	Check each part and wiring. Refer to the following page(s).[8-9-14 Simple Check on Inverter Circuit Components](page 273)
[3]	Disconnect the compressor wirings and check the resistance of the compressor with a megger.	Failure compressor if the insulating resistance value is not in specified range. Failure when the insulating resistance value is 1 MΩ or less.	Check that there is no liquid refrigerant in the compressor. If there is none, replace the compressor.
[4]	Disconnect the fan motor wirings and check the resistance of the fan motor with a megger.	Failure fan motor if the insulating resistance value is not in specified range. Failure when the insulating resistance value is 1 MΩ or less.	Replace the fan motor.

**Note**

The insulation resistance could go down to close to 1 MΩ after installation or when the power is kept off for an extended period of time because of the accumulation of refrigerant in the compressor. If the earth leakage breaker is triggered, please use the following procedure to take care of this.

- ♦Disconnect the wires from the compressor's terminal block.
- ♦If the resistance is less than 1 MΩ, switch on the power for the outdoor unit with the wires still disconnected.
- ♦Leave the power on for at least 12 hours.
- ♦Check that the resistance has recovered to 1 MΩ or greater.

**Earth leakage current measurement method**

- ♦For easy on-site measurement of the earth leakage current, enable the filter with a measurement instrument that has filter functions as below, clamp all the power supply wires, and measure.  
Recommended measurement instrument: CLAMP ON LEAK HiTESTER 3283 made by HIOKI E.E. CORPORATION
- ♦When measuring one device alone, measure near the device's power supply terminal block.

## 8-9-14 Simple Check on Inverter Circuit Components

**Note**

Turn off the power of the unit and wait at least 10 minutes, check that the voltage between the FT-P and FT-N terminals on the INV board or between the SC-P and SC-N terminals is 20 VDC or less, and then remove the applicable parts from the control box.

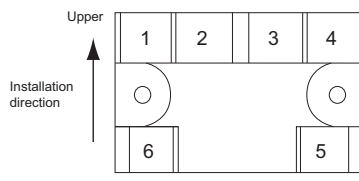
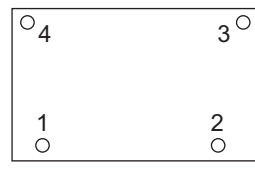
Part name	Judgment method																				
IGBT module	Refer to the following page(s). [8-9-15 Troubleshooting Problems with IGBT Module](page 273)																				
Rush current protection resistor R1, R5	Measure the resistance between terminals R1 and R5: 22 Ω±10%																				
Electromagnetic relay 72C	<p>This electromagnetic relay is rated at DC12V and is driven by a coil. Check the resistance between terminals</p> <p><b>P200-P400</b></p>  <table border="1" data-bbox="829 728 1220 840"> <thead> <tr> <th></th> <th>Check point</th> <th>Checking criteria(W)</th> </tr> </thead> <tbody> <tr> <td>Coil</td> <td>Between Terminals 5 and 6</td> <td>Not to be short-circuited (Center value 75 ohm)</td> </tr> <tr> <td rowspan="2">Contact</td> <td>Between Terminals 1 and 2</td> <td>∞</td> </tr> <tr> <td>Between Terminals 3 and 4</td> <td>∞</td> </tr> </tbody> </table> <p><b>P450-P500</b></p>  <table border="1" data-bbox="758 940 1396 1153"> <thead> <tr> <th></th> <th>Check point</th> <th>Checking criteria</th> </tr> </thead> <tbody> <tr> <td>Coil RY3-RY4</td> <td>Between 1-2 pins and inverter boards RY3 and RY4</td> <td>160Ω±10%</td> </tr> <tr> <td>Contact RY3-RY4</td> <td>Inverter board FT-R21 and SC-P *Faston terminal and SC-P wiring removed</td> <td>Inverter board CNRY Open: ∞ Inverter board CNRY When 12 VDC is being input: 0Ω</td> </tr> </tbody> </table>		Check point	Checking criteria(W)	Coil	Between Terminals 5 and 6	Not to be short-circuited (Center value 75 ohm)	Contact	Between Terminals 1 and 2	∞	Between Terminals 3 and 4	∞		Check point	Checking criteria	Coil RY3-RY4	Between 1-2 pins and inverter boards RY3 and RY4	160Ω±10%	Contact RY3-RY4	Inverter board FT-R21 and SC-P *Faston terminal and SC-P wiring removed	Inverter board CNRY Open: ∞ Inverter board CNRY When 12 VDC is being input: 0Ω
	Check point	Checking criteria(W)																			
Coil	Between Terminals 5 and 6	Not to be short-circuited (Center value 75 ohm)																			
Contact	Between Terminals 1 and 2	∞																			
	Between Terminals 3 and 4	∞																			
	Check point	Checking criteria																			
Coil RY3-RY4	Between 1-2 pins and inverter boards RY3 and RY4	160Ω±10%																			
Contact RY3-RY4	Inverter board FT-R21 and SC-P *Faston terminal and SC-P wiring removed	Inverter board CNRY Open: ∞ Inverter board CNRY When 12 VDC is being input: 0Ω																			
DC reactor DCL	Measure the resistance between terminals: 1Ω or lower (almost 0 Ω) Measure the resistance between terminals and the chassis: ∞																				

## 8-9-15 Troubleshooting Problems with IGBT Module

Measure the resistances between each pair of terminals on the IGBT with a tester, and use the results for troubleshooting. The terminals on the INV board are used for the measurement.

1) Notes on measurement

- Check the polarity before measuring. (On the tester, black normally indicates plus.)
- Check that the resistance is not open (∞ Ω) or not shorted (to 0 Ω).
- The values are for reference, and the margin of errors is allowed.
- The result that is more than double or half of the result that is measured at the same measurement point is not allowed.
- Disconnect all the wiring connected the INV board, and make the measurement.

2) Tester restriction

- Use the tester whose internal electrical power source is 1.5V or greater
- Use the dry-battery-powered tester.

**Note**

(The accurate diode-specific resistance cannot be measured with the button-battery-powered card tester, as the applied voltage is low.)

- Use a low-range tester if possible. A more accurate resistance can be measured.

<INV20Y>

Judgment value (reference)

		Black ( + )				
		SC-P1	FT-N	SC-L1	SC-L2	SC-L3
Red (-)	SC-P1	-	-	5 - 200 Ω	5 - 200 Ω	5 - 200 Ω
	FT-N	-	-	∞	∞	∞
	SC-L1	∞	5 - 200 Ω	-	-	-
	SC-L2	∞	5 - 200 Ω	-	-	-
	SC-L3	∞	5 - 200 Ω	-	-	-

		Black ( + )				
		SC-P2	FT-N	SC-U	SC-V	SC-W
Red (-)	SC-P2	-	-	5 - 200 Ω	5 - 200 Ω	5 - 200 Ω
	FT-N	-	-	∞	∞	∞
	SC-U	∞	5 - 200 Ω	-	-	-
	SC-V	∞	5 - 200 Ω	-	-	-
	SC-W	∞	5 - 200 Ω	-	-	-

INV board external diagram

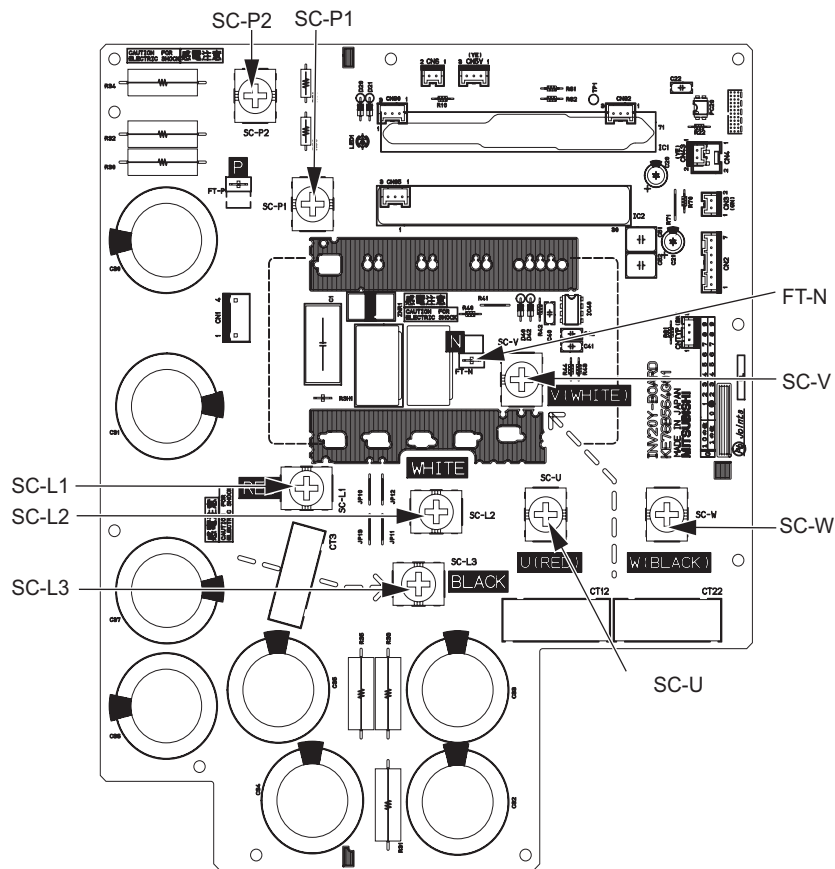

<INV30YC>

Judgment value (reference)

		Black ( + )						
		SC-L1	SC-L2	SC-L3	SC-B	SC-L	FT-R21	SC-N
Red (-)	SC-L1	-	-	-	-	∞	-	5 - 200 Ω
	SC-L2	-	-	-	-	∞	-	5 - 200 Ω
	SC-L3	-	-	-	-	∞	-	5 - 200 Ω
	SC-B	-	-	-	-	-	∞	-
	SC-L	5 - 200 Ω	5 - 200 Ω	5 - 200 Ω	-	-	-	-
	FT-R21	-	-	-	5 - 200 Ω	-	-	-
	SC-N	∞	∞	∞	-	-	-	-

		Black ( + )				
		FT-R21	SC-N	SC-U	SC-V	SC-W
Red (-)	FT-R21	-	-	5 - 200 Ω	5 - 200 Ω	5 - 200 Ω
	SC-N	-	-	∞	∞	∞
	SC-U	∞	5 - 200 Ω	-	-	-
	SC-V	∞	5 - 200 Ω	-	-	-
	SC-W	∞	5 - 200 Ω	-	-	-

INV board external diagram

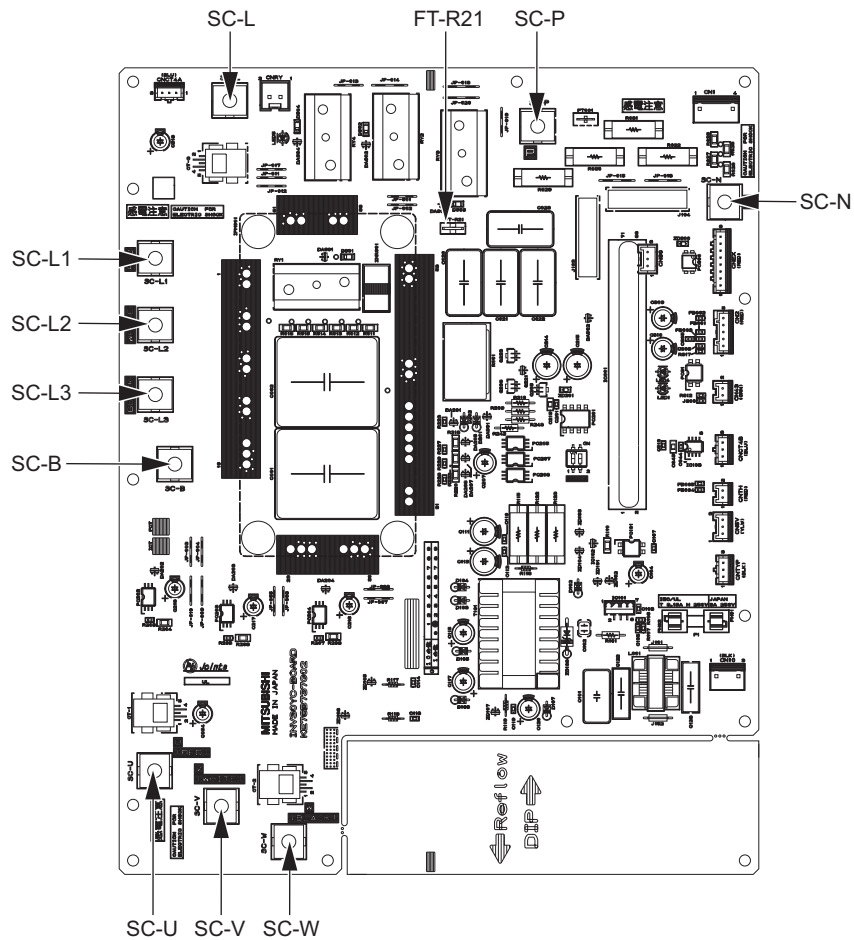

# 8-10 Control Circuit

## 8-10-1 Control Power Supply Function Block

1) PUHY-P200 - P400YKB-A1

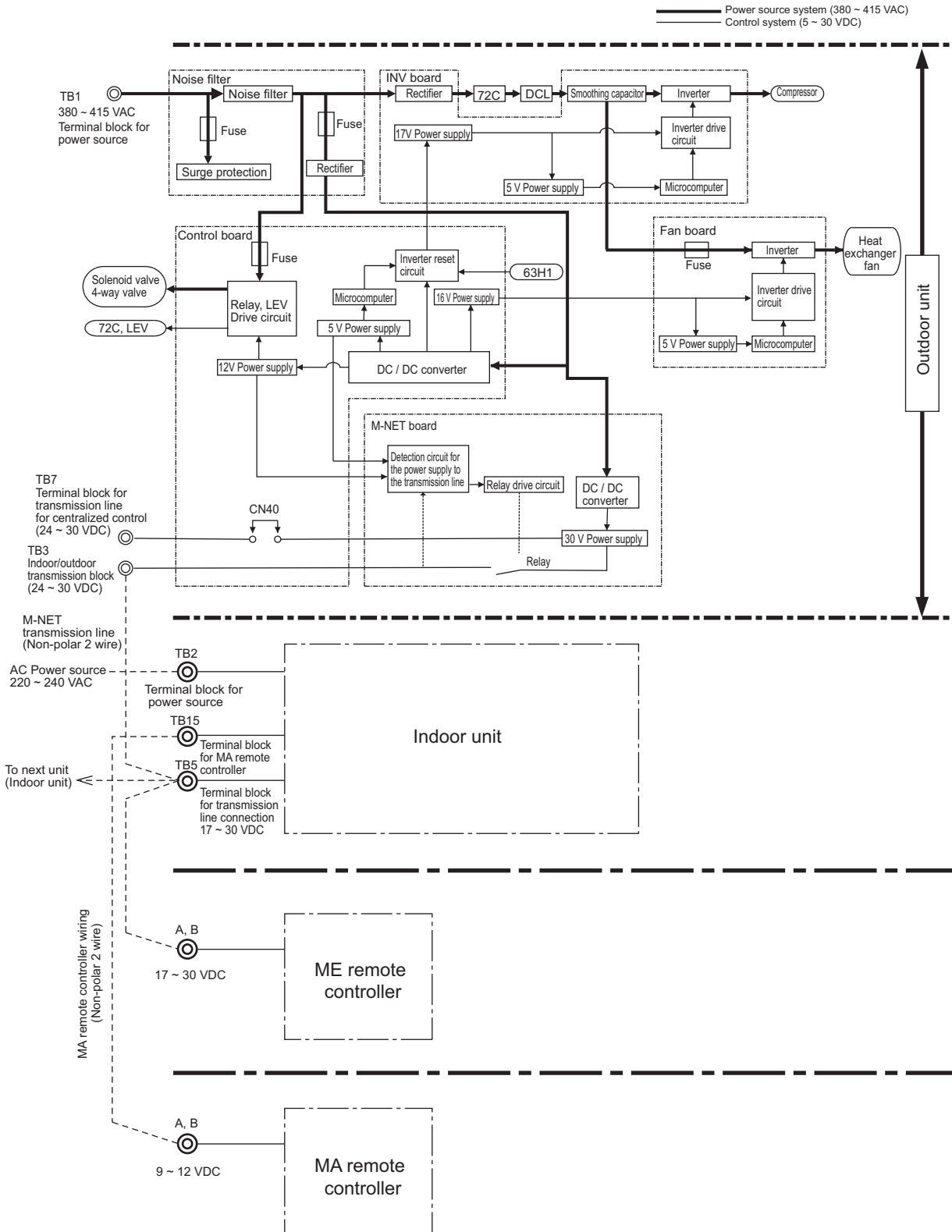

\* MA remote controllers and ME remote controllers cannot be used together.  
 (Both the ME and MA remote controller can be connected to a system with a system controller.)

2) PUHY-P450 - P500YKB-A1

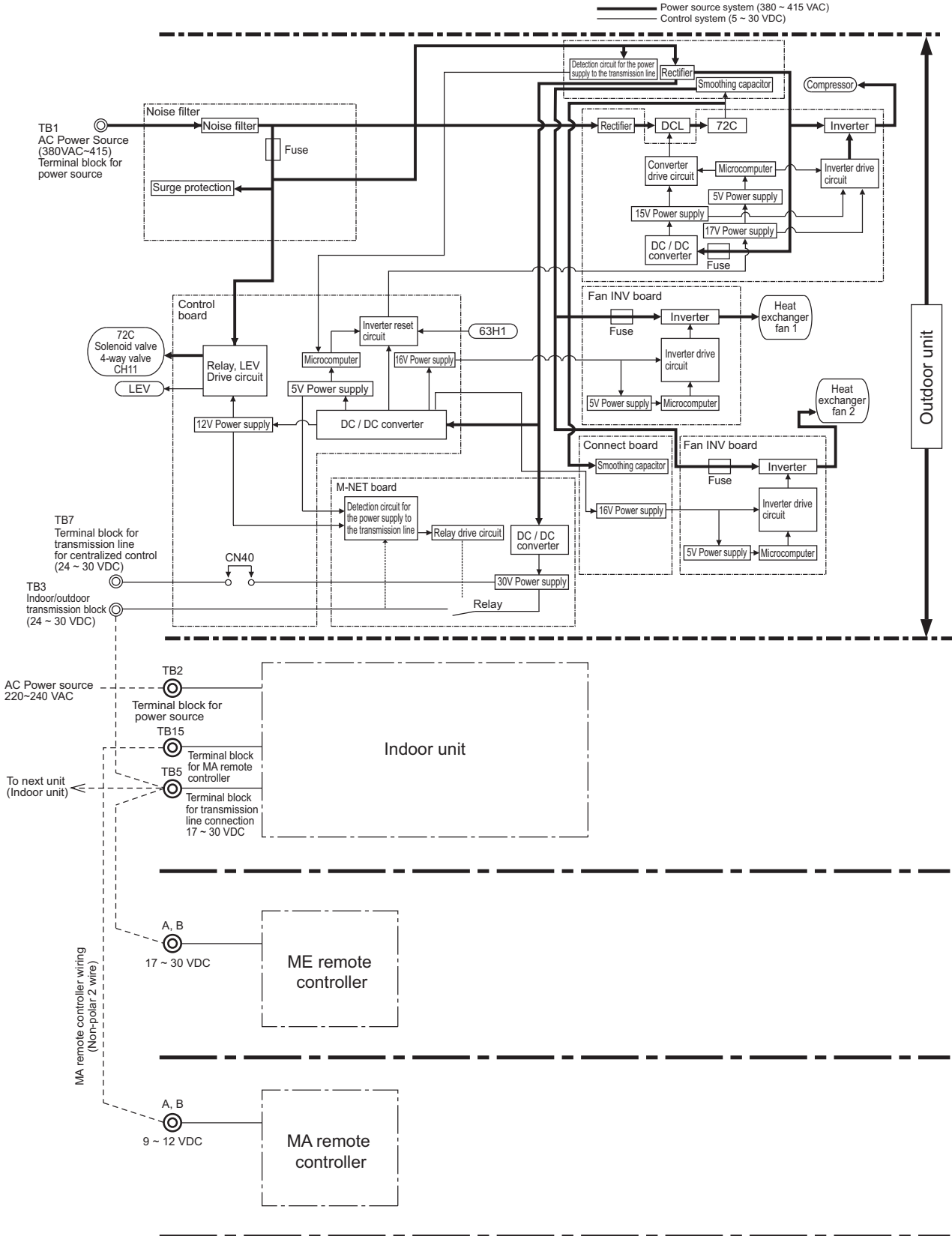

\* MA remote controllers and ME remote controllers cannot be used together.  
 (Both the ME and MA remote controller can be connected to a system with a system controller.)

## 8-10-2 Troubleshooting Problems with Outdoor Unit Transmission Power Supply Circuit

### 1) PUHY-P200 - P400YKB-A1

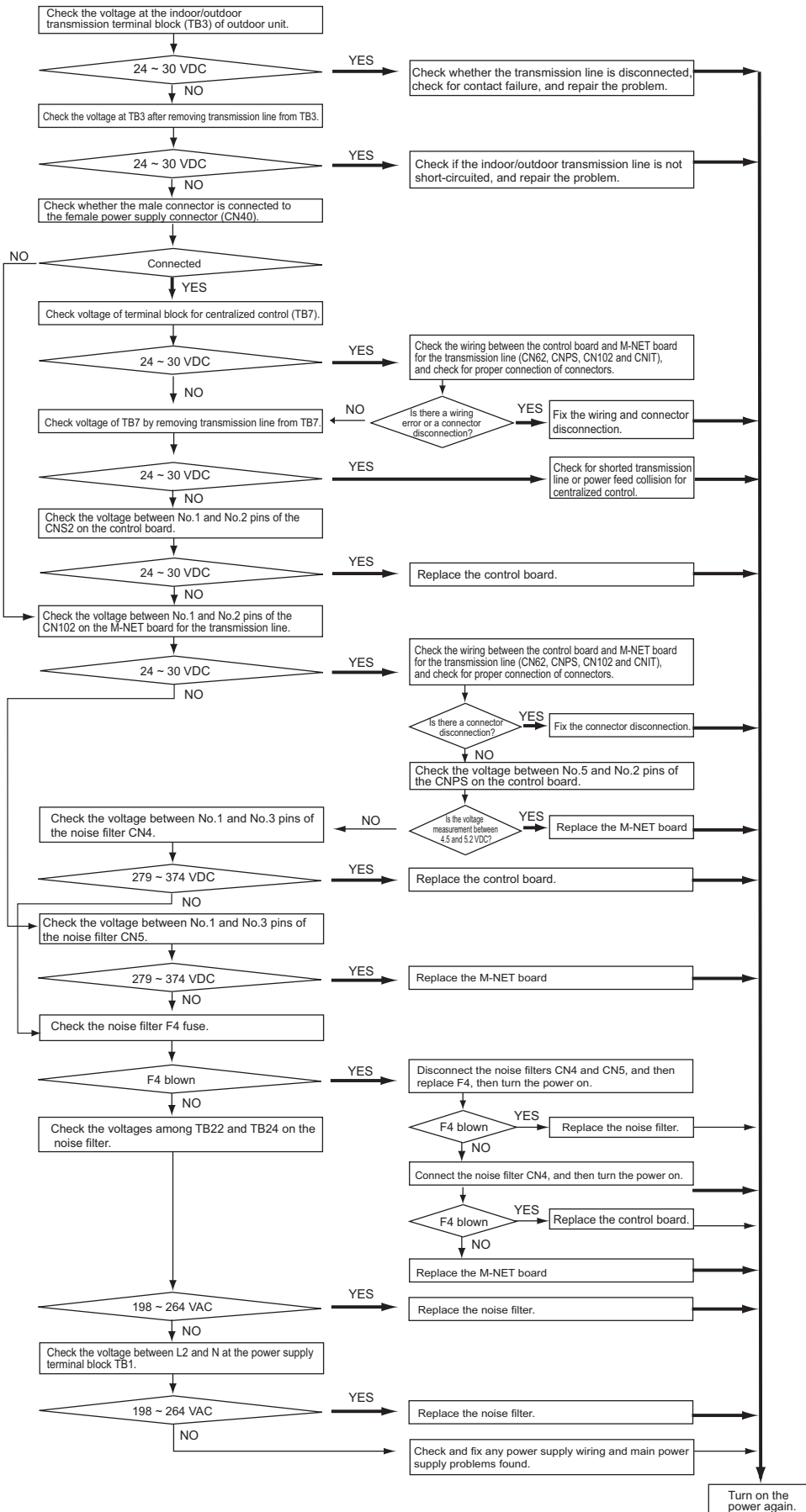

2) PUHY-P450 - P500YKB-A1

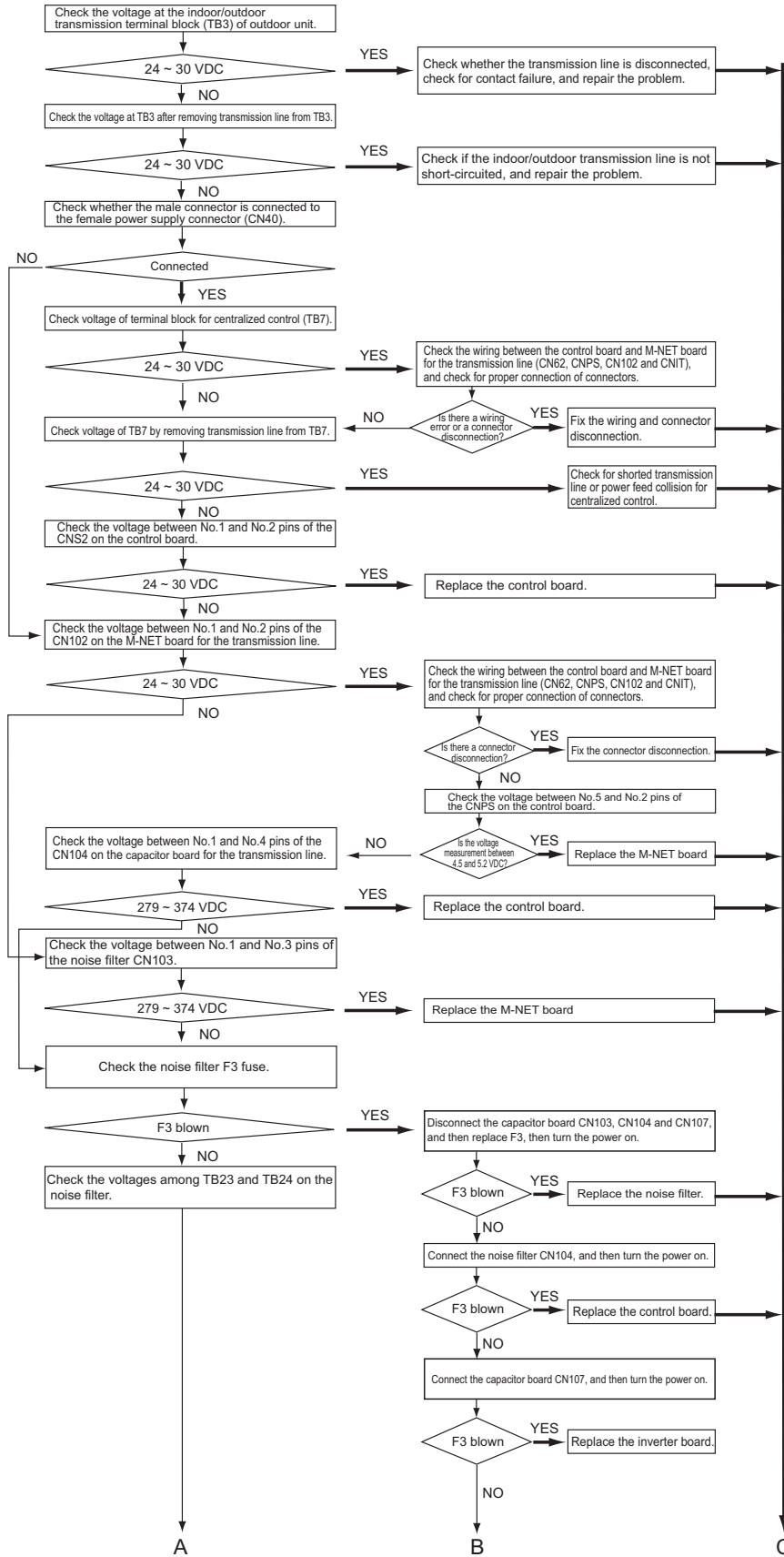



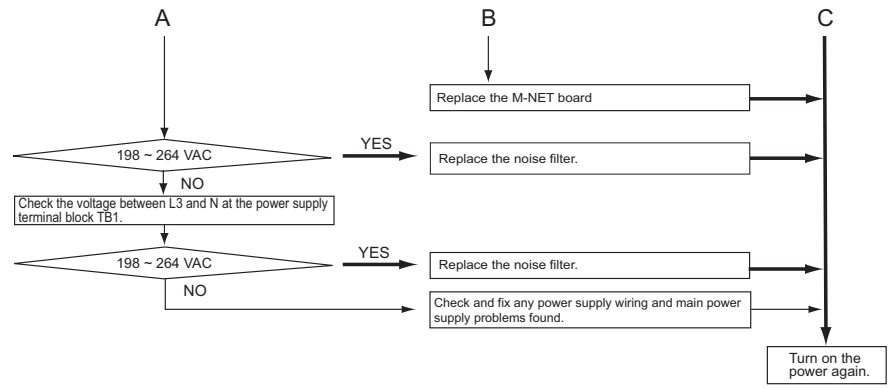

## 8-11 Measures for Refrigerant Leakage

### 1. Leak spot: In the case of extension pipe for indoor unit or optional unit (Cooling season)

- 1) Mount a pressure gauge on the service check joint (CJ2) on the low-pressure side.
- 2) Stop all the indoor units, and close the liquid service valve (BV2) inside the outdoor unit while the compressor is stopped.
- 3) Stop all the indoor units; turn on SW4 (912) on the outdoor unit control board while the compressor is being stopped.(Pump down mode will start, and all the indoor units will run in cooling test run mode.)
- 4) In the pump down mode (SW4 (912) is ON), all the indoor units will automatically stop when the low pressure (63LS) reaches 0.383MPa [55psi] or less or 15 minutes have passed after the pump mode started. Stop all the indoor units and compressors when the pressure indicated by the pressure gauge, which is on the check joint (CJ2) for low-pressure service, reaches 0.383MPa [55psi] or 20 minutes pass after the pump down operation is started.
- 5) Close the gas service valve (BV1) inside the outdoor unit.
- 6) Collect the refrigerant that remains in the extended pipe for the indoor unit or optional unit. Do not discharge refrigerant into the atmosphere when it is collected.
- 7) Repair the leak.
- 8) After repairing the leak, vacuum the extension pipe and the indoor unit or optional unit.
- 9) To adjust refrigerant amount, open the service valves (BV1 and BV2) inside the outdoor unit and turn off SW4 (912).

### 2. Leak spot: In the case of outdoor unit (Cooling season)

#### (1) Run all the indoor units in the cooling test run mode.

- 1) To run the indoor unit in test run mode, turn SW4 (769) from ON to OFF when SW3-1 on the outdoor control board is ON.
- 2) Change the setting of the remote controller for all the indoor units to the cooling mode.
- 3) Check that all the indoor units are performing a cooling operation.

#### (2) Check the values of Tc and TH6.

**(To display the values on the LED screen, use the self-diagnosis switch (SW4 (when SW6-10 is set to OFF)) on the outdoor unit control board.)**

- 1) When Tc-TH6 is 10°C [18°F] or more : See the next item (3).
- 2) When Tc-TH6 is less than 10°C [18°F] : After the compressor stops, collect the refrigerant inside the system, repair the leak, perform evacuation, and recharge new refrigerant. (Leak spot: 4. In the case of outdoor unit, handle in the same way as heating season.)

Tc self-diagnosis switch



TH6 self-diagnosis switch

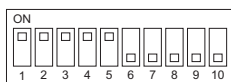

The figure at left shows that the switches 1 through 5 are set to ON and 6 through 10 are set to OFF.

#### (3) Stop all the indoor units, and stop the compressor.

- 1) To stop all the indoor units and the compressors, turn SW4 (769) from ON to OFF when SW3-1 on the outdoor control board is ON.
- 2) Check that all the indoor units are being stopped.

#### (4) Close the service valves (BV1 and BV2).

#### (5) To prevent the liquid seal, extract small amount of refrigerant from the check joint of the liquid service valve (BV2), as the liquid seal may cause a malfunction of the unit.

**In the cooling cycle, the section between check valve CV1 and LEV2 will form a closed circuit. Before recovering the refrigerant or evacuating the system, leave the unit in a stopped state for at least 30 minutes and then open LEV2 and switch SW4 (988) from OFF to ON so that LEV1 and SV5b are in an open state. If this work is not performed, recovering the refrigerant or evacuating the system may not be possible. (After completion of work, set SW4 (988) from ON to OFF.)**

- (6) Collect the refrigerant that remains inside the outdoor unit. Do not discharge refrigerant into air into the atmosphere when it is collected.
- (7) Repair the leak.
- (8) After repairing the leak, replace the dryer with the new one, and perform evacuation inside the outdoor unit and optional unit.
- (9) To adjust refrigerant amount, open the service valves (BV1 and BV2, or BV3 and BV4 when optional unit is installed) inside the outdoor unit.

**Note**

When the power to the outdoor/indoor unit must be turned off to repair the leak after closing the service valves specified in the item 4, turn the power off in approximately one hour after the outdoor/indoor units stop.

- 1) When 30 minutes have passed after the item 4 above, the indoor unit lev turns from fully closed to slightly open to prevent the refrigerant seal.  
LEV2 open when the outdoor unit remains stopped for 15 minutes to allow for the collection of refrigerant in the outdoor unit heat exchanger and to enable the evacuation of the outdoor unit heat exchanger.  
If the power is turned off in less than 5 minutes, LEV2 may close, trapping high-pressure refrigerant in the outdoor unit heat exchanger and creating a highly dangerous situation.
- 2) Therefore, if the power source is turned off within 30 minutes, the lev remains fully closed and the refrigerant remains sealed. When only the power for the indoor unit is turned off, the indoor unit LEV turns from faintly open to fully closed.

**3. Leak spot: In the case of extension pipe for indoor unit or optional unit (Heating season)**

**(1) Run all the indoor units in heating test run mode.**

- 1) To run the indoor unit in test run mode, turn SW4 (769) from ON to OFF when SW3-1 on the outdoor control board is ON.
- 2) Change the setting of the remote controller for all the indoor units to the heating mode.
- 3) Check that all the indoor units are performing a heating operation.

**(2) Stop all the indoor units, and stop the compressor.**

- 1) To stop all the indoor units and the compressors, turn SW4 (769) from ON to OFF when SW3-1 on the outdoor control board is ON.
- 2) Check that all the indoor units are stopped.

**(3) Close the service valves (BV1 and BV2).**

**(4) Collect the refrigerant that remains inside the indoor unit and optional unit. Do not discharge refrigerant into the atmosphere when it is collected.**

**(5) Repair the leak.**

**(6) After repairing the leak, perform evacuation of the extension pipe for the indoor unit and optional unit, and open the service valves (BV1 and BV2) to adjust refrigerant.**

**4. Leak spot: In the case of outdoor unit (Heating season)**

- 1) Collect the refrigerant in the entire system (outdoor unit, extended pipe and indoor unit). Do not discharge refrigerant into the atmosphere when it is collected. **In the cooling cycle, the section between check valve CV1 and LEV2 will form a closed circuit. Before recovering the refrigerant or evacuating the system, leave the unit in a stopped state for at least 15 minutes and then open LEV2 and switch SW4 (988) from OFF to ON so that LEV1 and SV5b are in an open state. If this work is not performed, recovering the refrigerant or evacuating the system may not be possible. (After completion of work, set SW4 (988) from ON to OFF.)**
- 2) Repair the leak.
- 3) After repairing the leak, perform evacuation of the entire system, and calculate the standard amount of refrigerant to be added (for the outdoor unit, extension pipe, and indoor unit), and charge the refrigerant. For details, refer to the following page(s). [6-9-3 The Amount of Refrigerant to Be Added](page 132)

**Note**

If the indoor or outdoor units need to be turned off for repairing leaks during Step 1) above, turn off the power approximately 1 hour after the units came to a stop.

If the power is turned off in less than 15 minutes, LEV2 may close, trapping high-pressure refrigerant in the outdoor unit heat exchanger and creating a highly dangerous situation.

## 8-12 Compressor Replacement Instructions

Follow the procedures below (Steps 1 through 6) to remove the compressor components and replace the compressor. Reassemble them in the reverse order after replacing the compressor.

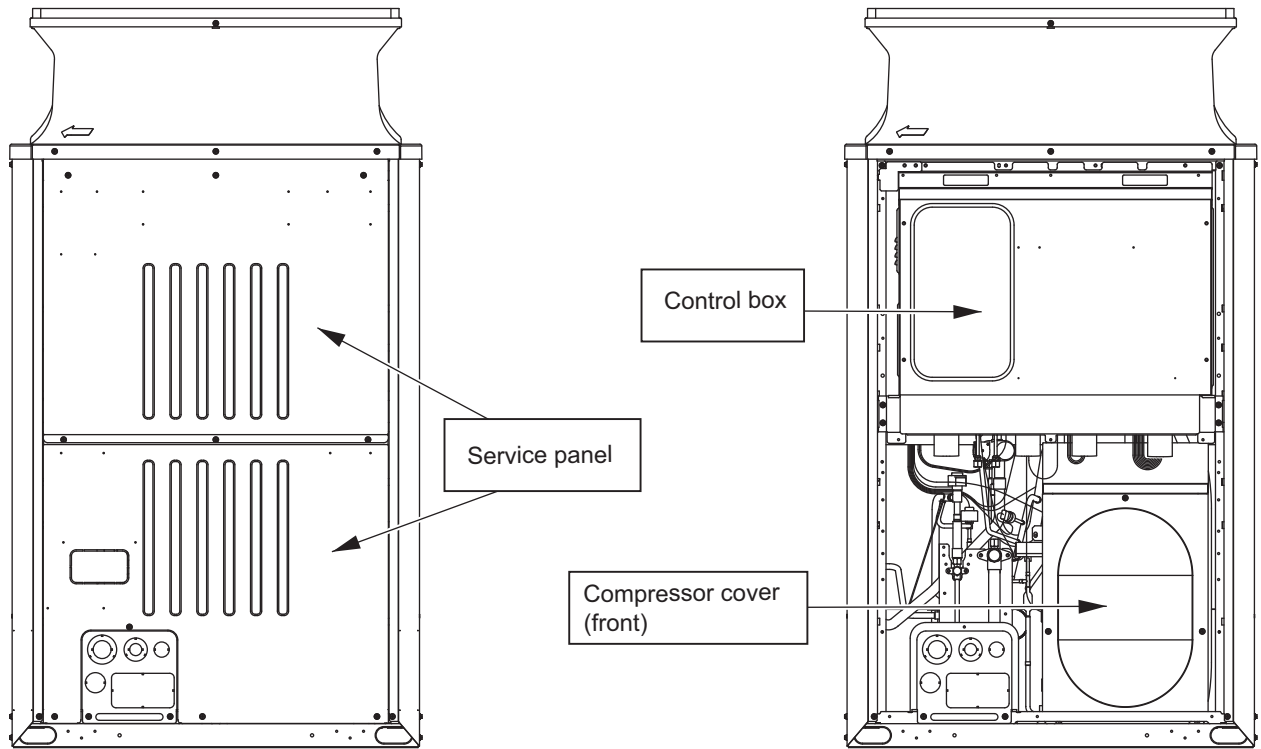

1. Remove both the top and bottom service panels (front panels).

2. Remove the control box and the compressor cover (front).

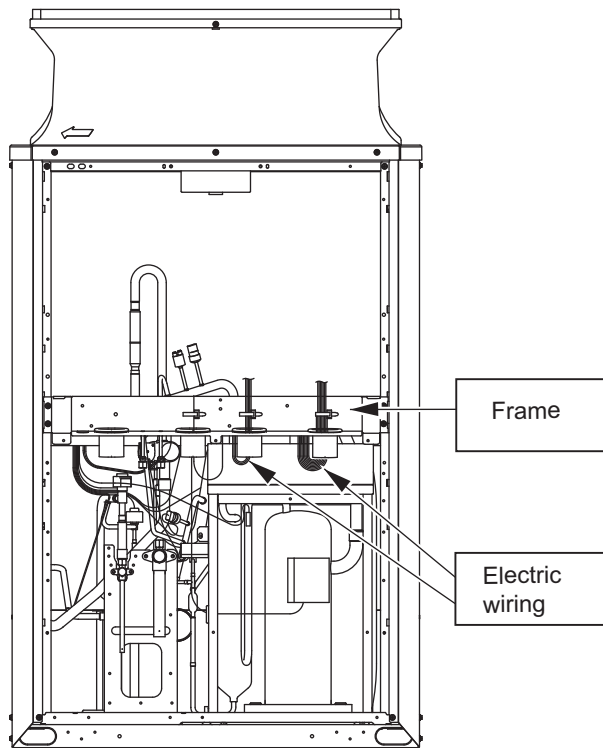

3. Remove the wires that are secured to the frame, and remove the frame.

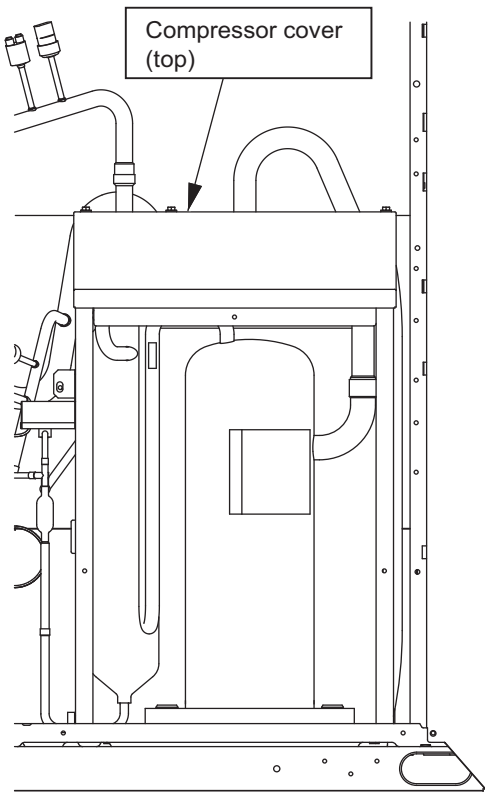

4. Remove the compressor cover (top).

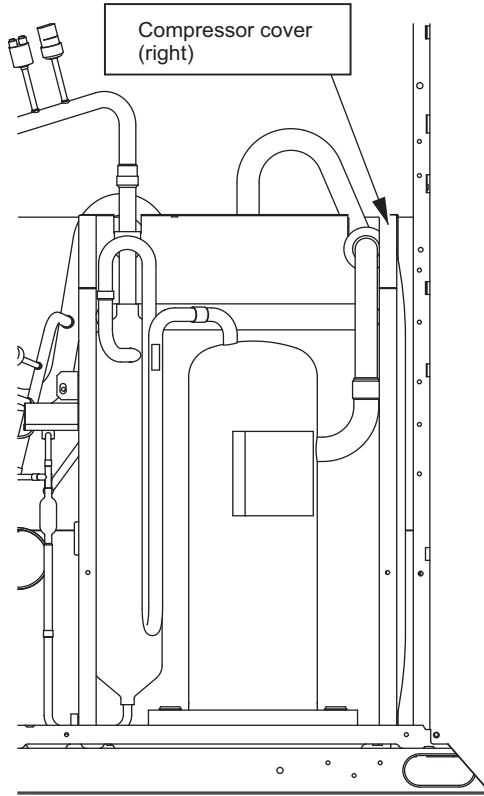

5. Remove the compressor wires, compressor cover, and the right.

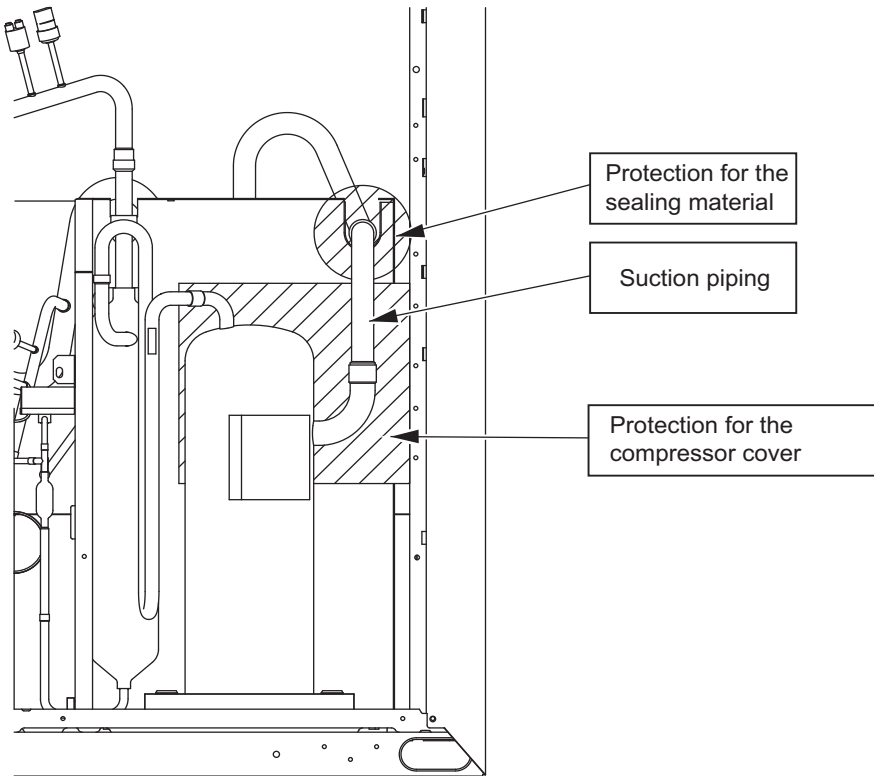

6. Place protective materials on the insulation lining of the compressor cover and on the sealing material on the compressor suction pipe to protect them from the torch flame, debraze the pipe, and replace the compressor.

## 8-13 Troubleshooting Problems Using the LED Status Indicators on the Outdoor Unit

If the LED error display appear as follows while all the SW4 switches and SW6-10 are set to OFF, check the items under the applicable item numbers below.

**1. Error code appears on the LED display.**

Refer to the following page(s). [7-1 Error Code and Preliminary Error Code Lists](page 165)

**2. LED is blank.**

Take the following troubleshooting steps.

**(1) Refer to the section on troubleshooting the transmission power supply circuit, if the voltage across pins 1 through 3 of CNDC on the control panel is outside the range between 220 VDC and 380 VDC. [8-10-2 Troubleshooting Problems with Outdoor Unit Transmission Power Supply Circuit](page 278)**

**(2) If the LED error display becomes lit when the power is turned on with all the connectors on the control board except CNDC disconnected, there is a problem with the wiring to those connectors or with the connectors themselves.**

**(3) If nothing appears on the display under item (2) above AND the voltage between pins 1 and 3 of CNDC is within the range between 220 VDC and 380 VDC, control board failure is suspected.**

**3. Only the software version appears on the LED display.**

**(1) Only the software version appears while the transmission cables to TB3 and TB7 are disconnected.**

1) Wiring failure between the control board and the transmission line power supply board.(CN62, CNPS, CNIT, CNS2, CN102)

2) If item 1) checks out OK, the transmission line power supply board failure is suspected.

3) If items 1) and 2) check out OK, control board failure is suspected.

**(2) If the LED shows the same display as the initial display upon disconnection of transmission lines (TB3, TB7), there is a problem with the transmission lines or with the connected devices. [9-1-2 Initial LED Display](page 290)**



---

## Chapter 9 LED Status Indicators on the Outdoor Unit Circuit Board

<b>9-1</b>	<b>LED Status Indicators</b> .....	<b>289</b>
9-1-1	How to Read the LED .....	289
9-1-2	Initial LED Display .....	290
9-1-3	Clock Memory Function .....	291
<b>9-2</b>	<b>LED Status Indicators Table</b> .....	<b>292</b>





# 9-1 LED Status Indicators

## 9-1-1 How to Read the LED

By setting the DIP SW 4-1 through 4-10 (Set SW6-10 to OFF.)(Switch number 10 is represented by 0), the operating condition of the unit can be monitored on the service monitor. (Refer to the table on the following pages for DIP SW settings.) The service monitor uses 4-digit 7-segment LED to display numerical values and other types of information.

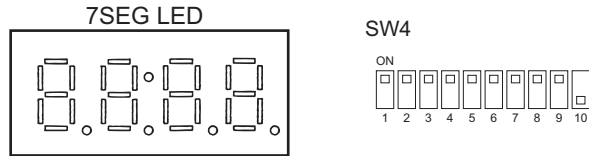

◆In the example above, 1 through 9 are set to ON, and 10 is set to OFF.

Pressure and temperature are examples of numerical values, and operating conditions and the on-off status of solenoid valve are examples of flag display.

1) Display of numerical values

Example: When the pressure data sensor reads 18.8kg/cm<sup>2</sup> (Item No. 58)

- ◆The unit of pressure is in kg/cm<sup>2</sup>
- ◆ Use the following conversion formula to convert the displayed value into a value in SI unit.  
Value in SI unit (MPa) = Displayed value (kg/cm<sup>2</sup>) x 0.098

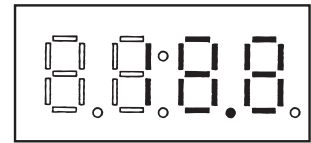

2) Flag display

Example: When 21S4a, 21S4b, SV1a are ON. (Item No. 3)

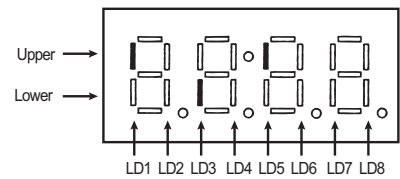

Example: 3-minutes restart mode (Item No. 14)

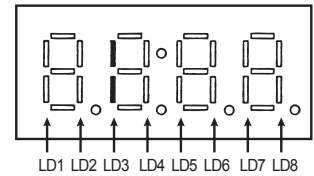

## 9-1-2 Initial LED Display

From power on until the completion of initial settings, the following information will be displayed on the monitor screen. (Displays No. 1 through No. 4 in order repeatedly.)

No	Item	Display	Remarks
1	Software version		[0103] : Version 1.03
2	Refrigerant type		[ 410] : R410A
3	Model and capacity		[H-20] : Cooling/Heating 20 HP For the first few minutes after power on, the capacity of each outdoor unit is displayed. Thereafter, the combined capacity is displayed.
4	Communication address		[ 51] : Address 51

After the initial settings have been completed, the information on these items can be checked by making the switch setting that corresponds to No. 517 in the LED display table.

**Note**

Only item No. 1 "Software Version" appears on the display if there is a wiring failure between the control board and the transmission line power supply board or if the circuit board has failed.

♦How to convert HP capacity to Model name

HP capacity is the capacity of outdoor unit that is shown on LED display at initial setting. Please refer to the following table to convert from HP capacity to Model name.

HP	Model	HP	Model
8	P200	32	P800
10	P250	34	P850
12	P300	36	P900
14	P350	38	P950
16	P400	40	P1000
18	P450	42	P1050
20	P500	44	P1100
22	P550	46	P1150
24	P600	48	P1200
26	P650	50	P1250
28	P700	52	P1300
30	P750	54	P1350

### 9-1-3 Clock Memory Function

The outdoor unit has a simple clock function that enables the unit to calculate the current time with an internal timer by receiving the time set by the system controller, such as AG-150A.

If an error (including a preliminary error) occurs, the error history data and the error detection time are stored into the service memory.

The error detection time stored in the service memory and the current time can be seen on the service LED.

**Note**

- 1) Use the time displayed on the service LED as a reference.
- 2) The date and the time are set to "00" by default. If a system controller that sets the time, such as AG-150A is not connected, the elapsed time and days since the first power on will be displayed. If the time set on a system controller is received, the count will start from the set date and the time.
- 3) The time is not updated while the power of the indoor unit is turned off. When the power is turned off and then on again, the count will resume from the time before the power was turned off. Thus, the time that differs the actual time will be displayed. (This also applies when a power failure occurs.)

The system controller, such as AG-150A, adjusts the time once a day. When the system controller is connected, the time will be automatically updated to the correct current time after the time set by the system controller is received. (The data stored into the memory before the set time is received will not be updated.)

**(1) Reading the time data:**

- 1) Time display

Example: 12 past 9

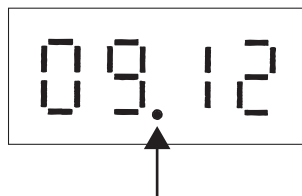

\* Disappears if the time data is deviated due to a power failure, or if a system controller that sets the time is not connected.

- 2) Date display

•When the main controller that can set the time is connected

Example: May 10, 2003

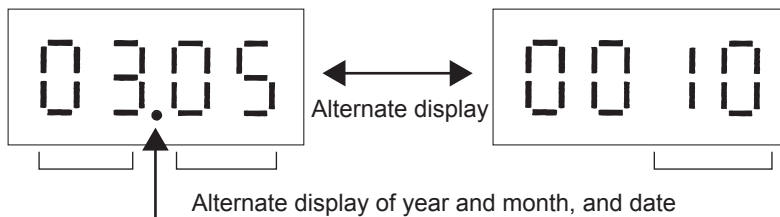

\* Appears between the year and the month, and nothing appears when the date is displayed.

•When the main controller that can set the time is not connected

Example: 52 days after power was turned on

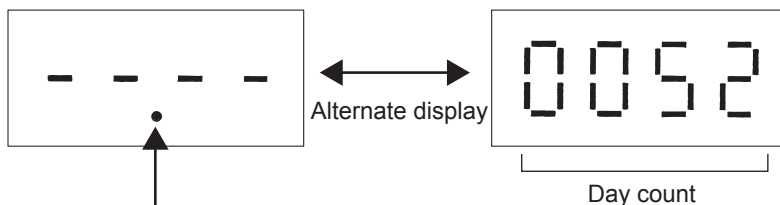

\* Appears between the year and the month, and nothing appears when the date is displayed.

## 9-2 LED Status Indicators Table

**Current data**

No.	SW4 (When SW6-10 is set to OFF) 1234567890	Item	Display										Unit (A, B) *1		Remarks	
			LD1	LD2	LD3	LD4	LD5	LD6	LD7	LD8	OC	OS				
0	0000000000	Relay output display 1 Lighting					72C				OC			A	A	
		Check (error) display 1 OC/OS error	0000 to 9999 (Address and error codes highlighted)										B	B		
1	1000000000	Check (error) display 2 OC/OS error	0000 to 9999 (Address and error codes highlighted)										A	A	Display of the latest preliminary error If no preliminary errors are detected, "----" appears on the display.	
2	0100000000	Check (error) display 3 (Including IC and BC)	0000 to 9999 (Address and error codes highlighted)										B		If no errors are detected, "----" appears on the display.	
3	1100000000	Relay output display 2 Top		SV10	CH11		SV1a					SV11		A	A	
		Bottom			21S4b	SV5b										
4	0010000000	Relay output display 3 Top					21S4c				SV9	Power supply for indoor transmission line		A	A	
		Bottom														
7	1110000000	Special control												B	B	
9	1001000000	Communication demand capacity	0000 to 9999										B	B	If not demanded controlled, "----" [%] appears on the display.	
10	0101000000	Contact point demand capacity	0000 to 9999										B		If not demanded controlled, "----" [%] appears on the display.	

\*1 A: The condition of either OC or OS is displayed individually. B: The condition of the entire refrigerant system is displayed.

Current data	No.	SW4 (When SW6-10 is set to OFF) 1234567890	Item	Display										Unit**1		Remarks	
				LD1	LD2	LD3	LD4	LD5	LD6	LD7	LD8	OC	OS				
11	1101000000		External signal (Open input contact point)	Contact point demand	Low-noise mode (Capacity priority)	Snow sensor	Cooling-heating changeover (Cooling)	Cooling-heating changeover (Heating)							A	A	
12	0011000000		External signal (Open input contact point)											Low-noise mode (Quiet priority)	A	A	
13	1011000000																
14	0111000000		Outdoor unit operation status		Warm-up mode	3-minutes restart mode	Compressor in operation	Preliminary error	Error	3-minutes restart after instantaneous power failure				Preliminary low pressure error	A	A	
15	1111000000		OC/OS identification	OC/OS-1/OS-2										A	A		
16	0000100000		Indoor unit check	Top	Unit No. 1	Unit No. 2	Unit No. 3	Unit No. 4	Unit No. 5	Unit No. 6	Unit No. 7	Unit No. 8					The lamp that corresponds to the unit that came to an abnormal stop lights. The lamp goes off when the error is reset. Each unit that comes to an abnormal unit will be given a sequential number in ascending order starting with 1.
17	1000100000			Bottom	Unit No. 9	Unit No. 10	Unit No. 11	Unit No. 12	Unit No. 13	Unit No. 14	Unit No. 15	Unit No. 16					
18	0100100000		Indoor unit Operation mode	Top	Unit No. 17	Unit No. 18	Unit No. 19	Unit No. 20	Unit No. 21	Unit No. 22	Unit No. 23	Unit No. 24					Lit during cooling Blinking during heating Unit while the unit is stopped or in the fan mode
19	1100100000			Bottom	Unit No. 25	Unit No. 26	Unit No. 27	Unit No. 28	Unit No. 29	Unit No. 30	Unit No. 31	Unit No. 32					
20	0010100000		Indoor unit Operation mode	Top	Unit No. 33	Unit No. 34	Unit No. 35	Unit No. 36	Unit No. 37	Unit No. 38	Unit No. 39	Unit No. 40					Lit during cooling Blinking during heating Unit while the unit is stopped or in the fan mode
21	1010100000			Bottom	Unit No. 41	Unit No. 42	Unit No. 43	Unit No. 44	Unit No. 45	Unit No. 46	Unit No. 47	Unit No. 48					
22	0110100000		Indoor unit Operation mode	Top	Unit No. 49	Unit No. 50											Lit during cooling Blinking during heating Unit while the unit is stopped or in the fan mode
23	1110100000			Bottom	Unit No. 1	Unit No. 2	Unit No. 3	Unit No. 4	Unit No. 5	Unit No. 6	Unit No. 7	Unit No. 8					

\*1 A: The condition of either OC or OS is displayed individually. B: The condition of the entire refrigerant system is displayed.

**Current data**

No.	SW4 (When SW6-10 is set to OFF) 1234567890	Item	Display										Unit <sup>*1</sup> (A, B) <sup>*1</sup>		Remarks
			LD1	LD2	LD3	LD4	LD5	LD6	LD7	LD8	OC	OS			
24	0001100000	Indoor unit thermostat	Unit No. 1	Unit No. 2	Unit No. 3	Unit No. 4	Unit No. 5	Unit No. 6	Unit No. 7	Unit No. 8	B		Lit when thermostat is on Unit when thermostat is off		
		Top	Unit No. 9	Unit No. 10	Unit No. 11	Unit No. 12	Unit No. 13	Unit No. 14	Unit No. 15	Unit No. 16					
25	1001100000	Indoor unit thermostat	Unit No. 17	Unit No. 18	Unit No. 19	Unit No. 20	Unit No. 21	Unit No. 22	Unit No. 23	Unit No. 24					
		Top	Unit No. 25	Unit No. 26	Unit No. 27	Unit No. 28	Unit No. 29	Unit No. 30	Unit No. 31	Unit No. 32					
26	0101100000	Indoor unit thermostat	Unit No. 33	Unit No. 34	Unit No. 35	Unit No. 36	Unit No. 37	Unit No. 38	Unit No. 39	Unit No. 40					
		Bottom	Unit No. 41	Unit No. 42	Unit No. 43	Unit No. 44	Unit No. 45	Unit No. 46	Unit No. 47	Unit No. 48					
27	1101100000	Indoor unit thermostat	Unit No. 49	Unit No. 50											
		Bottom													
39	1110010000	Outdoor unit Operation mode	Permissible stop	Standby	Cooling		Heating				B				
42	0101010000	Outdoor unit control mode	Stop	Thermo OFF	Abnormal stop	Scheduled control	Initial start up	Defrost	Oil balance	Low frequency oil recovery	A	A			
43	1101010000		Warm-up mode	Refrigerant recovery			Continuous heating 2	Continuous heating 1			A	A			
45	1011010000	TH4					-99.9 to 999.9				A	A	The unit is [°C]		
46	0111010000	TH3					-99.9 to 999.9				A	A			
47	1111010000	TH7					-99.9 to 999.9				A	A			
48	0000110000	TH6					-99.9 to 999.9				A	A			
49	1000110000	TH2					-99.9 to 999.9				A	A			
50	0100110000	TH5					-99.9 to 999.9				A	A			
54	0110110000	TH9					-99.9 to 999.9				A	A			
56	0001110000	THHS1					-99.9 to 999.9				A	A	The unit is [°C]		
58	0101110000	High-pressure sensor data					-99.9 to 999.9				A	A	The unit is [kgf/cm <sup>2</sup> ]		
59	1101110000	Low-pressure sensor data					-99.9 to 999.9				A	A			
63	1111110000	TH11					-99.9 to 999.9				A	A	The unit is [°C]		
78	0111001000	Σ Qj					0000 to 9999				B	B			
79	1111001000	Σ Qjc					0000 to 9999				B	B			

\*1 A: The condition of either OC or OS is displayed individually. B: The condition of the entire refrigerant system is displayed.

No.	SW4 (When SW6-10 is set to OFF) 1234567890	Item	Display								Unit *1		Remarks
			LD1	LD2	LD3	LD4	LD5	LD6	LD7	LD8	OC	OS	
80	0000101000	Σ Qjh	0000 to 9999								B	B	
81	1000101000	Target Tc	-99.9 to 999.9								B		The unit is [°C]
82	0100101000	Target Te	-99.9 to 999.9								B		
83	1100101000	Tc	-99.9 to 999.9								A	A	
84	0010101000	Te	-99.9 to 999.9								A	A	
86	01110101000	Total frequencies (OC+OS)	0000 to 9999								B		Control data [ Hz ]
87	1110101000	Total frequency of each unit	0000 to 9999								A	A	
88	0001101000	COMP frequency	0000 to 9999								A	A	
91	1101101000	COMP operating frequency	0000 to 9999								A	A	The unit is [rps] Output frequency of the inverter depends on the type of compressor and equals the integer multiples (x1, x2 etc.) of the operating frequency of the compressor
92	0011101000	Number of times error occurred during crankcase heating by compressor motor	0000 to 9999								A	A	Number of times INV error occurred during IH crankcase heating by compressor motor
93	1011101000	All AK (OC+OS)	0000 to 9999								B		
94	0111101000	AK	0000 to 9999								A	A	
95	1111101000	FAN1	0000 to 9999								A	A	Fan output [ % ]
96	0000011000	Fan inverter output rpm (FAN1)	0000 to 9999								A	A	[rpm]
97	1000011000	FAN2	0000 to 9999								A	A	Fan output [ % ]
98	0100011000	Fan inverter output rpm (FAN2)	0000 to 9999								A	A	[rpm]
103	1110011000	LEV1	0000 to 9999								A	A	Outdoor LEV opening (Fully open: 480)
104	0001011000	LEV2a	0000 to 9999								A	A	Outdoor LEV opening (Fully open: 3000)

\*1 A: The condition of either OC or OS is displayed individually. B: The condition of the entire refrigerant system is displayed.



**Current data**

No.	SW4 (When SW6-10 is set to OFF) 1234567890	Item	Display								Unit *1		Remarks
			LD1	LD2	LD3	LD4	LD5	LD6	LD7	LD8	OC	OS	
109	1011011000	LEV2b	0000 to 9999								A	A	Outdoor LEV opening (Fully open: 3000)
108	0011011000	COMP operating current (DC)	00.0 to 999.9								A	A	Peak value [A]
111	1111011000	COMP bus voltage	00.0 to 999.9								A	A	The unit is [ V ]
116	0010111000	Number of times the unit went into the mode to remedy wet vapor suction	0000 to 9999								B		
117	1010111000	COMP Operation time Upper 4 digits	0000 to 9999								A	A	The unit is [ h ]
118	0110111000	COMP Operation time Lower 4 digits	0000 to 9999								A	A	
121	1001111000	Backup mode	Abnormal pressure rise	High-pressure drop	Low-pressure drop	Abnormal Td rise					A	A	Stays lit for 90 seconds after the completion of backup control
123	1101111000	COMP number of start-stop events Upper 4 digits	0000 to 9999								A	A	Count-up at start-up The unit is [Time]
124	0011111000	COMP number of start-stop events Lower 4 digits	0000 to 9999								A	A	
129	1000000100	Integrated operation time of compressor (for rotation purpose)	0000 to 9999								B		The unit is [ h ]

\*1 A: The condition of either OC or OS is displayed individually. B: The condition of the entire refrigerant system is displayed.

**Current data**

No.	SW4 (When SW6-10 is set to OFF) 1234567890	Item	Display										Unit*1			Remarks
			LD1	LD2	LD3	LD4	LD5	LD6	LD7	LD8	OC	OS	OS			
178	0100110100	Error history 1	0000 to 9999										B	B	Address and error codes highlighted If no errors are detected, "----" appears on the display. Preliminary error information of the OS does not appear on the OC. Neither preliminary error information of the OC nor error information of the IC appears on the OS.	
179	1100110100	Error details of inverter	Error details of inverter (0001-0120)										A	A		
180	0010110100	Error history 2	0000 to 9999										B	B		
181	1010110100	Error details of inverter	Error details of inverter (0001-0120)										A	A		
182	0110110100	Error history 3	0000 to 9999										B	B		
183	1110110100	Error details of inverter	Error details of inverter (0001-0120)										A	A		
184	0001110100	Error history 4	0000 to 9999										B	B		
185	1001110100	Error details of inverter	Error details of inverter (0001-0120)										A	A		
186	0101110100	Error history 5	0000 to 9999										B	B		
187	1101110100	Error details of inverter	Error details of inverter (0001-0120)										A	A		
188	0011110100	Error history 6	0000 to 9999										B	B		
189	1011110100	Error details of inverter	Error details of inverter (0001-0120)										A	A		
190	0111110100	Error history 7	0000 to 9999										B	B		
191	1111110100	Error details of inverter	Error details of inverter (0001-0120)										A	A		
192	0000001100	Error history 8	0000 to 9999										B	B		
193	1000001100	Error details of inverter	Error details of inverter (0001-0120)										A	A		
194	0100001100	Error history 9	0000 to 9999										B	B		
195	1100001100	Error details of inverter	Error details of inverter (0001-0120)										A	A		
196	0010001100	Error history 10	0000 to 9999										B	B		
197	1010001100	Error details of inverter	Error details of inverter (0001-0120)										A	A		
198	0110001100	Error history of inverter (At the time of last data backup before error)	0000 to 9999										B	B		
199	1110001100	Error details of inverter	Error details of inverter (0001-0120)										A	A		

\*1 A: The condition of either OC or OS is displayed individually. B: The condition of the entire refrigerant system is displayed.

**Error history**

No.	SW4 (When SW6-10 is set to OFF) 1234567890	Item	Display								Unit (A, B) *1		Remarks
			LD1	LD2	LD3	LD4	LD5	LD6	LD7	LD8	OC	OS	
201	1001001100	Outdoor unit operation status		Warm-up mode	3-minutes restart mode	Compressor in operation	Preliminary error	Error	3-minutes restart after instantaneous power failure	Preliminary low pressure error	A	A	
202	0101001100	OC/OS identification	OC/OS-1/OS-2								A	A	
205	1011001100	Outdoor unit Operation mode	Permissible stop	Standby	Cooling			Heating			A	A	
208	0000101100	Outdoor unit control mode	Stop	Thermo OFF	Abnormal stop	Scheduled control	Initial start up	Defrost	Oil balance	Low frequency oil recovery	A	A	
209	1000101100		Warm-up mode	Refrigerant recovery			Continuous heating 2	Continuous heating 1			A	A	
211	1100101100	Relay output display 1 Lighting	Comp in operation				72C		OC	Always lit	A	A	
212	0010101100	Relay output display 2 Lighting	21S4a	SV10	CH11		SV1a			SV11	A	A	
		Relay output display 3 Lighting			21S4b	SV5b		21S4c	SV9	Lit while power to the indoor units is being supplied	A	A	
213	1010101100												
216	0001101100	TH4	-99.9 to 999.9								A	A	The unit is [°C]
217	1001101100	TH3	-99.9 to 999.9								A	A	
218	0101101100	TH7	-99.9 to 999.9								A	A	
219	1101101100	TH6	-99.9 to 999.9								A	A	
220	0011101100	TH2	-99.9 to 999.9								A	A	
221	1011101100	TH5	-99.9 to 999.9								A	A	
225	1000011100	TH9	-99.9 to 999.9								A	A	
227	1100011100	THHS1	-99.9 to 999.9								A	A	The unit is [°C]

\*1 A: The condition of either OC or OS is displayed individually. B: The condition of the entire refrigerant system is displayed.

**Error history**

No.	SW4 (When SW6-10 is set to OFF) 1234567890	Item	Display								Unit <sup>*1</sup> (A, B) <sup>*1</sup>		Remarks
			LD1	LD2	LD3	LD4	LD5	LD6	LD7	LD8	OC	OS	
229	1010011100	High-pressure sensor data	-99.9 to 999.9								A	A	The unit is [kgf/cm <sup>2</sup> ]
230	0110011100	Low-pressure sensor data	-99.9 to 999.9								A	A	
234	0101011100	TH11	-99.9 to 999.9								A	A	The unit is [°C]
249	1001111100	Σ Qj	0000 to 9999								B	B	
250	0101111100	Σ Qjc	0000 to 9999								B	B	
251	1101111100	Σ Qjh	0000 to 9999								B	B	
252	0011111100	Target Tc	-99.9 to 999.9								B		The unit is [°C]
253	1011111100	Target Te	-99.9 to 999.9								B		
254	0111111100	Tc	-99.9 to 999.9								A	A	The unit is [°C]
255	1111111100	Te	-99.9 to 999.9								A	A	
257	1000000010	Total frequencies (OC+OS)	0000 to 9999								B		Control data [ Hz ]
258	0100000010	Total frequency of each unit	0000 to 9999								A	A	
259	1100000010	COMP frequency	0000 to 9999								A	A	
262	0110000010	COMP operating frequency	0000 to 9999								A	A	The unit is [rps]
264	0001000010	All AK (OC+OS)	0000 to 9999								B		
265	1001000010	AK	0000 to 9999								A	A	
266	0101000010	FAN1	0000 to 9999								A	A	Fan inverter output [ % ]
267	1101000010	Fan inverter output rpm (FAN1)	0000 to 9999								A	A	[rpm]
268	0011000010	FAN2	0000 to 9999								A	A	Fan inverter output [ % ]
269	1011000010	Fan inverter output rpm (FAN2)	0000 to 9999								A	A	[rpm]
274	0100100010	LEV1	0000 to 9999								A	A	Outdoor LEV opening (Fully open: 480)
275	1100100010	LEV2a	0000 to 9999								A	A	Outdoor LEV opening (Fully open: 3000)

\*1 A: The condition of either OC or OS is displayed individually. B: The condition of the entire refrigerant system is displayed.

**Error history**

No.	SW4 (When SW6-10 is set to OFF) 1234567890	Item	Display								Unit *1		Remarks
			LD1	LD2	LD3	LD4	LD5	LD6	LD7	LD8	OC	OS	
279	1110100010	COMP operating current (DC)	00.0 to 999.9								A	A	
282	0101100010	COMP bus voltage	00.0 to 999.9								A	A	The unit is [ V ]
283	1101100010	LEV2b	0000 to 9999								A	A	Outdoor LEV opening (Fully open: 3000)
288	0000010010	COMP Operation time Upper 4 digits	0000 to 9999								A	A	The unit is [ h ]
289	1000010010	COMP Operation time Lower 4 digits	0000 to 9999								A	A	
294	0110010010	COMP number of start-stop events Upper 4 digits	0000 to 9999								A	A	Count-up at start-up The unit is [Time]
295	1110010010	COMP number of start-stop events Lower 4 digits	0000 to 9999								A	A	
300	0011010010	Integrated operation time of compressor (for rotation purpose)	0000 to 9999								B		The unit is [ h ]

\*1 A: The condition of either OC or OS is displayed individually. B: The condition of the entire refrigerant system is displayed.

**Current data**

No.	SW4 (When SW6-10 is set to OFF) 1234567890	Item	Display									Unit (A, B) <sup>*1</sup>		Remarks
			LD1	LD2	LD3	LD4	LD5	LD6	LD7	LD8	OC	OS		
301	1011010010	Power supply unit	OC/OS-1/OS-2 ↔ Address									B		
302	0111010010	Start-up unit	OC/OS-1/OS-2 ↔ Address									B		

\*1 A: The condition of either OC or OS is displayed individually. B: The condition of the entire refrigerant system is displayed.

**Data on indoor unit system**

No.	SW4 (When SW6-10 is set to OFF) 1234567890	Item	Display								Unit (A, B) *1		Remarks		
			LD1	LD2	LD3	LD4	LD5	LD6	LD7	LD8	OC	OS			
351	1111101010	IC1 Address/capacity code	0000 to 9999												Displayed alternately every 5 seconds
352	0000011010	IC2 Address/capacity code	0000 to 9999												
353	1000011010	IC3 Address/capacity code	0000 to 9999												
354	0100011010	IC4 Address/capacity code	0000 to 9999												
355	1100011010	IC5 Address/capacity code	0000 to 9999												
356	0010011010	IC6 Address/capacity code	0000 to 9999												
357	1010011010	IC7 Address/capacity code	0000 to 9999												
358	0110011010	IC8 Address/capacity code	0000 to 9999												
359	1110011010	IC9 Address/capacity code	0000 to 9999												
360	0001011010	IC10 Address/capacity code	0000 to 9999												
361	1001011010	IC11 Address/capacity code	0000 to 9999												
362	0101011010	IC12 Address/capacity code	0000 to 9999												
363	1101011010	IC13 Address/capacity code	0000 to 9999												
364	0011011010	IC14 Address/capacity code	0000 to 9999												
365	1011011010	IC15 Address/capacity code	0000 to 9999												
366	0111011010	IC16 Address/capacity code	0000 to 9999												
367	1111011010	IC17 Address/capacity code	0000 to 9999												

\*1 A: The condition of either OC or OS is displayed individually. B: The condition of the entire refrigerant system is displayed.

**Data on indoor unit system**

No.	SW4 (When SW6 - 10 is set to OFF) 1234567890	Item	Display								Unit (A, B) *1		Remarks		
			LD1	LD2	LD3	LD4	LD5	LD6	LD7	LD8	OC	OS			
368	0000111010	IC18 Address/capacity code	0000 to 9999												Displayed alternately every 5 seconds
369	1000111010	IC19 Address/capacity code	0000 to 9999												
370	0100111010	IC20 Address/capacity code	0000 to 9999												
371	1100111010	IC21 Address/capacity code	0000 to 9999												
372	0010111010	IC22 Address/capacity code	0000 to 9999												
373	1010111010	IC23 Address/capacity code	0000 to 9999												
374	0110111010	IC24 Address/capacity code	0000 to 9999												
375	1110111010	IC25 Address/capacity code	0000 to 9999												
376	0001111010	IC26 Address/capacity code	0000 to 9999												
377	1001111010	IC27 Address/capacity code	0000 to 9999												
378	0101111010	IC28 Address/capacity code	0000 to 9999												
379	1101111010	IC29 Address/capacity code	0000 to 9999												
380	0011111010	IC30 Address/capacity code	0000 to 9999												
381	1011111010	IC31 Address/capacity code	0000 to 9999												
382	0111111010	IC32 Address/capacity code	0000 to 9999												
383	1111111010	IC33 Address/capacity code	0000 to 9999												
384	0000000110	IC34 Address/capacity code	0000 to 9999												
385	1000000110	IC35 Address/capacity code	0000 to 9999												
386	0100000110	IC36 Address/capacity code	0000 to 9999												
387	1100000110	IC37 Address/capacity code	0000 to 9999												
388	0010000110	IC38 Address/capacity code	0000 to 9999												
389	1010000110	IC39 Address/capacity code	0000 to 9999												
390	0110000110	IC40 Address/capacity code	0000 to 9999												
391	1110000110	IC41 Address/capacity code	0000 to 9999												
392	0001000110	IC42 Address/capacity code	0000 to 9999												
393	1001000110	IC43 Address/capacity code	0000 to 9999												
394	0101000110	IC44 Address/capacity code	0000 to 9999												
395	1101000110	IC45 Address/capacity code	0000 to 9999												

\*1 A: The condition of either OC or OS is displayed individually. B: The condition of the entire refrigerant system is displayed.



**Data on indoor unit system**

No.	SW4 (When SW6-10 is set to OFF) 1234567890	Item	Display								Unit (A, B) *1		Remarks		
			LD1	LD2	LD3	LD4	LD5	LD6	LD7	LD8	OC	OS			
396	0011000110	IC46 Address/capacity code	0000 to 9999												Displayed alternately every 5 seconds
397	1011000110	IC47 Address/capacity code	0000 to 9999												
398	0111000110	IC48 Address/capacity code	0000 to 9999												
399	1111000110	IC49 Address/capacity code	0000 to 9999												
400	0000100110	IC50 Address/capacity code	0000 to 9999												
408	0001100110	IC1 Suction temperature	-99.9 to 999.9												The unit is [°C]
409	1001100110	IC2 Suction temperature	-99.9 to 999.9												
410	0101100110	IC3 Suction temperature	-99.9 to 999.9												
411	1101100110	IC4 Suction temperature	-99.9 to 999.9												

\*1 A: The condition of either OC or OS is displayed individually. B: The condition of the entire refrigerant system is displayed.

**Data on indoor unit system**

No.	SW4 (When SW6-10 is set to OFF) 1234567890	Item	Display									Unit (A, B) *1			Remarks	
			LD1	LD2	LD3	LD4	LD5	LD6	LD7	LD8	OC	OS				
412	0011100110	IC5 Suction temperature														
413	1011100110	IC6 Suction temperature														
414	0111100110	IC7 Suction temperature														
415	1111100110	IC8 Suction temperature														
416	0000010110	IC9 Suction temperature														
417	1000010110	IC10 Suction temperature														
418	0100010110	IC11 Suction temperature														
419	1100010110	IC12 Suction temperature														
420	0010010110	IC13 Suction temperature														
421	1010010110	IC14 Suction temperature														
422	0110010110	IC15 Suction temperature														
423	1110010110	IC16 Suction temperature														
424	0001010110	IC17 Suction temperature														
425	1001010110	IC18 Suction temperature														
426	0101010110	IC19 Suction temperature														
427	1101010110	IC20 Suction temperature														
428	0011010110	IC21 Suction temperature														
429	1011010110	IC22 Suction temperature														
430	0111010110	IC23 Suction temperature														
431	1111010110	IC24 Suction temperature														
432	0000110110	IC25 Suction temperature														
433	1000110110	IC26 Suction temperature														
434	0100110110	IC27 Suction temperature														
435	1100110110	IC28 Suction temperature														

\*1 A: The condition of either OC or OS is displayed individually. B: The condition of the entire refrigerant system is displayed.

**Data on indoor unit system**

No.	SW4 (When SW6-10 is set to OFF) 1234567890	Item	Display								Unit (A, B) *1		Remarks	
			LD1	LD2	LD3	LD4	LD5	LD6	LD7	LD8	OC	OS		
436	0010110110	IC29 Suction temperature											B	The unit is [°C]
437	1010110110	IC30 Suction temperature												
438	0110110110	IC31 Suction temperature												
439	1110110110	IC32 Suction temperature												
440	0001110110	IC33 Suction temperature												
441	1001110110	IC34 Suction temperature												
442	0101110110	IC35 Suction temperature												
443	1101110110	IC36 Suction temperature												
444	0011110110	IC37 Suction temperature												
445	1011110110	IC38 Suction temperature												
446	0111110110	IC39 Suction temperature												
447	1111110110	IC40 Suction temperature												
448	000001110	IC41 Suction temperature												
449	100001110	IC42 Suction temperature												
450	010001110	IC43 Suction temperature												
451	110001110	IC44 Suction temperature												
452	0010001110	IC45 Suction temperature												
453	1010001110	IC46 Suction temperature												
454	0110001110	IC47 Suction temperature												
455	1110001110	IC48 Suction temperature												
456	0001001110	IC49 Suction temperature												
457	1001001110	IC50 Suction temperature												
458	0101001110	IC1 Liquid pipe temperature												The unit is [°C]
459	1101001110	IC2 Liquid pipe temperature												
460	0011001110	IC3 Liquid pipe temperature												
461	1011001110	IC4 Liquid pipe temperature												
462	0111001110	IC5 Liquid pipe temperature												
463	1111001110	IC6 Liquid pipe temperature												

\*1 A: The condition of either OC or OS is displayed individually. B: The condition of the entire refrigerant system is displayed.

**Data on indoor unit system**

No.	SW4 (When SW6-10 is set to OFF) 1234567890	Item	Display								Unit (A, B) *1		Remarks		
			LD1	LD2	LD3	LD4	LD5	LD6	LD7	LD8	OC	OS			
464	0000101110	IC7 Liquid pipe temperature													The unit is [°C]
465	1000101110	IC8 Liquid pipe temperature													
466	0100101110	IC9 Liquid pipe temperature													
467	1100101110	IC10 Liquid pipe temperature													
468	0010101110	IC11 Liquid pipe temperature													
469	1010101110	IC12 Liquid pipe temperature													
470	0110101110	IC13 Liquid pipe temperature													
471	1110101110	IC14 Liquid pipe temperature													
472	0001101110	IC15 Liquid pipe temperature													
473	1001101110	IC16 Liquid pipe temperature													
474	0101101110	IC17 Liquid pipe temperature													
475	1101101110	IC18 Liquid pipe temperature													
476	0011101110	IC19 Liquid pipe temperature													
477	1011101110	IC20 Liquid pipe temperature													
478	0111101110	IC21 Liquid pipe temperature													
479	1111101110	IC22 Liquid pipe temperature													
480	0000011110	IC23 Liquid pipe temperature													
481	1000011110	IC24 Liquid pipe temperature													
482	0100011110	IC25 Liquid pipe temperature													
483	1100011110	IC26 Liquid pipe temperature													
484	0010011110	IC27 Liquid pipe temperature													
485	1010011110	IC28 Liquid pipe temperature													
486	0110011110	IC29 Liquid pipe temperature													
487	1110011110	IC30 Liquid pipe temperature													
488	0001011110	IC31 Liquid pipe temperature													
489	1001011110	IC32 Liquid pipe temperature													
490	0101011110	IC33 Liquid pipe temperature													
491	1101011110	IC34 Liquid pipe temperature													

\*1 A: The condition of either OC or OS is displayed individually. B: The condition of the entire refrigerant system is displayed.

**Data on indoor unit system**

No.	SW4 (When SW6-10 is set to OFF) 1234567890	Item	Display								Unit (A, B) *1		Remarks	
			LD1	LD2	LD3	LD4	LD5	LD6	LD7	LD8	OC	OS		
492	0011011110	IC35 Liquid pipe temperature												
493	1011011110	IC36 Liquid pipe temperature												
494	0111011110	IC37 Liquid pipe temperature												
495	1111011110	IC38 Liquid pipe temperature												
496	0000111110	IC39 Liquid pipe temperature												
497	1000111110	IC40 Liquid pipe temperature												
498	0100111110	IC41 Liquid pipe temperature												
499	1100111110	IC42 Liquid pipe temperature												
500	0010111110	IC43 Liquid pipe temperature												
501	1010111110	IC44 Liquid pipe temperature												
502	0110111110	IC45 Liquid pipe temperature												
503	1110111110	IC46 Liquid pipe temperature												
504	0001111110	IC47 Liquid pipe temperature												
505	1001111110	IC48 Liquid pipe temperature												
506	0101111110	IC49 Liquid pipe temperature												
507	1101111110	IC50 Liquid pipe temperature												

\*1 A: The condition of either OC or OS is displayed individually. B: The condition of the entire refrigerant system is displayed.

The unit is [°C]

**Setting data**

No.	SW4 (When SW6-10 is set to OFF) 1234567890	Item	Display								Unit (A, B) <sup>*1</sup>		Remarks
			LD1	LD2	LD3	LD4	LD5	LD6	LD7	LD8	OC	OS	
512	0000000001	Self-address	Alternate display of self address and unit model								A	A	
513	1000000001	IC/FU address	Count-up display of number of connected units								B		
514	0100000001	RC address	Count-up display of number of connected units								B		
516	0010000001	OS address	Count-up display of number of connected units								B		
517	1010000001	Version/Capacity	S/W version → Refrigerant type → Model and capacity → Communication address								A	A	
518	0110000001	OC address	OC address display									B	

\*1 A: The condition of either OC or OS is displayed individually. B: The condition of the entire refrigerant system is displayed.

**Data on indoor unit system**

No.	SW4 (When SW6-10 is set to OFF) 1234567890	Item	Display								Unit (A, B) <sup>*1</sup>		Remarks	
			LD1	LD2	LD3	LD4	LD5	LD6	LD7	LD8	OC	OS		
523	1101000001	IC1 Gas pipe temperature												
524	0011000001	IC2 Gas pipe temperature												
525	1011000001	IC3 Gas pipe temperature												
526	0111000001	IC4 Gas pipe temperature												
527	1111000001	IC5 Gas pipe temperature												
528	0000100001	IC6 Gas pipe temperature												
529	1000100001	IC7 Gas pipe temperature												
530	0100100001	IC8 Gas pipe temperature												
531	1100100001	IC9 Gas pipe temperature												
532	0010100001	IC10 Gas pipe temperature												
533	1010100001	IC11 Gas pipe temperature												
534	0110100001	IC12 Gas pipe temperature												
535	1110100001	IC13 Gas pipe temperature												
536	0001100001	IC14 Gas pipe temperature												
537	1001100001	IC15 Gas pipe temperature												
538	0101100001	IC16 Gas pipe temperature												
539	1101100001	IC17 Gas pipe temperature												
540	0011100001	IC18 Gas pipe temperature												
541	1011100001	IC19 Gas pipe temperature												
542	0111100001	IC20 Gas pipe temperature												
543	1111100001	IC21 Gas pipe temperature												
544	0000010001	IC22 Gas pipe temperature												
545	1000010001	IC23 Gas pipe temperature												
546	0100010001	IC24 Gas pipe temperature												
547	1100010001	IC25 Gas pipe temperature												
548	0010010001	IC26 Gas pipe temperature												
549	1010010001	IC27 Gas pipe temperature												

The unit is [°C]

\*1 A: The condition of either OC or OS is displayed individually. B: The condition of the entire refrigerant system is displayed.

**Data on indoor unit system**

No.	SW4 (When SW6-10 is set to OFF) 1234567890	Item	Display									Unit (A, B) *1		Remarks	
			LD1	LD2	LD3	LD4	LD5	LD6	LD7	LD8	OC	OS			
550	0110010001	IC28 Gas pipe temperature	-99.9 to 999.9												The unit is [°C]
551	1110010001	IC29 Gas pipe temperature	-99.9 to 999.9												
552	0001010001	IC30 Gas pipe temperature	-99.9 to 999.9												
553	1001010001	IC31 Gas pipe temperature	-99.9 to 999.9												
554	0101010001	IC32 Gas pipe temperature	-99.9 to 999.9												
555	1101010001	IC33 Gas pipe temperature	-99.9 to 999.9												
556	0011010001	IC34 Gas pipe temperature	-99.9 to 999.9												
557	1011010001	IC35 Gas pipe temperature	-99.9 to 999.9												
558	0111010001	IC36 Gas pipe temperature	-99.9 to 999.9												
559	1111010001	IC37 Gas pipe temperature	-99.9 to 999.9												
560	0000110001	IC38 Gas pipe temperature	-99.9 to 999.9												
561	1000110001	IC39 Gas pipe temperature	-99.9 to 999.9												
562	0100110001	IC40 Gas pipe temperature	-99.9 to 999.9												
563	1100110001	IC41 Gas pipe temperature	-99.9 to 999.9												
564	0010110001	IC42 Gas pipe temperature	-99.9 to 999.9												
565	1010110001	IC43 Gas pipe temperature	-99.9 to 999.9												
566	0110110001	IC44 Gas pipe temperature	-99.9 to 999.9												
567	1110110001	IC45 Gas pipe temperature	-99.9 to 999.9												
568	0001110001	IC46 Gas pipe temperature	-99.9 to 999.9												
569	1001110001	IC47 Gas pipe temperature	-99.9 to 999.9												
570	0101110001	IC48 Gas pipe temperature	-99.9 to 999.9												
571	1101110001	IC49 Gas pipe temperature	-99.9 to 999.9												
572	0011110001	IC50 Gas pipe temperature	-99.9 to 999.9												

\*1 A: The condition of either OC or OS is displayed individually. B: The condition of the entire refrigerant system is displayed.



**Data on indoor unit system**

No.	SW4 (When SW6-10 is set to OFF) 1234567890	Item	Display								Unit (A, B) <sup>*1</sup>		Remarks	
			LD1	LD2	LD3	LD4	LD5	LD6	LD7	LD8	OC	OS		
573	1011110001	IC1SH												The unit is [ °C ]
574	0111110001	IC2SH												
575	1111110001	IC3SH												
576	000001001	IC4SH												
577	100001001	IC5SH												
578	010001001	IC6SH												
579	110001001	IC7SH												
580	0010001001	IC8SH												
581	1010001001	IC9SH												
582	0110001001	IC10SH												
583	1110001001	IC11SH												
584	0001001001	IC12SH												
585	1001001001	IC13SH												
586	0101001001	IC14SH												
587	1101001001	IC15SH												
588	0011001001	IC16SH												
589	1011001001	IC17SH												
590	0111001001	IC18SH												
591	1111001001	IC19SH												
592	0000101001	IC20SH												
593	1000101001	IC21SH												
594	0100101001	IC22SH												
595	1100101001	IC23SH												
596	0010101001	IC24SH												
597	1010101001	IC25SH												
598	0110101001	IC26SH												
599	1110101001	IC27SH												

\*1 A: The condition of either OC or OS is displayed individually. B: The condition of the entire refrigerant system is displayed.

**Data on indoor unit system**

No.	SW4 (When SW6-10 is set to OFF) 1234567890	Item	Display									Unit (A, B) <sup>*1</sup>		Remarks		
			LD1	LD2	LD3	LD4	LD5	LD6	LD7	LD8	OC	OS				
600	0001101001	IC28SH														
601	1001101001	IC29SH														
602	0101101001	IC30SH														
603	1101101001	IC31SH														
604	0011101001	IC32SH														
605	1011101001	IC33SH														
606	0111101001	IC34SH														
607	1111101001	IC35SH														
608	0000011001	IC36SH														
609	1000011001	IC37SH														
610	0100011001	IC38SH														
611	1100011001	IC39SH														
612	0010011001	IC40SH														
613	1010011001	IC41SH														
614	0110011001	IC42SH														
615	1110011001	IC43SH														
616	0001011001	IC44SH														
617	1001011001	IC45SH														
618	0101011001	IC46SH														
619	1101011001	IC47SH														
620	0011011001	IC48SH														
621	1011011001	IC49SH														
622	0111011001	IC50SH														

\*1 A: The condition of either OC or OS is displayed individually. B: The condition of the entire refrigerant system is displayed.

**Data on indoor unit system**

No.	SW4 (When SW6-10 is set to OFF) 1234567890	Item	Display								Unit (A, B) <sup>*1</sup>		Remarks	
			LD1	LD2	LD3	LD4	LD5	LD6	LD7	LD8	OC	OS		
623	1111011001	IC1SC												
624	0000111001	IC2SC												
625	1000111001	IC3SC												
626	0100111001	IC4SC												
627	1100111001	IC5SC												
628	0010111001	IC6SC												
629	1010111001	IC7SC												
630	0110111001	IC8SC												
631	1110111001	IC9SC												
632	0001111001	IC10SC												
633	1001111001	IC11SC												
634	0101111001	IC12SC												
635	1101111001	IC13SC												
636	0011111001	IC14SC												
637	1011111001	IC15SC												
638	0111111001	IC16SC												
639	1111111001	IC17SC												
640	0000000101	IC18SC												
641	1000000101	IC19SC												
642	0100000101	IC20SC												
643	1100000101	IC21SC												
644	0010000101	IC22SC												
645	1010000101	IC23SC												
646	0110000101	IC24SC												
647	1110000101	IC25SC												
648	0001000101	IC26SC												
649	1001000101	IC27SC												

The unit is [ °C ]

\*1 A: The condition of either OC or OS is displayed individually. B: The condition of the entire refrigerant system is displayed.

**Data on indoor unit system**

No.	SW4 (When SW6-10 is set to OFF) 1234567890	Item	Display									Unit (A, B) <sup>*1</sup>			Remarks			
			LD1	LD2	LD3	LD4	LD5	LD6	LD7	LD8	OC	OS						
650	0101000101	IC28SC																
651	1101000101	IC29SC																
652	0011000101	IC30SC																
653	1011000101	IC31SC																
654	0111000101	IC32SC																
655	1111000101	IC33SC																
656	0000100101	IC34SC																
657	1000100101	IC35SC																
658	0100100101	IC36SC																
659	1100100101	IC37SC																
660	0010100101	IC38SC																
661	1010100101	IC39SC																
662	0110100101	IC40SC																
663	1110100101	IC41SC																
664	0001100101	IC42SC																
665	1001100101	IC43SC																
666	0101100101	IC44SC																
667	1101100101	IC45SC																
668	0011100101	IC46SC																
669	1011100101	IC47SC																
670	0111100101	IC48SC																
671	1111100101	IC49SC																
672	0000010101	IC50SC																

\*1 A: The condition of either OC or OS is displayed individually. B: The condition of the entire refrigerant system is displayed.

**Setting data**

No.	SW4 (When SW6-10 is set to OFF) 1234567890	Item	Display								Unit (A, B)*1		Remarks
			LD1	LD2	LD3	LD4	LD5	LD6	LD7	LD8	OC	OS	
676	0010010101	INV board S/W version	0.00 to 99.99								A	A	
679	1110010101	Fan board (address 5) S/W version	0.00 to 99.99								A	A	
680	0001010101	Fan board (address 6) S/W version	0.00 to 99.99								A	A	
688	0000110101	Current time	00:00 to 23:59								A	A	Hour: minute
689	1000110101	Current time -2	00.00 to 99.12/1 to 31										Year and month, and date alternate display
690	0100110101	Time of error detection 1	00:00 to 23:59										Hour: minute
691	1100110101	Time of error detection 1-2	00.00 to 99.12/1 to 31										Year and month, and date alternate display
692	0010110101	Time of error detection 2	00:00 to 23:59										Hour: minute
693	1010110101	Time of error detection 2-2	00.00 to 99.12/1 to 31										Year and month, and date alternate display
694	0110110101	Time of error detection 3	00:00 to 23:59										Hour: minute
695	1110110101	Time of error detection 3-2	00.00 to 99.12/1 to 31										Year and month, and date alternate display
696	0001110101	Time of error detection 4	00:00 to 23:59										Hour: minute
697	1001110101	Time of error detection 4-2	00.00 to 99.12/1 to 31										Year and month, and date alternate display
698	0101110101	Time of error detection 5	00:00 to 23:59										Hour: minute
699	1101110101	Time of error detection 5-2	00.00 to 99.12/1 to 31										Year and month, and date alternate display
700	0011110101	Time of error detection 6	00:00 to 23:59										Hour: minute
701	1011110101	Time of error detection 6-2	00.00 to 99.12/1 to 31										Year and month, and date alternate display

\*1 A: The condition of either OC or OS is displayed individually. B: The condition of the entire refrigerant system is displayed.

**Setting data**

No.	SW4 (When SW6-10 is set to OFF) 1234567890	Item	Display								Unit (A, B)*1		Remarks
			LD1	LD2	LD3	LD4	LD5	LD6	LD7	LD8	OC	OS	
702	0111110101	Time of error detection 7	00:00 to 23:59								A		Hour: minute
703	1111110101	Time of error detection 7-2	00.00 to 99.12/1 to 31										Year and month, and date alternate display
704	0000001101	Time of error detection 8	00:00 to 23:59										Hour: minute
705	1000001101	Time of error detection 8-2	00.00 to 99.12/1 to 31										Year and month, and date alternate display
706	0100001101	Time of error detection 9	00:00 to 23:59										Hour: minute
707	1100001101	Time of error detection 9-2	00.00 to 99.12/1 to 31										Year and month, and date alternate display
708	0010001101	Time of error detection 10	00:00 to 23:59										Hour: minute
709	1010001101	Time of error detection 10-2	00.00 to 99.12/1 to 31										Year and month, and date alternate display
710	0110001101	Time of last data backup before error	00:00 to 23:59										Hour: minute
711	1110001101	Time of last data backup before error -2	00.00 to 99.12/1 to 31										Year and month, and date alternate display

\*1 A: The condition of either OC or OS is displayed individually. B: The condition of the entire refrigerant system is displayed.

**Data on indoor unit system**

No.	SW4 (When SW6-10 is set to OFF) 1234567890	Item	Display								Unit (A, B) * 1		Remarks			
			LD1	LD2	LD3	LD4	LD5	LD6	LD7	LD8	OC	OS				
714	0101001101	IC1 LEV opening												B		Fully open: 2000
715	1101001101	IC2 LEV opening														
716	0011001101	IC3 LEV opening														
717	1011001101	IC4 LEV opening														
718	0111001101	IC5 LEV opening														
719	1111001101	IC6 LEV opening														
720	0000101101	IC7 LEV opening														
721	1000101101	IC8 LEV opening														
722	0100101101	IC9 LEV opening														
723	1100101101	IC10 LEV opening														
724	0010101101	IC11 LEV opening														
725	1010101101	IC12 LEV opening														
726	0110101101	IC13 LEV opening														
727	1110101101	IC14 LEV opening														
728	0001101101	IC15 LEV opening														
729	1001101101	IC16 LEV opening														
730	0101101101	IC17 LEV opening														
731	1101101101	IC18 LEV opening														
732	0011101101	IC19 LEV opening														
733	1011101101	IC20 LEV opening														
734	0111101101	IC21 LEV opening														
735	1111101101	IC22 LEV opening														
736	0000011101	IC23 LEV opening														
737	1000011101	IC24 LEV opening														
738	0100011101	IC25 LEV opening														
739	1100011101	IC26 LEV opening														
740	0010011101	IC27 LEV opening														

\*1 A: The condition of either OC or OS is displayed individually. B: The condition of the entire refrigerant system is displayed.

**Data on indoor unit system**

No.	SW4 (When SW6-10 is set to OFF) 1234567890	Item	Display								Unit (A, B) 1		Remarks
			LD1	LD2	LD3	LD4	LD5	LD6	LD7	LD8	OC	OS	
741	1010011101	IC28 LEV opening	0000 to 9999								B		Fully open: 2000
742	0110011101	IC29 LEV opening	0000 to 9999										
743	1110011101	IC30 LEV opening	0000 to 9999										
744	0001011101	IC31 LEV opening	0000 to 9999										
745	1001011101	IC32 LEV opening	0000 to 9999										
746	0101011101	IC33 LEV opening	0000 to 9999										
747	1101011101	IC34 LEV opening	0000 to 9999										
748	0011011101	IC35 LEV opening	0000 to 9999										
749	1011011101	IC36 LEV opening	0000 to 9999										
750	0111011101	IC37 LEV opening	0000 to 9999										
751	1111011101	IC38 LEV opening	0000 to 9999										
752	0000111101	IC39 LEV opening	0000 to 9999										
753	1000111101	IC40 LEV opening	0000 to 9999										
754	0100111101	IC41 LEV opening	0000 to 9999										
755	1100111101	IC42 LEV opening	0000 to 9999										
756	0010111101	IC43 LEV opening	0000 to 9999										
757	1010111101	IC44 LEV opening	0000 to 9999										
758	0110111101	IC45 LEV opening	0000 to 9999										
759	1110111101	IC46 LEV opening	0000 to 9999										
760	0001111101	IC47 LEV opening	0000 to 9999										
761	1001111101	IC48 LEV opening	0000 to 9999										
762	0101111101	IC49 LEV opening	0000 to 9999										
763	1101111101	IC50 LEV opening	0000 to 9999										
764	0011111101	IC1 Operation mode	0000: Stop 0001: Ventilation 0002: Cooling 0003: Heating 0004: Dry								B		
765	1011111101	IC2 Operation mode											
766	0111111101	IC3 Operation mode											
767	1111111101	IC4 Operation mode											
768	0000000011	IC5 Operation mode											

\*1 A: The condition of either OC or OS is displayed individually. B: The condition of the entire refrigerant system is displayed.



**Data on indoor unit system**

No.	SW4 (When SW6 - 10 is set to OFF) 1234567890	Item	Display								Unit (A, B) * 1		Remarks		
			LD1	LD2	LD3	LD4	LD5	LD6	LD7	LD8	OC	OS			
769	1000000011	IC6 Operation mode											B		
770	0100000011	IC7 Operation mode													
771	1100000011	IC8 Operation mode													
772	0010000011	IC9 Operation mode													
773	1010000011	IC10 Operation mode													
774	0110000011	IC11 Operation mode													
775	1110000011	IC12 Operation mode													
776	0001000011	IC13 Operation mode													
777	1001000011	IC14 Operation mode													
778	0101000011	IC15 Operation mode													
779	1101000011	IC16 Operation mode													
780	0011000011	IC17 Operation mode													
781	1011000011	IC18 Operation mode													
782	0111000011	IC19 Operation mode													
783	1111000011	IC20 Operation mode													
784	0000100011	IC21 Operation mode													
785	1000100011	IC22 Operation mode													
786	0100100011	IC23 Operation mode													
787	1100100011	IC24 Operation mode													
788	0010100011	IC25 Operation mode													
789	1010100011	IC26 Operation mode													
790	0110100011	IC27 Operation mode													
791	1110100011	IC28 Operation mode													
792	0001100011	IC29 Operation mode													
793	1001100011	IC30 Operation mode													
794	0101100011	IC31 Operation mode													
795	1101100011	IC32 Operation mode													
796	0011100011	IC33 Operation mode													

0000: Stop 0001: Ventilation 0002: Cooling 0003: Heating 0004: Dry

\*1 A: The condition of either OC or OS is displayed individually. B: The condition of the entire refrigerant system is displayed.

**Data on indoor unit system**

No.	SW4 (When SW6-10 is set to OFF) 1234567890	Item	Display								Unit (A, B) <sup>1</sup>		Remarks	
			LD1	LD2	LD3	LD4	LD5	LD6	LD7	LD8	OC	OS		
797	1011100011	IC34 Operation mode										B		
798	0111100011	IC35 Operation mode												
799	1111100011	IC36 Operation mode												
800	0000010011	IC37 Operation mode												
801	1000010011	IC38 Operation mode												
802	0100010011	IC39 Operation mode												
803	1100010011	IC40 Operation mode												
804	0010010011	IC41 Operation mode												
805	1010010011	IC42 Operation mode												
806	0110010011	IC43 Operation mode												
807	1110010011	IC44 Operation mode												
808	0001010011	IC45 Operation mode												
809	1001010011	IC46 Operation mode												
810	0101010011	IC47 Operation mode												
811	1101010011	IC48 Operation mode												
812	0011010011	IC49 Operation mode												
813	1011010011	IC50 Operation mode												
814	0111010011	IC1 filter												Hours since last maintenance [ h ]
815	1111010011	IC2 filter												
816	0000100011	IC3 filter												
817	1000100011	IC4 filter												
818	0100100011	IC5 filter												
819	1100100011	IC6 filter												
820	0010100011	IC7 filter												
821	1010100011	IC8 filter												
822	0110100011	IC9 filter												
823	1110100011	IC10 filter												
824	0001100011	IC11 filter												

0000: Stop 0001: Ventilation 0002: Cooling 0003: Heating 0004: Dry

0000 to 9999  
0000 to 9999  
0000 to 9999  
0000 to 9999  
0000 to 9999  
0000 to 9999  
0000 to 9999  
0000 to 9999  
0000 to 9999  
0000 to 9999

\*1 A: The condition of either OC or OS is displayed individually. B: The condition of the entire refrigerant system is displayed.

**Data on indoor unit system**

No.	SW4 (When SW6-10 is set to OFF) 1234567890	Item	Display								Unit (A, B) *1		Remarks
			LD1	LD2	LD3	LD4	LD5	LD6	LD7	LD8	OC	OS	
825	1001110011	IC12 filter	0000 to 9999								B		Hours since last maintenance [ h ]
826	0101110011	IC13 filter	0000 to 9999										
827	1101110011	IC14 filter	0000 to 9999										
828	0011110011	IC15 filter	0000 to 9999										
829	1011110011	IC16 filter	0000 to 9999										
830	0111110011	IC17 filter	0000 to 9999										
831	1111110011	IC18 filter	0000 to 9999										
832	0000001011	IC19 filter	0000 to 9999										
833	1000001011	IC20 filter	0000 to 9999										
834	0100001011	IC21 filter	0000 to 9999										
835	1100001011	IC22 filter	0000 to 9999										
836	0010001011	IC23 filter	0000 to 9999										
837	1010001011	IC24 filter	0000 to 9999										
838	0110001011	IC25 filter	0000 to 9999										
839	1110001011	IC26 filter	0000 to 9999										
840	0001001011	IC27 filter	0000 to 9999										
841	1001001011	IC28 filter	0000 to 9999										
842	0101001011	IC29 filter	0000 to 9999										
843	1101001011	IC30 filter	0000 to 9999										
844	0011001011	IC31 filter	0000 to 9999										
845	1011001011	IC32 filter	0000 to 9999										
846	0111001001	IC33 filter	0000 to 9999										
847	1111001011	IC34 filter	0000 to 9999										
848	0000101011	IC35 filter	0000 to 9999										
849	1000101011	IC36 filter	0000 to 9999										
850	0100101011	IC37 filter	0000 to 9999										
851	1100101011	IC38 filter	0000 to 9999										
852	0010101011	IC39 filter	0000 to 9999										

\*1 A: The condition of either OC or OS is displayed individually. B: The condition of the entire refrigerant system is displayed.

**Data on indoor unit system**

No.	SW4 (When SW6-10 is set to OFF) 1234567890	Item	Display									Unit (A, B) <sup>1</sup>		Remarks
			LD1	LD2	LD3	LD4	LD5	LD6	LD7	LD8	OC	OS		
853	1010101011	IC40 filter	0000 to 9999									B		Hours since last maintenance [ h ]
854	0110101011	IC41 filter	0000 to 9999											
855	1110101011	IC42 filter	0000 to 9999											
856	0001101011	IC43 filter	0000 to 9999											
857	1001101011	IC44 filter	0000 to 9999											
858	0101101011	IC45 filter	0000 to 9999											
859	1101101011	IC46 filter	0000 to 9999											
860	0011101011	IC47 filter	0000 to 9999											
861	1011101011	IC48 filter	0000 to 9999											
862	0111101011	IC49 filter	0000 to 9999											
863	1111101011	IC50 filter	0000 to 9999											

\*1 A: The condition of either OC or OS is displayed individually. B: The condition of the entire refrigerant system is displayed.

**Other types of data**

No.	SW4 (When SW6-10 is set to OFF) 1234567890	Item	Display								Unit (A, B) *1		Remarks
			LD1	LD2	LD3	LD4	LD5	LD6	LD7	LD8	OC	OS	
871	1110011011	U-phase current effective value 1	-99.9 to 999.9								A	A	The unit is [ A ]
872	0001011011	W-phase current effective value 1	-99.9 to 999.9								A	A	
873	1001011011	Power factor phase angle 1	-99.9 to 999.9								A	A	The unit is [ deg ]
880	0000111011	Control board Reset counter	0 to 254								A	A	The unit is [ time ]
881	1000111011	INV board Reset counter	0 to 254								A	A	
884	0010111011	Fan board (address 5) reset counter	0 to 254								A	A	The unit is [ time ]
885	1010111011	Fan board (address 6) reset counter	0 to 254								A	A	

\*1 A: The condition of either OC or OS is displayed individually. B: The condition of the entire refrigerant system is displayed.



# Service Handbook

**Model**

**PUHY-P200, P250, P300, P350, P400, P450, P500YKB-A1**

**PUHY-P400, P450, P500, P550, P600, P650, P700, P750, P800, P850, P900YSKB-A1**

**PUHY-P950, P1000, P1050, P1100, P1150, P1200, P1250, P1300, P1350YSKB-A1**

**mitsubishi** **MITSUBISHI ELECTRIC CORPORATION**

[www.MitsubishiElectric.com](http://www.MitsubishiElectric.com)