



# PUHY-P250YGM-A

Y Series 10hp Outdoor Unit

R410A Heat Pump



The City Multi Y Series makes use of a two pipe refrigerant circuit throughout, with the choice of either Branch Pipe or Header Pipe feeds to indoor units, with manual changeover from cooling to heating to ensure that a constant indoor climate is maintained.

- **Highest ever COP's / EER's due to new higher efficiency inverter technology**
- **Choice of Branch Pipe or Header Pipe feeds to indoor units**
- **Energy-saving inverter driven outdoor compressor units with very low start currents**
- **No requirement for plant rooms or bulky service shafts**
- **Improved pipe run of 150m, with a total system pipe length of 300m**
- **High Sensible Cooling Function - By raising off coil temperature, a 10% increase in sensible cooling capacity over standard operation is achievable, the result being greater comfort for occupants**



Pictures not to scale

## Product Details

PUHY-P250YGM-A	
Capacity (kW):	
Heating (Nominal)	31.5
Cooling (Nominal)	28.0
Heating (UK)	29.1
Cooling (UK)	26.6
Power Input (kW) Heating (Nominal)	7.62
Power Input (kW) Cooling (Nominal)	7.72
Power Input (kW) Heating (UK)	7.62
Power Input (kW) Cooling (UK)	4.79
Max No. of Connectable Indoor Units	16
Airflow (m3/min)	200
Noise (dBA)	57
Width - mm	990
Depth - mm	840 (877)
Height - mm	1840
Weight - kg	233
Electrical Supply	380-415v, 50Hz
Phase	3
Mains Cable No. Cores	4 + earth
Starting Current (A)	8
Running Current (A) - Heating	11.7
Running Current (A) - Cooling	11.9
Fuse Rating (BS88) - HRC (A)	25

### Piping Restrictions

Total Piping Length (m)	300
Furthest Piping Length (m)	150
Furthest Piping Length after 1st Branch (m)	40
Between Indoor and Outdoor Units - Height (m)	50
Between Indoor and Indoor Units - Height (m)	15

## Dimensions

PUHY-P250YGM-A

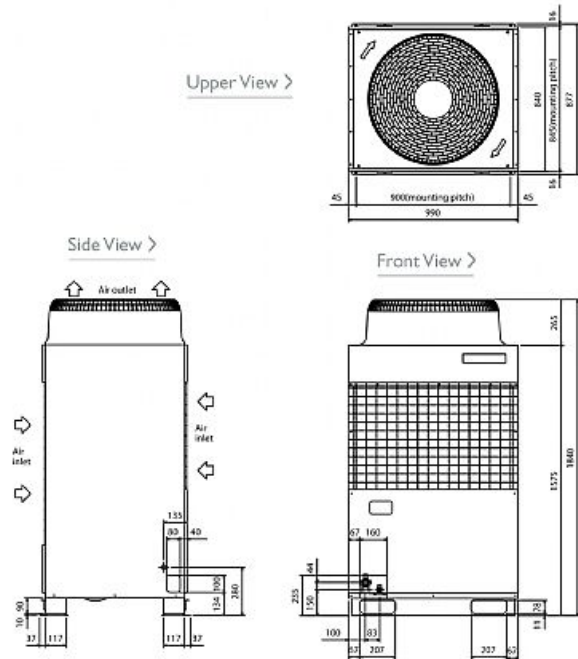

**Telephone: 01707 282880**

Email: [air.conditioning@meuk.mee.com](mailto:air.conditioning@meuk.mee.com) Website: <http://www.mitsubishielectric.co.uk/aircon>

Mitsubishi Electric reserves the right to make any variation in technical specification to the equipment described, or to withdraw or replace products without prior notification or public announcement.

Tel:  
Fax:

