

# PUHY-P200-250YREM-A

## CONTENTS

1. Specifications .....	3
2. Capacity Tables .....	5
2-1 Correction by temperature .....	5
2-2 Correction by total indoor .....	7
2-3 Correction by refrigerant piping length .....	8
2-4 Correction at frosting and defrosting .....	9
2-5 Operation limit .....	9
3. Sound Levels .....	10
4. External Dimensions .....	11
5. Electrical Wiring Diagram .....	12
6. Refrigerant Circuit Diagram .....	13
And Thermal Sensor	
7. Preparations for Installing Refrigerant Piping .....	14
7-1 Evaluating the Adaptability of the Existing Piping.....	14
7-2 Pipe Length Specifications .....	16
7-3 Selecting Refrigerant Piping .....	17
7-4 Connecting Refrigerant Pipes with Different Diameters .....	18
7-5 Calculating the Amount of Additional Refrigerant to Charge .....	22
7-6 Important Notes on Refrigerant Piping Connecting Valves .....	23

# Cautions For REPLACE MULTI Installation Work

## Flow of installation work in the field

## Items to be observed

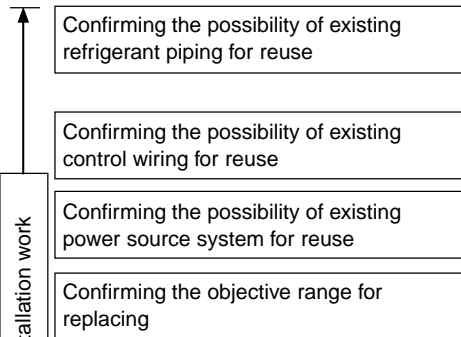

- Please note that our Corporation is not liable to the reliability of existing piping, wiring and power system for reuse (in relation with the gas leak of piping, partially defective/disconnection of wiring, deteriorated insulation, characteristic faults due to worn out system).
- For limitation on the refrigerant piping and applicable piping diameter, check the existing piping for reuse in accordance with the specified check sheet by referring to product catalogs and this manuals for judgement to reuse.
- If vapor condensation was found in the past, check the thermal insulation.
- Any portion suffering condensation dripping, check the deterioration of the insulation, and repair the insulation materials if required.
- When the copper piping is seriously deteriorated, do not use parts with verdigris or black spots.
- For reusing the existing control wiring between the outdoor unit, and remote controller, check the wire type, size or the like, based on the check sheet to judge the possibility.
- Even when the above does not meet the item on the check sheet, existing wiring may be reused depending on the number of connecting indoor units and piping length. Ask us for details.
- For the power source system, employ the voltage and number of phase meeting the outdoor unit, indoor unit and adopt the breaker capacity and wiring size based on the power source wiring connection diagram.
- When the existing power source system (including the power source wiring) is used, check the system for deterioration and damages.
- Check the refrigerating machine oil used in the existing system. (As is found at the oil inspection), if the refrigerating machine oil used in the existing system is mineral oil, use the ester oil sampling kit for inspection.
- When the length of piping for reuse is unknown, additional refrigerant charge is to be calculated based on the quantity of recovered refrigerant. For this reason, you are kindly requested to recover all refrigerant inside the existing outdoor/indoor units and extended piping to check and record the quantity. (The standard of additional refrigerant is (Quantity of R22 recovered - Charged quantity of existing outdoor unit + 3kg). Adjust the refrigerant quantity after mineral oil recovery operation.)

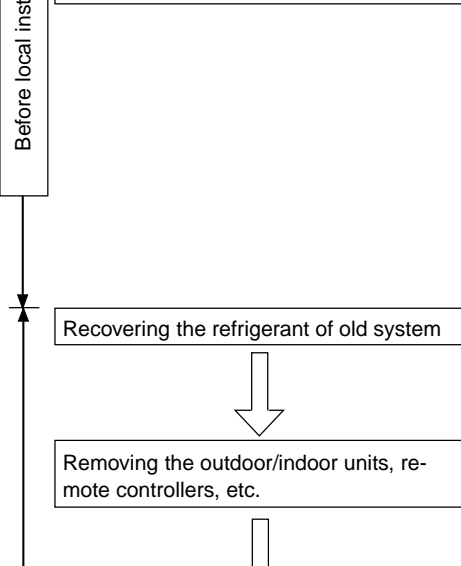

- Outdoor unit
  - Confirm the space around the outdoor unit. (Verifying the installation space of the oil trap kit)
- Turn the power source on, and confirm the normality of the system
  - Check the remote controller or outdoor unit for error display.
  - Run the indoor unit for fan operation after turning the remote controller on, and check the air feeding and direction.

**Do not run the compressor until finishing the mineral oil recovery operation.**

- Mount the valves to the field piping (extended piping). (The ball valve is attached to the outdoor unit.)
- Execute an airtight test to check the existing piping for deterioration or leaking.
- Calculate the quantity required by the extended piping, and charge the additional refrigerant. Make sure to enter the value in the additional refrigerant charge column on the label of the outdoor unit.
- If the refrigerant charge is insufficient, enter the value also.

**Without applying any operation, keep the ball valves of the outdoor unit closed before mineral oil recovery operation.**

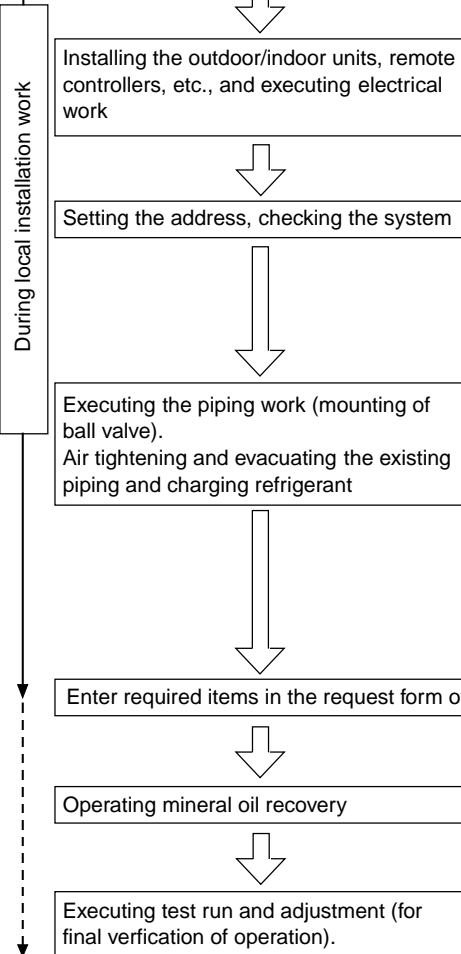

It is necessary to charge refrigerant in a rated quantity and adjust the quantity. Be sure to execute when the piping length is unknown. For detail, consult the agent of your dealer.

## Caution to Equipment Used for Replacing

### Caution

#### **Do not operate any valves before conducting mineral oil recovery operation.**

Operating valves before conducting mineral oil recovery operation may cause a deterioration in the performance of mineral oil recovery.

#### **For mineral oil recovery operation, the system controller and MA remote controller may be required to be remove sometimes.**

- Improper handling can lead to an inability to perform oil recovery operation.
- For removal, follow the instruction displayed on the PC for mineral oil recovery.
- Mount the controllers again after finishing the oil recovery operation.

#### **Observe a safe distance from the indoor unit fan which runs during the mineral oil recovery operation.**

Working in the surrounding of the indoor unit fan can cause personal injury.

#### **Record the quantity of refrigerant replenished. (Enter into the column for replenished refrigerant quantity on the label of the indoor unit.)**

- Missing the description may deteriorate the performance of mineral oil recovery.
- Malfunction or poor cooling/heating may also be caused.

#### **During the mineral oil recovery operation, an error display may be shown on the remote controller or system controller.**

- When an error display was shown during mineral oil recovery operation, reset the error display after finishing the operation.

#### **To conduct the refrigerant recovery/evacuation of the inside of exiting piping, choose tools only used with R407C e.g. charging hose.**

- Using a charging hose for R407C causes it to mix the conventional refrigerating machine oil leading to the deterioration of refrigerating machine oil.

## Before Conducting Installation Work/Electrical Work

### Caution

#### **Do not use the same switch or the like for plural outdoor units.**

Otherwise, malfunction, heat generation or fire may be caused.

#### **Be sure to mount the valve to the field piping (extended piping).**

After mineral oil recovery, the oil trap kit can not be removed disabling air conditioning operation.

#### **Provide thermal insulation to the valve on the field piping (extended piping) properly.**

- Insufficient thermal insulation generates condensation that may cause to deteriorate the performance.
- Provide thermal insulation (including lagging) after recovering mineral oil.

#### **Check possibility for the reuse of existing refrigerant piping by observing this manual.**

- The conventional refrigerating machine oil is contained inside existing piping and some residual oil deteriorates oil recovery performance which may lead to the deterioration of refrigerating machine oil.
- The piping specification (diameter, length, height difference) out of the use specified range may hinder the mineral oil recovery performance, possibly leading to deterioration of refrigerating machine oil.

#### **When using existing wiring (for power source or transmission) or switches, check them for disconnection and deterioration beforehand.**

- Otherwise an electric leak, heat generation or fire may be caused.

## Before Conducting Mineral Oil Recovery Operation

### Caution

#### **Do not run the outdoor unit during a test run until finishing the mineral oil recovery operation.**

- The indoor unit fan will run.

# 1. Specifications

Model name			PUHY-P200YREM-A	
			Cooling	Heating
Capacity	*1	kW	22.4	25.0
	*2	kcal/h	20,000	—
Power source			3N ~ 380/400/415V 50/60Hz	
Power input		kW	6.32	6.80
Current		A	10.6/10.1/9.7	11.4/10.9/10.5
Fan	Type X Quantity		Propeller fan X 1	
	Airflow rate	m <sup>3</sup> /min	200	
	Motor output	kW	0.38	
Compressor	Type		Hermetic	
	Motor output	kW	5.3	
	Crankcase heater	kW	0.045(240V)	
Refrigerant / Lubricant			R407C/MEL32	
External finish			Pre-coated galvanized sheets (Powder coating) <MUNSELL 5Y8/1 or similar>	
External dimension		mm	1755(H)X990(W)X840(L)	
Protection devices	High pressure protection		2.94MPa	
	Compressor		Over current protection	
	Fan		Thermal switch	
	Inverter		Over current protection, thermal protection	
Refrigerant piping diameter		Liquid / Gas	φ 12.7 (Flare) / φ 25.4 (Brazed)	
Indoor unit	Total capacity		50 ~ 130% of outdoor unit capacity	
	Model / Quantity		Model 20 ~ 250 / 1 ~ 13	
Noise level		* dB<A>	56	
Net weight		kg	239	
Operating temperature range			Indoor:15°CWB ~ 24°CWB Outdoor:-5°CDB ~ 43°CDB (0°CDB ~ 43°CDB with outdoor unit at lower position)	Indoor:15°CDB ~ 27°CDB Outdoor:-15°CWB ~ 15.5°CWB
Matters Deserving Special Mention			A pipe of φ28.58 can be used for the gas pipe	

Note: 1.Cooling/heating capacity indicates the maximum value at operation under the following condition.

*1 <b>Cooling</b> Indoor : 27°CDB/19°CWB	Outdoor : 35°CDB	*2 <b>Cooling</b> Indoor : 27°CDB/19.5°CWB	Outdoor : 35°CDB
<b>Heating</b> Indoor : 20°CDB	Outdoor : 7°CDB/6°CWB	Pipe length : 5m	Height difference : 0m
Pipe length : 7.5m	Height difference : 0m		

\* It is measured in anechoic room.

Model name			PUHY-P250YREM-A	
			Cooling	Heating
Capacity	*1	kW	28.0	31.5
	*2	kcal/h	25,000	-
Power source			3N ~ 380/400/415V 50/60Hz	
Power input		kW	8.54	8.95
Current		A	14.4/13.6/13.2	15.1/14.3/13.8
Fan	Type X Quantity		Propeller fan X 1	
	Airflow rate	m <sup>3</sup> /min	200	
	Motor output	kW	0.38	
Compressor	Type		Hermetic	
	Motor output	kW	6.8	
	Crankcase heater	kW	0.045(240V)	
Refrigerant / Lubricant			R407C/MEL32	
External finish			Pre-coated galvanized sheets <MUNSELL 5Y8/1 or similar>	
External dimension		mm	1755(H)X990(W)X840(L)	
Protection devices	High pressure protection		2.94MPa	
	Compressor		Over current protection	
	Fan		Thermal switch	
	Inverter		Over current protection, thermal protection	
Refrigerant piping diameter		Liquid / Gas	φ 12.7 (Flare) / φ 28.58 (Brazed)	
Indoor unit	Total capacity		50 ~ 130% of outdoor unit capacity	
	Model / Quantity		Model 20 ~ 250 / 1 ~ 16	
Noise level		* dB<A>	57	
Net weight		kg	239	
Operating temperature range			Indoor:15°CWB ~ 24°CWB Outdoor:-5°CDB ~ 43°CDB (0°CDB ~ 43°CDB with outdoor unit at lower position)	Indoor:15°CDB ~ 27°CDB Outdoor:-15°CWB~15.5°CWB

Note: 1.Cooling/heating capacity indicates the maximum value at operation under the following condition.

\*1 **Cooling** Indoor : 27°CDB/19°CWB Outdoor : 35°CDB

\*2 **Cooling** Indoor : 27°CDB/19.5°CWB Outdoor : 35°CDB

**Heating** Indoor : 20°CDB Outdoor : 7°CDB/6°CWB

Pipe length : 5m

Height difference : 0m

Pipe length : 7.5m

Height difference : 0m

\* It is measured in anechoic room.

# 2. Capacity Tables

## 2-1. Correction by temperature

### Cooling

- Standard Specifications

		PUHY-P200	PUHY-P250
Capacity	kW	22.4	28.0
Input	kW	6.32	8.54

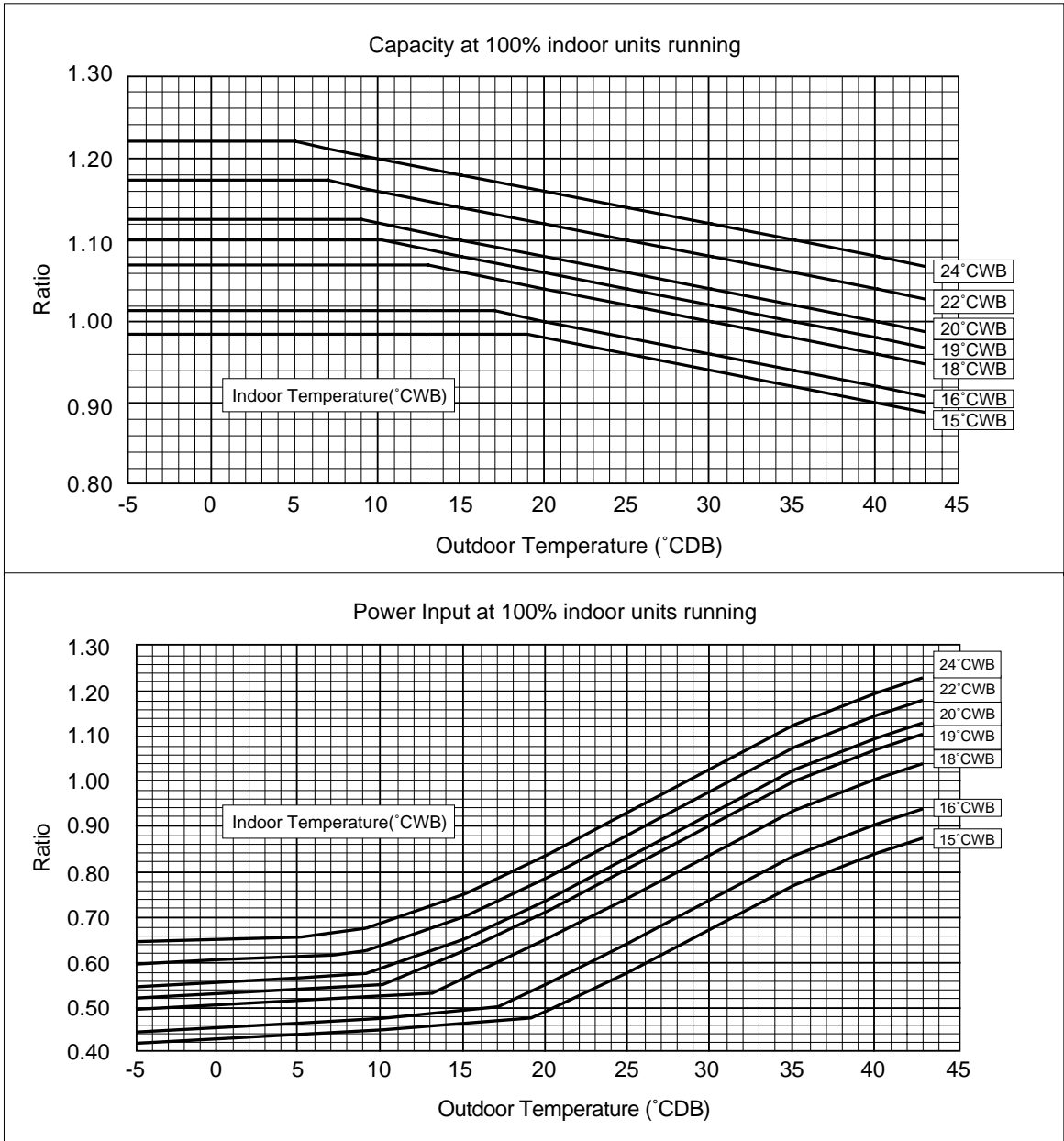

# Heating

- Standard Specifications (Outdoor 7°CDB/6°CWB Indoor 20°CDB/-)

		PUHY-P200	PUHY-P250
Capacity	kW	25.0	31.5
Input	kW	6.80	8.95

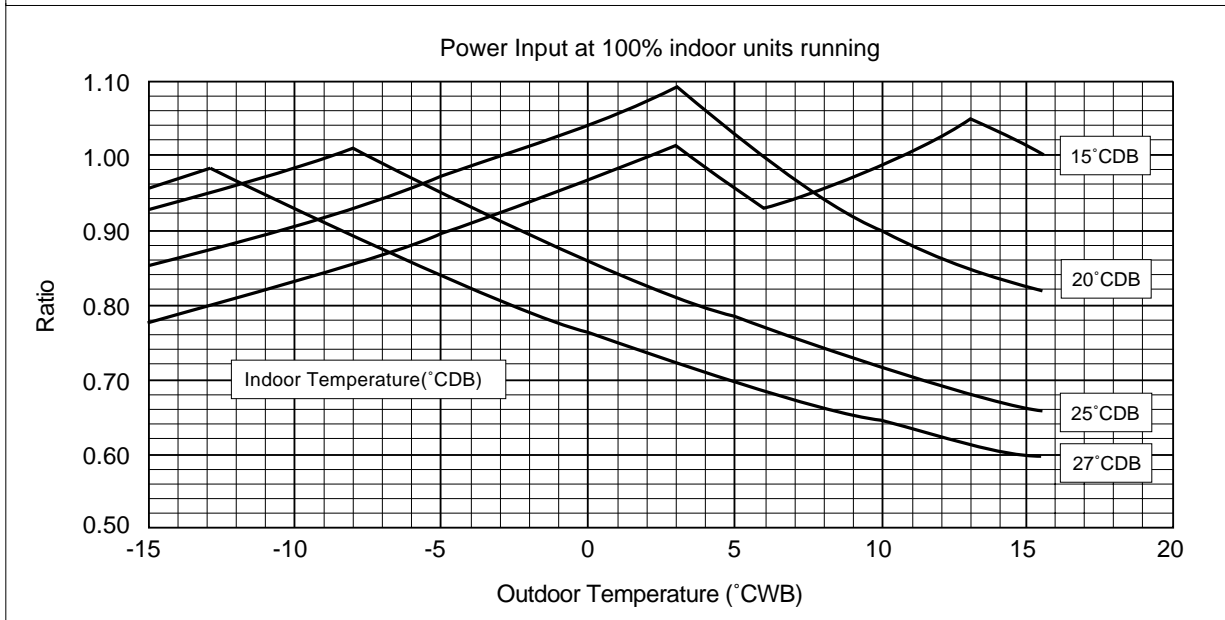
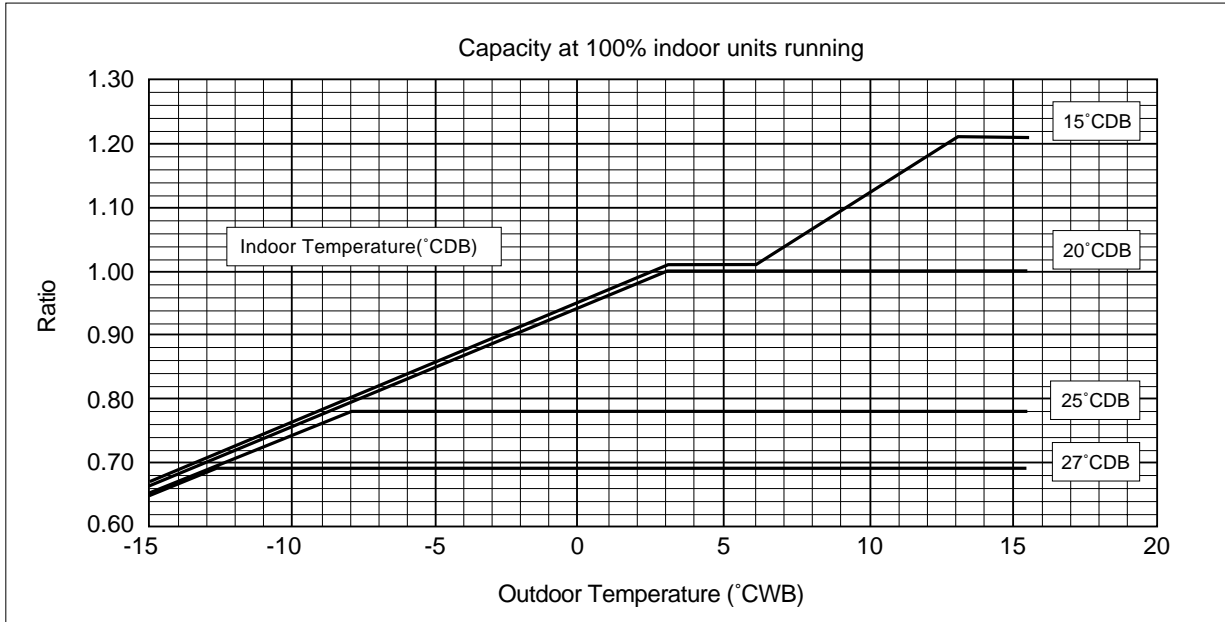

## 2-2. Correction by total indoor

### PUHY-P200

1) Capacity

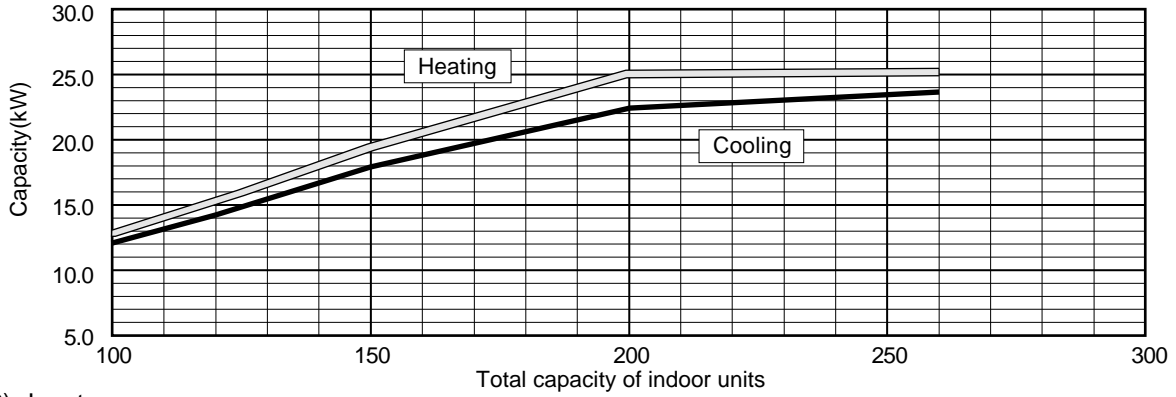

2) Input

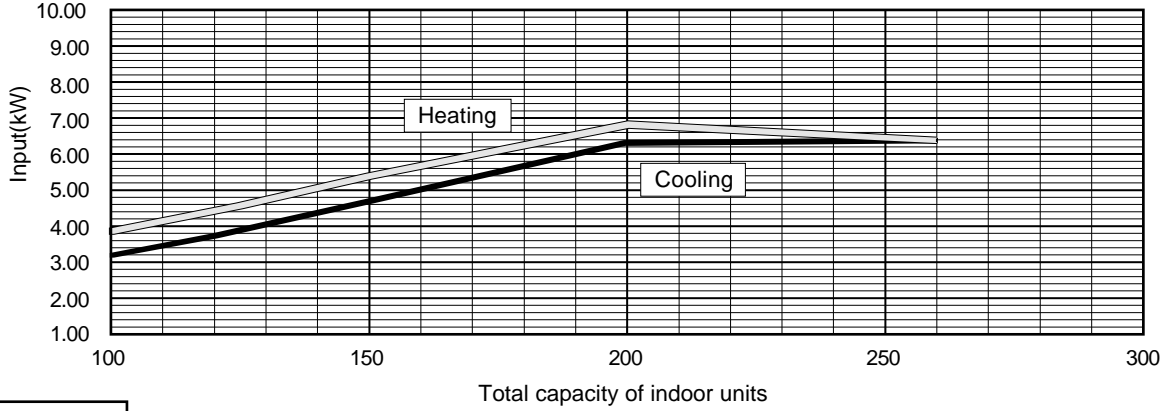

### PUHY-P250

1) Capacity

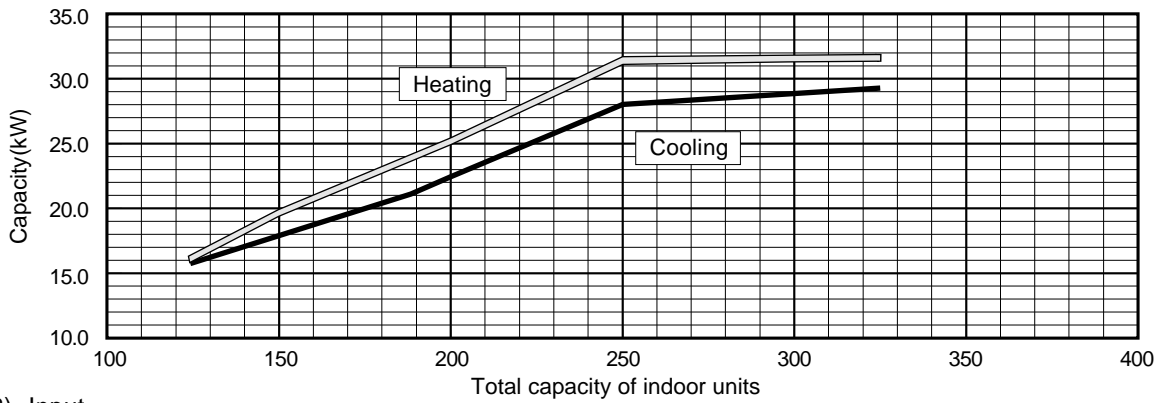

2) Input

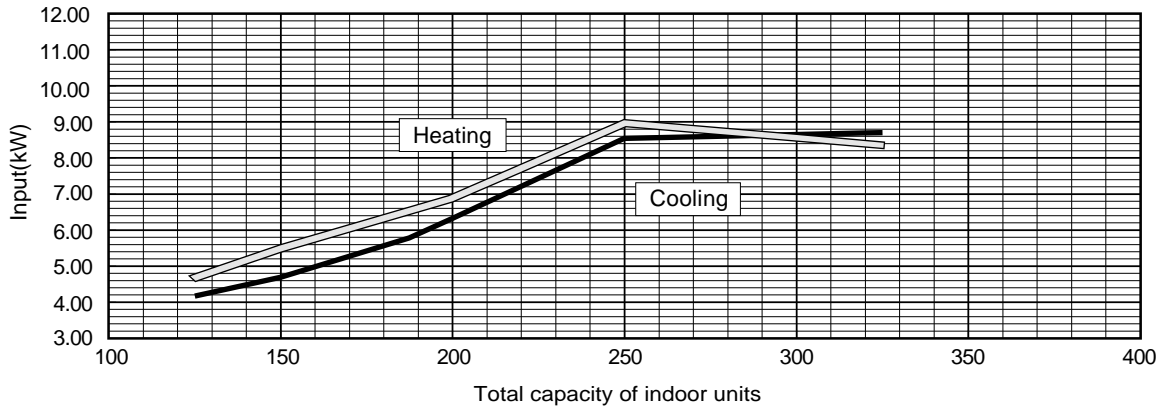



## 2-3. Correction by refrigerant piping length

To obtain a decrease in cooling/heating capacity due to refrigerant piping extension, multiply by the capacity correction factor based on the refrigerant piping equivalent length in the table below.

### • Cooling capacity correction

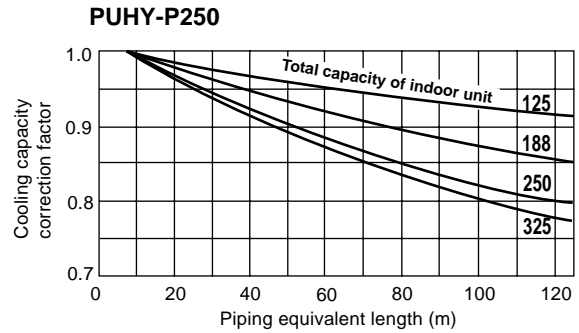
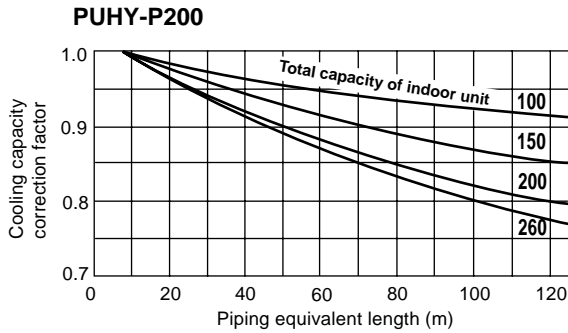

### • Heating capacity correction

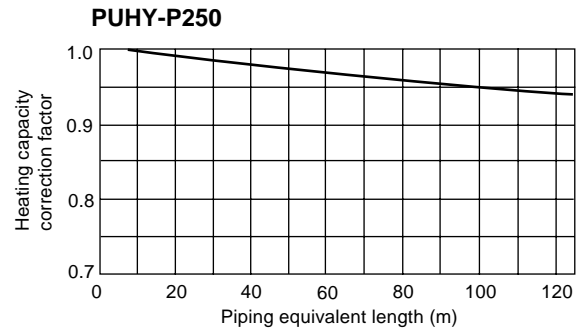
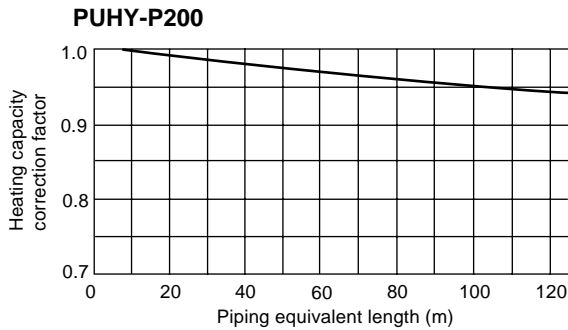

### • How to obtain piping equivalent length

#### ① PUHY-P200

Equivalent length = (Actual piping length to the farthest indoor unit) + (0.47 × number of bent on the piping)m

#### ② PUHY-P250

Equivalent length = (Actual piping length to the farthest indoor unit) + (0.50 × number of bent on the piping)m

## 2-4. Correction at frosting and defrosting

When a decrease in heating capacity due to frosted and defrosting operations is considered, the value multiplied by the correction factor in the table below represents the heating capacity.

Correction factor table

Outdoor inlet air temp (°CWB)		6	4	2	0	-2	-4	-6	-8	-10
Correction factor	PUHY-P200-250	1.0	0.95	0.84	0.83	0.87	0.9	0.95	0.95	0.95

## 2-5. Operation limit

### • Cooling

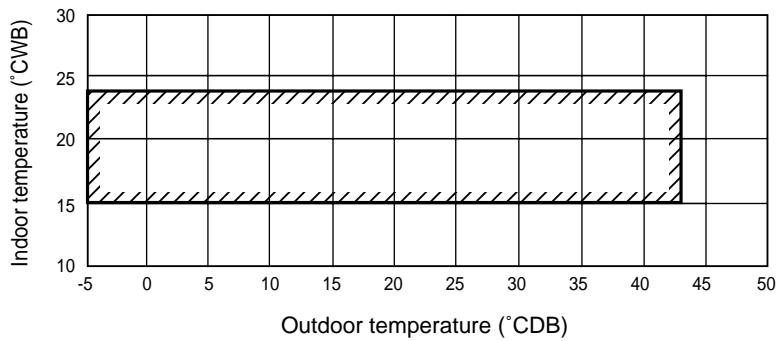

(Outdoor door temperature :  
0°CDB~43°CDB with outdoor unit  
at lower position in cooling mode.)

### • Heating

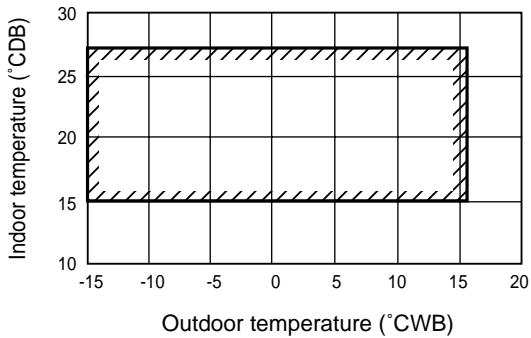

# 3. Sound Levels

## PUHY-P200

Measurement condition

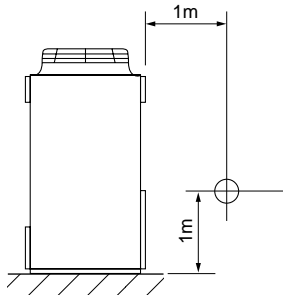

Sound pressure level in anechoic room  
56 dB (A)

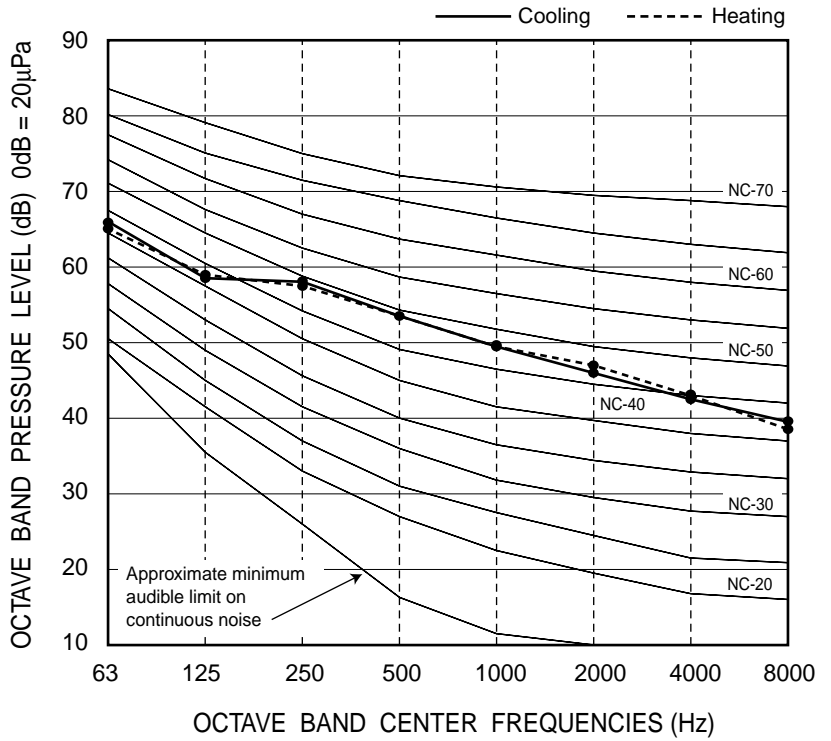

## PUHY-P250

Measurement condition

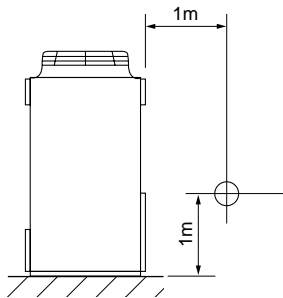

Sound pressure level in anechoic room  
57 dB (A)

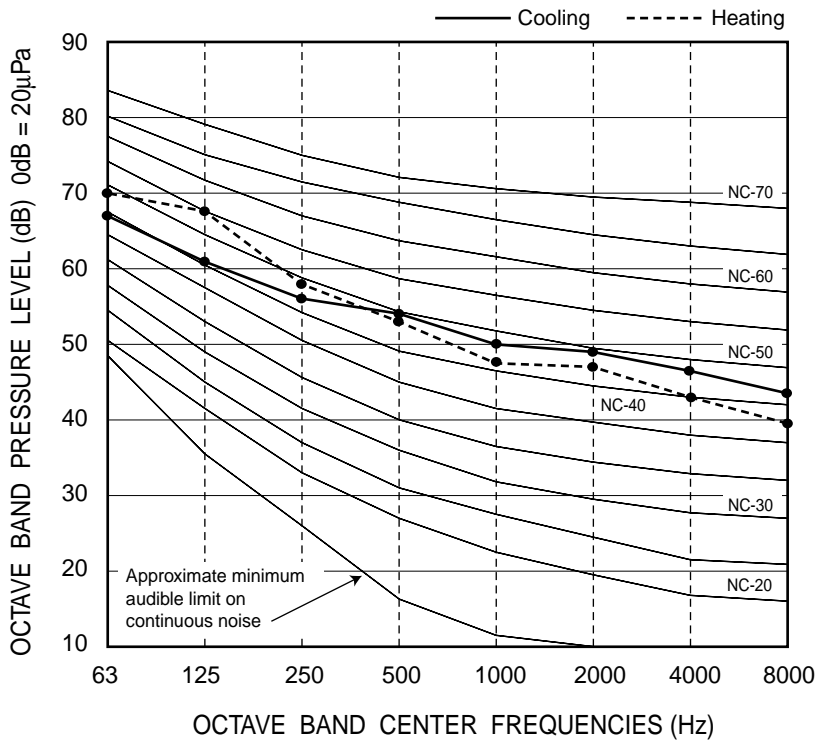

# 4. External Dimensions

## PUHY-P200,250YREM-A

Unit : mm

- <Accessory>
- Refrigerant (Gas) conn. pipe (Flange).....4pcs.
  - Ball valve (Liquid) .....1pc.
  - Ball valve (Gas) .....1pc.
  - Joint pipe .....1pc.
  - Pipe (Flare) .....1pc.
  - Packing for conn. pipe .....3pcs.
  - Bolt .....4pcs.
  - Wiring mounting board.....1pc.
  - Conduit mounting plate (Painted the same color as the unit body)  $\phi 40$ .....1pc.
  - $\phi 33$ .....1pc.
  - $\phi 27$ .....1pc.

Note 1>Please leave a space under the outdoor unit for the piping. When you connect the piping from the bottom.  
(Please be careful not to close the hole of the bottom plate by the basement)

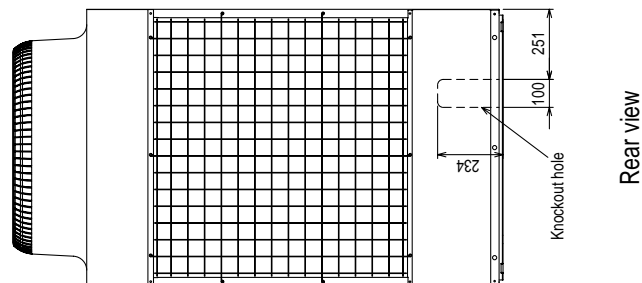
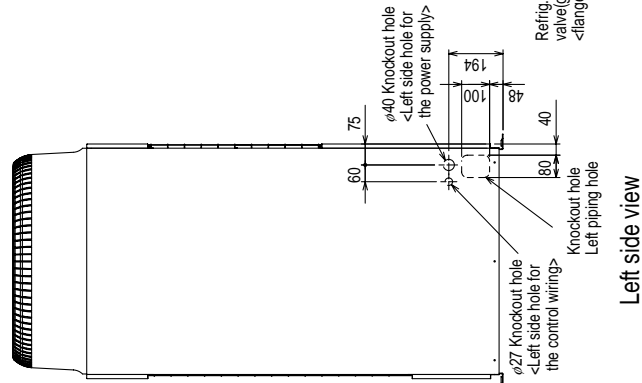
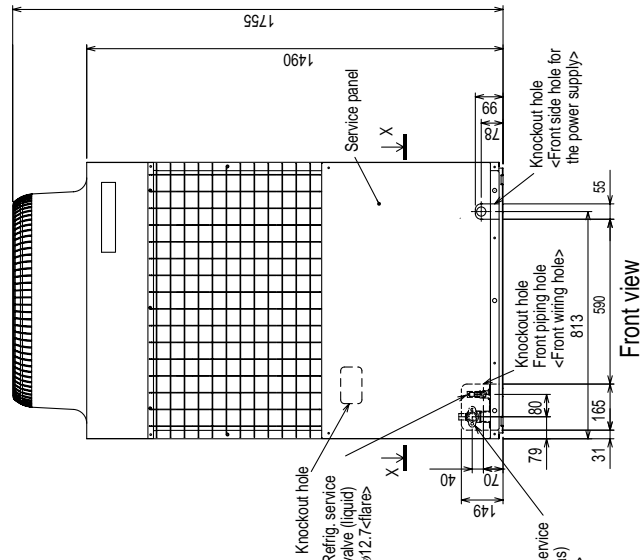
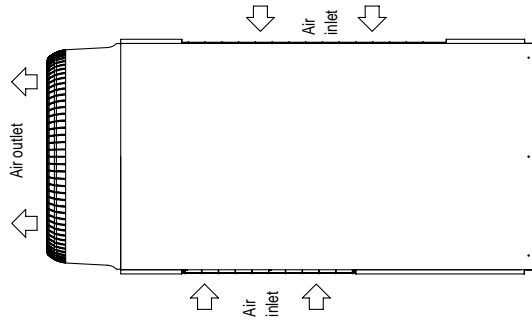
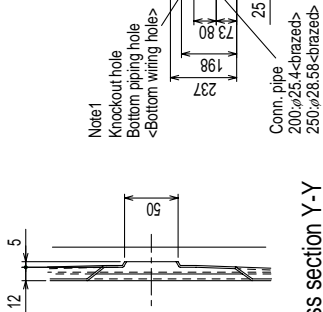
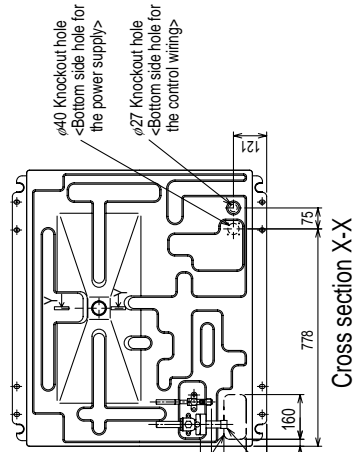
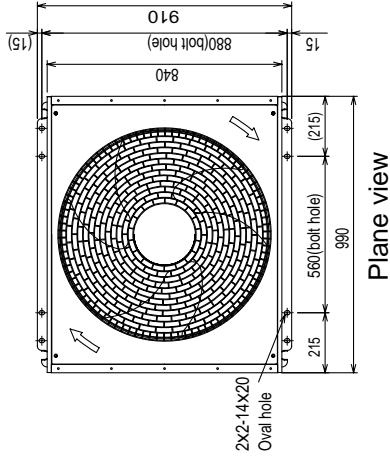

# 5. Electrical Wiring Diagram

## PUHY-P200, 250YREM-A

<ELECTRICAL WIRING DIAGRAM>

no fuse breaker	
PUHY-P200YREM-A	30A
PUHY-P250YREM-A	30A

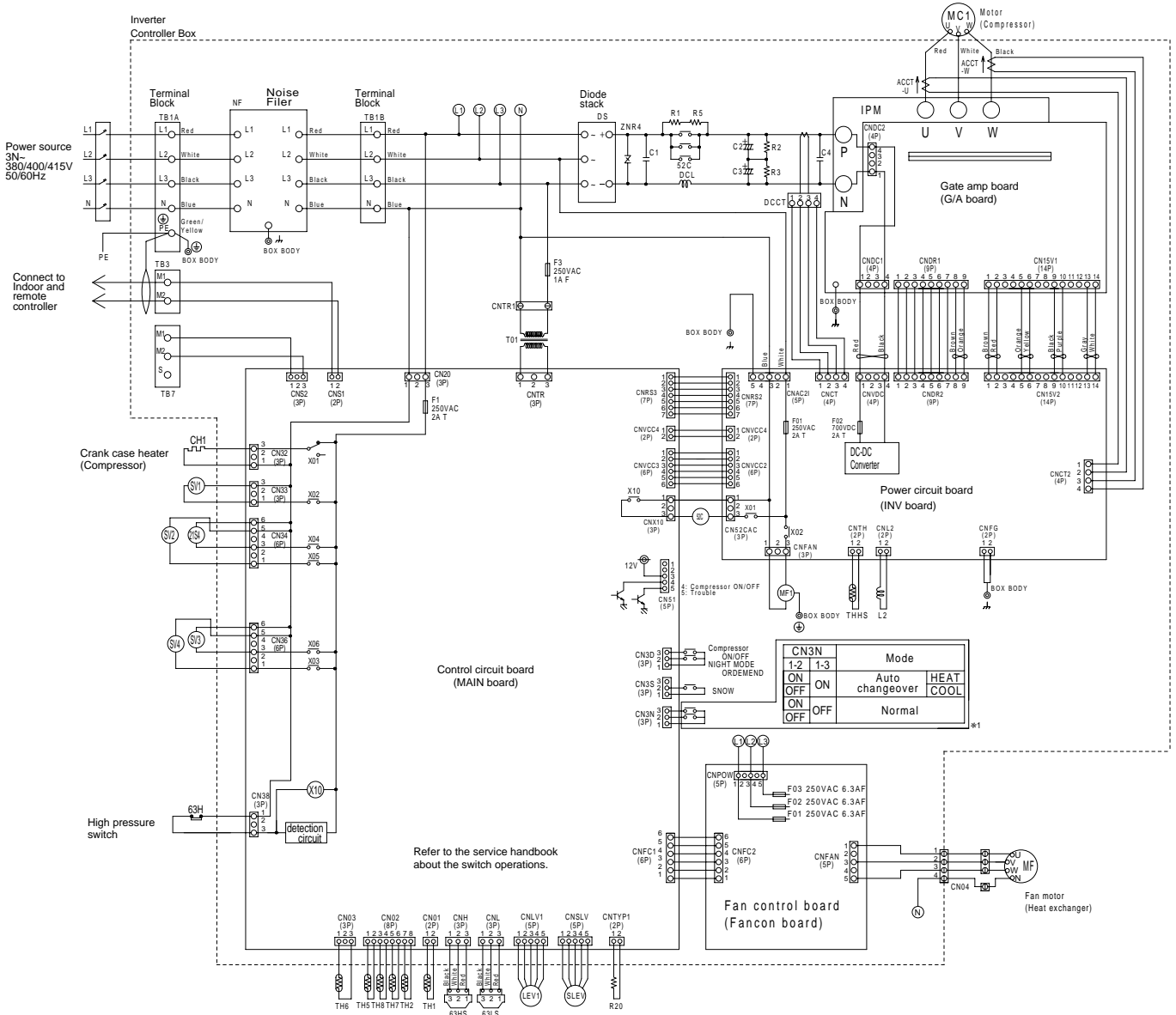

<SYMBOL EXPLANATION>

Symbol	N a m e	Symbol	N a m e	Symbol	N a m e	Symbol	N a m e
DCL	DC reactor (Power factor improvement)	SV3	Solenoid valve (Heat exchanger capacity control)	63HS	High pressure sensor	TH7	Thermistor liquid outlet temp. detect at Sub-cool coil
DCCT	Current Sensor	SV4	Solenoid valve (Heat exchanger capacity control)	63LS	Low pressure sensor	TH8	Thermistor bypass outlet temp. detect at Sub-cool coil
ACCT-U,W	Current Sensor	LEV1	Electric expansion valve (Sub-cool coil bypass)	L2	Choke coil (Transmission)	X1-10	Aux. relay
ZNR4	Varistor	SLEV	Electric expansion valve (Sub-cool coil bypass)	IPM	Intelligent power module	⊕	Earth terminal
52C	Magnetic contactor (Inverter main circuit)			TH1	Thermistor Discharge pipe temp. detect		
MF1	Fan motor (Radiator panel)			TH2	Saturation evapo. temp. detect		
21S4 *1	4-way valve			TH5	Pipe temp. detect		
SV1, SV2	Solenoid valve (Discharge-suction bypass)			TH6	OA temp. detect		

# 6. Refrigerant Circuit Diagram And Thermal Sensor

PUHY-P200, 250YREM-A

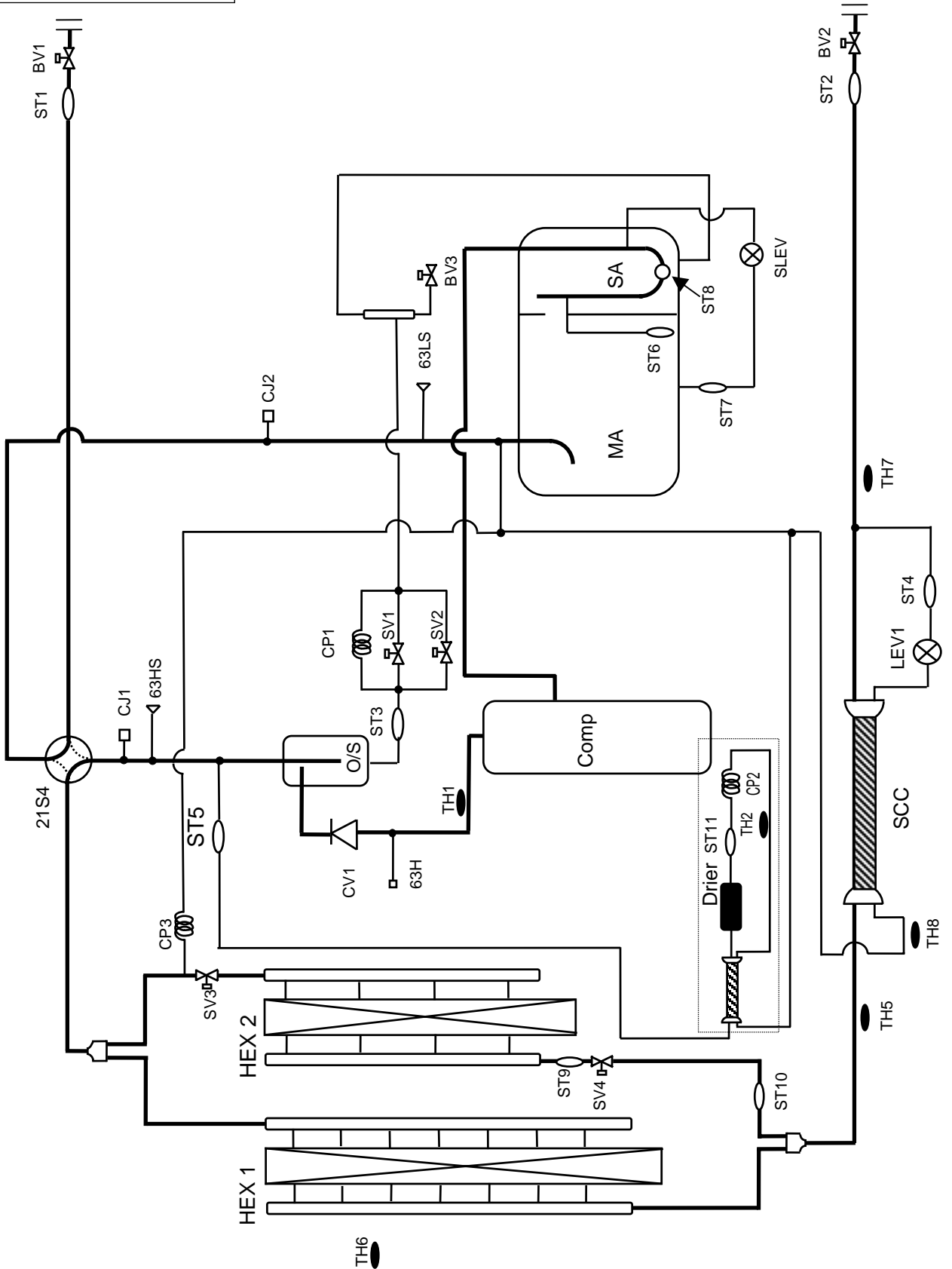

# 7. Preparations for Installing Refrigerant Piping

## 7-1. Evaluating the Adaptability of the Existing Piping

Both the checking of gas leak inside existing piping and the verification of reliability relating to piping strength belong to the scope of field work as same as in the past. Therefore, we are not liable to the quality of existing piping.

Before starting the work, it is necessary to confirm that the existing piping in question owns the rated strength (relating to the material, thickness, and corroded portions, if any).

### Points to be observed for simplified judgment to reuse existing piping

#### 1. Reusing of CITY MULTI air conditioner system

The existing piping can basically be reused if no problem was found during your use in the past. (Please check whether the trouble was caused by gas leak or it required frequent refrigerant replenishment.)

- (1) Change to same capacity → Usable as it is
- (2) Change to different capacity → Check whether the piping diameter, piping length, height difference, etc. are within our operating range.

#### 2. Reusing other makes or Mitsubishi other than CITY MULTI

- (1) Check whether the packaged air conditioner used in the past was in operational trouble or not. (Please check whether the trouble was caused by gas leak or it required frequent refrigerant replenishment.)
- (2) Confirm the type of refrigerating machine oil used by the existing facility. SUNISO, MS, HAB, Barrel Freeze, Freol are acceptable. For other refrigerating machine oil than the above, ask our factory in each case.
- (3) The branch types of T-fitting, Y-branch and header branching are acceptable. The branch pipe applied with pressure loss (like the multi-distributor of SLIM) can not be used. Replacement with new branch pipe is required in this case. Estimate the branch configuration and piping size depending on the maker name, model name and connecting quantity of existing products.
- (4) Confirm that the piping diameter, piping length, height difference, etc. are within our operating range.

#### Item, index of judgment for reusing of existing piping

Items	Judgment standard	Indirect material for judgment
Piping diameter, length	Refer to Items 7-2 ~ 4	None
Type of refrigerating machine oil	SUNISO, MS, HAB, Barrel Freeze, Freol	Maker, type (model name), year of manufacturing
Air tightness	No pressure drop by leaving for one day after pressurizing to 2.98Mpa	Operability of previous unit
Distributor configuration	T-fitting, Y-fitting, Header branching	Maker, type (model name), year of manufacturing
Thermal insulation	No peeling off of thermal insulation and caulking	None
Piping system	Unit height difference should be within the standard of typical unit	None
Pipe thickness	Pipe thickness equivalent to the standard of each country	

## Evaluating the Adaptability of the Existing Piping (Flow)

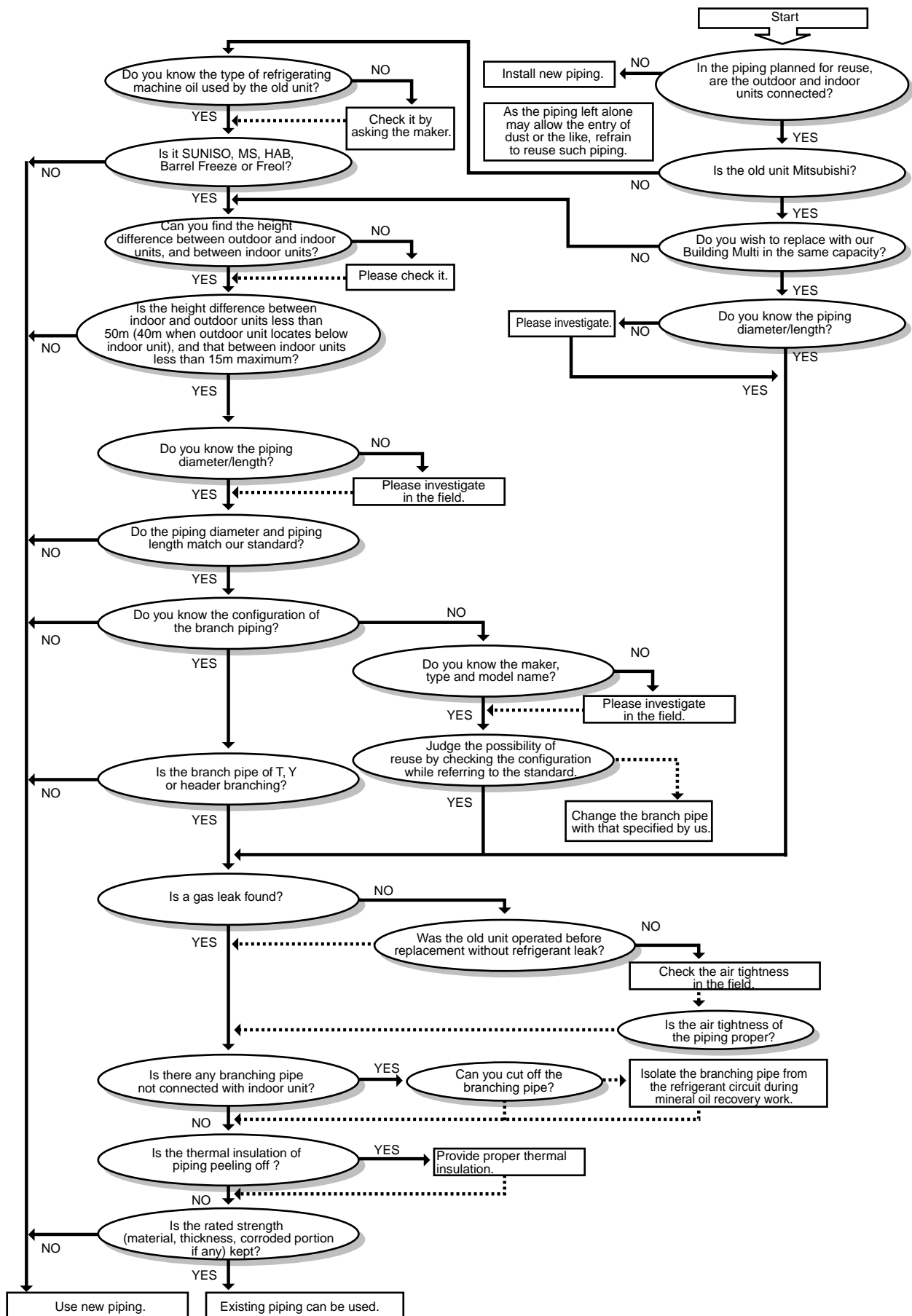



## 7-2. Pipe Length Specification

PUHY-P200-250

(1) In the case of replacing units using branch-pipe method

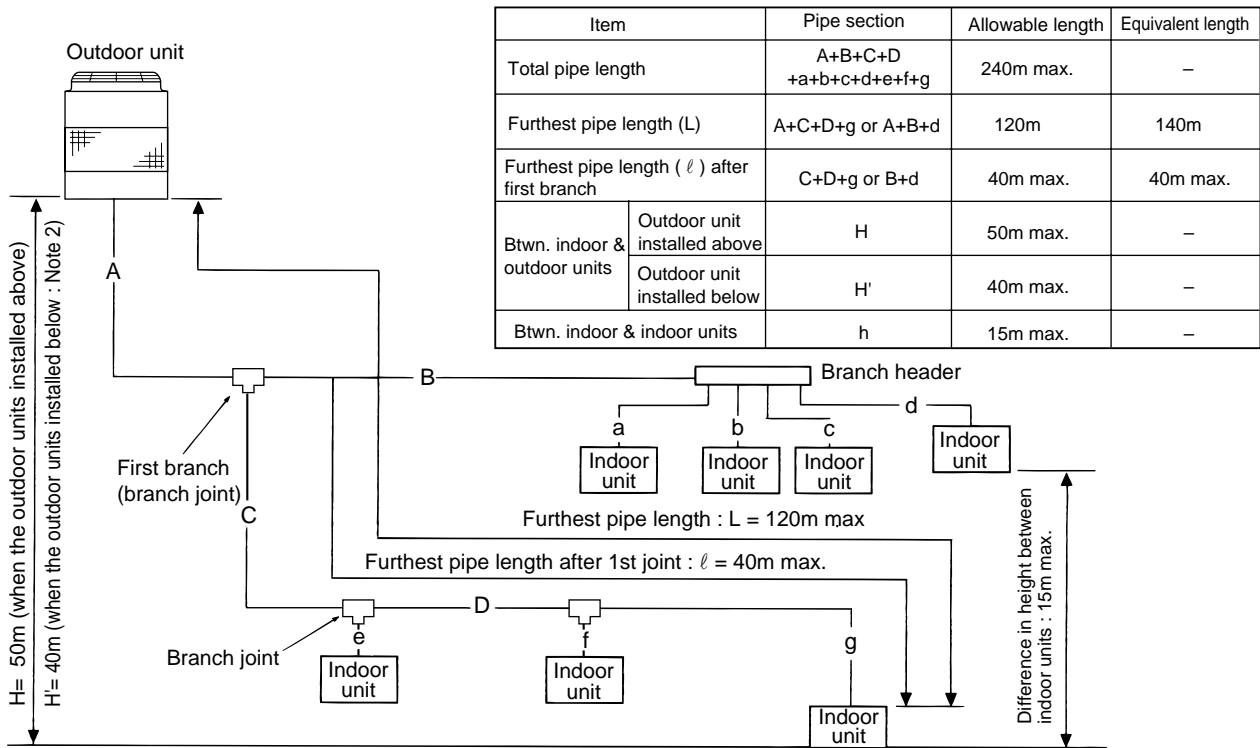

- Notes:
- No further branching in the pipes is possible after the header branch.
  - When cooling operation is performed when the outdoor temp. is 0°C or lower : H'= 4m or less.
  - Equivalent pipe length (m) : Actual pipe length +  $\frac{\text{model 200} : 0.47}{\text{model 250} : 0.50} \times \text{number of bent.}$

(2) In the case of replacing a typical split system

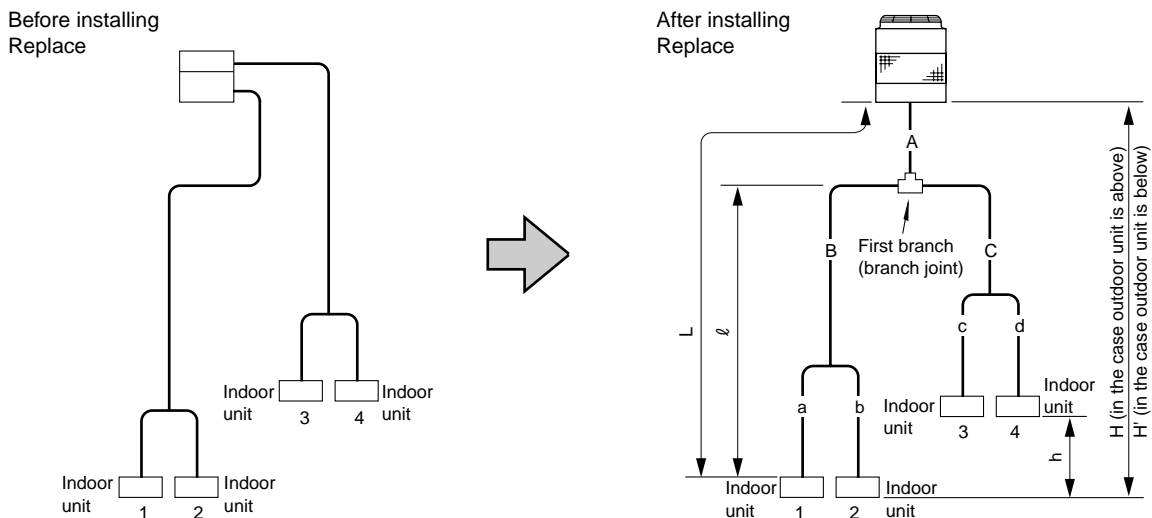

Item		Pipe section	Allowable length
Pipe length	Farthest pipe length	A + C + d or A + B + b	70 m max (equivalent length 85 m max.)
	Farthest pipe length after first branch (ℓ)	B + b or C + d	60m max
Height difference	Btwn. indoor & outdoor units	Outdoor unit installed above	H
		Outdoor unit installed below	H'
	Betw. indoor & indoor units	h	15 m max

## 7-3. Selecting Refrigerant Piping

PUHY-P200-250

(1) In the case of replacing units using branch-pipe method

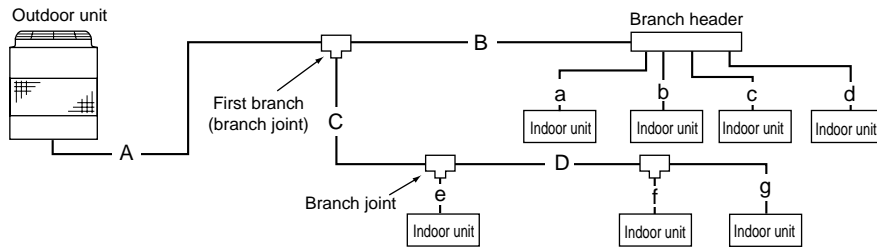

(2) In the case of replacing a typical split system

Before installing  
Replace

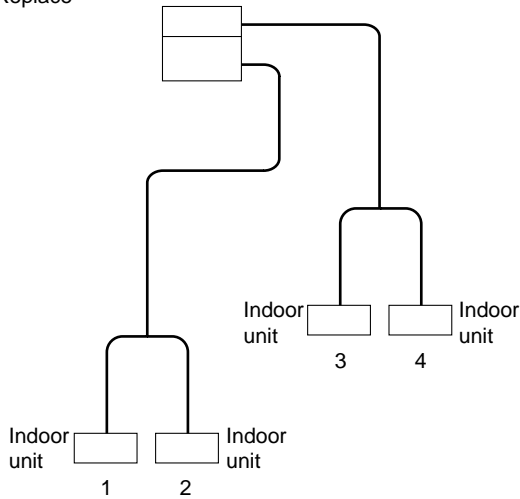

After installing  
Replace

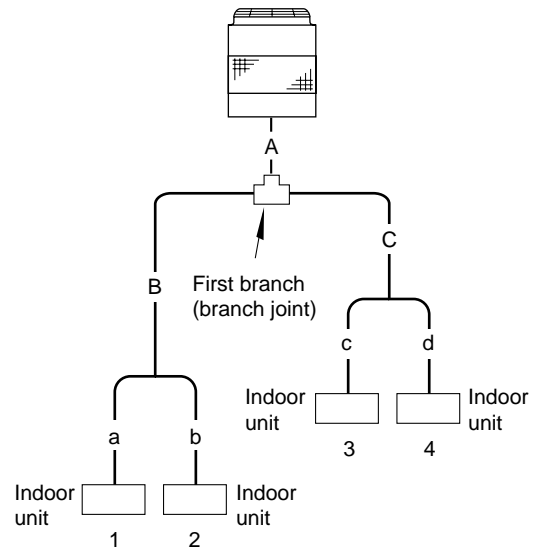

- Note :
- No further branching is possible after the header branch.
  - Arrange the total capacity of the indoor units less than 330, connected on the downstream side by the header branch. If over that, branch pipes on the upstream side using the branch joint.
  - Model 200 and 250 can not be connected with header branch.

### (1) Outdoor unit - 1st branch (Pipe A)

Outdoor unit model	Liquid pipe	Gas pipe
PUHY-P200	φ 12.7 X 0.8t	*1 φ 25.4 X 1.3t
PUHY-P250	φ 12.7 X 0.8t	φ 28.58 X 1.45t

\*1 The pipe of 28.58mm can be used for the gas pipe of PUHY-P200.

### (2) Branch joint / Header

Type of branch pipe	Total capacity of indoor units	Branch pipe model
Joint	~ 160	CMY-Y102S-F
	161 ~ 330	CMY-Y102L-F
Header	For 4 branches	CMY-Y104-F
	For 7 branches	CMY-Y107-F
	For 10 branches	CMY-Y1010-F

### (3) Branch - Branch (Pipe B,C,D)

Total capacity of indoor units	Liquid pipe	Gas pipe
~ 80	φ 9.52 X 0.8t	φ 15.88 X 1.0t
81 ~ 160	φ 12.7 X 0.8t	φ 19.05 X 1.0t
161 ~	φ 12.7 X 0.8t	** φ 25.4 X 1.3t

\*\* The pipe of 28.58mm can be used for the gas pipe of PUHY-P200.

※ The thickness of pipe is Japanese Standard.

Please choose the thickness according to your country standard referring to above chart.

### (4) Branch - Indoor unit (Pipe a, b, c, d, e, f, g)

Indoor unit model	Liquid pipe	Gas pipe
20,25,32,40	φ 6.35 X 0.8t	φ 12.7 X 0.8t
50,63,71,80	φ 9.52 X 0.8t	φ 15.88 X 1.0t
100,125,140	φ 9.52 X 0.8t	φ 19.05 X 1.0t
200	φ 12.7 X 0.8t	φ 25.4 X 1.3t
250	φ 12.7 X 0.8t	φ 28.58 X 1.3t

• Indoor unit capacities

The capacity of an indoor unit is the same as the number used for its type identification.

Examples:

PEFY-P63VM → Capacity = 63

## 7-4. Connecting Refrigerant Pipes with Different Diameters

### (1) List of possibility to connect deformed piping (Chart)

#### ① Outdoor–First branch [section A]

Table-1

		P200	P250
Gas pipe	φ 15.88	X	X
	φ 19.05	X	X
	φ 22.2	●	X
	φ 25.4	◎	●
	φ 28.58	*	◎
	φ 31.75	X	X
	φ 38.1	X	X
Liquid pipe	φ 9.52	X	X
	φ 12.7	◎	◎
	φ 15.88	△	△
	φ 19.05	X	X
	φ 22.2	X	X

- ◎ : Normal piping
- : Usable (without performance deterioration)
- : Usable (without performance deterioration: Refer to DATABOOK)
- △ : Usable (with rule on refrigerant charge: Refer to the formula to judge refrigerant charge on the next page)
- ▲ : Usable (with limitation on piping length)
- ◆ : Possible for liquid piping of φ 9.52
- X : Not connectable
- \* : Limitation on mineral oil recovery work process

#### ② Branch–indoor [a-f sections]

Table-2 List of possibility to connect indoor unit/deformed piping

		P20	P25	P32	P40	P50	P63	P71	P80	P100	P125	P140	P200	P250
Gas pipe	φ 12.7	◎	◎	◎	◎	●	●	X	X	X	X	X	X	X
	φ 15.88	X	X	X	◆	◎	◎	◎	◎	●	●	●	X	X
	φ 19.05	X	X	X	X	X	○	○	○	◎	◎	◎	X	X
	φ 22.2	X	X	X	X	X	X	X	*	*	*	○	●	X
	φ 25.4	X	X	X	X	X	X	X	X	X	*	*	◎	●
	φ 28.58	X	X	X	X	X	X	X	X	X	X	X	○	◎
	φ 31.75	X	X	X	X	X	X	X	X	X	X	X	X	X
Liquid pipe	φ 6.35	◎	◎	◎	◎	▲ (within 25m)	▲ (within 15m)	X	X	X	X	X	X	X
	φ 9.52	△	△	△	△	◎	◎	◎	◎	◎	◎	◎	X	X
	φ 12.7	△	△	△	△	△	△	△	△	△	△	△	◎	◎
	φ 15.88	△	△	△	△	△	△	△	△	△	△	△	△	△
	φ 19.05	X	X	X	X	X	X	X	X	X	X	X	X	X

#### Formula to judge refrigerant charge:

For the case marked △, it is necessary to take measures to reduce the piping length slightly, to raise the indoor model size or reduce the number of connected indoor units.

$$M = 0.3 \times L1 + 0.2 \times L2 + 0.12 \times L3 + 0.06 \times L4 + 0.024 \times L5 < 17.4$$

L1 : Piping length (m) of φ 19.05mm

L4 : Piping length (m) of φ 9.52mm

L2 : Piping length (m) of φ 15.88mm

L5 : Piping length (m) of φ 6.35mm

L3 : Piping length (m) of φ 12.7mm

### (2) Cooling or heating capacity when connecting the indoor unit using pipes with different diameters

#### Capacity correction with one-size smaller gas pipes.

Refer to “I”, when using pipes (gas pipe) that are one-size smaller only for branch pipes or branch pipes as well as main pipes.  
Refer to “II”, when using pipes (gas pipe) that are one-size smaller only for the main pipes.

#### I Capacity correction with one-size smaller branch pipes

With the indoor unit (P50, 63, 100, 125, 140, 200, 250), the capacity will reduce using one size smaller branch pipes.  
(Refrigerant pipe length capacity correction on the list of connecting pipes with different diameters is shown with ● marks.)

### (1) Pipes diameter correction coefficient of Outdoor unit (PUHY-P200YREM-A)

(1) Refrigerant pipe length capacity correction with P50, 63-type indoor unit with the  $\phi 12.7\text{mm}$  branch pipe on the gas pipe side

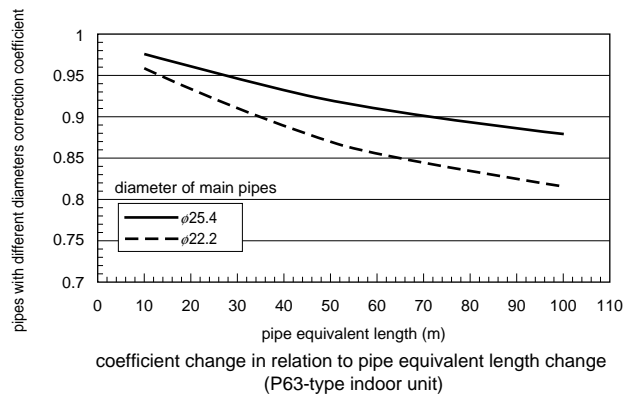
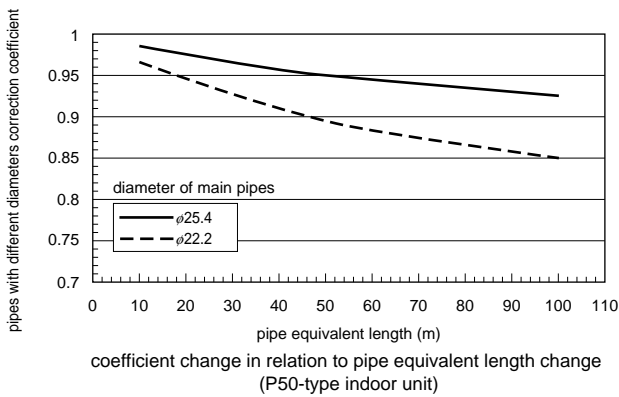

(2) Refrigerant pipe length capacity correction with P100, 125, 140-type indoor unit with the  $\phi 15.88\text{mm}$  branch pipe on the gas pipe side

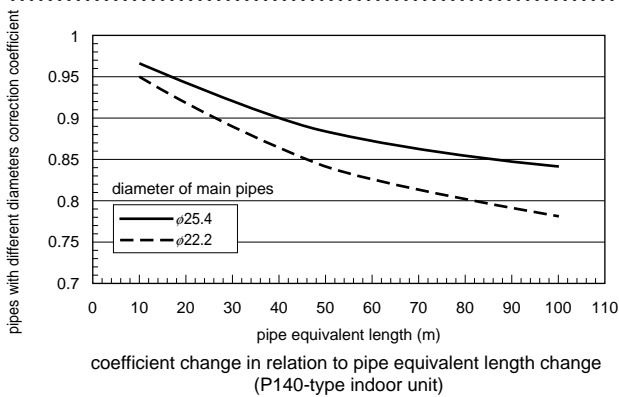
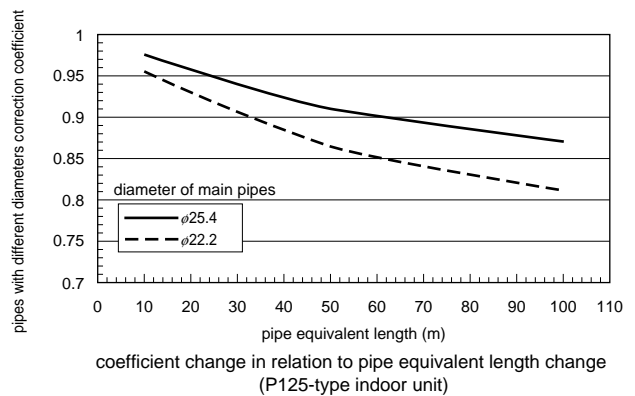
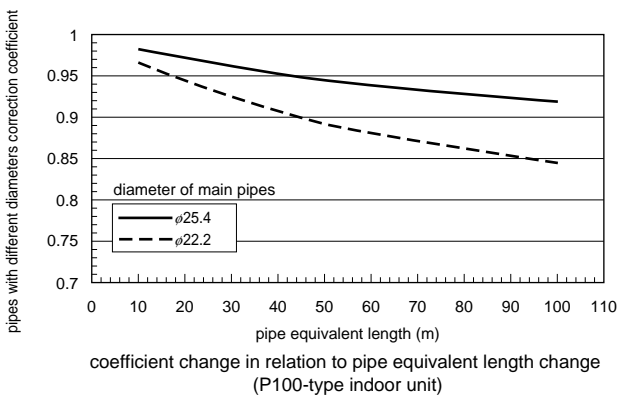

(3) Refrigerant pipe length capacity correction with the indoor unit on P200 with the  $\phi 22.2\text{mm}$  branch pipe on the gas pipe side

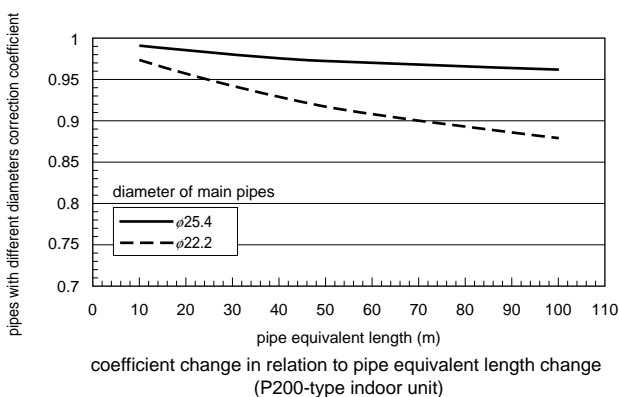

## (2) Pipes diameter correction coefficient of Outdoor unit (PUHY-P250YREM-A)

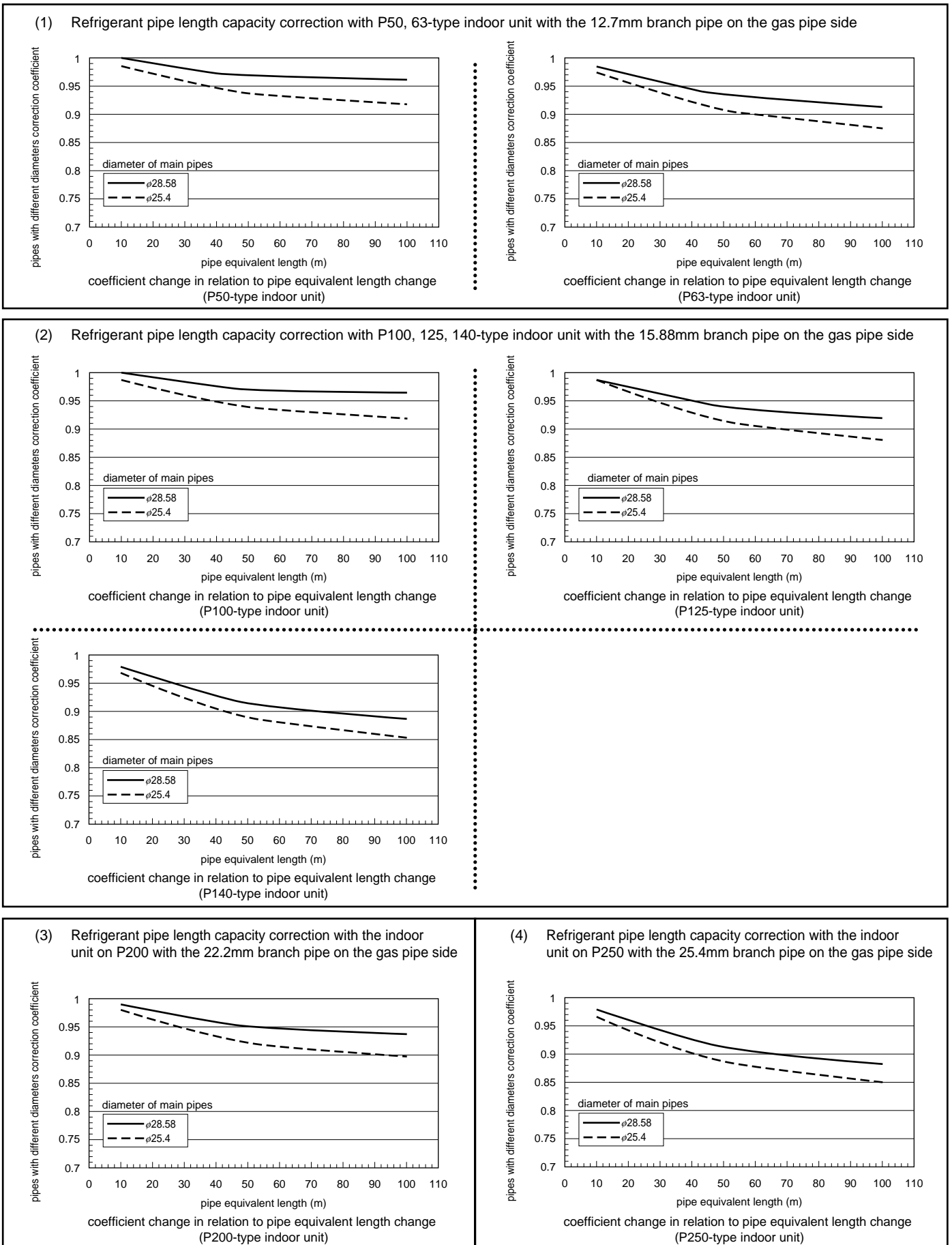

## II. Capacity correction using one-size smaller main pipes

With the outdoor units (P200, 250), capacity will deteriorate using one-size smaller main pipes. (with regular branch pipes)

Therefore, it might be necessary to correct system standard capacity using "pipes with different diameters correction coefficient" except for the units listed below. (P50, 63, 100, 125, 140, 200, 250 with regular gas pipes)

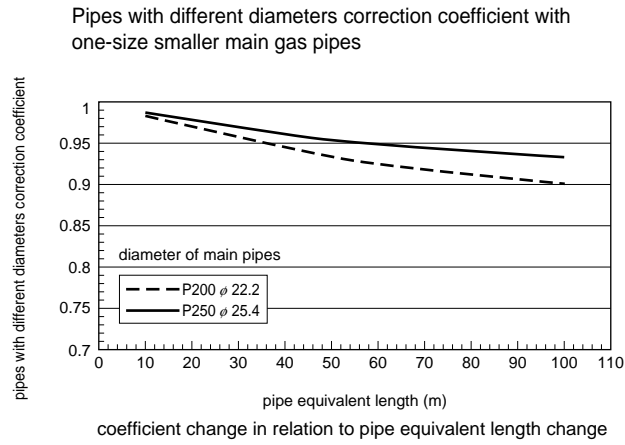

## 7-5. Calculating the Amount of Additional Refrigerant to Charge

### (1) Refrigerant charge

The following amount of refrigerant is being charged into the outdoor unit at factory shipment. As the amount does not include that for extended piping, charge it additionally in the field.

Outdoor unit	PUHY-P200	PUHY-P250
Refrigerant charge	13.0kg	13.0kg

### (2) Formula to obtain an amount of additional refrigerant charge

The additional amount of refrigerant to be added is calculated from the size of the extended liquid pipes and their length (in meters).

$$\text{Additional amount (kg)} = (0.25 \times L_1) + (0.12 \times L_2) + (0.06 \times L_3) + (0.024 \times L_4) - A$$

Where L1 : Length of  $\phi 15.88$  liquid pipe (m)  
 L2 : Length of  $\phi 12.7$  liquid pipe (m)  
 L3 : Length of  $\phi 9.52$  liquid pipe (m)  
 L4 : Length of  $\phi 6.35$  liquid pipe (m)  
 A: Additional refrigerant charge by total capacity of indoor units connected.

Type of Outdoor unit	Additional refrigerant charge (A)
P200, P250	2.0

\*1 : Any fractions below 0.01kg in the result of the calculation should be round up.  
 (Examples : 10.52  $\rightarrow$  10.6kg)

#### Example: PUHY-P200

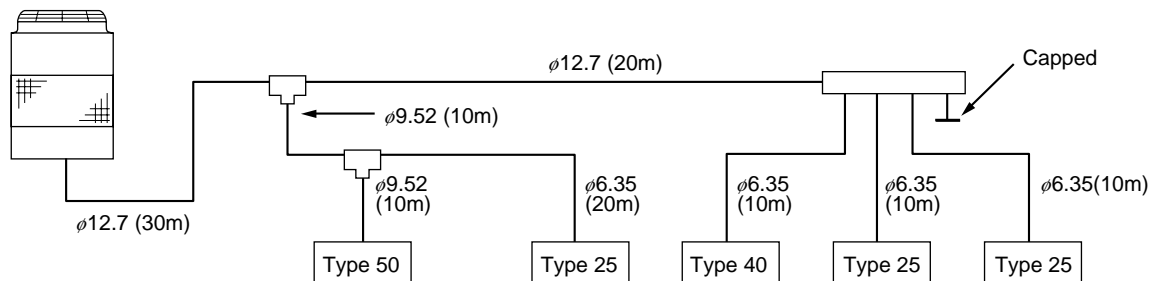

This calculation concerns only the liquid pipes.

$$\begin{aligned} \phi 12.7 &: 30\text{m} + 20\text{m} = 50\text{m} \\ \phi 9.52 &: 10\text{m} + 10\text{m} = 20\text{m} \\ \phi 6.35 &: 20\text{m} + 10\text{m} + 10\text{m} + 10\text{m} = 50\text{m} \end{aligned}$$

Total capacity of indoor units connected:  
 $40 + 25 + 40 + 25 + 25 = 155$

Calculation of additional amount :

$$\text{Additional amount (kg)} = (0.12 \times 50) + (0.06 \times 20) + (0.024 \times 50) - 2.0 = 6.40 \text{ kg}$$

The result of 6.40 kg is rounded up to one decimal place (0.1kg). Therefore,

$$\text{Additional amount} = 6.4 \text{ kg}$$

\* When the result of calculation of additional filling amount is rounded up under 0.5 kg, additional refrigerant amount is 0.5 kg.

## 7-6. Important Notes on Refrigerant Piping Connecting Valves

### (1) Before mineral oil recovery

- Conduct piping connection and valve operation accurately.
- The liquid-side connection pipe 3 is supplied with the outdoor unit.
  - ① Braze the ball valve on the liquid side.
  - ② Fit the cap and flare nut to isolate the refrigerant circuit.
- The gas-side connecting pipes 1,2,4 are supplied with the outdoor unit.

#### Connecting to the indoor unit side

- ① For brazing to the connecting pipe with flange, remove the connecting pipe with flange from the ball valve, and braze it.
- ② If the pipe diameter of the existing onsite piping is  $\phi 25.4\text{mm}$ , make a brazed connection using connecting pipe 2.
- ③ At the mounting of the hollow packing, wipe off dust attached on the flange sheet surface and the packing. Coat refrigerating machine oil (Ester oil, ether oil or alkyl benzene [small amount]) onto both surfaces of the packing.)

#### Connecting to the oil trap kit side

- ① Braze the ball valve on the gas side.
  - ② Insert the packing, consisting of rubber bushing with membrane, and fit the connecting pipe with flange to isolate the refrigerant circuit.
- When the valve is open, it obstructs the mineral oil recovery operation so this valve must be in the closed position.
  - Determine the amount of additional refrigerant charge by using the formula, and charge refrigerant additionally through the service port after completing piping connection work.
  - Refer to “(2) After mineral oil recovery” for the required tightening torque.
  - Conduct piping connection and valve operation accurately.
  - The gas side connecting pipe is assembled in factory before shipment.
    - ① For brazing to the connecting pipe with flange, remove the connecting pipe with flange from the ball valve, and braze it outside of the unit.
    - ② During the time when removing the connecting pipe with flange, remove the seal attached on the rear side of this sheet and paste it onto the flange surface of the ball valve to prevent the entry of dust into the valve.
    - ③ The refrigerant circuit is closed with a round, close-packed packing upon shipment to prevent gas leak between flanges. As no operation can be done under this state, be sure to replace the packing with the hollow packing attached at the piping connection.
    - ④ At the mounting of the hollow packing, wipe off dust attached on the flange sheet surface and the packing. Coat refrigerating machine oil (Ester oil, ether oil or alkylbenzene [small amount]) onto both surfaces of the packing.

<A> [Ball valve (gas side)]  
(This figure shows the valve in the close state.)

<B> [Ball valve (liquid side)]  
(This figure shows the valve in the close state.)

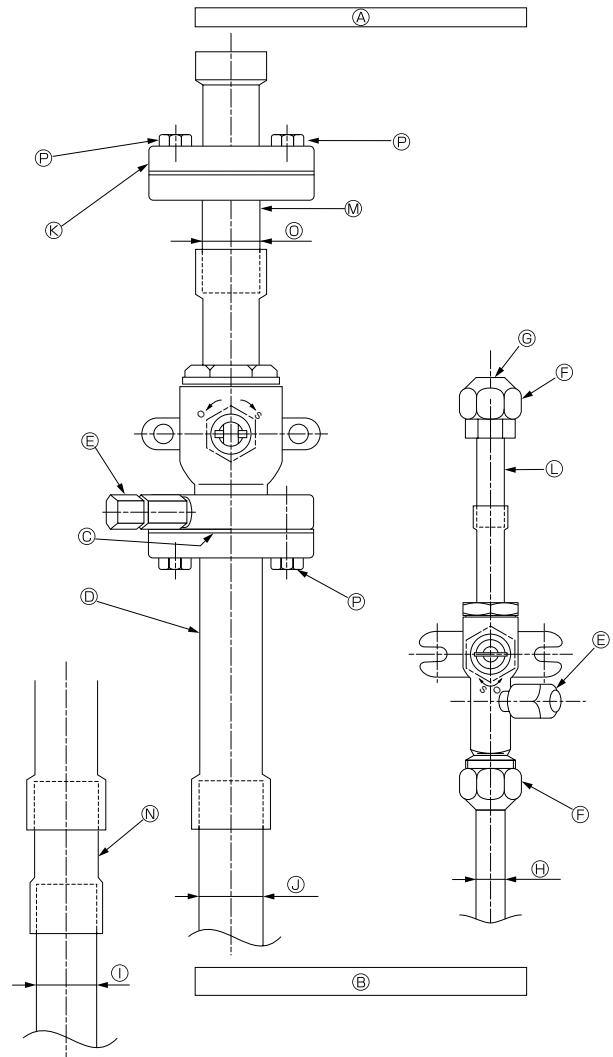

- |                                  |                                     |
|----------------------------------|-------------------------------------|
| Ⓐ :To oil trap kit               | ① : $\phi 25.4$ (PUHY-P200)         |
| Ⓑ :To indoor unit                | Ⓙ : $\phi 28.58$ (PUHY-P250)        |
| Ⓒ :Hollow Packing (Accessory)    | Ⓚ :Close-packed packing (Accessory) |
| Ⓓ :Connecting pipe 1 (Accessory) | Ⓛ :Connecting pipe 3 (Accessory)    |
| Ⓔ :Service port                  | Ⓜ :Connecting pipe 4 (Accessory)    |
| Ⓕ :Flare nut (Accessory)         | Ⓝ :Connecting pipe 2 (Accessory)    |
| Ⓖ :Cap (Accessory)               | Ⓞ : $\phi 25.4$                     |
| Ⓗ : $\phi 12.7$                  | Ⓟ :Bolt M10 (Accessory)             |



## (2) After mineral oil recovery

- After evacuation and refrigerant charge, ensure that the handle is fully open. If operating with the valve closed, abnormal pressure will be imparted to the high- or low-pressure side of the refrigerant circuit, giving damage to the compressor, four-way valve, etc.
- Determine the amount of additional refrigerant charge by using the formula, and charge refrigerant additionally through the service port after completing piping connection work.
- After completing work, tighten the service port and cap securely not to generate gas leak.

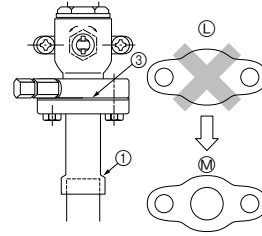

<A> [Ball valve (gas side)] (This figure shows the valve in the fully open state.)

<B> [Ball valve (liquid side)]

Ⓐ Valve stem

[Fully closed at the factory, when connecting the piping, when evacuating, and when charging additional refrigerant. Open fully after the operations above are completed.]

Ⓑ Stopper pin [Prevents the valve stem from turning 90° or more.]

Ⓒ Packing (Accessory)

[Manufacturer: Nichiasu corporation]

[Type: T/#1991-NF]

Ⓓ Connecting pipe (Accessory)

[Use packing and securely install this pipe to the valve flange so that gas leakage will not occur. (Tightening torque: 25 N·m) Coat both surfaces of the packing with refrigerating machine oil. (Ester oil, ether oil or alkylbenzene [small amount])]

Ⓔ Open (Operate slowly)

Ⓕ Cap, copper packing

[Remove the cap and operate the valve stem. Always reinstall the cap after operation is completed. (Valve stem cap tightening torque: 25 N·m or more)]

Ⓖ Service port

[Use this port to evacuate the refrigerant piping and add an additional charge at the site.]

Open and close the port using a double-ended wrench.

Always reinstall the cap after operation is completed.

(Service port cap tightening torque: 14 N·m or more)]

Ⓗ Flare nut

[Tightening torque: 55 N·m]

Loosen and tighten this nut using a double-ended wrench.

Coat the flare contact surface with refrigerating machine oil (Ester oil, ether oil or alkylbenzene [small amount])]

Ⓛ ⌀ 12.7

Ⓜ ⌀ 25.4 (PUHY-P200)

⌀ 28.58 (PUHY-P250)

Ⓚ Field piping

[Braze to the connecting pipe. (When brazing, use unoxidized brazing.)]

Ⓛ Close-packed packing

Ⓜ Hollow packing

<A> [Ball valve (gas side)]  
(This figure shows the valve  
in the fully open state.)

<B> [Ball valve (liquid side)]

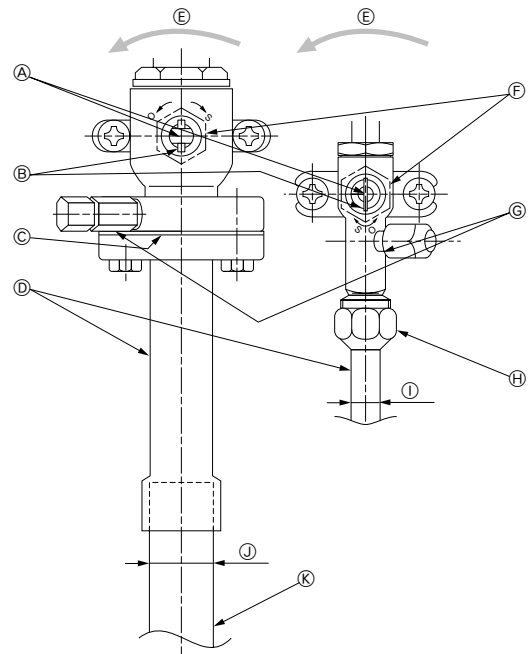

Ⓐ Valve stem

Ⓑ Stopper pin

Ⓒ Packing (Accessory)

Ⓓ Connecting pipe (Accessory)

Ⓔ Open (Operate slowly)

Ⓕ Cap, copper packing

Ⓖ Service port

Ⓗ Flare nut

Ⓛ 12.7

Ⓜ ⌀ 25.4 (PUHY-P200)

⌀ 28.58 (PUHY-P250)

Ⓚ Field piping

Ⓛ Close-packed packing

Ⓜ Hollow packing

### ⚠ Caution:

**Do not operate the valve before mineral oil collection running. Operating the valve before mineral oil collection running may cause deterioration of mineral oil collection capacity.**



HEAD OFFICE: MITSUBISHI DENKI BLDG., 2-2-3, MARUNOUCHI, CHIYODA-KU, TOKYO 100-8310, JAPAN

---