

# Air-Conditioners OUTDOOR UNIT

CE

# PUD-P250YMF-C

GB

D

F

E

I

NL

RU

## **INSTALLATION MANUAL**

For safe and correct use, please read this installation manual thoroughly before installing the air-conditioner unit.

## **INSTALLATIONSHANDBUCH**

Zum sicheren und ordnungsgemäßen Gebrauch der Klimageräte das Installationshandbuch gründlich durchlesen.

## **MANUEL D'INSTALLATION**

Veuillez lire le manuel d'installation en entier avant d'installer ce climatiseur pour éviter tout accident et vous assurer d'une utilisation correcte.

## **MANUAL DE INSTALACIÓN**

Para un uso seguro y correcto, lea detalladamente este manual de instalación antes de montar la unidad de aire acondicionado.

## **MANUALE DI INSTALLAZIONE**

Per un uso sicuro e corretto, leggere attentamente questo manuale di installazione prima di installare il condizionatore d'aria.

## **INSTALLATIEHANDLEIDING**

Voor een veilig en juist gebruik moet u deze installatiehandleiding grondig doorlezen voordat u de airconditioner installeert.

## **РУКОВОДСТВО ПО УСТАНОВКЕ**

Для осторожного и правильного использования прибора необходимо тщательно ознакомиться с данным руководством по установке до выполнения установки кондиционера.

**4** [Fig. 4.0.1]

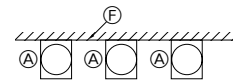
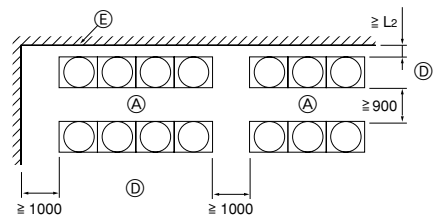
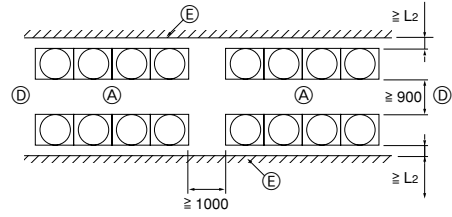
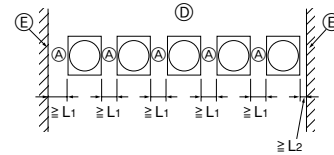
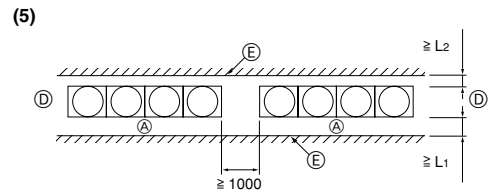
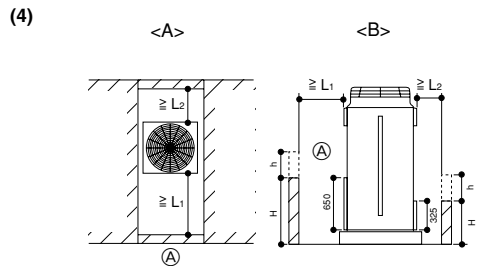
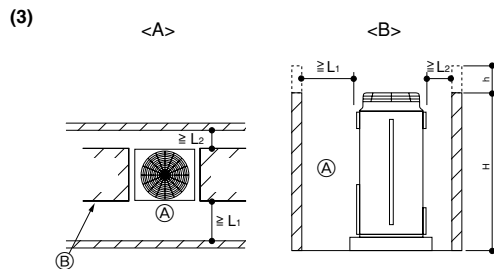
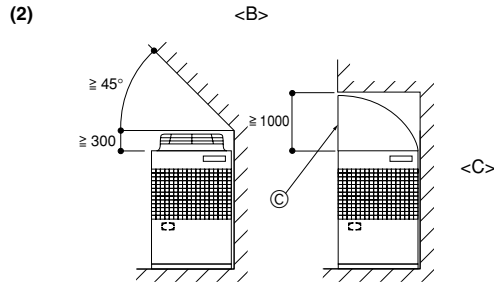
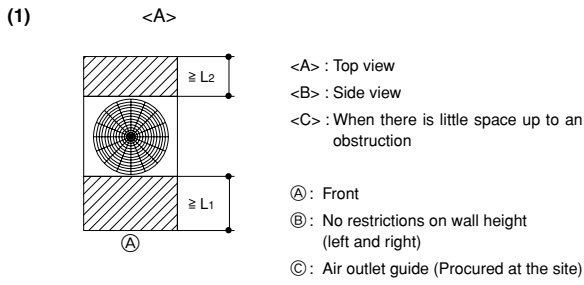

- (D) : Must be open
- (E) : Wall height (H)
- (F) : No restrictions on wall height

L1	L2
450	450

**5** [Fig. 5.0.1]

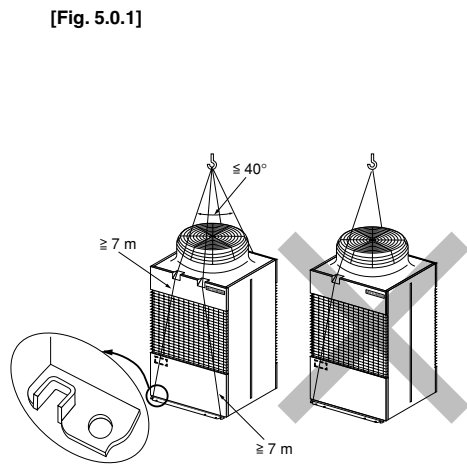

**6** **6.1**

[Fig. 6.1.1]

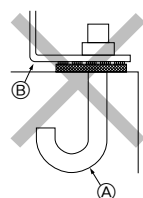

- (A) : M10 anchor bolt procured at the site.
- (B) : Corner is not seated.

[Fig. 6.1.2]

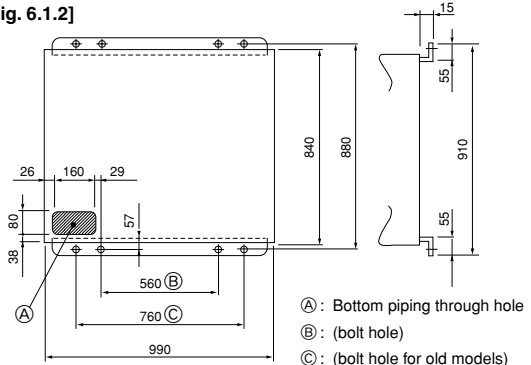

**6.2**

[Fig. 6.2.1]

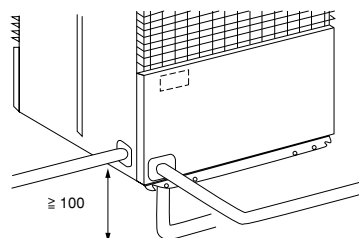

[Fig. 7.2.1]

When used in combination with PFD-P250VM-A

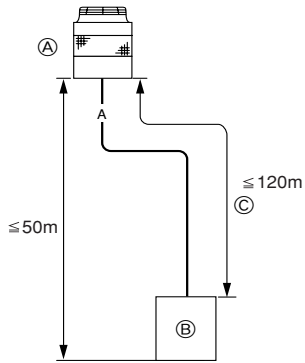

When used in combination with PFD-P500VM-A

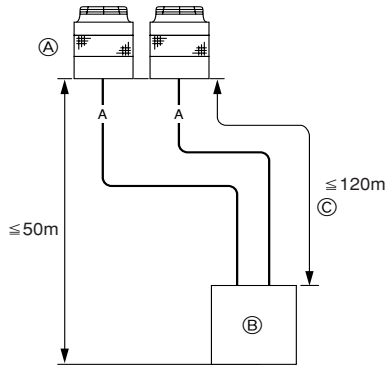

- Ⓐ : Outdoor unit
- Ⓑ : Indoor unit
- Ⓒ : (Equivalent length : 150m)

	Ⓐ Liquid pipe	Ⓑ Gas pipe
PFD-P250/500VM-A	ø12.7	ø28.58

(mm)

[Fig. 8.2.1]

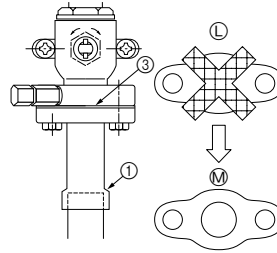

[Fig. 8.2.2]

<A> [Ball valve (gas side)] <B> [Ball valve (liquid side)]  
(This figure shows the valve in the fully open state.)

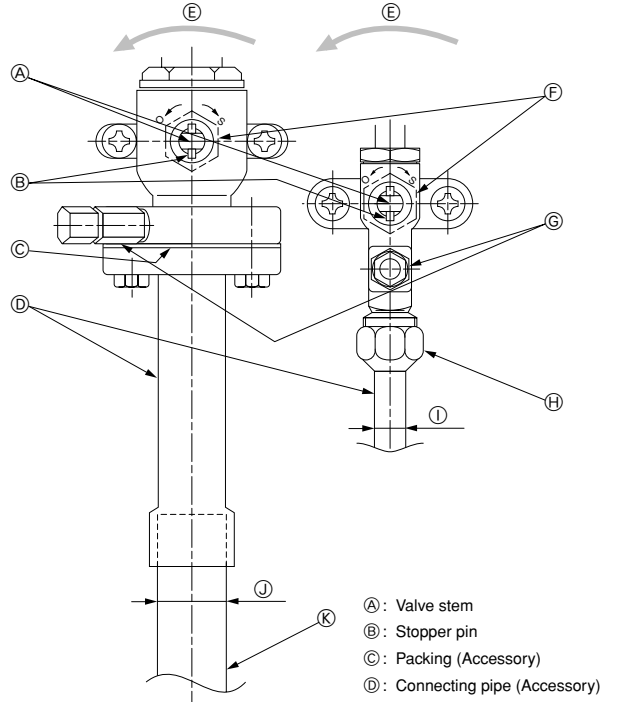

[Fig. 8.2.3]

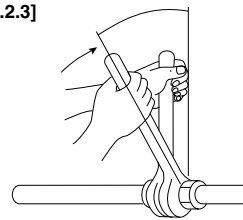

- Ⓐ : Valve stem
- Ⓑ : Stopper pin
- Ⓒ : Packing (Accessory)
- Ⓓ : Connecting pipe (Accessory)
- Ⓔ : Open (Operate slowly)
- Ⓕ : Cap, copper packing
- Ⓖ : Service port
- Ⓗ : Flare nut
- Ⓛ : ø12.7
- Ⓜ : ø28.58
- Ⓚ : Field piping
- Ⓛ : Close-packed
- Ⓜ : Hollow packing

8.3

[Fig. 8.3.1]

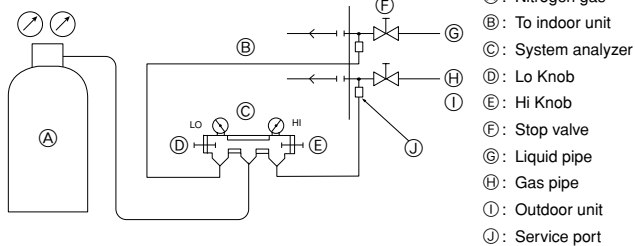

- Ⓐ : Nitrogen gas
- Ⓑ : To indoor unit
- Ⓒ : System analyzer
- Ⓓ : Lo Knob
- Ⓔ : Hi Knob
- Ⓕ : Stop valve
- Ⓖ : Liquid pipe
- Ⓗ : Gas pipe
- Ⓛ : Outdoor unit
- Ⓜ : Service port

[Fig. 8.3.2]

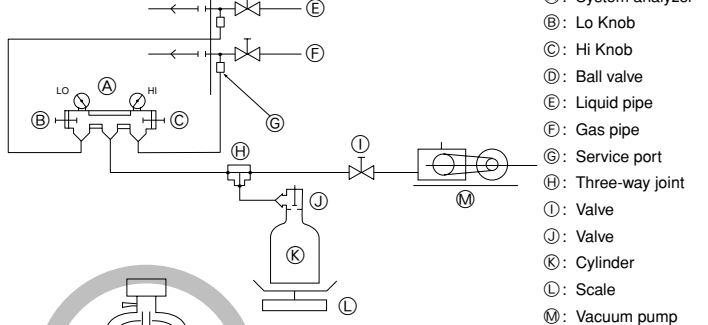

- Ⓐ : System analyzer
- Ⓑ : Lo Knob
- Ⓒ : Hi Knob
- Ⓓ : Ball valve
- Ⓔ : Liquid pipe
- Ⓕ : Gas pipe
- Ⓖ : Service port
- Ⓗ : Three-way joint
- Ⓛ : Valve
- Ⓜ : Valve
- Ⓚ : Cylinder
- Ⓛ : Scale
- Ⓜ : Vacuum pump

[Fig. 8.3.3]

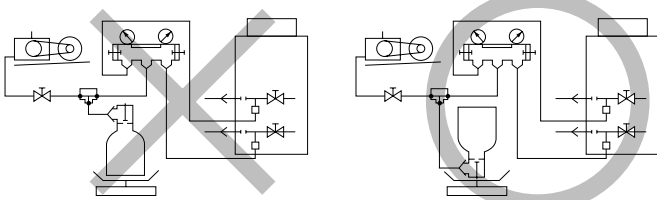

## 8.4

[Fig. 8.4.1]

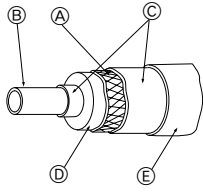

- Ⓐ: Steel wire
- Ⓑ: Piping
- Ⓒ: Asphaltic oily mastic or asphalt
- Ⓓ: Heat insulation material A
- Ⓔ: Outer covering B

[Fig. 8.4.2]

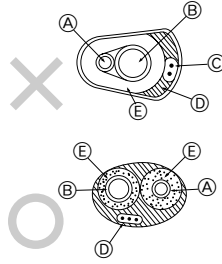

- Ⓐ: Liquid pipe
- Ⓑ: Gas pipe
- Ⓒ: Electric wire
- Ⓓ: Finishing tape
- Ⓔ: Insulator

[Fig. 8.4.3]

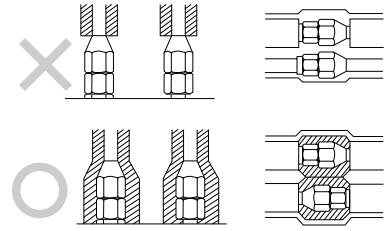

[Fig. 8.4.4]

<A> Inner wall (concealed)

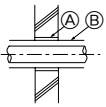

<B> Outer wall

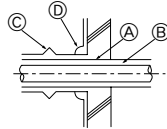

<C> Outer wall (exposed)

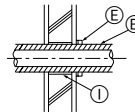

<D> Floor (fireproofing)

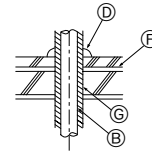

<E> Roof pipe shaft

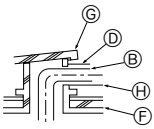

<F> Penetrating portion on fire limit and boundary wall

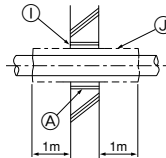

- Ⓐ: Sleeve
- Ⓑ: Heat insulating material
- Ⓒ: Lagging
- Ⓓ: Caulking material
- Ⓔ: Band
- Ⓕ: Waterproofing layer
- Ⓖ: Sleeve with edge
- Ⓖ: Lagging material
- Ⓡ: Mortar or other incombustible caulking
- Ⓢ: Incombustible heat insulation material

## 9

## 9.2

[Fig. 9.2.1]

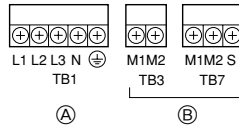

- Ⓐ: Power source
- Ⓑ: Transmission line

## 9.4

[Fig. 9.4.1]

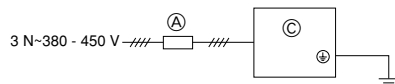
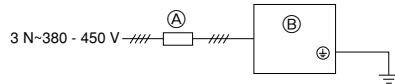

- Ⓐ: Switch (Breakers for Wiring and Current Leakage)
- Ⓑ: Outdoor unit
- Ⓒ: Indoor unit

# Contents

1. Safety precautions .....	5	7.2. Refrigerant piping system .....	8
1.1. Before installation and electric work .....	5	8. Additional Refrigerant Charge .....	8
1.2. Precautions for devices that use R407C refrigerant .....	5	8.1. Calculation of Additional Refrigerant Charge .....	8
1.3. Before getting installed .....	6	8.2. Caution for piping connection/valve operation .....	8
1.4. Before getting installed (moved) - electrical work .....	6	8.3. Airtight test, evacuation, and refrigerant charging .....	9
1.5. Before starting the test run .....	6	8.4. Thermal insulation of refrigerant piping .....	10
2. Specifications .....	6	9. Wiring .....	10
3. Confirmation of parts attached .....	6	9.1. Caution .....	10
4. Space required around unit .....	7	9.2. Control box and connecting position of wiring .....	10
5. Lifting method and weight of product .....	7	9.3. Wiring transmission cables .....	10
6. Installation of unit .....	7	9.4. Wiring of main power supply and equipment capacity .....	11
6.1. Installation .....	7	10. Test run .....	11
6.2. Connecting direction for refrigerant piping .....	7	10.1. The following phenomena do not represent trouble (emergency) .....	11
7. Refrigerant piping installation .....	7		
7.1. Caution .....	7		

## 1. Safety precautions

### 1.1. Before installation and electric work





- ▶ **Before installing the unit, make sure you read all the “Safety precautions”.**
- ▶ **The “Safety precautions” provide very important points regarding safety. Make sure you follow them.**

#### Symbols used in the text

 **Warning:**  
Describes precautions that should be observed to prevent danger of injury or death to the user.

 **Caution:**  
Describes precautions that should be observed to prevent damage to the unit.

#### Symbols used in the illustrations

-  : Indicates an action that must be avoided.
-  : Indicates that important instructions must be followed.
-  : Indicates a part which must be grounded.
-  : Beware of electric shock. (This symbol is displayed on the main unit label.)  
<Color: yellow>

-  **Warning:**  
**Carefully read the labels affixed to the main unit.**

-  **Warning:**
  - **Ask the dealer or an authorized technician to install the air conditioner.**
    - Improper installation by the user may result in water leakage, electric shock, or fire.
  - **Install the unit at a place that can withstand its weight.**
    - Inadequate strength may cause the unit to fall down, resulting in injuries.
  - **Use the specified cables for wiring. Make the connections securely so that the outside force of the cable is not applied to the terminals.**
    - Inadequate connection and fastening may generate heat and cause a fire.
  - **Prepare for strong winds and earthquakes and install the unit at the specified place.**
    - Improper installation may cause the unit to topple and result in injury.
  - **Always use an filter and other accessories specified by Mitsubishi Electric.**
    - Ask an authorized technician to install the accessories. Improper installation by the user may result in water leakage, electric shock, or fire.
  - **Never repair the unit. If the air conditioner must be repaired, consult the dealer.**
    - If the unit is repaired improperly, water leakage, electric shock, or fire may result.
  - **Do not touch the heat exchanger fins.**
    - Improper handling may result in injury.
  - **If refrigerant gas leaks during installation work, ventilate the room.**
    - If the refrigerant gas comes into contact with a flame, poisonous gases will be released.
  - **Install the air conditioner according to this Installation Manual.**
    - If the unit is installed improperly, water leakage, electric shock, or fire may result.

- **Have all electric work done by a licensed electrician according to “Electric Facility Engineering Standard” and wire regulation of the region and the instructions given in this manual and always use a special circuit.**
  - If the power source capacity is inadequate or electric work is performed improperly, electric shock and fire may result.
- **Securely install the outdoor unit terminal cover (panel).**
  - If the terminal cover (panel) is not installed properly, dust or water may enter the outdoor unit and fire or electric shock may result.
- **When installing and moving the air conditioner to another site, do not charge the it with a refrigerant different from the refrigerant (R407C) specified on the unit.**
  - If a different refrigerant or air is mixed with the original refrigerant, the refrigerant cycle may malfunction and the unit may be damaged.
- **If the air conditioner is installed in a small room, measures must be taken to prevent the refrigerant concentration from exceeding the safety limit even if the refrigerant should leak.**
  - Consult the dealer regarding the appropriate measures to prevent the safety limit from being exceeded. Should the refrigerant leak and cause the safety limit to be exceeded, hazards due to lack of oxygen in the room could result.
- **When moving and reinstalling the air conditioner, consult the dealer or an authorized technician.**
  - If the air conditioner is installed improperly, water leakage, electric shock, or fire may result.
- **After completing installation work, make sure that refrigerant gas is not leaking.**
  - If the refrigerant gas leaks and is exposed to a fan heater, stove, oven, or other heat source, it may generate noxious gases.
- **Do not reconstruct or change the settings of the protection devices.**
  - If the pressure switch, thermal switch, or other protection device is shorted and operated forcibly, or parts other than those specified by Mitsubishi Electric are used, fire or explosion may result.
- **To dispose of this product, consult your dealer.**
- **The installer and system specialist shall secure safety against leakage according to local regulation or standards.**
  - Following standards may be applicable if local regulation are not available.
- **Pay a special attention to the place, such as a basement, etc. where refrigeration gas can stay, since refrigeration is heavier than the air.**

### 1.2. Precautions for devices that use R407C refrigerant

-  **Caution:**
  - **Do not use the existing refrigerant piping.**
    - The old refrigerant and refrigerator oil in the existing piping contains a large amount of chlorine which may cause the refrigerator oil of the new unit to deteriorate.
  - **Use refrigerant piping made of phosphorus deoxidized copper and copper alloy seamless pipes and tubes. In addition, be sure that the inner and outer surfaces of the pipes are clean and free of hazardous sulphur, oxides, dust/dirt, shaving particles, oils, moisture, or any other contaminant.**
    - Contaminants on the inside of the refrigerant piping may cause the refrigerant residual oil to deteriorate.
  - **Store the piping to be used during installation indoors and keep both ends of the piping sealed until just before brazing. (Store elbows and other joints in a plastic bag.)**
    - If dust, dirt, or water enters the refrigerant cycle, deterioration of the oil and compressor trouble may result.
  - **Use ester oil, ether oil or alkylbenzene (small amount) as the refrigerator oil to coat flares and flange connections.**
    - The refrigerator oil will degrade if it is mixed with a large amount of mineral oil.

- **Use liquid refrigerant to fill the system.**
  - If gas refrigerant is used to seal the system, the composition of the refrigerant in the cylinder will change and performance may drop.
- **Do not use a refrigerant other than R407C.**
  - If another refrigerant (R22, etc.) is used, the chlorine in the refrigerant may cause the refrigerator oil to deteriorate.
- **Use a vacuum pump with a reverse flow check valve.**
  - The vacuum pump oil may flow back into the refrigerant cycle and cause the refrigerator oil to deteriorate.
- **Do not use the following tools that are used with conventional refrigerants.**

**(Gauge manifold, charge hose, gas leak detector, reverse flow check valve, refrigerant charge base, refrigerant recovery equipment)**

  - If the conventional refrigerant and refrigerator oil are mixed in the R407C, the refrigerant may deteriorate.
  - If water is mixed in the R407C, the refrigerator oil may deteriorate.
  - Since R407C does not contain any chlorine, gas leak detectors for conventional refrigerants will not react to it.
- **Do not use a charging cylinder.**
  - Using a charging cylinder may cause the refrigerant to deteriorate.
- **Be especially careful when managing the tools.**
  - If dust, dirt, or water gets in the refrigerant cycle, the refrigerant may deteriorate.

### 1.3. Before getting installed

#### ⚠ Caution:

- **Do not install the unit where combustible gas may leak.**
  - If the gas leaks and accumulates around the unit, an explosion may result.
- **Do not use the air conditioner where food, pets, plants, precision instruments, or artwork are kept.**
  - The quality of the food, etc. may deteriorate.
- **Do not use the air conditioner in special environments.**
  - Oil, steam, sulfuric smoke, etc. can significantly reduce the performance of the air conditioner or damage its parts.
- **When installing the unit in a hospital, communication station, or similar place, provide sufficient protection against noise.**
  - The inverter equipment, private power generator, high-frequency medical equipment, or radio communication equipment may cause the air conditioner to operate erroneously, or fail to operate. On the other hand, the air conditioner may affect such equipment by creating noise that disturbs medical treatment or image broadcasting.
- **Do not install the unit on a structure that may cause leakage.**
  - When the room humidity exceeds 80 % or when the drain pipe is clogged, condensation may drip from the indoor unit. Perform collective drainage work together with the outdoor unit, as required.

### 1.4. Before getting installed (moved) - electrical work

#### ⚠ Caution:

- **Ground the unit.**
  - Do not connect the ground wire to gas or water pipes, lightning rods, or telephone ground lines. Improper grounding may result in electric shock.
- **The reverse phase of L lines (L1, L2, L3) can be detected (Error cord: 4103), but the reverse phase of L lines and N line can be not be detected.**
  - The some electric parts should be damaged when power is supplied under the miss wiring.

## 2. Specifications

Model	PUD-P250YMF-C
Noise level	56 dB <A>
Net weight	231 kg
Maximum refrigerant pressure	2.94 MPa
External static pressure	0 Pa
Operation temperature	Cooling mode: - 15 °CDB ~ 43 °CDB

## 3. Confirmation of parts attached

- |   |  |  |
|---|--|--|
| ① Wiring mounting board × 1                                     | ② Conduit mounting plate (ø40, ø33, ø27) × 1 | ③ Tapping screw M4 × 6                 |
| ④ Connecting pipe × 1 (Connecting pipe is fixed with the unit.) |  | ⑤ Packing (inside ø23, outsideø35) × 1 |

- **Install the power cable so that tension is not applied to the cable.**
  - Tension may cause the cable to break and generate heat and cause a fire.
- **Install an leak circuit breaker, as required.**
  - If an leak circuit breaker is not installed, electric shock may result.
- **Use power line cables of sufficient current carrying capacity and rating.**
  - Cables that are too small may leak, generate heat, and cause a fire.
- **Use only a circuit breaker and fuse of the specified capacity.**
  - A fuse or circuit breaker of a larger capacity or a steel or copper wire may result in a general unit failure or fire.
- **Do not wash the air conditioner units.**
  - Washing them may cause an electric shock.
- **Be careful that the installation base is not damaged by long use.**
  - If the damage is left uncorrected, the unit may fall and cause personal injury or property damage.
- **Install the drain piping according to this Installation Manual to ensure proper drainage. Wrap thermal insulation around the pipes to prevent condensation.**
  - Improper drain piping may cause water leakage and damage to furniture and other possessions.
- **Be very careful about product transportation.**
  - Only one person should not carry the product if it weighs more than 20 kg.
  - Some products use PP bands for packaging. Do not use any PP bands for a means of transportation. It is dangerous.
  - Do not touch the heat exchanger fins. Doing so may cut your fingers.
  - When transporting the outdoor unit, suspend it at the specified positions on the unit base. Also support the outdoor unit at four points so that it cannot slip sideways.
- **Safely dispose of the packing materials.**
  - Packing materials, such as nails and other metal or wooden parts, may cause stabs or other injuries.
  - Tear apart and throw away plastic packaging bags so that children will not play with them. If children play with a plastic bag which was not torn apart, they face the risk of suffocation.

### 1.5. Before starting the test run

#### ⚠ Caution:

- **Turn on the power at least 12 hours before starting operation.**
  - Starting operation immediately after turning on the main power switch can result in severe damage to internal parts. Keep the power switch turned on during the operational season.
- **Do not touch the switches with wet fingers.**
  - Touching a switch with wet fingers can cause electric shock.
- **Do not touch the refrigerant pipes during and immediately after operation.**
  - During and immediately after operation, the refrigerant pipes are may be hot and may be cold, depending on the condition of the refrigerant flowing through the refrigerant piping, compressor, and other refrigerant cycle parts. Your hands may suffer burns or frostbite if you touch the refrigerant pipes.
- **Do not operate the air conditioner with the panels and guards removed.**
  - Rotating, hot, or high-voltage parts can cause injuries.
- **Do not turn off the power immediately after stopping operation.**
  - Always wait at least five minutes before turning off the power. Otherwise, water leakage and trouble may occur.

## 4. Space required around unit

[Fig. 4.0.1] (P.2)

<A> Top view

<B> Side view

<C> When there is little space up to an obstruction

Ⓐ Front

Ⓑ No restrictions on wall height (left and right)

Ⓒ Air outlet guide (Procured at the site)

Ⓓ Must be open

Ⓔ Wall height (H)

Ⓕ No restrictions on wall height

L1	L2
450	450

### (1) Basic space required

A space of at least 250 mm is necessary at the back for inlet air. Taking servicing, etc. from the rear into account, a space of about 450 mm should be provided, the same as at the front.

### (2) When there is an obstruction above the unit

### (3) When inlet air enters from right and left sides of unit

- Wall heights (H) of the front and the back sides shall be within overall height of unit.
- When the total height is exceeded, add the "h" dimension of the Fig. 4.0.1 to L1 and L2.

### (4) When unit is surrounded by walls

#### Note:

- Wall heights (H) of the front and the back sides shall be within overall height of unit.
- If the panel height is exceeded, add the "h" dimension of the Fig. 4.0.1 to L1 and L2.

L1	L2
450	450

Example: When h is 100,  
the L1 dimension becomes  $450 + 100 = 550$  mm.

### (5) Collective installation and continuous installation

- Space required for collective installation and continuous installation:  
When installing several units, leave the space between each block below considering passage for air and people.
- Open in the two directions.
- In case wall height (H) exceeds overall height of unit, add "h" dimension (h = wall height <H> – overall height of unit) to \* marked dimension.
- If there is a wall at both the front and the rear of the unit, install up to four units consecutively in the side direction and provide a space of 1000 mm or more as inlet space/passage space for each four units.

## 5. Lifting method and weight of product

[Fig. 5.0.1] (P.2)

### ⚠ Caution:

#### Be very careful to carry product.

- Do not have only one person to carry product if it is more than 20 kg.
- PP bands are used to pack some products. Do not use them as a mean for transportation because they are dangerous.
- Do not touch heat exchanger fins with your bare hands. Otherwise you may get a cut in your hands.
- Tear plastic packaging bag and scrap it so that children cannot play with it. Otherwise plastic packaging bag may suffocate children to death.
- When carrying in outdoor unit, be sure to support it at four points. Carrying in and lifting with 3-point support may make outdoor unit unstable, resulting in a fall of it.

## 6. Installation of unit

### 6.1. Installation

[Fig. 6.1.1] (P.2)

Ⓐ M10 anchor bolt procured at the site.

Ⓑ Corner is not seated.

- Fix unit tightly with bolts so that unit will not fall down due to earthquake or gust.
- Use concrete or angle for foundation of unit.
- Vibration may be transmitted to the installation section and noise and vibration may be generated from the floor and walls, depending on the installation conditions. Therefore, provide ample vibrationproofing (cushion pads, cushion frame, etc.).
- Be sure that the corners are firmly seated. If the corners are not firmly seated, the installation feet may be bent.

### ⚠ Warning:

- Be sure to install unit in a place strong enough to withstand its weight. Any lack of strength may cause unit to fall down, resulting in a personal injury.
- Have installation work in order to protect against a strong wind and earthquake.

#### Any installation deficiency may cause unit to fall down, resulting in a personal injury.

When building the foundation, give full attention to the floor strength, drain water disposal <during operation, drain water flows out of the unit>, and piping and wiring routes.

#### Down piping and down wiring precautions

When down piping and down wiring are performed, be sure that foundation and base work does not block the base through holes. When down piping is performed, make the foundation at least 100 mm high so that the piping can pass under the bottom of the unit.

[Fig. 6.1.2] (P.2)

Ⓐ Bottom piping through hole

Ⓑ (bolt hole)

Ⓒ (bolt hole for old models)

### 6.2. Connecting direction for refrigerant piping

[Fig. 6.2.1] (P.2)

## 7. Refrigerant piping installation

Connecting the piping is a terminal-branch type in which refrigerant piping from the outdoor unit is branched at the terminal and connected to each of the indoor units.

The method of connection consists of flare connections at the indoor units, flange connections for the piping of the outdoor unit and flare connections for the liquid piping. Note that the branched sections are brazed.

### ⚠ Warning:

**Always use extreme care to prevent the refrigerant gas (R407C) from leaking while using fire or flame. If the refrigerant gas comes in contact with the flame from any source, such as a gas stove, it breaks down and generates a poisonous gas which can cause gas poisoning. Never weld in an unventilated room. Always conduct an inspection for gas leakage after installation of the refrigerant piping has been completed.**

### 7.1. Caution

- ① Use the following materials for refrigeration piping.
  - Material: Use refrigerant piping made of phosphorus deoxidized copper. In addition, be sure that the inner and outer surfaces of the pipes are clean and free of hazardous sulphur, oxides, dust/dirt, shaving particles, oils, moisture, or any other contaminant. (For R407C models)
- ② Commercially available piping often contains dust and other materials. Always blow it clean with a dry inert gas.
- ③ Use care to prevent dust, water or other contaminants from entering the piping during installation.
- ④ Reduce the number of bending portions as much as possible, and make bending radius as big as possible.
- ⑤ Always observe the restrictions on the refrigerant piping (such as rated length, the difference between high/low pressures, and piping diameter). Failure to do so can result in equipment failure or a decline in heating/cooling performance.

- ⑥ This system will stop due an abnormality due to excessive or insufficient coolant. At such a time, always properly charge the unit. When servicing, always check the notes concerning pipe length and amount of additional refrigerant at both locations, the refrigerant volume calculation table on the back of the service panel and the additional refrigerant section on the labels for the combined number of indoor units.
  - ⑦ **Use liquid refrigerant to fill the system.**
  - ⑧ Never use refrigerant to perform an air purge. Always evacuate using a vacuum pump.
  - ⑨ Always insulate the piping properly. Insufficient insulation will result in a decline in heating/cooling performance, water drops from condensation and other such problems.
  - ⑩ When connecting the refrigerant piping, make sure the ball valve of the outdoor unit is completely closed (the factory setting) and do not operate it until the refrigerant piping for the outdoor and indoor units has been connected, a refrigerant leakage test has been performed and the evacuation process has been completed.
  - ⑪ Always use a non-oxidizing brazing material for brazing the parts. If a non-oxidizing brazing material is not used, it could cause clogging or damage to the compressor unit.
- \*3: Apply non-oxide brazing, using nitrogen.**  
Do not use commercially available antioxidants, for it may cause corrosion in the pipes or cause the refrigerant oil to deteriorate.
- ⑫ **Never perform outdoor unit piping connection work when it is raining.**

**Warning:**  
When installing and moving the unit, do not charge it with refrigerant other than the refrigerant specified on the unit.

- Mixing of a different refrigerant, air, etc. may cause the refrigerant cycle to malfunction and result in severe damage.

## 8. Additional Refrigerant Charge

At the time of shipping, the outdoor unit is charged with the refrigerant. As this charge does not include the amount needed for extended piping, additional charging for each refrigerant line will be required on site. In order that future servicing may be properly provided, always keep a record of the size and length of each refrigerant line and the amount of additional charge by writing it in the space provided on the outdoor unit.

### 8.1. Calculation of Additional Refrigerant Charge

- Calculate the amount of additional charge based on the length of the piping extension and the size of the refrigerant line.
- Use the table to the right as guide to calculating the amount of additional charging and charge the system according.
- If the calculation results of the calculation result in a fraction of less than 0.1 kg. For example, if the result of the calculation was 10.62 kg, round the result up to 10.7 kg.

<Additional Charge>

Additional refrigerant charge	=	Liquid pipe size Total length of ø12.7 × 0.12	+ 2.0 kg
(kg)		(m) × 0.12 (kg/m)	

ø12.7: 120 m

Therefore,  
<Calculation example>  
Additional refrigerant charge  
= 120 m × 0.12kg/m + 2.0 kg = 16.4 kg

### 8.2. Caution for piping connection/valve operation

- Conduct piping connection and valve operation accurately.
  - The gas side connecting pipe is being assembled for shipment.
- ① For brazing to the connecting pipe with flange, remove the connecting pipe with flange from the ball valve, and braze it at the outside of the unit.
  - ② During the time when removing the connecting pipe with flange, remove the seal attached on the back side of this sheet and paste it onto the flange surface of the ball valve to prevent the entry of dust into the valve.

- Caution:**
- **Use a vacuum pump with a reverse flow check valve. (For R407C models)**
    - If the vacuum pump does not have a reverse flow check valve, the vacuum pump oil may flow back into the refrigerant cycle and cause deterioration of the refrigerant oil and other trouble.
  - **Do not use the tools shown below used with conventional refrigerant. (For R407C models)**  
**(Gauge manifold, charge hose, gas leak detector, check valve, refrigerant charge base, vacuum gauge, refrigerant recovery equipment)**
    - Mixing of conventional refrigerant and refrigerant oil may cause the refrigerant oil to deteriorate.
    - Mixing of water will cause the refrigerant oil to deteriorate.
    - R407C refrigerant does not contain any chlorine. Therefore, gas leak detectors for conventional refrigerants will not react to it.
  - **Manage the tools more carefully than normal. (For R407C models)**
    - If dust, dirt, or water gets in the refrigerant cycle, the refrigerant oil will deteriorate.
  - **Never use existing refrigerant piping. (For R407C models)**
    - The large amount of chlorine in conventional refrigerant and refrigerant oil in the existing piping will cause the new refrigerant to deteriorate.
  - **Store the piping to be used during installation indoors and keep both ends of the piping sealed until just before brazing.**
    - If dust, dirt, or water gets into the refrigerant cycle, the oil will deteriorate and the compressor may fail.
  - **Do not use a charging cylinder. (For R407C models)**
    - Using a charging cylinder may cause the refrigerant to deteriorate.
  - **Do not use special detergents for washing piping.**

## 7.2. Refrigerant piping system

Connection Example

[Fig. 7.2.1] (P.3)

- Ⓐ Liquid pipe
- Ⓔ Gas pipe
- Ⓐ Outdoor unit
- Ⓔ Indoor unit
- Ⓒ (Equivalent length : 150m)

- ③ The refrigerant circuit is closed with a round, close-packed packing at the shipment to prevent gas leak between flanges. As no operation can be done under this state, be sure replace the packing with the hollow packing attached at the piping connection.
- ④ At the mounting of the hollow packing, wipe off dust attached on the flange sheet surface and the packing. Coat refrigerating machine oil (Ester oil, ether oil or alkylbenzene [small amount]) onto both surfaces of the packing.

[Fig. 8.2.1] (P.3)

- After evacuation and refrigerant charge, ensure that the handle is fully open. If operating with the valve closed, abnormal pressure will be imparted to the high- or low-pressure side of the refrigerant circuit, giving damage to the compressor, four-way valve, etc.
- Determine the amount of additional refrigerant charge by using the formula, and charge refrigerant additionally through the service port after completing piping connection work.
- After completing work, tighten the service port and cap securely not to generate gas leak.

[Fig. 8.2.2] (P.3)

- <A> [Ball valve (gas side)]  
(This figure shows the valve in the fully open state.)
- <B> [Ball valve (liquid side)]
- Ⓐ Valve stem  
[Fully closed at the factory, when connecting the piping, when evacuating, and when charging additional refrigerant. Open fully after the operations above are completed.]
  - Ⓑ Stopper pin [Prevents the valve stem from turning 90° or more.]
  - Ⓒ Packing (Accessory)  
[Manufacturer: Nichiasu corporation]  
[Type: T/#1991-NF]
  - Ⓓ Connecting pipe (Accessory)  
[Use packing and securely install this pipe to the valve flange so that gas leakage will not occur. (Tightening torque: 50 N·m (500 kg·cm)) Coat both surfaces of the packing with refrigerant oil (Ester oil, ether oil or alkylbenzene [small amount]).]
  - Ⓔ Open (Operate slowly)
  - Ⓕ Cap, copper packing  
[Remove the cap and operate the valve stem. Always reinstall the cap after operation is completed. (Valve stem cap tightening torque: 25 N·m (250 kg·cm) or more)]
  - Ⓖ Service port  
[Use this port to evacuate the refrigerant piping and add an additional charge at the site.  
Open and close the port using a double-ended wrench.  
Always reinstall the cap after operation is completed. (Service port cap tightening torque: 14 N·m (140 kg·cm) or more)]



- Ⓟ Flare nut  
[Tightening torque: 55 N·m (550 kg·cm)  
Loosen and tighten this nut using a double-ended wrench.  
Coat the flare contact surface with refrigerant oil (Ester oil, ether oil or alkylbenzene [small amount]).]
- ① ø12.7
- ② ø28.58
- Ⓚ Field piping  
[Brazed to the connecting pipe. (When brazing, use unoxidized brazing.)]
- Ⓛ Close-packed packing
- Ⓜ Hollow packing

Appropriate tightening torque by torque wrench:

Copper pipe external dia. (mm)	Tightening torque (N·m) / (kg·cm)
ø6.35	14 to 18 / 140 to 180
ø9.52	35 to 42 / 350 to 420
ø12.7	50 to 57.5 / 500 to 575
ø15.88	75 to 80 / 750 to 800
ø19.05	100 to 140 / 1000 to 1400

Tightening angle standard:

Pipe diameter (mm)	Tightening angle (°)
ø6.35, ø9.52	60 to 90
ø12.7, ø15.88	30 to 60
ø19.05	20 to 35

[Fig. 8.2.3] (P.3)

Note:

**If a torque wrench is not available, use the following method as a standard: When you tighten the flare nut with a wrench, you will reach a point where the tightening torque will abruptly increase. Turn the flare nut beyond this point by the angle shown in the table above.**

Airtight test procedure	Restriction
1. Nitrogen gas pressurization (1) After pressurizing to the design pressure (2.94 MPa) using nitrogen gas, let stand for about one day. If the pressure does not drop, airtightness is good. However, if the pressure drops, since the leaking point is unknown, the following bubble test may also be performed. (2) After the pressurization described above, spray the flare connection parts, brazed parts, flanges, and other parts that may leak with a bubbling agent (Kyuboflex, etc.) and visually check for bubbles. (3) After the airtight test, wipe off the bubbling agent.	<ul style="list-style-type: none"> <li>• If a flammable gas or air (oxygen) is used as the pressurization gas, it may catch fire or explode.</li> </ul>
2. Pressurization using refrigerant gas and nitrogen gas (1) Pressurizing to a gas pressure of approximately 0.2 MPa, pressurize to the design pressure (2.94 MPa) using nitrogen gas. However, do not pressurize at one time. Stop during pressurization and check that the pressure does not drop. (2) Check for gas leaks by checking the flare connection parts, brazed parts, flanges, and other parts which may leak using an R407C compatible electric leak detector. (3) This test may be used together with the bubble type gas leak test.	<ul style="list-style-type: none"> <li>• Do not use a refrigerant other than that indicated on the unit.</li> <li>• Sealing with gas from a cylinder will cause the composition of the refrigerant in the cylinder to change. (For R407C models)</li> <li>• Use a pressure gauge, charge box, and other parts especially for R407C. (For R407C models)</li> <li>• An electric leak detector for R22 cannot detect leaks of R407C.</li> <li>• Do not use a haloid torch. (Leaks cannot be detected.)</li> </ul>

## ② Evacuation

Evacuate with the ball valve of the outdoor unit closed and evacuate both the connection piping and the indoor unit from the service port provided on the ball valve of the outdoor unit using a vacuum pump. (Always evacuate from the service port of both the liquid pipe and the gas pipe.) After the vacuum reaches 650 Pa [abs], continue evacuation for at least one hour or more.

\* Never perform air purging using refrigerant.

[Fig. 8.3.2] (P.3)

- Ⓐ System analyzer
- Ⓑ Lo Knob
- Ⓒ Hi Knob
- Ⓓ Ball valve
- Ⓔ Liquid pipe
- Ⓕ Gas pipe
- Ⓖ Service port
- Ⓖ Three-way joint
- Ⓘ Valve
- Ⓙ Valve
- Ⓚ Cylinder
- Ⓛ Scale
- Ⓜ Vacuum pump

Note:

- **Always add an appropriate amount of refrigerant. Also always seal the system with liquid refrigerant. Too much or too little refrigerant will cause trouble.**
- **Use a gauge manifold, charging hose, and other parts for the refrigerant indicated on the unit.**
- **Use a gravimeter. (One that can measure down to 0.1 kg.)**
- **Use a vacuum pump with a reverse flow check valve. (For R407C models) (Recommended vacuum gauge: ROBINAIR 14830A Thermistor Vacuum Gauge)**  
**Also use a vacuum gauge that reaches 0.5 Torr or greater after operating for five minutes.**

## ⚠ Caution:

- **Always remove the connecting pipe from the ball valve and braze it outside the unit.**  
 - Brazing the connecting pipe while it is installed will heat the ball valve and cause trouble or gas leakage. The piping, etc. inside the unit may also be burned.
- **Use ester oil, ether oil or alkylbenzene (small amount) as the refrigerant oil to coat flares and flange connections. (For R407C models)**  
 - The refrigerant oil will degrade if it is mixed with a large amount of mineral oil.

## 8.3. Airtight test, evacuation, and refrigerant charging

### ① Airtight test

Perform with the stop valve of the outdoor unit closed, and pressurize the connection piping and the indoor unit from the service port provided on the stop valve of the outdoor unit. (Always pressurize from both the liquid pipe and the gas pipe service ports.)

[Fig. 8.3.1] (P.3)

- Ⓐ Nitrogen gas
- Ⓑ To indoor unit
- Ⓒ System analyzer
- Ⓓ Lo Knob
- Ⓔ Hi Knob
- Ⓕ Stop valve
- Ⓖ Liquid pipe
- Ⓖ Gas pipe
- Ⓘ Outdoor unit
- Ⓙ Service port

<For R407C models>

The method of conducting the airtight test is basically the same as for R22 models. However, since the restrictions have a large effect on deterioration of the refrigerant oil, always observe them. Also, with nonazeotropic refrigerant (R407C, etc.), gas leakage causes the composition to change and affects performance. Therefore, perform the airtightness test cautiously.

### ③ Refrigerant Charging (For R407C models)

Since the refrigerant used with the unit is nonazeotropic, it must be charged in the liquid state. Consequently, when charging the unit with refrigerant from a cylinder, if the cylinder does not have a syphon pipe, charge the liquid refrigerant by turning the cylinder upside-down as shown below. If the cylinder has a syphon pipe like that shown in the figure at the right, the liquid refrigerant can be charged with the cylinder standing upright. Therefore, give careful attention to the cylinder specifications. If the unit should be charged with gas refrigerant, replace all the refrigerant with new refrigerant. Do not use the refrigerant remaining in the cylinder.

[Fig. 8.3.3] (P.3)

## 8.4. Thermal insulation of refrigerant piping

Be sure to give insulation work to refrigerant piping by covering liquid pipe and gas pipe separately with enough thickness heat-resistant polyethylene, so that no gap is observed in the joint between indoor unit and insulating material, and insulating materials themselves. When insulation work is insufficient, there is a possibility of condensation drip, etc. Pay special attention to insulation work to ceiling plenum.

[Fig. 8.4.1] (P.4)

- Ⓐ Steel wire
- Ⓑ Piping
- Ⓒ Asphaltic oily mastic or asphalt
- Ⓓ Heat insulation material A
- Ⓔ Outer covering B

Heat insulation material A	Glass fiber + Steel wire	
	Adhesive + Heat - resistant polyethylene foam + Adhesive tape	
Outer covering B	Indoor	Vinyl tape
	Floor exposed	Water-proof hemp cloth + Bronze asphalt
	Outdoor	Water-proof hemp cloth + Zinc plate + Oily paint

**Note:**

- When using polyethylene cover as covering material, asphalt roofing shall not be required.
- No heat insulation must be provided for electric wires.

[Fig. 8.4.2] (P.4)

- Ⓐ Liquid pipe
- Ⓑ Gas pipe
- Ⓒ Electric wire
- Ⓓ Finishing tape
- Ⓔ Insulator

[Fig. 8.4.3] (P.4)

### Penetrations

[Fig. 8.4.4] (P.4)

- <A> Inner wall (concealed)
- <B> Outer wall
- <C> Outer wall (exposed)
- <D> Floor (fireproofing)
- <E> Roof pipe shaft
- <F> Penetrating portion on fire limit and boundary wall
- Ⓐ Sleeve
- Ⓑ Heat insulating material
- Ⓒ Lagging
- Ⓓ Caulking material
- Ⓔ Band
- Ⓕ Waterproofing layer
- Ⓖ Sleeve with edge
- Ⓖ Lagging material
- Ⓗ Mortar or other incombustible caulking
- Ⓙ Incombustible heat insulation material

When filling a gap with mortar, cover the penetration part with steel plate so that the insulation material will not be caved in. For this part, use incombustible materials for both insulation and covering. (Vinyl covering should not be used.)

## 9. Wiring

### 9.1. Caution

- ① Follow ordinance of your governmental organization for technical standard related to electrical equipment, wiring regulations and guidance of each electric power company.
- ② Wiring for control (hereinafter referred to as transmission line) shall be (5 cm or more) apart from power source wiring so that it is not influenced by electric noise from power source wiring. (Do not insert transmission line and power source wire in the same conduit.)
- ③ Be sure to provide designated grounding work to outdoor unit.
- ④ Give some allowance to wiring for electrical part box of indoor and outdoor units, because the box is sometimes removed at the time of service work.
- ⑤ Never connect the main power source to terminal block of transmission line. If connected, electrical parts will be burnt out.
- ⑥ Use 2-core shield cable for transmission line. If transmission lines of different systems are wired with the same multicore cable, the resultant poor transmitting and receiving will cause erroneous operations.
- ⑦ Only the transmission line specified should be connected to the terminal block for outdoor unit transmission.  
(Transmission line to be connected with indoor unit : Terminal block TB3 for transmission line, Other : Terminal block TB7 for centralized control)  
Erroneous connection does not allow the system to operate.
- ⑧ In case to connect with the upper class controller or to conduct group operation in different refrigerant systems, the control line for transmission is required between the outdoor units each other.  
Connect this control line between the terminal blocks for centralized control. (2-wire line with no polarity)  
When conducting group operation in different refrigerant systems without connecting to the upper class controller, replace the insertion of the short circuit connector from CN41 of one outdoor unit to CN40.
- ⑨ Group is set by operating the centralized controller (Ex. G-50).

### 9.2. Control box and connecting position of wiring

1. Connect the indoor unit transmission line to transmission terminal block (TB3), or connect the wiring between outdoor units or the wiring with the centralized controller system to the centralized controller terminal block.

When using shielded wiring, connect shield ground of the indoor unit transmission line to the earth screw (Ⓧ) and connect shield ground of the line between outdoor units and the centralized controller system transmission line to the shield (S) terminal of the centralized controller terminal block shield (S) terminal. In addition, in the case of outdoor units whose power supply connector CN41 has been replaced by CN40, the shield terminal (S) of terminal block of the centralized controller system should also be connected to the ground (Ⓧ).

[Fig. 9.2.1] (P.4)

- Ⓐ Power source
- Ⓑ Transmission line

2. Conduit mounting plates (ø27) are being provided. Pass the power supply and transmission wires through the appropriate knock-out holes, then remove the knock-out piece from the bottom of the terminal box and connect the wires.
3. Fix power source wiring to terminal box by using buffer bushing for tensile force (PG connection or the like).

### 9.3. Wiring transmission cables

#### ① Types of control cables

1. Wiring transmission cables
  - Types of transmission cables: Shielding wire CVVS or CPEVS
  - Cable diameter: More than 1.25 mm<sup>2</sup>
  - Maximum wiring length: Within 200 m
2. MA Remote control cables

Kind of remote control cable	2-core cable (unshielded)
Cable diameter	0.3 to 1.25 mm <sup>2</sup>
Length	Less than 200 m

#### ② Wiring examples

- Controller name, symbol and allowable number of controllers.

Name	Symbol	Allowable number of controllers
Outdoor unit controller	OC	
Indoor Unit Controller	IC	One controller for one OC
Remote Controller	RC (MA)	Maximum of two per group

## Example of a group operation system with multiple outdoor units (Shielding wires and address setting are necessary.)

<Examples of Transmission Cable Wiring>

Refer to the installation manual that came with the indoor unit (PFD-P250/500VM).

<Wiring Method and Address Settings>

- Always use shielded wire when making connections between the outdoor unit (OC) and the indoor unit (IC), as well for all OC-OC, and IC-IC wiring intervals.
- Use feed wiring to connect terminals M1 and M2 and the ground terminal on the transmission cable terminal block (TB3) of each outdoor unit (OC) to terminals M1, M2 and terminal S on the transmission cable block of the indoor unit (IC).
- Connect together terminals A, B and terminal S on the terminal block for centralized controller for the outdoor unit (OC).
- On one outdoor unit only, change the jumper connector on the control panel from CN41 to CN40.
- Connect the terminal S on the terminal block for central control (TB7) for the outdoor unit (OC) for the unit into which the jumper connector was inserted into CN40 in Step above to the ground terminal  $\oplus$  in the electrical component box.
- Set the address setting switch as follows.
  - \* To set the outdoor unit address to 100, the outdoor address setting switch must be set to 50.

Unit	Range	Setting Method
IC (Main)	01 to 50	Starting with "01," assign sequential odd numbers to the top controllers in the indoor units as the unit address (01, 03, 05 etc.)
IC (Sub)	01 to 50	Add 1 to the address of the main controller in the same unit.
Outdoor unit	51 to 100	Add 50 to the address of the indoor unit in the same refrigerant system.
MA R/C	—	Unnecessary address setting (Necessary main/sub setting)

- The group setting operations among the multiple indoor units is done by the remote controller (RC) after the electrical power has been turned on.

## 9.4. Wiring of main power supply and equipment capacity

### Schematic Drawing of Wiring (Example)

[Fig. 9.4.1] (P.4)

- Ⓐ Switch (Breakers for Wiring and Current Leakage)
- Ⓑ Outdoor unit
- Ⓒ Indoor unit

### Thickness of Wire for Main Power Supply and On/Off Capacities

Minimum Wire Thickness (mm <sup>2</sup> )			Switch (A)		Breaker for Wiring (NFB)	Breaker for Current Leakage
Main Cable	Branch	Ground	Capacity	Fuse		
4.0	—	4.0	32	32	30 A	30 A 100 mA 0.1sec. or less

- Use a separate power supply for the outdoor unit and indoor unit.
- Bear in mind ambient conditions (ambient temperature, direct sunlight, rain water, etc.) when proceeding with the wiring and connections.
- The wire size is the minimum value for metal conduit wiring. The power cord size should be 1 rank thicker consideration of voltage drops. Make sure the power-supply voltage does not drop more than 10 %.
- Specific wiring requirements should adhere to the wiring regulations of the region.
- Power supply cords of parts of appliances for outdoor use shall not be lighter than polychloroprene sheathed flexible cord (design 245 IEC57). For example, use wiring such as YZW.

### ⚠ Warning:

- Be sure to use specified wires to connect so that no external force is imparted to terminal connections. If connections are not fixed firmly, it may cause heating or fire.
- Be sure to use the appropriate type of overcurrent protection switch. Note that generated overcurrent may include some amount of direct current.

### ⚠ Caution:

- Some installation site may require attachment of an earth leakage breaker. If no earth leakage breaker is installed, it may cause an electric shock.
- Do not use anything other than breaker and fuse with correct capacity. Using fuse and wire or copper wire with too large capacity may cause a malfunction of unit or fire.

## 10. Test run

### 10.1. The following phenomena do not represent trouble (emergency)

Phenomenon	Display of remote controller	Cause
Indoor unit remote controller shows "HO" indicator for about one minute when turning ON universal power supply.	"HO" flashes	System is being driven. Operate remote controller again after "HO" disappear.
Outdoor unit does not run even when turn switch on.	Normal display	Outdoor unit SW 2-7 is on (SW 2-7 is off when shipped from factory). When the outdoor unit cold and the refrigerant has accumulated, the compressor performs warming-up operation for a maximum of 35 minutes. Fan operation is performed during this time.

---

This product is designed and intended for use in the residential, commercial and light-industrial environment.

The product at hand is based on the following EU regulations:

- Low Voltage Directive 73/23/EEC
- Electromagnetic Compatibility Directive 89/336/EEC

Please be sure to put the contact address/telephone number on this manual before handing it to the customer.