 **MITSUBISHI
ELECTRIC**
AIR CONDITIONERS CITY MULTI

Models **PQRY-P200, P250YGM-A**
PQRY-P400, P500YSGM-A
CMB-P104, P105, P106, P108, P1010, P1013, P1016V-G
CMB-P108, P1010, P1013, P1016V-GA
CMB-P104, P108V-GB
PQHY-P200, P250YGM-A
PQHY-P400, P500YSGM-A

R410A

Service Handbook

R410A Service Handbook **PQRY-P200, P250, P400, P500Y(S)GM-A**

Service Handbook **PQRY-P200, P250YGM-A**
PQRY-P400, P500YSGM-A
CMB-P104, P105, P106, P108, P1010, P1013, P1016V-G
CMB-P108, P1010, P1013, P1016V-GA
CMB-P104, P108V-GB
PQHY-P200, P250YGM-A
PQHY-P400, P500YSGM-A

 **MITSUBISHI ELECTRIC CORPORATION**

CITY MULTI

Contents

| | | |
|---|--|-----|
| 1 | Read Before Servicing | 6 |
| | [1] Items to Be Checked | 6 |
| | [2] Necessary Tools and Materials | 7 |
| | [3] Piping Materials | 8 |
| | [4] Storage of Piping Material | 10 |
| | [5] Piping Machining | 11 |
| | [6] Brazing..... | 12 |
| | [7] Airtightness Test | 13 |
| | [8] Vacuuming | 13 |
| | [9] Vacuum Drying..... | 14 |
| | [10] Changing Refrigerant..... | 15 |
| | [11] Remedies to be taken in case of a refrigerant leak..... | 15 |
| | [12] Characteristics of the Conventional and the New Refrigerants .. | 16 |
| | [13] Notes on Refrigerating Machine Oil..... | 17 |
| 2 | Restrictions | 18 |
| | [1] Electrical Work & M-NET control | 18 |
| | [2] Types of Switch Setting and Address Setting | 19 |
| | [3] Examples of system connection | 22 |
| | [4] Restrictions on Refrigerant Piping Length..... | 38 |
| 3 | Components of the Heat source Unit | 52 |
| | [1] Appearance of the Components and Refrigerant Circuit..... | 52 |
| | [2] Control Box | 57 |
| | [3] Circuit Board | 59 |
| | [4] BC controller (inside the panel) | 63 |
| | [5] BC control box | 66 |
| | [6] BC controller board | 66 |
| 4 | Remote Controller..... | 68 |
| | [1] Functions and Specifications of MA and ME Remote Controllers.... | 68 |
| | [2] Group Setting and Interlocking Settings that are Made on an ME Remote Controller..... | 69 |
| | [3] Interlocking Setting via the MA Remote Controller | 73 |
| | [4] Switching to the built-in Thermo on the remote controller..... | 76 |
| 5 | Electrical Wiring Diagram | 77 |
| | [1] PQRV-P200, P250YGM-A, PQRV-P400, P500YSGM-A | 77 |
| | [2] CMB-P104V-G | 78 |
| | [3] CMB-P105, 106V-G | 79 |
| | [4] CMB-P108, 1010V-G | 80 |
| | [5] CMB-P1013, 1016V-G | 81 |
| | [6] CMB-P104V-GB..... | 82 |
| | [7] CMB-P108V-GB..... | 83 |
| | [8] CMB-P108, 1010V-GA..... | 84 |
| | [9] CMB-P1013, 1016V-GA..... | 85 |
| | [10]Power Dispatching Extension Unit for the Transmission Lines..... | 86 |
| 6 | Refrigerant Circuit | 87 |
| | [1] Refrigerant Circuit Diagram | 87 |
| | [2] Functions of Principal Parts..... | 93 |
| | [3] BC controller | 95 |
| 7 | Control..... | 97 |
| | [1] Dip Switch Functions and Their Factory Settings | 97 |
| | [2] Controlling the Heat source Unit | 102 |
| | [3] Operation Flow Chart | 114 |

| | | |
|----|--|-----|
| 8 | Test Run | 120 |
| | [1] Check Items before Test Run..... | 120 |
| | [2] Test Run Method | 120 |
| | [3] Operating Characteristics and Refrigerant Amount..... | 121 |
| | [4] Adjustment and Judgment of Refrigerant Amount | 121 |
| | [5] Refrigerant Volume Adjustment Mode Operation | 124 |
| | [6] Symptoms that do not Signify Problems | 128 |
| | [7] Standard Operation Data (Reference Data) | 129 |
| 9 | Troubleshooting | 133 |
| | [1] Check Code List | 133 |
| | [2] Responding to Error Display on the Remote Controller | 135 |
| | [3] Investigation of Transmission Wave Shape/Noise | 170 |
| | [4] Troubleshooting of Principal Parts | 173 |
| | [5] Refrigerant Leak | 204 |
| | [6] BC controller service instruction | 208 |
| 10 | LED display | 211 |
| | [1] LED Monitor Display | 211 |

Safety Precautions

- ▶ Before installing the unit, be sure to carefully read all of the following safety precautions.
- ▶ These precautions provide important information regarding safety. Be sure to follow them to ensure safety.

Symbols used in the text

 **Warning:**

Failure to follow all instructions may result in serious personal injury or death.

 **Caution:**

Failure to follow all instructions may result in personal injury or damage to the unit.

Symbols used in the illustrations

 : Indicates an action that must be avoided.

 : Indicates that important instructions must be followed.

 : Indicates a part which must be grounded.

 : Beware of electric shock (This symbol is displayed on the main unit label.) <Color : Yellow>

- ▶ After reading this handbook, hand it over to those who will be using the unit.
- ▶ The user of the unit should keep this manual at hand and make it available to those who will be performing repairs or relocating the unit.
Also, make it available to the new user when the user changes hands.

 **Warning : Carefully read the labels affixed to the main unit.**

Have the unit professionally installed.

- Improper installation by an unqualified person may result in water leak, electric shock, or fire.

Be sure to carefully follow each step in this handbook when installing the unit.

- Improper installation may result in water leak, electric shock, smoke or fire.

Place the unit on a stable, level surface that withstands the weight of the unit to prevent the unit from tipping over or falling causing injury as a result.

Have all electrical work performed by a licensed electrician according to the local regulations and the instructions given in this manual. Secure a circuit designated exclusively to the unit.

- Improper installation or a lack of circuit capacity may cause the unit to malfunction or present a risk of electric shock, smoke, and fire.

Only use specified cables for wiring. Securely connect each cable, and make sure that the cables are not straining the terminals.

- Cables not connected securely and properly may generate heat and cause fire.

Securely attach the terminal cover (panel) on the unit.

- If installed improperly, dust and/or water may enter the unit and present a risk of electric shock, smoke, or fire.

Take necessary safety measures against typhoons and earthquakes to prevent the unit from falling over.

Do not make any changes or modifications to the unit. In case of problems, consult the dealer.

- If repairs are not made properly, the unit may leak water and present a risk of electric shock, or it may produce smoke or cause fire.

Only use Refrigerant R410A as indicated on the unit when installing or relocating the unit.

- The use of any other refrigerant or an introduction of air into the unit circuit may cause the unit to run an abnormal cycle and cause the unit to burst.

 **Warning : Carefully read the labels affixed to the main unit.**

In the event of a refrigerant gas leak, provide adequate ventilation to the room.

- If leaked refrigerant gas is exposed to a heat source, noxious gases may form.

With All-Fresh type air conditioners, outdoor air may be directly blown into the room upon thermo off. Take this into consideration when installing the unit.

- Direct exposure to outdoor air may present a health hazard, and it may also cause food items to deteriorate.

Do not try to defeat the safety features of the devices, and do not change the settings.

- Defeating the safety features on the unit such as the pressure switch and temperature switch or using parts other than those specified by Mitsubishi Electric may result in fire or explosion.

When installing the unit in a small room, safeguard against hypoxia that results from leaked refrigerant reaching the threshold level.

- Consult the dealer for necessary measures to take.

When relocating the air conditioner, consult the dealer or a specialist.

- Improper installation may result in water leak, electric shock, or fire.

After completing the service work, check for a refrigerant gas leak.

- If leaked gas refrigerant is exposed to a heat source such as fan heater, stove, and electric grill, noxious gases may form.

Only use specified parts.

- Have the unit professionally installed. Improper installation may cause water leak, electric shock, smoke, or fire.

Precautions for Handling Units for Use with R410A

 **Caution**

Do not use the existing refrigerant piping

- The old refrigerant and refrigerator oil in the existing piping contain a large amount of chlorine, which will cause the refrigerator oil in the new unit to deteriorate.
- R410A is a high-pressure refrigerant, and the use of the existing piping may result in bursting.

Use refrigerant pipes made of C1220 phosphorus deoxidized copper categorized under H3000 (Copper and Copper Alloy Seamless Pipes and Tubes), a standard set by JIS. Keep the inner and outer surfaces of the pipes clean and free of contaminants such as sulfur, oxides, dust/dirt, shaving particles, oils, and moisture.

- Contaminants inside the refrigerant piping will cause the refrigerant oil to deteriorate.

Use a vacuum pump with a reverse-flow-check valve.

- If other types of valves are used, the vacuum pump oil will flow back into the refrigerant cycle and cause the refrigerator oil to deteriorate.

Do not use the following tools that have been used with the conventional refrigerants. Prepare tools that are for exclusive use with R410A. (Gauge manifold, charging hose, gas leak detector, reverse-flow check valve, refrigerant charge base, vacuum gauge, and refrigerant recovery equipment.)

- If refrigerant and /or refrigerant oil left on these tools are mixed in with R410A, or if water is mixed with R410A, it will cause the refrigerant to deteriorate.
- Since R410A does not contain chlorine, gas-leak detectors for conventional refrigerators will not work.

 **Caution**

Store the piping to be used during installation indoors, and keep both ends of the piping sealed until immediately before brazing. (Keep elbows and other joints wrapped in plastic.)

- If dust, dirt, or water enters the refrigerant cycle, it may cause the oil in the unit to deteriorate or may cause the compressor to malfunction.

Use a small amount of ester oil, ether oil, or alkylbenzene to coat flares and flange connections.

- A large amount of mineral oil will cause the refrigerating machine oil to deteriorate.

Use liquid refrigerant to charge the system.

- Charging the unit with gas refrigerant will cause the refrigerant in the cylinder to change its composition and will lead to a drop in performance.

Do not use a charging cylinder.

- The use of charging cylinder will change the composition of the refrigerant and lead to power loss.

Exercise special care when handling the tools.

- An introduction of foreign objects such as dust, dirt, or water into the refrigerant cycle will cause the refrigerating machine oil to deteriorate.

Only use R410A refrigerant.

- The use of refrigerants containing chlorine (i.e. R22) will cause the refrigerant to deteriorate.

Before Installing the Unit

 **Warning**

Do not install the unit in a place where there is a possibility of flammable gas leak.

- Leaked gas accumulated around the unit may start a fire.

Do not use the unit to preserve food, animals, plants, artifacts, or for other special purposes.

- The unit is not designed to provide adequate conditions to preserve the quality of these items.

Do not use the unit in an unusual environment.

- The use of the unit in the presence of a large amount of oil, steam, acid, alkaline solvents, or special types of sprays may lead to a remarkable drop in performance and/or malfunction and presents a risk of electric shock, smoke, or fire.
- The presence of organic solvents, corroded gas (such as ammonia, sulfur compounds, and acid) may cause gas or water leak.

When installing the unit in a hospital, take necessary measures against noise.

- High-frequency medical equipment may interfere with the normal operation of the air conditioning unit or the air conditioning unit may interfere with the normal operation of the medical equipment.

Do not place the unit on or over things that may not get wet.

- When humidity level exceeds 80% or when the drainage system is clogged, indoor units may drip water.
- Installation of a centralized drainage system for the outdoor unit may also need to be considered to prevent water drips from the outdoor units.

Before Installing (Relocating) the Unit or Performing Electric Work

Warning

When installing or relocating the unit, make sure that no substance other than the specified refrigerant(R410A) enters the refrigerant circuit.

- Any presence of foreign substance such as air can cause abnormal pressure rise or explosion.

Caution

Ground the unit.

- Do not connect the grounding on the unit to gas pipes, water pipes, lightning rods, or the grounding terminals of telephones. Improper grounding presents a risk of electric shock, smoke, fire, or the noise caused by improper grounding may cause the unit to malfunction.

Use breakers and fuses (electrical current breaker, remote switch <switch + Type-B fuse>, molded case circuit breaker) with a proper current capacity.

- The use of large-capacity fuses, steel wire, or copper wire may damage the unit or cause smoke or fire.

Make sure the wires are not subject to tension.

- If the wires are too taut, they may break or generate heat and/or smoke and cause fire.

Do not spray water on the air conditioners or immerse the air conditioners in water.

- Water on the unit presents a risk of electric shock.

Install a breaker for current leakage at the power source to avoid the risk of electric shock.

- Without a breaker for current leakage, there is a risk of electric shock, smoke, or fire.

Periodically check the platform on which the unit is placed for damage to prevent the unit from falling.

- If the unit is left on a damaged platform, it may topple over, causing injury.

Use wires that are specified in the installation manual.

- The use of other types of wires presents a risk of electrical current leak, electric shock, smoke, or fire.

When installing draining pipes, follow the instructions in the manual, and make sure that they properly drain water so as to avoid dew condensation.

- If not installed properly, they may cause water leaks and damage the furnishings.

Exercise caution when transporting products.

- Do not try to move equipments over 20kg (approx. 44 lbs.) alone.
- Do not use the PP bands used on some packages for transportation.
- Wear protective gloves to avoid injury caused by touching the fins on the heat exchanger with bare hands.
- When using a suspension bolt to transport the heat-source unit, use a four-point suspension. A three-point suspension does not provide adequate stability and presents a risk of accidents.

Properly dispose of the packing materials.

- Things such as nails and wood pieces may be included in the package. Dispose of them properly to prevent injury.
- Plastic bags present a choking hazard to children. Tear up the plastic bags before disposing of them to prevent accidents.

Before the Test Run

 **Caution**

Turn on the unit at least 12 hours before the test run.

- Keep the unit on throughout the season. Turning the unit off during the season may cause problems.

Do not operate switches with wet hands to avoid electric shock.

Do not touch the refrigerant pipes with bare hands during and immediately after operation.

- Depending on the state of the refrigerant in the system, certain parts of the unit such as the pipes and compressor may become very cold or hot and may subject the person to frost bites or burning.

Do not operate the unit without panels and safety guards in their proper places.

- They are there to keep the users from injury from accidentally touching rotating, high-temperature, or high-voltage parts.

Do not turn off the power immediately after stopping the unit.

- Allow for at least five minutes before turning off the unit; otherwise, the unit may leak water or experience other problems.

Do not operate the unit without air filters.

- Dust particles in the air may clog the system and cause malfunction.

1 Read Before Servicing

[1] Items to Be Checked

1. Verify the type of refrigerant used by the unit to be serviced.

Refrigerant Type : R410A

2. Check the symptom exhibited by the unit to be serviced.

Look in this service handbook for symptoms relating to the refrigerant cycle.

3. Be sure to carefully read the *Safety Precautions* at the beginning of this document.

4. Prepare necessary tools: Prepare tools exclusive for use with each refrigerant type.

Refer to P7 for more information.

5. Verification of the connecting pipes: Verify the type of refrigerant used for the unit to be moved or replaced.

- Use pipes made of phosphorus deoxidized copper. Keep the inner and outer surfaces of the pipes clean and free of contaminants such as sulfur, oxides, dust/dirt, shaving particles, oils, and moisture.
- Contaminants inside the refrigerant piping will cause the refrigerant oil to deteriorate.

6. If there is a gas leak or if the remaining refrigerant is exposed to an open flame, a noxious gas hydrofluoric acid may form. Keep workplace well ventilated.



CAUTION

- 1. Install new pipes immediately after removing old ones to keep moisture out of the refrigerant circuit.**
- 2. Chloride in some types of refrigerants such as R22 will cause the refrigerating machine oil to deteriorate.**

[2] Necessary Tools and Materials

Prepare the following tools and materials necessary for installing and servicing the unit.

[Necessary tools for use with R410A (Adaptability of tools that are for use with R22 and R407C)]

1. To be used exclusively with R410A (not to be used if used with R22 or R407C)

| Tools/Materials | Use | Notes |
|------------------------------------|----------------------------------|---|
| Gauge Manifold | Evacuating, refrigerant charging | 5.09MPa on the High-pressure side. |
| Charging Hose | Evacuating, refrigerant charging | Hose diameter larger than the conventional ones. |
| Refrigerant Recovery Equipment | Refrigerant recovery | |
| Refrigerant Cylinder | Refrigerant charging | Write down the refrigerant type. Pink in color at the top of the cylinder. |
| Refrigerant Cylinder Charging Port | Refrigerant charging | Hose diameter larger than the conventional ones. |
| Flare Nut | Connecting the unit to piping | Use Type-2 Flare nuts. (That are in compliance with JIS B 8607). |

2. Tools and materials that may be used with R410A with some restrictions

| Tools/Materials | Use | Notes |
|--------------------------------|---------------------------|--|
| Gas leak detector | Detection of gas leaks | The ones for HFC type refrigerant may be used. |
| Vacuum Pump | Vacuum drying | May be used if a reverse flow check adaptor is attached. |
| Flare Tool | Flare machining of piping | Changes have been made in the flare machining dimension. Refer to the next page. |
| Refrigerant Recovery Equipment | Recovery of refrigerant | May be used if designed for use with R410A. |

3. Tools and materials that are used with R22 or R407C that can also be used with R410A

| Tools/Materials | Use | Notes |
|--------------------------------|------------------------|---|
| Vacuum Pump with a Check valve | Vacuum drying | |
| Bender | Bending pipes | |
| Torque Wrench | Tightening flare nuts | Only ϕ 12.70 (1/2") and ϕ 15.88 (5/8") have a larger flare machining dimension. |
| Pipe Cutter | Cutting pipes | |
| Welder and Nitrogen Cylinder | Welding pipes | |
| Refrigerant Charging Meter | Refrigerant charging | |
| Vacuum Gauze | Checking vacuum degree | |

4. Tools and materials that must not be used with R410A

| Tools/Materials | Use | Notes |
|-------------------|----------------------|---|
| Charging Cylinder | Refrigerant Charging | Must not be used with R410A-type units. |

Tools for R410A must be handled with special care; keep moisture and dust from entering the cycle.

[3] Piping Materials

Do not use the existing piping!

New Piping **Existing Piping**

<Types of copper pipe>

| | |
|-----------------|--|
| Type-O pipes | Soft copper pipes (annealed copper pipes) They can be bent easily with hands. |
| Type-1/2H pipes | Hard copper pipes (straight pipes) Stronger than type-O pipes of the same radial thickness. |

- The distinction between type-O and type-1/2H pipes is made based on the strength of the pipes themselves.
- Type-O pipes are soft and can easily be bent with hands.
- Type-1/2H pipes are considerably stronger than type-O pipes of the same radial thickness.

<Types of Copper Pipes (Reference)>

| | |
|----------------------------|-------------------------|
| Maximum Operation Pressure | Applicable Refrigerants |
| 3.45 MPa | R22, R407C etc. |
| 4.30 MPa | R410A |

※ Use pipes that meet the local standards.

<Piping Materials/Radial Thickness>

Use pipes made of phosphorus deoxidized copper.

Since the operation pressure of the units that use R401A is higher than that of the units for use with R22, use pipes with at least the radial thickness specified in the chart below.

(Pipes with a radial thickness of 0.7 mm or less may not be used.)

| Size(mm) | Size(inch) | Radial Thickness(mm) | Type |
|----------|------------|----------------------|----------------------|
| φ 6.35 | 1/4" | 0.8t | Type-O pipes |
| φ 9.52 | 3/8" | 0.8t | |
| φ 12.7 | 1/2" | 0.8t | |
| φ 15.88 | 5/8" | 1.0t | |
| φ 19.05 | 3/4" | 1.0t | Type-1/2H or H pipes |
| φ 22.2 | 7/8" | 1.0t | |
| φ 25.4 | 1" | 1.0t | |
| φ 28.58 | 1 1/8" | 1.0t | |
| φ 31.75 | 1 1/4" | 1.1t | |

※ Although it was possible to use type-O for pipes with a size of up to φ19.05 (3/4") with conventional refrigerants, use type-1/2H pipes for units that use R410A. (Type-O pipes may be used if the pipe size is φ19.05 and the radial thickness is 1.2t.)

※ The table shows the standards in Japan. Using this table as a reference, choose pipes that meet the local standards.

<Indication of the radial thickness and refrigerant type on the piping materials>

“Radial thickness” and “Refrigerant Types” are indicated on the insulation material on the piping materials for the new refrigerant.

Indication of the radial thickness (mm)

| Radial thickness | Symbols |
|------------------|---------|
| 0.8 | 08 |
| 1.0 | 10 |

Indication of the refrigerant type

| Refrigerant type | Symbol |
|------------------|--------|
| Type1 R22, R407C | ① |
| Type2 R410A | ② |

<Example of the symbols indicated on the insulation material>

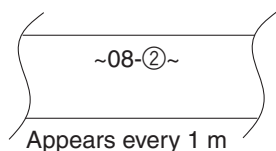

The type of piping materials can also be found on the package.

<Example of a label found on the package>

| | |
|---|-------------------------------|
| ② | : common to type 1 and type 2 |
| Refrigerant Type | : R22,R407C,R410A |
| Bore diameter and radial thickness of the copper piping | : 9.52×0.8, 15.88×1.0 |

<Flare Machining (type-O and OL only)>

The flare machining dimensions for units that use R410A is larger than those for units that use R22 in order to increase air tightness.

Flare Machining Dimension(mm)

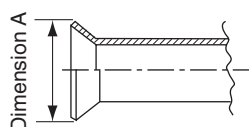

| External dimension of pipes | Size | Dimension A | |
|-----------------------------|------|-------------|------|
| | | R410A | R22 |
| φ 6.35 | 1/4" | 9.1 | 9.0 |
| φ 9.52 | 3/8" | 13.2 | 13.0 |
| φ 12.7 | 1/2" | 16.6 | 16.2 |
| φ 15.88 | 5/8" | 19.7 | 19.4 |
| φ 19.05 | 3/4" | 24.0 | 23.3 |

If a clutch type flare tool is used to machine flares on units that use R410A, make the protruding part of the pipe between 1.0 and 1.5mm. Copper pipe gauge for adjusting the length of pipe protrusion is useful.

<Flare Nut>

Type-2 flare nuts instead of type-1 s are used to increase the strength. The size of some of the flare nuts have also been changed.

Flare nut dimension(mm)

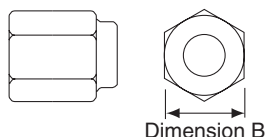

| External dimension of pipes | Size | Dimension B | |
|-----------------------------|------|--------------|------------|
| | | R410A(Type2) | R22(Type1) |
| φ 6.35 | 1/4" | 17.0 | 17.0 |
| φ 9.52 | 3/8" | 22.0 | 22.0 |
| φ 12.7 | 1/2" | 26.0 | 24.0 |
| φ 15.88 | 5/8" | 29.0 | 27.0 |
| φ 19.05 | 3/4" | 36.0 | 36.0 |

※ The table shows the standards in Japan. Using this table as a reference, choose pipes that meet the local standards.

[4] Storage of Piping Material

1. Storage location



Store the pipes to be used indoors. (Warehouse at site or owner's warehouse)
Storing them outdoors may cause dirt, waste, or water to infiltrate.

2. Pipe sealing before storage

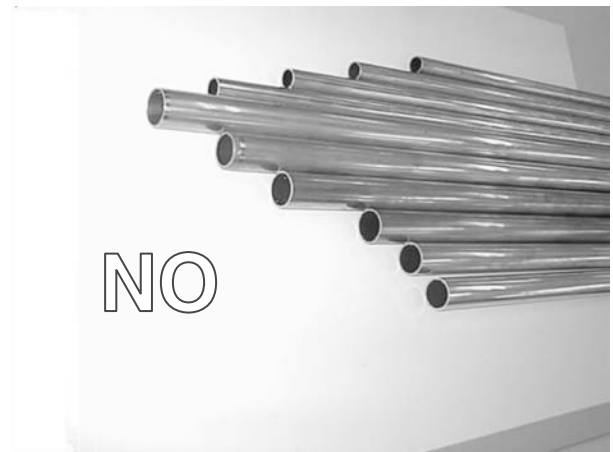
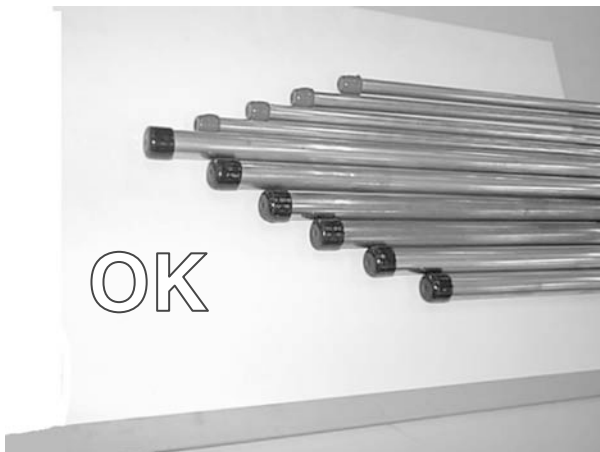

Both ends of the pipes should be sealed until immediately before brazing.
Wrap elbows and T's in plastic bags for storage.

* The new refrigerator oil is 10 times more hygroscopic than the conventional refrigerator oil (such as Suniso). Water infiltration in the refrigerant circuit may deteriorate the oil or cause a compressor failure. Piping materials must be stored with more care than with the conventional refrigerant pipes.

[5] Piping Machining

Use ester oil, ether oil or alkylbenzene (small amount) as the refrigerator oil to coat flares and flange connections.

Reason :

1. The refrigerator oil used for the equipment is highly hygroscopic and may introduce water inside.

Notes :

- Introducing a great quantity of mineral oil into the refrigerant circuit may also cause a compressor failure.
- Do not use oils other than ester oil, ether oil or alkylbenzene.

[6] Brazing

No changes from the conventional method, but special care is required so that foreign matter (ie. oxide scale, water, dirt, etc.) does not enter the refrigerant circuit.

Example : Inner state of brazed section

When non-oxide brazing was not used

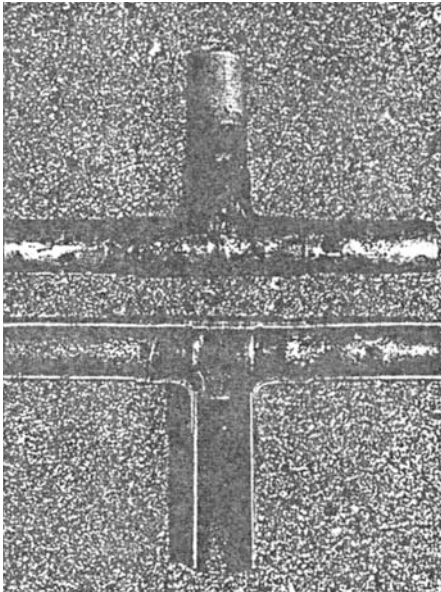

When non-oxide brazing was used

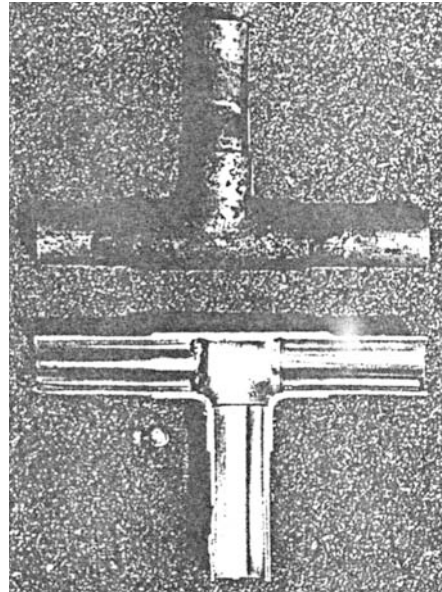

Items to be strictly observed :

1. Do not conduct refrigerant piping work outdoors on a rainy day.
2. Apply non-oxide brazing.
3. Use a brazing material (BCuP-3) which requires no flux when brazing between copper pipes or between a copper pipe and copper coupling.
4. If installed refrigerant pipes are not immediately connected to the equipment, then braze and seal both ends of them.

Reasons :

1. The new refrigerant oil is 10 times more hygroscopic than the conventional oil. The probability of a machine failure if water infiltrates is higher than with conventional refrigerant oil.
2. A flux generally contains chlorine. A residual flux in the refrigerant circuit may generate sludge.

Note :

- Commercially available antioxidants may have adverse effects on the equipment due to its residue, etc. When applying non-oxide brazing, use nitrogen.

[7] Airtightness Test

No changes from the conventional method. Note that a refrigerant leakage detector for R22 or R407C cannot detect R410A leakage.

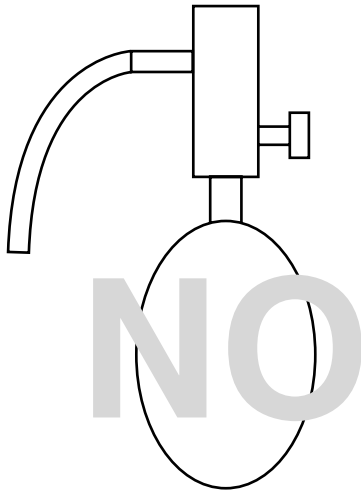

Halide torch

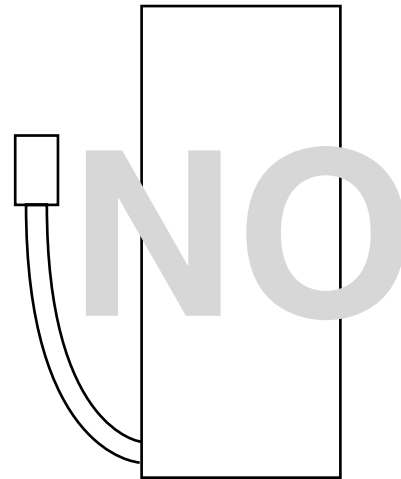

R22 or R407C leakage detector

Items to be strictly observed :

1. Pressurize the equipment with nitrogen up to the design pressure and then judge the equipment's airtightness, taking temperature variations into account.
2. When investigating leakage locations using a refrigerant, be sure to use R410A.
3. Ensure that R410A is in a liquid state when charging.

Reasons :

1. Use of oxygen as the pressurized gas may cause an explosion.
2. Charging with R410A gas will lead the composition of the remaining refrigerant in the cylinder to change and this refrigerant can then not be used.

Note :

- A leakage detector for R410A is sold commercially and it should be purchased.

[8] Vacuuming

1. Vacuum pump with check valve

A vacuum pump with a check valve is required to prevent the vacuum pump oil from flowing back into the refrigerant circuit when the vacuum pump power is turned off (power failure).

It is also possible to attach a check valve to the actual vacuum pump afterwards.

2. Standard degree of vacuum for the vacuum pump

Use a pump which reaches 650Pa or below after 5 minutes of operation.

In addition, be sure to use a vacuum pump that has been properly maintained and oiled using the specified oil. If the vacuum pump is not properly maintained, the degree of vacuum may be too low.

3. Required accuracy of the vacuum gauge

Use a vacuum gauge that can measure up to 650Pa. Do not use a general gauge manifold since it cannot measure a vacuum of 650Pa.

4. Evacuating time

- Evacuate the equipment for 1 hour after 650Pa has been reached.
- After evacuating, leave the equipment for 1 hour and make sure the that vacuum is not lost.

5. Operating procedure when the vacuum pump is stopped

In order to prevent a backflow of the vacuum pump oil, open the relief valve on the vacuum pump side or loosen the charge hose to draw in air before stopping operation.

The same operating procedure should be used when using a vacuum pump with a check valve.

[9] Vacuum Drying



Photo 1 15010H



Photo 2 14010

Recommended vacuum gauge : ROBINAIR 14010 Thermistor Vacuum Gauge

1. Vacuum pump with reverse-flow check valve (Photo 1)

To prevent vacuum pump oil from flowing back into the refrigerant circuit upon turning off the vacuum pump's power source, use a vacuum pump equipped with a reverse flow check valve. A check valve may also be added to the vacuum pump currently in use.

2. Standard of vacuum degree (Photos 1 and 2)

Use a vacuum pump that shows a vacuum degree of 65Pa or less after 5 minutes of operation. Use a pump well-maintained with an appropriate lubricant.

3. Required precision of vacuum gauge

Use a vacuum gauge that registers a vacuum degree of 650Pa and measures at intervals of 130Pa. (A recommended vacuum gauge is shown in Photo 2.)

Do not use a vacuum gauge that does not register a vacuum degree of 650Pa.

4. Evacuation time

- After the vacuum gauge has registered the vacuum degree of 650Pa, evacuate for 1 hour. (A thorough vacuum drying removes moisture in the pipes.)
- Verify that the vacuum degree has not risen by more than 130Pa 1 hour after evacuation. A rise by less than 130Pa is acceptable.
- If it has exceeded by more than 130Pa, conduct vacuuming following the instructions in the "6. Special vacuum drying" section.

5. Procedures for stopping vacuum pump

To prevent the reverse flow of vacuum pump oil, open the relief valve on the vacuum pump side, or draw in air by loosening the charge hose, and then stop the operation.

The same procedures should be followed when stopping a vacuum pump with a reverse-flow check valve.

6. Special vacuum drying

- When 650Pa or lower degree of vacuum cannot be attained after 3 hours of evacuation, it is likely that water has penetrated the system or that there is a leak. When water infiltration is suspected, vacuum with nitrogen gas. After breaking the vacuum, pressurize the system with nitrogen gas to a degree of 0.05MPa, and conduct an evacuation again. Repeat it until 650Pa or lower degree of vacuum is attained or the vacuum pressure rise will be lost.
- Only use nitrogen gas for vacuum breaking. (Use of oxygen may cause an explosion.)

[10] Changing Refrigerant

R410A must be in a liquid state when charging.

For a cylinder with a syphon attached

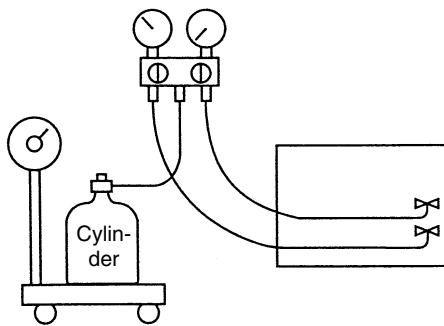

For a cylinder without a syphon attached

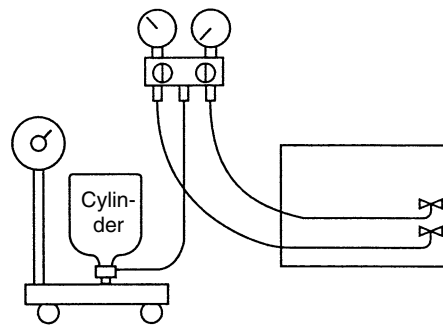

Cylinder color identification

R407C-Gray
R410A-Pink

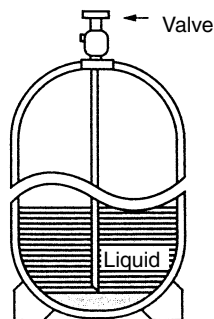

Charged with liquid refrigerant

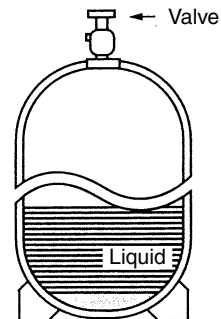

Reasons :

1. R410A is a pseudo-azeotropic refrigerant (boiling point R32 = -52°C , R125 = -49°C) and can roughly be handled in the same way as R22; however, be sure to fill the refrigerant from the liquid side, for doing so from the gas side will somewhat change the composition of the refrigerant in the cylinder.

Note :

- In the case of a cylinder with a syphon, liquid R410A is charged without turning the cylinder up side down. Check the type of cylinder before charging.

[11] Remedies to be taken in case of a refrigerant leak

When refrigerant leaks, additional refrigerant may be charged. (Add the refrigerant from the liquid side.)

*Refer to [9]-[5].

[12] Characteristics of the Conventional and the New Refrigerants

1. Chemical property

As with R22, the new refrigerant (R410A) is low in toxicity and a chemically stable non-flammable refrigerant. However, because the specific gravity of steam is greater than that of air, leaked refrigerant in a closed room will accumulate at the bottom of the room and may cause hypoxia. Also, leaked refrigerant exposed directly to an open flame will generate noxious gasses. Use the unit in a well-ventilated room.

| | New Refrigerant (HFC system) | | Conventional Refrigerant (HCFC system) |
|---|----------------------------------|----------------------------|---|
| | R410A | R407C | R22 |
| | R32/R125 | R32/R125/R134a | R22 |
| Composition (wt%) | (50/50) | (23/25/52) | (100) |
| Type of refrigerant | Simulated azeotropic refrigerant | Non-azeotropic refrigerant | Single refrigerant |
| Chloride | Not contained | Not contained | Contained |
| Safety Class | A1/A1 | A1/A1 | A1 |
| Molecular Weight | 72.6 | 86.2 | 86.5 |
| Boiling Point | -51.4 | -43.6 | -40.8 |
| Steam Pressure (25°C,MPa)(gauge) | 1.557 | 0.9177 | 0.94 |
| Saturated Steam Density (25°C,kg/m ³) | 64.0 | 42.5 | 44.4 |
| Flammability | Non-flammable | Non-flammable | Non-flammable |
| Ozone Depletion Coefficient (ODP)*1 | 0 | 0 | 0.055 |
| Global Warming Coefficient (GWP)*2 | 1730 | 1530 | 1700 |
| Refrigerant charging method | Liquid charging | Liquid charging | Gas charging |
| Addition of refrigerant in case of a leak | Possible | Possible | Possible |

*1: When CFC11 is used as a reference *2: When CO₂ is used as a reference

2. Refrigerant Composition

Because R410A is a simulated azeotropic refrigerant, it can be handled in almost the same manner as a single refrigerant such as R22. However, if the refrigerant is removed in the vapor phase, the composition of the refrigerant in the cylinder will somewhat change.

Remove the refrigerant in the liquid phase. Additional refrigerant may be added in case of a refrigerant leak.

3. Pressure Characteristics

The pressure in the units that use R410A is 1.6 times as great as that in the units that use R22.

| Temperature (°C) | Pressure (gauge) | R410A | R407C | R22 |
|------------------|------------------|-------|-------|------|
| | | MPa | MPa | MPa |
| -20 | | 0.30 | 0.18 | 0.14 |
| 0 | | 0.70 | 0.47 | 0.40 |
| 20 | | 1.34 | 0.94 | 0.81 |
| 40 | | 2.31 | 1.44 | 1.44 |
| 60 | | 3.73 | 2.44 | 2.33 |
| 65 | | 4.17 | 2.75 | 2.60 |

[13] Notes on Refrigerating Machine Oil

1. Refrigerating Machine Oil in the HFC Refrigerant System

HFC type refrigerants use a refrigerating machine oil different from that used in the R22 refrigerant system. Please note that the ester oil sealed in the unit is not the same as commercially available ester oil.

| Refrigerant | Refrigerating machine oil |
|-------------|---------------------------|
| R22 | Mineral oil |
| R407C | Ester oil |
| R410A | Ester oil |

2. Effects of the *Contaminants in the System

Refrigerating machine oil used in the HFC system must be handled more carefully than conventional mineral oils. The table below shows the effects of air, moisture, and contaminants in the refrigerating machine oil on the refrigeration cycle.

<The Effects of Air, Moisture, and Contaminants in the Refrigerating Machine Oil on the Refrigeration Cycle.>

| Cause | | Symptom | Effects on the refrigeration cycle |
|------------------------------|------------------|--|--|
| Water infiltration | | Expansion valve and capillary freeze | Clogged expansion valve and capillary Poor cooling performance |
| | | Hydrolysis | Compressor overheat Poor motor insulation Motor burning Coppering of the orbiting part Locking Burning in the orbiting part |
| Air infiltration | | Oxidization | |
| Infiltration of contaminants | Dust, dirt | Adhesion to expansion valve and capillary | Expansion valve/capillary Poor cooling performance Drier clogging Compressor overheat |
| | | Infiltration of contaminants into the compressor | Burning in the orbiting part |
| | Mineral oil etc. | Sludge formation and adhesion | Expansion valve and capillary clogging Poor cooling performance Compressor overheat |
| | | Oil degradation | Burning in the orbiting part |

* "Contaminants" is defined as moisture, air, process oil, dust/dirt, the wrong types of refrigerant and refrigerating machine oil.

2 Restrictions

[1] Electrical Work & M-NET control

1. Attention

- ① Follow ordinance of your governmental organization for technical standard related to electrical equipment, wiring regulations, and guidance of each electric power company.
- ② Wiring for control (hereinafter referred to as transmission line) shall be (5cm or more) apart from power source wiring so that it is not influenced by electric noise from power source wiring. (Do not insert transmission line and power source wire in the same conduit.)
- ③ Be sure to provide designated grounding work to heat source unit.
- ④ Give some allowance to wiring for electrical part box of indoor and heat source unit, because the box is sometimes removed at the time of service work.
- ⑤ Never connect 380~415V(220~240V) power source to terminal block of transmission line. If connected, electrical parts will be burnt out
- ⑥ Use 2-core shield cable for transmission line. If transmission lines of different systems are wired with the same multiple-core cable, the resultant poor transmitting and receiving will cause erroneous operations.

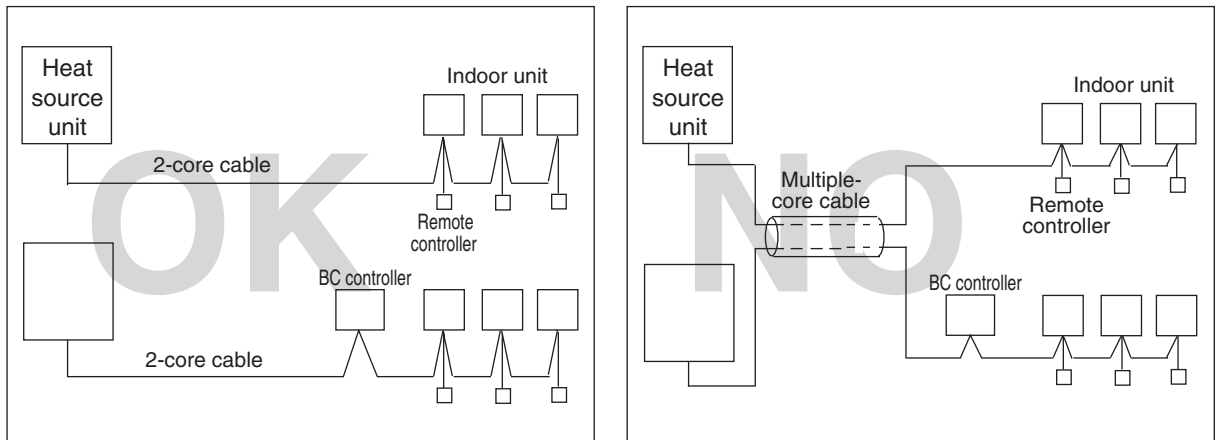

* The BC controller is connected to WR2 and R2 systems.

2. Types of control cable

| | Transmission cables | M-NET Remote controller cables | MA Remote controller cables |
|----------------|---|--|---|
| Type of cable | Shielding wire (2-core) CVVS,CPEVS or MVVS | Sheathed 2-core cable (unshielded) CVV | |
| Cable diameter | More than 1.25mm ² | 0.3 ~ 1.25mm ² (0.75 ~ 1.25mm ²) *1 | 0.3 ~ 1.25mm ² (0.75 ~ 1.25mm ²) *1 |
| Remarks | — | When 10m is exceeded, use cables with the same specification as transmission cables. | Max length : 200m |

*1 Connected with simple remote controller.

CVVS,MVVS : PVC insulated PVC jacketed shielded control cable

CPEVS : PE insulated PVC jacketed shielded communication cable

CVV : PV insulated PVC sheathed control cable

[2] Types of Switch Setting and Address Setting

1. Switch setting

Type and method of switch setting

Switch setting vary depending on the system configuration. Make sure to read “[3] Examples of system connection” before conducting electrical work. Turn off the power before setting the switch. Operating the switch while the unit is being powered will not change the setting, and the unit will not properly function.

2. Address setting

(1) Address setting varies depending on the system configuration. See “[3] Examples of system connection” section for details.

| Unit or controller | | Address setting range | Setting method | Factory setting |
|----------------------------|---------------------------------|---|--|-----------------|
| Indoor unit | Main/sub units | 0, 01~50 (Note 1) | Assign the smallest address to the indoor unit to become the main unit within the same group, and then use sequential numbers to assign an address to all the indoor units in the group. (Note 5) If applicable, set the sub BC controllers in an R2 system in the following order: (1) Indoor unit to be connected to the main BC controller (2) Indoor unit to be connected to No.1 sub BC controller (3) Indoor unit to be connected to No.2 sub BC controller Set the address so that (1) < (2) < (3) | 00 |
| | Lossnay | | Assign any unused address after setting all indoor units. | 00 |
| M-NET remote controller | Main remote controller | 101~150 | Set to the lowest address of the indoor main unit within the same group + 100. | 101 |
| | Sub remote controller | 151~200 (Note 2) | Set to the lowest address of the indoor main unit within the same group + 150. | |
| MA remote controller | | No address setting required. (When operating with 2 remote controllers, the main/sub selector switch must be set. | | Main |
| Outdoor (Heat source) unit | | 0, 51~100 (Note 1, 3, 4) | Use the address that equals the sum of the smallest indoor unit address in the same refrigerant system and 50. | 00 |
| Auxiliary units | BC controller (Main) | 52~100 (Note 3, 4) | Use the address that equals the sum of the address of the heat source unit in the same refrigerant system and 1. | |
| | BC controller (Sub) | | Use the address that equals the sum of the smallest address of the indoor unit out of all the indoor units that are connected to the BC controller and 50. When a sub BC controller is connected, the automatic start up function will not be available. | |
| System controller | Group remote controller | 201~250 | Set to the lowest No. of the group to be controlled + “200.” | 201 |
| | System remote controller | 201~250 | Choose any number within the range of addresses shown left. | 201 |
| | ON/OFF remote controller | 201~250 | Set to the lowest No. of the group desired to be controlled + “200.” | 201 |
| | Schedule timer (for M-NET) | 201~250 | Choose any number within the range of addresses shown left. | 202 |
| | Centralized controller (Note 5) | 0, 201~250 | Choose any number within the range of addresses shown left. However when using with the upper SC setting, or wishing to control the k-control units, set to “0.” | 000 |
| | LM adapter | 201~250 | Choose any number within the range of addresses shown left. | 247 |

Notes:

- Address setting is not required for a single refrigerant system (with a few exception).
- When setting M-NET remote controller address to “200,” make it “00.”
- When setting the heat source unit and outdoor auxiliary unit address to “100,” make it “50.”
- When an address in a system overlapped with the heat source unit or BC controller (Main) address of other refrigerant system, choose an another address within the set range that is not in use (with a few exceptions).
- When controlling the K-control units;
 - A K-transmission converter (Model name: PAC-SC25KA) is required. To set the address for the K-transmission converter, set it to the lowest address of the K-control unit to be controlled + 200.
 - Set the address of the system controller (G-50A) to “0.” The K-control unit can only be controlled by the system controller with the address “0.”
 - To control both K-control unit and M-NET model unit, make the address of the K-control unit larger than that of the indoor unit of M-NET model.
Group-register on the system controller so that the group No. and the lowest address of the K-controlled indoor units belonging to the group will be identical.
- BC controller is found only in the R2 and WR2 systems.

(2) Setting the power supply selecting connector for outdoor unit (Heat source unit)
(Factory setting: CN41 is connected.)

| System configuration | Connection with the system controller | Power supply unit for transmission lines | Grouping operation of different | The setting of the power supply selecting connector |
|-----------------------------|--|--|---------------------------------|--|
| Single-refrigerant system | – | – | – | Use CN41 as is. (Factory setting) |
| Multiple-refrigerant system | n/a | – | n/a | Disconnect the male connector from the female power supply switch connector (CN41) and connect it to the female power supply switch connector (CN40) on only one of the outdoor units. (Note 3) Connect the S (shielded) terminal on the terminal block (TB7) on the outdoor (Heat source) unit whose CN41 was replaced with CN40 to the earth terminal (⌚) on the electric box. |
| | With connection to the indoor-outdoor transmission line | Unnecessary | applicable | |
| | With connection to the transmission line for centralized control | Unnecessary (Note 2) (Power supplied from outdoor (Heat source) unit) | applicable//n/a | applicable//n/a |
| | | | applicable | applicable//n/a |

(Note 1) The total number of connectable units in the refrigerant system will be limited. Refer to DATA BOOK.

(Note 2) The need for a power supply unit for transmission lines depends on the system configuration. Refer to DATA BOOK.

(Note 3) When connecting a system controller to the transmission line for centralized control or performing a group operation of units in different refrigerant systems, the replacement of male power supply switch connector (CN41) must be performed only on one of the heat source units in the system.

(If a model between 34 and 50 HP is included in the system, replace the connector on that unit.)

(3) Settings for the centralized control switch on the outdoor (heat source) unit
(Factory setting: SW2-1 set to "OFF")

| System configuration | Switch setting for centralized control (SW2-1) |
|---|--|
| Connection with the system controller : n/a | Leave it to OFF.(Factory setting) |
| Connection with the system controller : applicable (Note 1) | ON |

(Note 1) When only the LM adapter is connected, leave SW2-1 to OFF (as it is).

(4) Indoor unit port switch setting (R2/WR2 series (Factory Setting: "0"))

Make the settings for the port switch that corresponds to the connected BC (Main/Sub) controller.

When more than two ports are used, make the setting on the port with a smaller port number.

The total capacity and the number of connectable indoor units per port is 90 and below, and 3 respectively.

(5) Selecting the position of temperature detection for the indoor unit (Factory setting: SW1-1 set to "OFF".)

① To use the built-in sensor on the remote controller, set the SW1-1 to ON.

*Some models of remote controllers are not equipped with a built-in temperature sensor.

Use the built-in temperature sensor on the indoor unit instead.

*When using the built-in sensor on the remote controller, install the remote controller where room temperature can be detected.

(Note) Factory setting for SW1-1 on the indoor unit of the All-Fresh Models (PEFY-P, M-E-F, PFFY-P, RM-E-F) is ON.

② When an optional temperature sensor is used, set SW1-1 to OFF, and set SW3-8 to ON.

*When using an optional temperature sensor, install it where room temperature can be detected.

(6) Various start-stop controls (Indoor unit settings)

Each indoor unit (or group of indoor units) can be controlled individually by setting SW 1-9 and 1-10.

| Function | Operation of the indoor unit when the operation is resumed after the unit was stopped | Setting (SW1) (Note 4) | |
|---|---|------------------------|-----|
| | | 9 | 10 |
| Power ON/OFF by the plug (Note 1, 2, 3) | Indoor unit will go into operation regardless of its operation status before power off (power failure). (In approx. 5 minutes) | OFF | ON |
| Automatic restoration after power failure | Indoor unit will go into operation if it was in operation when the power was turned off (or cut off due to power failure). (In approx. 5 minutes) | ON | OFF |
| | Indoor unit will remain stopped regardless of its operation status before power off (power failure). | OFF | OFF |

(Note 1) Do not cut off power to the outdoor (Heat source) unit.

Cutting off the power supply to the outdoor (Heat source) unit will cut off the power supply to the crankcase heater and may cause the compressor to malfunction when the unit is put back into operation.

(Note 2) Not applicable to units with a built-in drain pump or humidifier

(Note 3) Models with a built-in drain pump cannot be turned on/off by the plug individually. All the units in the same refrigerant circuits will be turned on or off by the plug.

(Note 4) Requires that the dipswitch settings for all the units in the group be made.

(7) Miscellaneous settings

Cooling-only setting for the indoor unit: Cooling only model (Factory setting: SW3-1 "OFF".)

When using indoor unit as a cooling-only unit, set SW3-1 to ON.

(8) Various types of control using input-output signal connector on the heat source unit (Connection options)

| Signal type | Usage | Function | Terminal |
|-------------|--|---|----------|
| Input | Prohibiting cooling/heating operation (thermo OFF) by an external input to the heat source unit. *Can be used as a demand control function for each refrigerant system. | Compressor ON/OFF (level) | CN3D |
| | Performs a low-noise-level operation of the outdoor unit by an external input to the heat source unit. (The unit can perform a night mode operation under the following conditions: Outdoor air temperature below 30°C during cooling operation/Outdoor air temperature above 3°C during heating operation.) | Night mode or step demand (level) (Note 1) | |
| | Forces the heat source unit to stop by receiving a contact signal from the pump interlock circuit. | Pump interlock signal input (level) | TB8 |
| Output | How to extract signals from the heat source unit. *Can be used as an operation status display device. *Can be used for an interlock operation with external devices. | Operation status of the compressor | CN51 |
| | | Error status or freeze prevention output (Note 2) | |
| | | Operation-ON signal (Note 3) | TB8 |

(Note 1) The night mode function is enabled when Dip SW 4-7 is set to OFF.
When Dip SW4-7 are set to ON, step demand control is possible, using different configurations of night mode input and Compressor ON/OFF input settings.

SW4-7:OFF (Compressor ON/OFF, Night mode)

| CN3D 1-3P | Compressor ON/OFF |
|-----------|-------------------|
| Open | ON |
| Short | OFF |

| CN3D 1-2P | Night mode |
|-----------|------------|
| Open | OFF |
| Short | ON |

SW4-7:ON (Step demand)

| CN3D 1-3P \ CN3D 1-2P | Open | Short |
|-----------------------|------|------------------|
| | Open | 100% (No demand) |
| Short | 0% | 50% |

Note the following steps to be taken when using the STEP DEMAND

(Example) When switching from 100% to 50%

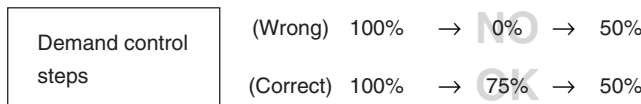

If the step listed as the wrong example above is taken, thermo may go off.
The percentage of the demand listed in the table above is an approximate value based on the compressor volume and does not necessarily correspond with the capacity.

(Note 2) Error status output function on the heat source unit is enabled when Dip SW3-3 is set to OFF.
When Dip SW3-3 is set to ON, signal is output when heat source unit is stopped and water temperature (TH6) goes below 5°C.

(Note 3) Operation-ON signal is output while the compressor is in operation if Dip SW2-7 is set to OFF.
If Dip SW2-7 is set to OFF, signal is output while receiving cooling or heating operation signal from the remote controller.
(Signal output is continued even if the compressor comes to a stop due to Thermo OFF.)

Terminals

■CN51

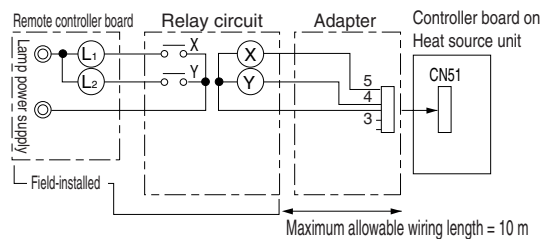

L1 : Error indicator lamp/freeze prevention output
L2 : Compressor operation display lamp
X,Y : Relay (For 12V DC coil rating 0.9 W or below)

■CN3D

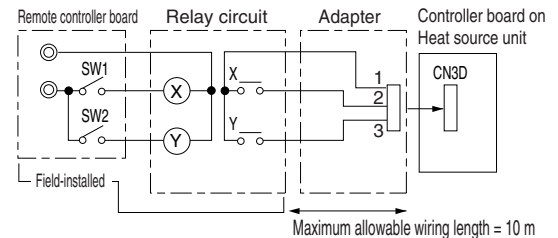

SW1 : Night mode command or step command
SW2 : Compressor ON/OFF command
X,Y : Relay (Contact Minimum applied load 12V DC 1 mA)

■TB8

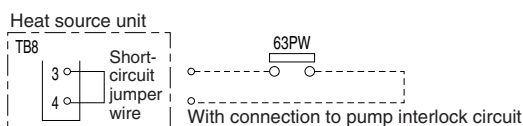

Remove the jumper wire when pump interlock circuit signal connection is made to 3 or 4 of TB8.
63PW:Pressure switch (Contact: Minimum applied load 5 mA)

■TB8

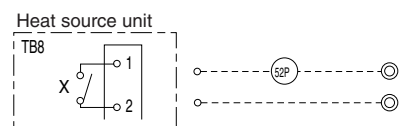

X : Relay (Contact rating 219~240V AC 1 A)
52P : Contactor for pump

[3] Examples of system connection

1. System using MA remote controller

(1) In the case of single refrigerant system (Automatic address set-up)

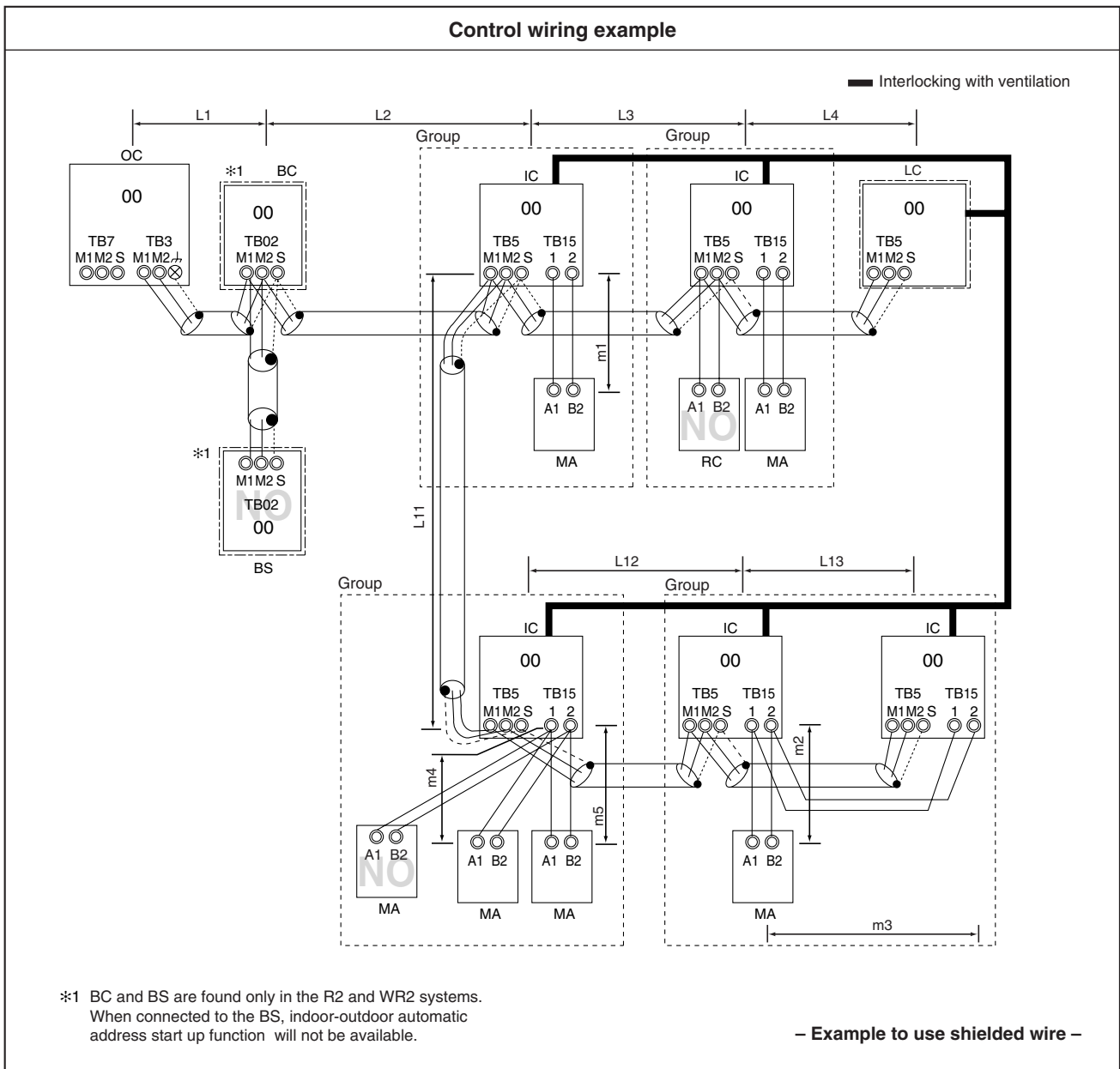

Prohibited items

1. M-NET and MA remote controllers can not be connected together to the indoor unit within the same group.
2. MA remote controller of 3 units or more can not be connected to the indoor unit within the same group.
3. When the total number of indoor units exceeds 26 units including that above Type 200, a transmission booster is required. When the transmission booster is used, BC and BS cannot be connected to TB3 (indoor unit side) on the transmission booster.
4. In the case when start/stop input (CN32, CN51, CN41) is used by indoor group operation, the "Automatic address set-up" can not be employed. Please refer to 1. (2) "Manual address set-up."
5. For the connection of LOSSNAY with more than 2 units in a single refrigerant system, refer to the following "Connection of 2 LOSSNAY units in refrigerant system."

Allowable length

- a. Indoor/outdoor transmission line**
Farthest length (1.25mm² or more)
 $L1 + L2 + L3 + L4 \leq 200\text{m}$
 $L1 + L2 + L11 + L12 + L13 \leq 200\text{m}$
- b. Centralized control transmission line**
No connection is required.
- c. MA remote controller wiring**
Total length (0.3 ~ 1.25mm²)
 $m1 \leq 200\text{m}$
 $m2 + m3 \leq 200\text{m}$
 $m4 + m5 \leq 200\text{m}$

Wiring method • Address setting method

a. Indoor/outdoor transmission line

Daisy-chain the M1 and M2 terminals of the indoor-outdoor transmission terminal block (TB3) on the outdoor (heat source) unit (OC), M1 and M2 terminals of the indoor-outdoor transmission line terminal block (TB02) on the BC controller (BC), and M1 and M2 terminals of the indoor-outdoor transmission line terminal block (TB5) on each indoor unit. (with non-polarity two wires)

※ When the transmission line is long or noise sources are located near the unit, recommend to use shielded wire.

Connection of shielded wire:

For the earth of shielded wire, apply jumper wiring connection between the earth screw of OC and the S-terminal of IC terminal block (TB5).

b. Centralized control transmission line

Connection is not required.

c. MA remote controller wiring

Connect the 1, 2 terminals of MA remote controller wiring terminal block (TB15) on IC to the terminal block of MA remote controller (MA). (with non-polarity two wires)

※ MA remote controller can be connected to A-type indoor unit or later.

For 2-remote controller operation:

To employ 2-remote controller operation, connect 1, 2 terminals of the terminal block (TB15) on IC to the terminal block of two MA remote controllers.

※ Set the main/sub selector switch of one MA remote controller to the sub remote controller. (For the setting method, see the installation manual of MA remote controller.)

For indoor group operation:

For the group operation of IC, connect 1, 2 terminals of the terminal block (TB15) on all ICs within the same group, and connect 1, 2 terminals of the terminal block (TB15) on another IC to the terminals of MA remote controller. (with non-polarity two wires)

※ To operate the indoor units with different function in the same group, refer to 1. (2).

d. LOSSNAY connection

Apply jumper wiring to connect M1, M2 terminals of the terminal block (TB5) on IC to the indoor/outdoor transmission terminal block (TB5) on LOSSNAY (LC). (with non-polarity two wires)

※ Linked and registered automatically with all indoor units within a refrigerant system.

※ Please refer to the 1. (2) "Manual address set-up," when interlocking partial indoor units with Lossnay, using Lossnay alone without interlocking, interlocking indoor units and Lossnay for over 16 units within a refrigerant system, or connecting LOSSNAY for over 2 units in a refrigerant system.

e. Switch setting

Address setting is not required.

| Order | Unit or controller | | | Address setting range | Setting method | Caution | Factory setting |
|-------|----------------------------|---------------|----|-----------------------|------------------------------------|--|-----------------|
| 1 | Indoor unit | Main unit | IC | Not required | - | <ul style="list-style-type: none"> • Branch number setting is required by R2 and WR2 systems. • Refer to 1. (2) to operate indoor units with different function in the same group. | 00 |
| | | Sub unit | IC | | | | |
| 2 | LOSSNAY | | LC | Not required | - | | 00 |
| 3 | MA remote controller | Main unit | MA | Not required | - | | Main |
| | | Sub unit | MA | Sub unit | Set with main/sub selector switch. | | |
| 4 | Outdoor (Heat source) unit | | OC | Not required | - | | 00 |
| 5 | Auxiliary units | BC controller | BC | | | | |

1. System using MA remote controller

(2) In the case of single refrigerant system connecting 2 or more LOSSNAY units (Manual address set-up)

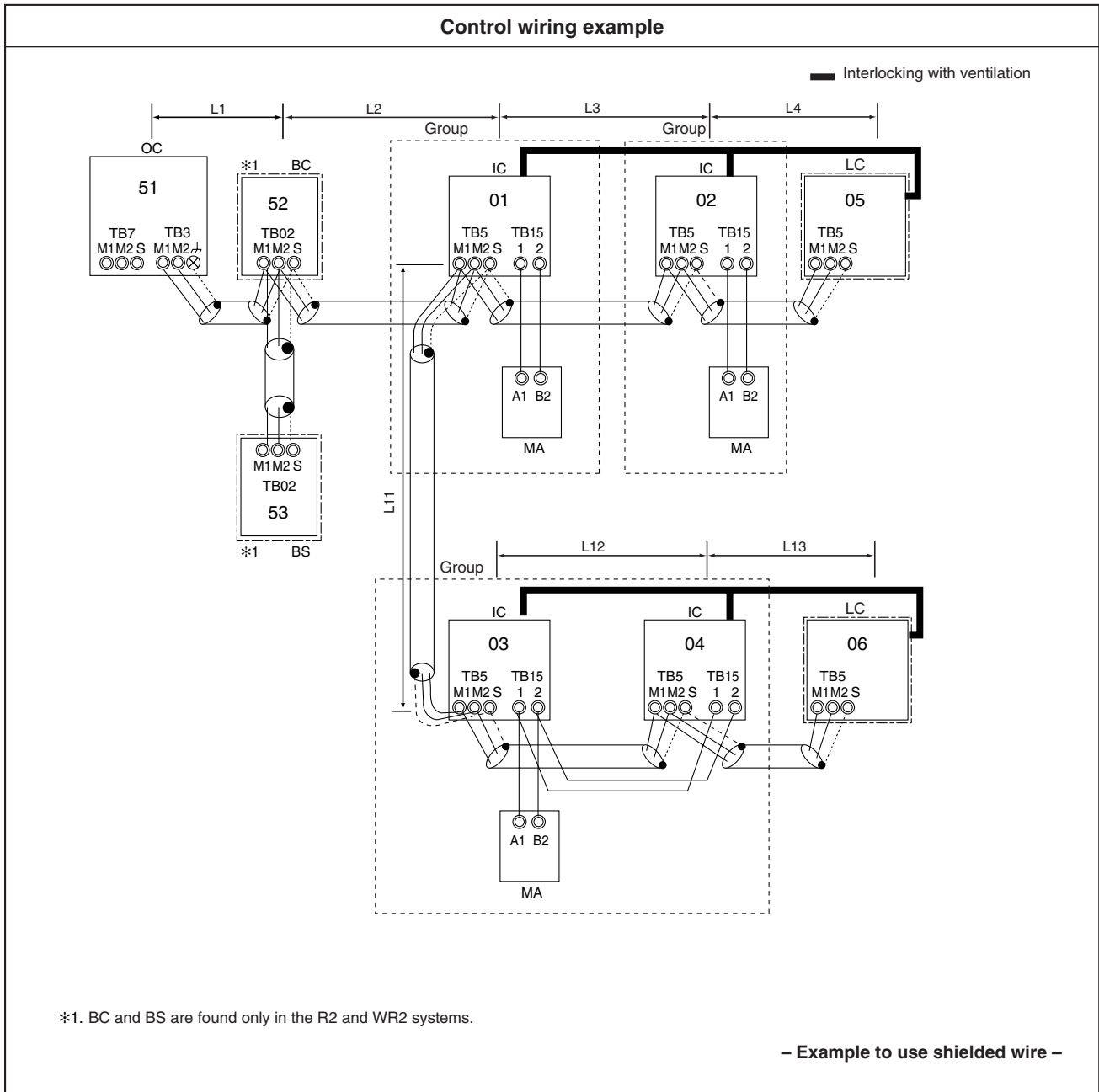

| Prohibited items | Allowable length |
|---|---|
| <ol style="list-style-type: none"> 1. M-NET and MA remote controllers can not be connected together to the indoor unit within the same group. 2. MA remote controller of 3 units or more can not be connected to the indoor unit within the same group. 3. When the total number of indoor units exceeds 26 units including that above Type 200, a transmission booster is required. When the transmission booster is used, BC and BS cannot be connected to TB3 (indoor unit side) on the transmission booster. | <ol style="list-style-type: none"> a. Indoor/outdoor transmission line The same as 1. (1) b. Centralized control transmission line No connection is required. c. MA remote controller wiring The same as 1. (1) |

Wiring method • Address setting method

a. Indoor/outdoor transmission line The same as 1. (1)

Connection of shielded wire: The same as 1. (1)

b. Centralized control transmission line

No connection is required.

c. MA remote controller wiring The same as 1. (1)

For 2-remote controller operation: The same as 1. (1)

For indoor group operation: The same as 1. (1)

d. LOSSNAY connection

Apply jumper wiring to connect M1, M2 terminals of the terminal block (TB5) on the indoor unit (IC) to the terminal block (TB5) on Lossnay (LC). (with non-polarity two wires)

※ The interlocking registration of the indoor unit and Lossnay from the remote controller is required. (For the registration method, see the installation manual of remote controllers.)

e. Switch setting

Address setting is required as listed below.

| Order | Unit or controller | | Address setting range | Setting method | Caution | Factory setting | |
|-------|----------------------------|----------------------|-----------------------|----------------|--|---|----|
| 1 | Indoor unit | Main unit | IC | 01 ~ 50 | <ul style="list-style-type: none"> • Set the lowest address within a same group to the indoor unit desired to be the main unit. • The address of the indoor unit connected to the sub BC controller must be larger than that of the indoor unit connected to the main BC controller. • If applicable, set the sub BC controllers in an R2 system in the following order: (1) Indoor unit to be connected to the main BC controller (2) Indoor unit to be connected to No.1 sub BC controller (3) Indoor unit to be connected to No.2 sub BC controller Set the address so that (1) < (2) < (3) | <ul style="list-style-type: none"> • When operating indoor units with different function within a same group, assign the indoor unit with the most plenty of function to the main unit. • Requires a branch-number setting. | 00 |
| | | Sub unit | | | | | |
| 2 | LOSSNAY | | LC | 01 ~ 50 | Set any address after setting all indoor units. | <ul style="list-style-type: none"> • Set the address not to be overlapped with the indoor unit address. | 00 |
| 3 | MA remote controller | Main unit | MA | Not required | - | Main | |
| | | Sub unit | MA | Not required | Set with main/sub selector switch. | | |
| 4 | Outdoor (Heat source) unit | | OC | 51 ~ 100 | The lowest address of indoor unit within refrigerant system + 50 | <ul style="list-style-type: none"> • To set the address to "100," set it to "50". • If the address of main BC controller overlaps with the address of the outdoor (heat source) unit or the sub BC controller, use an unused address within the setting range. • The use of a sub BC controller requires a main BC controller. | 00 |
| 5 | Auxiliary units | BC Controller (sub) | BS | 52 ~ 100 | Use the address that equals the sum of the smallest indoor unit address out of all the indoor units that are connected to the sub BC controller and 50. | 00 | |
| | | BC Controller (main) | BC | | Outdoor (Heat source) unit address +1 | | |

1. System using MA remote controller

(3) In the case of different refrigerant grouping operation

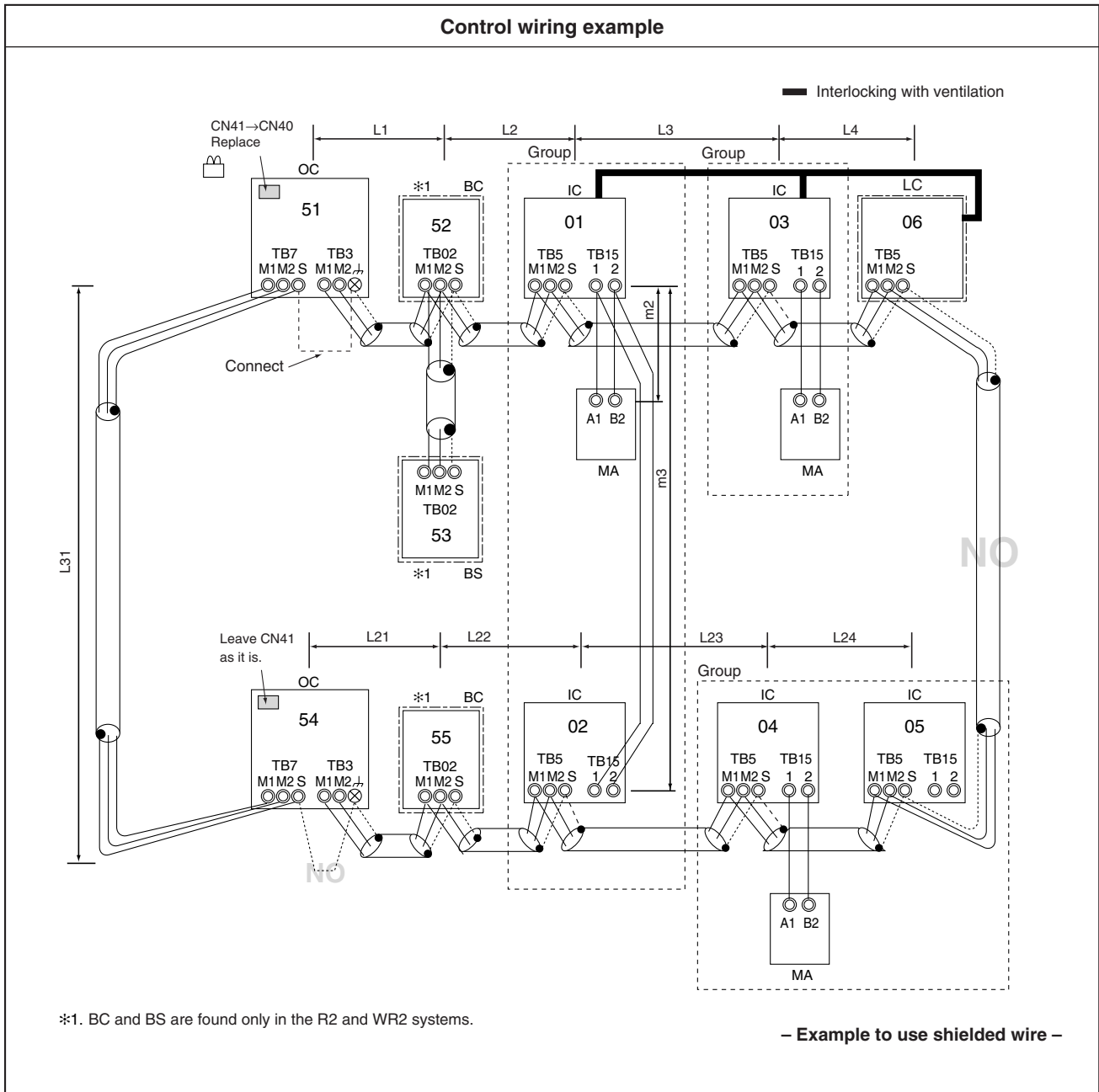

| Prohibited items | Allowable length |
|---|---|
| <ol style="list-style-type: none"> 1. M-NET and MA remote controllers can not be connected together to the indoor unit within the same group. 2. MA remote controller of 3 units or more can not be connected to the indoor unit within the same group. 3. Do not connect together the terminal blocks (TB5) of the indoor unit connected to different outdoor (heat source) units. 4. Replacement of the power supply selecting connector (CN41) on the outdoor (heat source) unit should be done only on one outdoor (heat source) unit. 5. Grounding of S-terminal of the centralized control terminal block (TB7) on outdoor (heat source) unit should be done only on one outdoor (heat source) unit. 6. When the total number of indoor units exceeds 26 units including that above Type 200, a transmission booster is required. When the transmission booster is used, BC and BS cannot be connected to TB3 (indoor unit side) on the transmission booster. | <ol style="list-style-type: none"> a. Indoor/outdoor transmission line Farthest length (1.25mm² or more) $L1 + L2 + L3 + L4 \leq 200\text{m}$ $L21 + L22 + L23 + L24 \leq 200\text{m}$ b. Centralized control transmission line Farthest length via outdoor (heat source) unit (1.25mm² or more) $L1 + L2 + L3 + L4 + L31 + L21 + L22 + L23 + L24 \leq 500\text{m}$ c. MA remote controller wiring The same as 1. (1) |

Wiring method · Address setting method

a. Indoor/outdoor transmission line

Daisy-chain the M1 and M2 terminals of the indoor-outdoor transmission terminal block (TB3) on the outdoor (heat source) unit (OC), M1 and M2 terminals of the indoor-outdoor transmission line terminal block (TB02) on the BC controller (BC), and M1 and M2 terminals of the indoor-outdoor transmission line terminal block (TB5) on each indoor unit. (with non-polarity two wires)

※ Make sure to use shielded wire.

Connecting of shielded wire: The same as 1. (1)

b. Centralized control transmission line

Apply jumper wiring between M1, M2 terminals of centralized control transmission line terminal blocks (TB7) on each OC. For one OC only, replace the power selecting connector (CN41) with (CN40).

※ Make sure to use shielded wire.

Connecting of shielded wire:

Apply jumper wiring to connect the shielded earth to S-terminal of the terminal block (TB7) on each OC. Connect S-terminal of the terminal block (TB7) on the one OC with (CN40) replaced to the earth screw (⌋) of the electrical parts box.

c. MA remote controller wiring The same as 1. (1)

For 2-remote controller operation: The same as 1. (1)

For indoor unit group operation: The same as 1. (2)

d. LOSSNAY connection The same as 1. (2)

e. Switch setting Address setting is required as follows.

| Order | Unit or controller | | Address setting range | Setting method | Caution | Factory setting | |
|-------|----------------------------|----------------------|-----------------------|----------------|--|---|------|
| 1 | Indoor unit | Main unit | IC | 01 ~ 50 | <ul style="list-style-type: none"> Set the lowest address within a same group to the indoor unit desired to be the main unit. The address of the indoor unit connected to the sub BC controller must be larger than that of the indoor unit connected to the main BC controller. If applicable, set the sub BC controllers in an R2 system in the following order: <ol style="list-style-type: none"> Indoor unit to be connected to the main BC controller Indoor unit to be connected to No.1 sub BC controller Indoor unit to be connected to No.2 sub BC controller Set the address so that (1) < (2) < (3) | <ul style="list-style-type: none"> When operating indoor units with different function within a same group, assign the indoor unit with the most plenty of function to the main unit. Requires a branch-number setting. | 00 |
| | | Sub unit | | | | | |
| 2 | LOSSNAY | | LC | 01 ~ 50 | Set any address after setting all indoor units. | <ul style="list-style-type: none"> Set the address not to be overlapped with the indoor unit address. | 00 |
| 3 | MA remote controller | Main unit | MA | Not required | — | | Main |
| | | Sub unit | MA | Not required | Set with main/sub selector switch. | | |
| 4 | Outdoor (Heat source) unit | | OC | 51 ~ 100 | The lowest address of indoor unit within refrigerant system + 50 | <ul style="list-style-type: none"> To set the address to “100,” set it to “50”. If the address of main BC controller overlaps with the address of the outdoor (heat source) unit or the sub BC controller, use an unused address within the setting range. The use of a sub BC controller requires a main BC controller. | 00 |
| 5 | Auxiliary units | BC Controller (sub) | BS | 52 ~ 100 | Use the address that equals the sum of the smallest indoor unit address out of all the indoor units that are connected to the sub BC controller and 50. | | |
| | | BC Controller (main) | BC | | Outdoor (Heat source) unit address +1 | | |

1. System using MA remote controller

(4) In the case of connecting system controller to centralized control transmission line

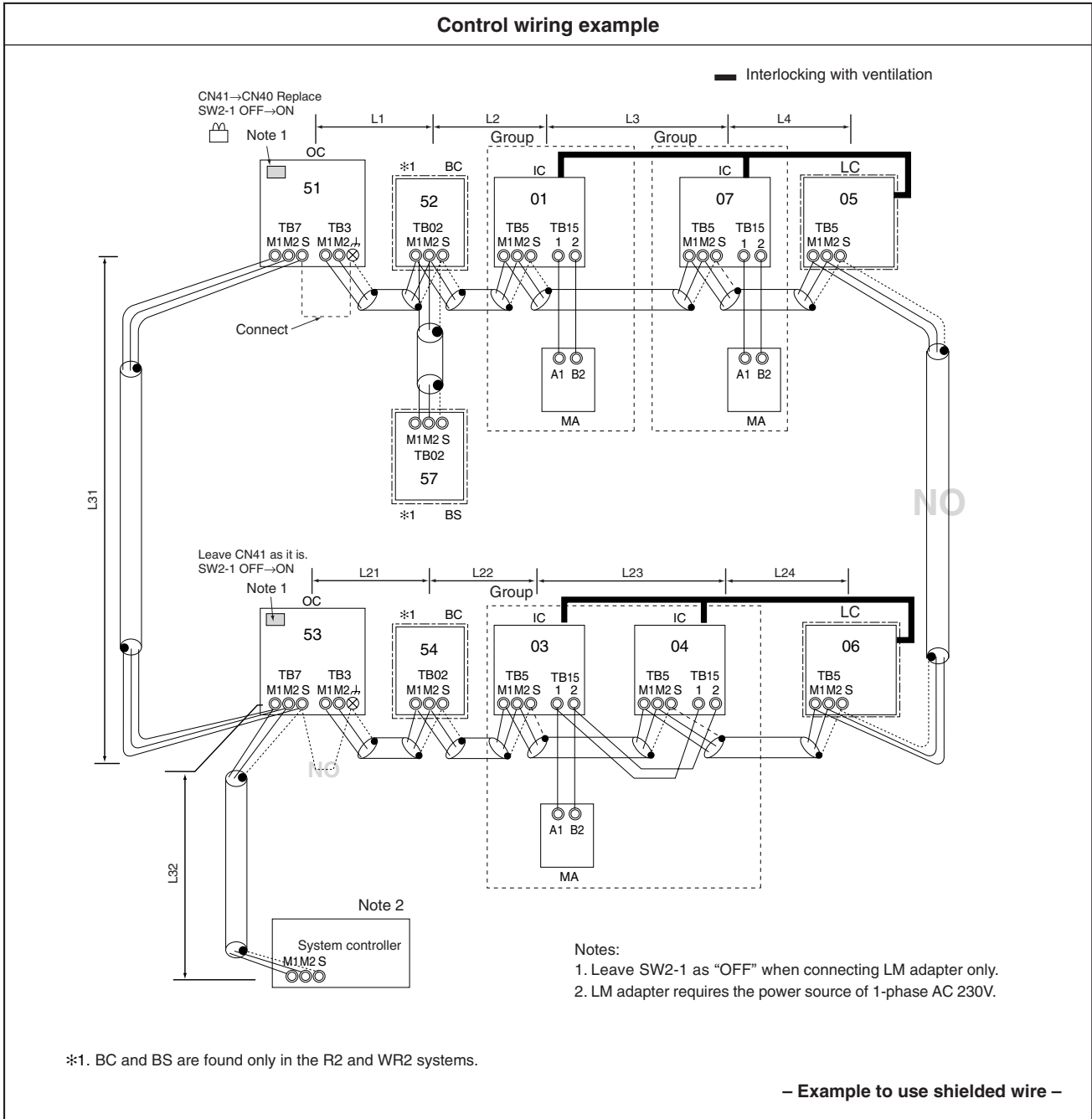

| Prohibited items | Allowable length |
|--|--|
| <ol style="list-style-type: none"> 1. M-NET and MA remote controllers can not be connected together to the indoor unit within the same group. 2. MA remote controller of 3 units or more can not be connected to the indoor unit within the same group. 3. Do not connect together the terminal blocks (TB5) of the indoor unit connected to different outdoor (heat source) units. 4. Replacement of the power supply selecting connector (CN41) on the outdoor (heat source) unit should be done only on one outdoor (heat source) unit. 5. Grounding work is required for S-terminal of the centralized control transmission block (TB7) on one outdoor (heat source) unit only. 6. When the total number of indoor units exceeds 26 units including that above Type 200, a transmission booster is required. When the transmission booster is used, BC and BS cannot be connected to TB3 (indoor unit side) on the transmission booster. | <ol style="list-style-type: none"> a. Indoor/outdoor transmission line The same as 1. (3) b. Centralized control transmission line Farthest length via outdoor (heat source) unit (1.25mm² or more) <ul style="list-style-type: none"> L32 + L31 + L1 + L2 + L3 + L4 ≤ 500m L32 + L21 + L22 + L23 + L24 ≤ 500m L1 + L2 + L3 + L4 + L31 + L21 + L22 + L23 + L24 ≤ 500m c. MA remote controller wiring The same as 1. (1) |

Wiring method · Address setting method

- a. Indoor/outdoor transmission line** The same as 1. (3)
Connection of shielded wire: The same as 1. (1)
- b. Centralized control transmission line**
 Apply jumper wiring between M1, M2 terminals of centralized control transmission line terminal blocks (TB7) on each OC. On one OC only, replace the power selecting connector (CN41) with (CN40). Set the centralized control switch (SW2-1) on the main board of all outdoor (heat source) units to "ON."
 ※ Make sure to use shielded wire.
Connection of shielded wire:
 Apply jumper wiring to connect the shielded earth to S-terminal of the terminal block (TB7) on each OC. Connect S-terminal of the terminal block (TB7) on one OC with (CN40) connected to the earth screw (⌋) of the electrical parts box.
- c. MA remote controller wiring** The same as 1. (1)
For 2-remote controller operation: The same as 1. (1)
For indoor group operation: The same as 1. (1)
- d. LOSSNAY connection**
 Apply jumper wiring to connect M1, M2 terminals of the terminal block (TB5) on (IC) to the terminal block (TB5) on the indoor/outdoor transmission line terminal block (TB5) on Lossnay (LC). (with non-polarity two wires)
 ※ The interlocking registration of the indoor unit and LOSSNAY from the system controller is required. (For the registration method, see the installation manual of the system remote controllers.) When connecting ON/OFF remote controller and LM adaptor only, the interlocking registration from the remote controller is required.
- e. Switch setting**
 Address setting is required as listed below.

| Order | Unit or controller | | Address setting range | Setting method | Caution | Factory setting | |
|-------|----------------------------|----------------------|-----------------------|----------------|---|---|------|
| 1 | Indoor unit | Main unit | IC | 01 ~ 50 | <ul style="list-style-type: none"> • Set the lowest address within a same group to the indoor unit desired to be the main unit. • The address of the indoor unit connected to the sub BC controller must be larger than that of the indoor unit connected to the main BC controller. • If applicable, set the sub BC controllers in an R2 system in the following order: (1) Indoor unit to be connected to the main BC controller (2) Indoor unit to be connected to No.1 sub BC controller (3) Indoor unit to be connected to No.2 sub BC controller Set the address so that (1) < (2) < (3) | <ul style="list-style-type: none"> • When operating indoor units with different function within a same group, assign the indoor unit with the most plenty of function to the main unit. • Requires a branch-number setting. | 00 |
| | | Sub unit | | | | | |
| 2 | LOSSNAY | | LC | 01 ~ 50 | Set any address after setting all indoor units. | • Set the address not to be overlapped with the indoor unit address. | 00 |
| 3 | MA remote controller | Main unit | MA | Not required | - | | Main |
| | | Sub unit | MA | Not required | Set with main/sub selector switch. | | |
| 4 | Outdoor (Heat source) unit | | OC | 51 ~ 100 | The lowest address of indoor unit within refrigerant system + 50 | <ul style="list-style-type: none"> • To set the address to "100," set it to "50". • If the address of main BC controller overlaps with the address of the outdoor (heat source) unit or the sub BC controller, use an unused address within the setting range. • The use of a sub BC controller requires a main BC controller. | 00 |
| 5 | Auxiliary units | BC Controller (sub) | BS | 52 ~ 100 | Use the address that equals the sum of the smallest indoor unit address out of all the indoor units that are connected to the sub BC controller and 50. | | |
| | | BC Controller (main) | BC | | Outdoor (Heat source) unit address +1 | | |

1. System using MA remote controller

(5) Connecting (multiple) BC controllers in R2 and WR2 systems (with the system controller connected to the transmission lines for centralized control)

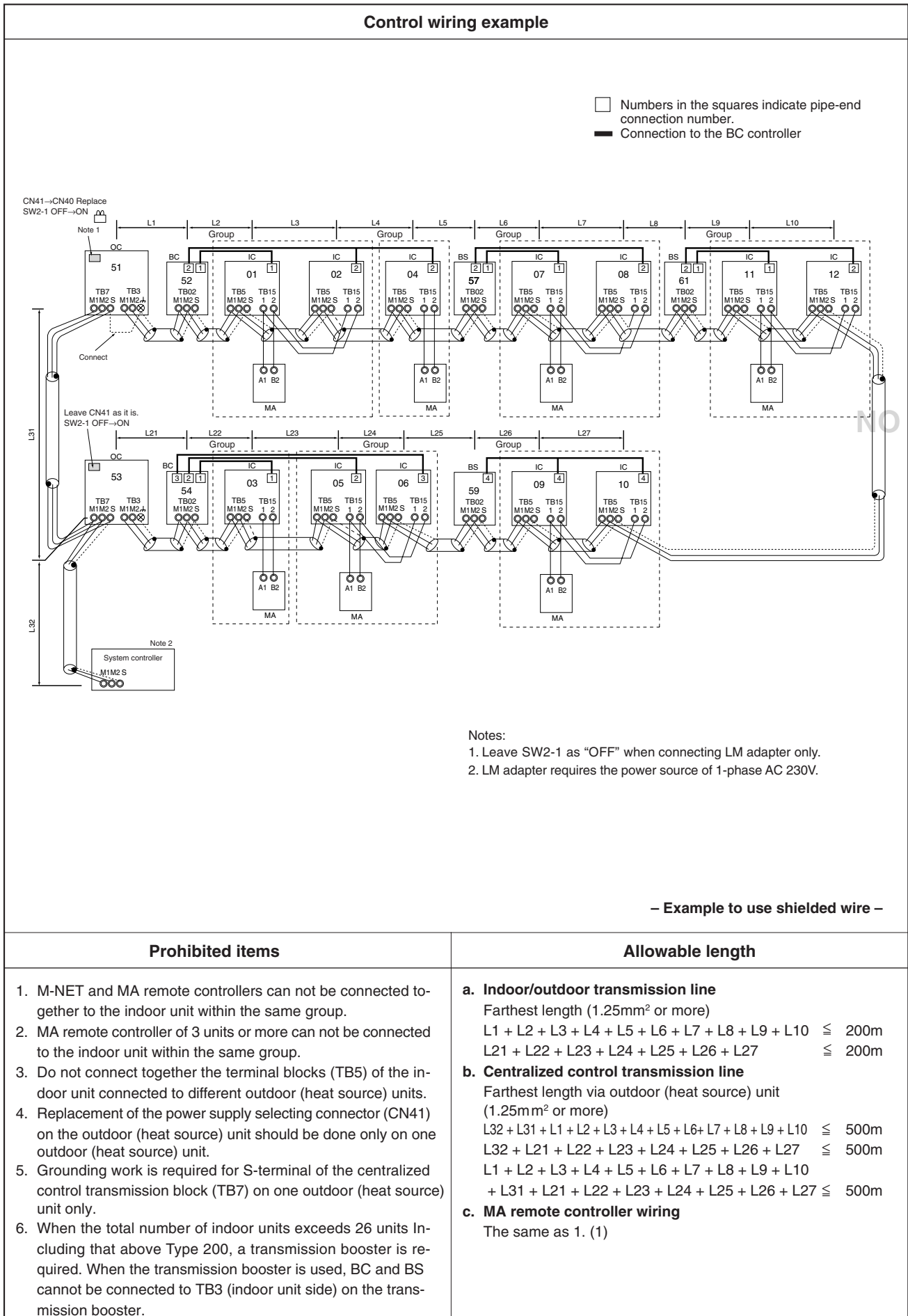

Wiring method • Address setting method

a. Indoor/outdoor transmission line

Connect terminals M1 and M2 of the indoor-outdoor transmission line terminal block (TB3) on the outdoor (heat source) unit (OC) to the terminals M1 and M2 of the indoor-outdoor transmission terminal block (TB02) of the main BC controller (BC) and the sub BC controller (BS) and terminals M1 and M2 of the indoor-outdoor transmission terminal block (TB5) on each indoor unit (IC).

※ Make sure to use shielded wire.

Connection of shielded wire: The same as 1. (1)

b. Centralized control transmission line The same as 1. (4)

Connection of shielded wire The same as 1. (4)

c. MA remote controller wiring The same as 1. (1)

For 2-remote controller operation: The same as 1. (1)

For indoor group operation: The same as 1. (1)

d. LOSSNAY connection The same as 1. (4)

e. Switch setting Address setting is required as listed below.

| Order | Unit or controller | | | Address setting range | Setting method | Caution | Factory setting |
|-------|----------------------------|----------------------|----|-----------------------|---|---|-----------------|
| 1 | Indoor unit | Main unit | IC | 01 ~ 50 | <ul style="list-style-type: none"> • Assign the smallest address within the group to the indoor unit to become the main unit. • The address of the indoor unit connected to the sub BC controller must be larger than that of the indoor unit connected to the main BC controller. • If applicable, set the sub BC controllers in an R2 system in the following order: (1) Indoor unit to be connected to the main BC controller (2) Indoor unit to be connected to No.1 sub BC controller (3) Indoor unit to be connected to No.2 sub BC controller Set the address so that (1) < (2) < (3) | <ul style="list-style-type: none"> • R2 and WR2 types require a branch number setting. | 00 |
| | | Sub unit | | | | | |
| 2 | LOSSNAY | | LC | 01 ~ 50 | Set any address after setting all indoor units. | <ul style="list-style-type: none"> • Set the address not to be overlapped with the indoor unit address. | 00 |
| 3 | MA remote controller | Main unit | MA | Not required | - | <ul style="list-style-type: none"> • Using the system controller, make the same indoor group setting that was made with the MA remote controller. | Main |
| | | Sub unit | MA | Sub unit | Set with main/sub selector switch. | | |
| 4 | Outdoor (Heat source) unit | | OC | 51 ~ 100 | The lowest address of indoor unit within refrigerant system + 50 | <ul style="list-style-type: none"> • To set the address to "100," set it to "50". • If the address of main BC controller overlaps with the address of the outdoor (heat source) unit or the sub BC controller, use an unused address within the setting range. • The use of a sub BC controller requires a main BC controller. | 00 |
| 5 | Auxiliary units | BC Controller (sub) | BS | 52 ~ 100 | Use the address that equals the sum of the smallest indoor unit address out of all the indoor units that are connected to the sub BC controller and 50. | <ul style="list-style-type: none"> • The use of a sub BC controller requires a main BC controller. | 00 |
| | | BC Controller (main) | BC | | Outdoor (Heat source) unit address +1 | | |

1. System using MA remote controller

(6) In the case of connecting system controller to indoor/outdoor transmission line (excluding LM adaptor)

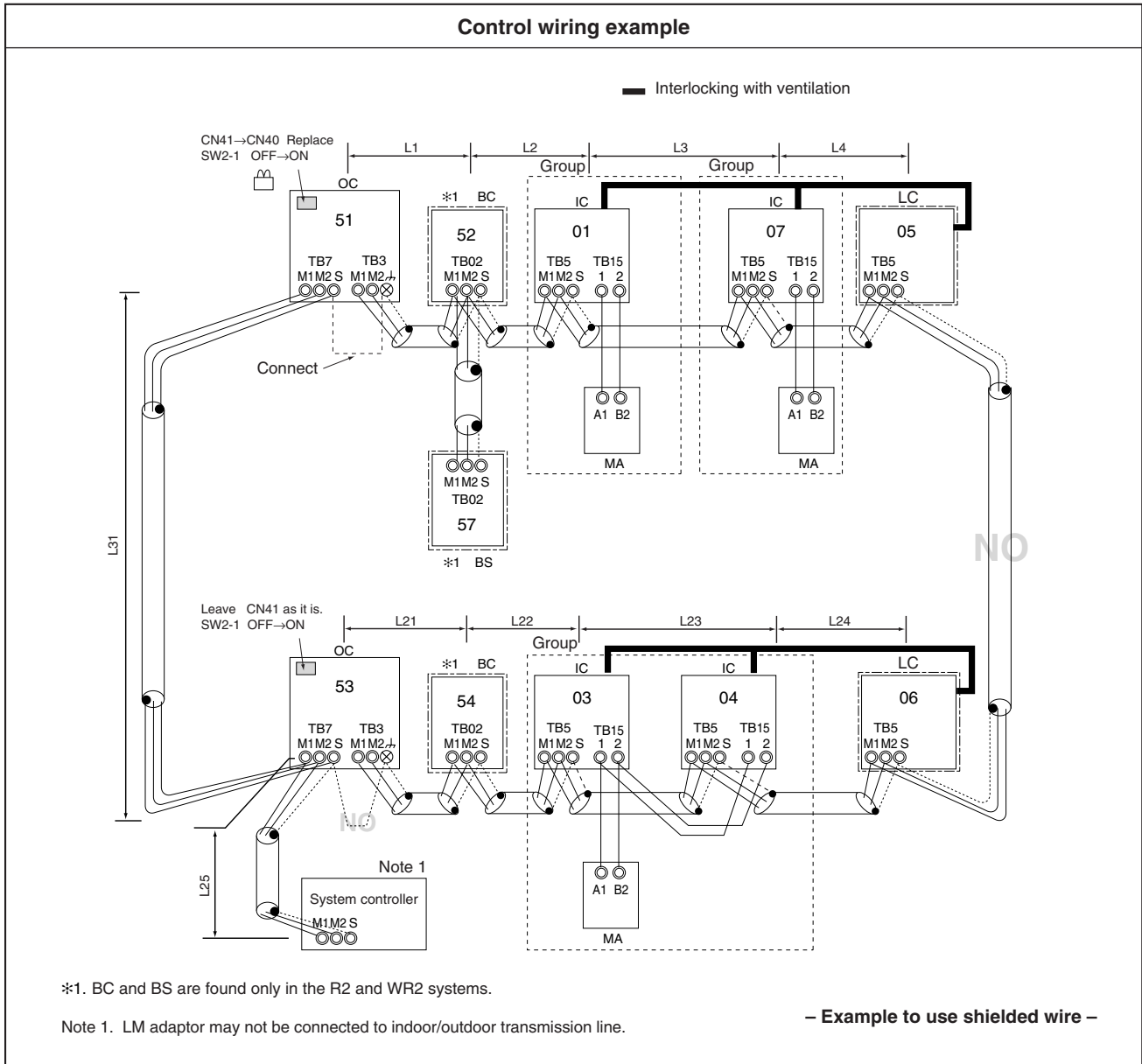

| Prohibited items | Allowable length |
|--|---|
| <ol style="list-style-type: none"> 1. M-NET and MA remote controllers can not be connected together to the indoor unit within the same group. 2. MA remote controller of 3 units or more can not be connected to the indoor unit within the same group. 3. Do not connect together the terminal blocks (TB5) of the indoor unit connected to different outdoor (heat source) units. 4. Replacement of the power supply selecting connector (CN41) on the outdoor (heat source) unit should be done only on one outdoor (heat source) unit. 5. Grounding work is required for S-terminal of the centralized control transmission block (TB7) on one outdoor (heat source) unit only. 6. The system controller connectable to the indoor/outdoor transmission line counts for 3 sets maximum. While G-50 counts for only 1 set 7. When the total number of indoor units exceeds 26 sets, the system controller may not be connected to the indoor/outdoor transmission line. 8. When the total number indoor units exceed 18 sets and they includes Type 200 or above, the system controller may not be connected to the indoor/outdoor transmission line. | <ol style="list-style-type: none"> a. Indoor/outdoor transmission line Farthest length (1.25mm² or more) $L1 + L2 + L3 + L4 \leq 200\text{m}$ $L21 + L22 + L23 + L24 \leq 200\text{m}$ $L25 \leq 200\text{m}$ b. Centralized control transmission line Farthest length via outdoor (heat source) unit (1.25mm² or more) $L25 + L31 + L1 + L2 + L3 + L4 \leq 500\text{m}$ $L1 + L2 + L3 + L4 + L31 + L21 + L22 + L23 + L24 \leq 500\text{m}$ c. MA remote controller wiring The same as 1. (1) |

Wiring method • Address setting method

a. Indoor/outdoor transmission line

Daisy-chain the M1 and M2 terminals of the indoor-outdoor transmission terminal block (TB3) on the outdoor (heat source) unit (OC), M1 and M2 terminals of the indoor-outdoor transmission line terminal block (TB02) on the BC controller (BC), and M1 and M2 terminals of the indoor-outdoor transmission line terminal block (TB5) on each indoor unit. (with non-polarity two wires)

※ Make sure to use shielded wire.

Connection of shielded wire:

For the grounding of shielded wire, apply jumper wiring between the grounding screw of OC, S-terminal of the terminal block (TB3), and S-terminal of the system controller.

b. Centralized control transmission line

Apply jumper wiring between M1, M2 terminals of centralized control transmission line terminal blocks (TB7) on each OC. On one OC only, replace the power selecting connector (CN41) with (CN40). Set the centralized control switch (SW2-1) on the main board of all outdoor (heat source) units to "ON."

※ Make sure to use shielded wire.

Connection of shielded wire:

Apply jumper wiring to connect the shielded earth to S-terminal of the terminal block (TB7) on each OC. Connect S-terminal of the terminal block (TB7) on one OC with (CN40) connected to the earth screw (⌋) of the electrical parts box.

c. MA remote controller wiring

The same as 1. (1)

For 2-remote controller operation: The same as 1. (1)

For indoor unit group operation: The same as 1. (2)

d. LOSSNAY connection

Apply jumper wiring to connect M1, M2 terminals of the terminal block (TB5) on (IC) to the terminal block (TB5) on the indoor/outdoor transmission line terminal block (TB5) on Lossnay (LC). (with non-polarity two wires)

※ The interlocking registration of the indoor unit and Lossnay is required from the system controller. (For the registration method, see the instruction manual of system controller.)

To connect ON/OFF remote controller only, interlocking registration from the remote controller is required.

e. Switch setting

Address setting is required as follows.

| Order | Unit or controller | | Address setting range | Setting method | Caution | Factory setting | |
|-------|----------------------------|----------------------|-----------------------|----------------|--|---|------|
| 1 | Indoor unit | Main unit | IC | 01 ~ 50 | <ul style="list-style-type: none"> Set the lowest address within a same group to the indoor unit desired to be the main unit. The address of the indoor unit connected to the sub BC controller must be larger than that of the indoor unit connected to the main BC controller. If applicable, set the sub BC controllers in an R2 system in the following order: <ol style="list-style-type: none"> Indoor unit to be connected to the main BC controller Indoor unit to be connected to No.1 sub BC controller Indoor unit to be connected to No.2 sub BC controller Set the address so that (1) < (2) < (3) | <ul style="list-style-type: none"> When operating indoor units with different function within a same group, as-sign the indoor unit with the most plenty of function to the main unit. Requires a branch-number setting. | 00 |
| | | Sub unit | | | | | |
| 2 | LOSSNAY | | LC | 01 ~ 50 | Set any address after setting all indoor units. | <ul style="list-style-type: none"> Set the address not to be overlapped with the indoor unit address. | 00 |
| 3 | MA remote controller | Main unit | MA | Not required | - | | Main |
| | | Sub unit | MA | Not required | Set with main/sub selector switch. | | |
| 4 | Outdoor (Heat source) unit | | OC | 51 ~ 100 | The lowest address of indoor unit within refrigerant system + 50 | <ul style="list-style-type: none"> To set the address to "100," set it to "50". | 00 |
| 5 | Auxiliary units | BC Controller (sub) | BS | 52 ~ 100 | Use the address that equals the sum of the smallest indoor unit address out of all the indoor units that are connected to the sub BC controller and 50. | <ul style="list-style-type: none"> If the address of main BC controller overlaps with the address of the outdoor (heat source) unit or the sub BC controller, use an unused address within the setting range. The use of a sub BC controller requires a main BC controller. | |
| | | BC Controller (main) | BC | | Outdoor (Heat source) unit address +1 | | |

2. System Using the M-NET Remote Controller

(1) System with the system controller connected to the transmission lines for centralized control

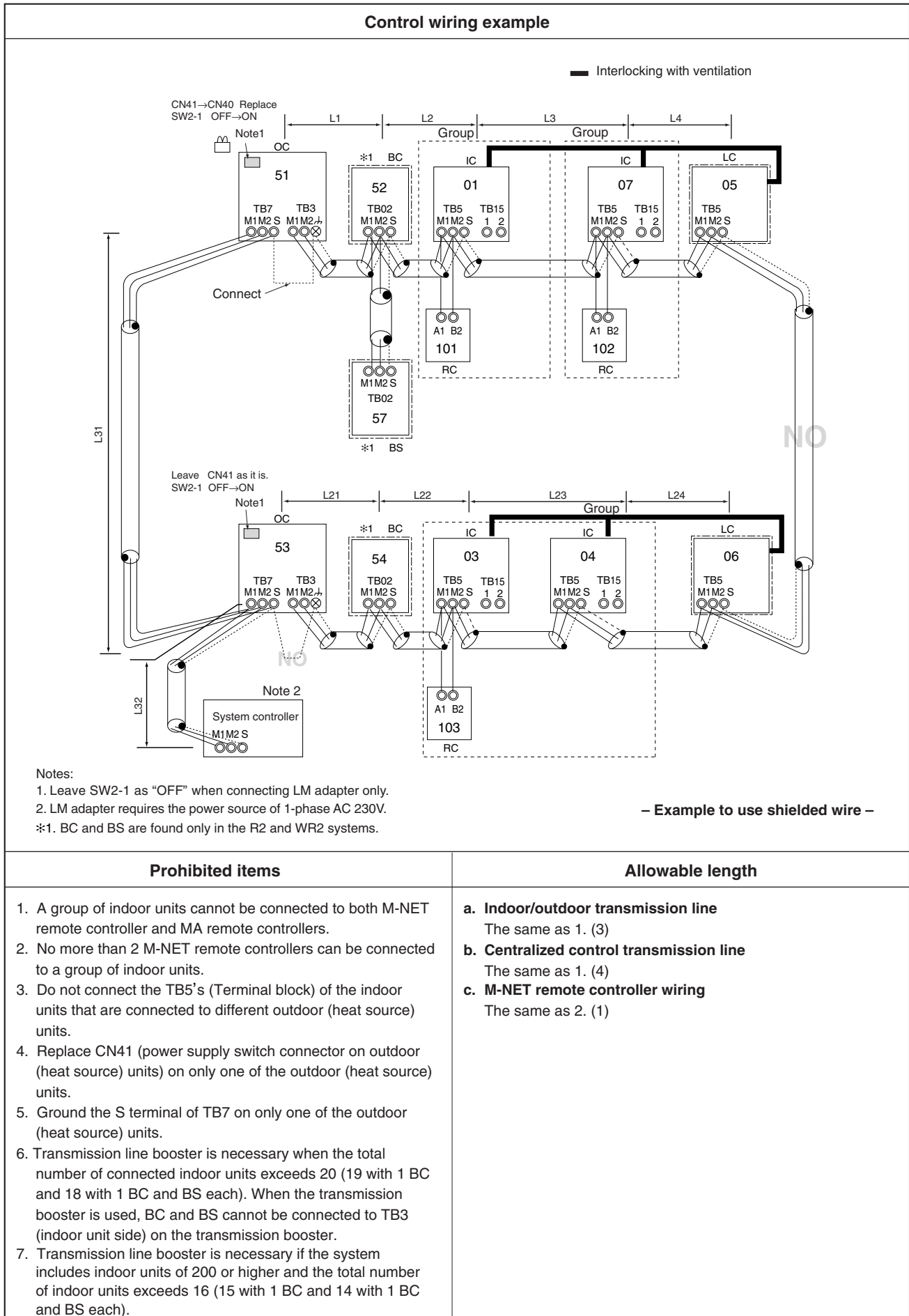

Wiring method · Address setting method

- a. Indoor/outdoor transmission line** The same as 1. (3)
Connection of shielded wire: The same as 1. (1)
- b. Centralized control transmission line** The same as 1. (4)
Connection of shielded wire: The same as 1. (4)
- c. M-NET remote controller wiring**
M-NET remote controller wiring
Connect each of the M1 and M2 terminals of TB5 (indoor/outdoor transmission line terminal block) on the IC to the terminals on the M-NET remote controller.
For 2-remote controller operation:
For a 2-remote-controller operation, connect each of the terminals M1 and M2 of the IC terminal block to the two RC terminal blocks respectively.
For indoor unit group operation:
Indoor unit group operation
To operate IC's as a group, connect the M1, M2 terminals of the terminal block on the main IC in the group with the RC terminal block (with non-polar two wires)
※M-NET remote controller can be connected at any point on the indoor/outdoor transmission line.
※To run a group operation of indoor units that have different functions, select the unit with the greatest number of functions as the main unit.
- d. LOSSNAY connection** The same as 1. (4)
- e. Switch setting** Address setting is required as follows.

| Order | Unit or controller | | Address setting range | Setting method | Caution | Factory setting | |
|-------|----------------------------|----------------------|-----------------------|----------------|--|---|-----|
| 1 | Indoor unit | Main unit | IC | 01 ~ 50 | <ul style="list-style-type: none"> Assign the smallest address within the group to the indoor unit to become the main unit. Assign a larger address to the indoor unit that is connected to the R2-type sub BC controller than the one assigned to the indoor unit connected to the main BC controller. If applicable, set the sub BC controllers in an R2 system in the following order: (1) Indoor unit to be connected to the main BC controller (2) Indoor unit to be connected to No.1 sub BC controller (3) Indoor unit to be connected to No.2 sub BC controller Set the address so that (1) < (2) < (3) | <ul style="list-style-type: none"> Make the initial setting of the indoor unit group setting with the system controller (MELANS). Branch numbers must be set for systems with R2 and WR2. | 00 |
| | | Sub unit | | | | | |
| 2 | LOSSNAY | | LC | 01 ~ 50 | <ul style="list-style-type: none"> The Lossnay address must not overlap with the indoor unit address. | 00 | |
| 3 | M-NET remote controller | Main unit | RC | 101 ~ 150 | The address of the main unit in the same group +100 | <ul style="list-style-type: none"> 100's digit does not need to be set. Set the address to "00" when setting it to "200". | 101 |
| | | Sub unit | RC | 151 ~ 200 | The address of the main unit in the same group +150 | | |
| 4 | Outdoor (Heat source) unit | | OC | 51 ~ 100 | The smallest indoor unit address in the same refrigerant system +50 | <ul style="list-style-type: none"> Set the address to "50" when setting it to "100". | 00 |
| 5 | Auxiliary units | BC Controller (sub) | BS | 52 ~ 100 | Use the address that equals the sum of the smallest indoor unit address out of all the indoor units that are connected to the sub BC controller and 50. | <ul style="list-style-type: none"> To set the address to "100," set it to "50". If the address of main BC controller overlaps with the address of the outdoor (heat source) unit or the sub BC controller, use an unused address within the setting range. The use of a sub BC controller requires a main BC controller. | 00 |
| | | BC Controller (main) | BC | | Outdoor (Heat source) unit address +1 | | |

3. System where MA remote controller and M-NET remote controller coexist

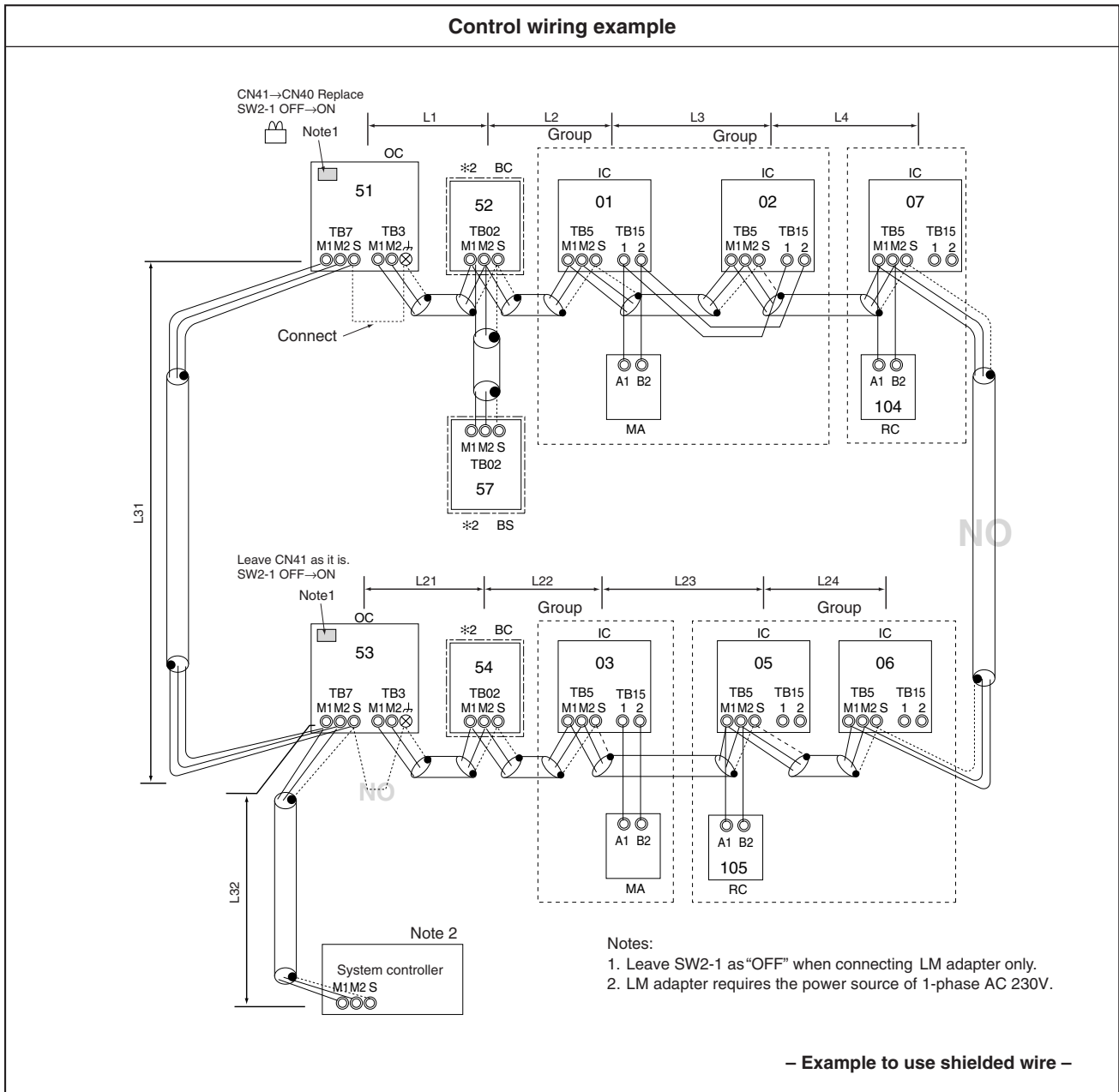

| Prohibited items | Allowable length |
|--|--|
| <ol style="list-style-type: none"> 1. Make sure to connect the system controller. 2. M-NET and MA remote controllers can not be connected together to the indoor unit within a same group. 3. M-NET remote controller of 3 units or more can not be connected to the indoor unit within a same group. 4. MA remote controller of 3 units or more can not be connected to the indoor unit within a same group. 5. Do not connect together the terminal blocks (TB5) of the indoor unit connected to different outdoor (heat source) units. 6. Replacement of the power supply selecting connector (CN41) on the outdoor (heat source) unit should be done only on one outdoor (heat source) unit. 7. Grounding work is required for S-terminal of the centralized control transmission block (TB7) on one outdoor (heat source) unit only. 8. When the total number of indoor units exceeds 20 sets, transmission line booster is required. When the transmission booster is used, BC and BS cannot be connected to TB3 (indoor unit side) on the transmission booster. 9. When the total number of indoor units exceed 16 sets and they include Type 200 or above, the transmission line booster is required. | <ol style="list-style-type: none"> a. Indoor/outdoor transmission line The same as 1. (3) b. Centralized control transmission line The same as 1. (4) c-1. MA remote controller wiring The same as 1. (1) c-2. M-NET remote controller wiring The same as 2. (1) |

Wiring method · Address setting method

- a. Indoor/outdoor transmission line** The same as 1. (3)
Connection of shielded wire: The same as 1. (1)
- b. Centralized control transmission line** The same as 1. (4)
Connection of shielded wire: The same as 1. (4)
- c-1. MA remote controller wiring, For 2-remote controller operation: , For indoor unit group operation:**
The same as 1. (1)
- c-2. M-NET remote controller, For 2-remote controller operation: , For indoor unit group operation:**
The same as 2. (1)
- d. Lossnay connection** The same as 1. (4)
- e. Switch setting** Address setting is required as follows.

| Order | Unit or controller | | | Address setting range | Setting method | Caution | Factory setting | |
|-------|--|----------------------|-----------|-----------------------|---|--|--|---------------------------------------|
| 1 | Operation with MA remote controller | Indoor unit | Main unit | IC | 01 ~ 50 | <ul style="list-style-type: none"> Set the lowest address within a same group to the indoor unit desired to be the main unit. Assign a larger address to the indoor unit that is connected to the R2-type sub BC controller than the one assigned to the indoor unit connected to the main BC controller. If applicable, set the sub BC controllers in an R2 system in the following order: (1) Indoor unit to be connected to the main BC controller (2) Indoor unit to be connected to No.1 sub BC controller (3) Indoor unit to be connected to No.2 sub BC controller Set the address so that (1) < (2) < (3) | <ul style="list-style-type: none"> Set lower address than that of the indoor unit connected to M-NET remote controller. Initially set the same setting detail as that of indoor unit group executed in the wiring of MA remote controller with system controller. Branch numbers must be set for systems with R2 and WR2. | 00 |
| | | | Sub unit | | | | | |
| | MA remote controller | Main unit | MA | Not required | - | | Main | |
| | | Sub unit | MA | Sub remote controller | Set by using the main/sub selector switch | | | |
| 2 | Operation with M-NET remote controller | Indoor unit | Main unit | IC | 01 ~ 50 | <ul style="list-style-type: none"> After setting the address of the indoor unit to be operated with MA controller, set the lowest address among the same group to the indoor unit desired to be the main unit. Assign a larger address to the indoor unit that is connected to the R2-type sub BC controller than the one assigned to the indoor unit connected to the main BC controller. | <ul style="list-style-type: none"> Initially set the same setting detail as that of indoor unit group with system controller. Branch numbers must be set for a system with R2. | 00 |
| | | | Sub unit | | | | | |
| | M-NET remote controller | Main unit | RC | 101 ~ 150 | Main unit address inside a same group + 100 | <ul style="list-style-type: none"> 100 digits are not required to set. When setting the address as "200," make it "00." | 101 | |
| | | Sub unit | RC | 151 ~ 200 | Main unit address inside a same group + 150 | | | |
| 3 | Lossnay | | | LC | 01 ~ 50 | After setting all indoor units, set any address. | <ul style="list-style-type: none"> Set so that not duplicating with the indoor unit addresses. | 00 |
| 4 | Outdoor (Heat source) unit | | | OC | 51 ~ 100 | The lowest address of indoor unit within refrigerant system + 50 | <ul style="list-style-type: none"> When setting the address to "100," make it "50." | 00 |
| 5 | Auxiliary units | BC Controller (sub) | BS | 52 ~ 100 | Use the address that equals the sum of the smallest indoor unit address out of all the indoor units that are connected to the sub BC controller and 50. | <ul style="list-style-type: none"> To set the address to "100," set it to "50". If the address of main BC controller overlaps with the address of the outdoor (heat source) unit or the sub BC controller, use an unused address within the setting range. The use of a sub BC controller requires a main BC controller | 00 | |
| | | BC Controller (main) | BC | | | | | Outdoor (Heat source) unit address +1 |

[4] Restrictions on Refrigerant Piping Length

For the piping connection, the end branching system is applied where the end of refrigerant piping from the heat source unit is branched and connected to each indoor unit. As the piping connection method, the indoor unit is applied with flare connection, heat source unit gas piping is flare connection, and liquid piping is flare connection. For the branching, brazed connection is applied.

Warning

Be careful not to leak refrigerant gas (R410A) near a fire. Refrigerant gas if touched a fire of gas oven and the like will be decomposed to generate poisonous gas leading to gas-poisoning. Do not conduct welding work in a closed room. Run a gas leak test after completing refrigerant piping work.

Warning

Do not use a refrigerant other than that indicated on the equipment at installation or movement.

- Mixing of different refrigerant or air makes the refrigeration cycle abnormal causing breakage and the like.

Caution

Use refrigerant piping phosphorus deoxidized copper. In addition, be sure that the inner and outer surface of the pipes are clean and free of hazardous sulphur, oxides, dust/dirt, shaving particles, oils, moisture, or any other contaminant.

- Contaminants on the inside of the refrigerant piping may cause the refrigerant residual oil to deteriorate.

Caution

Use liquid refrigerant to fill the system.

- If gas refrigerant is used to seal the system, the composition of the refrigerant in the cylinder will change and performance may drop.

Caution

Do not use existing refrigerant piping.

- The old refrigerant and refrigerator oil in the existing piping contains a large amount of chlorine which may cause the refrigerator oil of the new unit to deteriorate.

Caution

**Store the piping to be used during installation indoors and keep both ends of the piping sealed until just before brazing.
(Store elbows and other joints in a plastic bag.)**

- If dust, dirt, or water enters the refrigerant cycle, deterioration of the oil and compressor trouble may result.

Caution

Do not use a charging cylinder.

- Using a charging cylinder may cause the refrigerant to deteriorate.

1. Line-branch method

■PQRY-P200,P250YGM-A

[16 branches or less (the use of only the main BC controller or standard BC controller)]

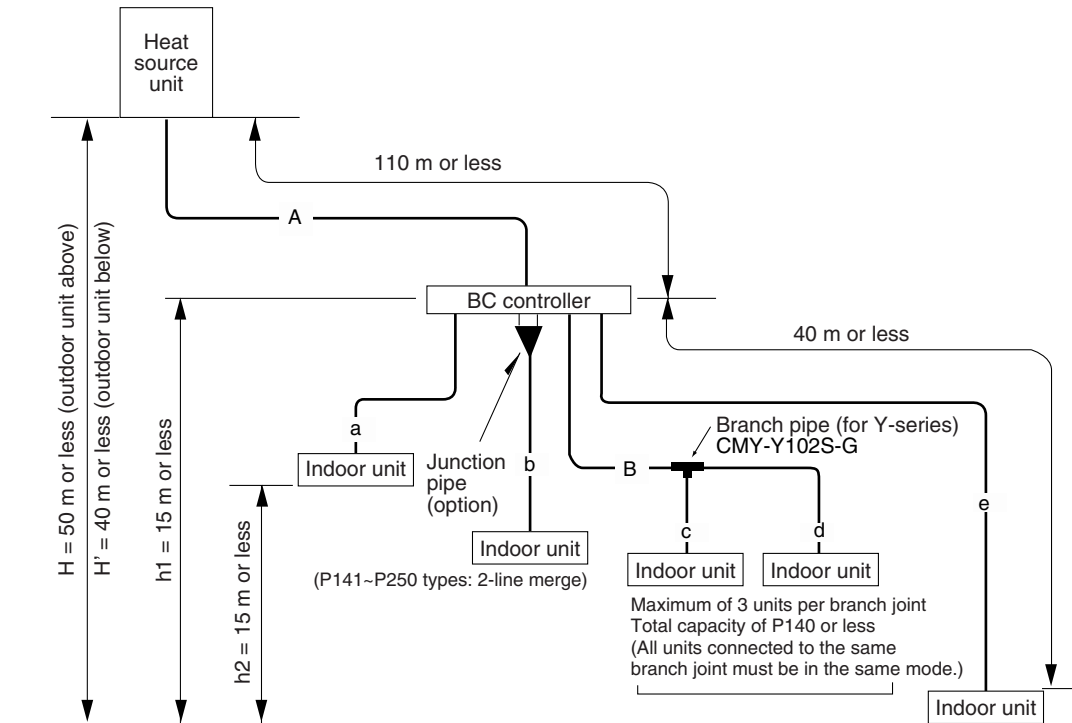

| Item | | Piping sections | Allowable value | |
|-------------------|--|---------------------------|--|--------------|
| Piping length | Total piping length | A + B + a + b + c + d + e | 300 m less (Note 2) | |
| | Farthest piping length | A + e | 150 m or less (175 m equivalent length or less) | |
| | Between heat source unit - BC controller | A | 110 m or less | |
| | Between BC controller and indoor unit | e | 40 m or less (Note 3) | |
| Height difference | Between indoor unit and heat source unit | Heat source unit above | H | 50 m or less |
| | | Heat source unit below | H' | 40 m or less |
| | Between indoor unit and BC controller | h1 | 15 m or less (10 m or less) (Note 1) | |
| | Between indoor units | h2 | 15 m or less (10 m or less) (Note 1) | |

- Note 1: Use the figures in the parentheses if the capacity of the connected indoor units is P200 type or above.
- Note 2: Refer to the graph below for restrictions on refrigerant piping length when the total piping length exceeds 300 m.
- Note 3: Refer to the graph below for restrictions on refrigerant piping length when the piping length between the BC controller and the farthest indoor unit exceeds 40 m. (except P250-type indoor units)
- Note 4: When indoor units of P200 type or above are connected, neither branch joints nor branch headers can be used.
- Note 5: Do not connect P200- or P250-type indoor units and other types of indoor units at the same pipe end connection.

• Restrictions on piping length

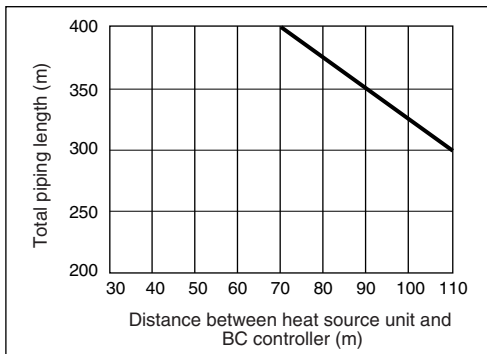

• Height difference and branch piping length between BC controller and indoor unit. (A)

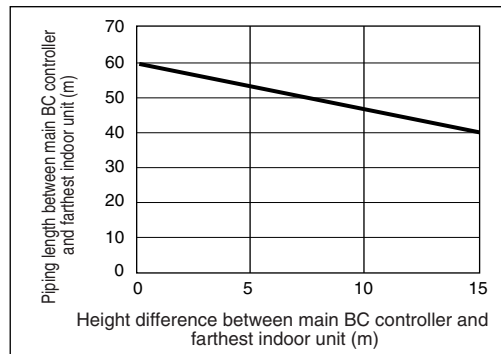

■PQRY-P200,P250YGM-A

[Systems that requires more than 16 pipe-end connections or with multiple BC controllers (with a use of both main and sub controllers)]

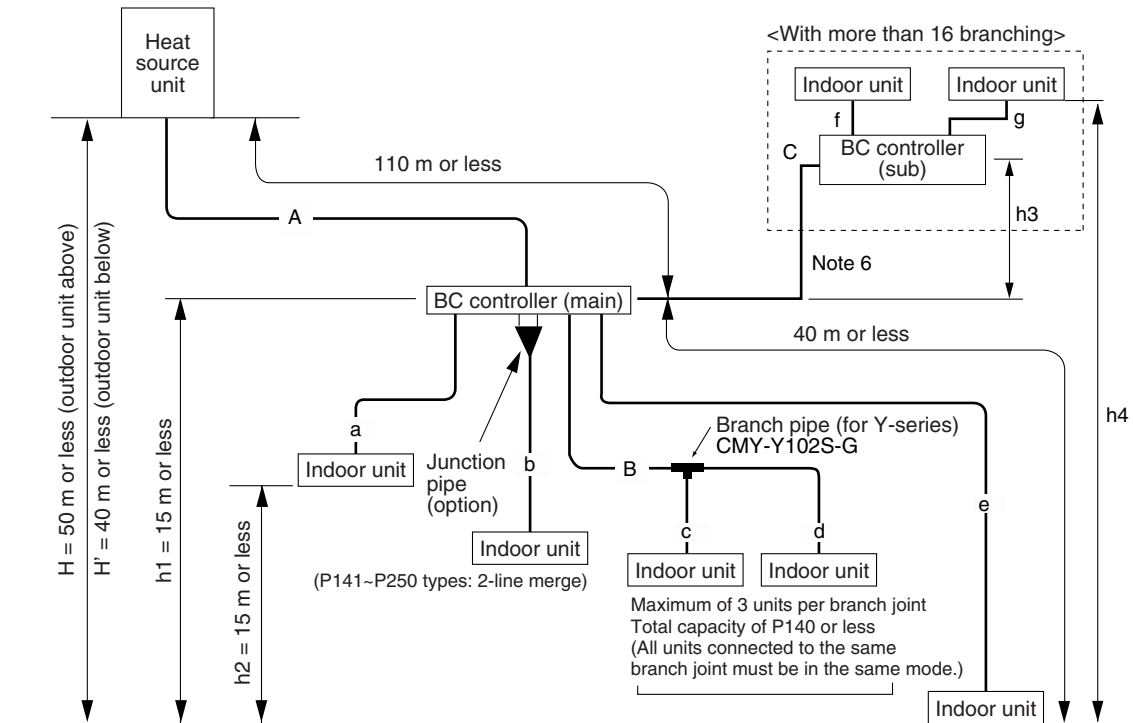

| Item | | Piping sections | Allowable value | |
|-------------------|--|---|--|--------------|
| Piping length | Total piping length | $A + B + C + a + b + c + d + e + f + g$ | 300 m less | |
| | Farthest piping length | $A + C + g$ or $A + e$ | 150 m or less (175 m equivalent length or less) | |
| | Between heat source unit - BC controller | A | 110 m or less | |
| | Between BC controller and indoor unit | e or $C + g$ | 40 m or less (Note 2) | |
| Height difference | Between indoor unit and heat source unit | Heat source unit above | H | 50 m or less |
| | | Heat source unit below | H' | 40 m or less |
| | Between indoor unit and BC controller | h1 | 15 m or less (10 m or less) (Note 3) | |
| | Between indoor units | h2 | 15 m or less (10 m or less) (Note 3) | |
| | Between main BC controller and sub BC controller | h3 | 15 m or less | |
| | Between indoor (main BC controller) and indoor (sub BC controller) units | h4 | 15 m or less (10 m or less) (Notes 3 and 5) | |

Note: A system with more than 16 branching requires 2 to 3 BC controllers (main/sub) and 3 pipes between BC controllers.

Note 1: Refer to the graph below for restrictions on refrigerant piping when the total piping length exceeds 300 m.

Note 2: Refer to the graph below for restrictions on refrigerant piping length when the piping length between the BC controller and the farthest indoor unit exceeds 40 m. (except P250-type indoor units)

Note 3: Use the figures in the parentheses if the capacity of the connected indoor units is P200 type or above.

Note 4: When indoor units of type P200 or above are connected, neither branch joints nor branch headers can be used.

Note 5: When 2 sub BC controllers are connected, include them in the figures in the table above.

Note 6: When 2 sub BC controllers are connected, connect them in parallel.

• Restrictions on piping length

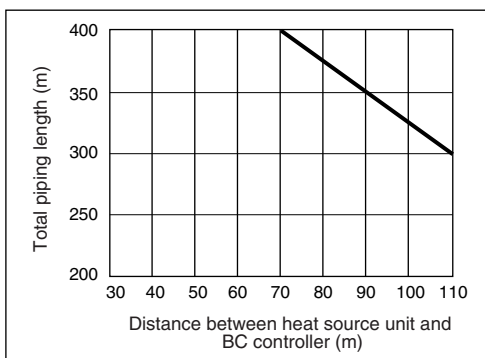

• Height difference and branch piping length between BC controller and indoor unit. (A)

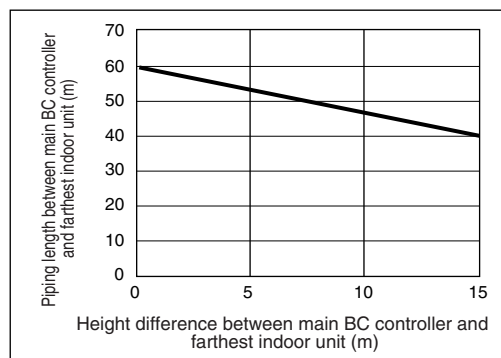

■PQRY-P400,P500YSGM-A

[16 branches or less (the use of only the main BC controller or standard BC controller)]

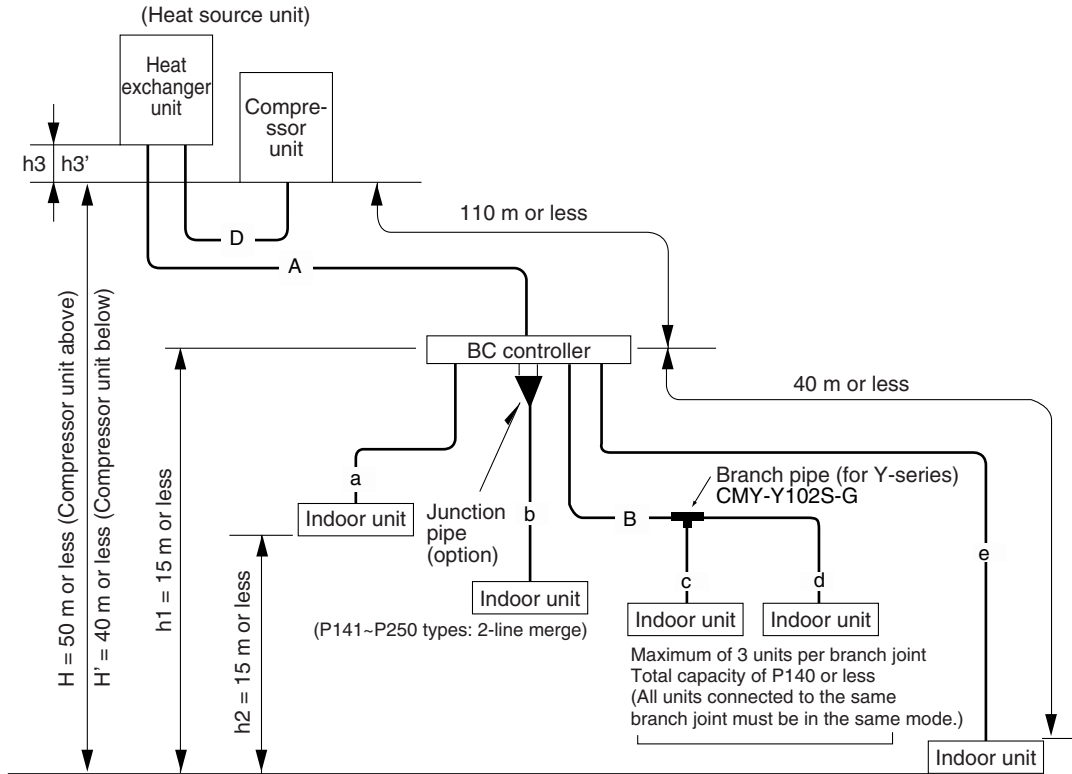

| Item | | Piping sections | Allowable value | |
|-----------------------|---|-------------------------------|--|--------------|
| Piping length | Total piping length | A + B + D + a + b + c + d + e | 300 m or less (Note 2) | |
| | Farthest piping length | A + D + e | 150 m or less (175 m equivalent length or less) | |
| | Between Compressor unit - BC controller | A + D | 110 m or less | |
| | Between BC controller and indoor unit | e | 40 m or less (Note 3) | |
| | Between Compressor unit and Heat exchanger unit | D | 10 m or less (Note 5, Note 6) | |
| Height difference | Between indoor unit and Compressor unit | Compressor unit above | H | 50 m or less |
| | | Compressor unit below | H' | 40 m or less |
| | Between indoor unit and BC controller | h1 | 15 m or less (10 m or less) (Note 1) | |
| | Between indoor units | h2 | 15 m or less (10 m or less) (Note 1) | |
| | Between Compressor unit and Heat exchanger unit | Compressor unit above | h3 | 0 m |
| Compressor unit below | | h3' | 10 m or less | |

- Note 1: Use the figures in the parentheses if the capacity of the connected indoor units is P200 type or above.
 Note 2: Refer to the graph below for restrictions on refrigerant piping length when the total piping length exceeds 300 m.
 Note 3: Refer to the graph below for restrictions on refrigerant piping length when the piping length between the BC controller and the farthest indoor unit exceeds 40 m. (except P250-type indoor units)
 Note 4: When indoor units of P200 type or above are connected, neither branch joints nor branch headers can be used.
 Note 5: Use optional extension wire for water-source unit to leave a space between the compressor unit and the heat exchanger.
 Note 6: The piping length between the compressor unit and the heat exchanger unit must be 10m or less.

• Restrictions on piping length

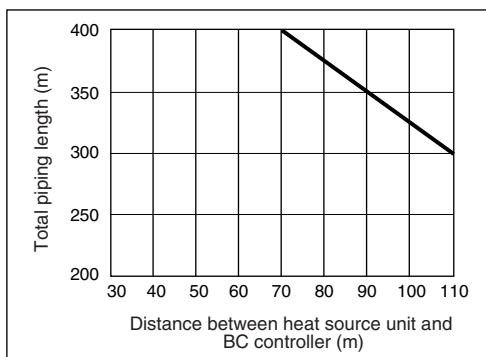

• Height difference and branch piping length between BC controller and indoor unit. (A)

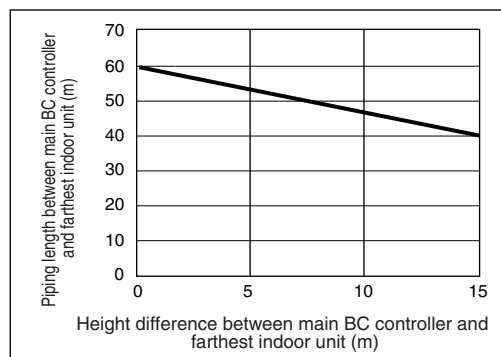

■PQRY-P400,P500YSGM-A

[Systems that requires more than 16 pipe-end connections or with multiple BC controllers (with a use of both main and sub controllers)]

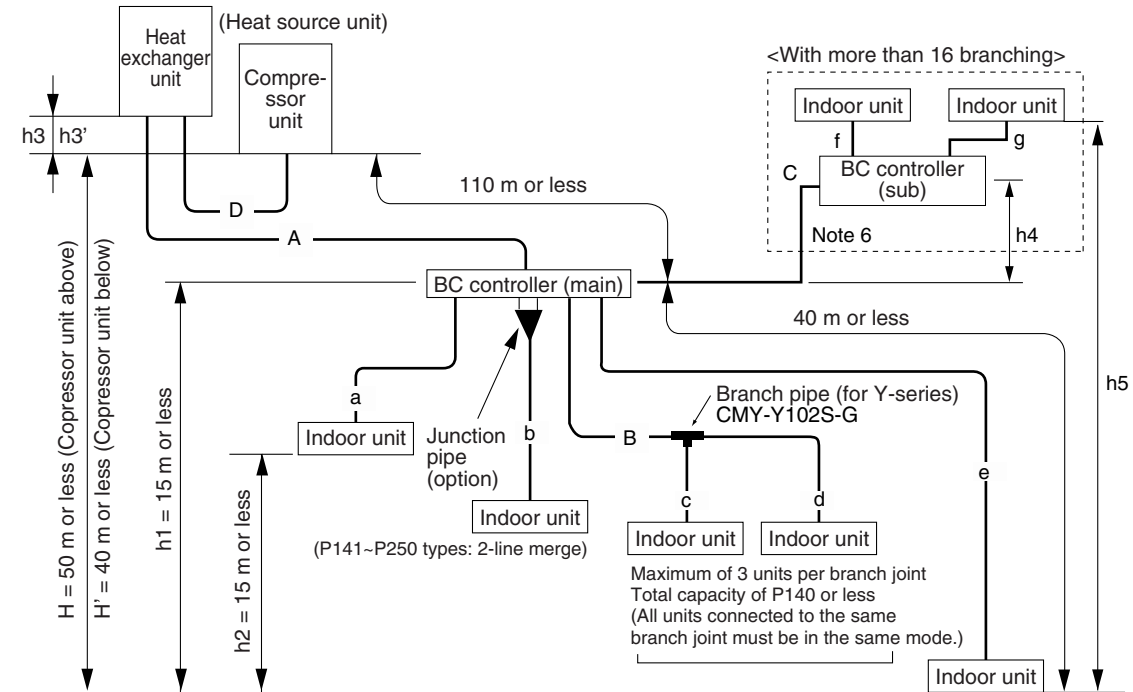

| Item | | Piping sections | Allowable value | |
|--|--|--|--|--------------|
| Piping length | Total piping length | A + B + C + D + a + b + c + d + e + f + g | 300 m or less | |
| | Farthest piping length | A + C + D + g or A + e | 150 m or less (175 m equivalent length or less) | |
| | Between Compressor unit - BC controller | A + D | 110 m or less | |
| | Between BC controller and indoor unit | e or C + g | 40 m or less (Note 2) | |
| | Between Compressor unit and Heat exchanger unit | D | 10 m or less (Note 7, Note 8) | |
| Height difference | Between indoor unit and Compressor unit | Compressor unit above | H | 50 m or less |
| | | Compressor unit below | H' | 40 m or less |
| | Between indoor unit and BC controller | h1 | 15 m or less (10 m or less) (Note 3) | |
| | Between indoor units | h2 | 15 m or less (10 m or less) (Note 3) | |
| | Between Compressor unit and Heat exchanger unit | Compressor unit above | h3 | 0 m |
| | | Compressor unit below | h3' | 10 m or less |
| | Between main BC controller and sub BC controller | h4 | 15 m or less | |
| Between indoor unit (main BC controller) and indoor unit (sub BC controller) | h5 | 15 m or less (10 m or less) (Note 3 and 5) | | |

Note: A system with more than 16 branching requires 2 to 3 BC controllers (main/sub) and 3 pipes between BC controllers.

Note 1: Refer to the graph below for restrictions on refrigerant piping when the total piping length exceeds 300 m.

Note 2: Refer to the graph below for restrictions on refrigerant piping length when the piping length between the BC controller and the farthest indoor unit exceeds 40 m. (except P250-type indoor units)

Note 3: Use the figures in the parentheses if the capacity of the connected indoor units is P200 type or above.

Note 4: When indoor units of type P200 or above are connected, neither branch joints nor branch headers can be used.

Note 5: When 2 sub BC controllers are connected, include them in the figures in the table above.

Note 6: When 2 sub BC controllers are connected, connect them in parallel.

Note 7: Use optional extension wire for water-source unit to leave a space between the compressor unit and the heat exchanger.

Note 8: The piping length between the compressor unit and the heat exchanger unit must be 10m or less.

• Restrictions on piping length

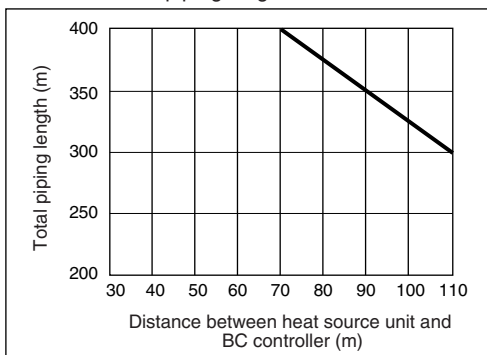

• Height difference and branch piping length between BC controller and indoor unit. (A)

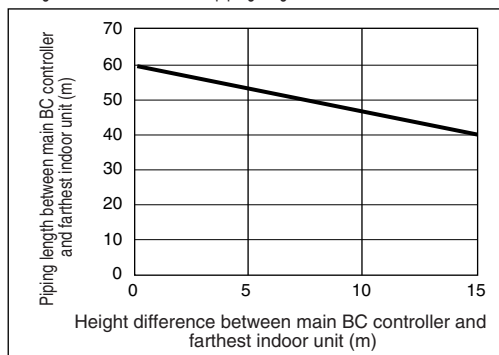

① Line branching system

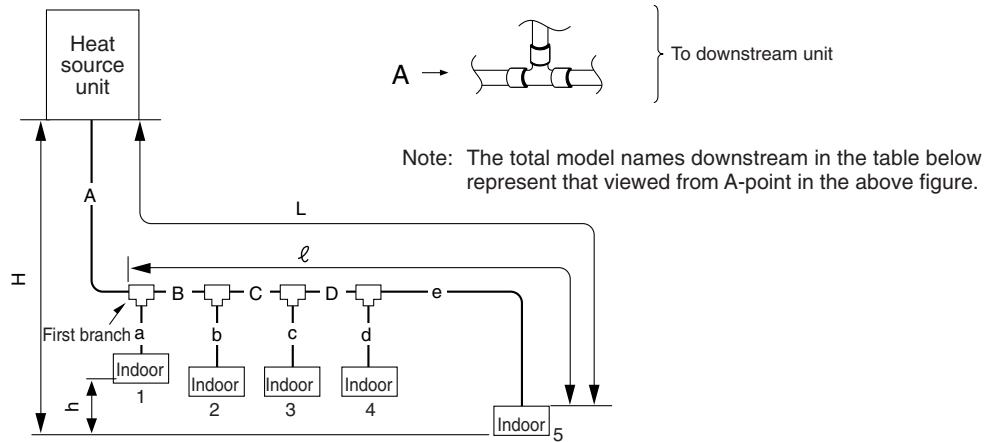

| Item | | Piping section | Allowable value | |
|-------------------|--|-------------------------------------|-----------------|---------------|
| Length | Total piping length | $A + B + C + D + a + b + c + d + e$ | Less than 300m | |
| | Farthest piping length (L) | $A + B + C + D + e$ | Less than 150m | |
| | Farthest piping length after first branch (ℓ) | $B + C + D + e$ | Less than 40m | |
| Height difference | Indoor – Heat source | Upper heat source unit | H | Less than 50m |
| | | Lower heat source unit | H' | Less than 40m |
| | Indoor – Indoor | h | Less than 15m | |

② Header branching system

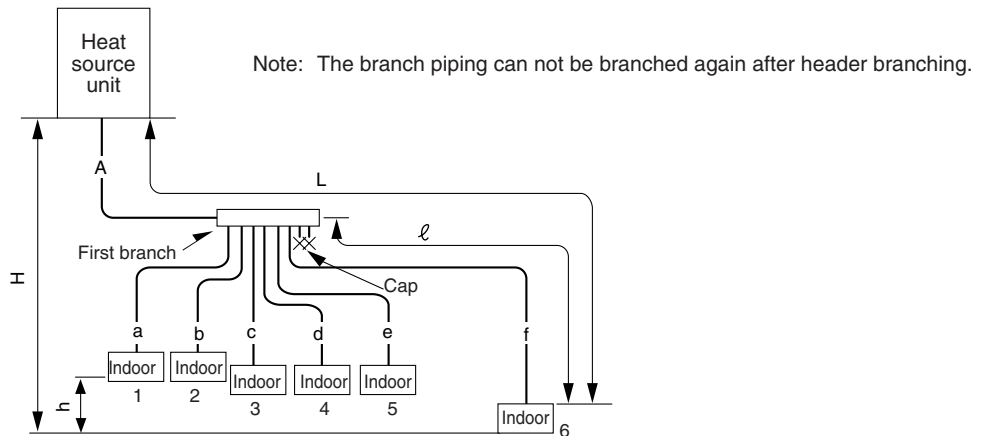

| Item | | Piping section | Allowable value | |
|-------------------|--|-----------------------------|-----------------|---------------|
| Length | Total piping length | $A + a + b + c + d + e + f$ | Less than 300m | |
| | Farthest piping length (L) | $A + f$ | Less than 150m | |
| | Farthest piping length after first branch (ℓ) | f | Less than 40m | |
| Height difference | Indoor – Heat source | Upper heat source unit | H | Less than 50m |
| | | Lower heat source unit | H' | Less than 40m |
| | Indoor – Indoor | h | Less than 15m | |

③ Mixed line and header branching system

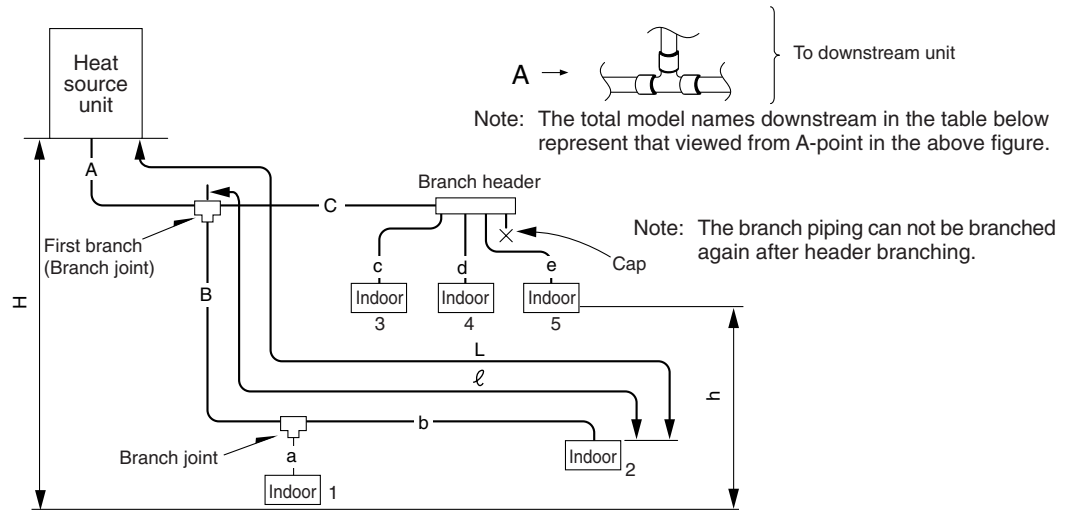

| Item | | Piping section | Allowable value | |
|-------------------|--|---------------------------------|-----------------|---------------|
| Length | Total piping length | $A + B + C + a + b + c + d + e$ | Less than 300m | |
| | Farthest piping length (L) | $A + B + b$ | Less than 150m | |
| | Farthest piping length after first branch (ℓ) | $B + b$ | Less than 40m | |
| Height difference | Indoor – Heat source | Upper heat source unit | H | Less than 50m |
| | | Lower heat source unit | H' | Less than 40m |
| | Indoor – Indoor | h | Less than 15m | |

① Line branching system

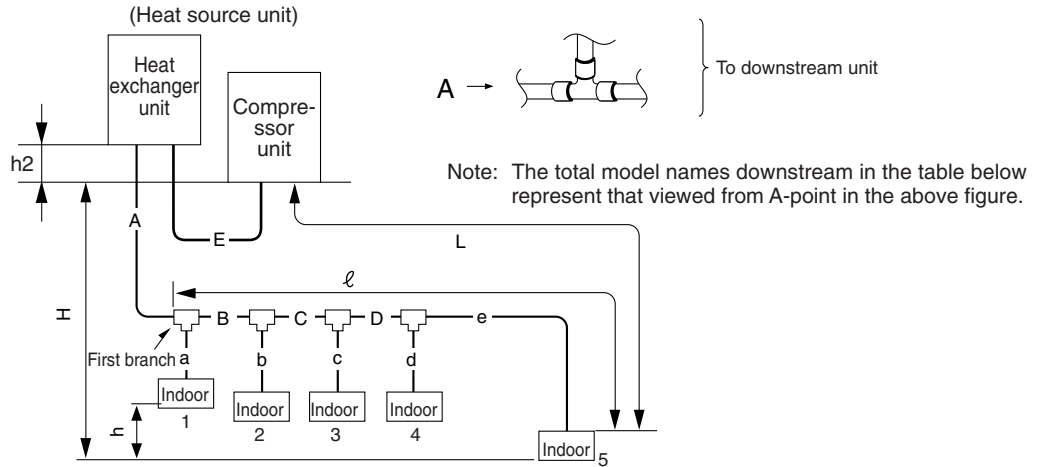

| Item | | Piping section | Allowable value | |
|-----------------------|--|---|-----------------|---------------|
| Length | Total piping length | $A + B + C + D + E + a + b + c + d + e$ | Less than 300m | |
| | Farthest piping length (L) | $A + B + C + D + E + e$ | Less than 150m | |
| | Farthest piping length after first branch (ℓ) | $B + C + D + e$ | Less than 40m | |
| Height difference | Indoor – Compressor unit | Upper Compressor unit | H | Less than 50m |
| | | Lower Compressor unit | H' | Less than 40m |
| | Indoor – Indoor | | h | Less than 15m |
| | Compressor unit – Heat exchanger unit | Upper Compressor unit | h2 | Less than 0m |
| Lower Compressor unit | | h2' | Less than 10m | |

② Header branching system

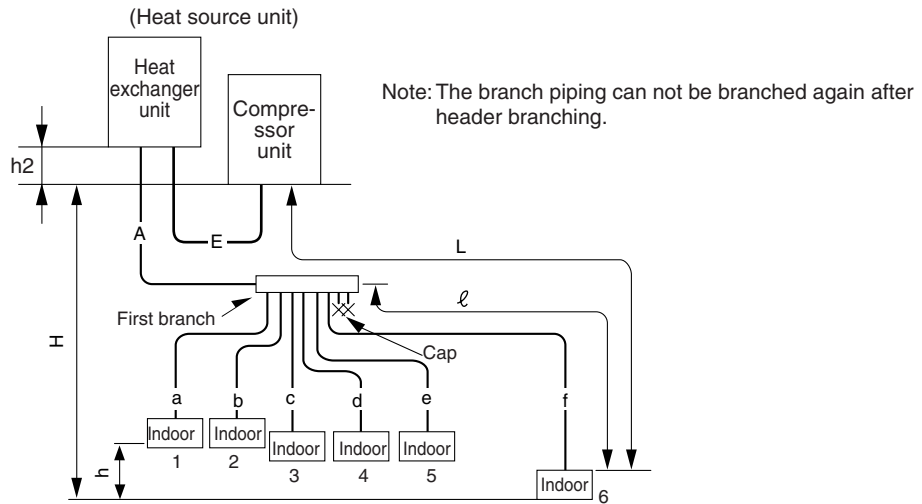

| Item | | Piping section | Allowable value | |
|-----------------------|--|-----------------------------|-----------------|---------------|
| Length | Total piping length | $A + a + b + c + d + e + f$ | Less than 300m | |
| | Farthest piping length (L) | $A + f$ | Less than 150m | |
| | Farthest piping length after first branch (ℓ) | f | Less than 40m | |
| Height difference | Indoor – Compressor unit | Upper Compressor unit | H | Less than 50m |
| | | Lower Compressor unit | H' | Less than 40m |
| | Indoor – Indoor | | h | Less than 15m |
| | Compressor unit – Heat exchanger unit | Upper Compressor unit | h2 | Less than 0m |
| Lower Compressor unit | | h2' | Less than 15m | |

③ Mixed line and header branching system

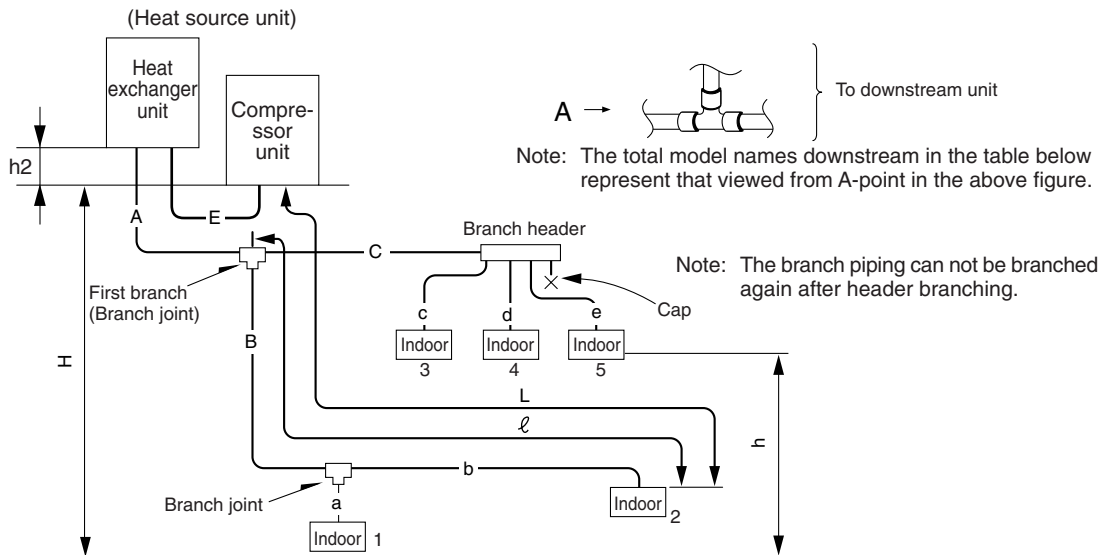

| Item | | Piping section | Allowable value | |
|-----------------------|--|---------------------------------|-----------------|---------------|
| Length | Total piping length | $A + B + C + a + b + c + d + e$ | Less than 300m | |
| | Farthest piping length (L) | $A + B + b$ | Less than 150m | |
| | Farthest piping length after first branch (ℓ) | $B + b$ | Less than 40m | |
| Height difference | Indoor – Compressor unit | Upper Compressor unit | H | Less than 50m |
| | | Lower Compressor unit | H' | Less than 40m |
| | Indoor – Indoor | | h | Less than 15m |
| | Compressor unit – Heat exchanger unit | Upper Compressor unit | h2 | Less than 0m |
| Lower Compressor unit | | h2' | Less than 15m | |

2. Refrigerant piping size

<PQRY>

① Between heat source unit and BC controller (Part A)

| Heat source unit | | PQRY-P200 YGM-A | PQRY-P250 YGM-A | PQRY-P400 YSGM-A | PQRY-P500 YSGM-A |
|--|--------------------|--------------------|--------------------|---------------------|---------------------|
| Refrigerant piping size | High pressure pipe | φ 15.88 | φ 19.05 | φ 22.2 | |
| | Low pressure pipe | φ 19.05 | φ 22.2 | φ 28.58 | |
| End connection of heat source unit and BC controller | High pressure pipe | φ 15.88 (Brazed) | φ 19.05 (Brazed) | φ 22.2 (Brazed) | |
| | Low pressure pipe | φ 19.05 (Brazed) | φ 22.2 (Brazed) | φ 28.58 (Brazed) | |

Note 1: Heat source units and BC controllers are supplied with flanges with a short copper pipe as a part used to connect to the low pressure pipe.

② Between BC controller and indoor unit (Parts a, b, c, d, and e)

| Indoor unit | | 20, 25, 32 40, 50 | 63, 71, 80, 100 125, 140 | 200 | 250 |
|--|-------------|----------------------|-----------------------------|---------|--------|
| Refrigerant piping size | Liquid pipe | φ 6.35 | φ 9.52 | | |
| | Gas pipe | φ 12.7 | φ 15.88 | φ 19.05 | φ 22.2 |
| End connection of indoor unit (Flare connection for all unit types) | Liquid pipe | φ 6.35 | φ 9.52 | | |
| | Gas pipe | φ 12.7 | φ 15.88 | φ 19.05 | φ 22.2 |

③ Between main BC controller and sub BC controller (Part C)

| Indoor unit | | ~P200 | P201~P300 | P301~P350 |
|---|--------------------------|---------|-----------|-----------|
| Refrigerant piping size (Use brazing for all units.) | Liquid pipe | φ 9.52 | | φ 12.7 |
| | High-pressure Gas pipe | φ 15.88 | φ 19.05 | |
| | Low-pressure Liquid pipe | φ 19.05 | φ 22.2 | φ 28.58 |

* When 2 sub controllers are connected, determine the pipe size on the main side based on the total capacity of the indoor units that are connected to the 2 sub controllers, and determine the pipe size on the sub controller side based on the total capacity of the units that are connected.

④ Compressor unit and Heat exchanger unit (Part D)

| Heat source unit | | PQRY-P200 YGM-A | PQRY-P250 YGM-A | PQRY-P400 YSGM-A | PQRY-P500 YSGM-A |
|-----------------------|--------------------|--------------------|--------------------|---------------------|---------------------|
| Refrigerant pipe size | Low-pressure pipe | — | | φ 28.58 | |
| | High-pressure pipe | — | | φ 19.05 | |
| | Bypass pipe | — | | φ 9.52 | |

Note 2: Use pipes that are specified in the section "Read Before Servicing: [3] Piping Materials."

<PQHY>

A (mm)

| Outdoor model | Liquid pipe | Gas pipe |
|---------------|-------------|----------|
| P200 | ø9.52 | ø19.05 |
| P250 | *1 ø9.52 | ø22.2 |
| P400 | ø12.7 | ø28.58 |
| P500 | ø15.88 | ø28.58 |

*1 ø12.7 for over 90m

| Downstream unit model total | Branch kit model |
|-------------------------------|------------------|
| ~ 200 | CMY-Y102S-G |
| 201 ~ 400 | CMY-Y102L-G |
| 401 ~ 650 | CMY-Y202-G |
| The 1st branch of P450 ~ P650 | |

| 4-Branching header (Downstream unit model total ≤ 200) | 8-Branching header (Downstream unit model total ≤ 400) | 10-Branching header Downstream unit model total ≤ 650) |
|--|--|--|
| CMY-Y104-G | CMY-Y108-G | CMY-Y1010-G |

B, C, D (mm)

| Total capacity of indoor units | Liquid pipe | Gas pipe |
|--------------------------------|-------------|----------|
| ~ 140 | ø9.52 | ø15.88 |
| 141 ~ 200 | ø9.52 | ø19.05 |
| 201 ~ 300 | ø9.52 | ø22.2 |
| 301 ~ 400 | ø12.7 | ø28.58 |
| 401 ~ 650 | ø15.88 | ø28.58 |

a, b, c, d, e (mm)

| Model number | Liquid pipe | Gas pipe |
|----------------------|-------------|----------|
| 20,25,32,40,50 | ø6.35 | ø12.7 |
| 63,71,80,100,125,140 | ø9.52 | ø15.88 |
| 200 | ø9.52 | ø19.05 |
| 250 | ø9.52 | ø22.2 |

3. Connecting the BC controllers

<PQRY>

(1) BC controller (standard model) end connection piping size

[P200,P250 types]

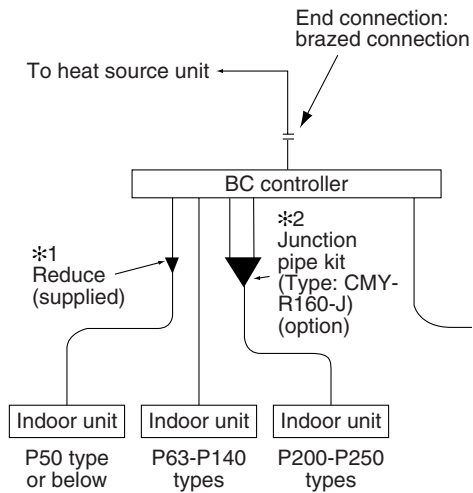

| Piping sections | | High-pressure side (liquid side) | Low-pressure side (gas side) |
|-----------------------|----------------|----------------------------------|------------------------------|
| Heat source unit side | PQRY-P200YGM-A | φ 15.88 (Braze) | φ 19.05 (Braze) |
| | PQRY-P250YGM-A | φ 19.05 (Braze) | φ 22.2 (Braze) |
| Indoor unit side | | φ 9.52 (Flare) | φ 15.88 (Flare) |

* BC controllers (standard model) can only be connected to P200,P250 heat source units.

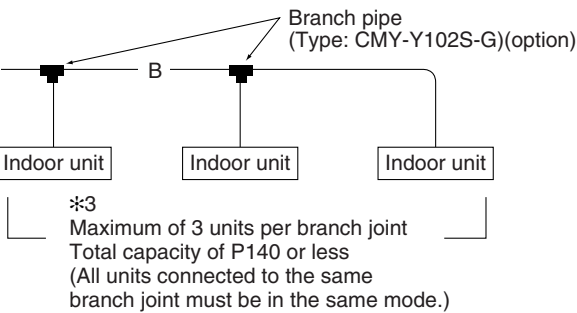

The size of the branch end connection on the BC controller is designed to fit P50-P140 type indoor units. To connect other types of indoor units, perform the following procedures.

*1: To connect P20-P50 type indoor units

Use the reducer that is supplied with the BC controller

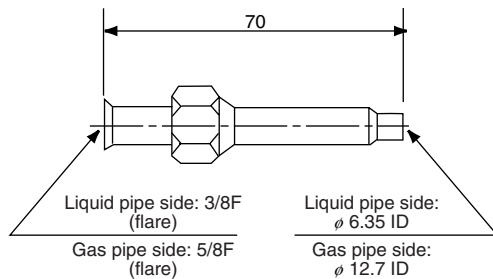

Note: Use the flare nut provided with the BC controller

*2: To connect P200 or P250 type indoor units (or when the total capacity of the indoor units exceeds P141)

Use an optional junction pipe kit and merge the 2 joints

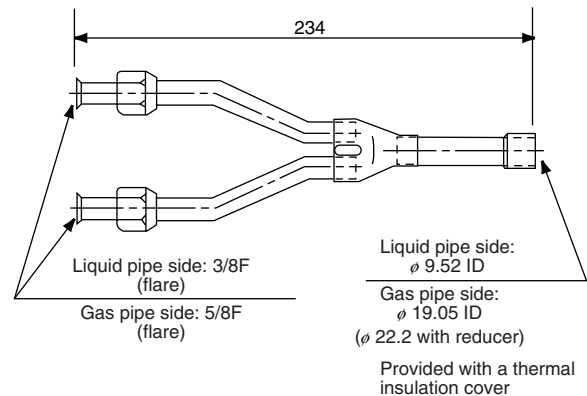

*3: To connect multiple indoor units to a branch joint (or to a junction pipe)

- ① Total capacity of connectable indoor units: P140 or below (P250 or below when a junction pipe is used)
- ② The number of connectable indoor units: 3 max.
- ③ Branch pipe: Use Type CMY-Y102S-G (option)
- ④ Selection of refrigerant piping (pipe size of the A and B in the figure above): Use the total capacity of the downstream indoor units to determine the proper pipe size, using the table below as a reference.

| Total capacity of the indoor units | Liquid pipe | Gas pipe |
|------------------------------------|-------------|------------|
| P140 or below | φ 9.52 | φ 15.88 |
| P141~P200 | φ 9.52 | φ 19.05 |
| P201~P250 | φ 9.52 | φ 22.2 (*) |

(*) With reducer

(2) BC controller (main) end connection piping size

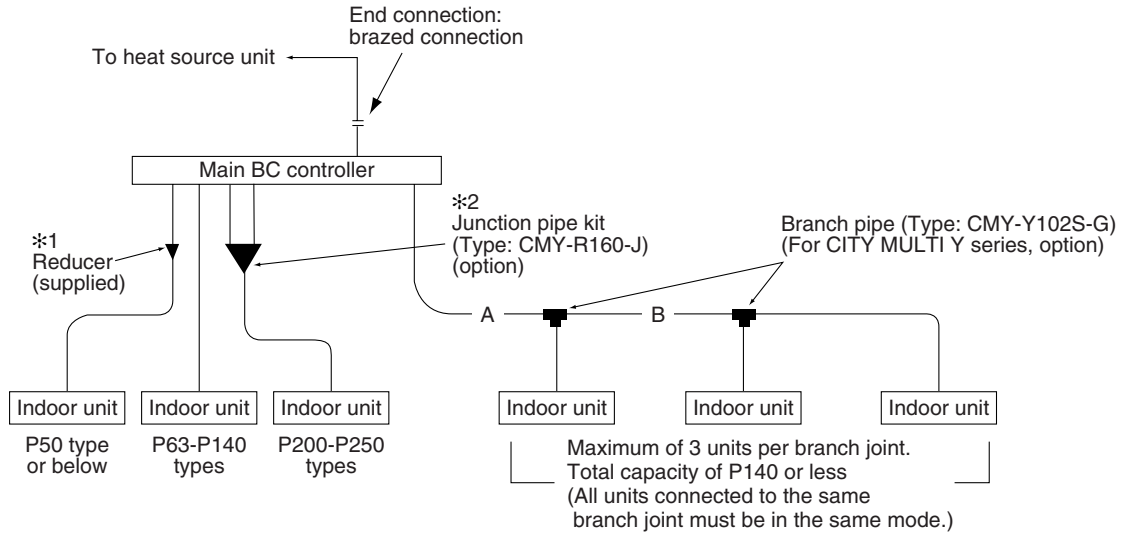

The size of the branch end connection on the BC controller is designed to fit P63-P140 type indoor units. To connect other types of indoor units, perform the following procedures.

- *1: To connect P20-P50 type indoor units, use the reducer that is supplied with the BC controller
- *2: To connect P200 or P250 type indoor units (or when the total capacity of the indoor units exceeds P141), use an optional junction pipe kit (Type: CMY-R160-J) and merge the 2 joints.
- *3: To connect multiple indoor units to a branch joint (or to a junction pipe)
 - Total capacity of connectable indoor units : P140 or below (P250 or below when a junction pipe is used)
 - The number of connectable indoor units : 3 max.
 - Selection of refrigerant piping (pipe size of the A and B in the figure above)
 - : Use the total capacity of the downstream indoor units to determine the proper pipe size, using the table below as a reference.

| Total capacity of the indoor units | Liquid pipe | Gas pipe |
|------------------------------------|-------------|------------|
| P140 or below | φ 9.52 | φ 15.88 |
| P141~P200 | φ 9.52 | φ 19.05 |
| P201~P250 | φ 9.52 | φ 22.2 (*) |

(*) With reducer

| Piping sections | | High-pressure side (liquid side) | Low-pressure side (gas side) |
|-----------------------|-----------------|----------------------------------|------------------------------|
| Heat source unit side | PQRY-P200YGM-A | φ 15.88 (Braze) | φ 19.05 (Braze) |
| | PQRY-P250YGM-A | φ 19.05 (Braze) | φ 22.2 (Braze) |
| | PQRY-P400YSGM-A | φ 22.2 (Braze) | φ 28.58 (Braze) |
| | PQRY-P500YSGM-A | | |
| Indoor unit side | | φ 9.52 (Flare) | φ 15.88 (Flare) |

(3) BC controller (sub) end connection piping size

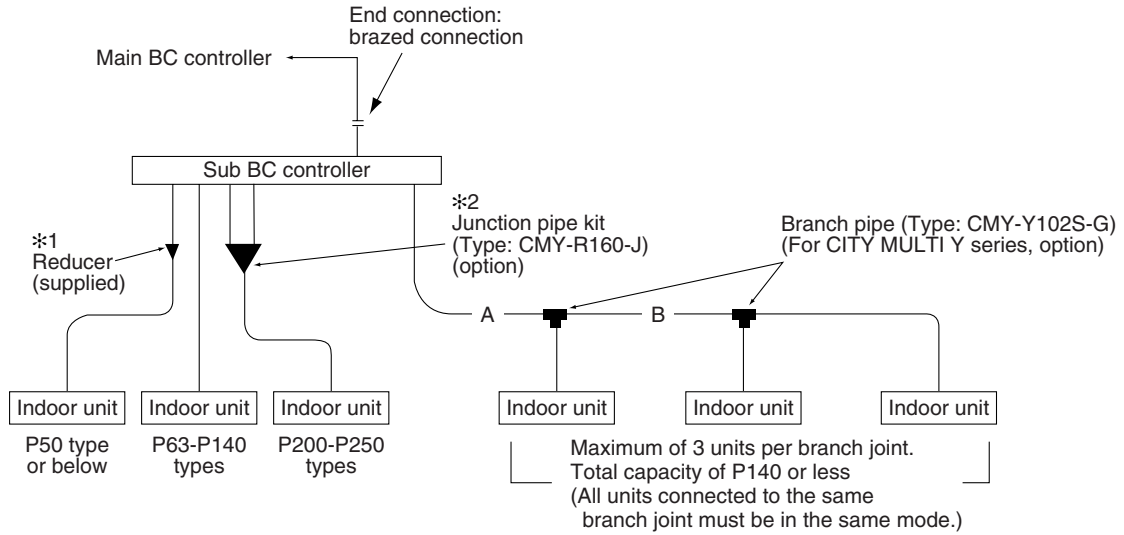

The size of the branch end connection on the BC controller is designed to fit P63-P140 type indoor units. To connect other types of indoor units, perform the following procedures.

- *1: To connect P20-P50 type indoor units, use the reducer that is supplied with the BC controller
- *2: To connect P200 or P250 type indoor units (or when the total capacity of the indoor units exceeds P141), use an optional junction pipe kit (Type: CMY-R160-J) and merge the 2 joints.
- *3: To connect multiple indoor units to a branch joint (or to a junction pipe)
 - Total capacity of connectable indoor units : P140 or below (P250 or below when a junction pipe is used)
 - The number of connectable indoor units : 3 max.
 - Selection of refrigerant piping (pipe size of the A and B in the figure above) :
Use the total capacity of the downstream indoor units to determine the proper pipe size, using the table below as a reference.

| Total capacity of the indoor units | Liquid pipe | Gas pipe |
|------------------------------------|-------------|------------|
| P140 or below | φ 9.52 | φ 15.88 |
| P141~P200 | φ 9.52 | φ 19.05 |
| P201~P250 | φ 9.52 | φ 22.2 (*) |

(*) With reducer

| Item | Piping sections | | | |
|--------------------|--|----------------------------------|------------------------------|----------------|
| | Total capacity of indoor units connected to applicable BC controller | High-pressure side (liquid side) | Low-pressure side (gas side) | Liquid side |
| BC controller side | P200 type and below | φ 15.88 (Braze) | φ 19.05 (Braze) | φ 9.52 (Braze) |
| | P201-P300 types | φ 19.05 (Braze) | φ 22.2 (Braze) | |
| | P301 types and above | | φ 28.58 (Braze) | φ 12.7 (Braze) |

3 Components of the Heat source Unit

[1] Appearance of the Components and Refrigerant Circuit

< PQRY-P200, P250 >

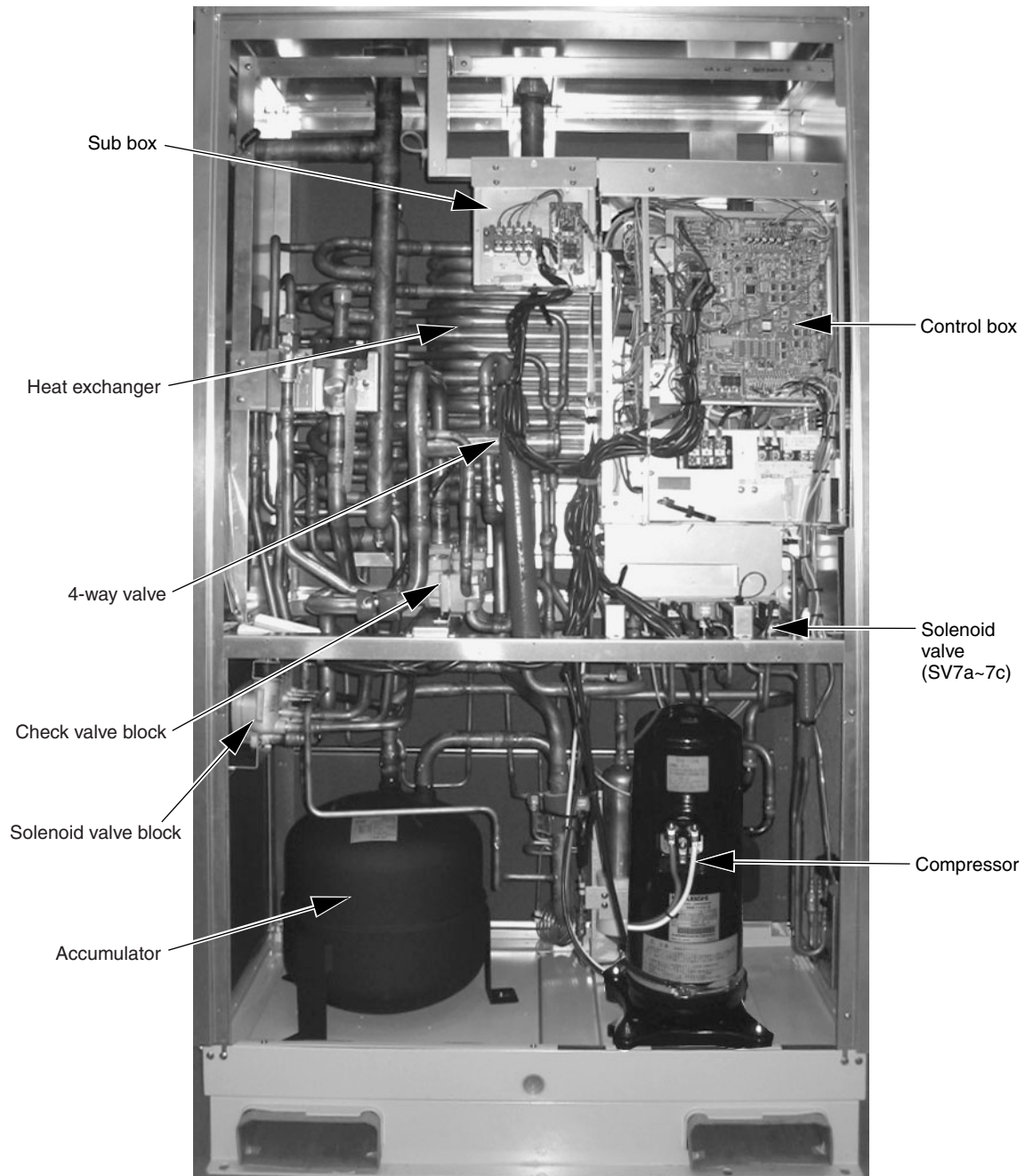

< PQHY-P200, P250 >

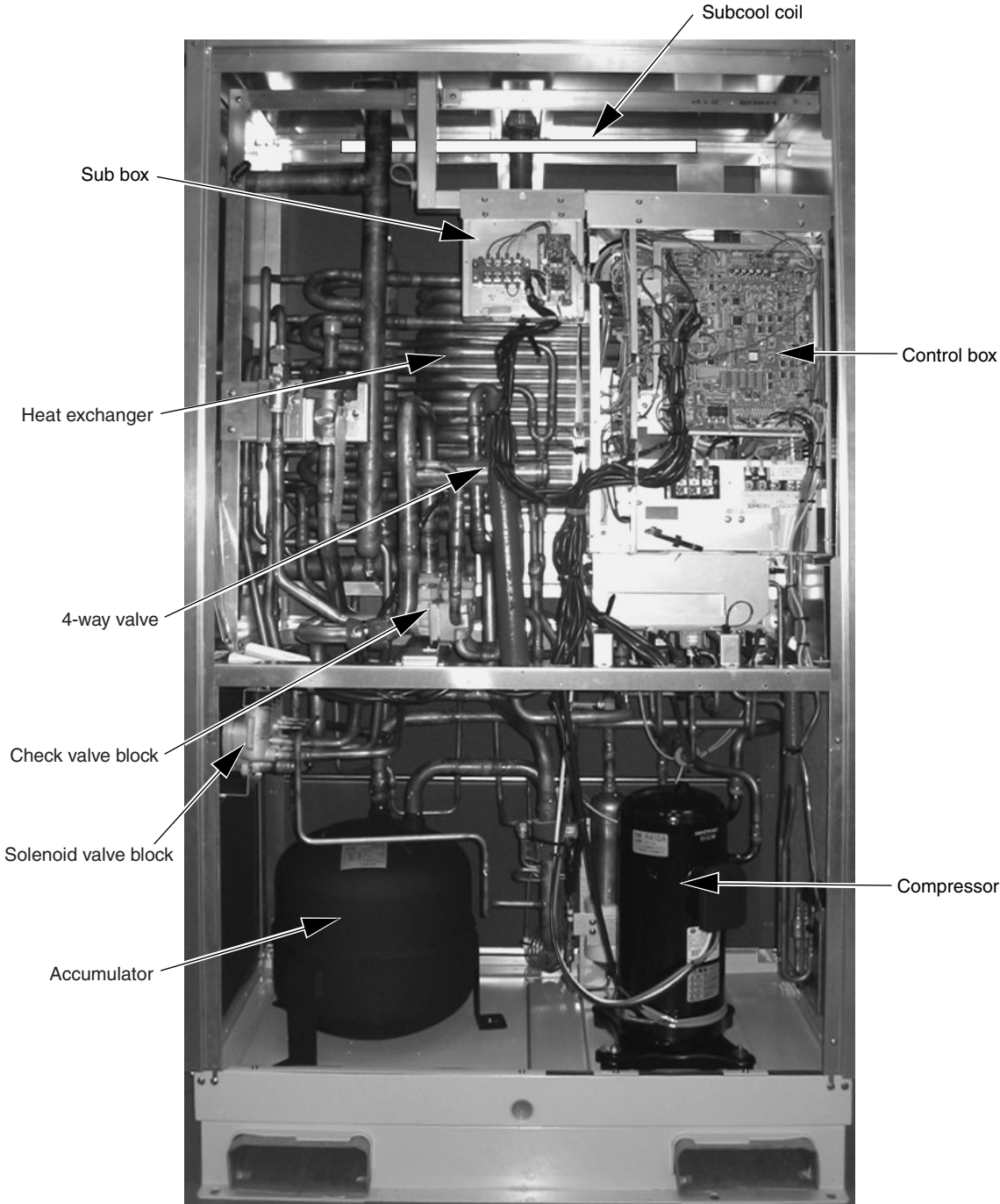

< PQRV-P400, P500 (Compressor unit) >

< PQHY-P400, P500 (Compressor unit) >

※This unit is both for PQHY and PQRV.

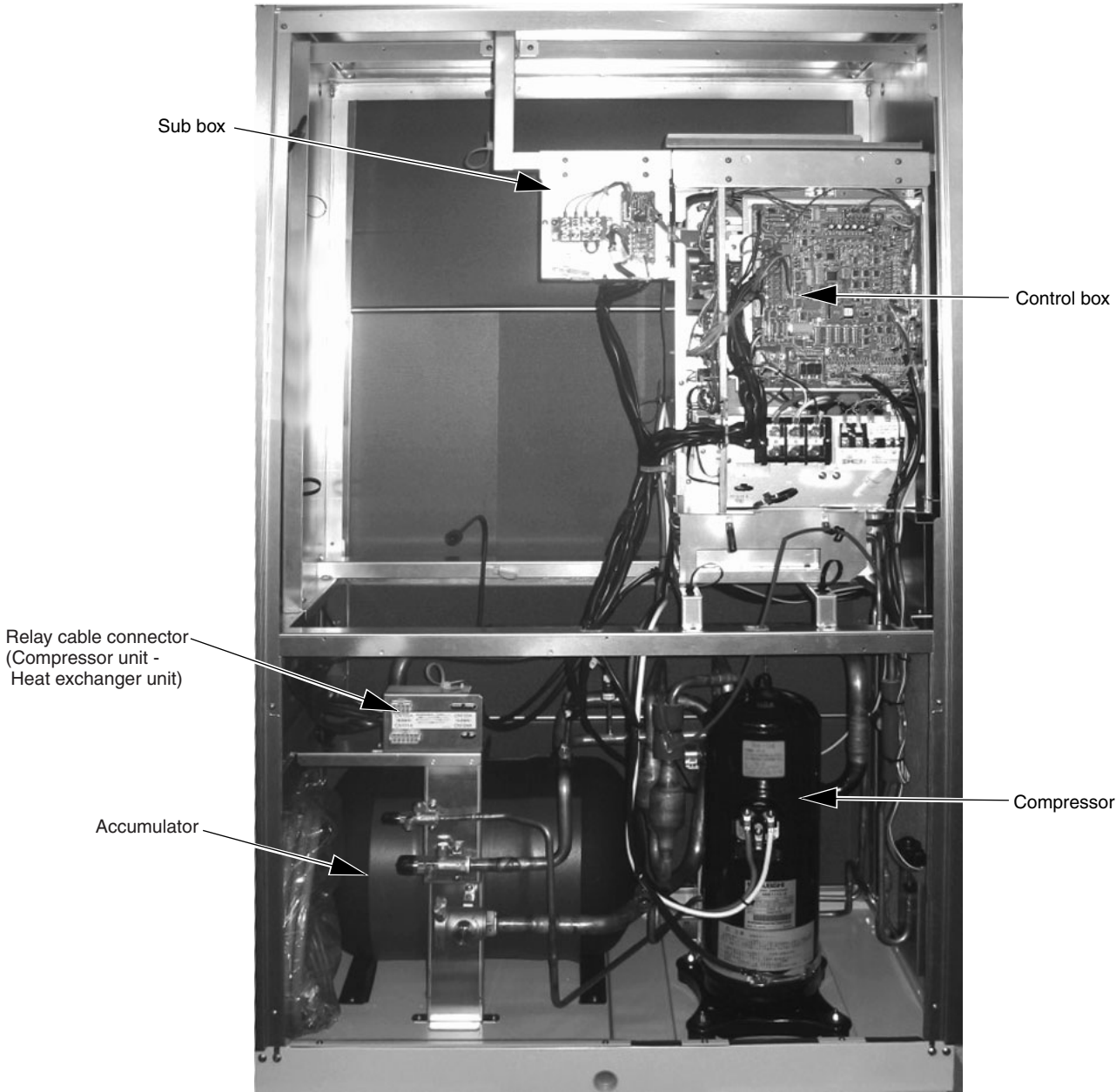

< PQRV-P400, P500 (Heat exchanger unit) >

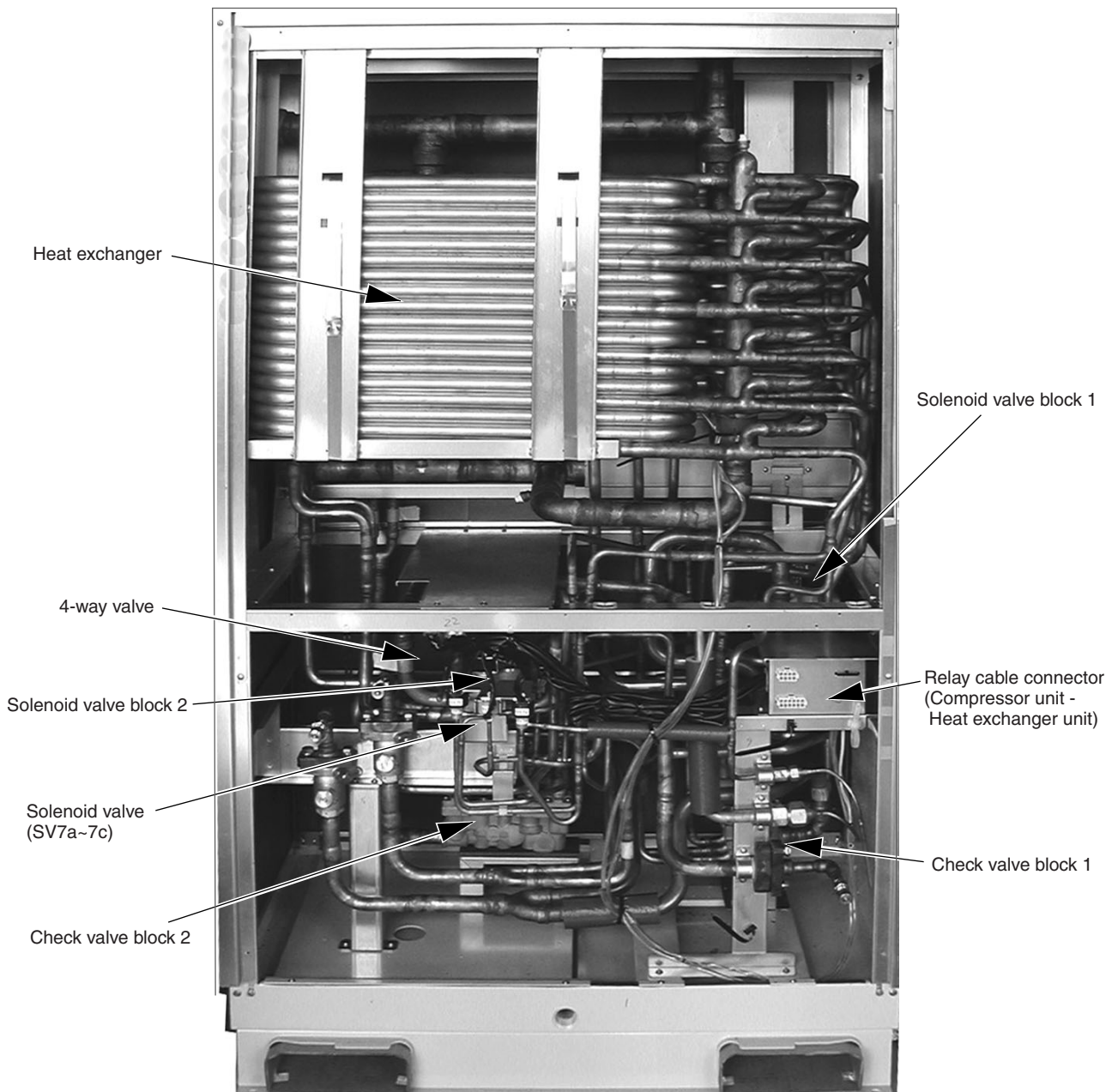

< PQHY-P400, P500 (Heat exchanger unit) >

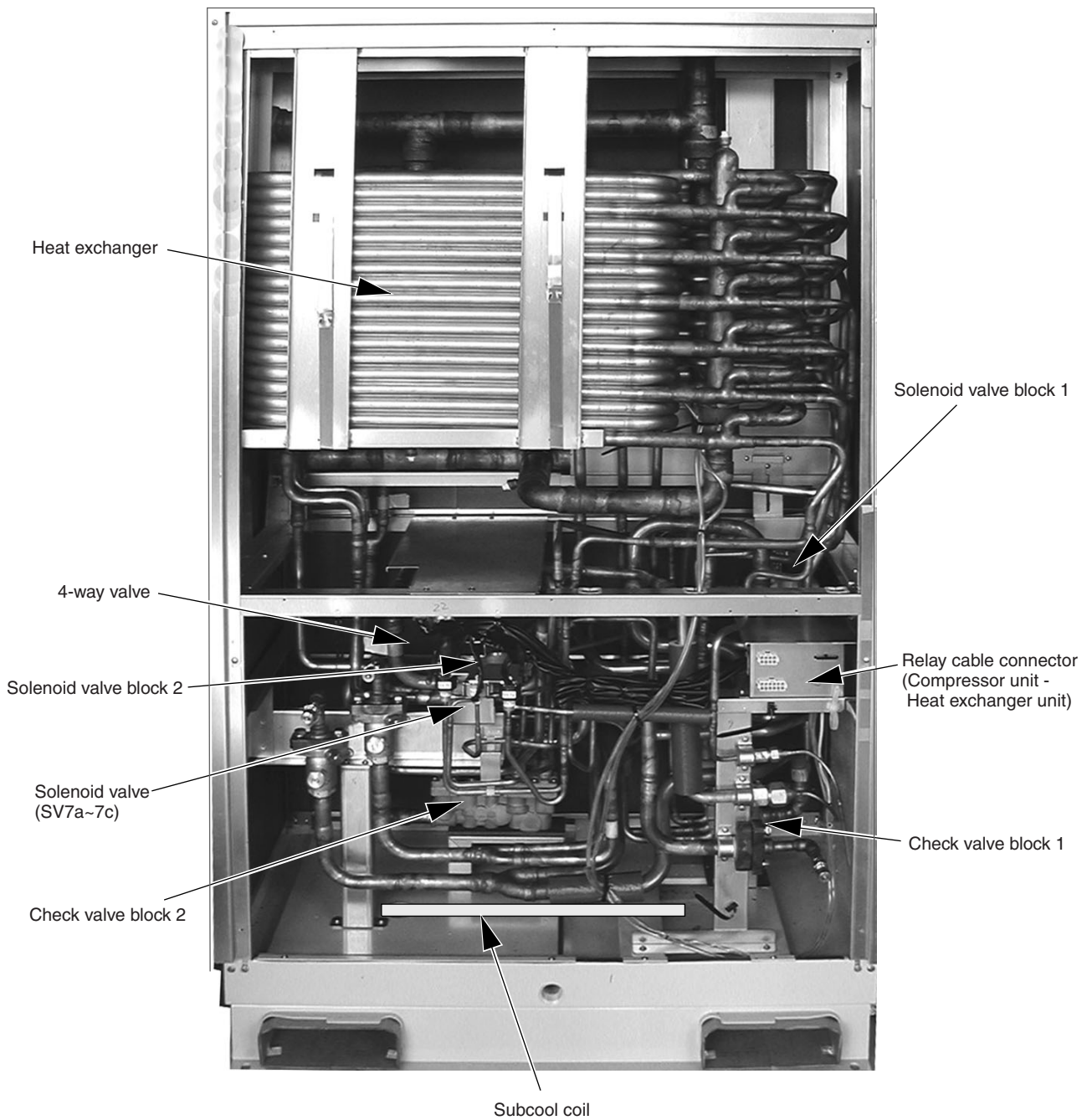

[2] Control Box

[Appearance]

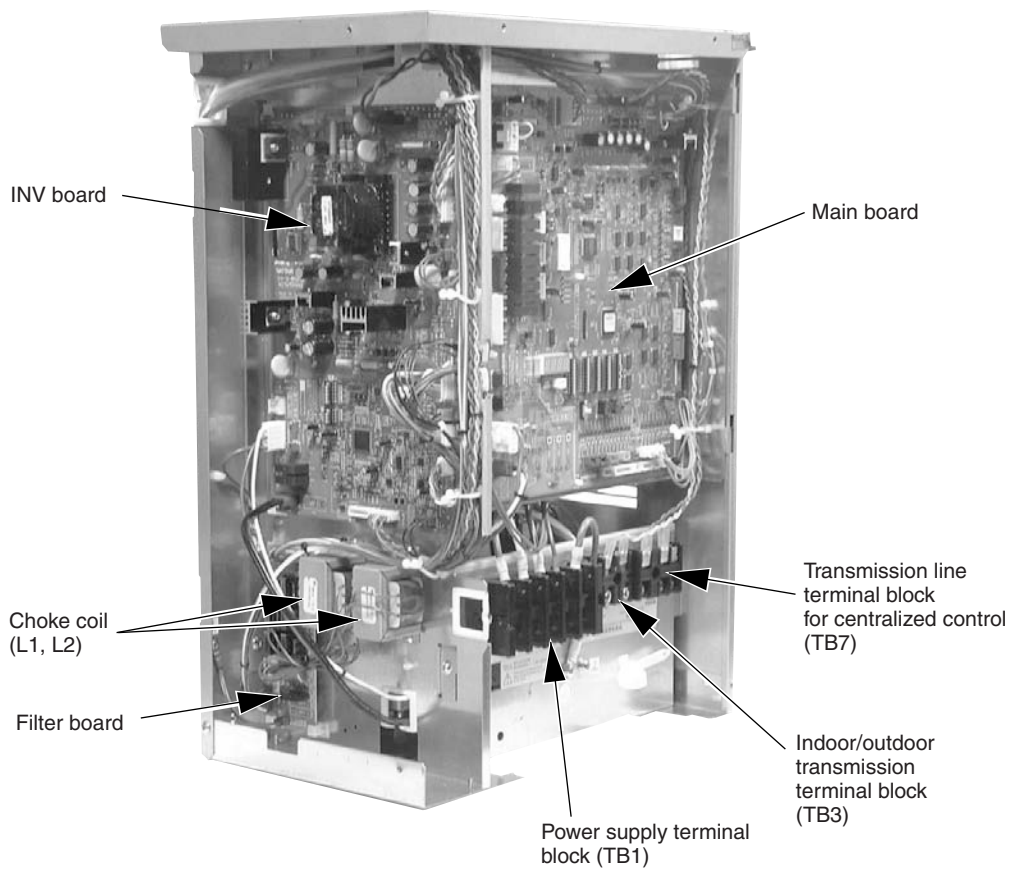

[Under the circuit board cover]

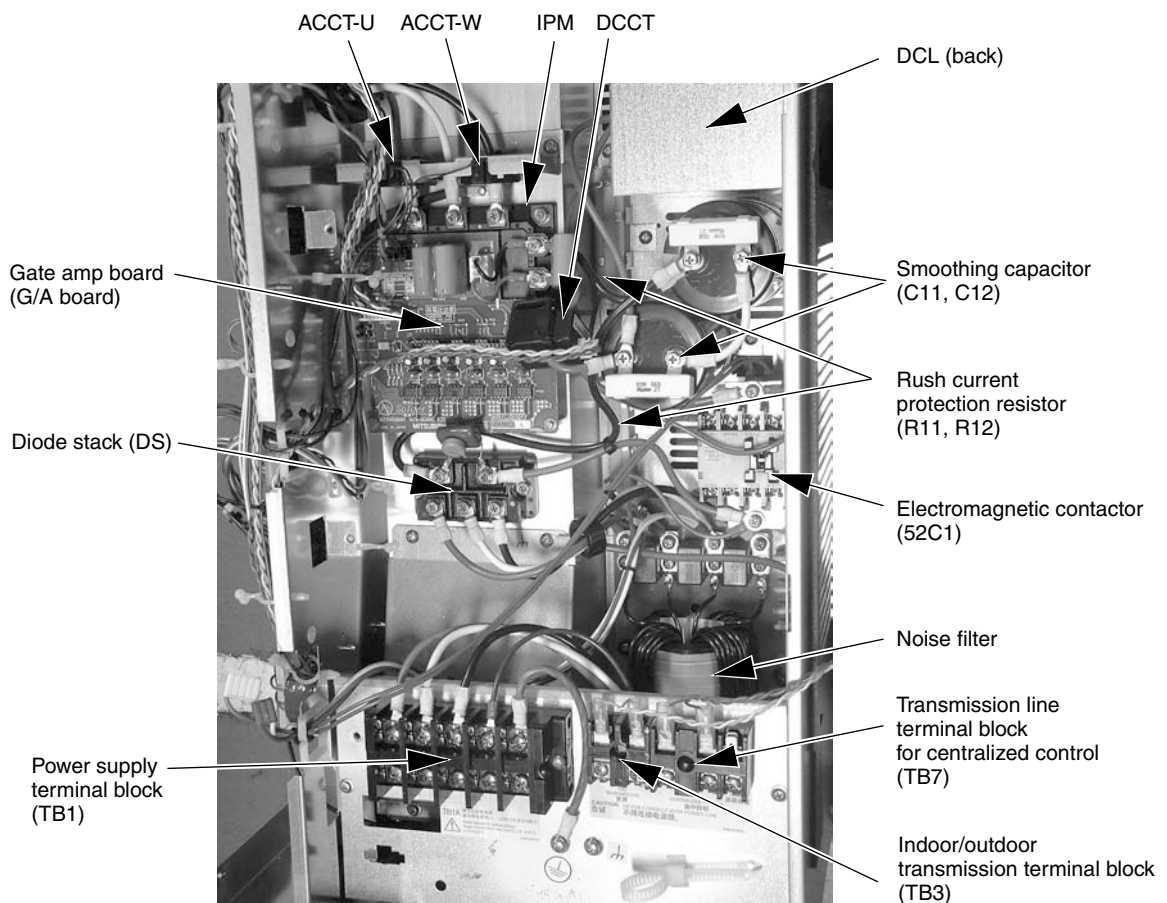

[Sub box]

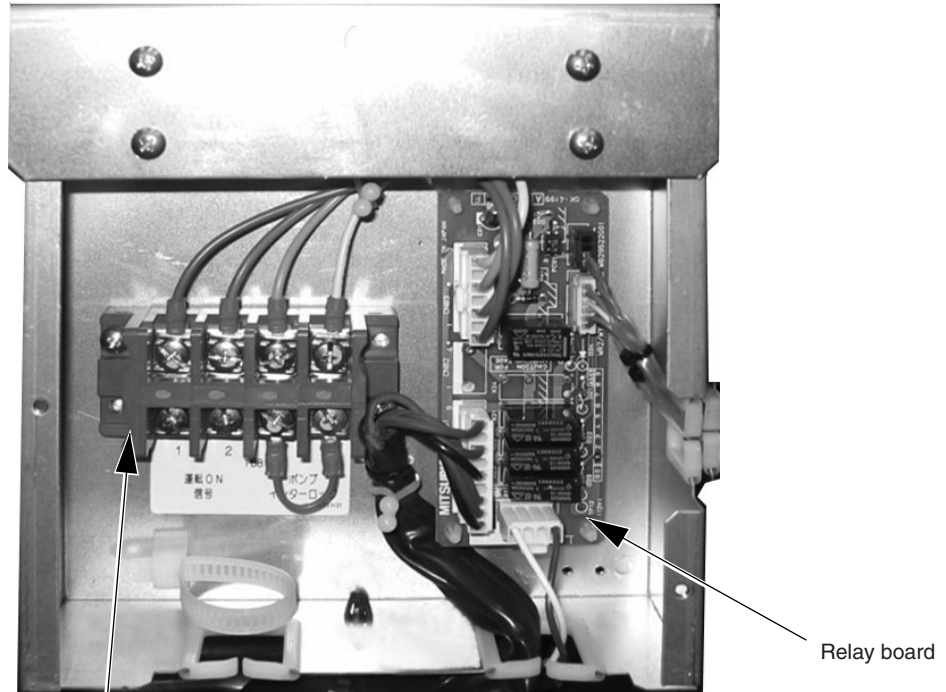

Pump interlock input
Operation-ON signal output terminal block
(TB8)

[3] Circuit Board

1. Main board

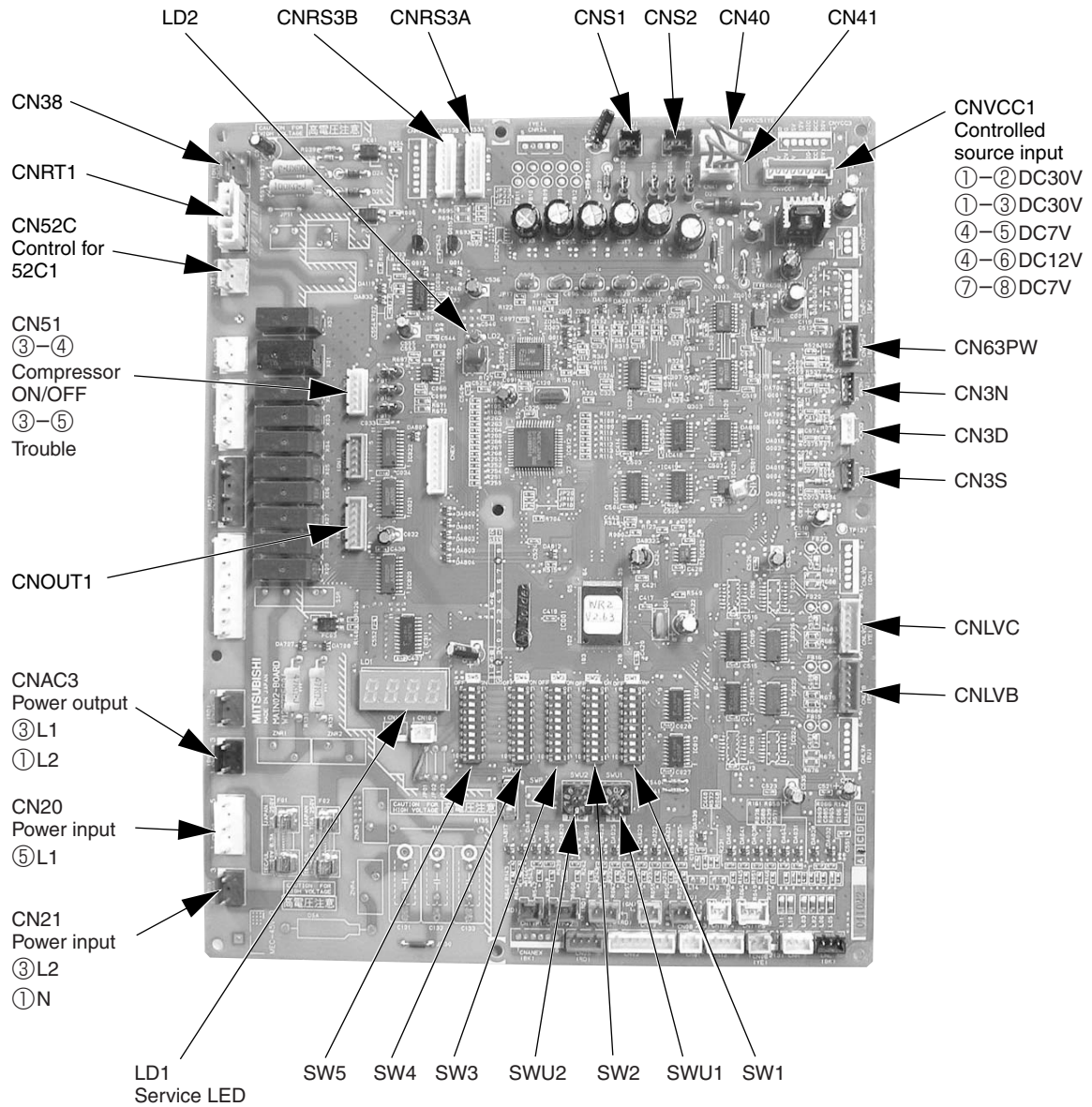

2. INV board

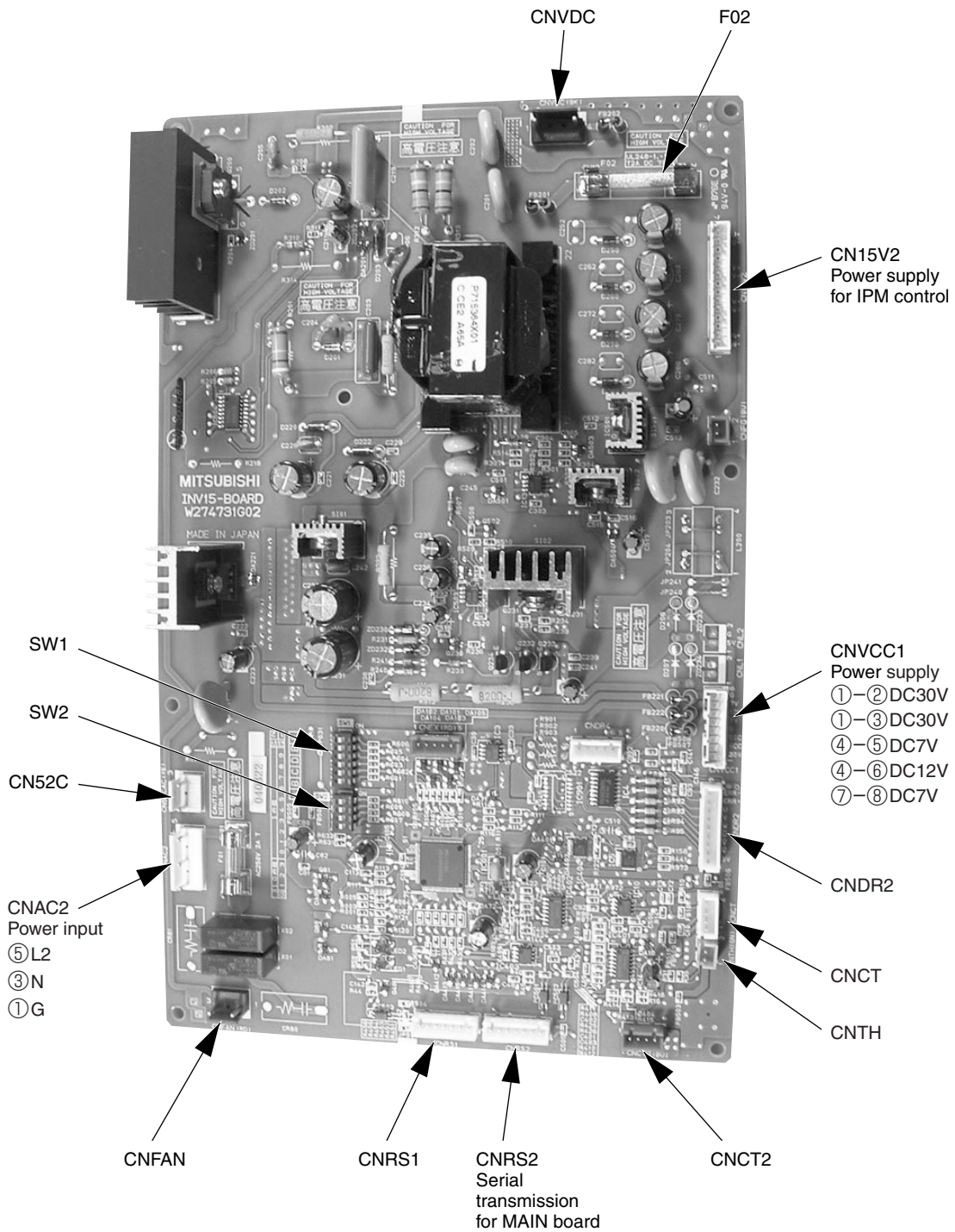

3. Filter board

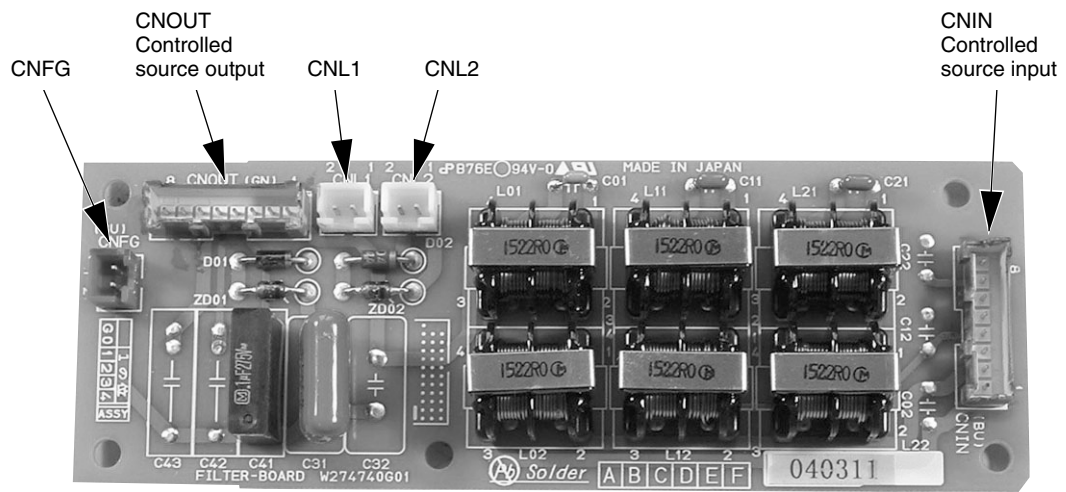

4. G/A board

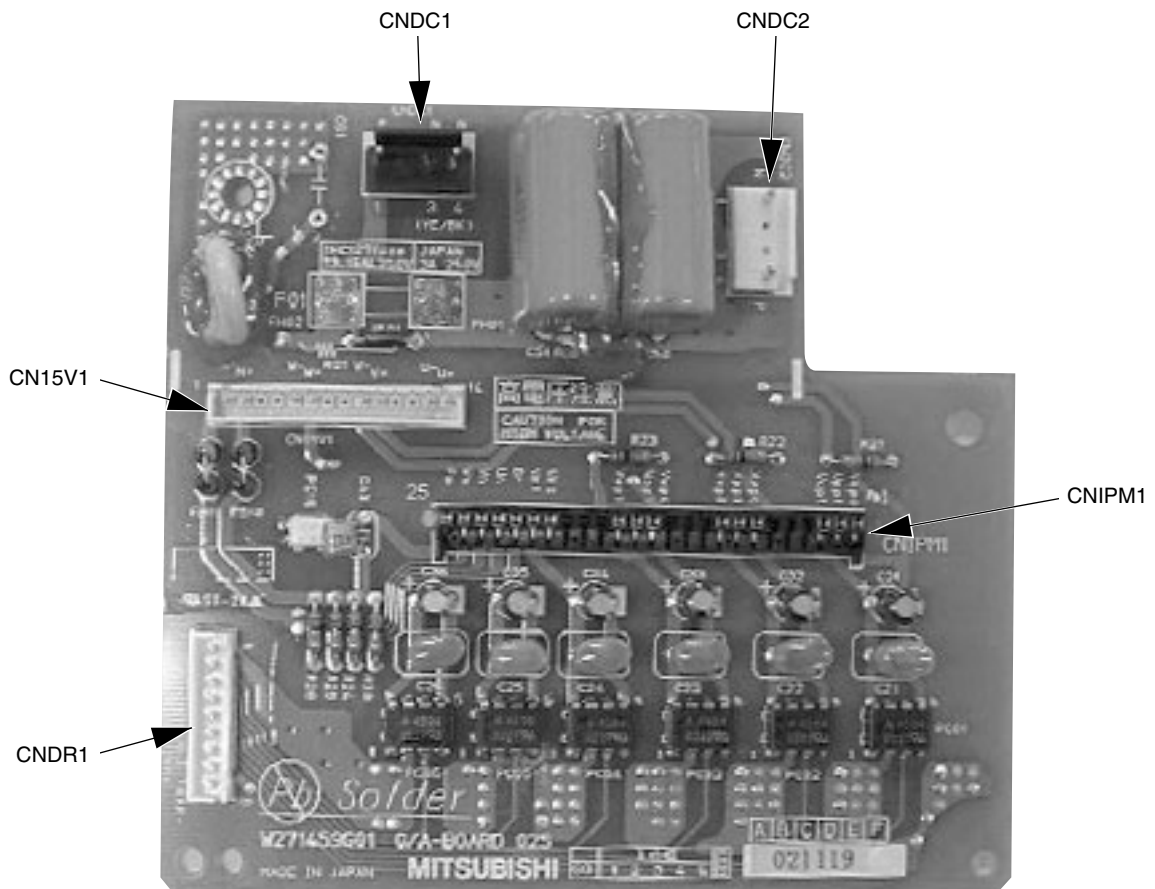

5. Relay board (Heat source unit)

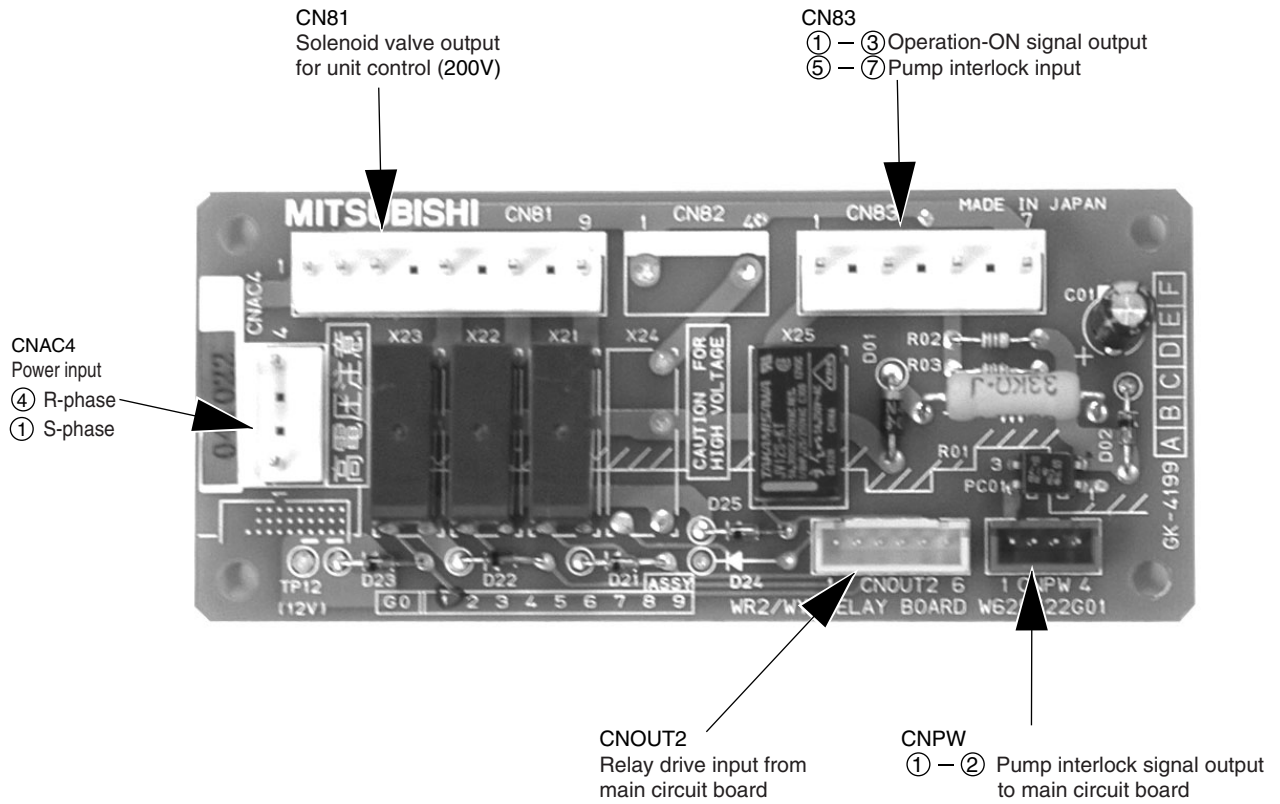

[4] BC controller (inside the panel)

< CMB-P○V-G(A) >

[Front (CMB-P1016V-G(A) is shown in the picture)]

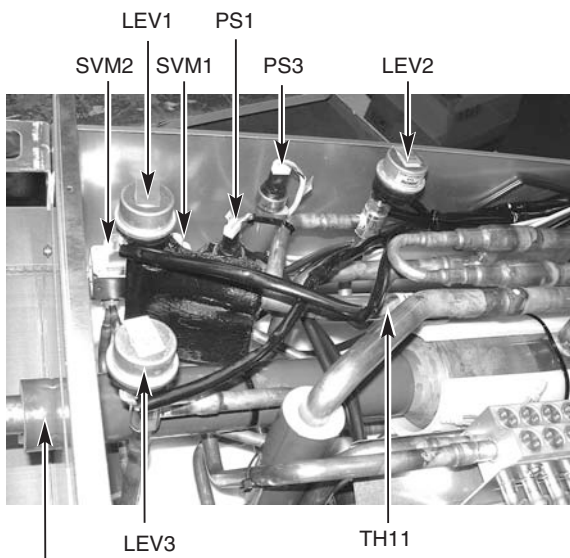
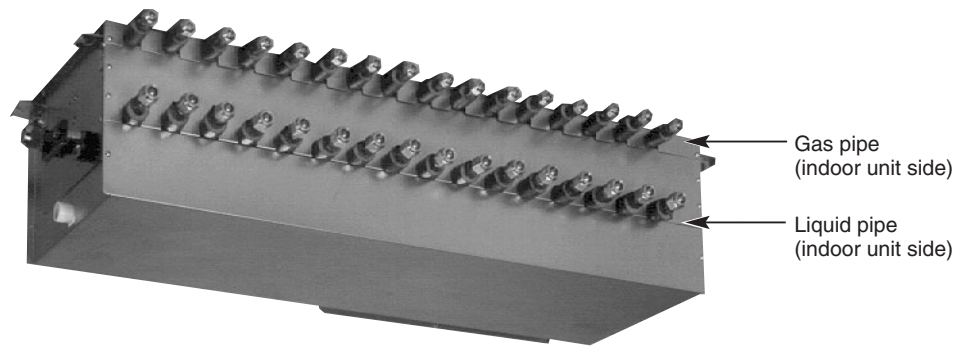

High-pressure side (Heat source unit side)

* No SVM2 on G type

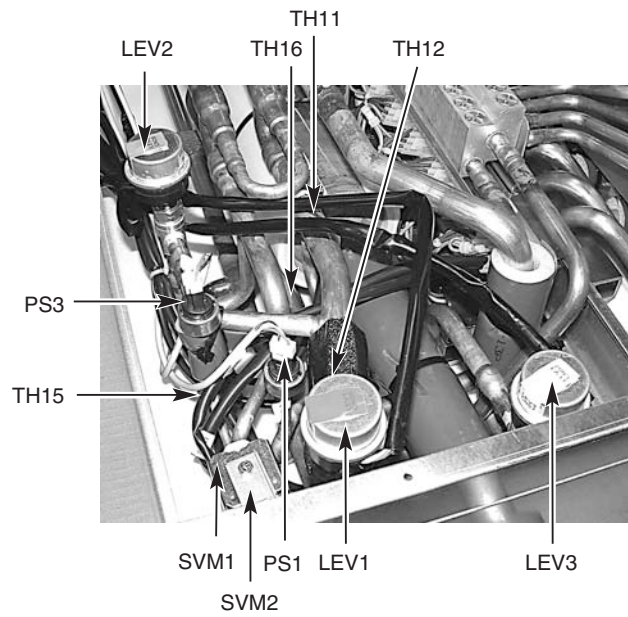

< CMB-P1016V-G >

[Rear view (CMB-P1016V-G(A) is shown in the picture)]

< CMB-P1016V-G >

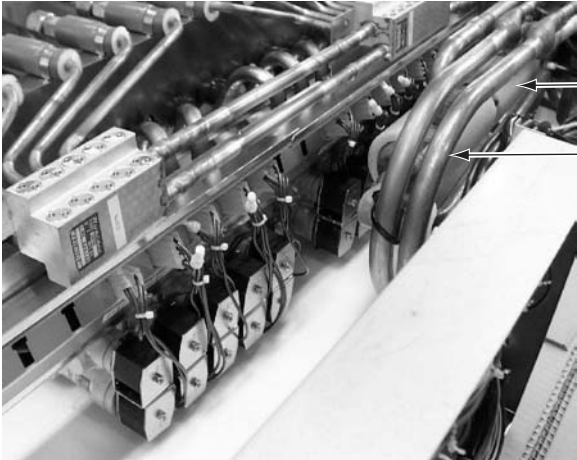

Gas-liquid separator

Tube-in-tube heat exchanger

< CMB-P1016V-GA >



Tube-in-tube heat exchanger

Gas-liquid separator

< CMB-P○V-GB >

[Front view (CMB-P104V-GB is shown in the picture)]

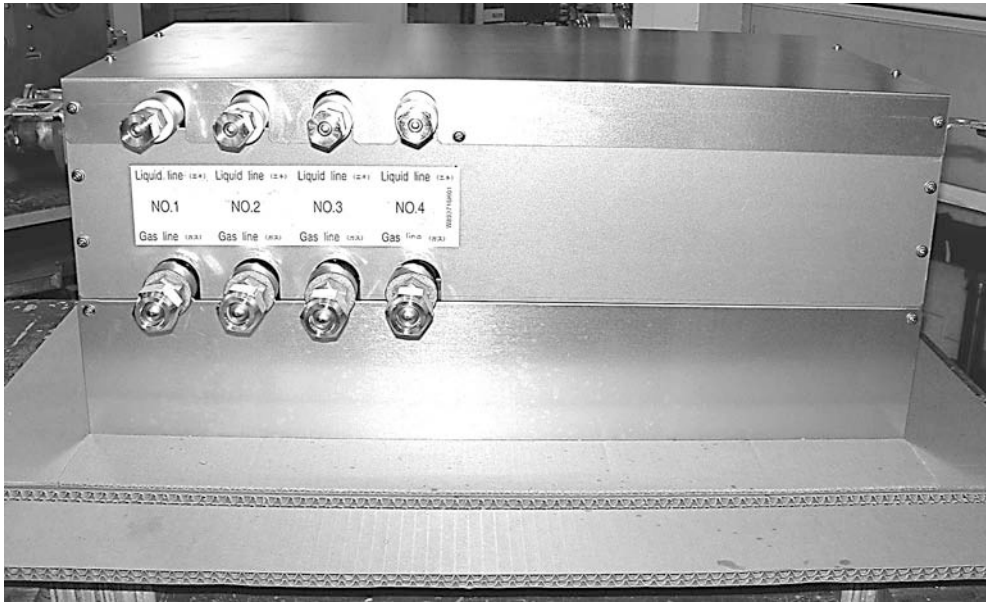

[Rear view (CMB-P104V-GB is shown in the picture)]

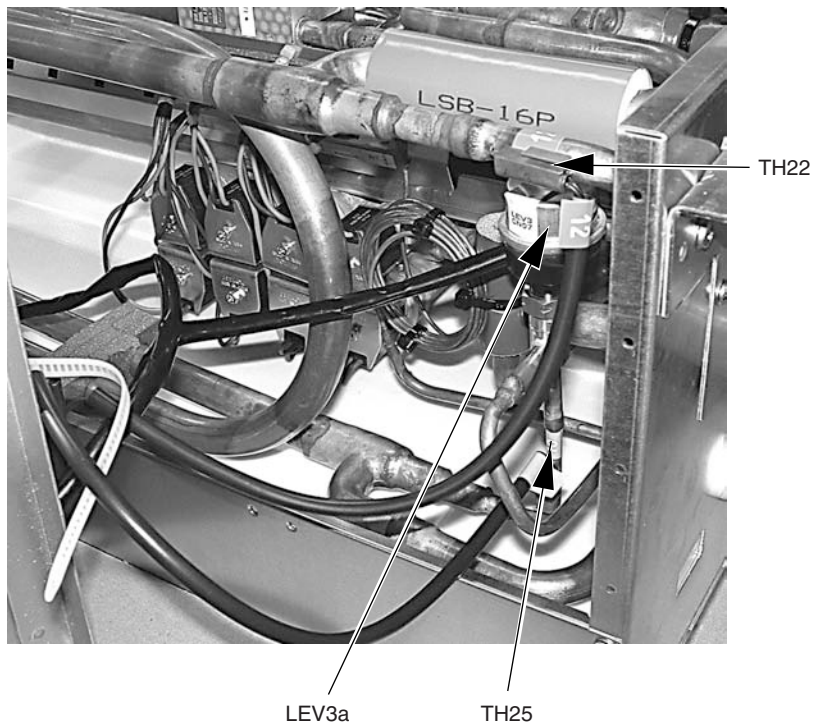

[5] BC control box

[BC controller control box (CMB-P1016V-GA is shown in the picture)]

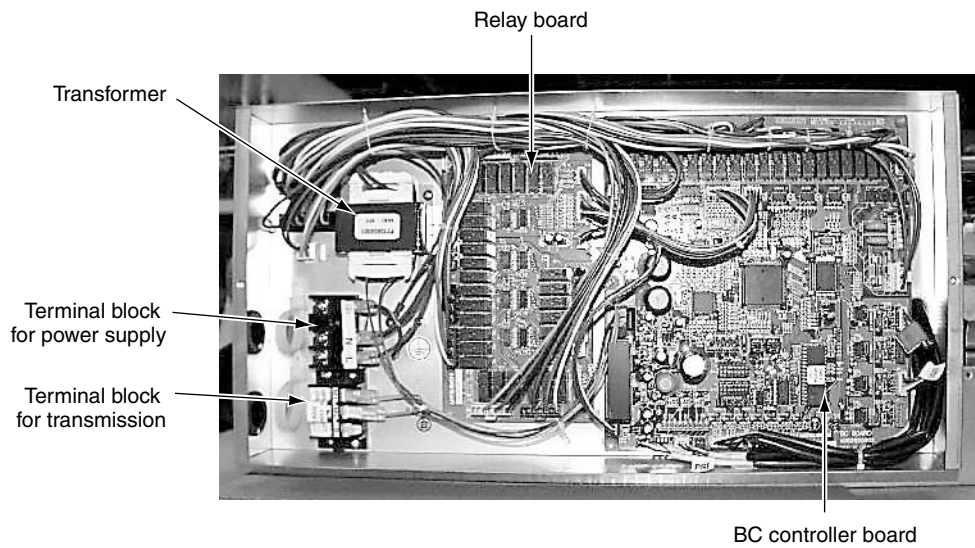

[6] BC controller board

[BC controller board]

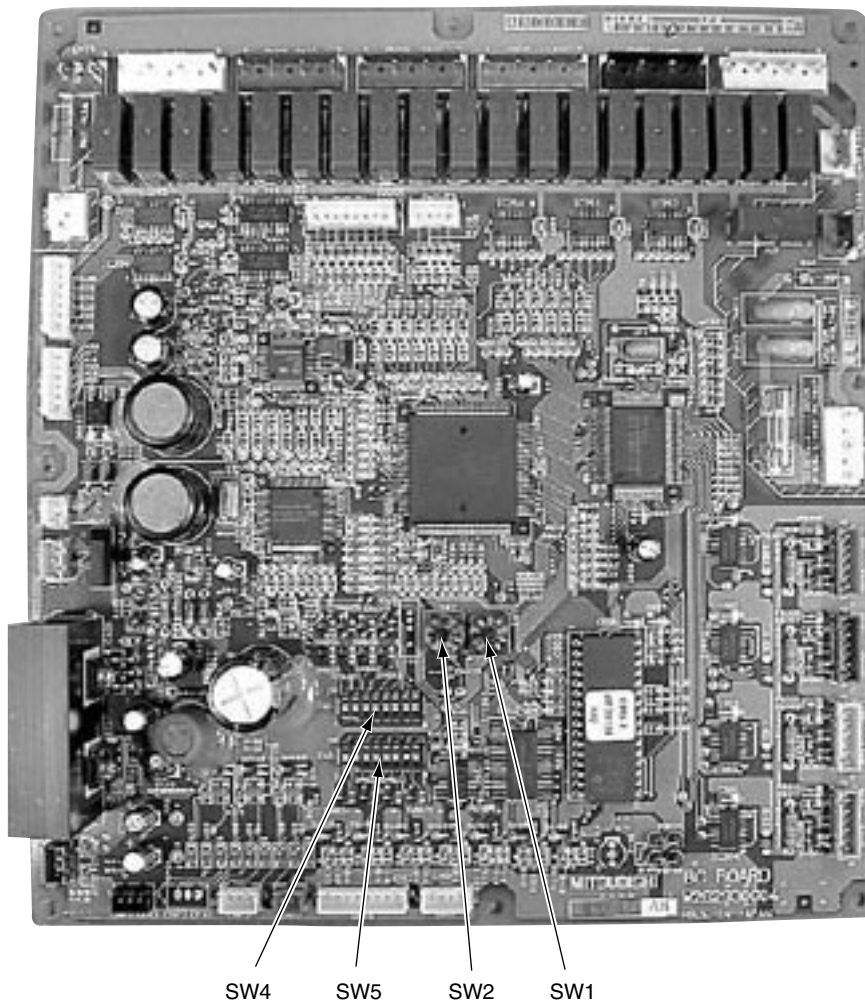

[Relay board (RELAY 4 board)]

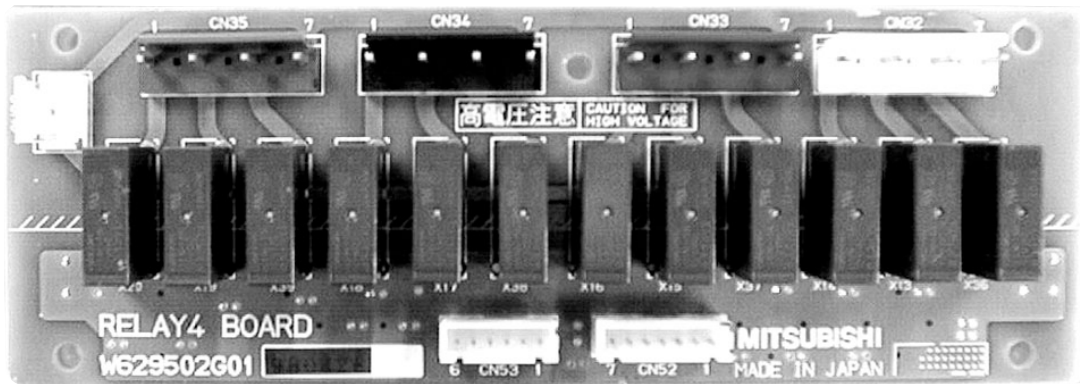

[Relay board (RELAY 10 board)]

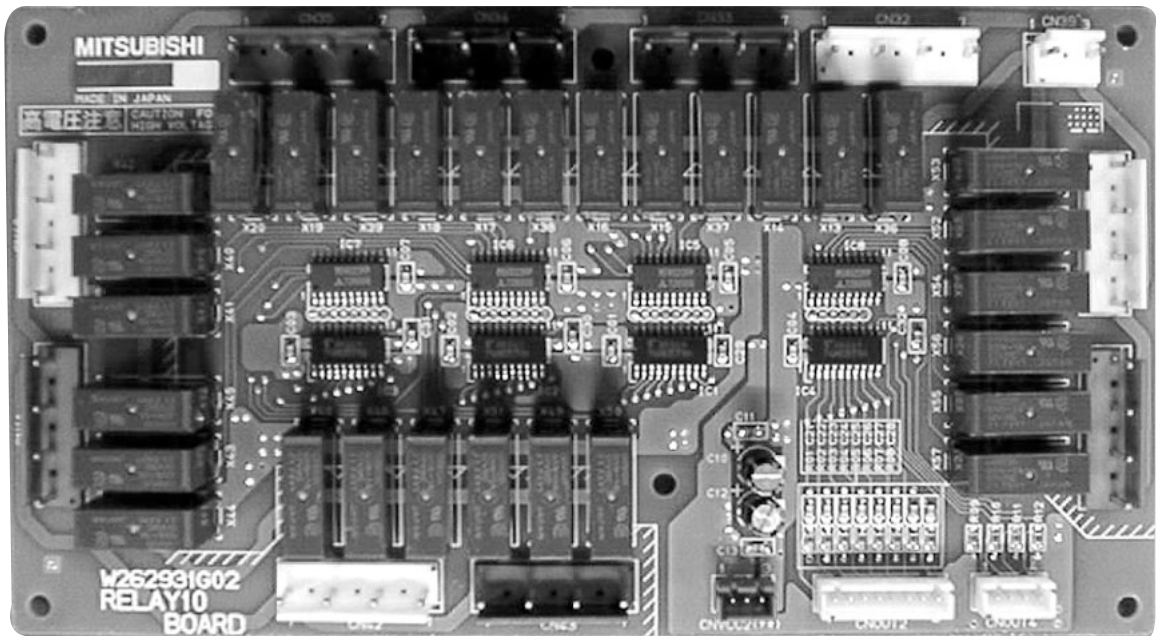

4 Remote Controller

[1] Functions and Specifications of MA and ME Remote Controllers

There are two types of remote controllers: M-NET (ME) remote controller, which is connected on the indoor/outdoor transmission line, and MA remote controller, which is connected to each indoor unit.

1. Comparison of Functions and Specifications of MA and ME Remote Controllers

| Function/specification | MA remote controller (Notes 1, 4) | M-NET(ME)Remote Controller (Notes 2, 4) |
|--|--|--|
| Remote controller address setting | Not required | Required |
| Indoor/outdoor unit address setting | Not required (required only by a system with one outdoor unit)(Note 3) | Required |
| Wiring method | Non-polar 2 wires ※ Daisy-chain the indoor units with non-polar 2 wires when running a group operation. | Non-polar 2 wires |
| Installation location of remote controller | Connectable to any indoor unit in the group | Connectable at any point on the indoor/outdoor transmission line |
| Interlocking with the ventilation unit | Each indoor unit can individually be interlocked with a ventilation unit. (Registered on the remote controller in the same group) | Each indoor unit can individually be interlocked with a ventilation unit. (Registered on the remote controller) |
| Making group changes | MA remote controller wires between indoor units require rewiring. | Indoor unit and remote controller addresses must be changed, or the registration information must be changed using MELANS. |

(Note 1) MA remote controller includes MA remote controllers, MA compact remote controllers, and wireless remote controllers.

(Note 2) M-NET remote controller includes ME remote controllers and compact remote controllers.

(Note 3) Depending on the system configuration, even a single refrigerant system may require an address setting.

(Note 4) Either an MA remote controller or an M-NET remote controller can be connected to a group of multiple-refrigerant systems or when a system controller is connected.

2. Selecting the Best Type of Remote Controller

Select either the MA remote controller or the M-NET remote controller to take full advantage of a given system.

The following information is provided as a reference for selection.

| MA remote controller (Notes 1, 2) | M-NET (ME) remote controller (Notes 1, 2) |
|---|---|
| <ul style="list-style-type: none"> • Low chances of system expansion and grouping changes are expected. • Grouping (floor plan) has been decided at the time of installation. | <ul style="list-style-type: none"> • High chances of centralized installation of remote controllers, system expansion, and grouping changes. • Grouping (floor plan) has not been decided at the time of installation. • Direct connection of the remote controller to the Lossnay inside the heater-humidifier. |

(Note 1) M-NET remote controllers and MA remote controllers cannot both be connected to the same group of indoor units.

(Note 2) A system controller must be connected to a system that has both MA remote controllers and M-NET remote controllers.

< A system using an MA remote controller >

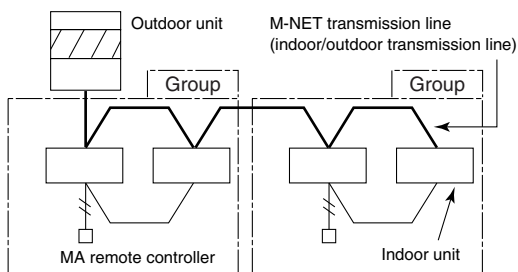

< System using an M-NET remote controller >

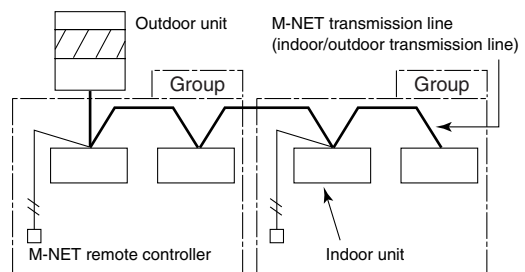

[2] Group Setting and Interlocking Settings that are Made on an ME Remote Controller

1. Group setting/interlocking setting

Make the following settings to perform a group operation of units that are connected to different outdoor units or to manually set up the indoor/outdoor unit address.

- (A) Group settings.....Registration of the indoor units to be controlled with the remote controller, and search and deletion of registered information.
- (B) Interlock settings.....Registration of LOSSNAY units to be interlocked with the indoor units, and search and deletion of registered information

[Operation Procedures]

(1) Address settings

Register the indoor unit to be controlled with the remote controller.

① Bring up either one of the following displays on the remote controller:

The blinking display of “HO,” which appears when the power is turned on, or the normal display, which appears when the unit is stopped. The display window must look like one of the two figures below to proceed to the next step.

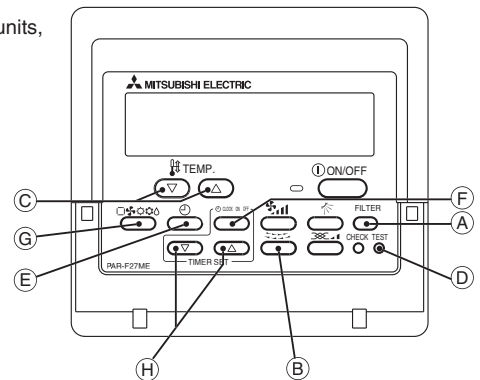
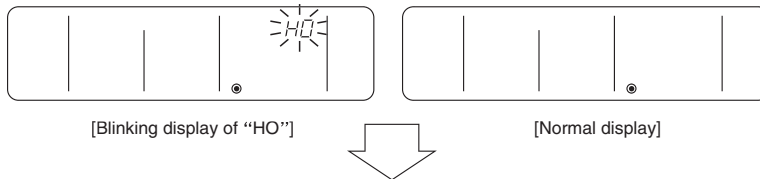

(A) Group Settings

② Bring up the “Group Setting” window.

-Press and hold buttons (A) [FILTER] and (B) [Louver] simultaneously for 2 seconds to bring up the display as shown below.

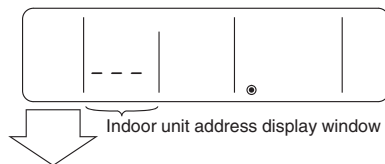

③ Select the unit address.

- Select the address of the indoor unit to be registered by pressing button (C) [SET TEMP. (▽) or (△)] to advance or go back through the addresses.

④ Register the indoor unit whose address appears on the display.

- Press button (D) [TEST] to register the indoor unit address whose address appears on the display.
- If registration is successfully completed, unit type will appear on the display as shown in the figure below.
- If the selected address does not have a corresponding indoor unit, an error message will appear on the display. Check the address, and try again.

<Successful completion of registration>

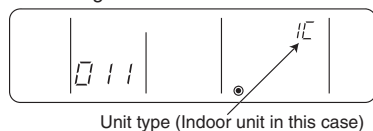

<Deletion error>

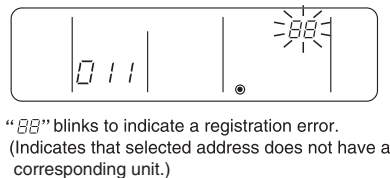

⑤ To register the addresses for multiple indoor units, repeat steps ③ and ④ above.

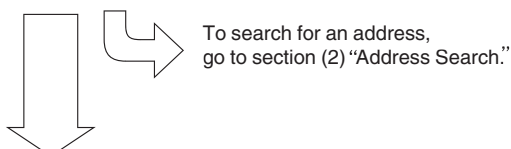

(B) Interlock Settings

⑥ Bring up the “Interlock Setting” window.

-Press button (G) [MODE] to bring up the following display. Press again to go back to the “Group Setting” window as shown under step ②.

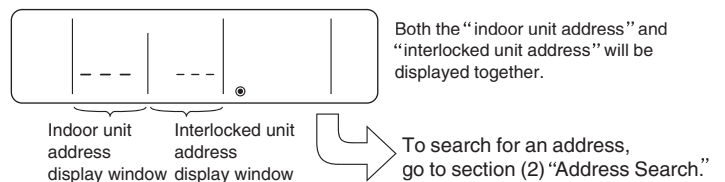

⑦ Bring up the address of the indoor unit and the address of the LOSSNAY to be interlocked on the display.

- Select the address of the indoor unit to be registered by pressing button (C) [SET TEMP. (▽) or (△)] to advance or go back through the addresses.
- Select the address of the LOSSNAY unit to be interlocked by pressing button (H) [TIMER SET (▽) or (△)] to advance or go back through the “interlocked unit addresses.”



⑧ Make the settings to interlock LOSSNAY units with indoor units.

- Press button (D) [TEST] while both the indoor unit address and the address of the LOSSNAY units to be interlocked are displayed to enter the interlock setting.
- Interlock setting can also be made by bringing up the LOSSNAY address in the indoor unit address display window and the indoor unit address in the interlocked unit address display window.

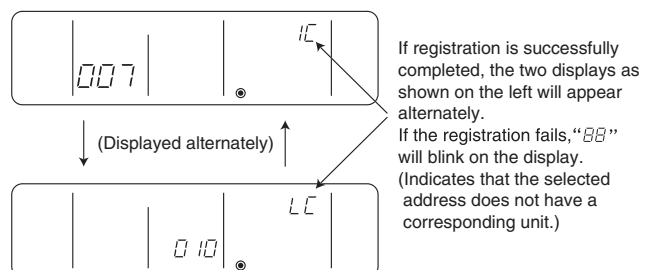

NOTE : Interlock all the indoor units in the group with the LOSSNAY units; otherwise, the LOSSNAY units will not operate.



(C) To return to the normal display

When all the group settings and interlock settings are made, take the following step to go back to the normal display.

- ⑩ Press and hold buttons **A [FILTER]** and **B [Louver]** simultaneously for 2 seconds to go back to the window as shown in step ①.

⑨ Repeat steps ⑦ and ⑧ in the previous page to interlock all the indoor units in a group with the LOSSNAY unit.

To go back to the normal display, follow step ⑩.

To search for an address, go to section (2) "Address Search."

(2) Address search

To search for the address of indoor units that have been entered into the remote controller, follow steps ① and ②.

(A) To search group settings

⑪ Bring up the "Group Setting" window.

- Each pressing of button **E [TIMER]** will bring up the address of a registered indoor unit and its unit type on the display.

<Entry found>



Unit type
(Indoor unit in this case)

<No entries found>



- When only one unit address is registered, the same address will remain on the display regardless of how many times the button is pressed.
- When the address of multiple units are registered (i.e. "011", "012", "013"), they will be displayed one at a time in an ascending order with each pressing of button **E [TIMER]**.

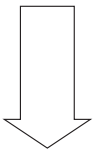

To delete an address, go to section (3) "Address Deletion."

To go back to the normal display, follow step ⑩.

(B) Interlock setting search

After performing step ⑥ proceed as follows:

⑫ Bring up the address of the indoor unit to be searched on the display.

- Select the address of the indoor unit to be searched by pressing button **H [TIMER SET (▽) or (△)]** to advance or go back through the interlocked addresses.



LOSSNAY can be searched in the same manner by bringing up the LOSSNAY address in the Interlocked unit address display window.

⑬ Bring up on the display the address of the LOSSNAY unit that was interlocked with the indoor unit in step ⑫.

- With each pressing of button **E [TIMER]**, the address of the LOSSNAY and indoor unit that is interlocked with it will be displayed alternately.

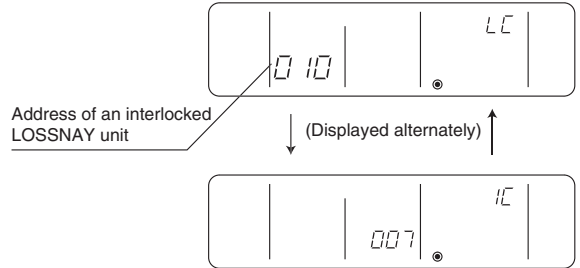

⑭ Bring up the address of another registered unit on the display.

- After completing step ⑬, a subsequent pressing of button **E [TIMER]** will bring up the address of another registered unit.

(The display method is the same as the one in step ⑬.)

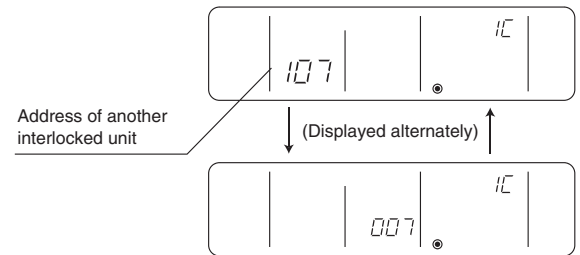

To delete an address, go to section (3) "Address Deletion."

(3) Address deletion

The addresses of the indoor units that have been entered into the remote controller can be deleted by deleting the group settings.

The interlock settings between units can be deleted by deleting the interlock settings.

Follow the steps in section (2) "Address Search" to find the address to be deleted and perform deletion with the address being displayed in the display window. To delete an address, the address must first be brought up on the display.

⑮ Delete the registered indoor unit address or the interlock setting between units.

- Press button **F [CLOCK → ON → OFF]** twice while either the indoor unit address or the address of the interlocked unit is displayed on the display to delete the interlock setting.

(A) To delete group settings

<Successful completion of deletion>

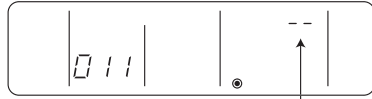

“--” will be displayed in the room temperature display window.

- If a transmission error occurs, the selected setting will not be deleted, and the display will appear as shown below. In this case, repeat the steps above.

<Deletion error>



“BB” will be displayed in the room temperature display window.

To go back to the normal display, follow step ⑩

(B) To delete interlock settings



(Displayed alternately)



If deletion is successfully completed, “--” will appear in the unit type display window. If the deletion fails, “BB” will appear in the unit type display window. In this case, repeat the steps above.

(4) Making (A) Group settings and (B) Interlock settings of a group from any arbitrary remote controller

(A) Group settings and (B) Interlock settings of a group can be made from any arbitrary remote controller. Refer to “(B) Interlock Settings” under section 1 “Group Settings/Interlock Settings” for operation procedures. Set the address as shown below.

(A) To make group settings

Interlocked unit address display window...Remote controller address
Indoor unit address display window.....The address of the indoor unit to be controlled with the remote controller

(B) To make interlock settings

Interlocked unit address display window...LOSSNAY address
Indoor unit address display window.....The address of the indoor unit to be interlocked with the LOSSNAY

2. Remote controller functions selection via the ME remote controller

In the remote controller function selection mode, the settings for three types of functions can be made or changed as necessary.

1) Operation mode display selection mode (Display or non-display of COOL/HEAT during automatic operation mode)

When the automatic operation mode is selected, the indoor unit will automatically perform a cooling or heating operation based on the room temperature. In this case, “AUTO COOL” or “AUTO HEAT” will appear on the remote controller display. This setting can be changed so that only “AUTO” will appear on the display.

2) Room temperature display selection mode (Display or non-display of room temperature)

Although the suction temperature is normally displayed on the remote controller, the setting can be changed so that it will not appear on the remote controller.

3) Narrowed preset temperature range mode

The default temperature ranges are 19°C to 30°C in the cooling/dry mode and 17°C to 28°C in the heating mode.

By changing these ranges (raising the lower limit for the cooling/dry mode and lowering the upper limit for the heating mode), energy can be saved.

NOTE

On the PAR-F27MEA-F model, automatic operation mode cannot be selected while the unit is in the narrowed preset temperature range mode. Only the lower limit can be set for cooling/dry mode, and upper limit for heating mode.

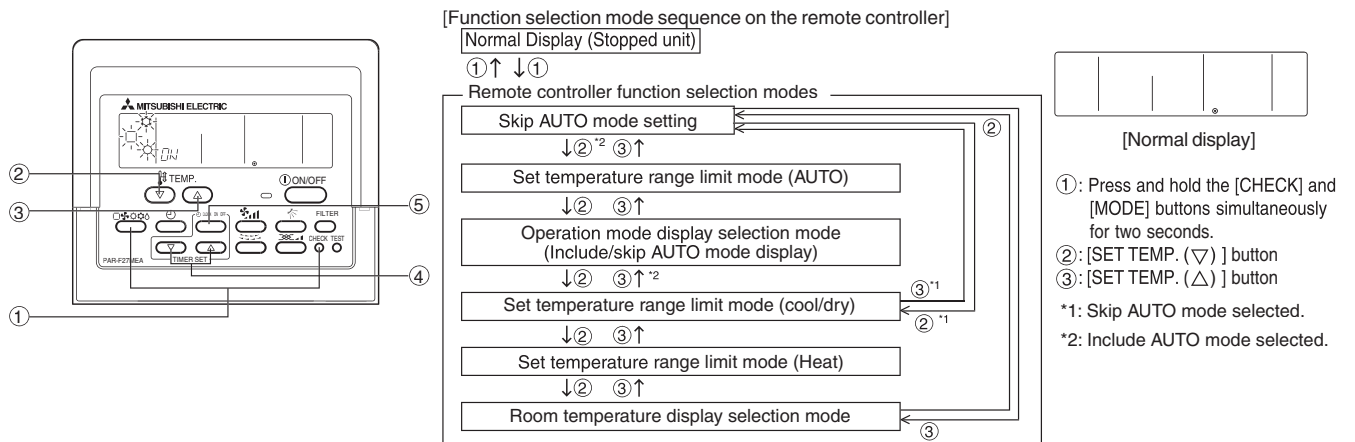

[Operation Procedures]

1. Press the [ON/OFF] button on the remote controller to bring the unit to a stop. The display will appear as shown in the previous page (Normal display).
2. Press buttons ① [CHECK] and [MODE] simultaneously for 2 seconds to go into the “operation mode display selection mode” under the remote controller function selection mode. Press button ② [SET TEMP. (▽)] or ③ [SET TEMP. (△)] to go into the other three modes under the remote controller function selection mode.

Skip AUTO mode setting (when you want to skip AUTO mode)

This setting is only valid when connected to an air conditioner with AUTO mode that supports simultaneous cooling and heating operations.

“□” flashes and “ON” or “OFF” lights. Each time the [Time selection (△) or (▽)] buttons are pressed in this state, the “ON” and “OFF” display is switched.

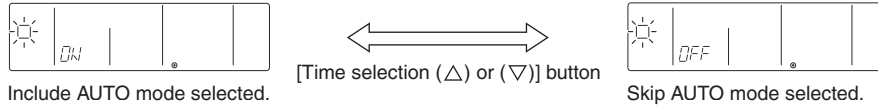

- When “ON” is selected, AUTO mode can be selected using the mode selection button.
- When “OFF” is selected, AUTO mode cannot be selected using the mode selection button and automatic operation is not possible. (When pressing the mode selection button, AUTO mode is skipped.)

Operation mode display selection mode (Display or non-display of room temperature on the remote controller.)

- “AUTO” “COOL/HEAT” will blink, and either “ON” or “OFF” will light up. Press button ④ [TIMER SET (△) or (▽)] in this state to switch between “ON” and “OFF.”

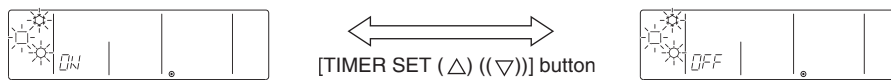

- When it is set to “ON,” “AUTO” and “COOL” or “AUTO” and “HEAT” will appear on the display during automatic operation mode.
- When it is set to “OFF,” only “AUTO” will appear on the display during automatic operation mode.

Room temperature display selection mode (Display or non-display of room temperature)

- “88 °C” will blink in the room temperature display window, and either “ON” or “OFF” will light up. Press button ④ [TIMER SET (△) or (▽)] in this state to switch between “ON” and “OFF.”

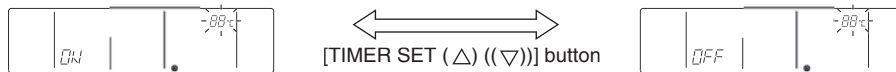

- When it is set to “ON,” the room temperature will stay in the operation display window during operation.
- When it is set to “OFF,” the room temperature will not appear in the operation display window during operation.

Narrowed preset temperature range mode (The range of preset temperature can be changed.)

1) Temperature range setting for the cooling/dry mode

“COOL/DRY” and “LIMIT TEMP.” will light up in the display window, and the temperature range for the cooling/dry mode will appear on the display. The lower limit temperature will be blinking in the preset temperature display window. While it is blinking, the temperature setting can be changed. [Selection range for the lower limit temperature] : 19 °C ↔ 30 °C (Medium temperature range indoor unit 14 °C ↔ 30 °C) (The upper limit temperature is fixed at 30 °C. Only the lower limit temperature is changeable.)

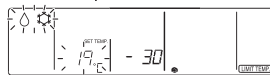

[When the temperature range for the cooling or dry mode is set to 24 °C to 30 °C]

- 2) Press button ④ [TIMER SET (△) or (▽)] to set the lower limit temperature to the desired temperature.

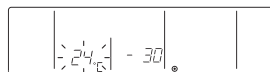

[When the temperature range is changed to 24 °C - 30 °C]

- 3) After completing the step above, press button ② [SET TEMP. (▽)] to go into the temperature range setting mode to set the temperature range for the heating operation.

“HEAT” and “LIMIT TEMP.” will light up, and the temperature range for the heating mode will appear on the screen.

The upper limit temperature can be changed with button ④ [TIMER SET (△) or (▽)].

[Selection range for the upper limit temperature] : 17 °C ↔ 28 °C (Medium temperature range indoor unit 17 °C ↔ 28 °C)

(The lower limit temperature is fixed at 17 °C. Only the upper limit temperature is changeable.)

4) AUTO mode temperature selection

This setting is unavailable when the controller is connected to an air conditioner without AUTO mode operation.

“AUTO” lights on the display. The set temperature adjustment range for AUTO mode is displayed.

The method used to set the AUTO mode temperature range settings is the same as the method used to set the COOL/DRY mode temperature range settings (using the three time selection buttons [Time selection], [△] and [▽])

[Lower limit temperature adjustment range]: 19 °C (*2) → 28 °C (Can be adjusted as high as the displayed upper limit temperature.)

[Upper limit temperature adjustment range]: 28 °C → 19 °C (*2) (Can be adjusted as low as the displayed lower limit temperature.)

*2: Mid temperature indoor units have a lower limit temperature of 17 °C.

3. When all the necessary settings have been made, exit the remote controller function selection mode and go back to the Normal display by pressing and holding buttons ① [CHECK] and [MODE] simultaneously for 2 seconds.

[3] Interlocking Setting via the MA Remote Controller

1. Lossnay interlocking setting (Make this setting only when necessary)

Make this setting only when necessary.

*When an upper controller is connected, make the settings on the upper controller.

NOTE : To perform an interlocked operation with LOSSNAY units, interlock all the indoor units in the group with the LOSSNAY units.

Perform this operation to enter the interlock setting between the LOSSNAY and the indoor units to which the remote controller is connected, or to search and delete registered information.

In the following example, the address of the indoor unit is 05 and the address of the LOSSNAY unit is 30.

[Operation Procedures]

- Press the [ON/OFF] button on the remote controller to bring the unit to a stop.
The display window on the remote controller must look like the figure below to proceed to step ②.

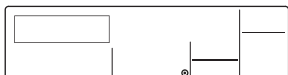

- Press and hold the [FILTER] and [LOSSNAY] buttons simultaneously for two seconds to perform a search for the LOSSNAY that is interlocked with the indoor unit to which the remote controller is connected.



- Search result
- The indoor unit address and the interlocked LOSSNAY address will appear alternately.

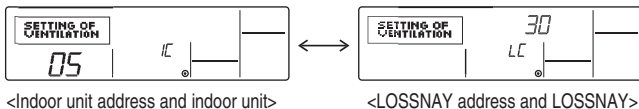

- Without interlocked LOSSNAY settings



- If no settings are necessary, exit the window by pressing and holding the [FILTER] and [LOSSNAY] buttons simultaneously for 2 seconds.
Go to step 1. **Registration Procedures** to make the interlock settings with LOSSNAY units, or go to step 2. **Search Procedures** to search for a particular LOSSNAY unit.
Go to step 3. **Deletion Procedures** to delete any LOSSNAY settings.

< 1. Registration Procedures >

- To interlock an indoor unit with a LOSSNAY unit, press the [TEMP. (▽) or (△)] button on the remote controller that is connected to the indoor unit, and select its address (01 to 50).
- Press the [CLOCK (▽) or (△)] button to select the address of the LOSSNAY to be interlocked (01 to 50).

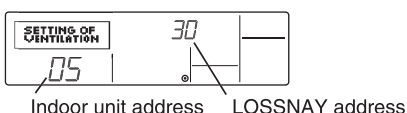

- Press the [TEST] button to register the address of the selected indoor unit and the interlocked LOSSNAY unit.
- Registration completed
The registered indoor unit address and "IC," and the interlocked LOSSNAY address and "LC" will appear alternately.

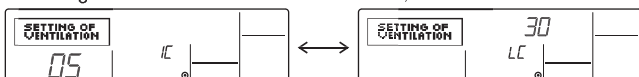

- Registration error

If the registration fails, the indoor unit address and the LOSSNAY address will be displayed alternately.

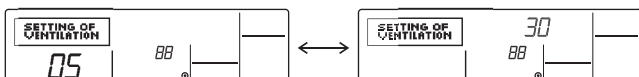

Registration cannot be completed: The selected unit address does not have a corresponding indoor unit or a LOSSNAY unit.
Registration cannot be completed: Another LOSSNAY has already been interlocked with the selected indoor unit.

< 2. Search Procedures >

⑧ To search for the LOSSNAY unit that is interlocked with a particular indoor unit, enter the address of the indoor unit into the remote controller that is connected to it.



<Indoor unit address>

⑨ Press the [MENU] button to search for the address of the LOSSNAY unit that is interlocked with the selected indoor unit.

- Search completed (With a LOSSNAY connection)

The indoor unit address and "IC," and the interlocked LOSSNAY address and "LC" will appear alternately.

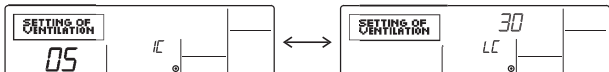

- Search completed (No interlocked settings with a LOSSNAY exist.)



- The selected address does not have a corresponding indoor unit.



< 3. Deletion Procedures >

Take the following steps to delete the interlock setting between a LOSSNAY unit and the interlocked indoor unit from the remote controller that is connected to the indoor unit.

⑩ Find the address of the LOSSNAY to be deleted (See section 2. Search Procedures.), and bring up the result of the search for both the indoor unit and LOSSNAY on the display.



⑪ Press the [ON/OFF] button twice to delete the address of the LOSSNAY unit that is interlocked with the selected indoor unit.

- Registration completed

The indoor unit address and "--," and the interlocked LOSSNAY address and "--" will appear alternately.



-Deletion error

If the deletion fails

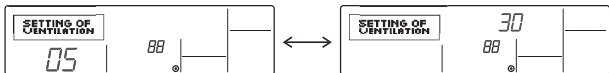

2. Remote controller function selection via the MA remote controller

(1) Remote controller function

The settings for the following remote controller functions can be changed in the remote controller function selection mode.
Change the settings as necessary.

| Category 1 | Category 2 | Category 3 (Setting content) |
|---|---|--|
| 1. Language selection ("CHANGE LANGUAGE") | Select the language in which the menu appears. | • Multi-language display is supported. |
| 2. Function lock ("FUNCTION SELECTION") | (1) Function lock setting ("LOCKING FUNCTION") | • Sets the type of locking to put into effect |
| | (2) Use of automatic mode ("SELECT AUTO MODE") | • Enables or disables automatic operation mode |
| | (3) Temperature range setting ("LIMIT TEMP FUNCTION") | • Sets the adjustable temperature range (maximum, minimum) |
| 3. Mode selection ("MODE SELECTION") | (1) Remote controller main/sub setting ("CONTROLLER MAIN/SUB") | • Sets the remote controller as main or sub * When two remote controllers are connected to the same group, one controller must be set as sub. |
| | (2) Clock enable/disable function ("CLOCK") | • Enables or disables clock function |
| | (3) Timer function setting ("WEEKLY TIMER") | • Sets the timer type |
| | (4) Technical assistance contact number setting ("CALL") | • Contact number can be set to appear in case of error. • Sets the telephone number |
| 4. Display mode ("DISP MODE SETTING") | (1) Temperature unit selection ("TEMP MODE °C/°F") | • Sets the temperature unit (°C or °F) for display |
| | (2) Suction air temperature display setting ("ROOM TEMP DISP SELECT") | • Switches between display and non-display of indoor (suction) air temperature |
| | (3) Automatic cooling/heating display setting ("AUTO MODE DISP C/H") | • Switches between display and non-display of "Cool" or "Heat" during automatic mode |

[Function selection flowchart]

[1] Stop the air conditioner to start the remote controller function selection mode. → [2] Select from category 1. → [3] Select from category 2. → [4] Make the setting. → [5] Setting completed → [6] Go back to the normal display (Finish)

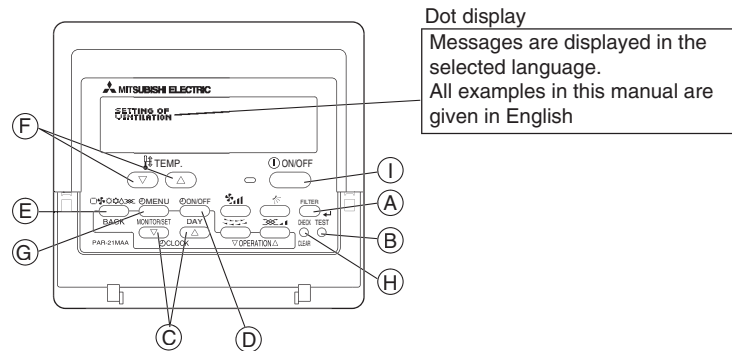

Normal display (Display that appears when the air condition is stopped)

(Press and hold the (E) button and (D) button simultaneously for two seconds.)
*The display cannot be changed during function selection, test run, and self-diagnosis.

(Press and hold the (E) button and (D) button simultaneously for two seconds.)
*The settings that are made according to this procedure are stored in the remote controller memory.

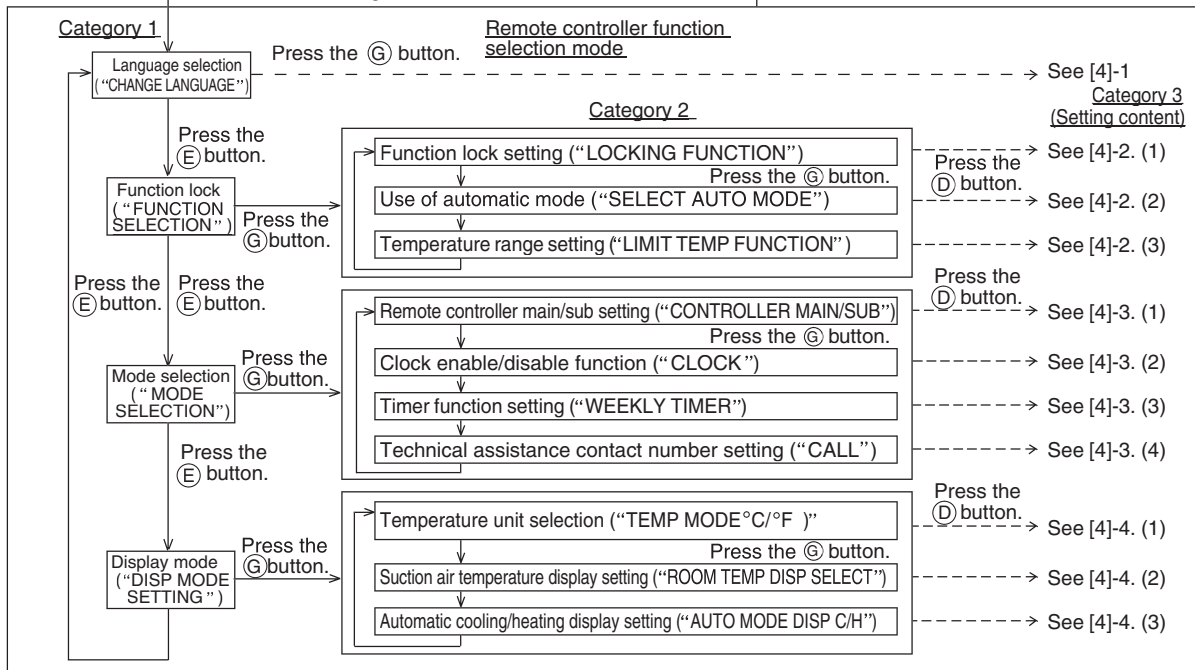

NOTE

Timer operation stops when the display is changed from remote controller function selection to normal display.

[Setting details]

[4] -1. Language selection

The language that appears on the dot display can be selected from among the following.

- Press the [ MENU] button to change the following setting.
- ① Japanese (JP), ② English (GB), ③ German (D), ④ Spanish (E), ⑤ Russian (RU), ⑥ Italian (I), ⑦ Chinese (CH), ⑧ French (F)

[4] -2. Function lock

(1) Function lock setting

- Press the [ ON/OFF] button to change the following setting.

- ① no1: All buttons except the [ ON/OFF] button are locked.
- ② no2: All buttons are locked.
- ③ OFF (Initial setting): No buttons are locked.

* To enable locking from the normal display, press and hold the [FILTER] and [ ON/OFF] buttons simultaneously for two seconds on the normal display after the above setting is made.

(2) Automatic mode display selection

When the remote controller is connected to a unit with an automatic operation mode, the following settings can be made.

- Press the [ ON/OFF] button to change the following setting.

- ① ON (Initial setting) : Automatic mode is displayed when the operation mode is selected.
- ② OFF : Automatic mode is not displayed when the operation mode is selected.

(3) Temperature range setting

After this setting is made, the temperature can be changed within the set range.

- Press the [ ON/OFF] button to change the following setting.

- ① LIMIT TEMP COOL MODE:
The temperature range for the cooling/dry mode can be changed.
- ② LIMIT TEMP HEAT MODE:
The temperature range for the heating mode can be changed.
- ③ LIMIT TEMP AUTO MODE:
The temperature range for the automatic mode can be changed.
- ④ OFF (Initial setting): The temperature range is not set.

* When any setting other than OFF is selected, the temperature range setting for cooling, heating, and automatic mode is also made. The range setting will not take effect if the temperature range has not been set.

- To increase or decrease the temperature, press the [ TEMP (▽) or (△)] button.

- To switch between the upper limit setting and the lower limit setting, press the  button. The selected setting will flash, allowing the temperature to be set.

- Settable range

| | |
|------------------|--------------------------|
| Cooling/Dry mode | Lower limit: 19°C ~ 30°C |
| | Upper limit: 30°C ~ 19°C |
| Heating mode | Lower limit: 17°C ~ 28°C |
| | Upper limit: 28°C ~ 17°C |
| Automatic mode | Lower limit: 19°C ~ 28°C |
| | Upper limit: 28°C ~ 19°C |

* The settable range varies depending on the unit to be connected.
(Mr. Slim units, Free-plan units, and medium temperature range units)

[4] -3. Mode selection

(1) Remote controller main/sub setting

- Press the [ ON/OFF] button to change the following setting.

- ① Main: Designates the controller as the main controller.
- ② Sub: Designates the controller as the sub controller.

(2) Clock enable/disable function

- Press the [ ON/OFF] button to change the following setting.

- ① ON: Clock function is enabled.
- ② OFF: Clock function is disabled.

(3) Timer function setting

- Press the [ ON/OFF] button to change the following setting.
(Select one of the following.)

- ① WEEKLY TIMER (Initial setting): Weekly timer function is enabled
- ② AUTO OFF TIMER: Auto off timer function is enabled
- ③ SIMPLE TIMER: Simple timer function is enabled.
- ④ TIMER MODE OFF: Timer function is disabled.

* When the clock setting is set to OFF, the "WEEKLY TIMER" is disabled.

(4) Technical assistance contact number setting

- Press the [ ON/OFF] button to change the following setting.

- ① CALL OFF: The set contact numbers are not displayed in an error situation.

- ② CALL**** ** * : The set contact numbers are displayed in an error situation.

CALL_ : Contact numbers can be entered when the display appears as shown on the left.

- Setting the contact numbers

To set the contact numbers, follow the following procedures.

Move the flashing cursor to set the numbers. Press the [ TEMP. (▽) or (△)] button to move the cursor right (left).

Press the [ CLOCK(▽) or (△)] button to set the numbers.

[4] -4. Display mode change

(1) Temperature unit selection

- Press the [ ON/OFF] button to change the following setting.

- ① °C (Initial setting): Temperature is displayed in °C.
- ② °F: Temperature is displayed in °F.



(2) Suction air temperature display setting

- Press the [ ON/OFF] button to change the following setting.

- ① ON: Suction air temperature is displayed.
- ② OFF: Suction air temperature is not displayed.

(3) Automatic cooling/heating display setting

- Press the [ ON/OFF] button to change the following setting.

- ① ON: Either "  COOL" or "  HEAT" is displayed during automatic mode.
- ② OFF: Only "  AUTO" is displayed during automatic mode.

[4] Switching to the built-in Thermo on the remote controller

1. Selecting the position of temperature detection by the indoor unit (Factory setting: SW1-1 "OFF")

To use the built-in sensor in the remote controller, set the SW1-1 on the indoor unit to ON.

* Some remote controllers are not equipped with a built-in sensor. Use the built-in sensor on the indoor unit instead.

* When using the built-in sensor on the remote controller, install the remote controller where room temperature can be detected.

5 Electrical Wiring Diagram

[1] PQR, PQHY-P200, P250YGM-A, P400, P500YSGM-A

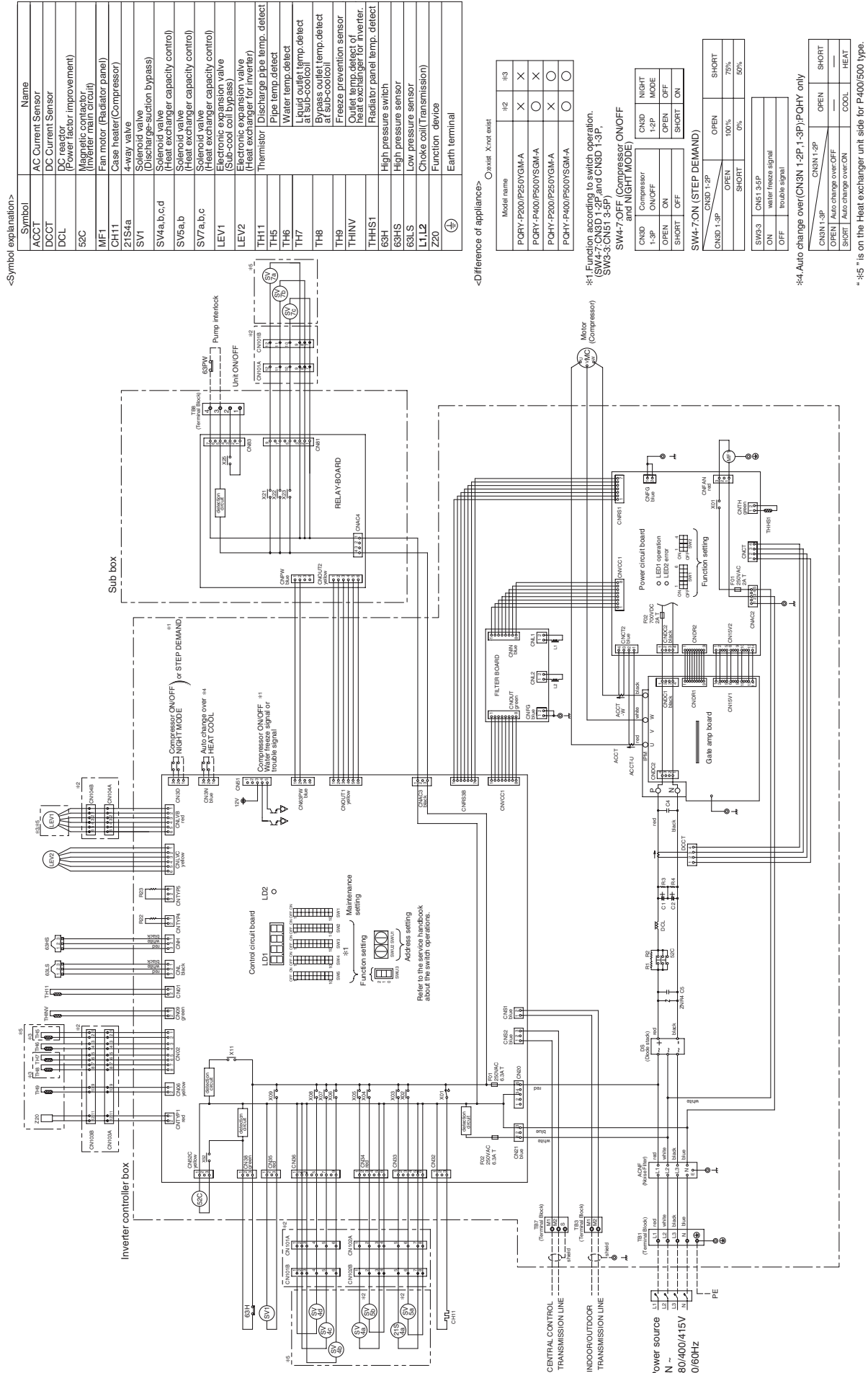

[2] CMB-P104V-G

Symbol explanation

| Symbol | Name |
|--------------|-----------------------------------|
| TR | Transformer |
| TH1,12,15,16 | Thermistor sensor |
| LEV1,3 | Expansion valve |
| PS1,3 | Pressure sensor |
| CONT.B | Circuit BC controller board |
| TB01 | Terminal block (for power source) |
| TB02 | Terminal block (for Transmission) |
| SV1~4A,B,C | Solenoid valve |
| SVM1 | Solenoid valve |
| T1~4 | Terminal |
| F01 | Fuse AC250V 6.3A F |

- Note:1. TB02 is transmission terminal block.
 Never connect power line to it.
 2. The initial set values of switch on CONT.B are as follows.
 SW1:0
 SW2:0

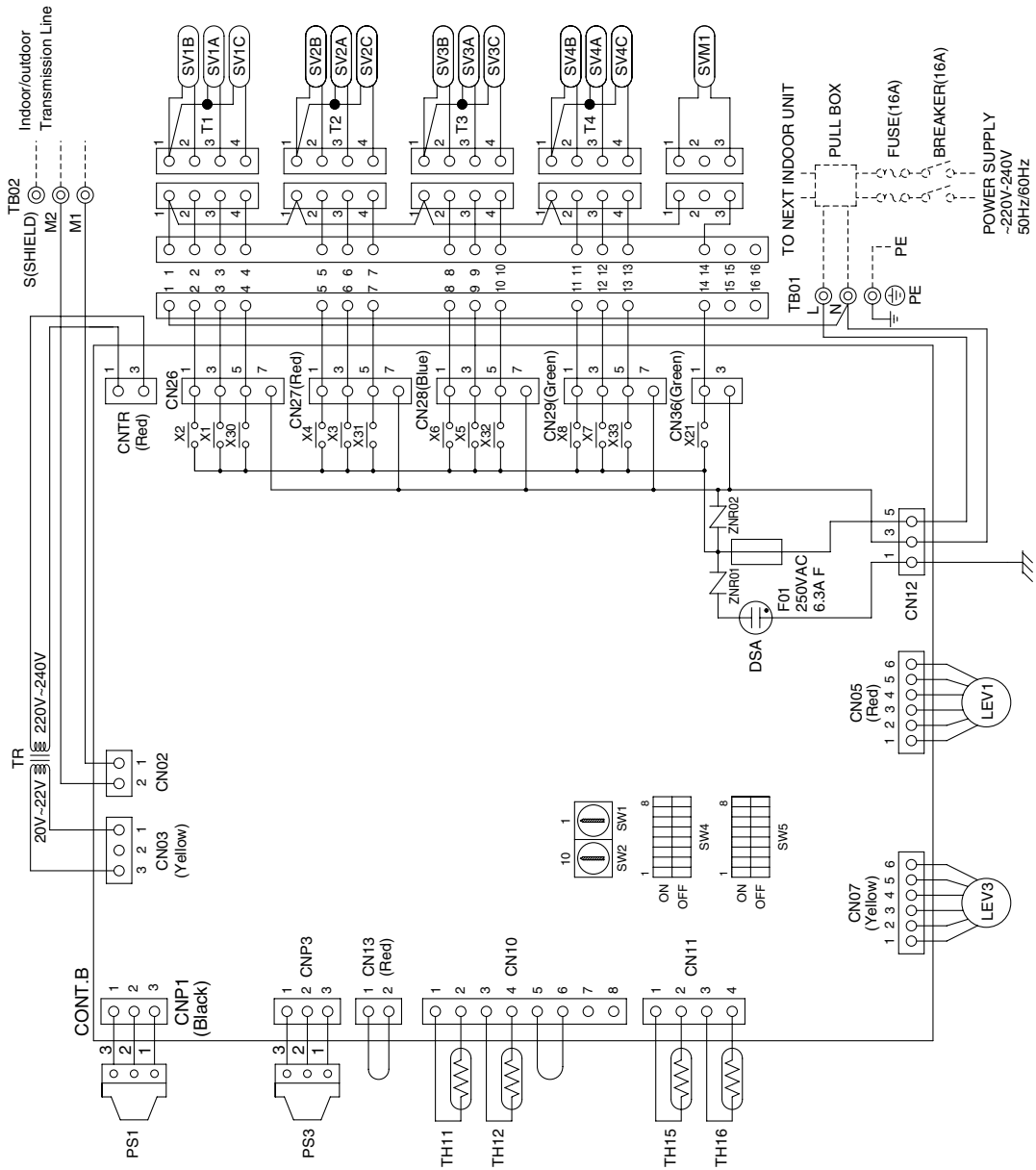

[3] CMB-P105, 106V-G

| Symbol | Name |
|--------------|-----------------------------------|
| TR | Transformer |
| TH1,12,15,16 | Thermistor sensor |
| LEV1,3 | Expansion valve |
| PS1,3 | Pressure sensor |
| CONT.B | Circuit BC board controller |
| TB01 | Terminal block (for power source) |
| TB02 | Terminal block (for transmission) |
| SV1~6A,B,C | Solenoid valve |
| SVM1 | Solenoid valve |
| T1~6 | Terminal |
| F01 | Fuse AC250V 6.3A F |

Note: 1. TB02 is transmission terminal block.
Never connect power line to it.
2. The initial set values of switch on CONT.B are as follows.

SW1:0
SW2:0

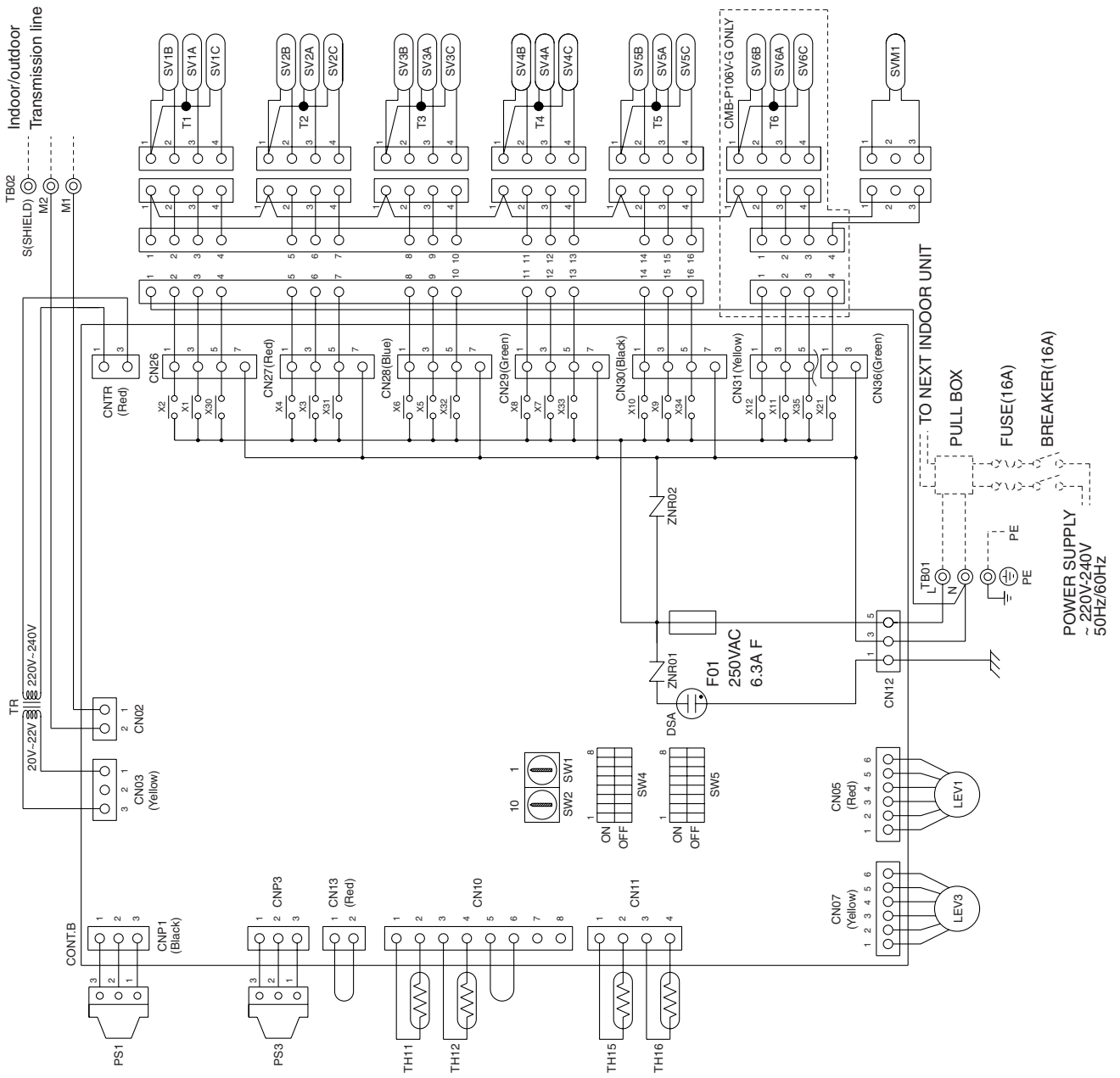

[4] CMB-P108, 1010V-G

Symbol explanation

| Symbol | Name |
|--------------|-----------------------------------|
| TR | Transformer |
| TH1,12,15,16 | Thermistor sensor |
| LEV1,3 | Expansion valve |
| PS1,3 | Pressure sensor |
| REL.B | Circuit Relay |
| CONT.B | BC controller board |
| TB01 | Terminal block (for power source) |
| TB02 | Terminal block (for Transmission) |
| SV1~10A,B,C | Solenoid valve |
| SW1 | Solenoid valve |
| T1~10 | Terminal |
| F01 | Fuse AC250V 6.3A F |

- Note:
- TB02 is transmission terminal block. Never connect power line to it.
 - The initial set values of switch on CONT.B are as follows.
SW1:0
SW2:0

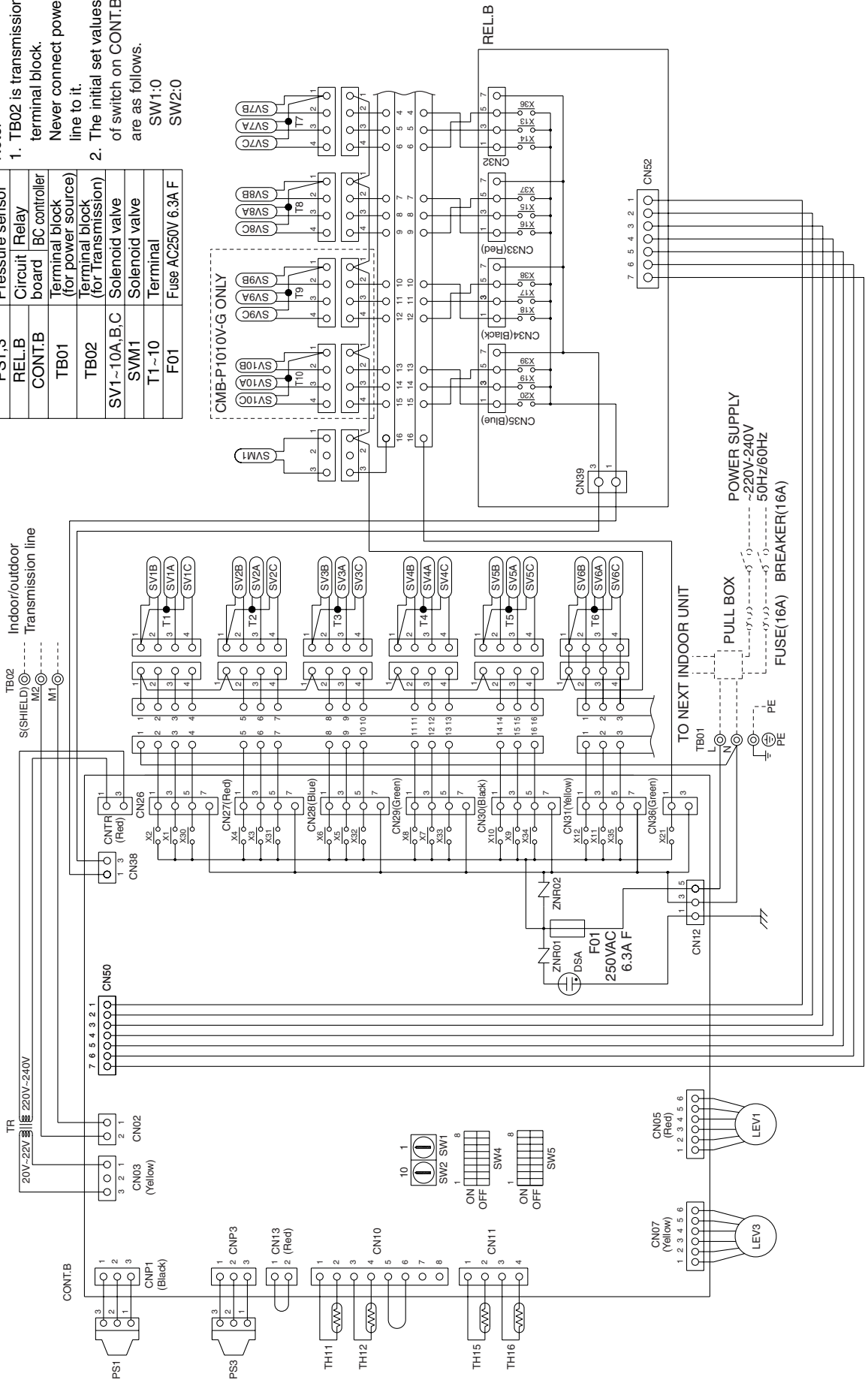

[5] CMB-P1013, 1016V-G

Symbol explanation

| Symbol | Name |
|--------------|-----------------------------------|
| TR | Transformer |
| TH1,12,15,16 | Thermistor sensor |
| LEV1,3 | Expansion valve |
| PS1,3 | Pressure sensor |
| REL.B | Circuit Relay |
| CONT.B | board IC controller |
| TB01 | Terminal block (for power source) |
| TB02 | Terminal block (for Transmission) |
| SV1~16A,BC | Solenoid valve |
| SVM1 | Solenoid valve |
| T1~16 | Terminal |
| F01 | Fuse AC250V 6.3A F |

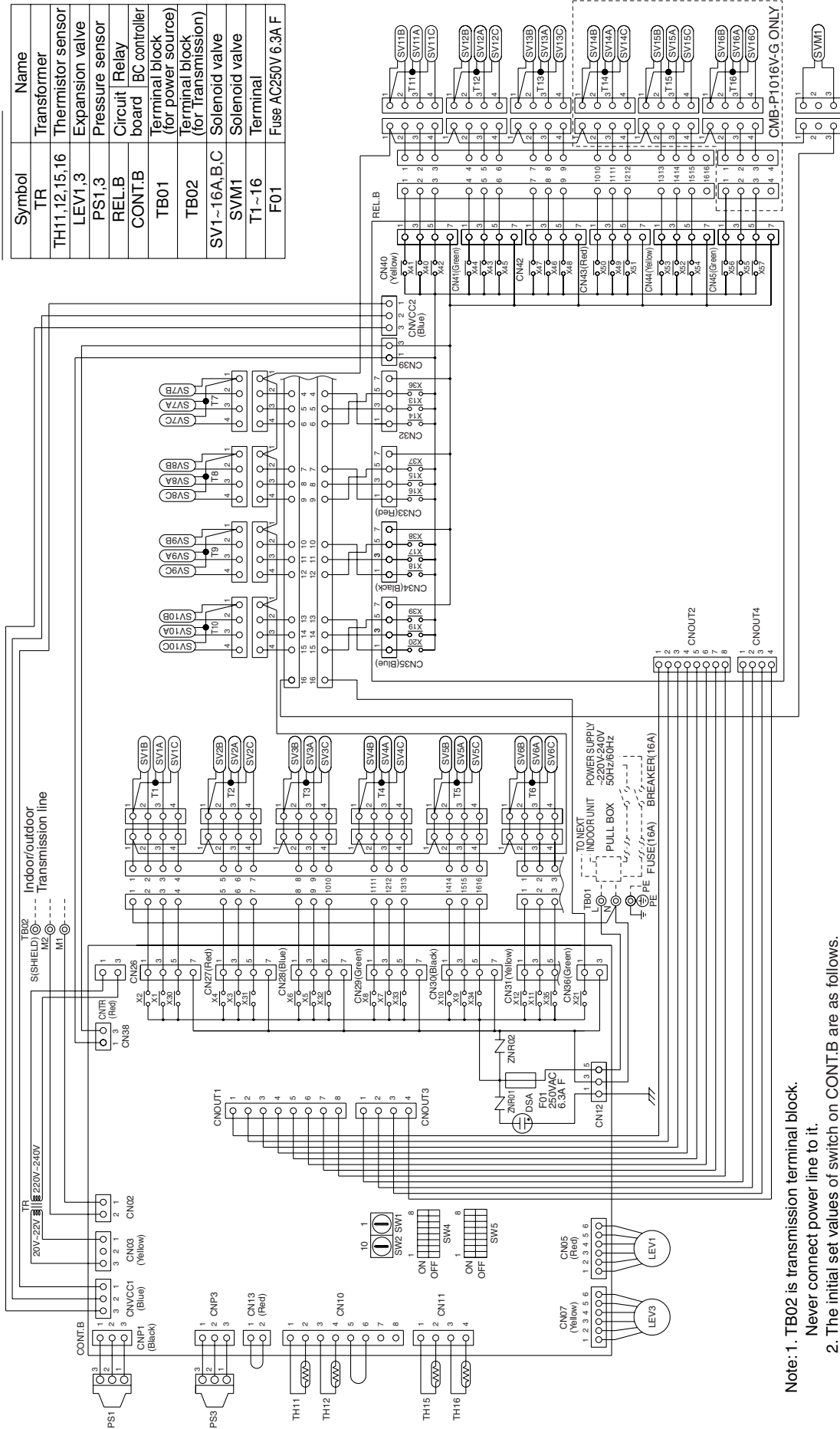

- Note: 1. TB02 is transmission terminal block.
 Never connect power line to it.
 2. The initial set values of switch on CONT.B are as follows.
 SW1:0
 SW2:0

[6] CMB-P104V-GB

Symbol explanation

| Symbol | Name |
|------------|-----------------------------------|
| TR | Transformer |
| TH12,15 | Thermistor sensor |
| LEV3 | Expansion valve |
| CONT.B | Circuit board controller |
| TB01 | Terminal block (for power source) |
| TB02 | Terminal block (for Transmission) |
| SV1~4A,B,C | Solenoid valve |
| T1~4 | Terminal |
| F01 | Fuse AC250V 6.3A F |

- Note: 1. TB02 is transmission terminal block.
Never connect power line to it.
2. The initial set values of switch on CONT.B are as follows.
SW1:0
SW2:0

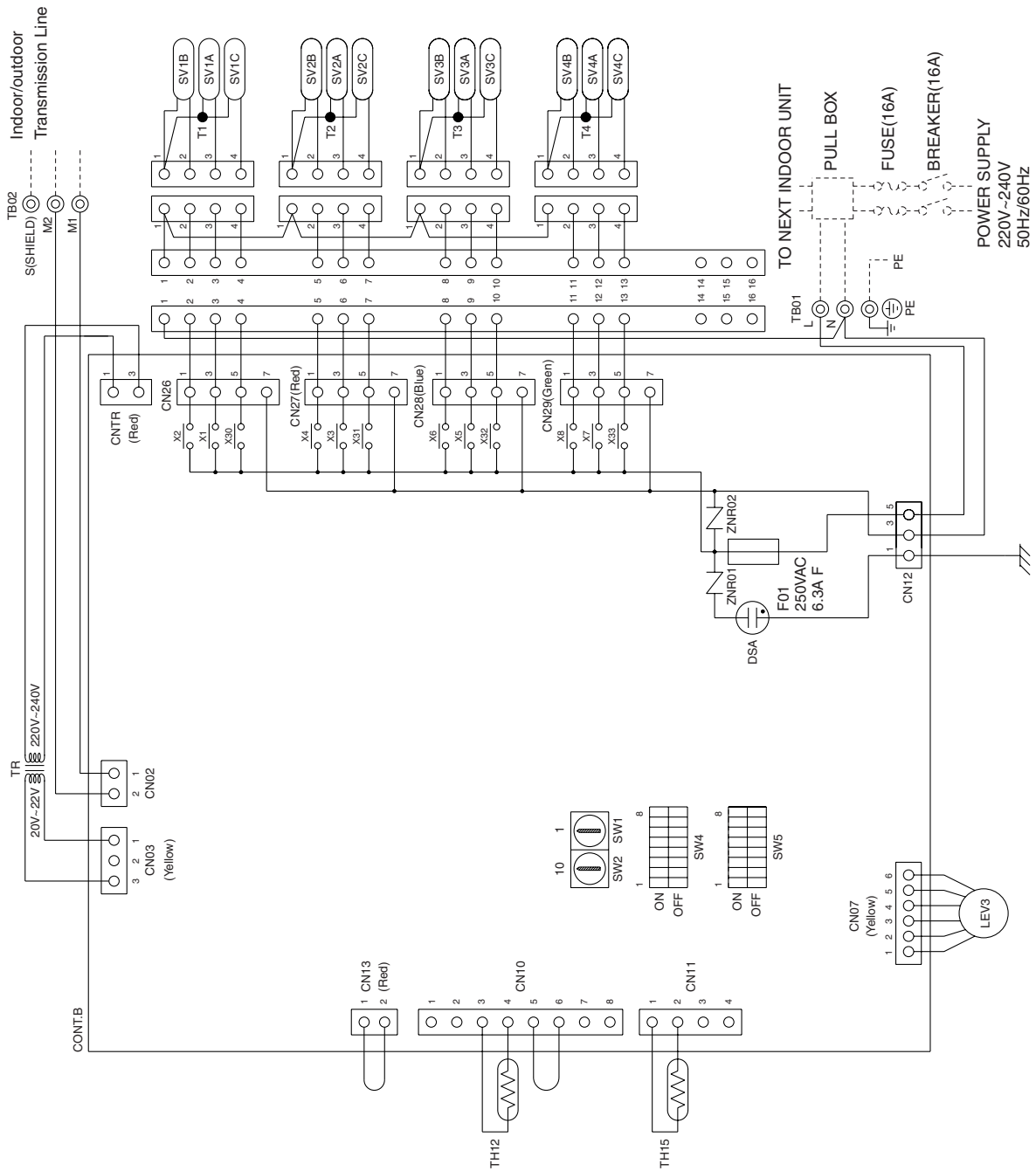

[7] CMB-P108V-GB

Symbol explanation

| Symbol | Name |
|------------|-----------------------------------|
| TR | Transformer |
| TH12,15 | Thermistor sensor |
| LEV3 | Expansion valve |
| REL.B | Circuit Relay |
| CONT.B | board IC controller |
| TB01 | Terminal block (for power source) |
| TB02 | Terminal block (for transmission) |
| SV1~8A,B,C | Solenoid valve |
| T1~8 | Terminal |
| F01 | Fuse AC250V 6.3A F |

Note:
 1. TB02 is transmission terminal block. Never connect power line to it.
 2. The initial set values of switch on CONT.B are as follows.
 SW1:0
 SW2:0

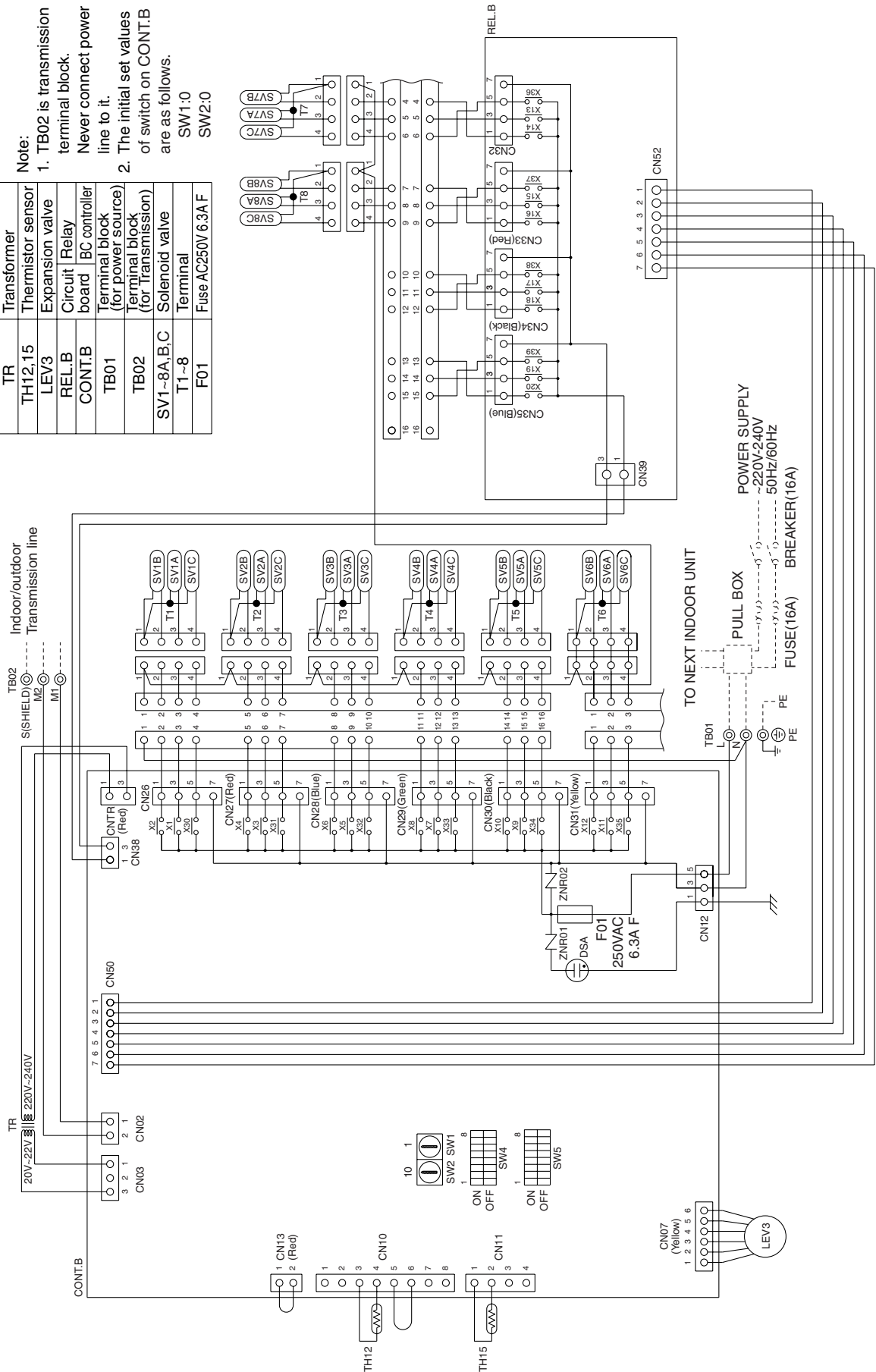

[8] CMB-P108, 1010V-GA

Symbol explanation

| Symbol | Name |
|--------------|-----------------------------------|
| TR | Transformer |
| TH1,12,15,16 | Thermistor sensor |
| LEV1~3 | Expansion valve |
| PS1,3 | Pressure sensor |
| REL.B | Circuit Relay |
| CONT.B | BC controller board |
| TB01 | Terminal block (for power source) |
| TB02 | Terminal block (for Transmission) |
| SV1~10A,B,C | Solenoid valve |
| SVM1,2 | Solenoid valve |
| T1~10 | Terminal |
| F01 | Fuse AC250V 6.3A F |

- Note:
1. TB02 is transmission terminal block. Never connect power line to it.
 2. The initial set values of switch on CONT.B are as follows.
SW1:0
SW2:0

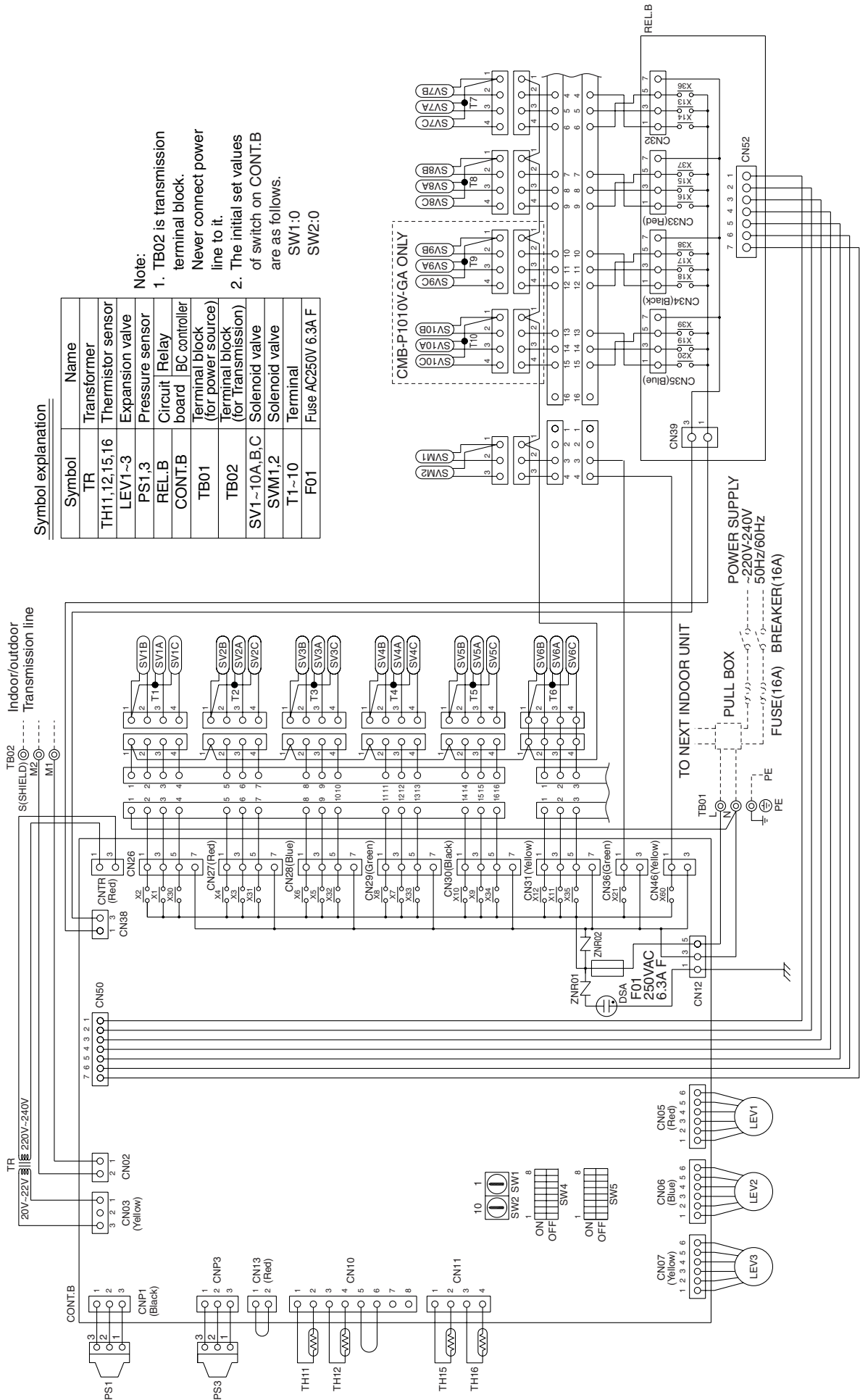

[9] CMB-P1013, 1016V-GA

Symbol explanation

| Symbol | Name |
|---------------|-----------------------------------|
| TR | Transformer |
| TH11,12,15,16 | Thermistor sensor |
| LEV1~3 | Expansion valve |
| PS1,3 | Pressure sensor |
| REL.B | Circuit Relay |
| CONT.B | board BC controller |
| TB01 | Terminal block (for power source) |
| TB02 | Terminal block (for transmission) |
| SV1~16A,B,C | Solenoid valve |
| SVM1,2 | Solenoid valve |
| T1~16 | Terminal |
| F01 | Fuse AC250V 6.3A F |

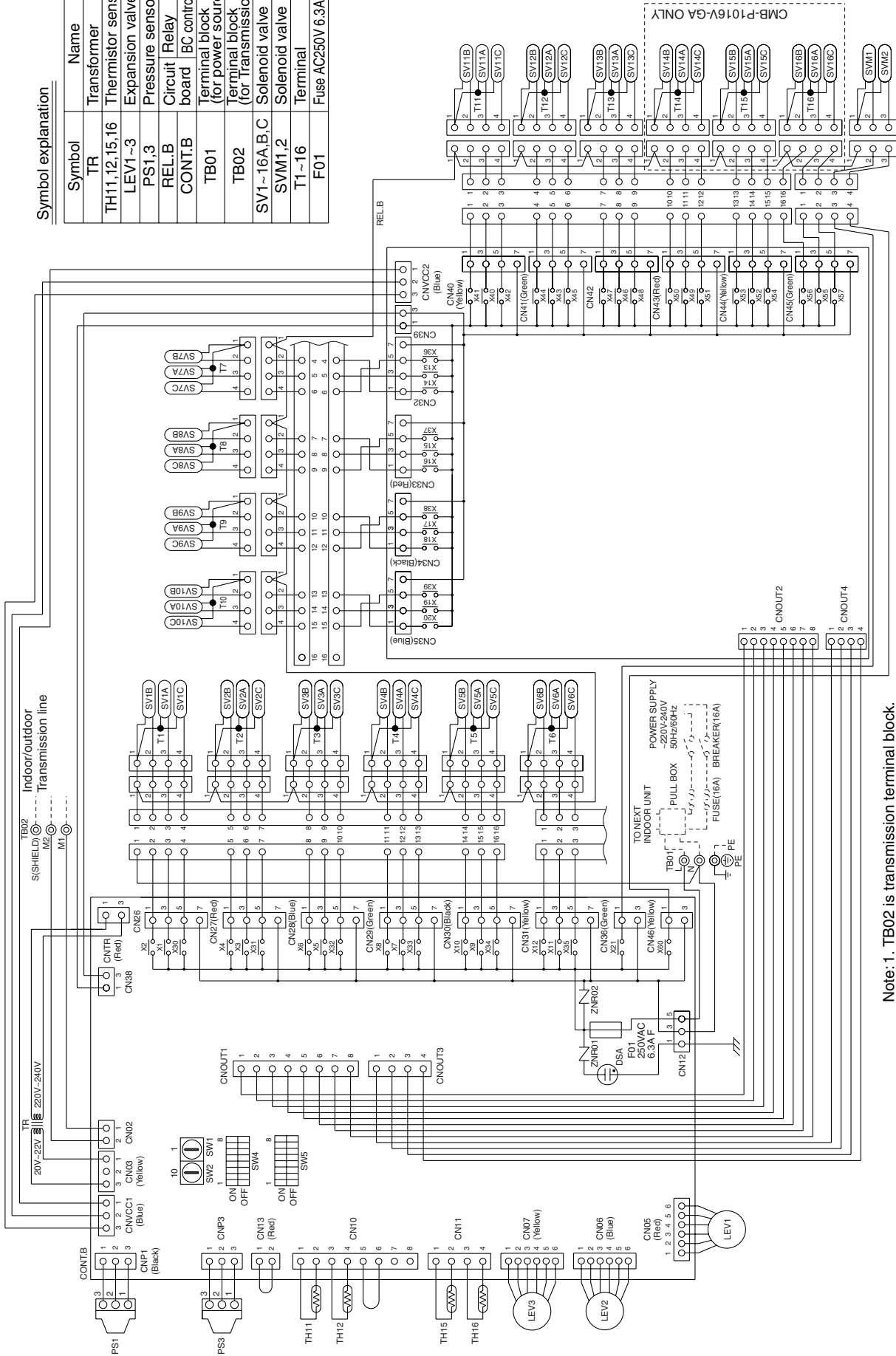

- Note: 1. TB02 is transmission terminal block.
 Never connect power line to it.
 2. The initial set values of switch on CONT.B are as follows.
 SW1:0
 SW2:0

[10] Power Dispatching Extension Unit for the Transmission Lines

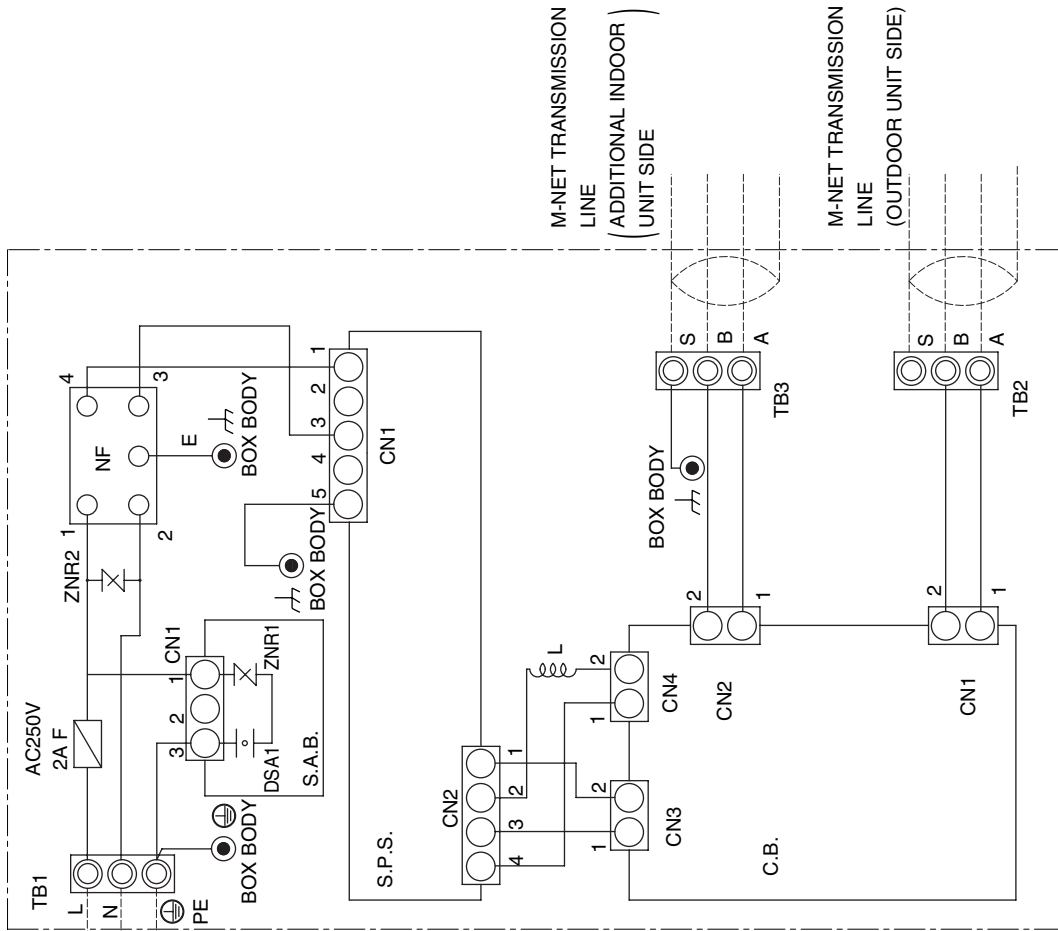

Breaker (3A)

Power source
220-240V~/N
50/60Hz

SYMBOL EXPLANATION

| SYMBOL | NAME |
|--------|--|
| C.B. | Circuit board |
| S.P.S. | Switching Power Supply |
| S.A.B. | Surge absorber board |
| NF | Noise Filter |
| L | Choke coil(Transmission) |
| DSA1 | Surge Absorber |
| ZNR1,2 | Varistor |
| F | Fuse |
| TB1 | Power source |
| TB2 | M-NET transmission line (Outdoor unit side) |
| TB3 | M-NET transmission line (Additional indoor unit side) |
| ⊕ | Earth terminal |

6 Refrigerant Circuit

[1] Refrigerant Circuit Diagram

< PQRV-P200, P250YGM-A >

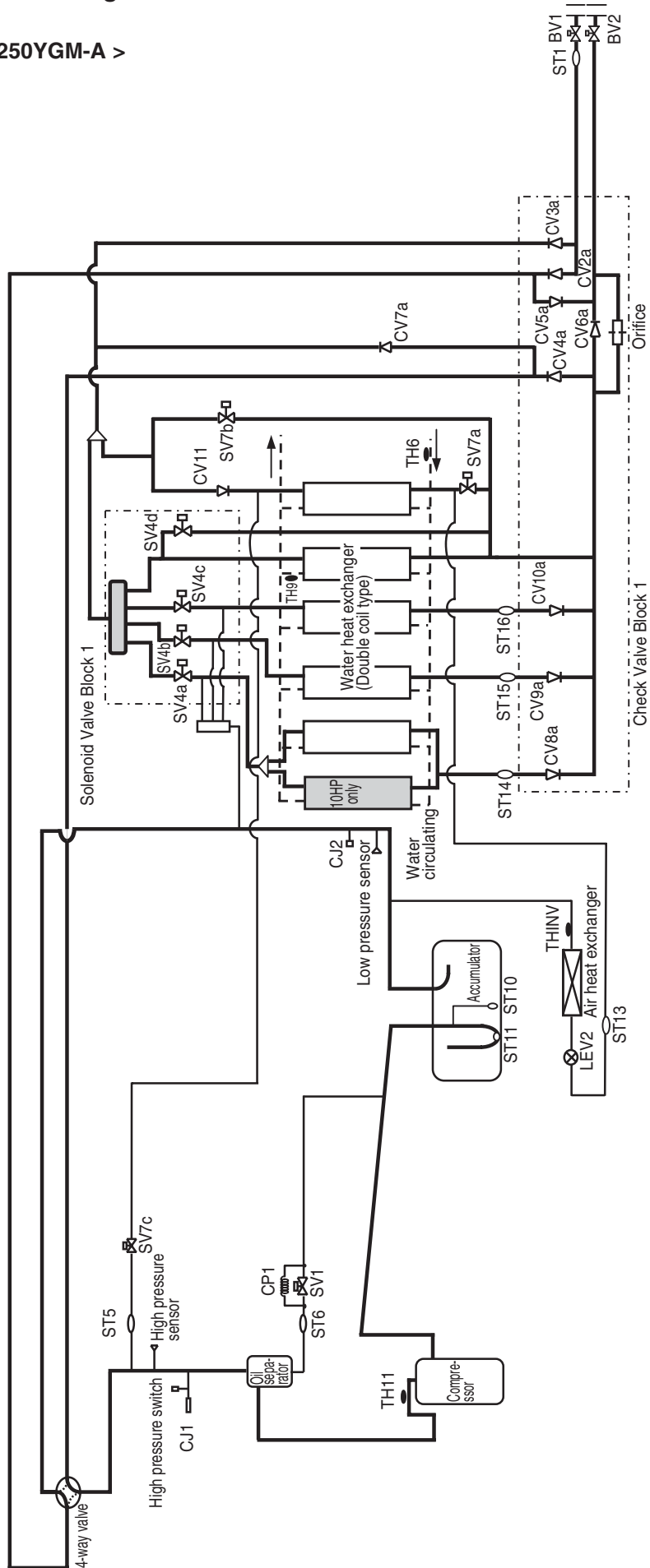

< PQHY-P200, P250YGM-A >

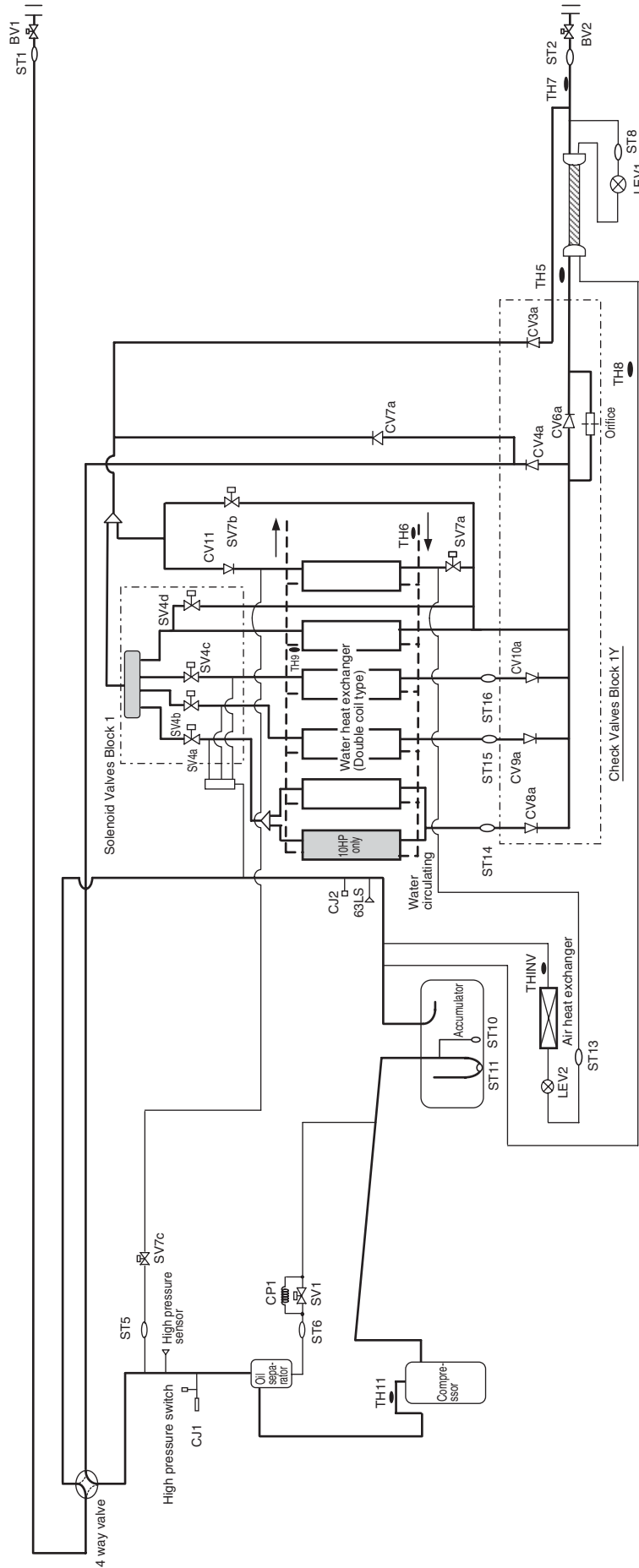

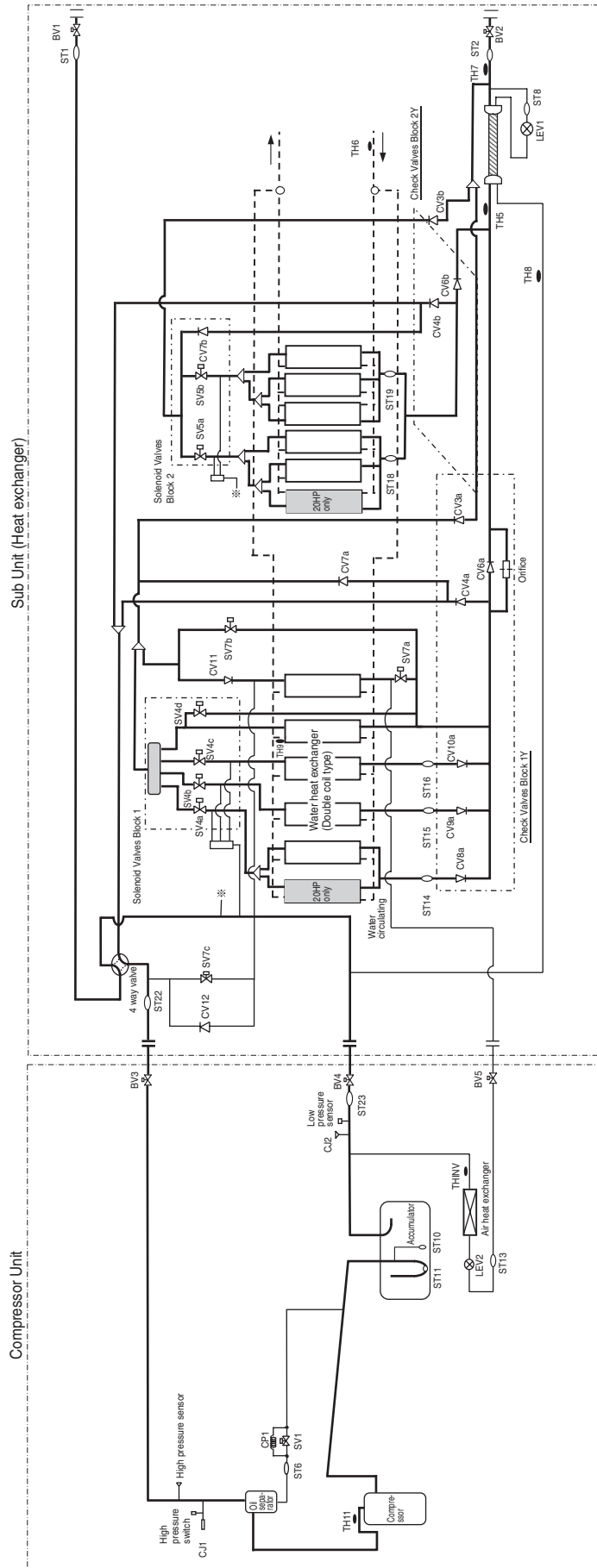

< CMB-P104,105,106,108,1010,1013,1016V-G >

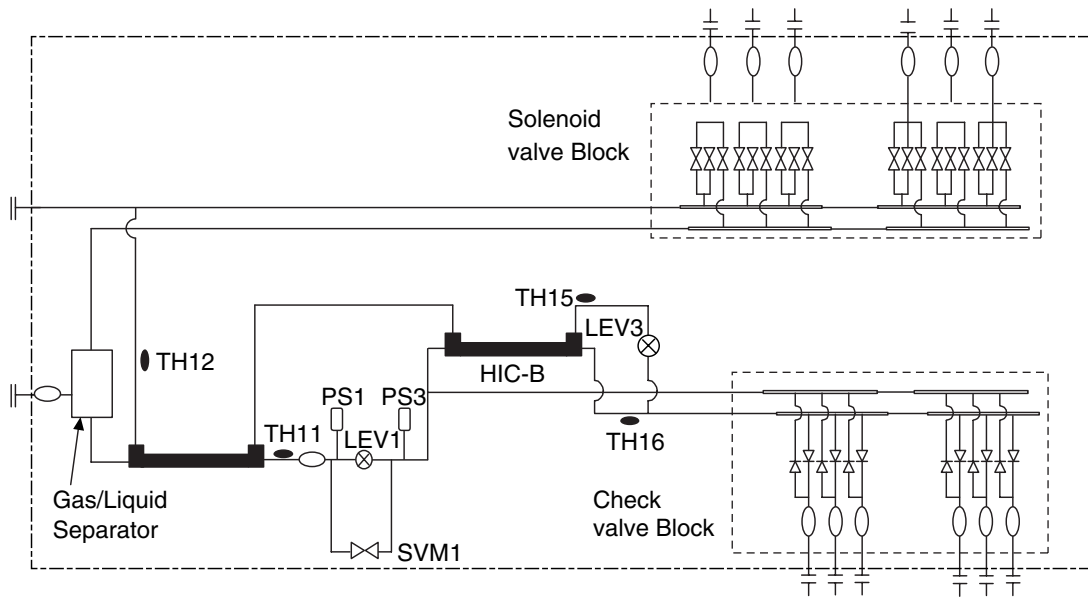

< CMB-P104,108V-GB >

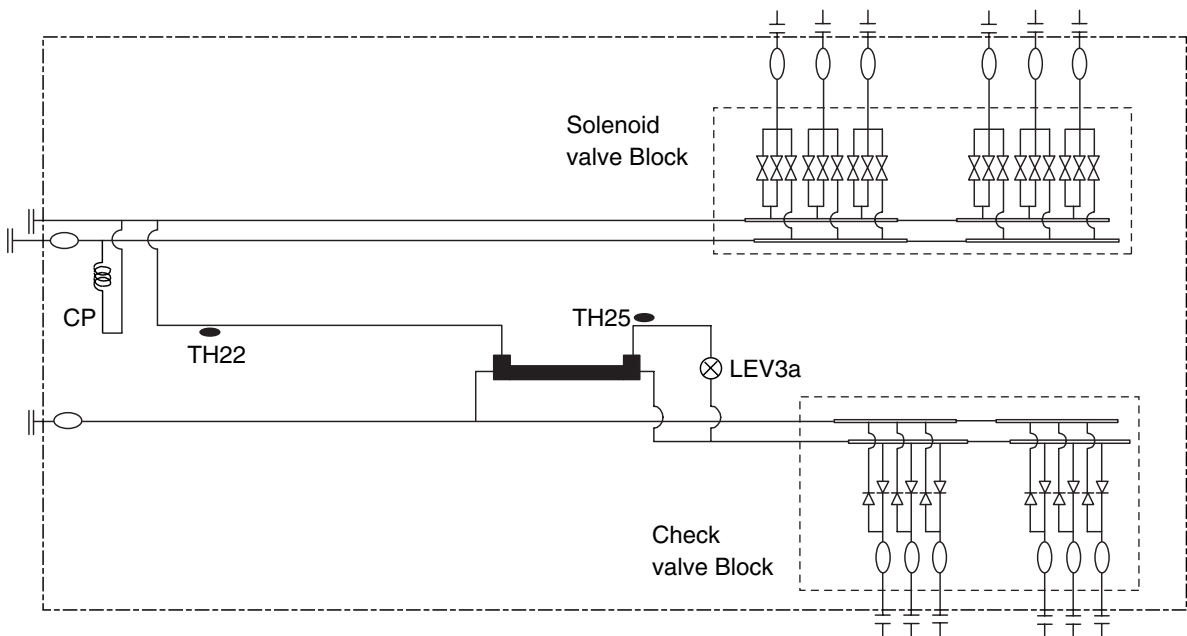

< CMB-P108,1010,1013,1016V-GA >

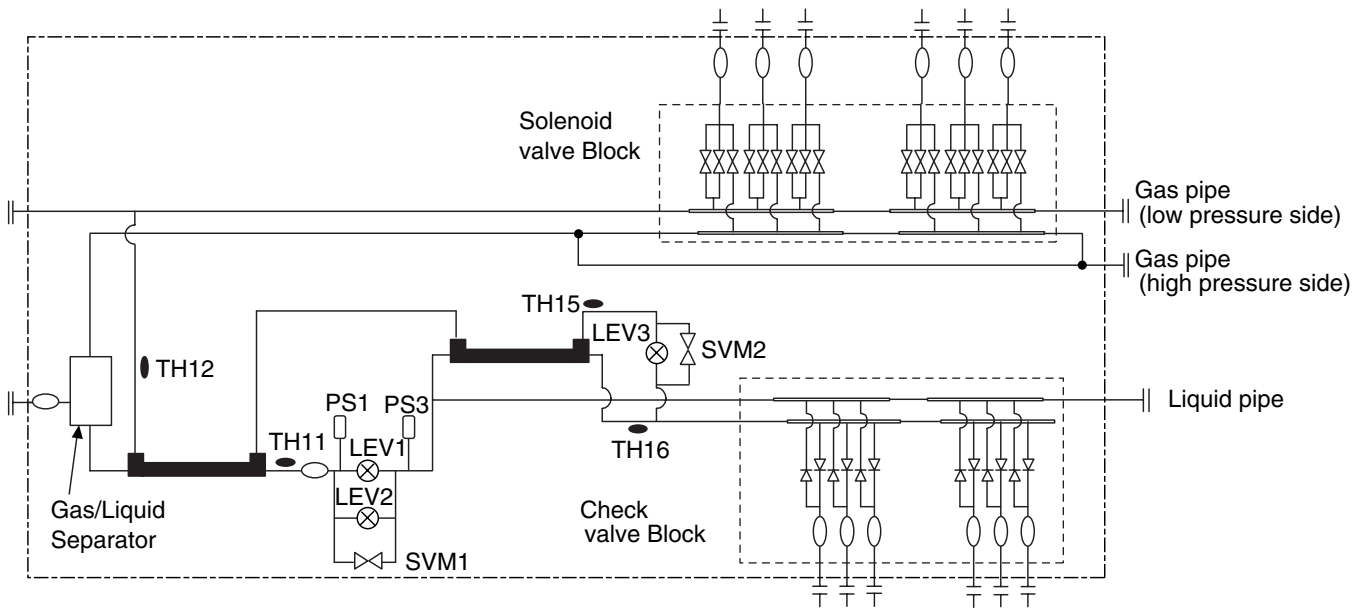

[2] Functions of Principal Parts

1. Heat source Unit

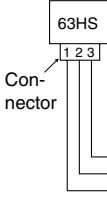
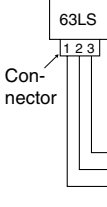
| Name | Symbol (function) | Notes | Function | Specification | Check method |
|----------------------|---|----------------------|---|---|--|
| Compressor | MC1 | | Adjusts the volume of circulating refrigerant by controlling the operating frequency with the operating pressure. | Low-pressure shell scroll type Winding resistance 20°C : 0.583Ω | |
| High-pressure sensor | 63HS | | ① Detects high pressure ② Regulates frequency and protects high pressure. |  <p>Pressure 0~4.15MPa Vout 0.5~3.5V 0.071V/0.098MPa Pressure [MPa] =1.38×Vout[V]-0.69</p> | |
| Low-pressure sensor | 63LS | | ① Detects low-pressure ② Protects low-pressure |  <p>Pressure 0~1.7MPa Vout 0.5~3.5V 0.173V/0.098MPa Pressure [MPa] =0.566×Vout[V]-0.283</p> | |
| Pressure switch | 63H1 | | ① Detects high pressure ② Protects high pressure | 4.15MPa Set to OFF | |
| Thermistor | TH11 (Discharge) | | ① Detects discharge temperature ② Protects high pressure | $R_{120}=7.465k\Omega$ $R_{25/120}=4057$ $R_t = 7.465 \exp\{4057(\frac{1}{273+t} - \frac{1}{393})\}$ | Resistance value check |
| | TH5 (Piping temperature) | PQHY only | Controls LEV1 by detecting sub cool at the heat exchanger outlet, using HPS data and TH5 reading. | $R_0=15k\Omega$ $R_{0/80}=3460$ $R_t = 15 \exp\{3460(\frac{1}{273+t} - \frac{1}{273})\}$ | Resistance value check |
| | TH6 (Inlet water temperature) | | Detects inlet water temperature | $0^\circ\text{C} : 15k\Omega$ $25^\circ\text{C} : 5.3k\Omega$ $10^\circ\text{C} : 9.7k\Omega$ $30^\circ\text{C} : 4.3k\Omega$ $20^\circ\text{C} : 6.4k\Omega$ $40^\circ\text{C} : 3.1k\Omega$ | |
| | TH7 TH8 | PQHY only | Controls LEV1, using TH5, TH7, and TH8 | | |
| | TH9 (Outlet water temperature) | | Freeze prevention of water-source heat exchanger | | |
| | THINV | | ① Detects the temperature at the inverter cooler's heat exchanger outlet. ② Controls the LEV2 opening angle | | |
| | THHS Inverter heat sink temperature | Heat sink | Controls inverter cooling fan, using THHS temperature. | $R_0=17k\Omega$ $R_{25/120}=4170$ $R_t = 17 \exp\{4170(\frac{1}{273+t} - \frac{1}{323})\}$ | $0^\circ\text{C} : 181k\Omega$ $25^\circ\text{C} : 50k\Omega$ $10^\circ\text{C} : 105k\Omega$ $30^\circ\text{C} : 40k\Omega$ $20^\circ\text{C} : 64k\Omega$ $40^\circ\text{C} : 26k\Omega$ |
| Solenoid valve | SV1 Discharge-suction bypass | | ① High/low pressure bypass at starting and stopping, and capacity control during low-load operation ② High-pressure rise suppression | AC220~240V Open when energized Closed when not energized | Continuity check with a tester |
| | SV4a~4d SV7a~7c Heat exchanger capacity control | | Controls heat source unit heat exchanger capacity. | AC220~240V Closed when energized Open when not energized | |
| | SV5a, 5b Heat exchanger capacity control | P400,P500 types only | | | |

| Name | Symbol (function) | Notes | Function | Specification | Check method |
|------------------------|--------------------------|-----------|--|--|--|
| Linear expansion valve | LEV1 | PQHY only | Adjusts the volume of bypass flow from the outdoor unit during cooling operation. | DC12V Opening of stepping motor driving valve 0-480 pulses (direct driven type) | Same as indoor LEV. The resistance value is not the same as that of the indoor LEV. (Refer to the section on LEV troubleshooting.) |
| | LEV2 | | Controls the volume of refrigerant flowing to the inverter cooler's heat exchanger | DC12V Stepping motor driving valve opening 0~100 pulse | |
| Heater | CH11 Crankcase heater | | Heats refrigerants in the compressor. | Cord heater AC220~240V CH11.....1280Ω 45W | Resistance value check |
| 4-way valve | 21S4a | | Switches between cooling and heating cycles. | AC220~240V De-energized : cooling cycle Energized : heating cycle | Continuity check with a tester |

2. Indoor Unit

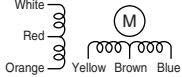
| Name | Symbol (function) | Notes | Function | Specification | Check method |
|------------------------|---|-------|--|--|---|
| Linear expansion valve | LEV | | ① Adjusts superheat at the indoor heat exchanger outlet during cooling ② Adjusts subcool at the indoor heat exchanger outlet during cooling | DC12V Opening of stepping motor driving valve 0-(1400) pulses | Refer to the section on continuity test with a tester Continuity between white-red-orange Continuity between yellow-brown-blue  |
| Thermistor | TH1 (Suction air temperature) | | Indoor unit control (Thermo) | $R_0=15k\Omega$ $R_{0/80}=3460$ $R_t = 15 \exp\left\{3460\left(\frac{1}{273+t} - \frac{1}{273}\right)\right\}$ 0°C : 15kΩ 30°C : 4.3kΩ 10°C : 9.7kΩ 40°C : 3.1kΩ 20°C : 6.4kΩ 25°C : 5.3kΩ | Resistance value check |
| | TH2 (Piping temperature) | | ① Indoor unit control (Anti-freeze/heat adjustment) ② LEV control during heating operation (subcool detection) | | |
| | TH3 (Gas-side piping temperature) | | LEV control during cooling operation (superheat detection) | | |
| | TH4 (Outdoor air temperature) | | Indoor unit control (Thermo) | | |
| | Temperature sensor (Indoor air temperature) | | Indoor unit control (Thermo) | | |

[3] BC controller

1. G type

| Name | Symbol (function) | Notes | Function | Specification | Check method |
|-----------------|--------------------------------------|-------|---|---|-------------------------------|
| Pressure sensor | 63HS1 (Liquid side) | | ① Detects liquid-side (high pressure) pressure ② LEV control | <p>63HS Connector 1 2 3 1 GND (Black) 2 Vout (White) 3 Vcc (DC5V) (red)</p> <p>Pressure 0~4.15MPa Vout 0.5~3.5V 0.071V/0.098MPa Pressure [MPa] =1.38×Vout[V]-0.69</p> | |
| | 63HS3 (Mid point) | | ① Detects mid-point pressure ② LEV control | | |
| Thermistor | TH11 (Liquid inlet temperature) | | LEV control (liquid level control) | $R_0=15k\Omega$ $R_{0/100}=3460$ $R_t = 15 \exp\left\{3460\left(\frac{1}{273+t} - \frac{1}{273}\right)\right\}$ 0°C : 15kΩ 10°C : 9.7kΩ 20°C : 6.4kΩ 25°C : 5.3kΩ 30°C : 4.3kΩ 40°C : 3.1kΩ | |
| | TH12 (By-pass outlet temperature) | | LEV control (Superheat) | | |
| | TH15 (By-pass outlet temperature) | | LEV control (Superheat) | | |
| | TH16 (By-pass outlet temperature) | | LEV control (Subcool) | | |
| Solenoid valve | SVM1 | | Open during all-cooling and defrost operations | AC220~240V Open when being powered Open when not being powered | Continuity test with a tester |
| | SV□A | | Supplies refrigerant to indoor units in cooling operation | | |
| | SV□B | | Supplies refrigerant to indoor units in heating operation | | |
| | SV□C | | Supplies refrigerant to indoor units in cooling operation | | |
| LEV | LEV1 | | Liquid level control Pressure difference control | DC12V Opening of stepping motor driving valve 0-2000 pulses | Same as the indoor LEV |
| | LEV3 | | Liquid level control Pressure difference control | | |

2. GA type

| Name | Symbol (function) | Notes | Function | Specification | Check method |
|-----------------|--------------------------------------|-------|---|---|-------------------------------|
| Pressure sensor | 63HS1 (Liquid side) | | ① Detects liquid-side (high pressure) pressure ② LEV control | <p>63HS Connector 1 2 3 Pressure 0~4.15MPa Vout 0.5~3.5V 0.071V/0.098MPa Pressure [MPa] = 1.38×Vout[V]-0.69 1 GND (Black) 2 Vout (White) 3 Vcc (DC5V) (red)</p> | |
| | 63HS3 (Mid point) | | ① Detects mid-point pressure ② LEV control | | |
| Thermistor | TH11 (Liquid inlet temperature) | | LEV control (liquid level control) | $R_0=15k\Omega$ $R_{0/100}=3460$ $R_t = 15\exp\{3460(\frac{1}{273+t} - \frac{1}{273})\}$ 0°C : 15kΩ 10°C : 9.7kΩ 20°C : 6.4kΩ 25°C : 5.3kΩ 30°C : 4.3kΩ 40°C : 3.1kΩ | |
| | TH12 (By-pass outlet temperature) | | LEV control (Superheat) | | |
| | TH15 (By-pass inlet temperature) | | LEV control (Superheat) | | |
| | TH16 (Liquid temperature) | | LEV control (Subcool) | | |
| Solenoid valve | SVM1 | | Open during all-cooling and defrost operations | AC220~240V Open when being powered Open when not being powered | Continuity test with a tester |
| | SVM2 | | Pressure difference control | | |
| | SV□A | | Supplies refrigerant to indoor units in cooling operation | | |
| | SV□B | | Supplies refrigerant to indoor units in heating operation | | |
| | SV□C | | Supplies refrigerant to indoor units in cooling operation | | |
| LEV | LEV1 LEV2 | | Liquid level control Pressure difference control | DC12V Opening of stepping motor driving valve 0-2000 pulses | Same as the indoor LEV |
| | LEV3 | | Liquid level control Pressure difference control | | |

3. GB type

| Name | Symbol (function) | Notes | Function | Specification | Check method |
|----------------|--------------------------------------|-------|---|--|-------------------------------|
| Thermistor | TH22 (By-pass outlet temperature) | | LEV control (Superheat) | $R_0=15k\Omega$ $R_{0/100}=3460$ $R_t = 15\exp\{3460(\frac{1}{273+t} - \frac{1}{273})\}$ 0°C : 15kΩ 10°C : 9.7kΩ 20°C : 6.4kΩ 25°C : 5.3kΩ 30°C : 4.3kΩ 40°C : 3.1kΩ | |
| | TH25 (By-pass inlet temperature) | | LEV control (Superheat) | | |
| Solenoid valve | SV□A | | Supplies refrigerant to indoor units in cooling operation | AC220~240V Open when being powered Open when not being powered | Continuity test with a tester |
| | SV□B | | Supplies refrigerant to indoor units in heating operation | | |
| | SV□C | | Supplies refrigerant to indoor units in cooling operation | | |
| LEV | LEV3a | | Pressure difference control | DC12V Opening of stepping motor driving valve 0-2000 pulses | Same as the indoor LEV |

7 Control

[1] Dip Switch Functions and Their Factory Settings

1. Heat source unit

(1) Main board

| Switch | Function | Function according to switch setting | | Switch setting timing | |
|--------|----------|--|---|---|--|
| | | OFF | ON | OFF | ON |
| SWU | 1~2 | Unit address setting | | Set to 00 or 51-100 with the dial switch | |
| SW1 | 1~10 | For self-diagnosis/operation monitoring | | Refer to the LED monitor display on the outdoor unit board | |
| SW2 | 1 | Centralized control switch | Not connected to the centralized control | Connected to the centralized control | Before power on |
| | 2 | Deletion of connection information | Ordinary control | Deletion | Before power on |
| | 3 | Deletion of error history | Storage of IC/OC error history | Deletion of IC/OC error history | Anytime after power on (When switched from OFF to ON) |
| | 4 | Refrigerant amount adjustment | Ordinary control | Refrigerant amount adjustment mode | Anytime after power on (Except during initial start up mode/becomes ineffective 2 hours after compressor start up) |
| | 5 | – | – | – | – |
| | 6 | – | – | – | – |
| | 7 | Operation ON signal output switching Relay contact output TB8-1,2 | The relay closes during compressor operation. | The relay closes during reception of the cooling or the heating operation signal from the controller. (Note: It is output even if the thermostat is OFF (when the compressor is stopped).) | At all times |
| | 8 | Disregard pump interlock trouble. | Normal | Disregard trouble | At all times |
| | 9 | – | – | – | – |
| | 10 | – | – | – | – |
| SW3 | 1 | Test run: valid/invalid | SW3-2 invalid | SW3-2 valid | Anytime after power on |
| | 2 | Test run: ON/OFF | Stops all ICs | Test runs all ICs | After power on and when SW3-1 is on. |
| | 3 | CN51-3,5 Output switching | Water heat exchanger freeze prevention signal | Heat source unit abnormal output | At all times |
| | 4 | Freeze prevention operation | Normal | Freeze prevention operation* | At all times |
| | 5 | – | – | – | – |
| | 6 | Pump down operation | Ordinary control | Pump down operation | After power on and while compressor is stopped |
| | 7 | Heating Tcm | 49°C | 53°C | Anytime after power on |
| | 8 | – | – | – | – |
| | 9 | – | – | – | – |
| | 10 | – | – | – | – |
| SW4 | 1 | – | – | – | – |
| | 2 | – | – | – | – |
| | 3 | – | – | – | – |
| | 4 | – | – | – | – |
| | 5 | – | – | – | – |
| | 6 | – | – | – | – |
| | 7 | Night mode/Step demand | Night mode | Demand function | Before power on |
| | 8 | – | – | – | – |
| | 9 | – | – | – | – |
| | 10 | – | – | – | – |
| SW5 | 1 | – | – | – | – |
| | 2 | – | – | – | – |
| | 3 | – | – | – | – |
| | 4 | – | – | – | – |
| | 5 | – | – | – | – |
| | 6 | – | – | – | – |
| | 7 | – | – | – | – |
| | 8 | – | – | – | – |
| | 9 | – | – | – | – |
| | 10 | – | – | – | – |

Note: All are set to OFF at factory shipment

(2) INV board

| Switch | Function | Function according to switch setting | | Switch setting timing | | |
|--------|----------|---|-------------------------|--------------------------|------------------------|-----------------------|
| | | OFF | ON | OFF | ON | |
| SW1 | 1 | Enabling/disabling the following error detection functions: ACCT, DCCT sensor circuit error (530X Detail No. 115, 116) ACCT, DCCT sensor error (530X Detail No. 117, 118) IPM open/Disconnected CNCT2 (530X Detail No. 119) Detection of erroneous wiring (530X Detail No. 120) | Error detection enabled | Error detection disabled | Anytime after power on | |
| | 2 | — | — | — | — | |
| | 3 | — | — | — | — | |
| | 4 | — | — | — | — | |
| | 5 | — | — | — | — | |
| | 6 | — | — | — | — | |
| | SW2 | 1 | Inverter address | 0 | 1 | Always leave it to ON |
| 2 | | — | — | — | — | |
| 3 | | — | — | — | — | |
| 4 | | — | — | — | — | |

Note 1 Except for SW2-1, all are set to OFF at factory shipment.

Unless otherwise specified, set the switch to OFF where indicated by “—,” which may be set to a certain setting for a reason.

Note 2 Leave SW1-1 off during normal operation. If it is turned on, errors cannot be detected and the unit may be damaged.







2. Indoor unit







DIP SW1, 3

| Switch | Function | Function according to switch operation | | Switch set timing | | Remarks |
|--------|----------|--|-----------------------|----------------------------|--|-----------------------------------|
| | | OFF | ON | OFF | ON | |
| SW1 | 1 | Room temp. sensor position | Indoor unit inlet | Built in remote controller | At unit stopping (at remote controller OFF) | |
| | 2 | Clogged filter detect. | None | Provided | | |
| | 3 | Filter duration | 100h | 2500h | | |
| | 4 | OA intake | Ineffective | Effective | | Always ineffective for PKFY-P.VAM |
| | 5 | Remote display select. | Fan output display | Thermo. ON signal display | | |
| | 6 | Humidifier control | At stationary heating | Always at heat. | | |
| | 7 | Heating thermo. OFF airflow | Very low speed | Low speed | | |
| | 8 | Heating thermo. OFF airflow | SW1-7 setting | Set airflow | | |
| | 9 | Power failure automatic return | Ineffective | Effective | | |
| | 10 | Power source start/stop | Ineffective | Effective | | |
| SW3 | 1 | Model selection | Heat pump | Cooling only | | |
| | 2 | Louver <small>{ Cooling capacity saving for PKFY-P. VAM, effective/ineffective }</small> | None | Provided | | |
| | 3 | Vane | None | Provided | | |
| | 4 | Vane swing function | None | Provided | Not provided for PKFY-P.VAM | |
| | 5 | Vane horizontal angle | 1st setting | 2nd setting | | |
| | 6 | Vane angle set for cooling | Down blow B, C | Horizontal | Always down blow B,C for PKFY-P.VAM | |
| | 7 | – | – | – | | |
| | 8 | Heating 4K up | Effective | Ineffective | Ineffective (ON) setting for floor standing | |
| | 9 | – | – | – | | |
| | 10 | – | – | – | | |

Note: When both SW1-7 and SW1-8 are being set to ON, the fan stops at the heating thermostat of OFF.

Setting of DIP SW2

| Model | P20 | P25 | P32 | P40 | P50 | P63 | P71 |
|----------------------------|--|--|--|--|---|--|--|
| Capacity code (model name) | 4 | 5 | 6 | 8 | 10 | 13 | 14 |
| SW2 setting | ON OFF  | ON OFF  | ON OFF  | ON OFF  | ON OFF  | ON OFF  | ON OFF  |

| Model | P80 | P100 | P125 | P140 | P200 | P250 |
|----------------------------|--|--|--|--|---|--|
| Capacity code (model name) | 16 | 20 | 25 | 28 | 40 | 50 |
| SW2 setting | ON OFF  | ON OFF  | ON OFF  | ON OFF  | ON OFF  | ON OFF  |

Setting of DIP SW5

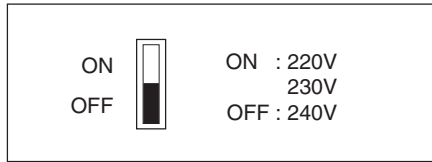
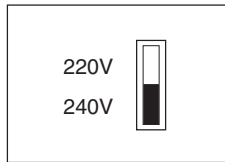

(PLFY-P-VLMD-E)

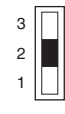
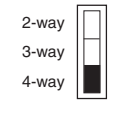
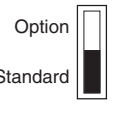
| Switch | Function | Operation by switch | Switch set timing | | | | | | | | | | | | | | | | |
|-----------|----------------------------------|---|-----------------------|----------------|---|------|-------|----------------|----------------|------|-----------------------|----------------|----------------|----------------|-------|----------------|----------------|----------------|-----------------------|
| SWA | Ceiling height setting | <p>(PCFY-P-VGM-E)</p>  <table border="1" data-bbox="590 851 813 985"> <thead> <tr> <th></th> <th>Ceiling height</th> </tr> </thead> <tbody> <tr> <td>3</td> <td>3.5m</td> </tr> <tr> <td>2</td> <td>2.8m</td> </tr> <tr> <td>1</td> <td>2.3m</td> </tr> </tbody> </table> | | Ceiling height | 3 | 3.5m | 2 | 2.8m | 1 | 2.3m | Always after powering | | | | | | | | |
| | Ceiling height | | | | | | | | | | | | | | | | | | |
| 3 | 3.5m | | | | | | | | | | | | | | | | | | |
| 2 | 2.8m | | | | | | | | | | | | | | | | | | |
| 1 | 2.3m | | | | | | | | | | | | | | | | | | |
| SWA | External static pressure setting | <p>(PDFY-P20 ~ 80VM-E, PEFY-P20 ~ 80VMM-E)</p>  <p>100Pa 50Pa 30Pa</p> <p>For other models, change the setting of static pressure by replacing the connector.</p> | Always after powering | | | | | | | | | | | | | | | | |
| SWB | Setting of air outlet opening | <p>(PLFY-P-VAM-E)</p>  <table border="1" data-bbox="813 1276 1133 1545"> <thead> <tr> <th>SWB \ SWA</th> <th>1</th> <th>2</th> <th>3</th> </tr> </thead> <tbody> <tr> <td>2-way</td> <td>4.0m (3.3m)</td> <td>4.2m (3.5m)</td> <td>-</td> </tr> <tr> <td>3-way</td> <td>3.6m (3.0m)</td> <td>4.0m (3.3m)</td> <td>4.2m (3.5m)</td> </tr> <tr> <td>4-way</td> <td>3.2m (2.7m)</td> <td>3.6m (3.0m)</td> <td>4.2m (3.5m)</td> </tr> </tbody> </table> <p>Values in the parentheses are for P32~80 types.</p> | SWB \ SWA | 1 | 2 | 3 | 2-way | 4.0m (3.3m) | 4.2m (3.5m) | - | 3-way | 3.6m (3.0m) | 4.0m (3.3m) | 4.2m (3.5m) | 4-way | 3.2m (2.7m) | 3.6m (3.0m) | 4.2m (3.5m) | Always after powering |
| SWB \ SWA | 1 | 2 | 3 | | | | | | | | | | | | | | | | |
| 2-way | 4.0m (3.3m) | 4.2m (3.5m) | - | | | | | | | | | | | | | | | | |
| 3-way | 3.6m (3.0m) | 4.0m (3.3m) | 4.2m (3.5m) | | | | | | | | | | | | | | | | |
| 4-way | 3.2m (2.7m) | 3.6m (3.0m) | 4.2m (3.5m) | | | | | | | | | | | | | | | | |
| SWC | Airflow control | <p>(PLFY-P-VAM-E, PCFY-P-VGM-E, PKFY-P-VGM-E, PDFY-P-VM-E)</p>  <p>Option Standard</p> <p>Set to the option to install the high efficiency filter.</p> | Always after powering | | | | | | | | | | | | | | | | |

3. BC controller (main board)

| Switch | Function | Function according to the switch setting | | Switch setting timing | |
|--------|----------|--|---|-----------------------|------------------------|
| | | OFF | ON | | |
| SW4 | 1 | Model type setting | R410A | - | Always leave it to OFF |
| | 2~8 | - | - | - | - |
| SW5 | 1~6 | - | - | - | - |
| | 7 | Model type setting | Refer to the "Model type setting" below | | Before powering |
| | 8 | Model type setting | Refer to the "Model type setting" below | | Before powering |

• Model type setting

| | | SW5-8 | |
|-------|-----|---------|---------|
| | | OFF | ON |
| SW5-7 | OFF | Type G | |
| | ON | Type GA | Type GB |

4. Remote controller

(1) MA remote controller (PAR-20MAA)

Removing the cover shows switches at the lower part of the remote controller unit. By operating these switches, the remote controller main/sub, and other function will be set.

In normal case, do not change the setting except No.1 switch used to set the main/sub. (All setting at factory shipment are "ON.")

Remote controller unit

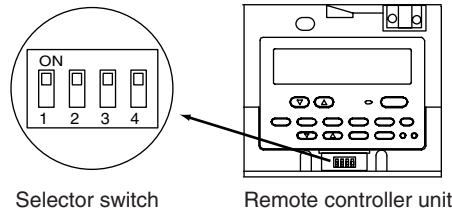

| Switch | Function | ON | OFF | Action by switching | Switch set timing |
|--------|--|-----------------|---------------------|--|-------------------|
| 1 | Remote controller main/sub | Main | Sub | Sets one to "Sub" when connecting 2 sets in 1 group. | Before powering |
| 2 | At powering of remote controller | Normal start up | Timer mode start up | Sets to "Timer mode start up" so desired at power failure return when the schedule timer is connected. | Before powering |
| 3 | Cooling/heating display at automatic setting | Yes | No | Sets to "No" when not desiring to display "Cooling" or "Heating." | Before powering |
| 4 | Inlet temperature display | Yes | No | Sets to "No" when not desiring to display inlet temperature. | Before powering |

(2) ME remote controller (PAR-F27MEA-F)

Set the address of the remote controller with the rotary switch.

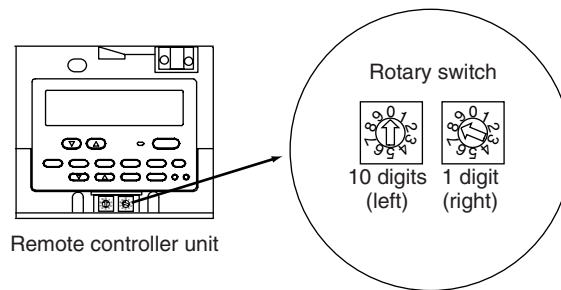

Example: In case of address 108

| | Address setting range | Setting method |
|------------------------|-----------------------|---|
| Main remote controller | 101 ~ 150 | Set to the lowest indoor main unit address + 100. |
| Sub remote controller | 151 ~ 200 | Set to the lowest indoor main unit address + 150. |

| Setting of rotary switch | Address No. |
|--------------------------|--------------------------------|
| 01 ~ 99 | 101 ~ 199 being added with 100 |
| 00 | 200 |

Note : To set addresses, use a precision screwdriver [(-), 20mm (w)], and apply load less than 19.6N.
Operating with a method other than above may damage the rotary switch.

[2] Controlling the Heat source unit

1. Initial control

- When the power is turned on, the initial processing of the microcomputer is given top priority.
- During the initial processing, control processing of the operation signal is suspended. The control processing is resumed after the initial processing is completed.
(Initial processing: processing of the data inside the microcomputer and initial setting of each LEV opening, requiring up to approximately 2 minutes.)
- During the initial processing, the LED monitor on the heat source unit's main board displays "S/W version", "refrigerant type", "heat pump", "cooling only and capacity" in turn every second.

2. Control at start-up

- The upper limit of frequency during the first 3 minutes of the operation is 50Hz.
- When the power is turned on, normal operation will start after the initial start-up mode (to be described later) has been completed (with a restriction on the frequency).

3. Bypass control

Bypass solenoid valves, which bypass the high- and low- pressure sides, operate in the following manner.

(1) Bypass solenoid valve (SV1) (ON = Open)

| Operation Timing | SV1 | |
|--|--|---|
| | ON (Open) | OFF (Close) |
| At No. 1 compressor start up or at No. 2 compressor start up (P450-P650 types only) | ON for 4 minutes | |
| After the restoration of thermo or 3 minutes after restart | ON for 2 minutes | |
| During cooling or heating operation with the compressor stopped | Always ON. (Exception : OFF when HPS-LPS \leq 0.2MPa) | |
| After the operation has stopped | ON for 3 minutes. (Exception : OFF when HPS \leq 0.2MPa) | |
| During defrost operation (See figure *1 below.) | Always ON | |
| During oil-recovery operation | Always OFF during cooling operation and always ON during heating operation when running an oil-recovery operation after running a continuous operation at low frequency. | |
| During an operation with the compressor running at 30Hz When low pressure (LPS) drops When low pressure (LPS) drops (After 3 minutes have past since start up) | When low pressure (LPS) drops below 0.23 MPa. | When low pressure (LPS) exceeds 0.38 MPa. |
| When high pressure (Pd) rises | When Pd exceeds 3.77 MPa | When Pd is or below 3.43MPa and 30 seconds has passed |

[Example of an SV1 operation]

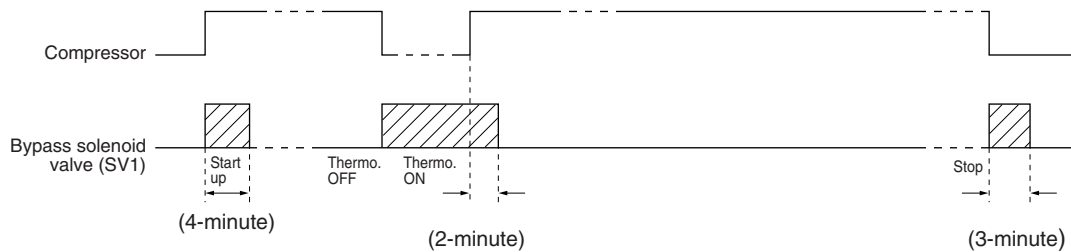

4. Frequency control

- Depending on the capacity required, the frequency of the compressor is controlled to keep constant the evaporation temperature ($0^{\circ}\text{C} = 0.71\text{MPa}$) during cooling operation and condensing temperature ($49^{\circ}\text{C} = 2.88\text{MPa}$) during heating operation.
- The following table shows the frequency change of the inverter compressor during normal operation.

| Model | Frequency/cooling | Frequency/heating | Speed |
|-----------|-------------------|-------------------|----------|
| P200 type | 20~62Hz(**) | 20~52Hz | 3Hz/sec. |
| P250 type | 20~67Hz(**) | 20~62Hz | 3Hz/sec. |
| P400 type | 20~100Hz | 20~100Hz | 3Hz/sec. |
| P500 type | 20~120Hz | 20~120Hz | 3Hz/sec. |

- * The maximum frequency during heating operation is affected by the outdoor air temperature to a certain extent.
- ** When the total capacity of the connected indoor units is less than 100% of the maximum allowable capacity: P200 type: 20~52, P250 type: 20~62.

(1) Pressure limit

The maximum limit of high pressure (P_d) is set for each frequency level. If this limit is exceeded, the frequency will be reduced every 30 seconds.

(2) Discharge temperature limit

The discharge temperature (T_d) of the compressor in operation is detected, and if it exceeds the upper limit, the frequency is reduced by 5 Hz.

- Control is performed 30 seconds after compressor start-up and every 30 seconds thereafter.
- Operating temperature is 115°C .

(3) Periodic frequency control

Frequency control other than the ones performed at startup, upon status change, and for protection is called periodic frequency control (conversent control) and is performed in the following manner.

① Periodic control cycle

Periodic control is performed after the following time has passed

- (a) 30 seconds after either compressor start up or the completion of defrost operation
- (b) 30 seconds after frequency control by discharge temperature or by pressure limit

② The amount of frequency change

The amount of frequency change is controlled to approximate the target value based on the evaporation temperature (T_e) and condensing temperature (T_c).

5. Refrigerant recovery control (1) [PQRY only]

Recovery control (1) is performed to prevent an excess flow of refrigerant to the BC controller. It is performed during cooling operation also to prevent excess accumulation of refrigerant in the heat source unit.

(1) Starting conditions for refrigerant recovery

<Starting conditions 1>[Cooling only, cooling main, heating only, heating main]

Refrigerant recovery (1) begins when all of the following conditions are met.

15 minutes (heating only, heating main)/5 minutes (cooling only, cooling main) have past since the completion of the last refrigerant recovery AND the Td meets the following criteria.

$$T_d > 105^{\circ}\text{C}$$

<Starting conditions 2>[Heating only, heating main]

Refrigerant recovery (1) begins when all of the following conditions are met.

- ① Evaporation temperature $< -5^{\circ}\text{C}$ remains true for 3 continuous minutes.
- ② Discharge superheat is above 30°C .

(2) Refrigerant recovery operation

The opening of LEV1 and LEV3 is increased.

6. Refrigerant recovery control (2)

<PQRY>

Refrigerant recovery (2) is performed to keep the refrigerant from accumulating in the stopped unit (ventilation unit) and is performed at each BC controller port.

(1) Starting conditions for refrigerant recovery

Refrigerant recovery (2) begins when all of the following conditions are met.

- ① 30 minutes have passed since the demand for a particular port becomes anything other than "Cooling Thermo-ON."
- ② 30 minutes have passed since the completion of the last refrigerant recovery operation.
- ③ The port is not in the 3-minute restart prevention mode.

(2) Refrigerant recovery operation

- Thermostat's demand for the port is "Heating Thermo-ON."

Refrigerant recovery operation is performed by opening the LEV on the applicable indoor unit (Stopped, ventilation mode, or cooling mode) for 30 seconds.

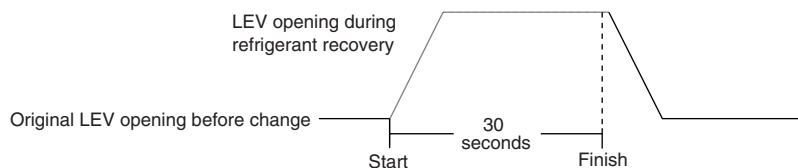

- Thermostat's demand for the port is anything other than "Heating Thermo-ON."
SV□C at the port is kept open for 30 seconds. (□ corresponds to the port number.)

<PQHY>

- Recovery of refrigerant is performed during heating operation to prevent the refrigerant from accumulating inside the unit while it is stopped (unit in fan mode), or inside the indoor unit that is in cooling mode or in heating mode with thermo off.

It is also performed during cooling operation to prevent an excessive amount of refrigerant from accumulating in the heat source unit heat exchanger.

[During heating operation]

(1) Initiation of refrigerant recovery

- Recovery of refrigerant during heating operation begins when all of the following three conditions are met:
 - ① 15 minutes have past since the completion of previous refrigerant recovery.
 - ② $T_d > 115^{\circ}\text{C}$
 - ③ Frequencies below 50 Hz

(2) Refrigerant recovery

- Refrigerant is recovered with the LEV on the applicable indoor unit (unit under stopping mode, fan mode, cooling, heating with thermo off) being opened for 30 seconds.
- Periodic capacity control of the outdoor units and periodic LEV control of the indoor units will be suspended during refrigerant recovery operation; they will be performed after the recovery has been completed.
- Defrost operation will be suspended until refrigerant recovery has been completed.

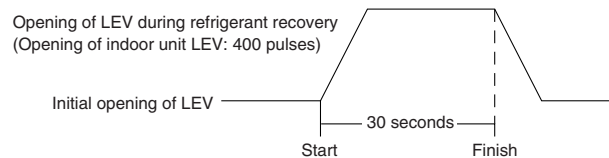

[During cooling operation]

(1) Initiation of refrigerant recovery

- Recovery of refrigerant during cooling operation begins when all of the following conditions are met:
 - ① 30 minutes have past since the completion of previous refrigerant recovery.
 - ② When discharge temperature has remained above the limit continuously.
 - ③ $T_d > 105^{\circ}\text{C}$ or [$P_d > 3.43\text{MPa}$ ($35\text{kg/cm}^2\text{G}$ and $SC0 > 10\text{deg}$)]

(2) Refrigerant recovery

- Increase the opening of LEV1 (Periodic control begins when 30 seconds have elapsed).

7. Control of heat source unit heat exchanger capacity

(1) Control method

- Depending on capacity required, control solenoid valves (SV4a~4d, 5a~5b, 7a~7c) to maintain a constant evaporation temperature ($0^{\circ}\text{C} = 0.71\text{MPa}$) during cooling operation and constant condensing temperature ($49^{\circ}\text{C} = 2.88\text{MPa}$) during heating operation.

(2) Patterns of heat source unit heat exchanger capacity control

○ : Open × : Closed

| Operation type | Solenoid valve | | | | | | | | |
|--------------------------|----------------|------|------|------|------|------|------|------|------|
| | SV4a | SV4b | SV4c | SV4d | SV5a | SV5b | SV7a | SV7b | SV7c |
| Cooling only | ○ | ○ | ○ | × | ○ | ○ | ○ | × | × |
| | ○ | ○ | ○ | × | ○ | ○ | ○ | ○ | × |
| | ○ | ○ | ○ | × | ○ | × | ○ | × | × |
| | ○ | ○ | ○ | × | ○ | × | ○ | ○ | × |
| | ○ | ○ | ○ | × | × | × | ○ | × | × |
| | ○ | ○ | ○ | × | × | × | ○ | ○ | × |
| | × | ○ | ○ | × | × | × | ○ | × | × |
| | × | ○ | ○ | × | × | × | × | × | × |
| | × | ○ | ○ | × | × | × | × | ○ | × |
| | × | × | ○ | × | × | × | × | × | × |
| | × | × | ○ | ○ | × | × | × | × | × |
| | × | × | × | × | × | × | × | × | × |
| Cooling main (PQRY only) | ○ | ○ | ○ | × | ○ | ○ | ○ | × | × |
| | ○ | ○ | ○ | × | ○ | ○ | ○ | ○ | × |
| | ○ | ○ | ○ | × | ○ | × | ○ | × | × |
| | ○ | ○ | ○ | × | ○ | × | ○ | ○ | × |
| | ○ | ○ | ○ | × | × | × | ○ | × | × |
| | × | ○ | ○ | × | × | × | ○ | × | × |
| | × | ○ | ○ | × | × | × | × | × | × |
| | × | ○ | ○ | × | × | × | × | ○ | × |
| | × | × | ○ | × | × | × | × | × | × |
| | × | × | ○ | × | × | × | × | ○ | × |
| | × | × | ○ | ○ | × | × | × | × | × |
| | × | × | × | × | × | × | × | × | × |
| Heating only | ○ | ○ | ○ | × | ○ | ○ | × | × | ○ |
| | ○ | ○ | ○ | × | ○ | ○ | × | ○ | ○ |
| | ○ | ○ | ○ | × | ○ | × | × | × | ○ |
| | ○ | ○ | ○ | × | × | × | × | ○ | ○ |
| | ○ | ○ | ○ | × | × | × | × | × | ○ |
| | ○ | × | ○ | × | × | × | × | × | ○ |
| | ○ | × | ○ | × | × | × | × | ○ | ○ |
| | ○ | × | × | × | × | × | × | × | ○ |
| | × | × | × | × | × | × | × | × | ○ |
| Heating main (PQRY only) | ○ | ○ | ○ | × | ○ | ○ | × | × | ○ |
| | ○ | ○ | ○ | × | ○ | ○ | × | ○ | ○ |
| | ○ | ○ | ○ | × | ○ | × | × | × | ○ |
| | ○ | ○ | ○ | × | ○ | × | × | ○ | ○ |
| | ○ | ○ | ○ | × | × | × | × | × | ○ |
| | ○ | × | ○ | × | × | × | × | × | ○ |
| | ○ | × | ○ | × | × | × | × | ○ | ○ |
| | ○ | × | × | × | × | × | × | × | ○ |
| | × | × | × | × | × | × | × | × | ○ |
| | × | × | × | ○ | × | × | × | × | ○ |

*All valves are closed while the unit is stopped.
 **SV5a and SV5b are found on P400 or larger models only.

8. Subcool coil control (Linear expansion valve <LEV1>) [PQHY only]

- The amount of super heat is controlled and kept constant based on the bypass outlet temperature (TH8) of subcool coil every 30 seconds.
- The degree of opening is controlled based on the subcool coil outlet/inlet temperature (TH5, TH7), high pressure (Pd), and discharge temperature.
However, the LEV will be closed (0) during heating operation and when the compressor is stopped, and it will be open during cooling operation with thermo off.
- It stays open at 480 during defrost operation.

9. Control at initial startup

- When the unit is started for the first time, it will run the following course of operation.

<Flow chart of initial operation mode>

*Do not operate the unit in the initial operation mode 12 or more hours after power on.

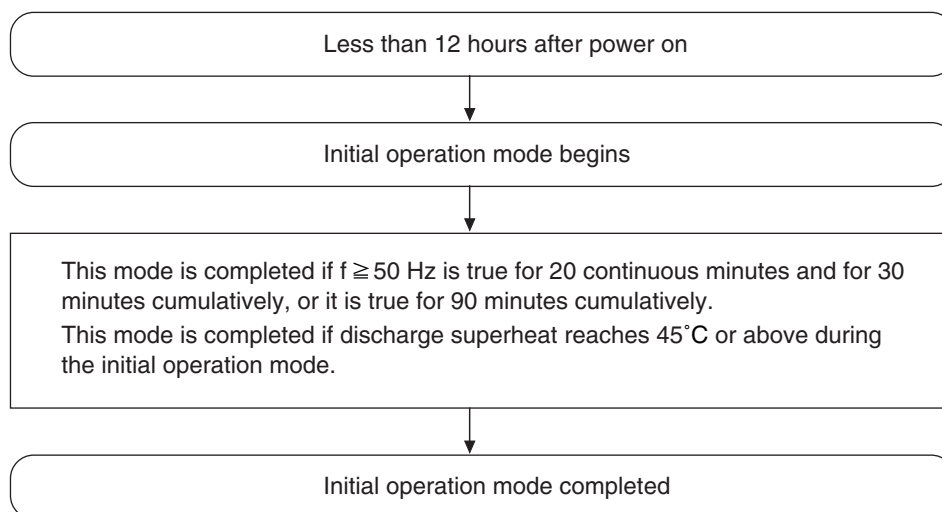

<Restrictions for initial heating operation mode>

* If discharge superheat of the compressor is below a certain range in the heating-only, heating-main, or cooling-main mode, or when the discharge pressure is low, the total indoor unit connection capacity will be limited. (Only in a system with 4 or more indoor units in heating operation)

[Total indoor unit connection capacity]

P200/P250 model heat source unit (with connection of 5 or more indoor units) : P89 model or below
P200/P250 model heat source unit (with connection of 4 or fewer indoor units) : P139 model or below
P400/P500 : P139 model or below

10. Control box cooling System

In PQRV and PQHY, in order to cool the parts in the control box which emit heat, a refrigerant evaporator has been placed in the bottom of the control box (unit frame side).

To cool inside the unit and the control box, refrigerant must be provided to the evaporator during inverter operation and the cooling fan inside the control box must be operated.

(1) Cooling fan control

(a) If the temperature of fin is over 95°C when the inverter is just turned on, run the fan until the temperature drops below 95°C. During this operation, turning on the inverter is prohibited.

(b) When the inverter is operating Always ON

(c) Once the fan goes on, it forcibly remains ON for 1 minute.

(2) LEV 2 control

(a) LEV2 control range.

$$0 \leq \text{LEV 2} \leq 100 \text{ pulses}$$

(b) LEV2 Control method

Cooling only/Cooling main operation

| SHB=THINV-Te (Evaporation temperature) | THHS | LEV2 |
|---|-------------------------------------|------|
| $6 \leq \text{SHB}$ | $55^\circ\text{C} \leq \text{THHS}$ | Up |
| | $\text{THHS} < 55^\circ\text{C}$ | Down |
| $\text{SHB} < 6$ | $55^\circ\text{C} \leq \text{THHS}$ | Down |
| | $\text{THHS} < 55^\circ\text{C}$ | Down |
| – | – | Down |

Heating only/Heating main operation

| Evaporation temperature Te | SHB=THINV-Te (Evaporation temperature) | THHS | LEV2 |
|--|---|-------------------------------------|------|
| $9^\circ\text{C} \leq \text{Te}$ | – | – | Up |
| $7^\circ\text{C} \leq \text{Te} < 9^\circ\text{C}$ | – | – | Up |
| $\text{Te} < 7^\circ\text{C}$ | $6 \leq \text{SHB}$ | $55^\circ\text{C} \leq \text{THHS}$ | Up |
| | | $\text{THHS} < 55^\circ\text{C}$ | Down |
| | $\text{SHB} < 6$ | $55^\circ\text{C} \leq \text{THHS}$ | Down |
| | | $\text{THHS} < 55^\circ\text{C}$ | Down |
| – | – | – | Down |

11. Cooling/heating circuit control and an overview of the functions of system equipment

[PQRY only]

| Operation status | Simplified diagram of refrigerant circuit | Refrigerant cycle-simplified diagram |
|------------------|---|--------------------------------------|
| Cooling only | | |
| Cooling main | | |
| Heating only | | |
| Heating main | | |

12. Operation mode

(1) Indoor unit operation modes

An operation mode can be selected from the following 5 modes on the remote controller.

| | |
|---|---------------|
| ① | Cooling mode |
| ② | Heating mode |
| ③ | Dry mode |
| ④ | Fan mode |
| ⑤ | Stopping mode |

(2) Heat source unit operation modes

<PQRY>

Five operation modes of the heat source units

| | | |
|---|---------------|--|
| ① | Cooling only | All indoor units in are in cooling mode. |
| ② | Heating only | All indoor units in are in heating mode. |
| ③ | Cooling main | Indoor units in the combination of cooling and heating modes |
| ④ | Heating main | Indoor units in the combination of cooling and heating modes |
| ⑤ | Stopping mode | All indoor units are in fan or stopping mode |

When the indoor units are in the combination of cooling and heating modes, operation mode (cooling main or heating main mode) is determined by the heat source unit based on the refrigerant pressure and variation rate in the WR2 refrigerant circuit.

<PQHY>

| | | |
|---|---------------|--|
| ① | Cooling mode | All indoor units in operation are in cooling mode. |
| ② | Heating mode | All indoor units in operation are in heating mode. |
| ③ | Stopping mode | All indoor units are in fan mode or stopping mode. |

Note : If the outdoor unit is already in the cooling mode, other indoor units (in stopping mode, fan mode, thermo OFF) will not run a heating operation when directed to do so, and "HEAT" on the remote controller will blink. When the outdoor unit is already in the heating mode, the reverse will be true. (The first selection made on the remote controller has the priority.)

(3) Patterns of the auto cooling-heating changeover operation [PQRY only]

When the auto heating-cooling changeover mode is selected, indoor temperature is detected as shown in the operation pattern shown below, and the cooling or heating mode is automatically selected.

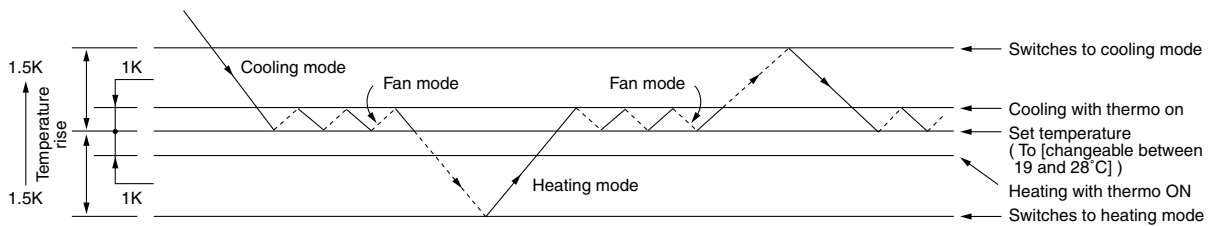

(4) Relationships between operation modes and load capacity (kW) (within the same refrigerant system) [PQRY only]

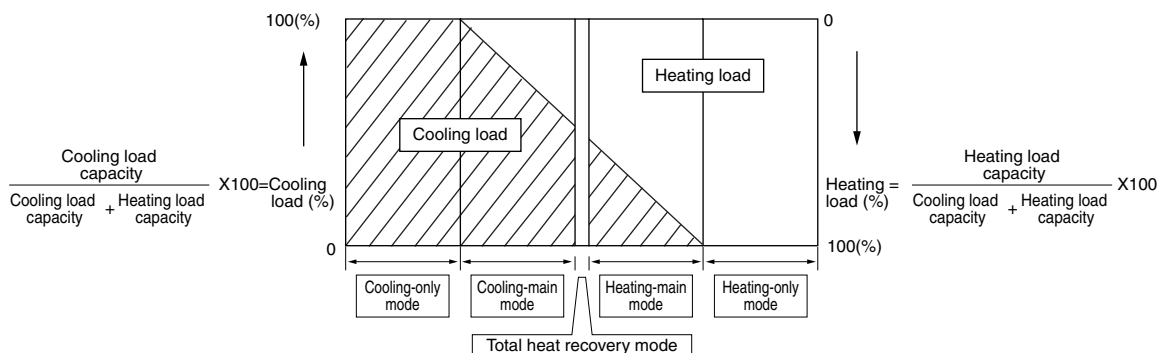

13. BC controller control (CMB-P○G, CMB-P○GA, CMB-P○GB)

(1) SV□A, SV□B, SV□C control

SV□A, SV□B, SV□C comes on and off depending on the mode at the pipe end connection.

| Pipe end connection \ Mode | Cooling | Heating | Stop | Defrost |
|----------------------------|---------|---------|------|---------|
| SV□A | ON | OFF | OFF | OFF |
| SV□B | OFF | ON | OFF | OFF |
| SV□C | ON | OFF | OFF | OFF |

(2) SVM1 control

SVM comes on and off depending on the operation mode.

| Operation mode | Cooling only | Cooling main | Heating only | Heating main | Defrost | Stop |
|----------------|--------------|--------------------------------|--------------|--------------|---------|------|
| SVM1 | ON | Pressure difference control ※2 | OFF | OFF | ON | OFF |

※2: The pressure difference (PS1, P3) is controlled every minute to stay constant.

(3) LEV□ control

The opening of LEV□ (sj) is controlled based on the operation mode.

| | Operation mode | Cooling only | Heating only | Cooling main | Heating main | Defrost | Stop |
|------------|----------------------|----------------------|--------------------------------|---|------------------|---------|------|
| Type G, GA | LEV1 | 2000 | 110 | Liquid-level control ※3 Pressure difference control ※2 | 110 ※4 | 2000 | 1200 |
| | LEV2 Type GA only | | | | | | |
| | LEV3 | Superheat control ※1 | Pressure difference control ※2 | Pressure difference control ※2 | G:1000 G:2000 | 600 | |
| Type GB | LEV3a | Superheat control ※1 | 60 | Superheat control ※1 | 60 | 60 | 60 |

※1: Superheat control - Every minute, the amount of superheat calculated on the bases of bypass outlet/inlet temperature (G,GA:TH12,TH15, GB:TH22,TH25) is controlled every minute to stay constant.

※2: The pressure difference (PS1, P3) is controlled every minute to stay constant.

※3: The liquid level detected on the bases of liquid inlet temperature (TH11) is controlled every minute to stay constant.

※4: It may exceed 110 due to a pressure rise on the liquid side (PS1).

(4) SVM2 control (Type GA only)

| Operation mode | Cooling only | Cooling main | Heating only | Heating main | Defrost | Stop |
|----------------|--------------|--------------|--------------------------------|--------------------------------|---------|------|
| SVM2 | OFF | OFF | Pressure difference control ※2 | Pressure difference control ※2 | OFF | OFF |

14. Demand control

Cooling/heating operation can be prohibited (thermo OFF) by an external input to the indoor units.

Note : When DIPSW4-7 are on, STEP DEMAND are possible. NIGHT MODE will become unavailable however.

SW4-7 : OFF (Compressor ON/OFF and NIGHT MODE)

| CN3D 1-3P | Compressor ON/OFF |
|-----------|-------------------|
| OPEN | ON |
| SHORT | OFF |

| CN3D 1-2P | NIGHT MODE |
|-----------|------------|
| OPEN | OFF |
| SHORT | ON |

SW4-7 : ON (STEP DEMAND)

| CN3D 1-3P \ CN3D 1-2P | OPEN | SHORT |
|-----------------------|------|------------------|
| | OPEN | 100% (no demand) |
| SHORT | 0% | 50% |

Note the following steps to be taken when using the STEP DEMAND

(Example) When switching from 100% to 50%

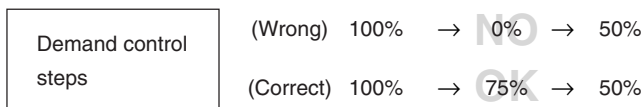

If the step listed as the wrong example above is taken, thermo may go off.

The percentage of the demand listed in the table above is an approximate value based on the compressor volume and does not necessarily correspond with the capacity.

[Example of wiring connection]

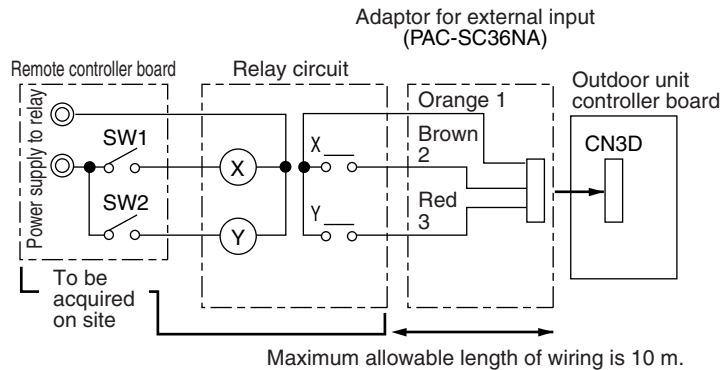

SW1 : NIGHT MODE or demand command

SW2 : Demand command

X, Y : Relay (contact rating DC1mA)

[3] Operation Flow Chart

1. Flow to determine the mode

(1) Indoor unit (cooling, heating, dry, fan mode)

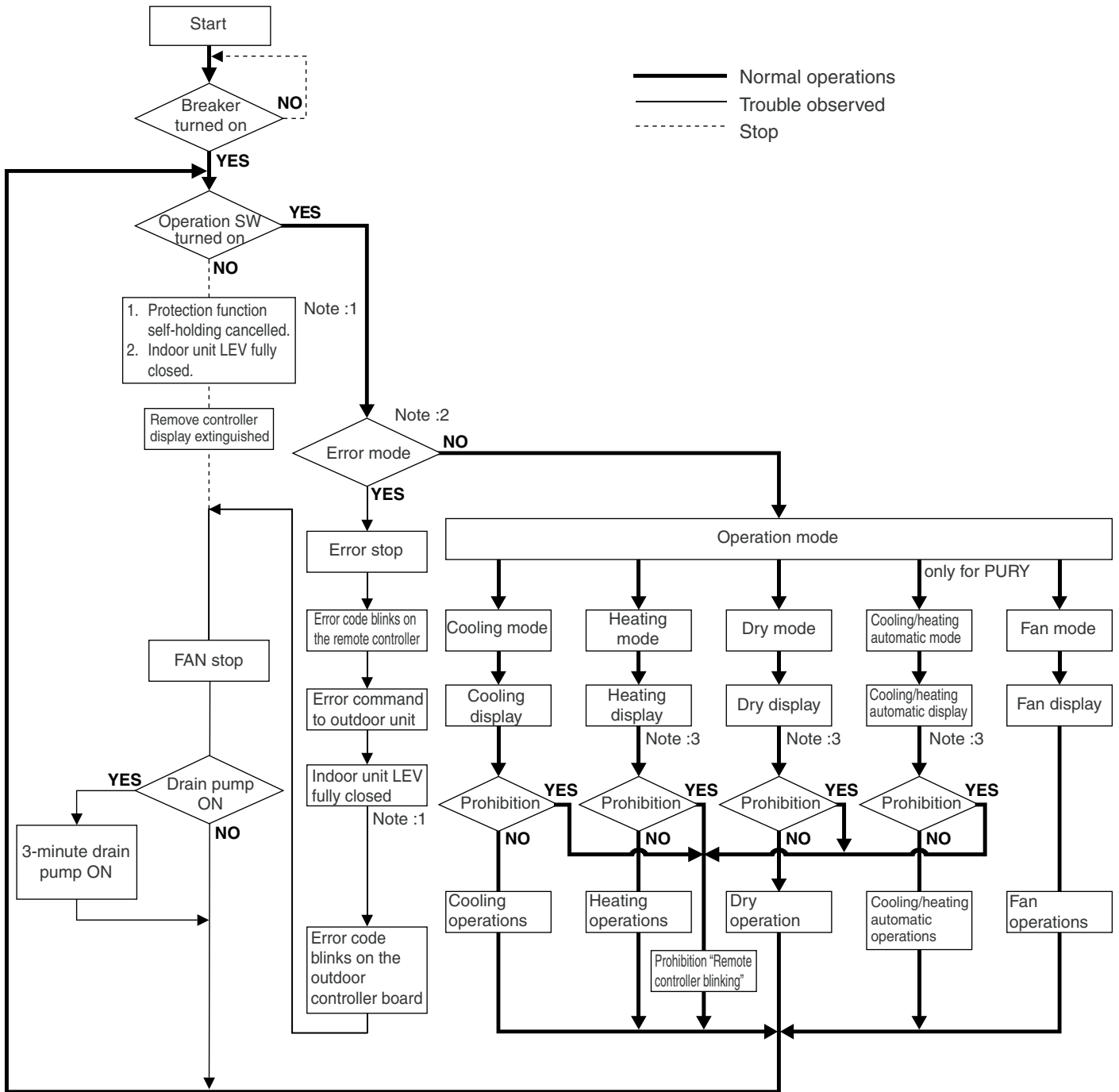

| | |
|----------|---|
| Note : 1 | Indoor unit LEV fully closed : Opening 60 (41) |
| Note : 2 | Two error codes include indoor unit trouble, (BC controller trouble) and outdoor unit side trouble. In the case of indoor unit trouble, error stop is observed in the concerned indoor unit only, and in the cases of (BC controller and) outdoor unit side troubles, error stop is observed in all the indoor units connected. |
| Note : 3 | “Prohibition” status is observed (when several indoor units are connected to one connection, of BC controller and) when connection mode is different from indoor unit operation mode. (Operation mode display on the remote controller blinks on and off, fan stops, and indoor unit LEV is fully closed.) |

(2) Heat source unit (Cooling only, heating only, cooling main, heating main operations)

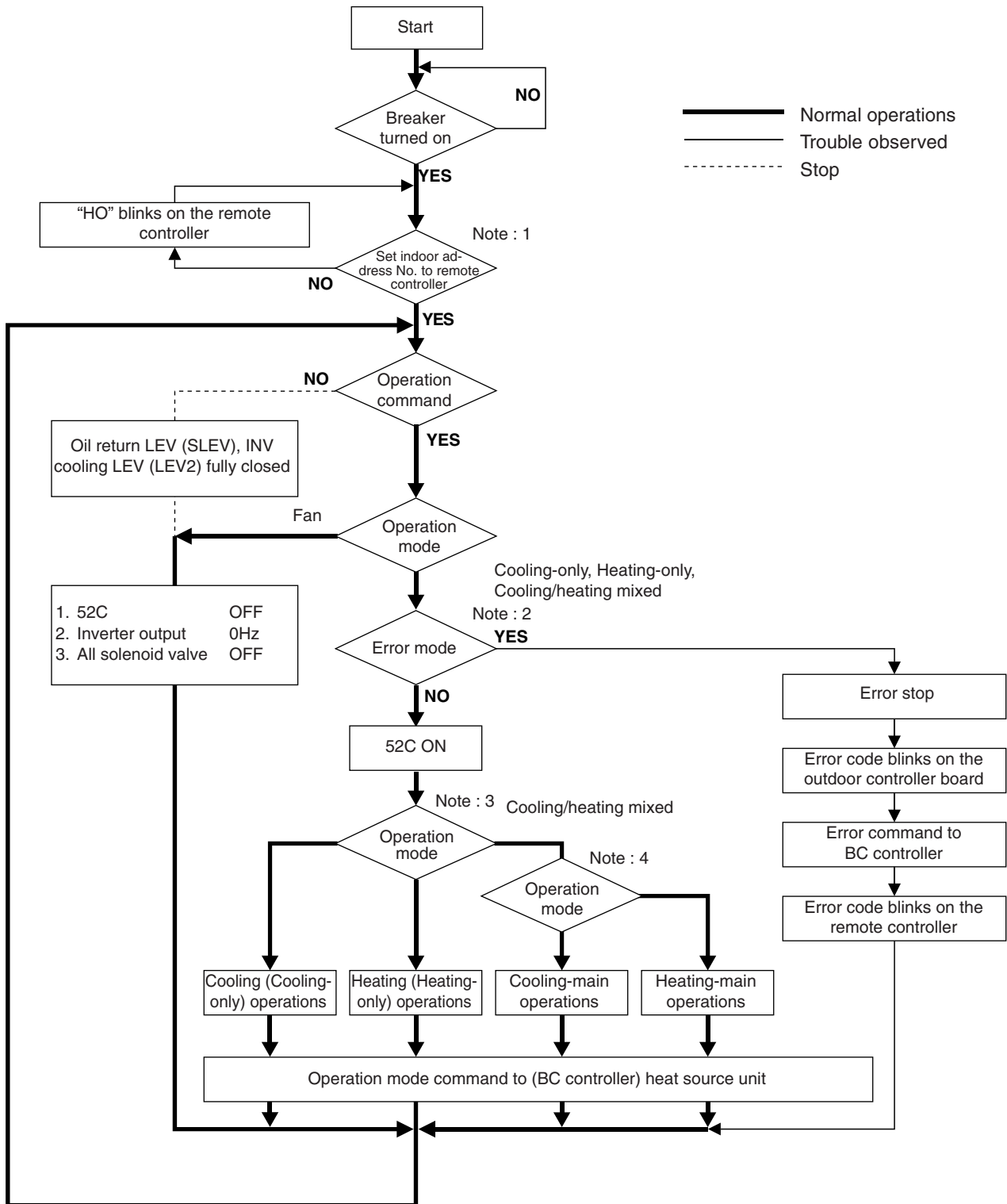

| | |
|----------|--|
| Note : 1 | For about 3 minutes after turning on power source, address and group information of heat source unit, BC, controller indoor unit, and remote controller are retrieved by remote controller, during which "HO" blinks on and off on remote controller. In case indoor unit is not grouped to remote controller, "HO" display on remote controller continues blinking even after 3 minutes after turning on power source. |
| Note : 2 | Two trouble modes included indoor unit side trouble, (BC controller trouble) and heat source unit side trouble. In the case of indoor unit side trouble, error stop is observed in heat source unit only when all the indoor units are in trouble. However, if one or more indoor units are operating normally, heat source unit shows only LED display without undergoing stop. |
| Note : 3 | On PUHY system, operation mode conforms to mode command by indoor unit. However, when heat source unit is being under cooling operation, the operation of indoor unit will be prohibited even by setting a part of indoor units under operation, or indoor unit under stopping or fan mode to heating mode. Reversely when heat source unit is being heating operation, the same condition will be commenced. On PURY system, operation mode conforms to mode command by BC controller. |
| Note : 4 | In case BC controller issues cooling/heating mixed operation mode, heat source unit decides operation mode of cooling-main operation or heating-main operation. |

(3) BC controller (Cooling only, heating only, cooling main, heating main operations)

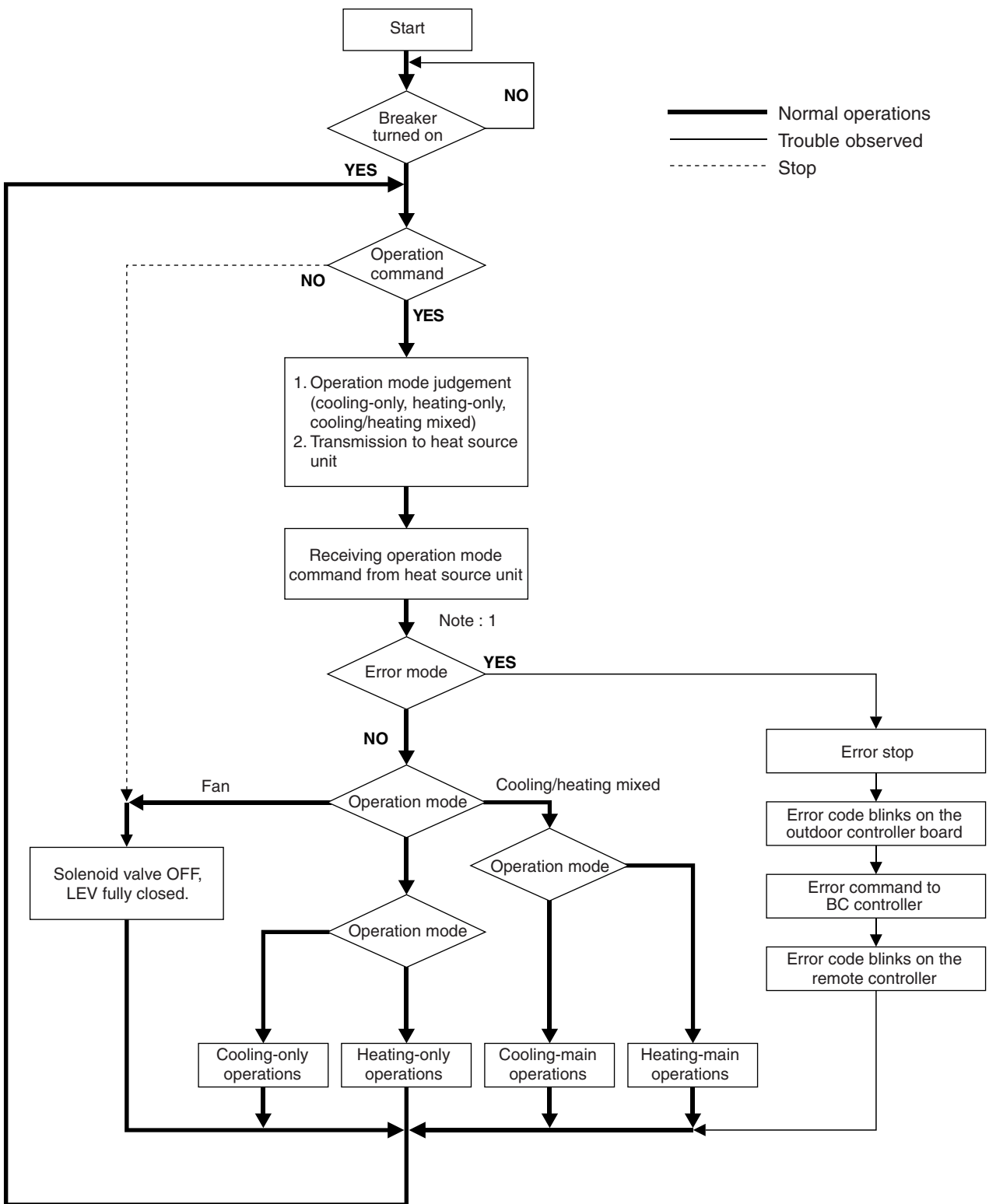

Note : 1 Two error modes include indoor unit side trouble, BC controller trouble, and heat source unit side trouble. In the case of indoor unit side trouble, error stop is observed in the concerned indoor unit only, and in the cases of BC controller and heat source unit side troubles, error stop is observed in all the indoor units, BC controller, and heat source unit.

2. Operation under each mode

(1) Cooling operation

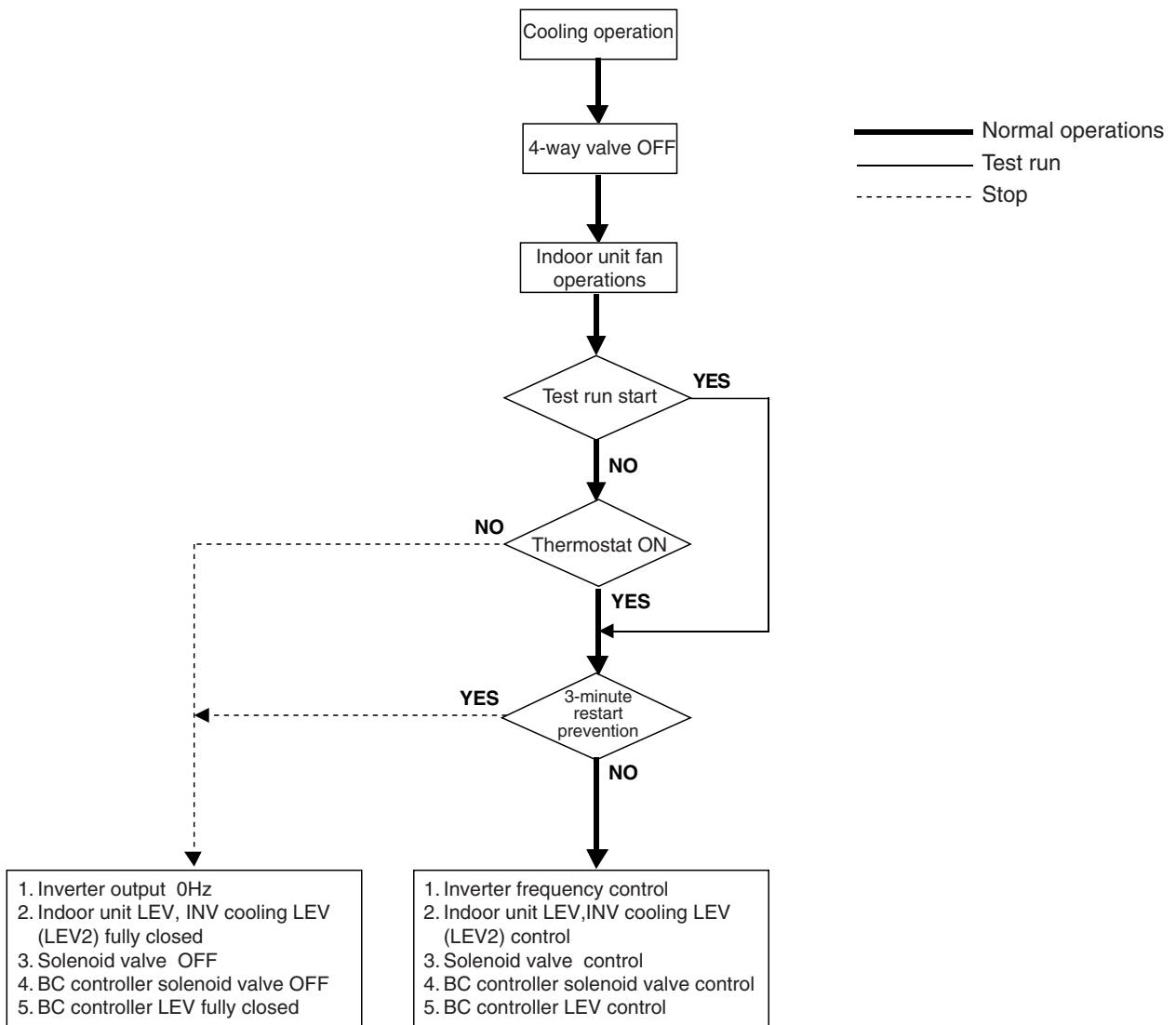

(2) Heating operation

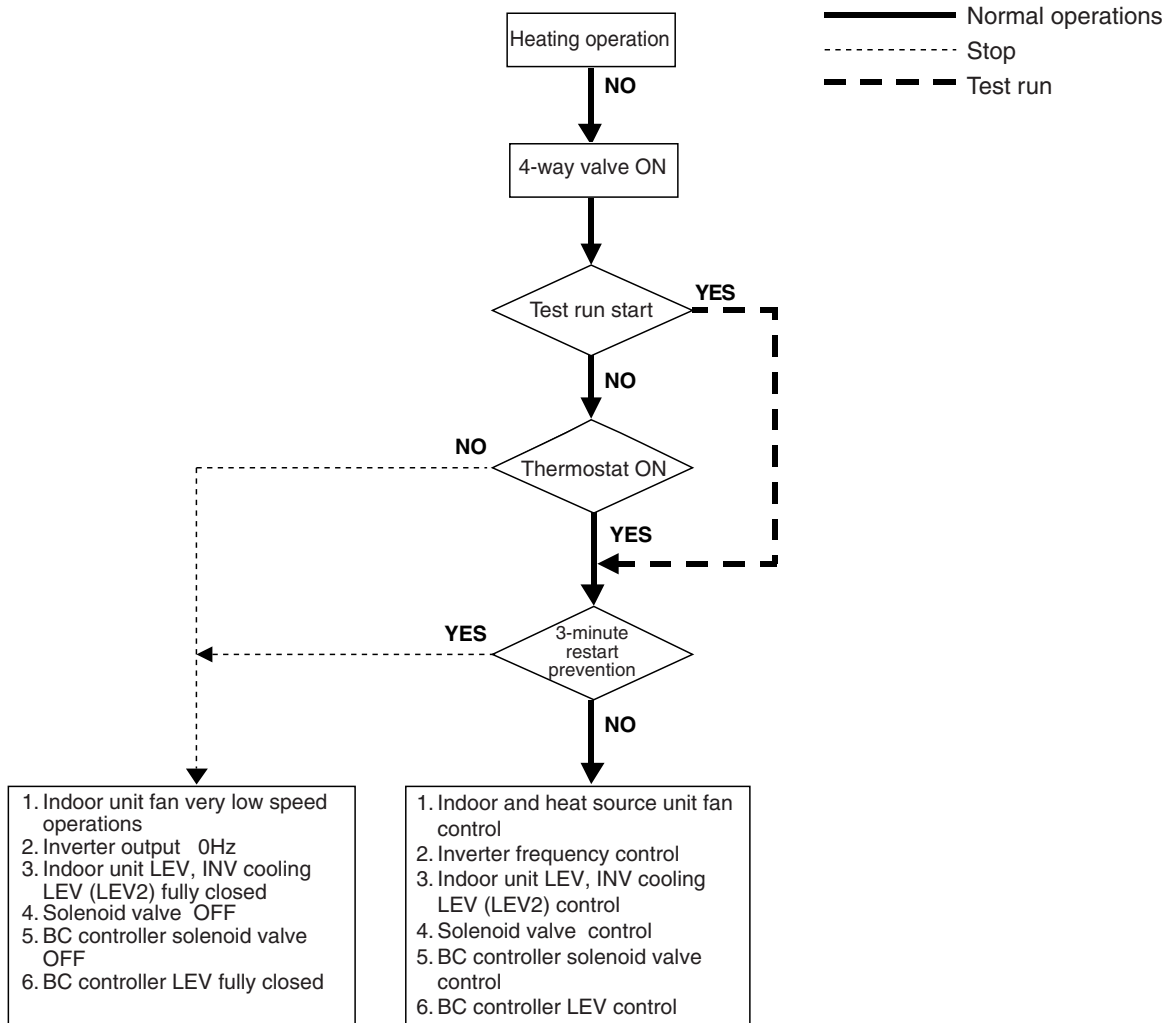

(3) Dry operation

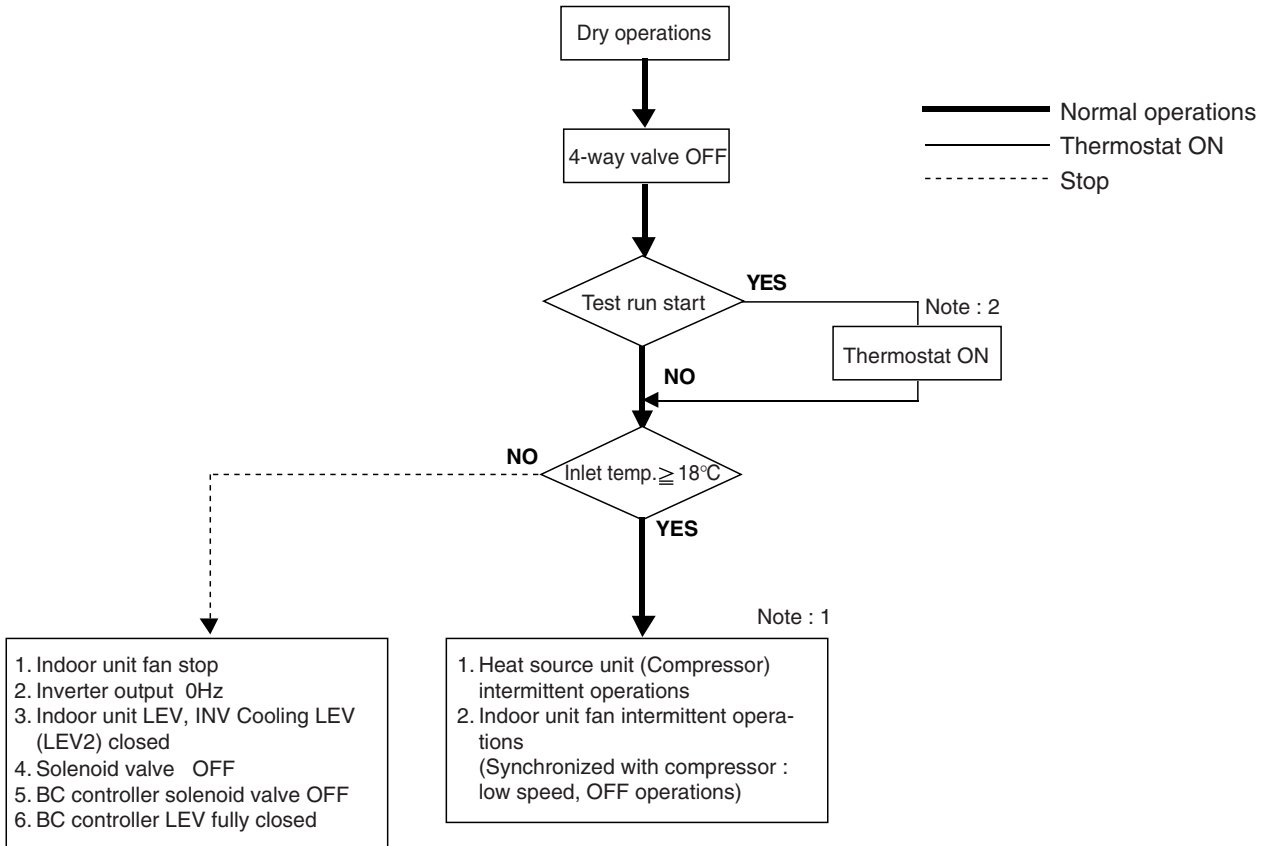

| | |
|----------|--|
| Note : 1 | When indoor unit inlet temperature exceeds 18°C, heat source unit (compressor) and indoor unit fan start intermittent operations synchronously. Operations of heat source unit, BC controller, indoor unit LEV and solenoid valve accompanying compressor are the same as those in cooling operations. |
| Note : 2 | Thermostat is always kept on in test run, and indoor and heat source unit intermittent operation (ON) time is a little longer than normal operations. |

8 Test Run

[1] Check Items before Test Run

| | |
|---|---|
| 1 | Check refrigerant leak, loose power source or transmission line if found. |
| 2 | Measure resistance between the power source terminal block and ground with a 500V megger to confirm it is exceeding 1.0MΩ. Notes: 1. Do not operate the unit when the insulation resistance stays below 1.0MΩ. 2. Never apply a megger to the transmission line terminal block. Otherwise, the control board will be damaged. 3. At immediately after installation or when the unit is left with the main power source turned off for a long time, the insulation resistance between the power source terminal block and ground may drop down to 1MΩ approximately due to refrigerant accumulated inside the compressor. 4. When the insulation resistance counts for more than 1MΩ, power the crankcase heater for 12 hours or more by turning the main power source on. Doing this way evaporates refrigerant inside the compressor leading to increase the insulation resistance. 5. Never measure the insulation resistance of the transmission terminal block for the MA remote controller. |
| 3 | Confirm that the ball valves are fully opened at both gas and liquid sides. Note: 1. Make sure to tighten the cap. |
| 4 | Check the phase order of the 3-phase power source and the voltage between each phase. Note: 1. Open phase or reverse phase causes the emergency stop of test run. (4103 error) |
| 5 | [When connected to the transmission booster for transmission line] Before turning on the outdoor unit, turn on the transmission booster for transmission line. Notes: 1. When the outdoor unit is turned on first, connection information of refrigerant system may not be confirmed normally. 2. If the outdoor unit is turned on first, after turning on the transmission booster for transmission line, reset the power of the outdoor unit. |
| 6 | Turn the main power source on 12 hours at least before test run to power the crankcase heater. Note: 1. Shorter powering time may cause compressor trouble. |

[2] Test Run Method

※ The figure shows an MA deluxe remote controller.

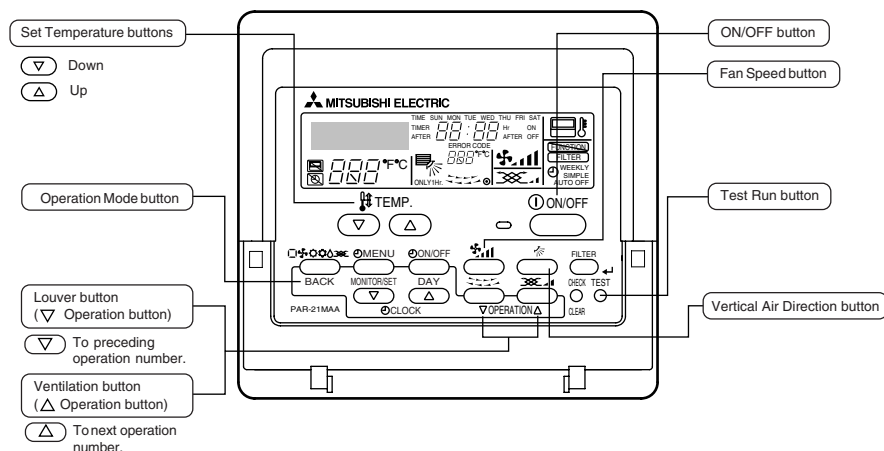

| Operation procedures | |
|--|--|
| Turn on the main power. | → "PLEASE WAIT" appears on the LCD for up to five minutes. Leave the power on for 12 hours. (Energize the crankcase heater.) |
| Press the Test button twice. | → "TEST RUN" will appear on the LCD. |
| Press the Operation Mode button. | → Make sure that the air is blowing out. |
| Switch to cooling (or heating) operation by pressing the Operation Mode button. | → Make sure that cold (or warm) air blows out. |
| Press the Fan Speed button. | → Make sure that the fan speed changes with each pressing of the button. |
| Change the air flow direction by pressing the Vertical Air Direction button or the Louver button. | → Make sure that the air flow direction changes with each pressing of the button. |
| → Confirm the operation of outdoor unit fan. | |
| Confirm the operation of all interlocked equipment, such as ventilation equipment. | |
| Cancel the test run by pressing the ON/OFF button. | → Stop |
| <p>Note 1: Refer to the following pages if an error code appears on the remote controller or when the unit malfunctions.</p> <p>2: The OFF timer will automatically stop the test run after 2 hours.</p> <p>3: The remaining time for the test run will be displayed in the time display during test run.</p> <p>4: The temperature of the liquid pipe on the indoor unit will be displayed in the room temperature display window on the remote controller during test run.</p> <p>5: On some models, "NOT AVAILABLE" may appear on the display when the Vertical Air Direction button is pressed. This is normal.</p> | |

[3] Operating Characteristics and Refrigerant Amount

Clarify relationship between the refrigerant amount and operating characteristics of CITY MULTI new refrigerant series, and perform service activities such as decision and adjustment of refrigerant amount on the market.

1. Operating characteristics and refrigerant amount

The followings are operating characteristics and refrigerant amount which draw special attention.

| | | |
|---|--|---|
| 1 | During cooling operation, the amount of refrigerant in the accumulator is the smallest when all indoor units are in operation. | |
| 2 | During heating operations, liquid level of accumulator is the highest when all the indoor units are operating. | |
| 3 | Tendency of discharge temperature | Discharge temperature is more likely to rise when there is a lack of refrigerant. |
| | | Little change in discharge temperature is seen, even if the refrigerant is increased or decreased while there is refrigerant in the accumulator. |
| | | Discharge temperature is more likely to rise when high-pressure is high. Discharge temperature is more likely to rise when the low temperature is low. |
| 4 | Compressor shell temperature is 10~60K higher than low pressure saturation temperature (Tc) when refrigerant amount is appropriate. → Judged as over replenishment when temperature difference from low pressure saturation temperature (Te) is 5K or less. | |

[4] Adjustment and Judgment of Refrigerant Amount

1. Symptom

The symptoms shown in the table below are the signs of excess or lack of refrigerant amount. Be sure to adjust refrigerant amount in the refrigerant amount adjustment mode, by checking operation status, judging refrigerant amount and performing selfdiagnosis with LED, for overall judgement of excess or lack of refrigerant amount.

| | | |
|---|--|--|
| 1 | Emergency stop at 1500 remote controller display (excessive refrigerant replenishment) | Excessive refrigerant replenishment |
| 2 | Operating frequency does not fully increase, thus resulting in insufficient capacity | Insufficient refrigerant replenishment |
| 3 | Emergency stop at 1102 remote controller display (discharge temperature trouble) | |

2. Refrigerant volume

Checking the operating condition

Operate all the indoor units on cooling or on heating, checking the discharge temperature, sub-cooling, low pressure saturation temperature, inlet temperature, shell bottom temperature, liquid level, liquid step, etc. and rendering an overall judgment.

| Condition | | Judgement |
|-----------|---|---|
| 1 | Discharge temperature is high. (Normal temperature: 95°C or below) | Refrigerant volume tends toward insufficient. |
| 2 | Low pressure is extremely low. | |
| 3 | Inlet superheating is high (if normal, SH = 20K or lower). | |
| 4 | Shell bottom temperature is high (the difference with the low pressure saturation temperature ※1 is 60K or greater) | |
| 5 | Shell bottom temperature is low (the difference with the low pressure saturation temperature ※1 is 5K or higher.) | Refrigerant volume tends toward overcharge. |
| 6 | Inlet super heating is low (if normal, SH = 10K or higher). | |

※1 Low pressure saturation temperature (Low pressure shell compressor)

3. Amount of additional refrigerant to be charged

<PQRY>

The unit is charged with the amount of refrigerant listed in the table below at factory shipment. The refrigerant necessary for extension pipes (on-site piping) is not included and it must be added on site.

| | | | | |
|---|-------|-------|--------|--------|
| Heat source unit model name | P200 | P250 | P400 | P500 |
| The amount of refrigerant that is sealed in | 7.5kg | 8.5kg | 12.0kg | 12.0kg |

Sample calculations

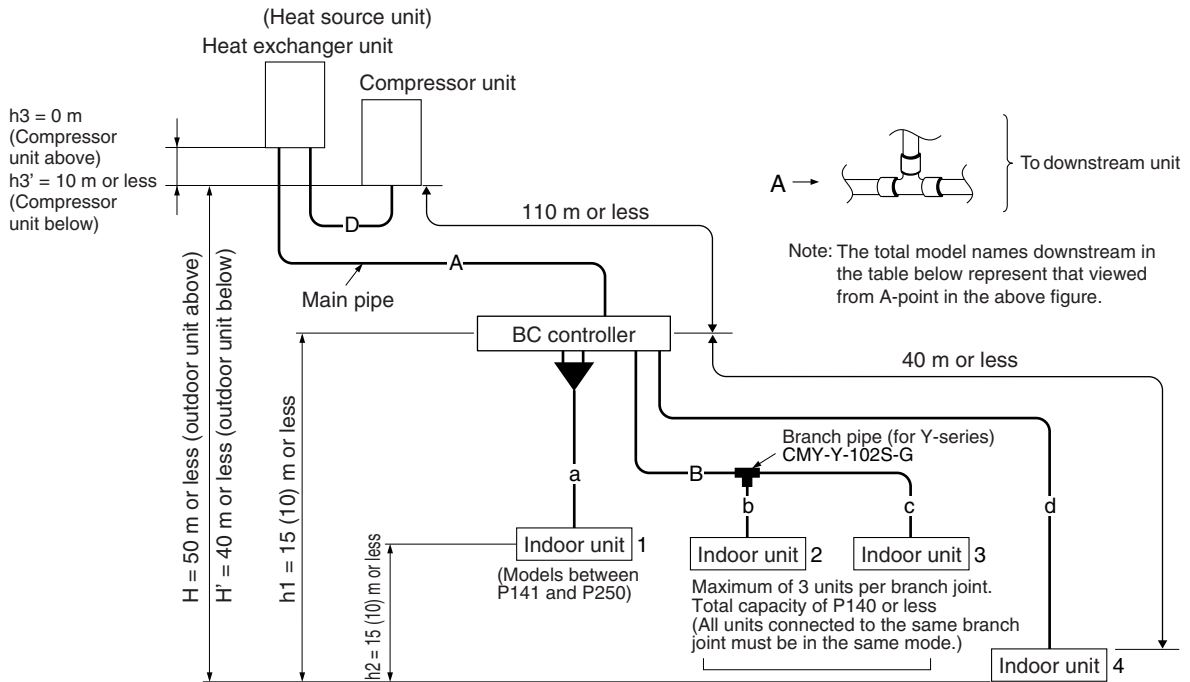

<The amount of additional charge>

| | | | | | | |
|--|--|---|---|---|---|--|
| Size of high-pressure pipe Total length of ϕ 22.2 x 0.23 | + | Size of high-pressure pipe Total length of ϕ 19.05 x 0.16 | + | Size of high-pressure pipe Total length of ϕ 15.88 x 0.11 | + | Size of high-pressure pipe Total length of ϕ 12.7 x 0.12 |
| (m) x 0.23 (kg/m) | | (m) x 0.16 (kg/m) | | (m) x 0.11 (kg/m) | | (m) x 0.12 (kg/m) |
| Size of liquid pipe Total length of ϕ 9.52 x 0.06 | + | Size of liquid pipe Total length of ϕ 6.35 x 0.024 | + | Total capacity of connected indoor units | + | Total number of BC controllers (sub) |
| (m) x 0.06 (kg/m) | | (m) x 0.024 (kg/m) | | ~80 | | 1 unit |
| | | | | 81~160 | | 2 units |
| | | | | 161~330 | | |
| | | | | 331~480 | | |
| | | | | 481~630 | | |
| | | | | 631~710 | | |
| | | | | 711~890 | | |
| | | | | 891~1070 | | |
| Heat source unit type | Amount of refrigerant for heat source unit | | | Amount of refrigerant for indoor units | | Amount of refrigerant for BC controllers (sub) |
| P200~P400 | 0.0kg | | | 1.0kg | | 1.0kg |
| P500 | 2.0kg | | | 1.5kg | | 2.0kg |
| | | | | 2.0kg | | |
| | | | | 2.5kg | | |
| | | | | 3.0kg | | |
| | | | | 4.0kg | | |
| | | | | 5.0kg | | |
| | | | | 6.0kg | | |

<Example>

When { Heat source unit : 250 type
Indoor units 1 : 100 type A : ϕ 19.05 40m a : ϕ 9.52 10 m
2 : 63 type B : ϕ 9.52 10m b : ϕ 9.52 5 m
3 : 32 type D : ϕ 19.05 5m c : ϕ 6.35 10 m
4 : 63 type d : ϕ 9.52 10 m

The total length of each liquid pipe is ϕ 19.05 : A + D = 45 m
 ϕ 9.52 : B + a + b + d = 10 + 10 + 5 + 10 = 35m
 ϕ 6.35 : c = 10m

Therefore
<Sample calculation> The amount of additional charge = 45 x 0.16 + 35 x 0.06 + 10 x 0.024 + 2 = 11.6kg

<PQHY>

The heat source unit is charged with the amount of refrigerant listed in the table below at factory shipment.
The refrigerant necessary for extension pipes (on-site piping) is not included and it must be added on site.

| | | | | |
|---|-------|-------|--------|--------|
| Heat source unit model name | P200 | P250 | P400 | P500 |
| The amount of refrigerant that is sealed in | 7.0kg | 8.0kg | 12.0kg | 12.0kg |

Sample calculations

<In case of P200 or P250 model>

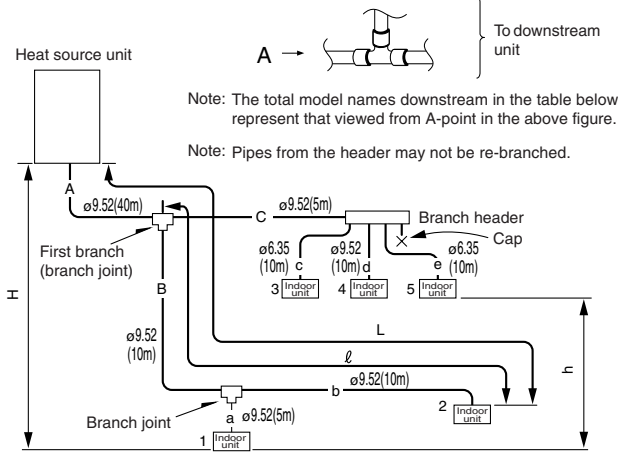

<In case of P400 or P500 model>

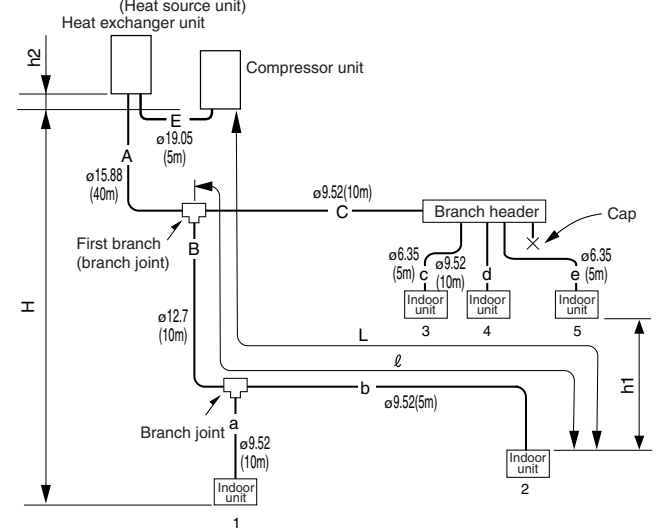

<The amount of additional charge>

| | | | | | | | | |
|--|---|---|--|---|--|--|-----------------------|--|
| Size of liquid pipe Total length of ϕ 19.05 x 0.29 | Size of liquid pipe Total length of ϕ 15.88 x 0.2 | | | | | | | |
| (m) x 0.29 (kg/m) | (m) x 0.2 (kg/m) | + | | | | | | |
| Size of liquid pipe Total length of ϕ 12.7 x 0.12 | Size of liquid pipe Total length of ϕ 9.52 x 0.06 | | Size of liquid pipe Total length of ϕ 6.35 x 0.024 | | | | | |
| (m) x 0.12 (kg/m) | (m) x 0.06(kg/m) | + | (m) x 0.024 (kg/m) | + | | | | |
| | | | | | Total capacity of connected indoor units | Amount of refrigerant for indoor units | | |
| | | | | | ~80 | 1.0kg | | |
| | | | | | 81~160 | 1.5kg | | |
| | | | | | 161~330 | 2.0kg | | |
| | | | | | 331~480 | 2.5kg | | |
| | | | | | 481~630 | 3.0kg | | |
| | | | | | 631~710 | 4.0kg | | |
| | | | | | | | Heat source unit type | Amount of refrigerant for heat source unit |
| | | | | | | | P200~P400 | 0.0kg |
| | | | | | | | P500 | 2.0kg |

<Example:in case of P200 or P250 model>

| | | | | | | |
|------|---|---------------------------|-----------------|-----|-----------------|------|
| When | { | Indoor units 1 : 100 type | A : ϕ 9.52 | 40m | a : ϕ 9.52 | 5 m |
| | | 2 : 63 type | B : ϕ 9.52 | 10m | b : ϕ 9.52 | 10 m |
| | | 3 : 32 type | C : ϕ 9.52 | 5m | c : ϕ 6.35 | 10 m |
| | | 4 : 63 type | | | d : ϕ 9.52 | 10 m |
| | | 5 : 20 type | | | e : ϕ 6.35 | 10 m |

The total length of each liquid pipe is ϕ 9.52 : A + B + C + a + b + d = 40 + 10 + 5 + 5 + 10 + 10 = 80m
 ϕ 6.35 : c + e = 10 + 10 = 20m

Therefore
<Sample calculation> The amount of additional charge = 80 x 0.06 + 20 x 0.024 + 2 = 7.3kg

<Example:in case of P400 or P500 model>

| | | | | | | |
|-------------|---|-----------------------------|------------------|-----|-----------------|------|
| When | { | Heat source unit : 500 type | | | | |
| | | Indoor units 1 : 250 type | A : ϕ 15.88 | 40m | a : ϕ 9.52 | 10 m |
| | | 2 : 100 type | B : ϕ 12.7 | 10m | b : ϕ 9.52 | 5 m |
| | | 3 : 32 type | C : ϕ 9.52 | 10m | c : ϕ 6.35 | 10 m |
| | | 4 : 125 type | | | d : ϕ 9.52 | 10 m |
| 5 : 32 type | | | e : ϕ 6.35 | 5 m | | |

The total length of each liquid pipe is ϕ 19.05 : E = 5m
 ϕ 15.88 : A = 40m
 ϕ 12.7 : B = 10m
 ϕ 9.52 : C + a + b + d = 10 + 10 + 5 + 10 = 35m
 ϕ 6.35 : c + e = 10 + 5 = 15m

Therefore
<Sample calculation> The amount of additional charge = 5 x 0.29 + 40 x 0.2 + 10 x 0.12 + 35 x 0.06 + 15 x 0.024 + 3.0 + 2.0 = 18.2kg

[5] Refrigerant Volume Adjustment Mode Operation

Since the refrigerant volume adjustment introduced in this chapter is just for emergency need, correct adjustment to meet the rated refrigerant volume is difficult. Please judge for adequate volume by following the flow chart later under normal operation mode.

1. Procedure

Depending on the operating conditions, it may be necessary either to charge with supplementary refrigerant, or to drain out some, but if such a case arises, please follow the procedure given below

<PQRY>

(1) Switching the function select switch (SW2-4), located on the heat source unit's control board, ON starts refrigerant volume adjustment mode operation and the following operation occurs

| | |
|-----------|--|
| Operation | <ul style="list-style-type: none"> ① During cooling operation, the indoor unit LEV opening becomes slightly smaller than the usual, and subcool can be easily procured. ② During only cooling operation, balance oil, oil connection and refrigerant collection controls become invalid. ③ During heating only and heating main operation, normal operation is conducted. |
|-----------|--|

Notes: 1. Even if the refrigerant volume has reached a suitable level shortly after starting refrigerant volume adjustment mode, if left for a sufficient length of time (once the refrigeration system has stabilized), there are times when this level may become unsuitable.

1) The refrigerant volume is suitable;

When the subcools (SC11 and SC16) of the BC controller are 5K or more, and when SH of the indoor unit is 5~15K.

2) The current volume is suitable, however, may become unsuitable after a certain length of time;

When the subcools (SC11 and SC16) of the BC controller are 5K or less, or when SH of the indoor unit is 5K or less.

※ In this case, after the subcool of the BC controller reaches 5K or more, and after SH of the indoor unit reaches 5~15K, perform the judgment of the refrigerant adjustment.

※ SC11: BC controller inlet liquid refrigerant subcool

SC16: BC controller outlet liquid refrigerant subcool

2. There are times when it becomes difficult to determine the volume when performing refrigerant adjustments if the high pressure exceeds 2.0MPa.

3. Based on the following flowchart, use TH11 to adjust the refrigerant volume. Use the self-diagnosis switch (SW1) on the outdoor unit main PCB to display TH11, SC11 and SC16.

4. Refrigerant adjustment mode operation will automatically stop in 90 minutes. By turning off and on SW 2-4, the adjustment mode operation can be run again.

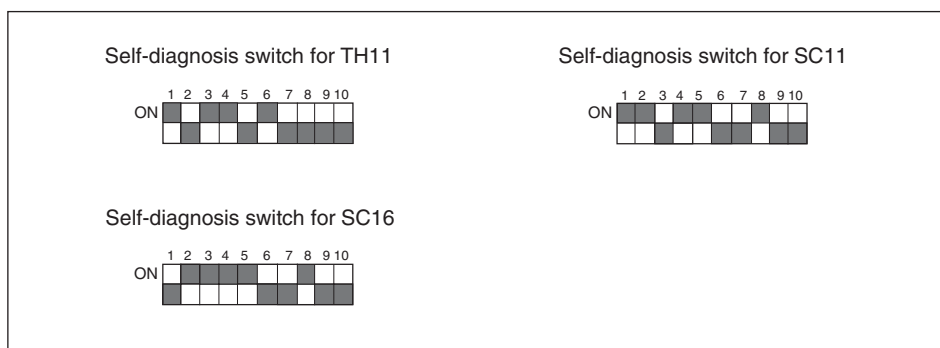

Using these, judge TH11, SC11 and SC16.

[Refrigerant Adjustment Method]

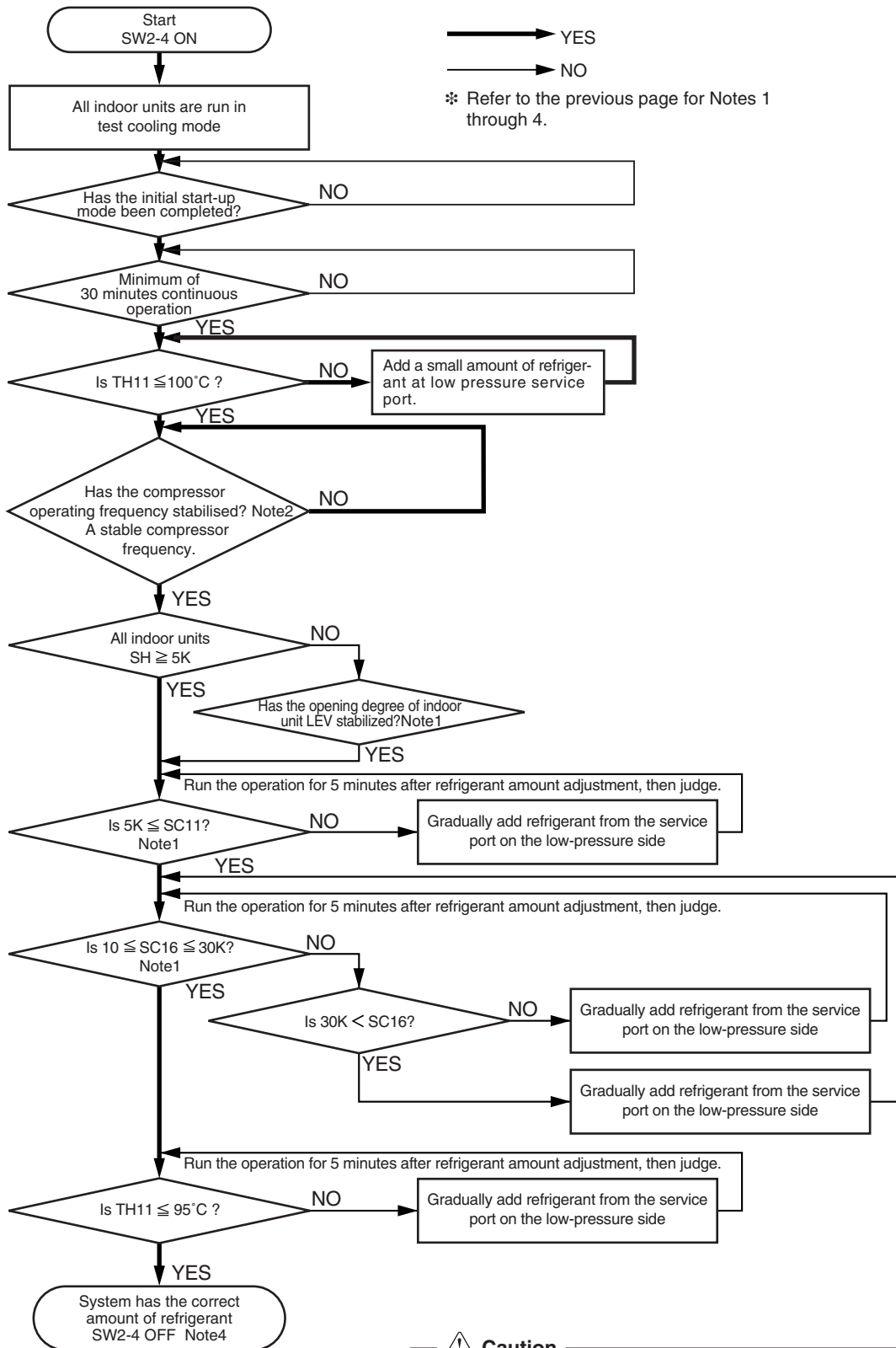

————→ YES

————→ NO

※ Refer to the previous page for Notes 1 through 4.

⚠ **Caution**

Ensure that no refrigerant is released into the atmosphere.

⚠ **Caution**

USE liquid refrigerant to fill the system.

- If gas refrigerant is used to seal the system, the composition of the refrigerant in the cylinder will change and performance may drop.

<PQHY>

(1) Switching the function select switch (SW2-4), located on the outdoor unit's control board, ON starts refrigerant volume adjustment mode operation and the following operation occurs

| | |
|-----------|--|
| Operation | The heat source unit LEV1 diverges more than usual during cooling operation. |
|-----------|--|

- Notes:
1. Even if the refrigerant volume has reached a suitable level shortly after starting refrigerant volume adjustment mode, if left for a sufficient length of time (once the refrigeration system has stabilized), there are times when this level may become unsuitable.
 - 1) The refrigerant volume is suitable;
When the refrigerant volume for TH5 - TH7 is more than 5K at the heat source unit, and 5 to 15K for SH at the indoor unit.
 - 2) The current volume is suitable, however, may become unsuitable after a certain length of time;
When the refrigerant volume for TH5 - TH7 is less than 5K at the heat source unit, or less than 5K for SH at the indoor unit.
 2. There are times when it becomes difficult to determine the volume when performing refrigerant adjustments if the high pressure exceeds 2.0MPa.
 3. Based on the following flowchart, use TH11, TH5, TH7 and Tc to adjust the refrigerant volume. Use the self-diagnosis switch (SW1) on the heat source unit main PCB to display TH11, TH5, TH7 and Tc.
 4. Refrigerant adjustment mode operation will automatically stop in 90 minutes. By turning off and on SW 2-4, the adjustment mode operation can be run again.

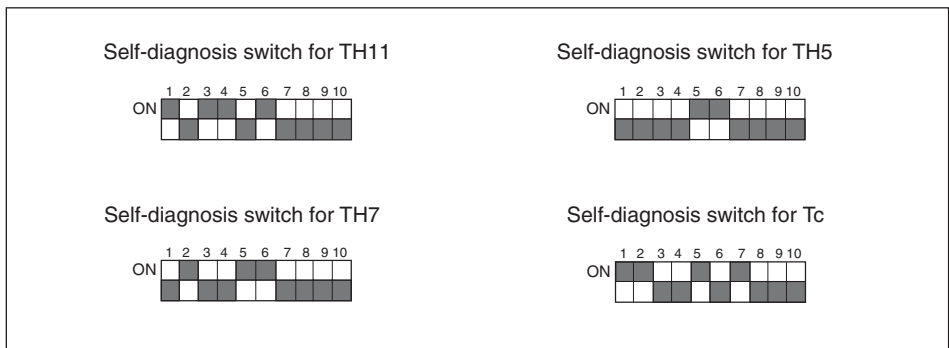

Using these, judge TH11, Tc - TH5 and Tc - TH7.

[Refrigerant Adjustment Method]

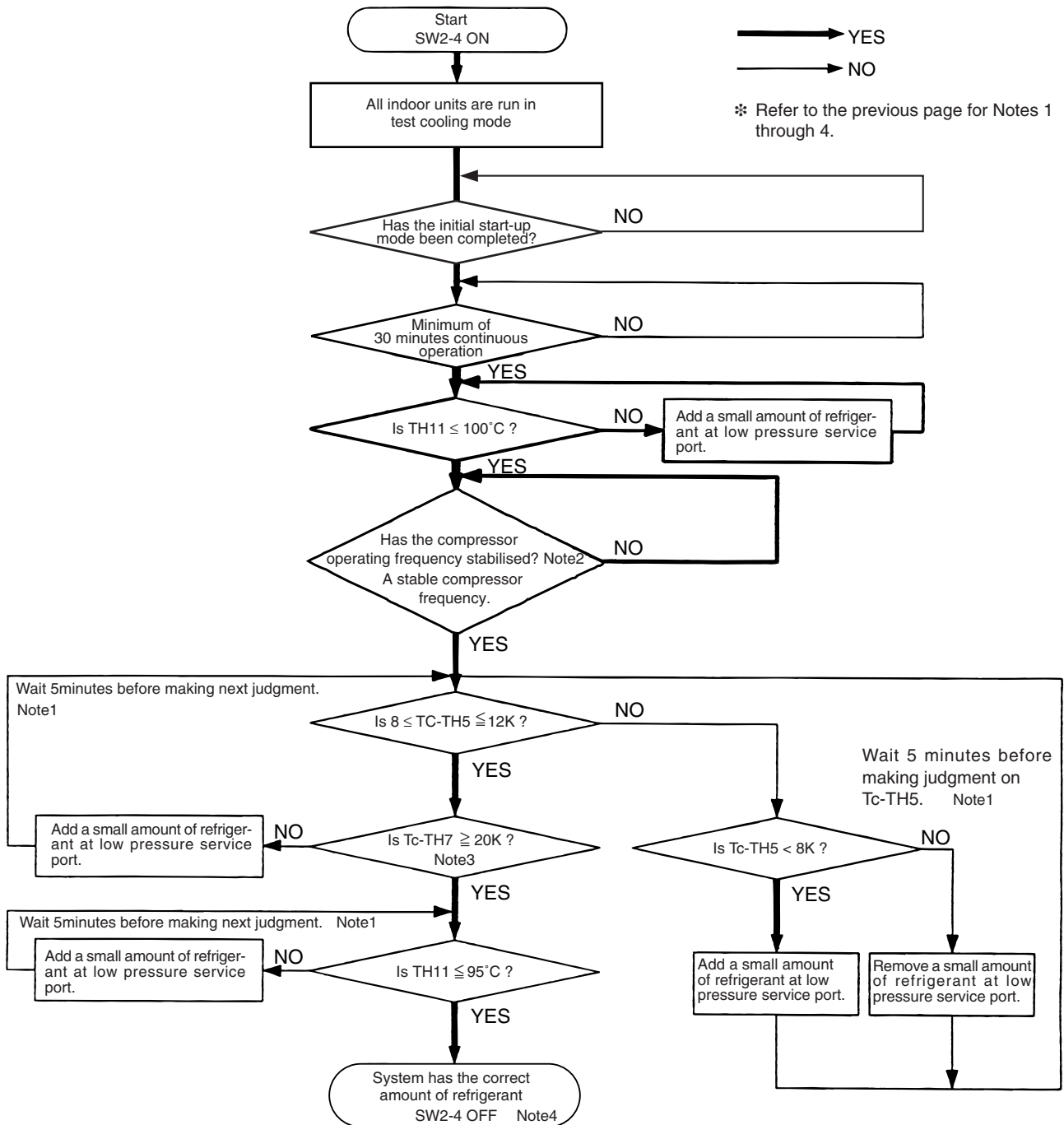

⚠ Caution

Ensure that no refrigerant is released into the atmosphere.

⚠ Caution

Use liquid refrigerant to fill the system.

- If gas refrigerant is used to seal the system, the composition of the refrigerant in the cylinder will change and performance may drop.

[6] Symptoms that do not Signify Problems

| Symptom | Remote controller display | Cause |
|---|--|---|
| Indoor unit does not run while operating for cooling (heating). | "COOL (HEAT)" blinking display | Unable to execute cooling (heating) operation while other indoor unit is under cooling (heating) operation. |
| Auto-vane runs freely. | Normal display | Because of the control action of the auto-vane, horizontal blow may be commenced automatically one hour after using for down blow in cooling. Horizontal blow will also be commenced at defrosting under heating, at the time of the hot adjust and the thermostat off. |
| Air speed setting switches over freely during heating operation. | Normal display | Very low speed operation is commenced at thermostat OFF. At thermostat ON, the very low speed operation automatically changes over to the set value by the time or piping temperature. |
| Fan does not stop while stopping operation. | Extinguished | When the auxiliary heater is turned on, fan operates for one minute after stopping to remove residual heat. |
| Air speed does not attain the set value even though turning operation switch to "ON." | Preparing heating | Very low speed for 5 minutes after SW "ON" or until the piping temperature reaches 35°C. Thereafter, the set value is commenced after low speed for 2 minutes. (Hot adjust control) |
| The display shown right will appear on the indoor unit remote controller for about 5 minutes when the main power source is turned on. | "PLEASE WAIT" ("HO") blinking display | The system is under starting up. Operate the remote controller after the blinking of "PLEASE WAIT" ("HO") is disappeared. |
| Drain pump does not stop while the operation is stopped. | Extinguished | At stopping of cooling operation, drain pump operates for 3 minutes further. |
| Drain pump runs even during unit stopping. | | Run drain pump if drain water is generated even under stopping. |
| Indoor unit and BC controller make noise during cooling/heating changeover. | Normal display | This noise is made when the refrigerant circuit is reversed and is normal. |
| Sound of the refrigerant flow is heard from the indoor unit immediately after starting operation. | Normal display | This is caused by the transient instability of the refrigerant flow and is normal. |

[7] Standard Operation Data (Reference Data)

1. Cooling operation [Standard type]

| Heat source unit model BC controller model | | – | PQRY-P200YGM-A CMB-P104V-G | | | | PQRY-P250YGM-A CMB-P104V-G | | | | PQRY-P400YSGM-A CMB-P108V-GA | | | | PQRY-P500YSGM-A CMB-P108V-GA | | | | |
|---|-------------------------------------|------------------------------|-------------------------------|-----|-----|------|-------------------------------|-----|------|------|---------------------------------|------|------|------|---------------------------------|-----|-----|-----|-----|
| Conditions | Power supply | V/Hz | 200/60 | | | | 200/60 | | | | 200/60 | | | | 200/60 | | | | |
| | Indoor temperature | °C DB/WB | 27.0/19.0 | | | | 27.0/19.0 | | | | 27.0/19.0 | | | | 27.0/19.0 | | | | |
| | Heat source water temperature | °C | 30.0 | | | | 30.0 | | | | 30.0 | | | | 30.0 | | | | |
| | Heat source water volume | m³/h | 4.56 | | | | 5.76 | | | | 9.12 | | | | 11.52 | | | | |
| | Indoor unit | Number of units | Units | 4 | | | | 4 | | | | 4 | | | | 4 | | | |
| | | Number of units in operation | | 4 | | | | 4 | | | | 4 | | | | 4 | | | |
| | | Unit model | | – | 71 | 63 | 50 | 20 | 100 | 71 | 63 | 20 | 200 | 100 | 63 | 32 | 250 | 125 | 100 |
| | Piping | Main piping | m | 5 | | | | 5 | | | | 5 | | | | 5 | | | |
| | | Branch piping | | 10 | 10 | 10 | 10 | 10 | 10 | 10 | 10 | 10 | 10 | 10 | 10 | 10 | 10 | 10 | 10 |
| | | Total piping length | | 45 | | | | 45 | | | | 45 | | | | 45 | | | |
| Indoor unit fan speed setting | – | Hi | Hi | Hi | Hi | Hi | Hi | Hi | Hi | Hi | Hi | Hi | Hi | Hi | Hi | Hi | Hi | | |
| Refrigerant amount | kg | 11.8 | | | | 13.4 | | | | 17.7 | | | | 20.2 | | | | | |
| Heat source unit | Total current | A | 8.0/7.4 | | | | 10.0/9.1 | | | | 19.1/17.5 | | | | 25.4/23.3 | | | | |
| | Voltage | V | 380/415 | | | | 380/415 | | | | 380/415 | | | | 380/415 | | | | |
| | Compressor frequency | | 52 | | | | 62 | | | | 100 | | | | 120 | | | | |
| LEV opening | Indoor unit | Pulse | 253 | 441 | 362 | 187 | 325 | 253 | 441 | 187 | 324 | 325 | 441 | 261 | 388 | 387 | 325 | 261 | |
| | BC controller (1/2/3) | | 2000 | – | 130 | 2000 | – | 135 | 2000 | 2000 | 180 | 2000 | 2000 | 200 | | | | | |
| Pressure | High pressure/low pressure | MPa | 2.65/0.93 | | | | 2.66/.093 | | | | 2.69/0.94 | | | | 2.69/0.94 | | | | |
| | BC controller liquid side/mid point | | 2.51/2.51 | | | | 2.53/2.53 | | | | 2.56/2.56 | | | | 2.56/2.56 | | | | |
| Misc. Temperatures | Heat source unit | °C | 80 | | | | 82 | | | | 86 | | | | 91 | | | | |
| | | | 14 | | | | 14 | | | | 16 | | | | 15 | | | | |
| | | | 14 | | | | 14 | | | | 16 | | | | 15 | | | | |
| | | | 20 | | | | 20 | | | | 23 | | | | 21 | | | | |
| | | | 37 | | | | 40 | | | | 48 | | | | 37 | | | | |
| | Indoor unit | LEV inlet | 19 | | | | 19 | | | | 26 | | | | 24 | | | | |
| | | Heat exchanger inlet | 13 | | | | 13 | | | | 15 | | | | 13 | | | | |

| | | | | | | | | | | | | | | | | | | | |
|-------------------------------|-------------------------------|------------------------------|----------------|-----|-----|------|----------------|-----|-----|------|-----------------|-----|-----|------|-----------------|-----|-----|-----|----|
| Heat source unit model | | – | PQHY-P200YGM-A | | | | PQHY-P250YGM-A | | | | PQHY-P400YSGM-A | | | | PQHY-P500YSGM-A | | | | |
| Conditions | Power supply | V/Hz | 200/60 | | | | 200/60 | | | | 200/60 | | | | 200/60 | | | | |
| | Indoor temperature | °C DB/WB | 27.0/19.0 | | | | 27.0/19.0 | | | | 27.0/19.0 | | | | 27.0/19.0 | | | | |
| | Heat source water temperature | °C | 30.0 | | | | 30.0 | | | | 30.0 | | | | 30.0 | | | | |
| | Heat source water volume | m³/h | 4.56 | | | | 5.76 | | | | 9.12 | | | | 11.52 | | | | |
| | Indoor unit | Number of units | Units | 4 | | | | 4 | | | | 4 | | | | 4 | | | |
| | | Number of units in operation | | 4 | | | | 4 | | | | 4 | | | | 4 | | | |
| | | Unit model | – | 71 | 63 | 50 | 20 | 100 | 71 | 63 | 20 | 200 | 100 | 63 | 32 | 250 | 125 | 100 | 32 |
| | Piping | Main piping | m | 5 | | | | 5 | | | | 5 | | | | 5 | | | |
| | | Branch piping | | 10 | 10 | 10 | 10 | 10 | 10 | 10 | 10 | 10 | 10 | 10 | 10 | 10 | 10 | 10 | 10 |
| | | Total piping length | | 45 | | | | 45 | | | | 45 | | | | 45 | | | |
| Indoor unit fan speed setting | – | Hi | Hi | Hi | Hi | Hi | Hi | Hi | Hi | Hi | Hi | Hi | Hi | Hi | Hi | Hi | Hi | | |
| Refrigerant amount | kg | 11.0 | | | | 12.4 | | | | 17.2 | | | | 20.0 | | | | | |
| Heat source unit | Total current | A | 8.0/7.4 | | | | 10.0/9.1 | | | | 19.1/17.5 | | | | 25.4/23.3 | | | | |
| | Voltage | V | 380/415 | | | | 380/415 | | | | 380/415 | | | | 380/415 | | | | |
| | Compressor frequency | | 52 | | | | 62 | | | | 100 | | | | 120 | | | | |
| LEV opening | Indoor unit | Pulse | 253 | 441 | 362 | 187 | 325 | 253 | 441 | 187 | 324 | 325 | 441 | 261 | 388 | 387 | 325 | 261 | |
| | High pressure/low pressure | MPa | 2.65/0.93 | | | | 2.66/.093 | | | | 2.69/0.94 | | | | 2.69/0.94 | | | | |
| Misc. Temperatures | Heat source unit | Discharge (TH11) | 80 | | | | 82 | | | | 86 | | | | 91 | | | | |
| | | Accumulator inlet | 14 | | | | 14 | | | | 16 | | | | 15 | | | | |
| | | Accumulator outlet | 14 | | | | 14 | | | | 16 | | | | 15 | | | | |
| | | Suction | 20 | | | | 20 | | | | 23 | | | | 21 | | | | |
| | | Shell bottom | 37 | | | | 40 | | | | 48 | | | | 37 | | | | |
| | Indoor unit | LEV inlet | 19 | | | | 19 | | | | 26 | | | | 24 | | | | |
| | | Heat exchanger inlet | 13 | | | | 13 | | | | 15 | | | | 13 | | | | |

2. Heating operation

| Heat source unit model | | – | PQRY-P200YGM-A CMB-P104V-G | | | | PQRY-P250YGM-A CMB-P104V-G | | | | PQRY-P400YSGM-A CMB-P108V-GA | | | | PQRY-P500YSGM-A CMB-P108V-GA | | | | | | | |
|------------------------|-------------------------------------|------------------------------|-------------------------------|-----|-----|------|-------------------------------|-----|-----|------|---------------------------------|-----|-----|------|---------------------------------|-----|-----|-----|-----|----|--|--|
| Conditions | Indoor temperature | °C DB/WB | 20.0/– | | | | 20.0/– | | | | 20.0/– | | | | 20.0/– | | | | | | | |
| | Heat source water temperature | °C | 20.0 | | | | 20.0 | | | | 20.0 | | | | 20.0 | | | | | | | |
| | Heat source water volume | m³/h | 4.56 | | | | 5.76 | | | | 9.12 | | | | 11.52 | | | | | | | |
| | Indoor unit | Number of units | Units | 4 | | | | 4 | | | | 4 | | | | 4 | | | | | | |
| | | Number of units in operation | | 4 | | | | 4 | | | | 4 | | | | 4 | | | | | | |
| | | Unit model | | – | 71 | 63 | 50 | 20 | 100 | 71 | 63 | 20 | 200 | 100 | 63 | 32 | 250 | 125 | 100 | 32 | | |
| | Piping | Main piping | m | 5 | | | | 5 | | | | 5 | | | | 5 | | | | | | |
| | | Branch piping | | 10 | 10 | 10 | 10 | 10 | 10 | 10 | 10 | 10 | 10 | 10 | 10 | 10 | 10 | 10 | 10 | | | |
| | | Total piping length | | 45 | | | | 45 | | | | 45 | | | | 45 | | | | | | |
| | Indoor unit fan speed setting | – | Hi | Hi | Hi | Hi | Hi | Hi | Hi | Hi | Hi | Hi | Hi | Hi | Hi | Hi | Hi | Hi | | | | |
| Refrigerant amount | kg | 11.8 | | | | 13.4 | | | | 17.7 | | | | 20.2 | | | | | | | | |
| Heat source unit | Total current | A | 7.9/7.2 | | | | 9.7/8.9 | | | | 18.5/17.0 | | | | 22.9/21.0 | | | | | | | |
| | Voltage | V | 385/415 | | | | 385/415 | | | | 385/415 | | | | 385/415 | | | | | | | |
| | Compressor frequency | | 51 | | | | 60 | | | | 95 | | | | 110 | | | | | | | |
| LEV opening | Indoor unit | Pulse | 450 | 695 | 555 | 310 | 555 | 450 | 695 | 310 | 555 | 555 | 695 | 345 | 597 | 597 | 555 | 345 | | | | |
| | BC controller (1/2/3) | | 110 | – | 520 | 110 | – | 590 | 110 | 110 | 800 | 110 | 110 | 980 | | | | | | | | |
| Pressure | High pressure/low pressure | MPa | 2.82/0.80 | | | | 2.71/0.80 | | | | 2.78/0.80 | | | | 2.82/0.80 | | | | | | | |
| | BC controller liquid side/mid point | | 2.72/2.72 | | | | 2.61/2.61 | | | | 2.35/2.35 | | | | 2.76/2.76 | | | | | | | |
| Misc. Temperatures | Heat source unit | °C | Discharge (TH11) | | | | 72 | | | | 73 | | | | 71 | | | | 76 | | | |
| | | | Accumulator inlet | | | | 0 | | | | –1 | | | | 0 | | | | 1 | | | |
| | | | Accumulator outlet | | | | 0 | | | | –1 | | | | 0 | | | | 1 | | | |
| | | | Suction | | | | 12 | | | | 0 | | | | –1 | | | | 1 | | | |
| | | | Shell bottom | | | | 25 | | | | 25 | | | | 30 | | | | 24 | | | |
| | Indoor unit | LEV inlet | | | | 38 | | | | 35 | | | | 31 | | | | 39 | | | | |
| | | Heat exchanger inlet | | | | 60 | | | | 60 | | | | 60 | | | | 62 | | | | |

| | | | | | | | | | | | | | | | | | | | |
|------------------------|-------------------------------|------------------------------|------------------|-----|-----|------|----------------|-----|-----|------|-----------------|-----|-----|------|-----------------|-----|-----|-----|-----|
| Heat source unit model | | – | PQHY-P200YGM-A | | | | PQHY-P250YGM-A | | | | PQHY-P400YSGM-A | | | | PQHY-P500YSGM-A | | | | |
| Conditions | Indoor temperature | °C DB/WB | 20.0/– | | | | 20.0/– | | | | 20.0/– | | | | 20.0/– | | | | |
| | Heat source water temperature | °C | 20.0 | | | | 20.0 | | | | 20.0 | | | | 20.0 | | | | |
| | Heat source water volume | m ³ /h | 4.56 | | | | 5.76 | | | | 9.12 | | | | 11.52 | | | | |
| | Indoor unit | Number of units | Units | 4 | | | | 4 | | | | 4 | | | | 4 | | | |
| | | Number of units in operation | | 4 | | | | 4 | | | | 4 | | | | 4 | | | |
| | | Unit model | | – | 71 | 63 | 50 | 20 | 100 | 71 | 63 | 20 | 200 | 100 | 63 | 32 | 250 | 125 | 100 |
| | Piping | Main piping | m | 5 | | | | 5 | | | | 5 | | | | 5 | | | |
| | | Branch piping | | 10 | 10 | 10 | 10 | 10 | 10 | 10 | 10 | 10 | 10 | 10 | 10 | 10 | 10 | 10 | 10 |
| | | Total piping length | | 45 | | | | 45 | | | | 45 | | | | 45 | | | |
| | Indoor unit fan speed setting | – | Hi | Hi | Hi | Hi | Hi | Hi | Hi | Hi | Hi | Hi | Hi | Hi | Hi | Hi | Hi | Hi | |
| Refrigerant amount | kg | 11.0 | | | | 12.4 | | | | 17.2 | | | | 20.0 | | | | | |
| Heat source unit | Total current | A | 7.9/7.2 | | | | 9.7/8.9 | | | | 18.5/17.0 | | | | 22.9/21.0 | | | | |
| | Voltage | V | 385/415 | | | | 385/415 | | | | 385/415 | | | | 385/415 | | | | |
| | Compressor frequency | | 51 | | | | 60 | | | | 95 | | | | 110 | | | | |
| LEV opening | Indoor unit | Pulse | 450 | 695 | 555 | 310 | 555 | 450 | 695 | 310 | 555 | 555 | 695 | 345 | 597 | 597 | 555 | 345 | |
| Pressure | High pressure/low pressure | MPa | 2.82/0.80 | | | | 2.71/0.80 | | | | 2.78/0.80 | | | | 2.82/0.80 | | | | |
| | Misc. Temperatures | Heat source unit | Discharge (TH11) | 72 | | | | 73 | | | | 71 | | | | 76 | | | |
| Accumulator inlet | | | 0 | | | | –1 | | | | 0 | | | | 1 | | | | |
| Accumulator outlet | | | 0 | | | | –1 | | | | 0 | | | | 1 | | | | |
| Suction | | | 12 | | | | 0 | | | | –1 | | | | 1 | | | | |
| Shell bottom | | | 25 | | | | 25 | | | | 30 | | | | 24 | | | | |
| Indoor unit | | LEV inlet | 38 | | | | 35 | | | | 31 | | | | 39 | | | | |
| | | Heat exchanger inlet | 60 | | | | 60 | | | | 60 | | | | 62 | | | | |

9 Troubleshooting

[1] Check Code List

1. Error Code and Preliminary Error Code List

| Error code | Preliminary error code | Error (preliminary) Detail Code | Error code definition | Applicable unit | | | | | Notes |
|--|--|---------------------------------|--|------------------------------------|-------------|---------------|--------------|-------------------|-------------------------|
| | | | | Heat source unit | Indoor unit | BC controller | LOSSNAY unit | Remote controller | |
| 0403 | 4300 | 01 | Serial communication error | ○ | | | | | |
| 0900 | – | – | Test run mode | | | | ○ | | |
| 1102 | 1202 | – | Abnormal discharge air temperature | ○ | | | | | |
| 1301 | – | – | Abnormal low pressure | ○ | | | | | |
| 1302 | 1402 | – | Abnormal high pressure | ○ | | | | | |
| 1500 | 1600 | – | Excessive or insufficient refrigerant charge | ○ | | | | | |
| – | 1605 | – | Preliminary vacuum operation protection | ○ | | | | | |
| 2000 | 2100 | – | Pump interlock error | ○ | | | | | Water-cooling unit only |
| 2134 | 2234 | – | Abnormal water temperature | ○ | | | | | Water-cooling unit only |
| 2135 | 2235 | – | Water-source heat exchanger freezing | ○ | | | | | Water-cooling unit only |
| 2500 | – | – | Water leakage | | ○ | | | | |
| 2502 | – | – | Drain pump error/float switch trip | | ○ | ○ | | | |
| 2503 | – | – | Drain sensor failure/float switch trip | | ○ | | ○ | | |
| 2600 | – | – | Water leakage | | | | ○ | | |
| 2601 | – | – | Water supply cutoff | | | | ○ | | |
| 4103 | – | – | Reverse phase/open phase | ○ | | | | | |
| 4115 | – | – | Power supply sync signal abnormality | ○ | | | | | |
| 4116 | – | – | RPM error/motor malfunction | | ○ | | ○ | | |
| 4220 | 4320 | [108] | Bus voltage drop (S/W detection) | ○ | | | | | |
| | | [109] | Bus voltage rise (S/W detection) | ○ | | | | | |
| | | [110] | Bus voltage abnormality (H/W detection) | ○ | | | | | |
| | | [111] | Logic error | ○ | | | | | |
| 4230 | 4330 | – | Heatsink overheat protection | ○ | | | | | |
| 4240 | 4340 | – | Overload protection | ○ | | | | | |
| 4250 | 4350 | [101] | IPM error | ○ | | | | | |
| | | [102] | ACCT overcurrent breaker trip (H/W detection) | ○ | | | | | |
| | | [103] | DCCT overcurrent breaker trip (H/W detection) | ○ | | | | | |
| | | [104] | IPM short/grounding error | ○ | | | | | |
| | | [105] | Loaded short-circuit | ○ | | | | | |
| | | [106] | Instantaneous overcurrent breaker trip (S/W detection) | ○ | | | | | |
| [107] | Effective value overcurrent breaker trip (S/W detection) | ○ | | | | | | | |
| 4260 | 4360 (No history) | – | Cooling fan abnormality | ○ | | | | | |
| 5101 | 1202 | – | Temperature sensor failure | Indoor unit air inlet (TH21) | | ○ | | | |
| | | | | OA processing unit air inlet (TH4) | | | | ○ | |
| Outdoor unit (Heat source unit) discharge (TH11) | ○ | | | | | | | | |
| Indoor unit piping (TH22) | | ○ | | | | | | | |
| OA processing unit piping (TH2) | | | | | ○ | | | | |
| Indoor unit gas-side piping (TH23) | | ○ | | | | | | | |
| OA processing unit gas-side piping (TH3) | | | | | ○ | | | | |
| OA processing unit outside air (TH1) | | | | | ○ | | | | |
| Outside air temperature (TH24) | | | | ○ | | | | | |
| Piping (TH5) | ○ | | | | | | WY only | | |
| Water piping (TH6) | ○ | | | | | | | | |
| Liquid temperature (TH7) | ○ | | | | | WY only | | | |
| SC coil outlet (TH8) | ○ | | | | | WY only | | | |

| Error code | Preliminary error code | Error (preliminary) Detail Code | Error code definition | Applicable unit | | | | | Notes | |
|------------|------------------------|---------------------------------|---|---|-------------|---------------|--------------|-------------------|-------|-------------------------|
| | | | | Heat source unit | Indoor unit | BC controller | LOSSNAY unit | Remote controller | | |
| 5109 | 1218 | - | Temperature sensor failure | Water piping (TH9) | ○ | | | | | Water-cooling unit only |
| 5112 | 1215 | - | | Inverter cooling heat exchanger (THINV) | ○ | | | | | Water-cooling unit only |
| 5110 | 1214 | 01 | | Heatsink (THHS) | ○ | | | | | |
| 5111 | - | - | Temperature sensor failure (BC controller) | BC controller liquid inlet (TH11) | | ○ | | | | |
| 5112 | - | - | | Bypass outlet (TH12) | | ○ | | | | |
| 5115 | - | - | | Bypass inlet (TH15) | | ○ | | | | |
| 5116 | - | - | | Mid point (TH16) | | ○ | | | | |
| 5201 | 1402 | - | High pressure sensor error (Heat source HPS)/BC controller 63HS | | ○ | | ○ | | | |
| 5203 | - | - | BC controller mid-point pressure sensor (63HS3) | | | | ○ | | | |
| 5301 | 4300 | [115] | ACCT sensor failure | | ○ | | | | | |
| | | [116] | DCCT sensor failure | | ○ | | | | | |
| | | [117] | ACCT sensor circuit failure | | ○ | | | | | |
| | | [118] | DCCT sensor circuit failure | | ○ | | | | | |
| | | [119] | IPM open/Disconnected ACCT connector | | ○ | | | | | |
| | | [120] | ACCT faulty wiring detection | | ○ | | | | | |
| 6600 | - | - | Address overlaps | | ○ | ○ | ○ | ○ | ○ | |
| 6602 | - | - | Transmission processor H/W error | | ○ | ○ | ○ | ○ | ○ | |
| 6603 | - | - | Transmission Bus-Busy | | ○ | ○ | ○ | ○ | ○ | |
| 6606 | - | - | Communication error with the transmission processor | | ○ | ○ | ○ | ○ | ○ | |
| 6607 | - | - | No acknowledgment | | ○ | ○ | ○ | ○ | ○ | |
| 6608 | - | - | No response | | ○ | ○ | ○ | ○ | ○ | |
| 6831 | - | - | MA communication receipt error (no receipt) | | | ○ | | | ○ | |
| 6832 | - | - | MA communication receipt error (synchronization error) | | | ○ | | | ○ | |
| 6833 | - | - | MA communication transmission/receipt error (H/W error) | | | ○ | | | ○ | |
| 6834 | - | - | MA communication transmission/receipt error (Start bit detection error) | | | ○ | | | ○ | |
| 7100 | - | - | Total capacity error | | ○ | | | | | |
| 7101 | - | - | Capacity code error | | ○ | ○ | | ○ | | |
| 7102 | - | - | Exceeding the number of connectable units | | ○ | | ○ | | | |
| 7105 | - | - | Address setting error | | ○ | | | | | |
| 7106 | - | - | Attribute setting error | | | | | ○ | | |
| 7107 | - | - | Port setting error | | | | ○ | | | BC only |
| 7110 | - | - | Connection information setting error | | ○ | | | | | |
| 7111 | - | - | Remote controller sensor failure | | | ○ | | ○ | | |
| 7113 | - | - | Function setting error | | ○ | | | | | |
| 7116 | - | - | Replace Multi setting error | | ○ | | | | | |
| 7117 | - | - | Model type setting error | | ○ | | | | | |
| 7130 | - | - | Incompatible units | | ○ | | | | | |

[2] Responding to Error Display on the Remote Controller

1. Mechanical problems

| Checking code | | Meaning, detecting method | Cause | Checking method & Countermeasure |
|---------------|--|---|---|---|
| 0403 | Serial transmission abnormality | Serial transmission failure between the main board and the INV board, and between the main board. Detail code 01: Between the main board and the INV board | (1) Defective wiring. | Check for wiring between the main board connector CNRS3B and the INV board connector CNRS1 or check for contact the connector. |
| | | | (2) Inverter address switches are set wrong. | Check the address of SW2-1 on the INV board. |
| | | | (3) Defective INV board. | Replace the INV board when the power turns on automatically, even if the power is reset. |
| 1102 | Discharge temperature abnormality (Heat source unit) | <p>1. When 120°C or more discharge temperature is detected during operations (the first time), heat source unit stops once, mode is changed to restart mode after 3 minutes, then the heat source unit restarts.</p> <p>2. When 120 °C or higher discharge is detected again (the second time) within 30 minutes after the first stop of heat source unit, mode is changed to restart mode after 3 minutes, then the heat source unit restarts.</p> <p>3. When 120°C or more discharge is detected, again (the third time) within 30 minutes after previous stop of heat source unit, emergency stop is observed with code No.“1102” displayed.</p> <p>4. When 120°C or more discharge is detected 30 or more minutes after previous stop of heat source unit, the stop is regarded as the first time and the process shown in 1. is observed.</p> <p>5. 30 minutes after stop of heat source unit is intermittent fault check period with LED displayed.</p> | (1) Gas leak, gas shortage. | See Refrigerant amount check. |
| | | | (2) Overload operations. | Check operating conditions and operation status of indoor/heat source units. |
| | | | (3) Poor operations of indoor LEV. (4) Poor operations of BC controller LEV. Cooling-only → LEV3 Cooling-main → LEV1,2 and 3 Heating-only or heating-main → LEV3 | Check operation status by actually performing cooling or heating operations. Cooling : Indoor LEV (Cooling-only) LEV1,2,3(BC) SVM1,2(BC) SVA(BC) LEV1 (PQHY·OC) |
| | | | (5) Poor operations of the BC controller SVM1 and 2 → Cooling-only | Heating : Indoor LEV (Heating-only) LEV3(BC) SVB(BC) SV4a~4d SV5a,5b |
| | | | (6) Poor operations of the OC controller LEV1 (PQHY) | |
| | | | (7) Poor operations of the BC controller SVA → Cooling-only/Cooling-main | See Trouble check of LEV and solenoid valve. |
| | | | (8) Poor operations of the BC controller SVB → Heating-only/Heating-main | |
| | | | (9) Poor operations of the solenoid valve SV (4a~4d (P200~P250type), 4a~4d, 5a, 5b (P400~P500type)) → Heating-only/Heating-main | |
| | | | (10) Branch port address setting error.(PQRY) | Check the branch port address of the indoor unit. |
| | | | (11) Poor operations of ball valve. | Confirm that ball valve is fully opened. |
| | | | (12) Insufficient heat source water volume, heat source water cutoff, dirty or clogged water-source heat exchanger → Heating only/Heating main { (3) ~ (11) are caused by discharge temperature rise due to low pressure drop. } | Check the water-source heat exchanger for clogging. Check the circulation water pump on heat source unit. |

※ For the check code on the inverter, refer to “ 7. Inverter and compressor ” in the section [4] “ Troubleshooting of principal parts ”

| Checking code | | Meaning, detecting method | Cause | Checking method & Countermeasure |
|---------------|--|---|---|--|
| 1102 | Discharge temperature abnormality (Heat source unit) | | (13) Gas leak between low and high pressures. { 4-way valve trouble, compressor trouble, solenoid valve SV1 trouble. } | Check operation status of cooling-only or heating-only. |
| | | | (14) Thermistor trouble (TH11). | Check resistance of thermistor. |
| | | | (15) Thermistor input circuit trouble on control circuit board. | Check inlet temperature of sensor with LED monitor. |
| 1301 | Low pressure abnormality | When starting the compressor from Stop Mode for the first time (include the time when starting the compressor for the next time, when starting bound power, ending bound power or when the thermo turns off just after the remote controller is turned on), check the low-pressure sensor beforehand. If the sensor is 0.098MPa, stop the operation immediately after starting. | (1) Internal pressure is dropping due to a gas leak. (2) The low pressure pressure sensor is defective. (3) Insulation is torn. (4) A pin is missing in the connector, or there is faulty contact. (5) A wire is disconnected. (6) The control board's low pressure pressure sensor input circuit is defective. | Refer to the item on judging low pressure pressure sensor failure. |
| 1302 | High pressure abnormality 1 (Heat source unit) | <p>1. When pressure sensor detects 3.87MPa or more during operations (the first time), heat source unit stops once, mode is changed to restart mode after 3 minutes, then the heat source unit restarts.</p> <p>2. When a pressure of 3.87MPa or more is detected again (the second time) within 30 minutes after first stop of heat source unit, mode is changed to restart mode after 3 minutes, then the heat source unit restarts.</p> <p>3. When 3.87MPa or more pressure is detected again (the third time) within 30 minutes after stop of heat source unit, error stop is observed with code No. "1302" displayed.</p> <p>4. When 3.87MPa or more pressure is detected 30 or more minutes after stop of heat source unit, the detection is regarded as the first time and the process shown in 1. is observed.</p> <p>5. 30 minutes after stop of heat source unit is intermittent fault check period with LED displayed.</p> <p>6. Error stop is observed immediately when pressure switch (4.15⁺⁰_{-1.5} MPa) operates in addition to pressure sensor.</p> | (1) Poor operations of indoor LEV → Heating (2) Poor operations of the BC controller Heating-only or heating-main → Indoor LEV3 (3) Poor operations of the BC controller SVM1, SVM2 → Cooling-only (4) Poor operations of the BC controller SVA → Cooling-only/Cooling-main (5) Poor operations of the BC controller SVB → Heating-only/Heating-main (6) Poor operations of the solenoid valve SV (4a~4d (P200~P250type), 4a~4d, 5a, 5b (P400~P500type)) → Heating-only/Heating-main | Check operations status by actually performing cooling or heating operations. Cooling : Indoor LEV LEV1,2,3 (BC) SVM1,2 (BC) SVA (BC) Heating : Indoor LEV LEV3 (BC) SVM2 (BC) SV4a~4d (OC) SV5a,5b (OC) |
| | | | (7) Branch port address setting error | |
| | | | (8) Poor operations of ball valve. | Confirm that ball valve is fully opened. |
| | | | (9) Short cycle of indoor unit. (10) Clogging of indoor unit filter. (11) Fall in air volume caused by dust on indoor unit fan. (12) Dust on indoor unit heat exchanger. (13) Indoor unit fan block, motor trouble. { (2)~(13) : Rise in high pressure caused by lowered condensing capacity in heating-only and heating-main operation. } | Check indoor unit and take measures to trouble. |
| | | | (14) Insufficient heat source water volume. (15) Heat source water cutoff. (16) Dirty or clogged water-source heat exchanger. | Check the water-source heat exchanger for clogging. Check the circulation water pump on heat source unit. |
| | | | | |

| Checking code | | Meaning, detecting method | Cause | Checking method & Countermeasure |
|---------------|--|---|---|---|
| 1302 | High pressure abnormality 1 (Heat source unit) | | (17) Disconnection of relay cable between compressor unit and heat exchanger unit (P400 and 500 models only) | Check for the disconnection of relay cable, and correct the problem if found. |
| | | | (18) Poor operations of solenoid valves SV1 (Bypass valves (SV1) can not control rise in high pressure). | See Trouble check of solenoid valve. |
| | | | (19) Thermistor trouble (TH5, TH6). | Check resistance of thermistor. |
| | | | (20) Pressure sensor trouble. | Check Trouble check of pressure sensor. |
| | | | (21) Control circuit board thermistor trouble, pressure sensor input circuit trouble. | Check inlet temperature and pressure of sensor with LED monitor. |
| | | | (22) Thermistor mounting failure (TH5, TH6) (23) No connector for pressure switch (63H), disconnected wire. | Check inlet temperature and pressure of sensor with LED monitor. |
| | High pressure abnormality 2 (Heat source unit) | When pressure sensor detects 0.098MPa or less just before starting of operation, error stop is observed with code No.“1302” displayed. | (1) Fall in internal pressure caused by gas leak. (2) Pressure sensor trouble. (3) Film breakage. (4) Coming off of pin in connector portion, poor contact. (5) Broken wire. (6) Pressure sensor input circuit trouble on control circuit board. | See Trouble check of pressure sensor. |
| 1500 | Overcharged refrigerant abnormality | <p>1. If the discharge SH \leq 10K is detected during operation (at first detection), the heat source unit stops at once. The 3 minutes restart prevention mode is entered. After three minutes, the heat source unit starts up again.</p> <p>2. If the discharge SH \leq 10K is detected again within 30 minutes after the heat source unit stops (second detection), an abnormal stop is applied, and “1500” is displayed.</p> <p>3. If discharge SH \leq 10K is detected more than 30 minutes after the heat source unit stops, the state is the same as the first detection and the same operation as 1. above takes place.</p> <p>4. The abnormal stop delay period is in effect for 30 minutes after the heat source unit stops. The abnormal stop delay period LED turns ON during this time.</p> | (1) Excessive refrigerant charge. | Refer to the section on judging the refrigerant volume. |
| | | | (2) Main circuit board thermistor input circuit trouble. | Check the sensor detection temperature and pressure with the LED monitor. |
| | | | (3) Thermistor mounting trouble (TH11). | |
| 2000 | Pump interlock operation | Unit will come to an abnormal stop and code “2000” is displayed if pump interlock circuit remains open for 10 continuous minutes except when the unit is stopped. Dip SW2-8 on the heat source unit’s controller board must be set to OFF for the code to be displayed. | (1) Heat source unit water circulation pump failure. (2) Broken wire. (3) Connector disconnection, contact failure. (4) Interlock input circuit failure on the relay board. (5) Interlock input circuit failure on the controller board. | |

| Checking code | | Meaning, detecting method | Cause | Checking method & Countermeasure |
|---------------|--------------------------------------|---|--|--|
| 2134 | Abnormal water temperature | <p>1. If water inlet temperature of 5°C or below or 50°C or above is detected (first detection) during operation, the heat source unit comes to a stop, goes into the 3-minute restart prevention mode, and restarts in 3 minutes.</p> <p>2. If water inlet temperature of 5°C or below or 50°C or above is detected again (second detection) within 30 minutes of the first occurrence (as described under item 1 above), the unit comes to an abnormal stop and code "2134" is displayed.</p> | (1) Heat source unit water circulation pump failure. (2) Cooling tower/heater device problem. (3) Dirty or clogged water-source heat exchanger. | |
| | | | (4) Thermistor failure (TH6). | |
| | | | (5) Thermistor input circuit failure on the controller board | |
| | | | (6) Poor thermistor installation (TH6) | |
| | | | 3. If water inlet temperature of 5°C or below or 50°C or above is detected again after 30 minutes of the first occurrence (as described under item 1 above), this detection is regarded as the first detection, and the unit follows the same procedure as described under item 1. | |
| 2135 | Water-source heat exchanger freezing | <p>1. If the following conditions are met (first time) during operation, the heat source unit comes to a stop, goes into the 3-minute restart prevention mode, and restarts in 3 minutes. <Conditions> Water-source heat exchanger outlet piping sensor reading (TH9) is below 3°C or compressor frequency in heating only or heating main operation is smaller than the sum of the minimum frequency (P200,P250 : 30Hz,P400,P500 : 20Hz) + 10. AND Te stays below -10°C for continuous 15 minutes.</p> <p>2. If the above conditions are met again (second time) within 60 minutes of the first stoppage of the heat source unit, the unit comes to an abnormal stop and code "2135" is displayed.</p> <p>3. If the above conditions are met again after 60 minutes of the first stoppage of the heat-source unit, this detection is regarded as the first detection, and the unit follows the same procedure as described under item 1.</p> | <p>(1) Heat source unit water circulation pump failure. (2) Heater device problem. (3) Dirty or clogged water-source heat exchanger. (4) Broken lead wire for water-source heat exchanger Freeze Thermo. (5) Disconnected connector for water-source heat exchanger Freeze Thermo. (6) Problem with the water-source heat exchanger freeze prevention thermo input circuit on the relay board. (7) Problem with the water-source heat exchanger freeze prevention thermo input circuit on the controller board</p> | |
| 2500 | Leakage (water) abnormality | When drain sensor detects flooding during drain pump OFF. | (1) Water leak due to humidifier or the like in trouble. | Check water leaking of humidifier and clogging of drain pan. |

| Checking code | | Meaning, detecting method | Cause | Checking method & Countermeasure |
|---------------|--|--|--|---|
| 2502 | Drain pump abnormality (This error occurs only for the applied indoor units.) | When drain sensor detects flooding during drain pump ON. | <p>(1) Drain pump malfunction</p> <p>(2) Clogged drain pump intake</p> <p>(3) Clogged drain pipe</p> <p>(4) Return water from drain pipe (installation defect)</p> | <p>(1) Check the drain pump malfunction</p> <p>① Check whether there is water in the drain pan. When the water level is approximately 10mm from the bottom of the drain pan, the drain pump may be normal.</p> <p>② Check whether the drain pump operates properly. Whether the resistance of the drain pump is normal or the drain pump operates when the power supply is applied.</p> <p>(2) Check the clogged drain pump intake. Check whether there is no dust around the drain pump intake.</p> <p>(3) Check the clogged drain pipe. Check whether there is no clogging outside of the pipe body.</p> <p>(4) Check the return water. Pour approximately 1-liter water in the drain pump, and start the drain pump. When the water level in the drain pan becomes stably lower, stop the pump, and check the amount of the return water to the drain pan. ※When a large amount of water returns, the gradient of drain pipe may be the reason. Check whether the drain pipe is installed properly as the instruction in the installation manual says. Furthermore, check whether the gradient of the unit installation is horizontal. Error may be detected because of the return water depending on the gradient. (Gradient approximately 0.5°)</p> <p>After checking the above, when all normal, misdetection of the drain sensor is possible.</p> <p>① Check the drain sensor. · Check the resistance value.</p> <p><Error release method> Reset (error reset) the applied indoor unit with the remote controller.</p> |

| Checking code | | Meaning, detecting method | Cause | Checking method & Countermeasure |
|---------------|--|--|---|--|
| 2502 | Drain pump abnormality (This error occurs for all the indoor units in the same refrigerant system.) | When drain sensor detects flooding during drain pump ON in the stopped indoor unit. | (1) Drain pump malfunction (2) Clogged drain pump intake (3) Clogged drain pipe (4) Return water from drain pipe (installation defect) | Refer to the previous page. <Error release method> Reset the power of the applied indoor unit. However, the reset (error reset) using the remote controller can be done in 10 minutes after the power has been reset. Furthermore, the reset using the remote controller is required for all the indoor units. |
| 2503 | Drain sensor abnormality | When short circuit or open circuit is detected during operation (cannot be detected during OFF). Short circuit: detected 90°C or more Open circuit: detected -20°C or less | (1) Thermistor failure (2) Connector contact failure (Insert failure) (3) Disconnected wire or partial disconnected wire for thermistor | Thermistor resistance check 0°C : 6.0kΩ 10°C : 3.9kΩ 20°C : 2.6kΩ 30°C : 1.8kΩ 40°C : 1.3kΩ |
| | | | (4) Indoor board (detection circuit) failure | Connector contact failure If no fault is found, indoor board is faulty. |
| 2600 | Water leakage | — | Water leaks from the pipes in such as the humidifier. | Check the place from where the water leaks. |
| 2601 | Water-supply cut | — | (1) Water is not supplied into the humidification feed tank. | Check the amount of supply water. Check the solenoid valve or connection. |
| | | | (2) The solenoid valve for humidification is OFF. | Check the connector. |
| | | | (3) Float switch disconnection. | Check the connecting part. |
| | | | (4) Float switch malfunction. | Check the defective float switch. |
| | | | (5) Freeze on the feed tank. | Defrost by turning the power off and turn the power on again. |

| Checking code | | Meaning, detecting method | Cause | Checking method & Countermeasure | | | | | | | | |
|------------------------|---|---|---|---|-----|-----|----|------------|---|------------|----|------------|
| 4103 | Reverse phase abnormality | 1. The operation cannot be started because of the reserve phase of one of the power lines (L1, L2 or L3). | (1) Faulty wiring | <ul style="list-style-type: none"> · Check whether the phase of the power supply terminal block (TB1) is normal. · Check the wiring between the power supply terminal block (TB1) and the main boards (CN20 and CN21). <table border="1"> <thead> <tr> <th>TB1</th> <th>Pin</th> </tr> </thead> <tbody> <tr> <td>L1</td> <td>CN20 5 Pin</td> </tr> <tr> <td>N</td> <td>CN21 3 Pin</td> </tr> <tr> <td>L2</td> <td>CN21 1 Pin</td> </tr> </tbody> </table> | TB1 | Pin | L1 | CN20 5 Pin | N | CN21 3 Pin | L2 | CN21 1 Pin |
| | | | TB1 | Pin | | | | | | | | |
| | | | L1 | CN20 5 Pin | | | | | | | | |
| | | | N | CN21 3 Pin | | | | | | | | |
| | | L2 | CN21 1 Pin | | | | | | | | | |
| | | (2) Main board failure | If the above faults are not found, the main board is faulty. | | | | | | | | | |
| | | 2. When turning on the power, the operation cannot be started because of the open phase of one of the power lines (L1 or L2). | (1) Power supply failure a) Open phase of power supply voltage b) Power supply voltage drop | Check the input resistance of the power supply terminal block (TB1). | | | | | | | | |
| | | | (2) Faulty wiring Between the voltage terminal block (TB1) and the main boards (CN20 and 21) | <ul style="list-style-type: none"> · Check the voltage of No.5 pin of the main board connector (CN20) and the voltage between No.1 and 3 pin of CN21. · If the voltage is not the same as the power supply voltage, the wiring is faulty. | | | | | | | | |
| (3) Blown fuse | Check whether the fuses of the main board (both F01 and F02) are not blown. | | | | | | | | | | | |
| (4) Main board failure | If the above faults are not found, the main board is faulty. | | | | | | | | | | | |

| Checking code | | Meaning, detecting method | Cause | Checking method & Countermeasure |
|---------------|---|---|---|--|
| 4115 | Power supply sync signal abnormality | The frequency cannot be determined when the power is switched on. (The power supply's frequency cannot be detected. The outdoor fan cannot be controlled by phase control.) | (1) There is an open phase in the power supply. | Check before the breaker, after the breaker or at the power supply terminal blocks TB1, and if there is an open phase, correct the connections. |
| | | | (2) A fuse is defective. | If F01 or F02 on the MAIN board is melted, (Resistance between both ends of the fuse is ∞), replace the fuses. |
| | | | (3) Faulty wiring. | Check voltage between the pin-5 on the main board connector (CN20), between the pin-1 and the pin-3 on CN21. When the voltage is not the same as the power source voltage (380-415V), the wiring is faulty. |
| | | | (4) The circuit board is defective. | If none of the items in (1) to (3) is applicable, and if the trouble reappears even after the power is switched on again, replace the MAIN board (when replacing the circuit board, be sure to connect all the connectors, ground wires, etc. securely). |
| 4116 | Fan speed abnormality (motor abnormality) | [LOSSNAY] 1. The motor keep running even if the power is OFF. 2. The thermal overload relay is ON. (Only for the three-phase model) [Indoor unit] If detected less than 180rpm or more than 2000rpm, the indoor unit will restart and keep running for 3 minutes. If detected again, the display will appear. | (1) Defective board. | Replace the board. |
| | | | (2) Motor malfunction. | Check for the motor and the solenoid switch. |
| | | | (3) Solenoid switch malfunction. | |
| 4220 | Bus voltage drop abnormality (Error details No.108) | If $V_{dc} \leq 289V$ is detected during operation. (Software detection) | (1) Power supply environment. | Check whether the unit makes an instantaneous stop when the detection result is abnormal or a power failure occurs. Check whether the power voltage $\geq 289V$ across all phases. |
| | | | (2) Voltage drop detected. | <In the case of 4220> Check the voltage of the connector (CNDC2) on the INV board. → Replace the INV board when there is no voltage drop. → Check the followings when there is a voltage drop. ① Check the voltage of CN52C on the main board → Refer to (3) ② Check whether 52C1 works normally → Refer to (4) Or check 52C1-connecting piping. ③ Check for the diode stack → Refer to (5) ④ Check for the wiring and the connectors between the CNDC2 on the INV board and the CNDC1 on the G/A board. Replace G/A board when no fault is found for the above ①~④. |

| Checking code | | Meaning, detecting method | Cause | Checking method & Countermeasure |
|---------------|---|--|---|--|
| 4220 | Bus voltage drop abnormality (Error details No.108) | If $V_{dc} \leq 289V$ is detected during operation. (Software detection) | (3) Main board failure. | Check whether AC220~240V is applied to the connector (CN52C) during inverter operation. → If not applied, check the main board and the fuse (F01 and F02). Replace the main board when no fault is found. |
| | | | (4) 52C1 failure. | Refer to [9].[4].7.(2) Check the coil resistance check. |
| | | | (5) Diode stack failure. | Refer to [9].[4].7.(2) Check the diode stack resistance. |
| | Bus voltage rise abnormality (Error details No.109) | If $V_{dc} \geq 817V$ is detected during inverter operation. | (1) Different voltage connection. | Check the voltage of the power-supply terminal block (TB1). |
| | | | (2) INV board failure. | Replace INV board if no fault is found. In the case of 4220: INV board |
| | Bus Voltage abnormality (Error details No.110) | Bus voltage abnormality If $V_{dc} \geq 772V$ or $V_{dc} \leq 308V$ is detected. (H/W detection) | (1) Same as detail code No.108 and 109 of 4220 error. | Same as detail code No.108 and 109 of 4220 error. |
| | Logic error (Error details No.111) | If only the H/W error logic circuit operates, and no identifiable error is detected. | <In the case of 4220> (1) External noise. (2) INV board failure. (3) G/A board failure. (4) IPM failure. (5) DCC failure. | Refer to [9].[4].7.(2).[5] Replace G/A board. Refer to [9].[4].7.(2).[1] Replace DCCT. |
| | | | <In the case of 4225> (1) External noise. (2) FAN board failure. | Refer to [9].[4].7.(2).[7] |
| 4230 | Heat sink overheat protection | <In the case of 4230> When the heat sink temperature (THHS1) $\geq 95^{\circ}C$ is detected. | (1) Cooling fan failure. | Check that the connector and the wire are not disconnected. Check the resistance of the cooling fan. Resistance of the cooling fan: 0.5-1.0 k Ω |
| | | | (2) LEV2 failure. | Refer to the page on troubleshooting for LEV. |
| | | | (3) THINV failure. | Check that the thermistor and the wire are not disconnected. Check the resistance of the sensor. Refer to [6].[2].1 |
| | | | (4) THHS failure. | |
| | | | (5) Air passage blockage. | Check to make sure the air passage of the heat sink cooling is not blocked. |
| | | | (6) INV board fan output failure. | Ensure that 220~240V is applied to the inverter PCB connector CNFAN when the inverter is on. |
| | | | (7) Power supply environment | Check the power supply voltage. Ensure that the power supply voltage $\geq 342V$ across all phases. |
| | | | (8) IPM failure. | Refer to [9].[4].7.(2) "Check for compressor ground fault or coil error" [5] "Check the inverter circuit trouble" |

*: For the check code on the inverter, refer to " 7. Inverter and compressor " in the section [4] " Troubleshooting of principal parts "

| Checking code | | Meaning, detecting method | Cause | Checking method & Countermeasure | | | | | | | | | | |
|------------------------------------|---|---|--|---|-----------|---------|-----------|---------|-----------|---------|-----------|---------|------------------------------|---|
| 4240 | Overload abnormality | <p>When the output current (Iac) > I_{max} (Arms) or THHS > 90°C is detected for 10 minutes in a row during the inverter operation.</p> <table border="1" data-bbox="470 358 746 548"> <thead> <tr> <th></th> <th>I_{max}</th> </tr> </thead> <tbody> <tr> <td>Type P200</td> <td>27 Arms</td> </tr> <tr> <td>Type P250</td> <td>27 Arms</td> </tr> <tr> <td>Type P400</td> <td>27 Arms</td> </tr> <tr> <td>Type P500</td> <td>27 Arms</td> </tr> </tbody> </table> | | I _{max} | Type P200 | 27 Arms | Type P250 | 27 Arms | Type P400 | 27 Arms | Type P500 | 27 Arms | (1) Air passage short cycle. | Ensure that a short cycle has not occurred at the unit fan exhaust. |
| | | | | I _{max} | | | | | | | | | | |
| | | | Type P200 | 27 Arms | | | | | | | | | | |
| | | | Type P250 | 27 Arms | | | | | | | | | | |
| | | | Type P400 | 27 Arms | | | | | | | | | | |
| | | | Type P500 | 27 Arms | | | | | | | | | | |
| | | | (2) Air passage blockage. | Check to make sure the air passage of the heat sink cooling is not blocked. | | | | | | | | | | |
| | | | (3) Power supply. | Check if the power supply voltage \geq 342V. | | | | | | | | | | |
| | | | (4) Wiring defect. | Check the cooling fan wiring. | | | | | | | | | | |
| | | | (5) THHS failure. | Check the THHS sensor resistance. | | | | | | | | | | |
| (6) INV board fan output failure. | Ensure that the heat sink temperature is 55°C or more and that 220~240V is applied to the inverter PCB connector CNFAN when the inverter is on. | | | | | | | | | | | | | |
| (7) Cooling fan failure. | Check the cooling fan operation under the above operating conditions. | | | | | | | | | | | | | |
| (8) Current sensor (ACCT) failure. | Refer to [9].[4].7.(4) "Current sensor ACCT" | | | | | | | | | | | | | |
| (9) Inverter circuit failure. | Refer to [9].[4].7.(2).[4] "Inverter damage check" | | | | | | | | | | | | | |
| (10) Compressor failure. | Check that the compressor has not overheated during operation. → Check the refrigerant circuit (oil return section). Replace the compressor if there are no problems with the refrigerant circuit. | | | | | | | | | | | | | |
| 4250 | IPM abnormality (Error details No.101) | IPM error signal detected | <In the case of 4250> (1) Inverter output related. (2) Same as 4230 error. | Same as 4230 error | | | | | | | | | | |
| | ACCT overcurrent abnormality (Error details No.102) DCCT overcurrent abnormality (Error details No.103) ACCT overcurrent abnormality (Error details No.106, 107) | Overcurrent break (94A _{peak} or 35Arms) detected by the current sensor. | (1) Inverter output related. | [9].[4].7.(2) inverter output related trouble processing Refer to [1] - [5]. | | | | | | | | | | |
| | IPM short/grounding fault (Error details No.104) | IPM short damage or grounding at the load side detected just before starting the inverter. | <In the case of 4250> (1) Grounding fault of compressor. (2) Inverter output related. | Refer to [9].[4].7.(2) | | | | | | | | | | |

* For the check code on the inverter, refer to " 7. Inverter and compressor " in the section [4] " Troubleshooting of principal parts "

| Checking code | | Meaning, detecting method | Cause | Checking method & Countermeasure | |
|---------------|--|--|---|---|--|
| 4250 | Load short abnormality (Error details 105) | Shorting at the load (compressor) side detected just before starting the inverter. | <In the case of 4250> (1) Shorting of compressor (2) Output wiring (3) Power supply | Refer to [9].[4].7.(2).[2] | |
| 4260 | Cooling fan abnormality | <In the case of 4260> When the heat sink temperature (THHS1) $\geq 95^{\circ}\text{C}$ for 10 minutes or longer after the inverter starts. | Same as 4230 error | Same as 4230 error | |
| 5101 | Thermal sensor error (Indoor unit) | Air inlet | (1) Thermistor failure (2) Contact failure of the connector (3) Thermistor wire disconnection or partial disconnection (4) Thermosensor is not set up or contact failure | Thermistor resistance check 0°C : 15k Ω 10°C : 9.7k Ω 20°C : 6.4k Ω 30°C : 4.3k Ω 40°C : 3.1k Ω | |
| 5102 | | Liquid pipe | | | |
| 5103 | | Gas pipe | (5) Indoor board failure (detection circuit) | | Check the contact of the connector If no fault is found, the indoor board is a failure. |
| 5104 | | Outdoor air temperature | | | |
| 5104 | Outdoor air processing unit | Outdoor air temperature | (1) The connection of the connector (CN29) is a failure. (2) The outdoor air processing unit is out of order. | Check the contact of the connector Replace the sensor. | |

* For the check code on the inverter, refer to “ 7. Inverter and compressor ” in the section [4] “ Troubleshooting of principal parts ”

| Checking code | | Meaning, detecting method | Cause | Checking method & Countermeasure |
|---------------|--|---|--|---|
| 5101 | Temperature sensor abnormality (Heat source unit) | <p>1. Shorting (high temperature intake) or open (low temperature intake) of the thermistor is detected. (First detection) The heat source unit will stop at once and the restart prevention mode will be operated for 3 minutes. When the detection temperature of the thermistor is within the normal range just before the restart, the unit must be restarted.</p> <p>2. When shorting or open is detected again (second detection) during the operation after the restart, the heat source unit will stop at once and the restart prevention mode will be operated for 3 minutes. When the detection temperature of the thermistor is within the normal range just before the restart, the unit must be restarted.</p> <p>3. When shorting or open is detected again (third detection) during the operation after the restart, the heat source unit will make an error stop.</p> <p>4. When shorting or open of the thermistor is detected just before the restart, the unit will make an error stop and check code "5101", "5106", "5109", and "5112" will appear.</p> <p>5. LED display, which indicates the grace period, will appear while the restart prevention mode is being operated.</p> <p>6. Shorting or open is not detected for 10 minutes after starting the compressor or for 3 minutes during or after defrosting.</p> | (1) Thermistor failure | Thermistor resistance check |
| 5105 | | | (2) Pinched lead wire | Check for lead wire. |
| 5106 | | | (3) Coating tear | Check for coating. |
| 5107 | | | (4) No pin on the connector, contact failure | Check for connector. |
| 5108 | | | (5) Disconnected wire | Check for wire. |
| 5109 | | | (6) Thermistor input circuit failure on the main board | Check the intake temperature of the sensor with the LED monitor. When the temperature is far different from the actual temperature, replace the control board. |
| 5112 | | | (7) Disconnection of relay cable between compressor unit and heat exchanger unit (TH6, TH9 of P400 and P500 models only) | Check for the disconnection of relay cable, and correct the problem if found. |
| | | | <p>Shorting detection</p> <p>TH11 240°C or higher (0.57kΩ)</p> <p>TH5 110°C or higher (0.4kΩ)</p> <p>TH6 110°C or higher (0.4kΩ)</p> <p>TH7 70°C or higher (1.14kΩ)</p> <p>TH8 70°C or higher (1.14kΩ)</p> <p>TH9 110°C or higher (0.4kΩ)</p> <p>THINV 110°C or higher (0.4kΩ)</p> | <p>Open detection</p> <p>0°C or lower (643kΩ)</p> <p>-40°C or lower (130kΩ)</p> <p>-40°C or lower (130kΩ)</p> <p>-40°C or lower (130kΩ)</p> <p>-40°C or lower (130kΩ)</p> <p>-40°C or lower (130kΩ)</p> <p>-40°C or lower (130kΩ)</p> |
| 5110 | Radiator panel temperature sensor abnormality Error details 01: Compressor INV side | THHS open or shorting is detected just before starting the inverter or during operation. | (1) THHS sensor failure | Check for short circuit in THHS sensor. |
| | | | (2) Contact failure | Replace THHS sensor. |
| | | | (3) INV board failure of the compressor or the fan | Replace INV board of the compressor or the fan. |
| 5111 | Thermal sensor abnormality (BC controlled) | <p>1. When short (high temp. inlet) or open (low temperature inlet) of thermistor is detected during operation, error stop will be commenced displaying "5111" or "5112," or "5115" or "5116".</p> <p>2. The above detection is not made during defrosting and 3-minute after changing operation mode.</p> | (1) Thermistor trouble. | Check thermistor resistance. |
| 5112 | | | (2) Biting of lead wire. | Check lead wire biting. |
| 5115 | | | (3) Broken cover. | Check broken cover. |
| 5116 | | | (4) Coming off of pin at connector portion, poor contact. | Check coming off of pin at connector. |
| | | | (5) Broken wire. | Check broken wire. |
| | | | (6) Faulty thermistor input circuit of control board. | Check sensor sensing temperature. If it deviates from the actual temperature seriously, replace control |
| | | | <p>Short Detected</p> <p>TH11 110°C or more (0.4 kΩ)</p> <p>TH12 110°C or more (0.4 kΩ)</p> <p>TH15 70°C or more (1.14 kΩ)</p> <p>TH16 70°C or more (0.4 kΩ)</p> | <p>Open Detected</p> <p>-40°C or less (130 kΩ)</p> <p>-40°C or less (130 kΩ)</p> <p>-40°C or less (130 kΩ)</p> <p>-40°C or less (130 kΩ)</p> |

*: For the check code on the inverter, refer to " 7. Inverter and compressor " in the section [4] " Troubleshooting of principal parts "

| Checking code | | Meaning, detecting method | Cause | Checking method & Countermeasure |
|---------------|--|--|---|---|
| 5201 | High pressure sensor abnormality (Heat source unit) | <p>1. When pressure sensor detects 0.098MPa or less during operation, heat source unit once stops with 3 minutes restarting mode, and restarts if the detected pressure of pressure sensor exceeds 0.098MPa immediately before restarting.</p> <p>2. If the detected pressure of sensor is less than 0.098MPa immediately before restarting, error stop is commenced displaying 5201.</p> <p>3. Under 3 minutes restarting mode, LED displays intermittent fault check.</p> <p>4. During 3 minutes after compressor start, defrosting and 3 minutes after defrosting operations, trouble detection is ignored.</p> | (1) Pressure sensor trouble. | See Troubleshooting of pressure sensor. |
| | | | (2) Inner pressure drop due to a leakage. | |
| | | | (3) Broken cover. | |
| | | | (4) Coming off of pin at connector portion, poor contact. | |
| | | | (5) Broken wire. | |
| | | | (6) Faulty thermistor input circuit of MAIN board. | |
| 5201 | Liquid side | When pressure sensor detects 4.06MPa or more, error code "5201" or "5203" is displayed. However, error stop is not made, and backup operation will start. | (1) Pressure sensor trouble. | See Troubleshooting of pressure sensor. |
| 5203 | Intermediate | | (2) Inner pressure drop due to a leakage. | |
| | | | (3) Broken cover. | |
| | | | (4) Coming off of pin at connector portion, poor contact. | |
| | | | (5) Broken wire. | |
| | | | (6) Faulty thermistor input circuit of MAIN board. | |
| 5301 | ACCT sensor abnormality (Error details No.115) | -1.5Arms \leq output current's effective value \leq 1.5Arms was detected during inverter operation. | (1) Contact is faulty. | Check the INV board CNCT2 (ACCT) contact, CNDR2 and G/A Board CNDR1. |
| | | | (2) ACCT sensor is faulty. | Replace the ACCT sensor |
| | DCCT sensor abnormality (Error details No.118) | An abnormal value is detected in the DCCT detection circuit just before the INV started. | (1) Contact is faulty. | Check the connector connection on the INV board CNCT (DCCT), DCCT side. |
| | | | (2) DCCT sensor incorrectly installed. | Check DCCT installation direction |
| | | | (3) DCCT sensor is faulty. | Replace the DCCT sensor |
| | | | (4) INV board fault. | Replace the INV board |
| | ACCT sensor/circuit abnormality (Error details No.117) | An abnormal value was detected with the ACCT detection circuit just before the INV started. | (1) INV board fault. | Refer to [9].[4].7.(2).[1] "Check the INV board error detection circuit" |
| | | | (2) Compressor ground fault and IPM fault. | Refer to [9].[4].7.(2).[2] "Check for compressor ground fault or coil error." Refer to [9].[4].7.(2).[5] "Check the inverter circuit trouble". |

* For the check code on the inverter, refer to " 7. Inverter and compressor " in the section [4] " Troubleshooting of principal parts "

| Checking code | | Meaning, detecting method | Cause | Checking method & Countermeasure |
|---|--|---|---|---|
| 5301 | DCCT sensor/circuit abnormality (Error details No.116) | An abnormal value was detected with the DCCT detection circuit just before the INV started. | (1) Contact is faulty. | Check the contacts around the INV board connector CNCT and DCCT side connector. |
| | | | (2) INV board fault. | Refer to [9].[4].7.(2).[1] "Check the INV board error detection circuit". |
| | | | (3) DCCT sensor is faulty. | If there is no problem up to step (2), replace DCCT and check the DCCT polarity. |
| | | | (4) Compressor ground fault and IPM fault. | Refer to [9].[4].7.(2).[2] "Check for compressor ground fault or coil error." Refer to [9].[4].7.(2).[5] "Check the inverter circuit trouble". |
| IPM open/ACCT connection abnormality (Error details No.119) | IPM open damage or CNCT2 dislocation was detected just before INV started. (Sufficient current was not detected during self-diagnosis just before starting.) | (1) ACCT sensor is dislocated | Check CNCT2 sensor connection (Check ACCT installation state) | |
| | | (2) Wire connection is faulty. | Check CNDR2 connection on INV board, or CNDR1 connection on G/A board | |
| | | (3) ACCT is faulty. | Refer to [9].[4].7.(4) "Current sensor ACCT" resistance value | |
| | | (4) Compressor is disconnected | Refer to [9].[4].7.(2).[2] "Check for compressor ground fault or coil error". | |
| | | (5) Inverter circuit is faulty. | Refer to [9].[4].7.(2).[5] "Check the inverter circuit trouble". | |
| ACCT miswiring abnormality (Error details No.120) | Improper installation of the ACCT sensor was detected. | (1) ACCT sensor incorrectly installed. | Refer to [9].[4].7.(4) "Current sensor ACCT". | |

* For the check code on the inverter, refer to "7. Inverter and compressor" in the section [4] "Troubleshooting of principal parts"

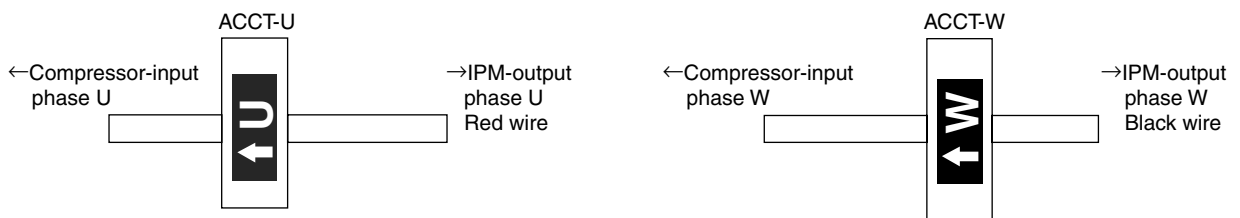

2. Communication/system errors

| Checking code | Meaning, detecting method | Cause | Checking method & Countermeasure |
|---------------|--|---|--|
| 6600 | Multiple address abnormality Transmission from units with the same address is detected. Note: The address/attribute shown on remote controller indicates the controller which has detected error. | (1) Two or more controllers of heat source unit, indoor unit, remote controller, etc. have the same address. <Example> Error display of the remote controller 6600 "01" Unit No.1 detected the error Two Units No.1 or more are in a same system. | Search for the unit which has the same address with that of the source of the trouble. When the same address is found, turn off the power source of heat source unit, and indoor unit for 5 minutes or more after modifying the address, and then turn on it again. |
| 6601 | Unset polarity The error detected when transmission processor cannot distinguish the polarities of the M-NET transmission line. | (1) No voltage is applied to the M-NET transmission line that G-50A is connected to. (2) M-NET transmission line to which G-50A is connected is short-circuited. | Check if power is supplied to the M-NET transmission line of the G-50A, and correct any problem found. |

| Checking code | Meaning, detecting method | Cause | Checking method & Countermeasure |
|---------------|---|--|---|
| 6602 | <p>Transmission processor hardware abnormality</p> <p>Though transmission processor intends to transmit "0", "1" is displayed on transmission line.</p> <div data-bbox="360 387 687 551" style="border: 1px solid black; padding: 5px;"> <p>Note: The address/attribute shown on remote controller indicates the controller which has detected error.</p> </div> | <p>(1) At the collision of mutual transmission data generated during the wiring work or polarity change of the transmission line of indoor or heat source unit while turning the power source on, the wave shape is changed and the error is detected.</p> <p>(2) Ground fault of transmission line.</p> <p>(3) Insertion of power supply connector (CN40) of plural heat source units at the grouping of plural refrigerant systems.</p> <p>(4) Insertion of power supply connector (CN40) of plural heat source units in the connection system with MELANS.</p> <p>(5) When using the power supply unit for transmission line in the connected system with MELANS, the power supply connector (CN40) of the heat source unit is inserted into the transmission line.</p> <p>(6) Faulty controller of unit in trouble.</p> <p>(7) Change of transmission data due to the noise in transmission.</p> <p>(8) Connection system with plural refrigerant systems or MELANS for which voltage is not applied on the transmission line for central control.</p> | <p>Checking method and processing</p> |
| 6603 | <p>Transmission circuit bus-busy abnormality</p> <p>1. Collision of data transmission: Transmission can not be performed for 4~10 consecutive minutes due to collision of data transmission.</p> <p>2. Data can not be transmitted on transmission line due to noise for 4~10 consecutive minutes.</p> <div data-bbox="360 1989 687 2096" style="border: 1px solid black; padding: 5px;"> <p>Note: The address/attribute shown on remote controller indicates the controller which has detected error.</p> </div> | <p>(1) As the voltage of short frequency like noise is mixed in transmission line continuously, transmission processor can not transmit.</p> <p>(2) Faulty controller of generating unit.</p> | <p>(a) Check transmission wave shape/noise on transmission line by following <Investigation method of transmission wave shape/noise>.</p> <p>→No noise indicates faulty controller of generating unit.</p> <p>→Noise if existed, check the noise.</p> |

| Checking code | Meaning, detecting method | Cause | Checking method & Countermeasure |
|---------------|---|--|--|
| 6606 | <p>Communications with transmission processor abnormality</p> <p>Communication trouble between apparatus processor and transmission processor.</p> <div style="border: 1px solid black; padding: 5px; margin-top: 10px;"> <p>Note: The address/attribute shown on remote controller indicates the controller which has detected error.</p> </div> | <p>(1) Data is not properly transmitted due to casual erroneous operation of the generating controller.</p> <p>(2) Faulty generating controller.</p> | <p>Turn off power sources of indoor unit, and heat source unit.</p> <p style="margin-left: 20px;">{ When power sources are turned off separately, microcomputer is not reset and normal operations can not be restored. }</p> <p>→Controller trouble is the source of the trouble when the same trouble is observed again.</p> |

| Checking code | Meaning, detecting method | |
|---------------|---------------------------|--|
| 6607 | No ACK abnormality | <p>When no ACK signal is detected in 6 continuous times with 30 seconds interval by transmission side controller, the transmission side detects error.</p> <div style="border: 1px solid black; padding: 5px; margin-top: 10px;"> <p>Note : The address/attribute shown on remote controller indicates the controller not providing the answer (ACK).</p> </div> |

| System composition | Generating unit address | Display of trouble | Detecting method | Cause | Cause checking method & Countermeasure |
|--------------------------------------|------------------------------------|---|---|--|--|
| (1) Single refrigerant system | 1. Outdoor (Heat source) unit (OC) | Remote controller (RC) | No reply (ACK) at BC, IC transmission to OC | <p>(1) Poor contact of transmission line of OC or BC, IC.</p> <p>(2) Damping of transmission line voltage/signal by acceptable range of transmission wiring exceeded.</p> <p style="margin-left: 20px;">{ Farthest: Less than 200m Remote controller wiring: Less than 10m }</p> <p>(3) Erroneous sizing of transmission line (Not within the range below). Wire diameter: 1.25mm² or more</p> <p>(4) Faulty control circuit board of OC.</p> | <p>Shut down OC unit power source, and make it again.</p> <p>It will return to normal state at an accidental case.</p> <p>When normal state can not be recovered, check for the (1) ~ (4) of the cause.</p> |
| | 2. BC controller (BC) | M-NET remote controller (RC) MA remote controller (MA) | No reply (ACK) at IC transmission to BC | <p>(1) When BC controller address is changed or modified during operation.</p> <p>(2) Faulty or disconnection of transmission wiring of BC controller.</p> <p>(3) Disconnection of BC controller connector (CN02).</p> <p>(4) Faulty control board of BC controller.</p> | <p>Shut down the power sources of both OC and BC for 5 minutes or more, and make them again.</p> <p>It will return to normal state at an accidental case.</p> <p>When normal state can not be recovered, check for (1)~(4) of the cause.</p> |
| | 3. Indoor unit (IC) | Remote controller (RC) | No reply (ACK) at RC transmission to IC | <p>(1) When IC unit address is changed or modified during operation.</p> <p>(2) Faulty or disconnection of transmission wiring of IC.</p> <p>(3) Disconnection of IC unit connector (CN2M).</p> <p>(4) Faulty IC unit controller.</p> <p>(5) Faulty remote controller.</p> | <p>Shut down both OC power source for 5 minutes or more, and make them again.</p> <p>It will return to normal state at an accidental case.</p> <p>When normal state can not be recovered, check for the (1) ~ (4) of the cause.</p> |
| | 4. Remote controller (RC) | Remote controller (RC) | No reply (ACK) at IC transmission to RC | <p>(1) Faulty transmission wiring at IC unit side.</p> <p>(2) Faulty transmission wiring of RC.</p> <p>(3) When remote controller address is changed or modified during operation.</p> <p>(4) Faulty remote controller.</p> | <p>Shut down OC power sources for 5 minutes or more, and make it again.</p> <p>It will return to normal state at an accidental case.</p> <p>When normal state can not be recovered, check for the (1) ~ (4) of the cause.</p> |

| Checking code | Meaning, detecting method | | | | |
|--|-----------------------------------|---|---|--|--|
| 6607 (continued) | No ACK abnormality | When no ACK signal is detected in 6 continuous times with 30 seconds interval by transmission side controller, the transmission side detects error. | | | |
| <div style="border: 1px solid black; padding: 5px; width: fit-content; margin: auto;"> Note : The address/attribute shown on remote controller indicates the controller not providing the answer (ACK). </div> | | | | | |
| System composition | Generating unit address | Display of trouble | Detecting method | Cause | Cause checking method & Countermeasure |
| (2) Group operation system using plural refrigerants | 1. Outdoor (Heat source) unit(OC) | Remote controller (RC) | No reply (ACK) at BC, IC transmission to OC | As same that for single refrigerant system. | Same as measure for single refrigerant system. |
| | 2. BC controller (BC) | M-NET remote controller (RC) MA remote controller (MA) | No reply (ACK) at IC transmission to BC | As same that for single refrigerant system. | Same as measure for single refrigerant system. |
| | 3. Indoor unit (IC) | Remote controller (RC) | No reply (ACK) at RC transmission to IC | (1) Cause of (1) ~ (5) of "Cause for single refrigerant system". (2) Disconnection or short circuit of transmission line of OC terminal block for centralized control (TB7). (3) Shut down of OC unit power source of one refrigerant system. (4) Neglecting insertion of OC unit power supply connector (CN40). (5) Inserting more than 2 sets of power supply connector (CN40) for centralized control use. For generation after normal operation conducted once, the following causes can be considered. <ul style="list-style-type: none"> • Total capacity error (7100) • Capacity code setting error (7101) • Connecting set number error (7102) • Address setting error (7105) | (a) Shut down the power source of both IC and OC for over 5 minutes simultaneously, and make them again. Normal state will be returned in case of accidental trouble. (b) Check for (1) ~ (5) of causes. If cause is found, remedy it. (c) Check other remote controller or OC unit LED for troubleshooting for trouble. Trouble →Modify the trouble according to the content of check code. No trouble →Faulty indoor controller |
| | 4. Remote controller (RC) | Remote controller (RC) | No reply (ACK) at IC transmission to RC | (1) Cause of (1) ~ (3) of "Cause for single refrigerant system". (2) Disconnection or short circuit of transmission line of OC terminal block for centralized control (TB7). (3) Shut down of OC unit power source of one refrigerant system. (4) Neglecting insertion of OC unit power supply connector (CN40). (5) Inserting more than 2 sets of power supply connector (CN40) for centralized control use. At generation after normal operation conducted once, the following causes can be considered. <ul style="list-style-type: none"> • Total capacity error (7100) • Capacity code setting error (7101) • Connecting set number error (7102) • Address setting error (7105) | (a) Shut down the power source of OC for over 5 minute, and make it again. Normal state will be returned in case of accidental trouble. (b) Check for (1) ~ (5) of causes. If cause is found, remedy it. When normal state can not be obtained, check (1) ~ (5) of causes. |

| Checking code | Meaning, detecting method | | | | |
|--|-----------------------------------|---|---|--|---|
| 6607 (continued) | No ACK abnormality | | When no ACK signal is detected in 6 continuous times with 30 seconds interval by transmission side controller, the transmission side detects error. | | |
| <div style="border: 1px solid black; padding: 5px; width: fit-content; margin: auto;"> Note : The address/attribute shown on remote controller indicates the controller not providing the answer (ACK). </div> | | | | | |
| System composition | Generating unit address | Display of trouble | Detecting method | Cause | Cause checking method & Countermeasure |
| (3) Connecting system with controller (MELANS) | 1. Outdoor (Heat source) unit(OC) | Remote controller (RC) | No reply (ACK) at BC, IC transmission to OC | As same that for single refrigerant system. | Same countermeasure as that for single refrigerant system. |
| | 2. BC controller (BC) | M-NET remote controller (RC) System controller (SC) MA remote controller (MA) | No reply (ACK) at IC transmission to BC | As same that for single refrigerant system. | Same countermeasure as that for single refrigerant system. |
| | 3. Indoor unit (IC) | Remote controller (RC) | No reply (ACK) at transmission of SC to IC | Trouble of partial IC units : (1) Same cause as that for single refrigerant system. | →Same countermeasure as that for single refrigerant system. |
| | | | | Trouble of all IC in one refrigerant system: (1) Cause of total capacity error. (7100) (2) Cause of capacity code setting error. (7101) (3) Cause of connecting number error. (7102) (4) Cause of address setting error. (7105) (5) Disconnection or short circuit of transmission line of OC unit terminal block for central control (TB7). (6) Power source shut down of OC unit. (7) Trouble of OC unit electrical system. | Confirm OC trouble diagnosis LED. →At trouble generation, check for the content according to check code. Check the content of (5) ~ (7) shown left. |
| | | | | Trouble of all IC: (1) As same that for single refrigerant system. (2) When using the power supply unit for transmission line, the power supply connector (CN40) is inserted into the transmission line for centralized control. (3) Disconnection or power source shut down of power supply unit for transmission line. (4) Faulty system controller (MELANS). | Confirm voltage of transmission line for centralized control. • More than 20V → Confirm (1) (2) left. • Less than 20V → Confirm (3) left. |

| Checking code | Meaning, detecting method | | | | |
|--|---------------------------|---|--|--|---|
| 6607 (continued) | No ACK abnormality | When no ACK signal is detected in 6 continuous times with 30 seconds interval by transmission side controller, the transmission side detects error. | | | |
| <div style="border: 1px solid black; padding: 5px; width: fit-content; margin: auto;"> Note : The address/attribute shown on remote controller indicates the controller not providing the answer (ACK). </div> | | | | | |
| System composition | Generating unit address | Display of trouble | Detecting method | Cause | Cause checking method & Countermeasure |
| (3) Connecting system with controller (MELANS) | 4. Remote controller (RC) | Remote controller (RC) | No reply (ACK) at transmission of IC to RC | Same cause as that for plural refrigerant system. | Same countermeasure as that for plural refrigerant system. |
| | | | No reply (ACK) at transmission of MELANS to RC | Trouble of partial IC units: (1) Same cause of that for single refrigerant system. | →Same countermeasure as that for single refrigerant system. |
| | | | | Trouble of all IC in one refrigerant system: (1) Error detected by OC unit. Total capacity error. (7100) Capacity code setting error. (7101) Connecting number error. (7102) Address setting error. (7105) (2) Disconnection or short circuit of transmission line of OC unit terminal block for central control (TB7). (3) Power source shut down of OC unit. (4) Trouble of OC unit electrical system. | Confirm OC trouble diagnosis LED. →At trouble generation, check for the content according to check code. Check the content of (2) ~ (4) shown left. |
| | | | | Trouble of all IC: (1) As same that for single refrigerant system. (2) When using the power supply unit for transmission line, the power supply connector (CN40) is inserted into the transmission line for centralized control. (3) Disconnection or power shutdown of power supply unit for transmission line. (4) Faulty MELANS. | Check the causes of (1) ~ (4) left. |

| Checking code | Meaning, detecting method | | | | |
|--|---------------------------|---|--|--|---|
| 6607 (continued) | No ACK abnormality | When no ACK signal is detected in 6 continuous times with 30 seconds interval by transmission side controller, the transmission side detects error. | | | |
| <div style="border: 1px solid black; padding: 5px; width: fit-content; margin: 0 auto;"> Note : The address/attribute shown on remote controller indicates the controller not providing the answer (ACK). </div> | | | | | |
| System composition | Generating unit address | Display of trouble | Detecting method | Cause | Cause checking method & Countermeasure |
| (3) Connecting system with controller (MELANS) | 5. System controller (SC) | Remote controller (RC) | No reply (ACK) at transmission of IC to SC | Trouble of partial remote controller: (1) Faulty wiring of RC transmission line. (2) Disconnection or poor contact of RC transmission connector. (3) Faulty RC. | Check the causes of (1) ~ (3) left. |
| | | | | Trouble of all IC in one refrigerant system. (1) Error detected by OC unit. Total capacity error (7100) Capacity code setting error (7101) Connecting number error (7102) Address setting error (7105) (2) Disconnection or short circuit of transmission line of OC unit terminal block for central control (TB7). (3) Power source shut down of OC unit. (4) Trouble of OC unit electrical system. | Confirm OC trouble diagnosis LED. →At trouble generation, check for the content according to check code. Check the content of (2) ~ (4) shown left. |
| | | | | Trouble of all RC: (1) As same that for single refrigerant system. (2) When using the power supply unit for transmission line, the power supply connector (CN40) is inserted into the transmission line for centralized control. (3) Disconnection or power shutdown of power supply unit for transmission line. (4) Faulty MELANS. | Check the causes (1) ~ (4) left. |

| Checking code | Meaning, detecting method | | | | |
|--|-------------------------------------|--------------------|---|--|---|
| 6607 (continued) | No ACK abnormality | | When no ACK signal is detected in 6 continuous times with 30 seconds interval by transmission side controller, the transmission side detects error. | | |
| <div style="border: 1px solid black; padding: 5px; width: fit-content; margin: auto;"> Note : The address/attribute shown on remote controller indicates the controller not providing the answer (ACK). </div> | | | | | |
| System composition | Generating unit address | Display of trouble | Detecting method | Cause | Cause checking method & Countermeasure |
| No relation with system | Address which should not be existed | - | - | (1) IC unit is keeping the memory of the original group setting with RC although the RC address was changed later. The same symptom will appear for the registration with SC. (2) IC unit is keeping the memory of the original interlocking registration with Fresh Master with RC although the Fresh Master address was changed later. | As some IC units are keeping the memory of the address not existing, delete the information. Employ one of the deleting method among two below. (1) Deletion by remote controller. Delete unnecessary information by the manual setting function of remote controller. (2) Deletion by connecting information deleting switch of OC unit. <div style="border: 1px solid black; padding: 5px; width: fit-content; margin: auto;"> Be careful that the use of this method will delete all the group information set with RC and all the interlocking information of Fresh Master and IC unit. </div> (a) Shut down OC unit power source, and wait for 5 minutes. (b) Turn on the dip switch SW2-2 provided on OC unit control circuit board. (c) Make OC unit power source, and wait for 5 minutes. (d) Shut down OC unit power source, and wait for 5 minutes. (e) Turn off the dip switch SW2-2 provided on OC unit control circuit board. (f) Make OC unit power source. |

| Checking code | Meaning, detecting method | Cause | Checking method & Countermeasure |
|---------------|---|---|---|
| 6608 | No response abnormality Though acknowledgment of receipt (ACK) is received after transmission, no response command is returned. Detected as error by transmission side when the same symptom is repeated 10 times with an interval of 3 seconds. <div style="border: 1px solid black; padding: 5px; width: fit-content; margin: auto;"> Note: The address/attribute shown on remote controller indicates the controller which has detected error. </div> | (1) At the collision of mutual transmission data when transmission wiring is modified or the polarity is changed while turning the power source on, the wave shape changes detecting error. (2) Repeating of transmission error due to noise. (3) Damping of transmission line voltage/ signal due to exceeding of the acceptable range for transmission wiring. <ul style="list-style-type: none"> • Farthest Less than 200m • RC wiring Less than 12m (4) Damping of transmission voltage/ signal due to improper type of transmission line. <ul style="list-style-type: none"> • Wire size More than 1.25mm² | (a) Generation at test run. Turn off the power sources of OC unit, IC unit and Fresh Master for more than 5 minutes simultaneously, and make them again. →Returning to normal state means the trouble detection due to transmission line work while powering. (b) Check (3) and (4) of the causes left. (c) Investigate the transmission wave shape/noise on transmission line according to <Investigation method of transmission wave shape/noise>. <div style="border: 1px solid black; border-radius: 15px; padding: 5px; width: fit-content; margin: auto;"> Much possibility if 6602 is generated. </div> |

| Checking code | | Meaning, detecting method | Factor | Checking method & Remedy |
|---------------|---|---|---|---|
| 6831 | MA Communication no reception error | 1. Communication between the MA remote controller and the indoor unit is not done properly. 2. No proper data has been received for 3 minutes. | (1) The remote control line of the MA remote controller or the indoor unit has a poor contact. (2) All remote controllers are slaves. (3) The wiring specifications are not observed. 1. Wire length 2. Wire thickness 3. Number of remote controllers 4. Number of indoor units (4) After the remote controller is connected, disconnection of the remote controller without resetting the power. (5) Noise enters the transfer path of the remote controller. (6) The transmission/reception circuit of the remote controller of the indoor unit is poor. (7) The transmission/reception circuit of the remote controller is defective. | (1) Check the transmission lines of the indoor unit and MA remote controller for disconnection and looseness. (2) Check the power supply to the main power and remote controller lines. (3) Check whether the tolerable range of the MA remote controller line is exceeded or not. (4) Check the main/slave setting of the MA remote controller. (5) Diagnose the remote controller. (Remote controller IM description) Result: [OK]: No problem in the remote controller (wiring specifications check) [NO]: Replace the remote controller |
| 6834 | MA Communication start bit error | 1. Communication between the MA remote controller and the indoor unit is not done properly. 2. No proper data has been received for 2 minutes. | (1) The remote control line of the MA remote controller or the indoor unit is in poor contact. (2) It is set on two or more main remote controllers. (3) The indoor unit address is set twice. (4) Noise enters the remote controller line. (5) The wiring specifications are not observed. 1. Wire length 2. Wire thickness 3. Number of remote controllers 4. Number of indoor units (6) The transmission/reception circuit of the remote controller is defective. | [6832, 6833, ERC]: Noise is the cause. < To (6) > (6) Check the transmission waveform and noise on the transmission signal of MA remote controller line. (7) If no problem is present in items. 1) to (6) above, replace the indoor controller board or MA remote controller. The following states can be checked from LED1 and LED2 on the indoor controller board. • LED1 is lit at the same time. The main power is supplied to the indoor unit. • LED2 alone is lit. Power is supplied to the MA remote controller line. |
| 6832 | MA Communication synchroniza- tion recovery error | 1. Communication between the MA remote controller and the indoor unit is not done properly. 2. When transmission is impossible because the emptiness of the transfer path cannot be checked. Indoor unit : 3 minutes Remote controller : 6 seconds | (1) The remote control line of the MA remote controller or the indoor unit is in poor contact. (2) It is set on two or more main remote controllers. (3) The indoor unit address is set twice. (4) Noise enters the remote controller line. (5) The wiring specifications are not observed. 1. Wire length 2. Wire thickness 3. Number of remote controllers 4. Number of indoor units (6) The transmission/reception circuit of the remote controller is defective. | [6832, 6833, ERC]: Noise is the cause. < To (6) > (6) Check the transmission waveform and noise on the transmission signal of MA remote controller line. (7) If no problem is present in items. 1) to (6) above, replace the indoor controller board or MA remote controller. The following states can be checked from LED1 and LED2 on the indoor controller board. • LED1 is lit at the same time. The main power is supplied to the indoor unit. • LED2 alone is lit. Power is supplied to the MA remote controller line. |
| 6833 | MA Communication transmission /reception hardware error | 1. Communication between the MA remote controller and the indoor unit is not done properly. 2. When the transmitted data is received at the same time and compared, the different state continues 30 times. | (1) The remote control line of the MA remote controller or the indoor unit is in poor contact. (2) It is set on two or more main remote controllers. (3) The indoor unit address is set twice. (4) Noise enters the remote controller line. (5) The wiring specifications are not observed. 1. Wire length 2. Wire thickness 3. Number of remote controllers 4. Number of indoor units (6) The transmission/reception circuit of the remote controller is defective. | [6832, 6833, ERC]: Noise is the cause. < To (6) > (6) Check the transmission waveform and noise on the transmission signal of MA remote controller line. (7) If no problem is present in items. 1) to (6) above, replace the indoor controller board or MA remote controller. The following states can be checked from LED1 and LED2 on the indoor controller board. • LED1 is lit at the same time. The main power is supplied to the indoor unit. • LED2 alone is lit. Power is supplied to the MA remote controller line. |

3. System error

| Checking code | Meaning, detecting method | Cause | Checking method & Countermeasure | | | | | | | | | | | | | | | | | | |
|---|---|---|--|-----------------|---------------------------------|--|-----------------------------|-----------------------|----------------------------------|-----|---------------------------------|-----------|---|--------|--|-----|-----------|-----|-----------|-----|---|
| 7100 | <p>Total capacity abnormality</p> <p>Total capacity of indoor units in the same refrigerant system exceeds limitations.</p> <p>Trouble source : Heat source unit</p> | <p>(1) Total capacity of indoor units in the same refrigerant system exceeds the following:</p> <table border="1"> <thead> <tr> <th>Model</th> <th>Total capacity</th> </tr> </thead> <tbody> <tr> <td>PQRY-P200</td> <td>300</td> </tr> <tr> <td>PQRY-P250</td> <td>375</td> </tr> <tr> <td>PQRY-P400</td> <td>600</td> </tr> <tr> <td>PQRY-P500</td> <td>750</td> </tr> <tr> <td>PQHY-P200</td> <td>260</td> </tr> <tr> <td>PQHY-P250</td> <td>325</td> </tr> <tr> <td>PQHY-P400</td> <td>520</td> </tr> <tr> <td>PQHY-P500</td> <td>650</td> </tr> </tbody> </table> | Model | Total capacity | PQRY-P200 | 300 | PQRY-P250 | 375 | PQRY-P400 | 600 | PQRY-P500 | 750 | PQHY-P200 | 260 | PQHY-P250 | 325 | PQHY-P400 | 520 | PQHY-P500 | 650 | <p>(a) Check for the model total (capacity cord total) of indoor units connected.</p> <p>(b) Check whether indoor unit capacity code (SW2) is wrongly set.</p> <p>For erroneous switch setting, modify it, turn off power source of heat source unit, and indoor unit simultaneously for 5 minutes or more to modify the switch for setting the model name (capacity code).</p> |
| Model | Total capacity | | | | | | | | | | | | | | | | | | | | |
| PQRY-P200 | 300 | | | | | | | | | | | | | | | | | | | | |
| PQRY-P250 | 375 | | | | | | | | | | | | | | | | | | | | |
| PQRY-P400 | 600 | | | | | | | | | | | | | | | | | | | | |
| PQRY-P500 | 750 | | | | | | | | | | | | | | | | | | | | |
| PQHY-P200 | 260 | | | | | | | | | | | | | | | | | | | | |
| PQHY-P250 | 325 | | | | | | | | | | | | | | | | | | | | |
| PQHY-P400 | 520 | | | | | | | | | | | | | | | | | | | | |
| PQHY-P500 | 650 | | | | | | | | | | | | | | | | | | | | |
| 7101 | <p>Capacity code abnormality</p> <p>Error display at erroneous connection of Indoor unit of which model name can not be connected.</p> <p>Trouble source : Heat source unit Indoor unit</p> | <p>(1) The Indoor unit model name (model code) connected is not connectable. Connectable range : 20 ~ 250</p> <p>(2) Erroneous setting of the switch (SW2) for setting of model name of indoor unit connected.</p> | <p>(a) Check for the model name of the Indoor unit connected.</p> <p>(b) Check for the switch (SW2 if indoor controller for setting of Indoor unit model name of generating address. When it is not agreed to the model name, modify the capacity code while shutting off the power source of Indoor unit. ※ The capacity of Indoor unit can be confirmed by the self-diagnosis function (SW1 operation) of indoor unit.</p> | | | | | | | | | | | | | | | | | | |
| 7102 | <p>Error in the number of connected units</p> <p>Number of units connected in the same refrigerant system exceeds limitations.</p> <p>Trouble source: Heat source unit</p> | <p>(1) Number of unit connected to terminal block (TB3) for outdoor/indoor transmission line exceeds limitations given below:</p> <table border="1"> <thead> <tr> <th>Item</th> <th>Number of units</th> </tr> </thead> <tbody> <tr> <td>1) Total number of indoor units</td> <td>PQRY-P200:1~15 PQRY-P250:1~19 PQRY-P400:1~24 PQRY-P500:1~24 PQHY-P200:1~13 PQHY-P250:1~16 PQHY-P400:1~22 PQHY-P500:1~24</td> </tr> <tr> <td>2) Number of BC controllers</td> <td>1 (P200,P250 only)</td> </tr> <tr> <td>3) Number of Main BC controllers</td> <td>1</td> </tr> <tr> <td>4) Number of Sub BC controllers</td> <td>0, 1 or 2</td> </tr> <tr> <td>5) Number of LOSSNAY units (Only when the free address is set.)</td> <td>0 or 1</td> </tr> </tbody> </table> <p>(2) Disconnection of transmission wiring at heat source unit.</p> <p>(3) Short circuit of transmission line in case of (2) and (3), remote controller displays "HO".</p> | Item | Number of units | 1) Total number of indoor units | PQRY-P200:1~15 PQRY-P250:1~19 PQRY-P400:1~24 PQRY-P500:1~24 PQHY-P200:1~13 PQHY-P250:1~16 PQHY-P400:1~22 PQHY-P500:1~24 | 2) Number of BC controllers | 1 (P200,P250 only) | 3) Number of Main BC controllers | 1 | 4) Number of Sub BC controllers | 0, 1 or 2 | 5) Number of LOSSNAY units (Only when the free address is set.) | 0 or 1 | <p>(a) Check whether the connection of units to the terminal block for indoor/outdoor transmission wiring (TB3) of heat source unit is not exceeding the limitation. (See (1) ~ (2) left.)</p> <p>(b) Check for (2), (3), and (4).</p> <p>(c) Check for the connection of the transmission wiring to the terminal block for centralized control is erroneously connected to the indoor/outdoor transmission wiring terminal block (TB3).</p> <p>(d) Check for the model total (capacity code total) of indoor units connected.</p> | | | | | | |
| Item | Number of units | | | | | | | | | | | | | | | | | | | | |
| 1) Total number of indoor units | PQRY-P200:1~15 PQRY-P250:1~19 PQRY-P400:1~24 PQRY-P500:1~24 PQHY-P200:1~13 PQHY-P250:1~16 PQHY-P400:1~22 PQHY-P500:1~24 | | | | | | | | | | | | | | | | | | | | |
| 2) Number of BC controllers | 1 (P200,P250 only) | | | | | | | | | | | | | | | | | | | | |
| 3) Number of Main BC controllers | 1 | | | | | | | | | | | | | | | | | | | | |
| 4) Number of Sub BC controllers | 0, 1 or 2 | | | | | | | | | | | | | | | | | | | | |
| 5) Number of LOSSNAY units (Only when the free address is set.) | 0 or 1 | | | | | | | | | | | | | | | | | | | | |
| 7105 | <p>Address setting error</p> <ul style="list-style-type: none"> • Erroneous setting of OC unit address • Erroneous setting of BC controller address <p>Trouble source : Heat source unit BC controller</p> | <p>(1) Setting error of heat source unit address. The address of heat source unit is not being set to 51~100.</p> <p>(2) The address of BC controller is not being set within 51~100.</p> | <p>Check that the address of OC unit is being set to 51~100. Reset the address if it stays out of the range, while shutting the power source off.</p> <p>When BC controller is out of the range, reset it while shutting the power source of both OC unit and BCcontroller off.</p> | | | | | | | | | | | | | | | | | | |

| Checking code | Meaning, detecting method | Cause | Checking method & Countermeasure | | | | | | |
|-------------------|---|--|----------------------------------|-------------------|------------------|-----|------------------|-----|---|
| 7107 | <p>Branch port setting error</p> <p>Branch port No. setting of the indoor unit is wrong. Total type number per each branch port is greater than the specification.</p> | <p>(1) Total type number of the indoor unit per each branch port or per each merge port is greater than the specification.</p> <table border="1" data-bbox="721 347 1027 443"> <thead> <tr> <th>Total port number</th> <th>Total type number</th> </tr> </thead> <tbody> <tr> <td>Single branching</td> <td>140</td> </tr> <tr> <td>2 branches merge</td> <td>250</td> </tr> </tbody> </table> <p>(2) Single branching setting is made on 4 or more indoor units. (3) When multiple branches merge, the smallest number is not set on the branch port. (4) For the address of the BC controller (Sub 1 or 2), 50 is not added to the smallest address of the indoor unit, which is connected to the BC controller (Sub1 or 2). (5) Under the multiple BC controllers connection system, the address of the indoor unit, which is connected to the BC controller, is not set as shown below.</p> <p>① The address of the indoor unit which is connected to the BC controller (main) ② The address of the indoor unit which is connected to the BC controller (Sub1) ③ The address of the indoor unit which is connected to the BC controller (Sub2)</p> <p>Address setting ① < ② < ③ *:② and ③ can be reversed.</p> | Total port number | Total type number | Single branching | 140 | 2 branches merge | 250 | <p>Before resetting the branch port setting switch or the type (capacity code) setting switch, turn off the power of the heat source unit, the BC controller and the indoor unit.</p> |
| Total port number | Total type number | | | | | | | | |
| Single branching | 140 | | | | | | | | |
| 2 branches merge | 250 | | | | | | | | |
| | | | | | | | | | |

| Checking code | Meaning, detecting method | Cause | Checking method & Countermeasure |
|---------------|---|--|--|
| 7110 | Connection number setting abnormality | (1) Transmission booster is faulty. (2) Power supply of transmission booster has been cut. | Check transmission booster and power supply. |
| 7111 | Remote control sensor abnormality Error not providing the temperature designed to remote controller sensor. Trouble source : Indoor unit | (1) The remote controller without the temperature sensor (the wireless remote controller or the M-NET compact remote controller (mounted type)) is used and the remote controller sensor for the indoor unit is specified. (SW1-1 is ON.) | (a) Replace the remote controller with the one with built-in temperature sensor. |
| 7113 | Functional restriction error | Disconnection of plug on main board. | Check all main board connectors and rectify faulty connection. |
| 7116 | System error before flashing operation The refrigerant pipe has not been washed. | The model-switching switch (SW4-3) is set wrong. It is set to Replace MULTI. | Check that the SW4-3 on the main board is OFF. |
| 7117 | Unset model error | Faulty wiring Disconnected connector, shorting, or contact failure. | Check for the contact of the connector CNTYP1, 4, 5 on the main board. Check the record of CNTYP1, 4, 5. |
| 7130 | Different unit model error The check code will appear when the indoor units with different refrigerant systems are connected. | The indoor unit that uses only R22 or only R407C refrigerant is connected. The wrong unit model is connected. When connecting the slim model (A control) with M-NET, the connection adapter for M-NET is connected to the indoor unit. | Check the connected indoor unit model. Check whether the connecting adapter for M-NET is not connected to the indoor unit. (Connect the connecting adapter for M-NET to the heat source unit.) |

4. Trouble shooting according to the remote controller malfunction and the external input error

(1) In the case of MA remote controller

| | Phenomena | Factors | Check method & Handling |
|---|---|--|--|
| 1 | <p>Even if the operation SW on the remote controller is pressed, the display remains unlit and the unit does not start running.</p> <p>(Power indicator ● does not appear on the screen.)</p> | <p>(1) The power for the indoor unit is not on.</p> <p>① The power of the indoor unit is OFF.</p> <p>② The connector on the indoor unit controller board has come off.</p> <p>③ The fuse on the indoor unit controller board has melted.</p> <p>④ Transformer failure and disconnected wire of the indoor unit</p> <p>(2) The wire for the MA remote controller is connected incorrectly.</p> <p>① Disconnected wire for the MA remote controller and disconnected line to the terminal block.</p> <p>② Short circuit of the wire for the MA remote controller</p> <p>③ The wire for the MA remote controller is connected incorrectly to the terminal block for the transmission line (TB5).</p> <p>④ Reversed connection between the wire for the MA remote controller and the power-supply wire for AC220~240V.</p> <p>⑤ Reversed connection inside the indoor unit between the wire for the MA remote controller and the M-NET transmission line.</p> <p>(3) The number of the MA remote controllers that are connected to an indoor unit exceeds the allowable range (2 units).</p> <p>(4) The length and the diameter of the wire for MA remote controller are out of specification.</p> <p>(5) Short circuit of the wire for the remote display output for the heat source unit or reversed polarity connection of the relay.</p> <p>(6) Indoor unit controller board failure</p> <p>(7) MA remote controller failure</p> | <p>(a) Check voltage of the MA remote controller terminal (among ① to ③).</p> <p>i) If the voltage is DC8.5-12V, the remote controller is defective.</p> <p>ii) If there is no voltage Check the left described (1) and (3). If a fault is found, handle the problem. If no fault is found, refer to (b).</p> <p>(b) Remove the wire for the remote controller from the terminal block (TB13) on the MA remote controller for the indoor unit, and check voltage among ① to ③.</p> <p>i) If the voltage is DC8.5-12V Check the left described (2) and (4). If a fault is found, handle the problem.</p> <p>ii) If there is no voltage Check the left described (1) again. If a fault is found, handle the problem. If no fault is found, check the wire for the remote display output (the relay polarity). If no further fault is found, replace the indoor controller board.</p> |

| | Phenomena | Factors | Check method & Handling |
|---|---|---|---|
| 2 | When turning on the remote controller operation SW, a temporary operation display is indicated, and the display lights out immediately, and the unit stops. | <p>(1) The power for the M-NET transmission line is not supplied from the heat source unit.</p> <p>(2) Short circuit of the transmission line.</p> <p>(3) Incorrect wiring of the M-NET transmission line on the heat source unit side.</p> <p>① Disconnected wire for the MA remote controller and disconnected line to the terminal block.</p> <p>② The indoor transmission line is connected incorrectly to terminal block (TB7) to the transmission line for centralized control.</p> <p>③ The power supply connectors (CN40) for multiple heat source units are inserted.</p> <p>Or the power supply connector (CN40) for heat source unit is inserted in the system to which the power supply unit for transmission line is connected.</p> <p>(4) Disconnected M-NET transmission line on the indoor unit side.</p> <p>(5) Disconnected wire between terminal block (TB5) to the M-NET transmission line of the indoor unit and the indoor controller board (CN2M) or disconnected connector.</p> | <div style="border: 1px solid black; padding: 5px; width: fit-content;"> <p>When the factor (2) and (3) apply, self-diagnosis LED works and the check code 7102 will be displayed.</p> </div> |

Check method & Handling

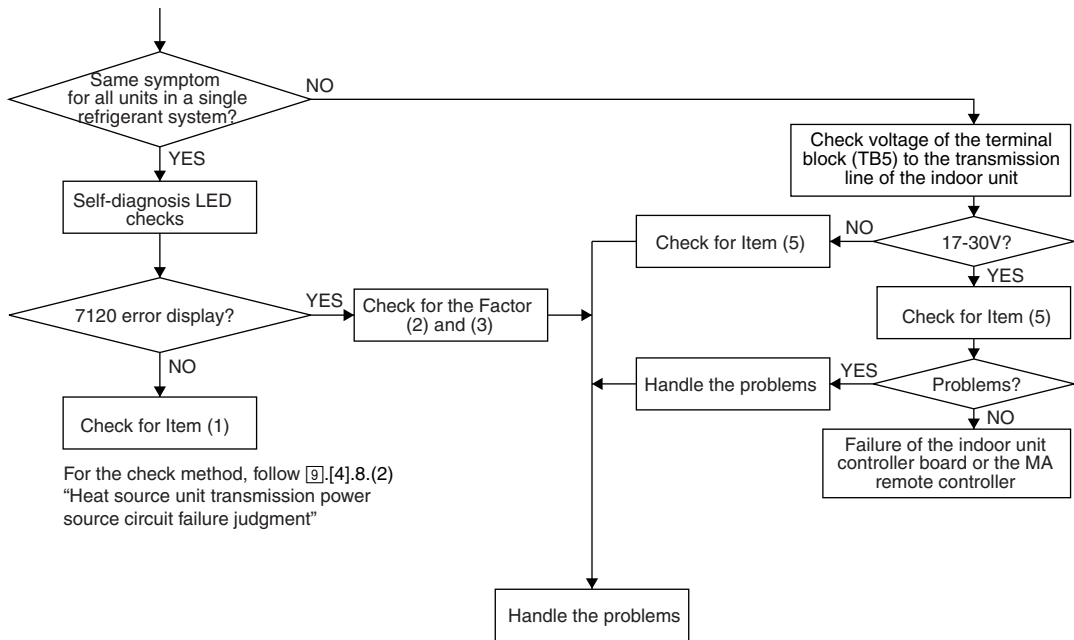

| | Phenomena | Factors |
|---|---|---|
| 3 | <p>“HO” display on the remote controller does not turn off, and the switch does not work.</p> <p>(“HO” display turn off 3 minutes later, after turning the power on.)</p> | <p>(1) The power for the M-NET transmission line is not supplied from the heat source unit.</p> <p>(2) Short circuit of the transmission line.</p> <p>(3) Incorrect wiring of the M-NET transmission line on the heat source unit side.</p> <p>① Disconnected wire for the MA remote controller and disconnected line to the terminal block.</p> <p>② The indoor transmission line is connected incorrectly to terminal block (TB7) to the transmission line for centralized control.</p> <p>③ The power supply connectors (CN40) for multiple heat source units are inserted. Or the power supply connector (CN40) for heat source unit is inserted in the system to which the power supply unit for transmission line is connected.</p> <p>(4) Disconnected M-NET transmission line on the indoor unit side.</p> <p>(5) Disconnected wire between terminal block (TB5) to the M-NET transmission line of the indoor unit and the indoor controller board (CN2M) or disconnected connector.</p> <p>(6) The wire for the MA remote controller is connected incorrectly.</p> <p>① Short circuit of the wire for the MA remote controller.</p> <p>② Disconnected wire for the MA remote controller (No.2) and disconnected line to the terminal block.</p> <p>③ Reversed connection under group control.</p> <p>④ The wire for the MA remote controller is connected incorrectly to the terminal block to the transmission line (TB5).</p> <p>⑤ The M-NET transmission line is connected incorrectly to the terminal block (TB13) on the MA remote controller.</p> <p>(7) The sub/main setting of the MA remote controller is set to sub.</p> <p>(8) More than 2 main MA remote controllers are connected.</p> <p>(9) Indoor unit controller board failure (MA remote controller communication line)</p> <p>(10) Remote controller failure.</p> |

When the factor (2) and (3) apply, self-diagnosis LED works and the check code 7102 will be displayed.

Check method & Handling

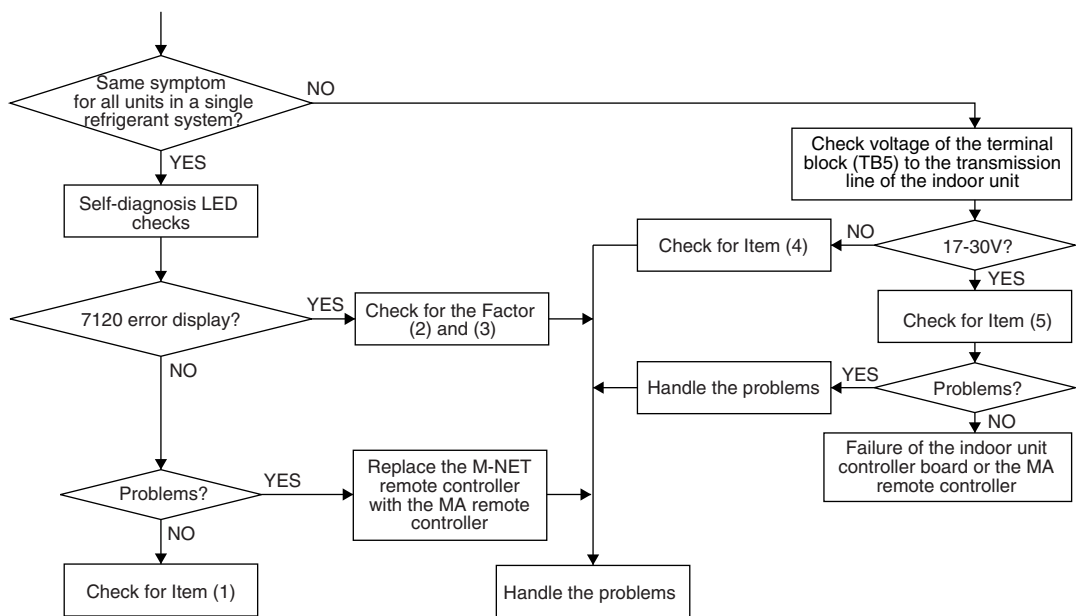

For the check method, follow [9].[4].8.(2)
“Heat source unit transmission power source circuit failure judgment”

(2) In the case of the M-NET remote controller

| | Phenomena | Factors | Check method & Handling |
|---|---|---|---|
| 1 | <p>Even if the operation SW on the remote controller is pressed, the display remains unlit and the unit does not start running.</p> <p>(Power indicator ● does not appear on the screen.)</p> | <p>(1) The power for the M-NET transmission line is not supplied from the heat source unit.</p> <p>(2) Short circuit of the transmission line</p> <p>(3) Incorrect wiring of the M-NET transmission line on the heat source unit side.</p> <p>① Disconnected wire for the MA remote controller and disconnected line to the terminal block.</p> <p>② The indoor transmission line is connected incorrectly to terminal block (TB7) to the transmission line for centralized control.</p> <p>(4) Disconnected transmission line on the remote controller side</p> <p>(5) Remote controller failure</p> | <p>(a) Check voltage of the M-NET remote controller transmission terminal.</p> <p>i) If the voltage is 17V-30V →The M-NET remote controller is defective.</p> <p>ii) If there is 17V or less →Refer to [9].[4].8.(2) "Heat source unit transmission power source circuit failure judgment".</p> <div style="border: 1px solid black; padding: 5px; margin-top: 10px;"> <p>When the factor (2) and (3) apply, self-diagnosis LED of the heat source unit works and the check code 7102 will be displayed.</p> </div> |
| 2 | <p>When turning on the remote controller operation SW, a temporary operation display is indicated, and the display lights out immediately.</p> | <p>(1) The power for the indoor unit is not on.</p> <p>① The main power of the indoor unit (AC220~240V) is OFF.</p> <p>② The connector on the indoor unit controller board has come off.</p> <p>③ The fuse on the indoor unit controller board has melted.</p> <p>④ Transformer failure and disconnected wire of the indoor unit.</p> <p>⑤ The indoor controller board failure.</p> <p>(2) The main board of the indoor and the heat source unit failure As the indoor unit does not interact with the heat source unit, the heat source unit model cannot be recognized.</p> | |

Check method & Handling

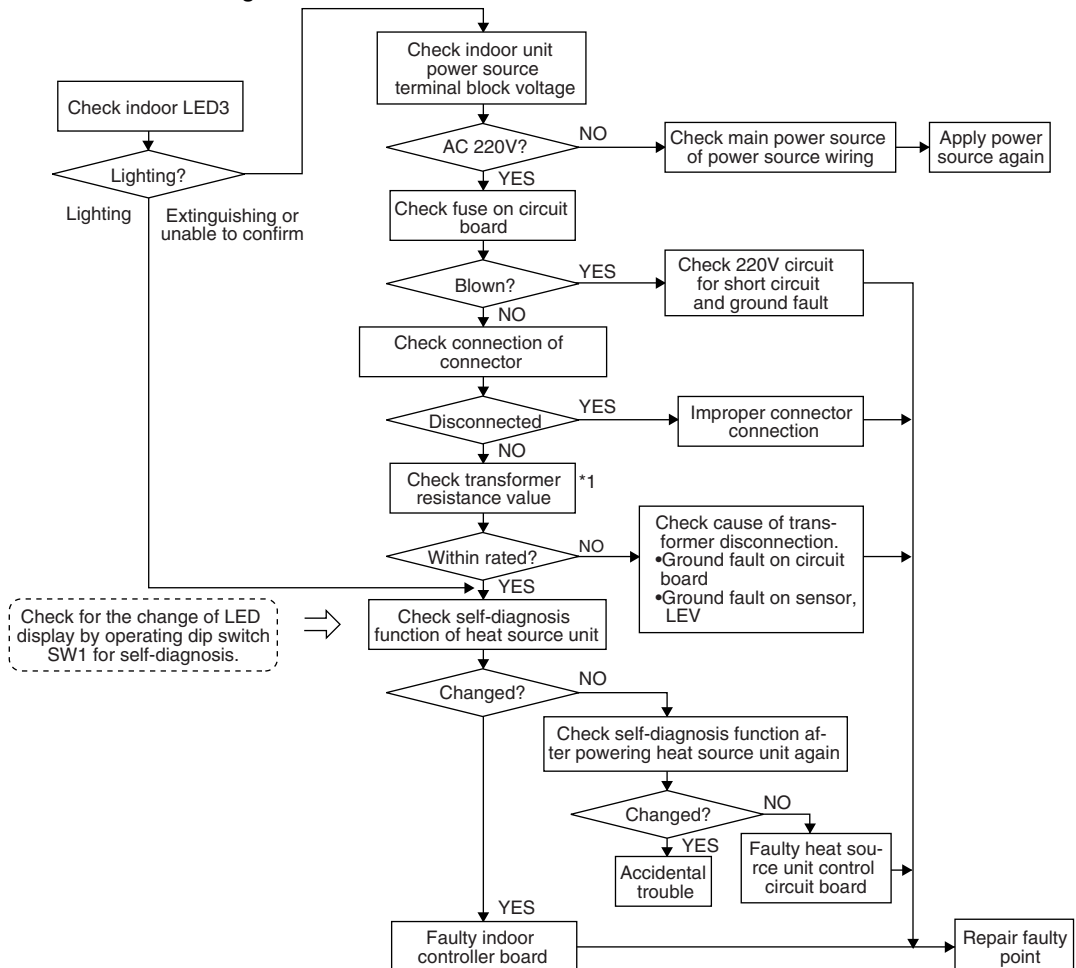

*1 Check the transformer in accordance with the "TROUBLESHOOTING" in the indoor unit's service handbook.

| | Phenomena | Factors |
|---|---|---|
| 3 | <p>“HO” display on remote controller does not disappear and ON/OFF switch is ineffective.</p> | <p>(Without using MELANS)</p> <p>(1) Heat source unit address is set to “00”</p> <p>(2) Erroneous address.</p> <p>① Address setting of indoor unit to be coupled with remote controller incorrect. (Indoor unit = remote controller – 100.)</p> <p>② Address setting of remote controller incorrect. (Remote controller = indoor unit + 100.)</p> <p>(3) Faulty wiring of transmission terminal block TB5 of indoor unit in the same group with remote controller.</p> <p>(4) Centralized control SW2-1 of heat source unit is turned ON.</p> <p>(5) Disconnection or faulty wiring of indoor unit transmission line.</p> <p>(6) Disconnection between indoor unit M-NET transmission line terminal block (TB5) and connector CN2M.</p> <p>(7) More than 2 sets of power supply connector (CN40) are inserted into centralized control transmission line of heat source unit.</p> <p>(8) M-NET remote controller is connected to the terminal block of MA remote controller.</p> <p>(9) Faulty heat source unit control circuit board.</p> <p>(10) Faulty indoor controller board.</p> <p>(11) Faulty remote controller.</p> <p>(Interlocking control with MELANS)</p> <p>(12) No grouping registration from MELANS (Neglecting to set the relation between indoor unit and network remote controller).</p> <p>(13) Disconnection of centralized control transmission line (TB7) at heat source unit.</p> <p>(14) Power supply connectors (CN40) of Multiple heat source units are inserted into transmission lines. Or in the system to which power supply unit for transmission line, power supply of the heat source unit (CN40) is inserted into transmission line.</p> |

Check method & Handling

In case MELANS is not used

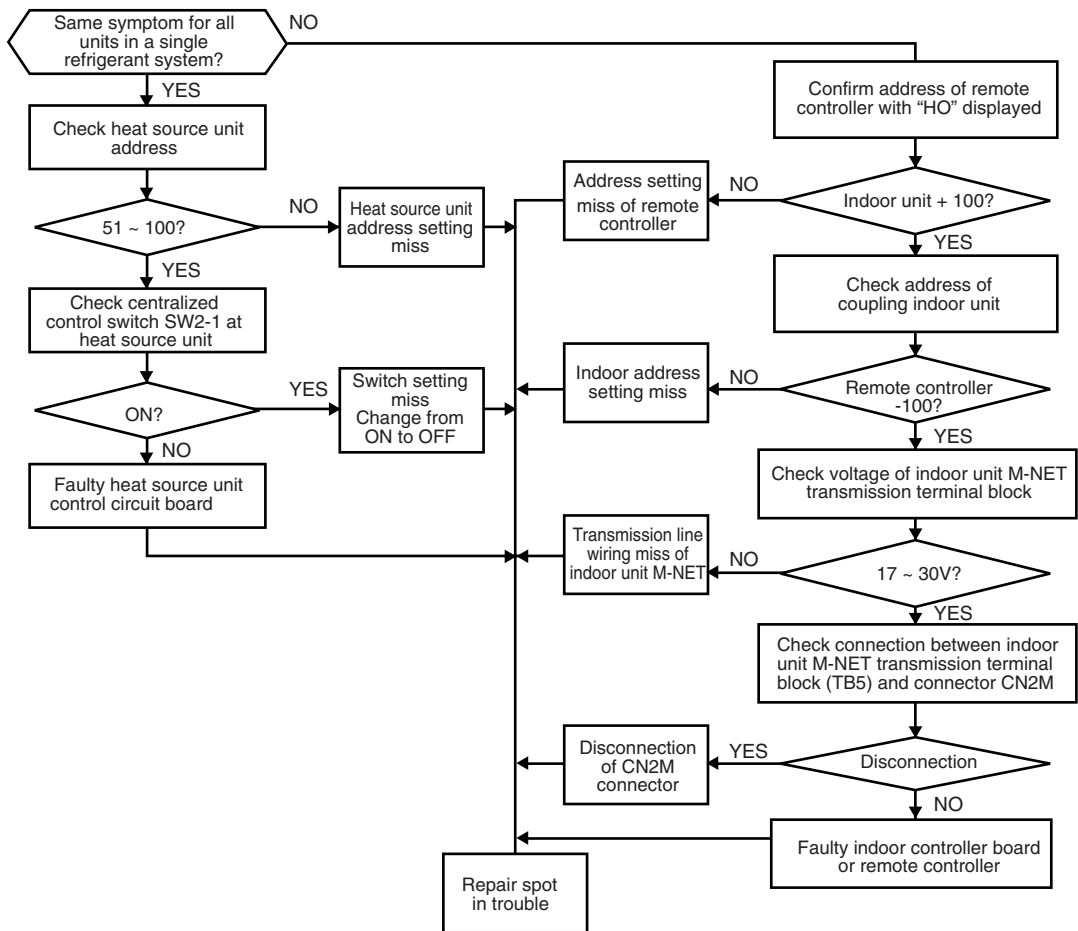









In case with MELANS used

When MELANS is used, “HO” display on the remote controller will disappear at the group registration of the indoor unit and local remote controller. If “HO” does not disappear after the registration, check the items (11) ~ (13) in the Factors column.

| | Phenomena | Factors | Check method & Handling |
|---|---|--|---|
| 4 | "88" appears on remote controller at registration and access remote controller. | (Generates at registration and confirmation) (1) Erroneous address of unit to be coupled. (2) Disconnection of transmission line of unit to be coupled (No connection). (3) Faulty circuit board of unit to be coupled. (4) Installation miss of transmission line. | (a) Confirm the address of unit to be coupled. (b) Check the connection of transmission line. (c) Check the transmission terminal block voltage of unit to be coupled. i) Normal if voltage is DC17 ~ 30V. ii) Check the item d) in case other than i). |
| | | (Generates at interlocking registration between LOSSNAY and the indoor unit) (5) The power of LOSSNAY is OFF. | (d) Check for the main power of LOSSNAY. |
| | | (Confirmation of different refrigerant system controller) (6) Disconnection of power source of heat source unit to be confirmed. (7) Disconnection of centralized control transmission line (TB7) of heat source unit. (8) Power supply connector (CN40) is not inserted into centralized control transmission line in grouping with different refrigerant system without using MELANS. (9) More than 2 sets of power supply connector are inserted into the centralized control transmission line of heat source unit. (10) In the system connected with MELANS, power supply connector (CN40) is inserted into the centralized control transmission line of heat source unit. (11) Short circuit of centralized control transmission line. | (e) Confirm the power source of heat source unit to be coupled with the unit to be confirmed. (f) Confirm that the centralized control transmission line (TB7) of heat source unit is not disconnection. (g) Confirm the voltage of centralized control transmission line. i) Normal in case of 10V ~ 30V. ii) Check the items (8) ~ (11) left in case other than i). |

(3) Both for MA remote controller and M-NET remote controller

| | Phenomena | Factors | Check method & Handling |
|---|---|--|--|
| 1 | Cooling with normal remote controller display but not providing capacity. | <p>(1) Insufficient frequency rise</p> <ul style="list-style-type: none"> ① Faulty detection of pressure sensor. ② Higher discharge temperature exceeding frequency limit. ③ Higher high pressure exceeding frequency limit. ④ Low pressure excessively lowered. | <p>(a) Observe difference between sensor detected pressure and actual pressure by monitoring with LED. →At abnormal intake, check the pressure sensor. (Refer to Troubleshooting of Pressure Sensor).</p> <p>Note: Lower intake of low pressure sensor than actual pressure causes insufficient capacity.</p> <p>SW1 setting High pressure sensor</p>  <p>ON</p> <p>Low pressure sensor</p>  <p>ON</p> <p>(b) Observe difference between evaporating temperature (Te) and target evaporating temperature (Tem) by monitoring with LED.</p> <p>Note: Higher Te than Tem causes insufficient capacity.</p> <p>SW1 setting Evaporating temperature Te</p>  <p>ON</p> <p>Target evaporating temperature Tem</p>  <p>ON</p> <p>Note: When frequency does not rise even at higher Te than Tem, frequency restriction by discharge temperature or high pressure may be affected. At high discharge temperature →Refer to 1102 At high pressure →Refer to 1302</p> |
| | | <p>(2) Faulty action of indoor unit LEV</p> <ul style="list-style-type: none"> ① Faulty action of indoor unit LEV does not allow sufficient flow rate. Frequency does not rise due to lowered low pressure. ② Leaking LEV of stopping unit lowers flow rate of operating unit. | Refer to the page of LEV troubleshooting ([9].[4].6) |
| | | <p>(3) Abnormal speed of heat source unit fan</p> <ul style="list-style-type: none"> ① Faulty motor or board, or heat exchanger clogging lowers airflow rate. ② Faulty temperature intake of OA sensor causes fan control malfunction. ③ Faulty intake of pressure sensor causes fan control malfunction. | Refer to the page of heat source unit fan troubleshooting. Refer to the page of 5106. Refer to the page of 1302. |
| | | <p>(4) Long piping length Pressure loss degree at pressure side varies cooling capacity greatly.</p> | Check the characteristic of capacity decrease by piping length. Piping pressure loss is assumable by temperature difference between heat exchanger outlet temperature of indoor unit and OC evaporation temp. (Te). →Modify piping. |
| | | <p>(5) Piping size is not proper (slender)</p> | |
| | | <p>(6) Insufficient refrigerant volume Discharge temperature rises while</p> | Refer to Item 1-(1) (Frequency does not rise sufficiently.) Refer to Item Refrigerant volume adjustment. |

| | Phenomena | Factors | Check method & Handling |
|---|---|--|--|
| 1 | Cooling with normal remote controller display but not providing capacity. | (7) Clogging by foreign matter | Check temperature difference between before and after a portion (strainer, distributor) of low pressure piping where foreign matter may likely be clogged. Significant temperature drop may indicate clogging. →Remove foreign matter inside piping. |
| | | (8) Indoor unit inlet temperature excessively low (Less than 15°C wet bulb) | Check inlet temperature and short cycle at indoor unit side. To improve using manner |
| | | (9) Faulty compressing Leaking inside compressor lowers refrigerant circulation volume. | As leaking if existed increases discharge temperature, judge by measuring the temperature. |
| | | (10) Faulty action of LEV1 As sufficient sub-cooling can not be kept at heat source unit outlet due to faulty LEV1 action, refrigerant is difficult to flow at indoor unit. | Refer to page of LEV troubleshooting ([9].[4].6) High possibility at little or no difference between TH5 and TH7 |
| | | (11) Faulty TH5, TH7, HPS sensor, erroneous wiring. No normal control of LEV1 | a) Check thermistor. b) Check wiring. |
| 2 | Heating with normal remote controller display but not providing capacity. | (1) Insufficient frequency rise ① Faulty detection of pressure sensor ② Higher discharge temperature exceeding frequency limit ③ Higher high pressure exceeding frequency limit | a) Observe difference between sensor detected pressure and actual pressure by monitoring with LED. →At abnormal intake, check the pressure sensor. (Refer to Troubleshooting of Pressure Sensor Note: Higher intake of high pressure sensor than actual pressure causes insufficient capacity. SW1 setting High pressure sensor  Low pressure sensor  (b) Observe difference between condensing temperature (Tc) and target condensing temperature (Tcm) by monitoring with LED. Note: Higher Te than Tem causes insufficient capacity. SW1 setting Condensing temperature Tc  Target condensing temperature Tcm  Note: When frequency does not rise even at lower Tc than Tcm, frequency restriction by discharge temperature or high pressure may be affected. At high discharge temperature →Refer to 1102 At high pressure →Refer to 1302 |
| | | (2) Faulty action of indoor unit LEV Faulty action of indoor unit LEV does not allow sufficient flow rate. | Refer to the page of LEV troubleshooting. |

| | Phenomena | Factors | Check method & Handling |
|--|---|--|---|
| 2 | Heating with normal remote controller display but not providing capacity. | (3) When abnormal temperature of indoor unit piping temperature sensor is taken higher, LEV is throttled excessively due to apparent small sub-cooling. | Check piping thermistor. |
| | | (4) Abnormal speed of heat source unit fan ① Faulty motor or board, or heat exchanger clogging lowers airflow rate. This lowers airflow rate and low pressure leading to increase discharge temperature. ② Faulty temperature intake of piping sensor causes fan control malfunction. | Refer to the page of heat source unit fan. |
| | | (5) Faulty insulation of refrigerant piping | |
| | | (6) Long piping length Excessively long piping length at high pressure side causes high pressure loss leading to decrease in high pressure. | Check the characteristic of capacity decrease by piping length. →Modify piping Check pressure difference between before and after a portion (strainer, distributor) of high pressure (gas) piping where foreign matter may likely be clogged. Difficult to confirm clogging inside extended piping. Check clogging in the same manner in cooling by operating under cooling cycle. →Remove foreign matter |
| | | (7) Piping size is not proper (slender) (8) Clogging by foreign matter | |
| | | (9) Indoor unit inlet temperature excessively high (exceeding 28°C) | Check inlet temperature and short cycle at indoor unit side. To improve using manner |
| | | (10) Insufficient refrigerant volume Discharge temperature drops while frequency does not rise. Likely to enter refrigerant recovery operation. | Refer to Item 2-(1). (Insufficient frequency rise) Refer to Item Refrigerant volume adjustment. |
| (11) Faulty compressing (as same in case of cooling) | Check discharge temperature. | | |
| 3 | | <p>As a previous step to apply emergency stop under error mode, the first detection will not be applied with emergency stop as it is stopping under the 3 minutes restart prevention mode as an intermittent fault checking.</p> <ul style="list-style-type: none"> ① High pressure error ② Discharge temperature error ③ Radiator panel thermistor error ④ Thermistor error ⑤ Pressure sensor error ⑥ Overcurrent shutout ⑦ Refrigerant over charge error <p>Notes: 1. Freeze protection tripping only under cooling mode may be considered in addition to the above. (Freeze protection is detected by one or all indoor units.) 2. With some error codes, emergency stop is not commenced even at the second stopping.</p> | <p>(a) Check the mode operated in the past by displaying intermittent fault check history by LED display with SW1.</p> <p>(b) Check the mode for stopping through the operation reproduced displaying intermittent fault checking by LED display with SW1.</p> <p style="text-align: center;">↓</p> <p>For each error mode, refer to the relating page. * When checking freeze protection tripping, set SW1 to the status displaying indoor piping temperature table (Chapter 10) to confirm the temperature.</p> |

[3] Investigation of Transmission Wave Shape/Noise

1. M-NET transmission

Control is performed by exchanging signals between heat source unit, indoor unit and remote controller by M-NET transmission. If noise should enter into the transmission line, the normal transmission will be hindered causing erroneous operation.

(1) Symptom caused by the noise entered into transmission line

| Cause | Erroneous operation | Error code |
|--------------------------------------|---|--------------|
| Noise entered into transmission line | Signal changes and is misjudged as the signal of other address. | 6600 |
| | Transmission wave shape changes to other signal due to noise. | 6602 |
| | Transmission wave shape changes due to noise, and can not be received normally thus providing no reply (ACK). | 6607 |
| | Transmission can not be made continuously due to the entry of fine noise. | 6603 |
| | Transmission can be made normally, but reply (ACK) or answer can not be issued normally due to noise. | 6607 6608 |

(2) Method to confirm wave shape

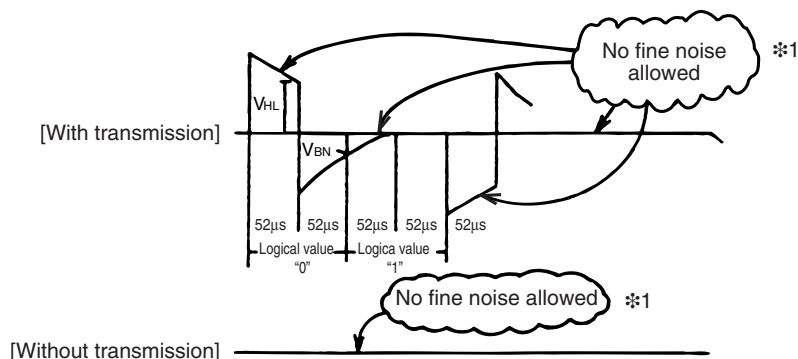

Check the wave shape of transmission line with an oscilloscope to confirm that the following conditions are being satisfied.

- 1) The figure should be $104\mu\text{s}/\text{bit} \pm 1\%$.
- 2) No finer wave shape (noise) than the transmission signal ($52\mu\text{s} \pm 1\%$) should be allowed. **:1
- 3) The sectional voltage level of transmission signal should be as follows.

| Logic value | Transmission line voltage level |
|-------------|---------------------------------|
| 0 | $V_{HL} = 2.0\text{V}$ or more |
| 1 | $V_{BN} = 1.3\text{V}$ or less |

**:1 However, minute noise from the DC-DC converter or inverter operation may be picked up.

(3) Checking and measures to be taken

(a) Measures against noise

Check the items below when noise can be confirmed on wave shape or the error code in the item (1) is generated.

| | Items to be checked | Measures to be taken |
|----------------------------|--|---|
| Checking for wiring method | (1) Wiring of transmission and power lines in crossing. | Isolate transmission line from power line (5cm or more). Never put them in a same conduit. |
| | (2) Wiring of transmission line with that of other system in bundle. | Wire transmission line isolating from other transmission line. Wiring in bundle may cause erroneous operation like crosstalk. |
| | (3) Use of shield wire for transmission line (for both indoor unit control and centralized control). | Use specified transmission wire. Type : Shield line CVVS/CPEVS Wire diameter : 1.25mm ² or more |
| | (4) Repeating of shield at the repeating of transmission line with indoor unit. | The transmission line is wired with 2-jumper system. Wire the shield with jumper system as same for transmission line. When the jumper wiring is not applied to the shield, the effect against noise will be reduced. |
| | (5) Are the unit and transmission lines grounded as instructed in the INSTALLATION MANUAL? | Connect to ground as shown in the INSTALLATION MANUAL. |
| Check for earthing | (6) Earthing of the shield of transmission line (for indoor unit control) to heat source unit. | One point earthing should be made at heat source unit. Without earthing, transmission signal may be changed as the noise on the transmission line has no way to escape. |
| | (7) Arrangement for the shield of transmission line (for centralized control). | For the shield earth of the transmission line for centralized control, the effect of noise can be minimized if it is from one of the heat source units incase of the group operation with different refrigerant systems, and from the upper rank controller in case the upper rank controller is used. However, the environment against noise such as the distance of transmission line, the number of connecting sets, the type of connecting controller, and the place of installation, is different for the wiring for centralized control. Therefore, the state of the work should be checked as follows. a) No earthing • Group operation with different refrigerant systems One point earthing at heat source unit • Upper rank controller is used Earthing at the upper rank controller b) Error is generated even though one point earth is being connected. Earth shield at all heat source units Connect to ground as shown in the user's manual. |

(b) When the wave height value of transmission wave shape is low, 6607 error is generated, or remote controller is under the state of "HO."

| | Items to be checked | Measures to be taken |
|--|--|---|
| | (8) The farthest distance of transmission line is exceeding 200m. | Confirm that the farthest distance from heat source unit to indoor unit/ remote controller is less than 200m |
| | (9) The types of transmission lines are different. | Use the transmission wire specified. Type of transmission line : Shield wire CVVS/CPEVS Wire dia. of transmission line : 1.25mm ² or more |
| | (10) No transmission power (30V) is being supplied to the indoor unit or the remote control. | a) Check 30V on CNS1, CNS2. b) Remove CNS1 and CNS2 and check resistance is 5-2, 6-2, if not this is a fault. Check main board R3 resistance is 1kΩ±5%, if not this is a fault. |
| | (11) Faulty indoor unit/remote controller. | Replace heat source unit circuit board or remote controller |

2. MA remote control transmission

The MA remote control and indoor unit communicate with the current tone burst method.

(1) Symptoms caused by infiltration of noise on transmission cable

If noise, etc., infiltrates the transmission cable and the communication between the MA remote control and indoor unit is cut off for three consecutive minutes, a MA communication error (6831) will occur.

(2) Confirmation of transmission specifications and waveform

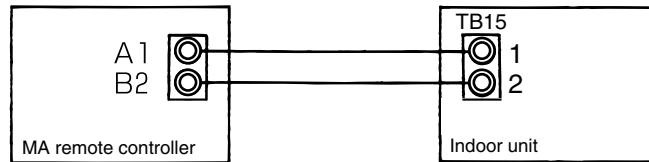

A1, B2: No polarity
Across terminal No. 1-2 :
Power supply (8.5V to 12VDC)

Transmission waveform (Across terminal No. 1-2)

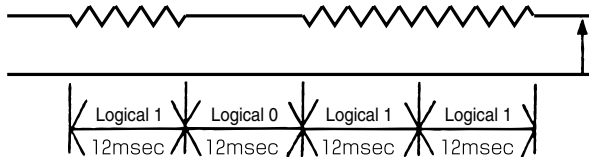

- (1) 2msec/bit \pm 5% must be satisfied
- (2) Voltage across terminal No.1-2 must be within range shown on left.

[4] Troubleshooting of Principal Parts

1. Pressure sensor

(1) Check for failure by comparing the sensing pressure according to the high pressure/low pressure pressure sensor and the pressure gauge pressure.

Set SW1 as shown below to display the high and low pressure sensor data displayed digitally by the light emitting diode LD1.



- (1) In the stopped condition, compare the pressure readings from the gauge and from the LD1 display.
 - (a) If the gauge pressure is 0~0.0098MPa, the internal pressure is dropping due to gas leakage.
 - (b) If the pressure according to the LD1 display is 0~0.0098MPa, there is a faulty contact at the connector, or it is disconnected. Proceed to (4).
 - (c) If the pressure according to the LD1 display is 4.15MPa for high pressure or higher, proceed to (3).
 - (d) If other than (a), (b) or (c), compare the pressure readings during operation. Proceed to (2).
- (2) Compare the pressure readings from the gauge and from the LD1 display while in the running condition.
 - (a) If the difference between the two pressures is within 0.098MPa, for high pressure and 0.03MPa for low pressure both the affected pressure sensor and the main MAIN board are normal.
 - (b) If the difference between the two pressures exceeds 0.098MPa, for high pressure and 0.03MPa for low pressure the affected pressure sensor is faulty (deteriorating performance).
 - (c) If the pressure reading in the LD1 display does not change, the affected pressure sensor is faulty.
- (3) Disconnect the pressure sensor from the MAIN board and check the pressure according to the LD1 display.
 - (a) If the pressure is 0~0.098MPa for low pressure on the LD1 display, the affected pressure sensor is faulty.
 - (b) If the pressure is 4.15MPa for high pressure or higher, the MAIN board is faulty.
- (4) Disconnect the pressure sensor from the MAIN board and short out the No. 2 and No. 3 pins of the connector (63HS), then check the pressure by the LD1 display.
 - (a) If the pressure according to the LD1 display is 4.15MPa for high pressure the affected pressure, the affected pressure sensor is faulty.
 - (b) If other than (a), the MAIN board is faulty.

(2) Pressure sensor configuration

The pressure sensors are configured in the circuit shown in the figure below. If DC 5V is applied between the red and black wires, a voltage corresponding to the voltage between the white and black wires is output and this voltage is picked up by the microcomputer.

The output voltage is 0.071V/0.098MPa.

※ The pressure sensor on the body side is specified for connector connection.

The connector pin number on the body side is different from that on the main board side.

| | Body side | Main board side |
|------|-----------|-----------------|
| Vcc | Pin 1 | Pin 3 |
| Vout | Pin 2 | Pin 2 |
| GND | Pin 3 | Pin 1 |

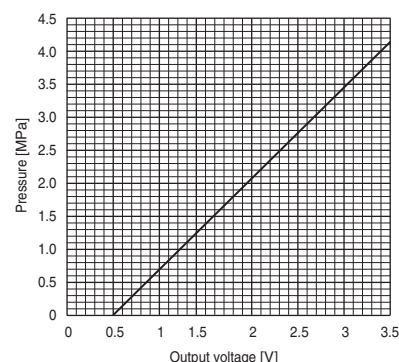
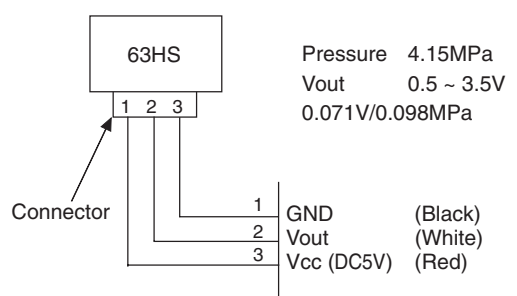

2. Low-pressure pressure sensor (63LS)

(1) Conduct the check comparing the pressure that is detected by the low-pressure pressure sensor and the low-pressure gauge pressure.

The pressure that is detected by the low-pressure pressure sensor will be displayed on the LED screen, LD1 when setting the digital shift switch (SW1) as shown below.



- (1) Compare the gauge pressure and the pressure that is displayed on LD1 while the sensor being stopped.
 - (a) When the gauge pressure is 0~0.098MPa → Inner pressure drop due to gas leak.
 - (b) When the pressure that is displayed on LD1 0~0.098MPa → Contact failure of the connector Check for the contact and proceed to (4).
 - (c) When the pressure that is displayed on LD is 1.7MPa or more → Proceed to (3).
 - (d) When (a), (b), and (c) are not applied, compare the pressure while the sensor is operating. → Proceed to (2).
- (2) Compare the gauge pressure and the pressure that is displayed on LD1 while the sensor is operating. (Compare by MPa unit.)
 - (a) When the difference between the both pressure is within 0.03MPa → Both the low-pressure pressure sensor and the main board are normal.
 - (b) When the difference between the both pressure is over 0.03MPa → The low-pressure pressure sensor is defective (particular deterioration).
 - (c) When the pressure that is displayed on LD1 does not change → The low-pressure pressure sensor is defective.
- (3) Remove the low-pressure pressure sensor from the main board and check the pressure that is displayed on LD1.
 - (a) When the pressure that is displayed on LD1 is 0~0.098MPa → The low-pressure pressure sensor is defective.
 - (b) When the pressure that is displayed on LD1 is approximately 1.7MPa → The main board is defective.
 - When the outdoor temperature is 30°C or less → The main board is defective.
 - When the outdoor temperature is over 30°C → Proceed to (5).
- (4) Remove the low-pressure pressure sensor from the main board, short circuit between the No.2 and No.3 connector (63LS), and check the pressure that is displayed LD1.
 - (a) When the pressure that is displayed on LD1 is 1.7MPa or more → The low-pressure pressure sensor is defective.
 - (b) When (a) is not applied → The main board is defective.
- (5) Remove the high-pressure sensor (63HS) from the main board, insert it into the low-pressure pressure sensor (63LS), and check the pressure that is displayed on LD1.
 - (a) When the pressure that is displayed on LD1 is 1.7MPa or more → The main board is defective.
 - (b) When (a) is no applied → The low-pressure pressure sensor is defective.

(2) Low-pressure pressure configuration

The low-pressure pressure sensor is composed of the circuit as shown in the right figure. When DC5V is applied between Vcc and GND, the voltage that is appropriate for the pressure between Vout and GND will be output, and it will be taken by the microcomputer.

The output voltage is 0.173V/0.098MPa.

* The pressure sensor on the body side is specified for connector connection.

The connector pin number on the body side is different from that on the main board side.

| | Body side | Main board side |
|------|-----------|-----------------|
| Vcc | Pin 1 | Pin 3 |
| Vout | Pin 2 | Pin 2 |
| GND | Pin 3 | Pin 1 |

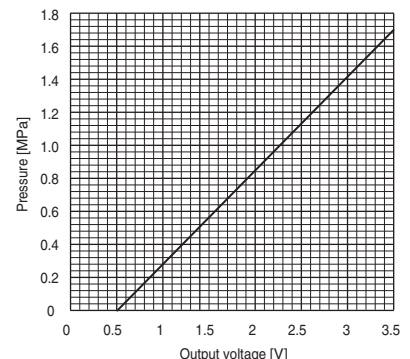
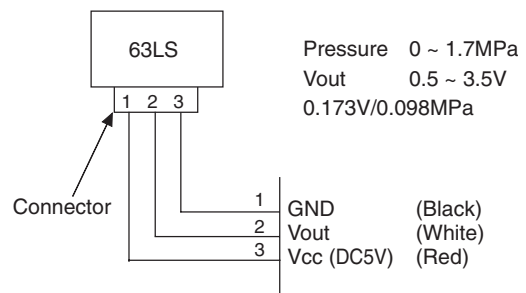





3. Solenoid valve

Check if the control board's output signals and the operation of the solenoid valves match.

Setting the self-diagnosis switch (SW1) as shown in the figure below causes the ON signal of each relay to be output to the LED's.

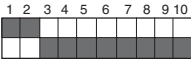
Each LED shows whether the relays for the following parts are ON or OFF. When a LED lights up, it indicates that the relay is ON.

*The circuit is closed when the relay is ON depending on parts. Refer to the following instructions.

| SW1 | LED | | | | | | | |
|---|-------|------|------|------|------|------|---|---|
| | 1 | 2 | 3 | 4 | 5 | 6 | 7 | 8 |
| ON  | 21S4a | | | CH11 | | | | |
| ON  | SV1 | | | SV4a | SV4b | SV4c | | |
| ON  | SV5a | SV5b | | | SV4d | | | |
| ON  | SV7a | SV7b | SV7c | | | | | |

When whatever valves malfunction, check whether the solenoid valve coil is not attached wrongly, the lead wire of the coil is not disconnected, the connector on the board is not inserted wrongly, or the wire for the connector is not disconnected.

(1) In the case of SV1 (Bypass valve)

This solenoid valve opens when powered (Relay ON).

- When the compressor starts, SV1 is ON for 4 minutes, check operation by whether the solenoid valve is emitting an operating noise.
- Changes in the operating condition by solenoid valve operation can be confirmed by the temperature of the bypass circuit and the sound of the refrigerant.
- SV1 goes on in accordance with the rise in high pressure in the cooling and heating mode, check operation by LED display and the operating noise emitted by the solenoid valve.

(2) In the case of SV4a~4d,SV7a~7c [P200, P250 type] or SV4a~4d, 5a, 5b,SV7a~7c [P400, P500 type] (Heat exchanger capacity control)

- ① In the case of cooling-only, one or more valves among SV4a~4c, 5a, 5b,7a~7c turn(s) on depending on the condition. Check the operation by LED display and operation sound of the solenoid valve.
- ② In the case of heating-only, all of SV4a~4c, 5a, 5b,7a~7c turn on. The operation can be checked by LED display and operation sound of the solenoid valve.
- ③ In the case of cooling-main or heating-main, one or more valves among SV4a~4d, 5a, 5b,7a~7c turn(s) on. Check the operation by LED display and operation sound of the solenoid valve.
- ④ Refrigerant flow is as shown in the figure below. In the case of cooling-only or cooling-main mode, high-temperature (high-pressure) flow is shown, and in the case of heating-only or heating-main mode, low-temperature gas or liquid flow is shown. Refer to the refrigerant circuit figure. Turn on or off the solenoid valve depending on the indoor unit capacity or the outdoor temperature. Check the LED monitor. Remove the SV coil, open the lid, and check the plunger. However, pin-face tools, which are specified in service parts list, are required.

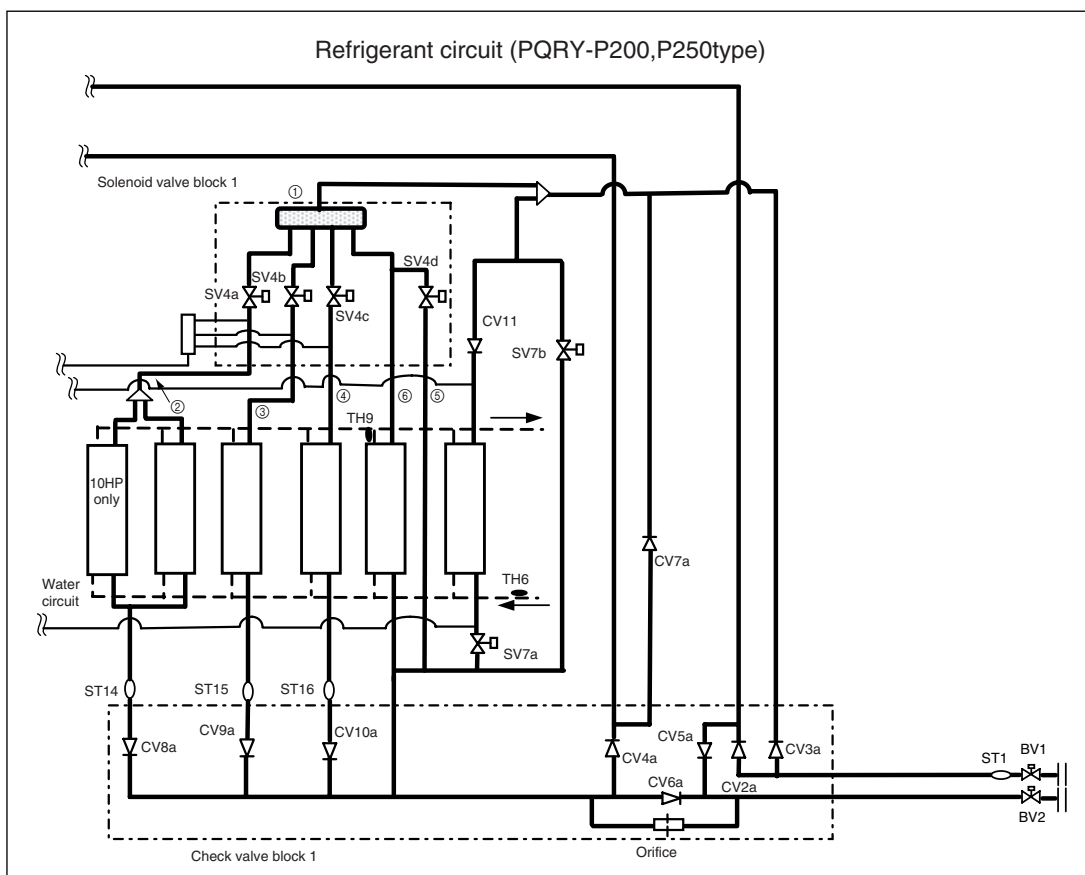
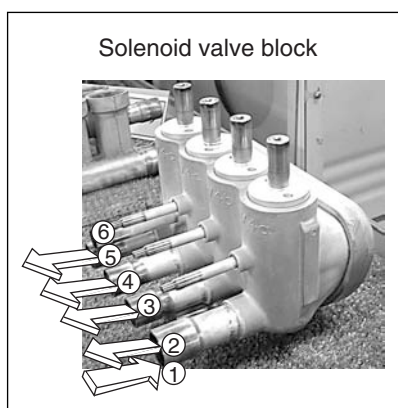
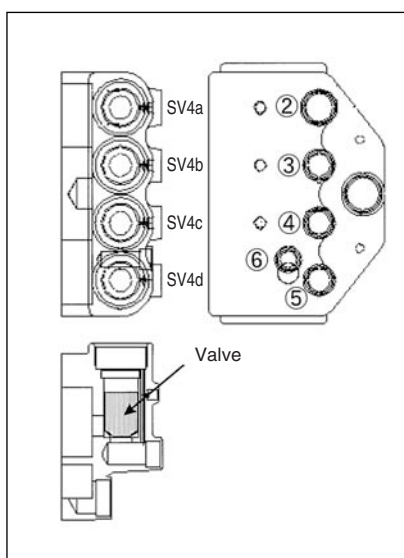

Refrigerant circuit (PQHY-P200,P250type)

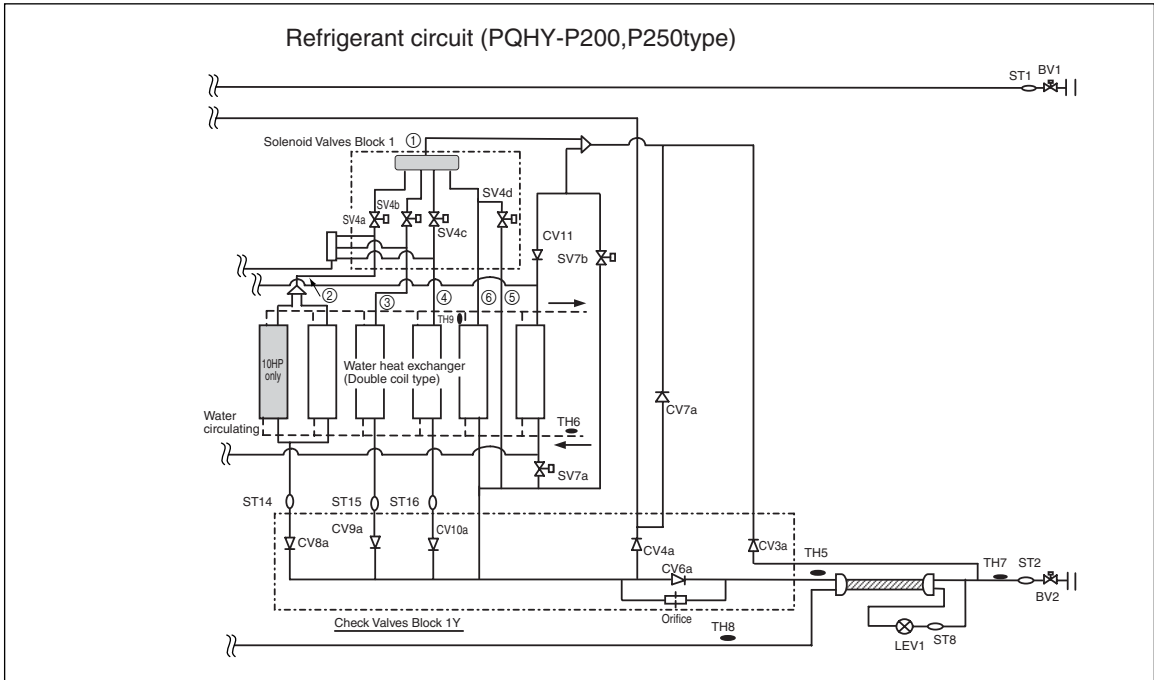

Refrigerant circuit (PQRY-P400,P500types)

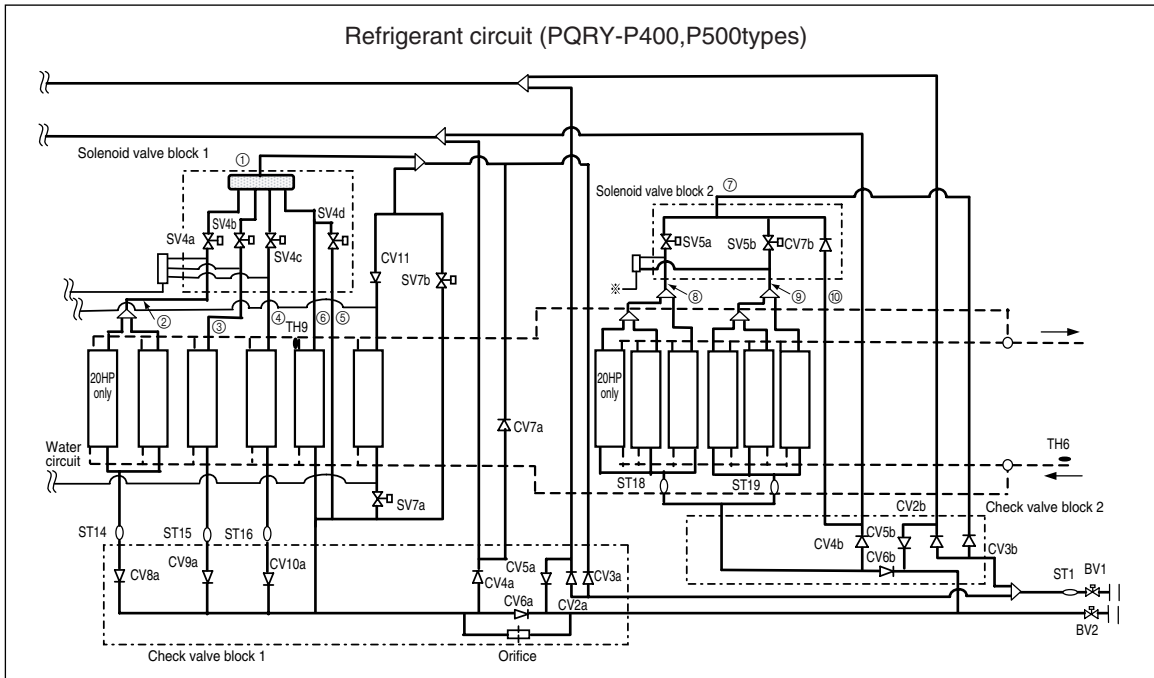

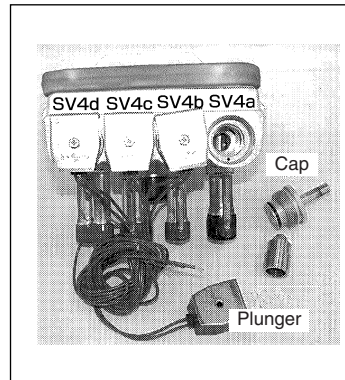
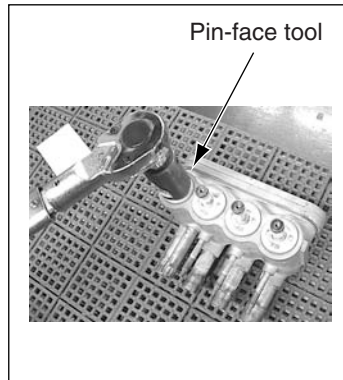
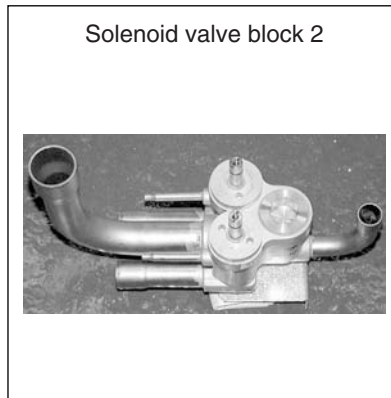
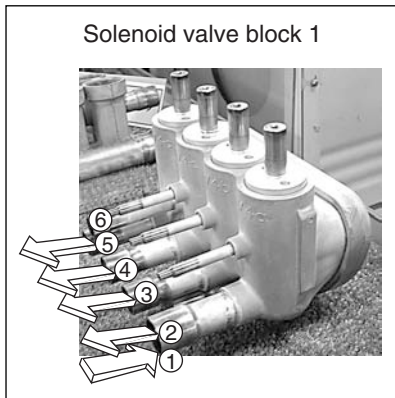
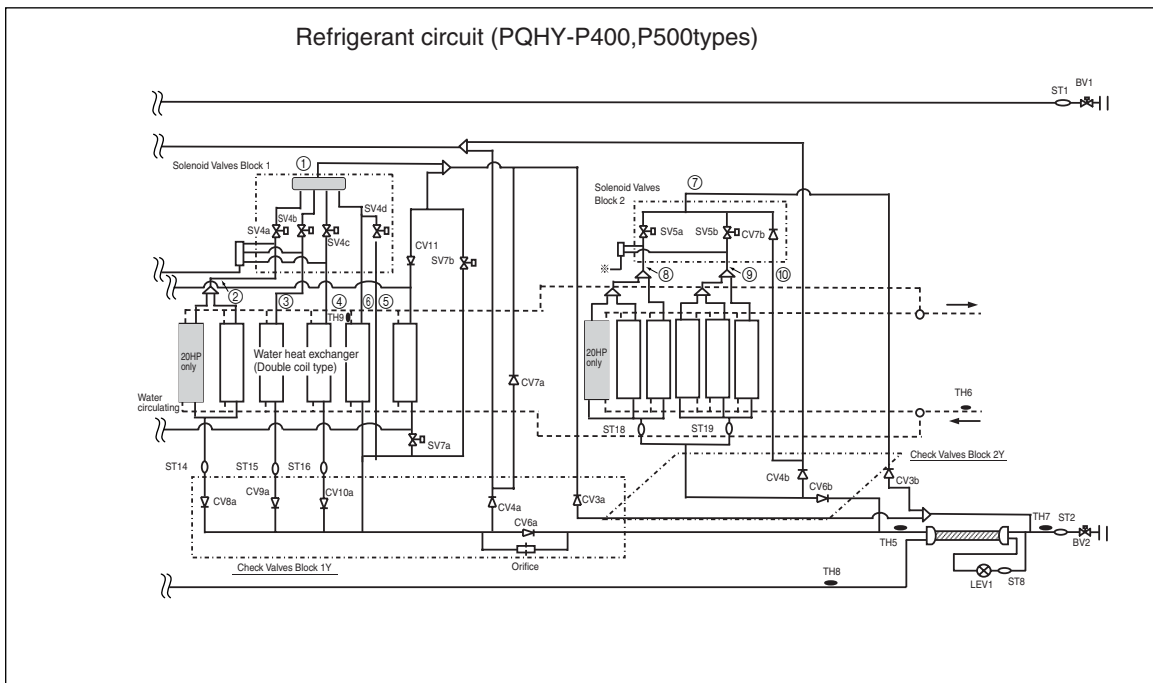

Tightening torque : 150 N·m

(3) In the case of 21S4a (4-way switching valve)

About this 4-way valve

When not powered : The electricity runs between the oil separator exit and the heat exchanger and between the gas ball valve (BV1) and the accumulator. This circulation is for cooling.

When powered : The electricity runs between the oil separator and the gas ball valve, and between the heat exchanger and the accumulator. This circulation is for heating.

Check the LED display and the intake and the discharge temperature for the 4-way valve to check whether the valve has no faults and the electricity runs between where and where.

Do not touch the pipe when checking the temperature, as the pipe on the oil separator side will be hot.

* Do not give an impact from outside, as the outer hull will be deformed leading to the malfunction of the inner valve.

(4) Check valve block

By turning on or off SV3-6, the refrigerant flows through ⑥, ⑦, ⑧, and ⑨. Check the LED monitor. Valve plug A, B and C can be removed with 3 kinds of hex wrenches. Hex wrench size is shown below.

<PQRY>

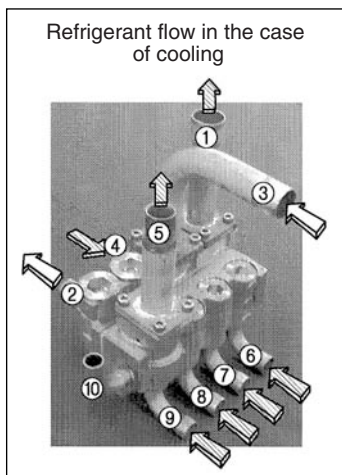
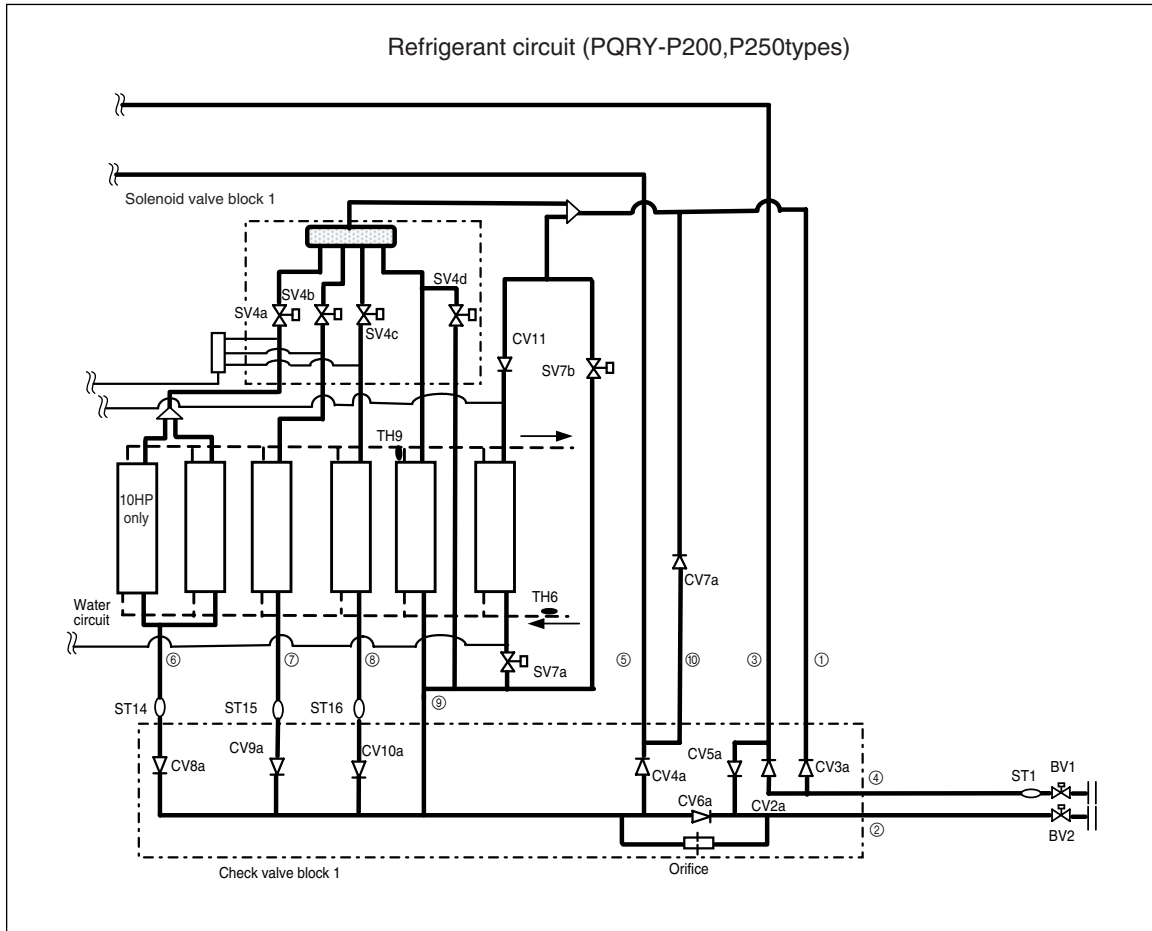

Check valve block1

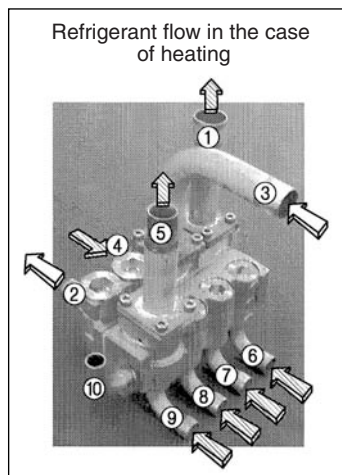

Check valve block1

- High-pressure (gas)
- High-pressure (liquid)
- Low-pressure (gas/liquid)

Refrigerant circuit (PQRY-P400,P500types)

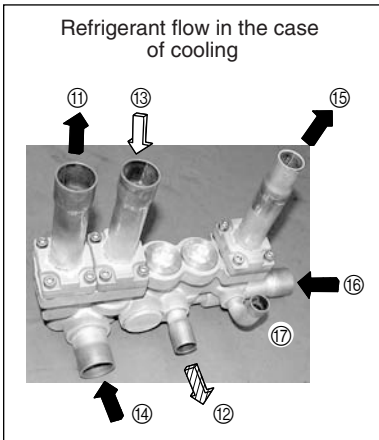
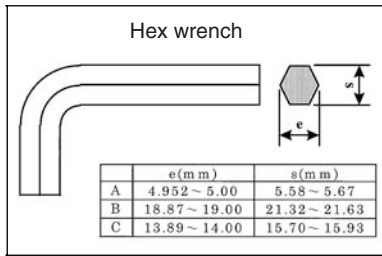
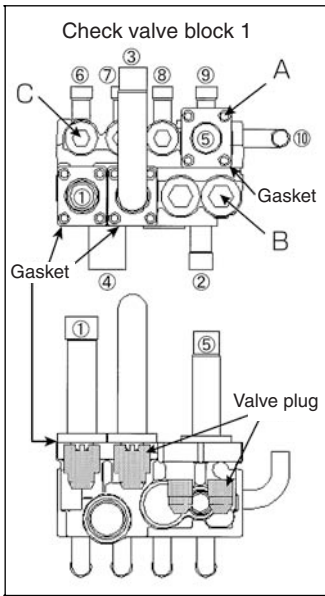
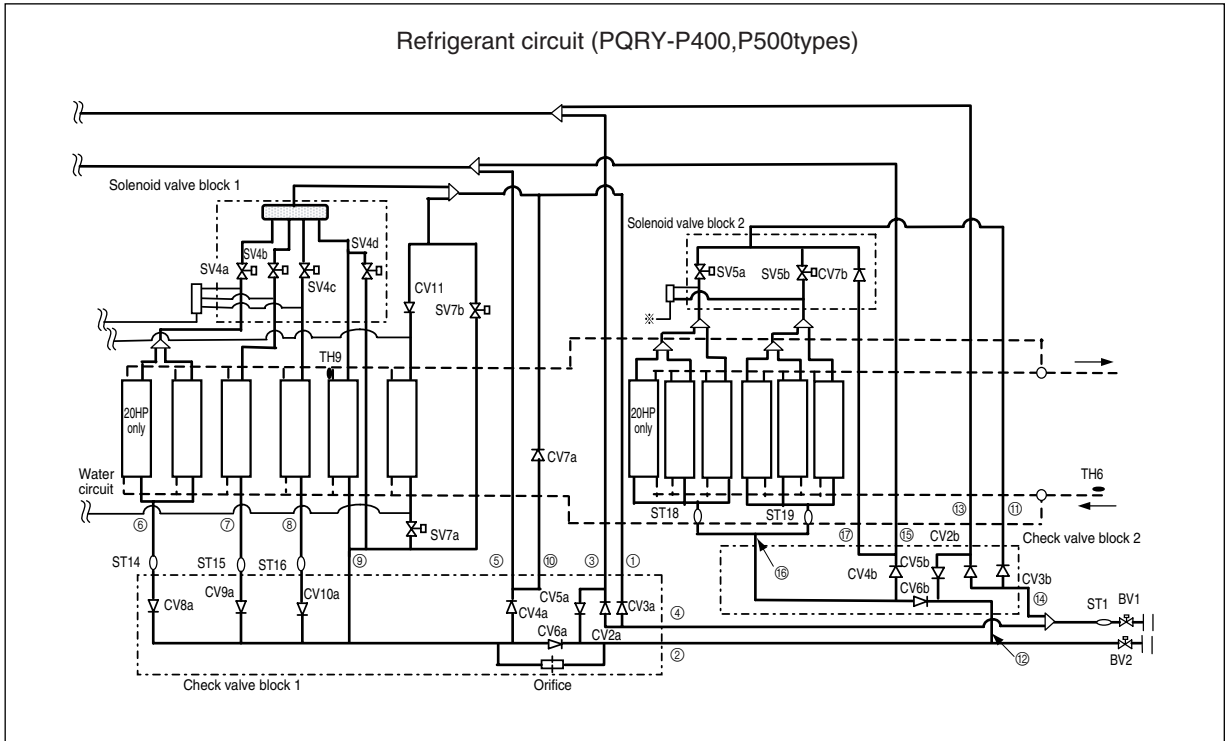

Check valve block2 (only P400,P500types)

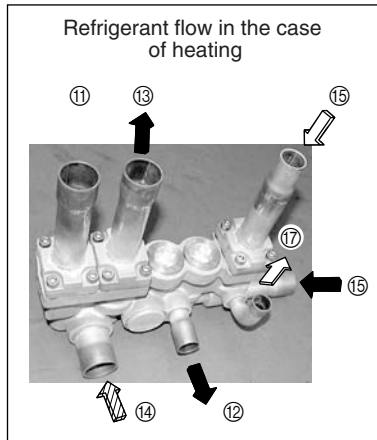

Check valve block2 (only P400,P500types)

- High-pressure (gas)
- High-pressure (liquid)
- Low-pressure (gas/liquid)

<PQHY>

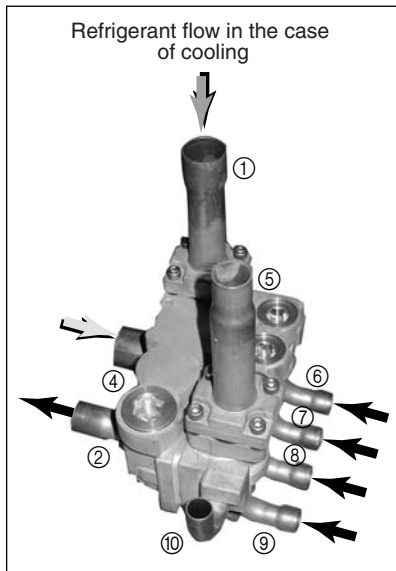
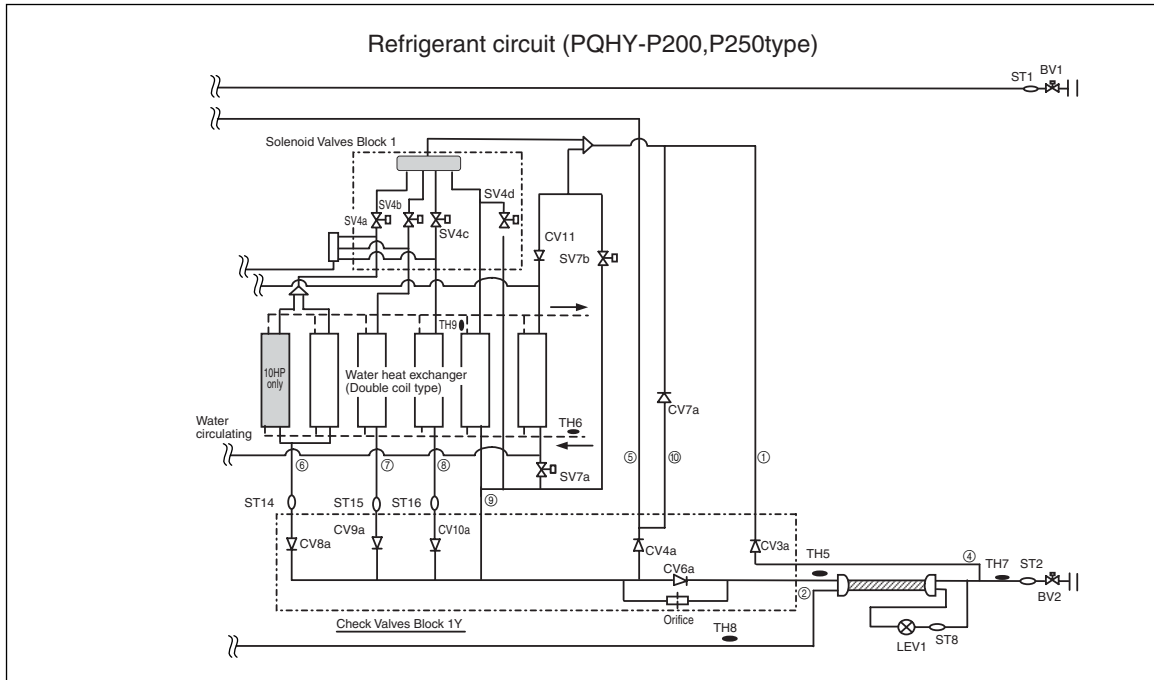

Check valve block1

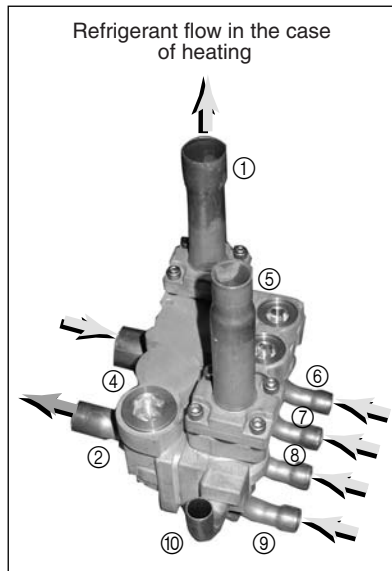

Check valve block1

- High-pressure (gas)
- High-pressure (liquid)
- Low-pressure (gas/liquid)

Refrigerant circuit (PQHY-P400,P500types)

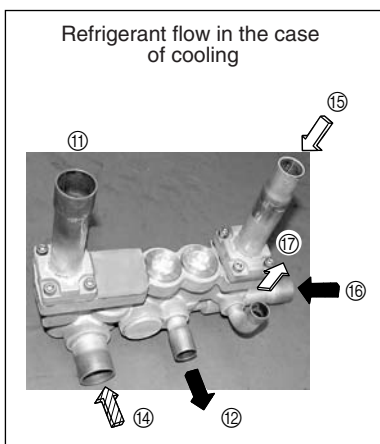
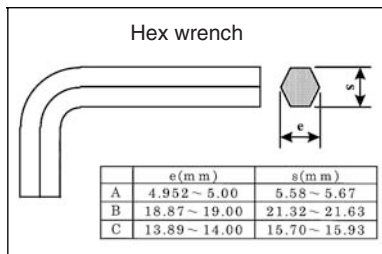
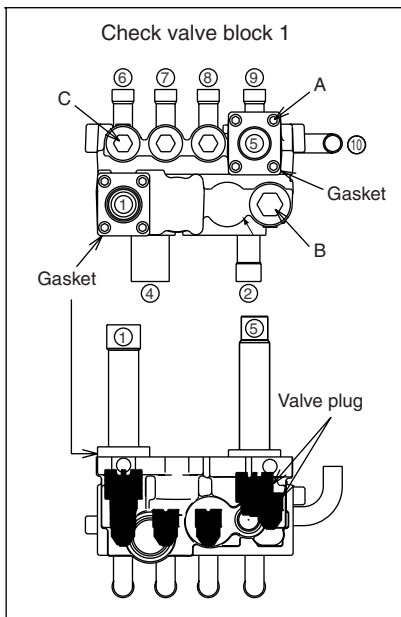
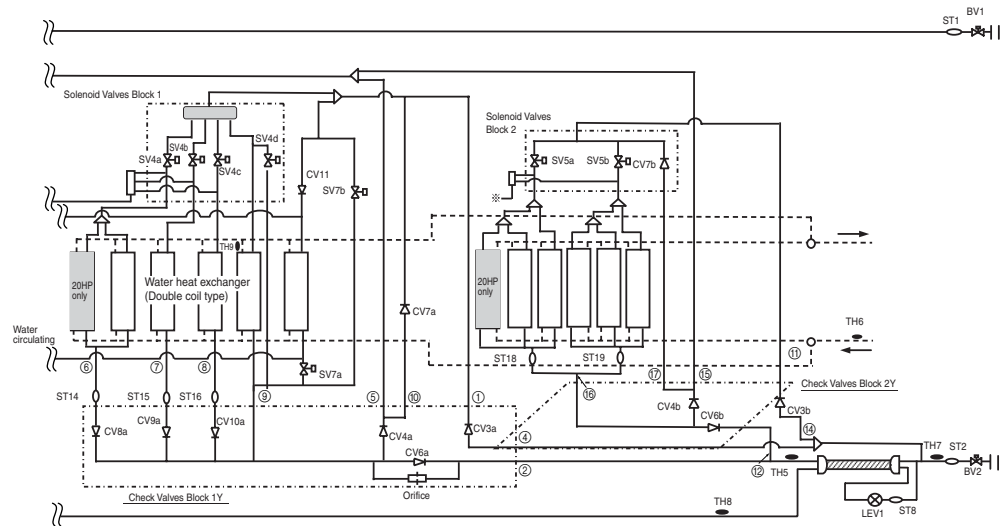

Check valve block2 (only P400,P500types)

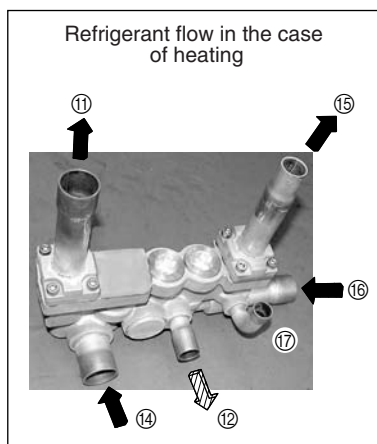

Check valve block2 (only P400,P500types)

- High-pressure (gas)
- High-pressure (liquid)
- Low-pressure (gas/liquid)

5. Troubleshooting method of main parts of BC controller

(1) Pressure sensor



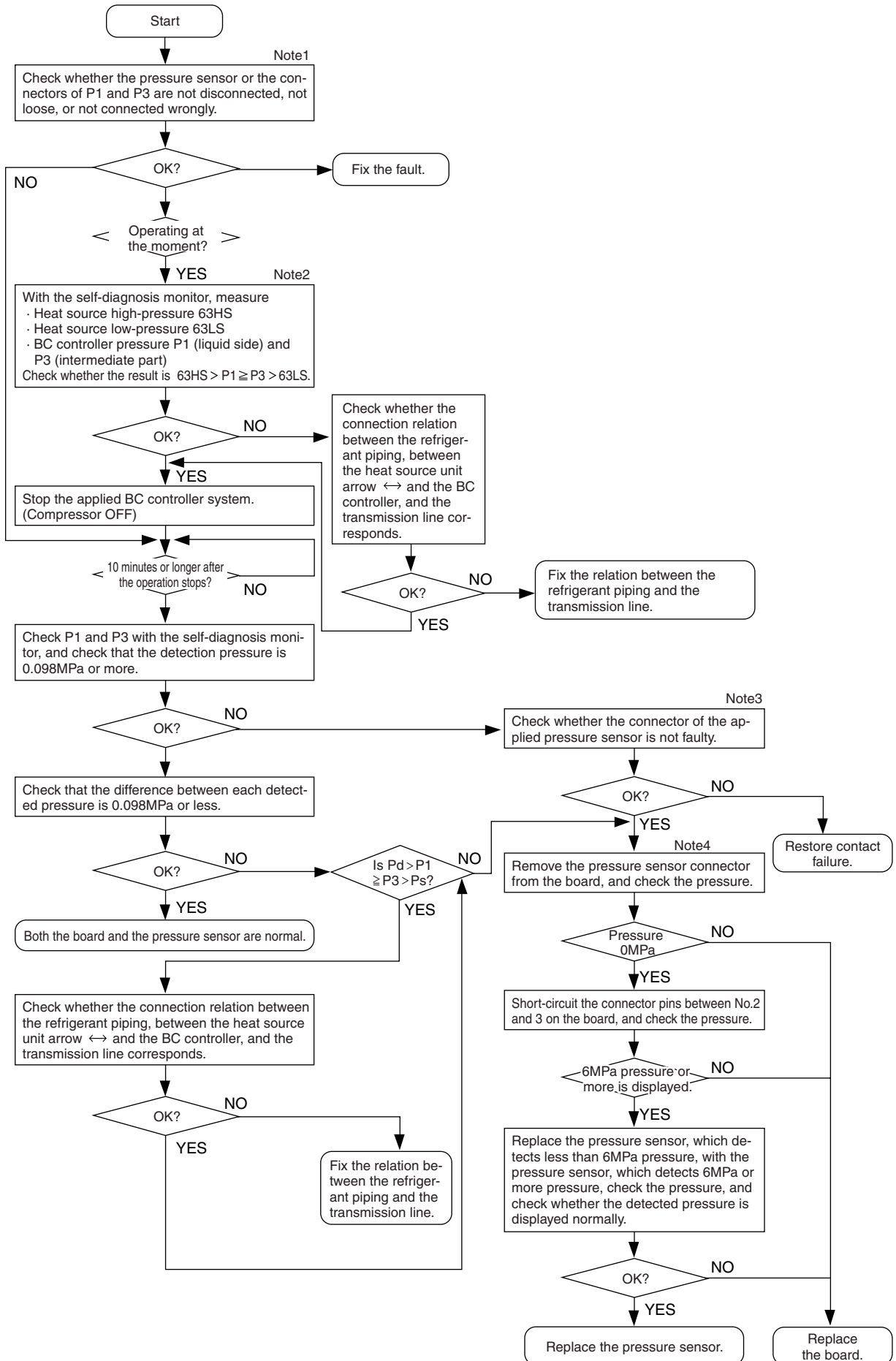

Troubleshooting flow chart for pressure sensor



Note1 BC controller: Phenomena when the pressure sensor is connected wrongly (reverse connection of P1 and P3) to the board.

| Phenomena | | | | | | |
|--------------|--------------|---|---|---|--|---|
| Cooling-only | Cooling-main | | Heating-only | | Heating-main | |
| Normal | Non-cooling | SC11 large SC16 small △ PHM large | Heating indoor SC small Heating indoor Thermo ON Especially noise is large. | SC11 large SC16 small △ PHM large | Non-cooling Heating indoor SC small Heating indoor Thermo ON Especially noise is large. | SC11 large SC16 small △ PHM large |

Note2 Check the self-diagnosis switch (Heat source control board SW1).

| Measurement data | Symbol | SW1 setting value |
|--|--------|--|
| Heat source high-pressure pressure | 63HS | ON  |
| Heat source low-pressure pressure | 63LS | ON  |
| BC controller pressure (liquid side) | P1 | ON  |
| BC controller pressure (intermediate part) | P3 | ON  |

Note3 Check whether CNP1 (liquid side) connector on the BC controller control board and the connector CNP2 (intermediate part) are not disconnected or not loose.

Note4 Check the pressure value with the self-diagnosis switch (same as note1) with the connector of the applied pressure sensor is disconnected from the board.

(2) Temperature sensor

Thermistor troubleshooting instruction

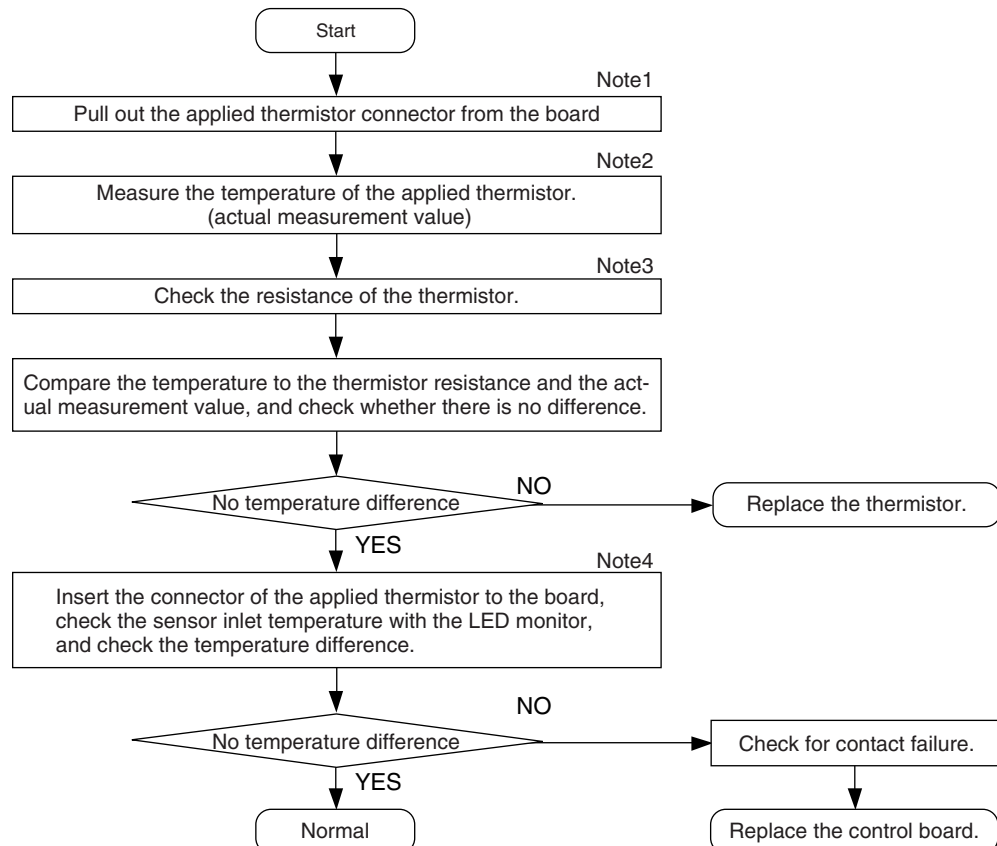





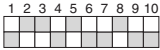

Note1 For the connectors on the board, TH11~TH12 is CN10, and TH15 and TH16 is CN11. Disconnect the applied connector, and check every number of the sensor.

Note2 and 3

- (1) Pull out the sensor connector from the I/O board Do not pull the sensor with holding the lead wire.
- (2) Measure the resistance with such as a tester.
- (3) Compare the measured value with that of shown in the figure below. When the result is $\pm 10\%$, it is normal.

Note4 Check the self-diagnosis switch (Heat source control board SW1).

| | Measurement data | Symbol | SW1 setting value |
|------------------------|---------------------------|--------|---|
| G,GA type | Liquid inlet temperature | TH11 | ON  |
| | Bypass outlet temperature | TH12 | ON  |
| | Bypass inlet temperature | TH15 | ON  |
| | Liquid inlet temperature | TH16 | ON  |
| GB type (unit 1) | Bypass outlet temperature | TH22 | ON  |
| | Bypass inlet temperature | TH25 | ON  |
| GB type (unit 2) | Bypass outlet temperature | TH22 | ON  |
| | Bypass inlet temperature | TH25 | ON  |

(3) Troubleshooting flow chart for LEV · Solenoid valve

① LEV

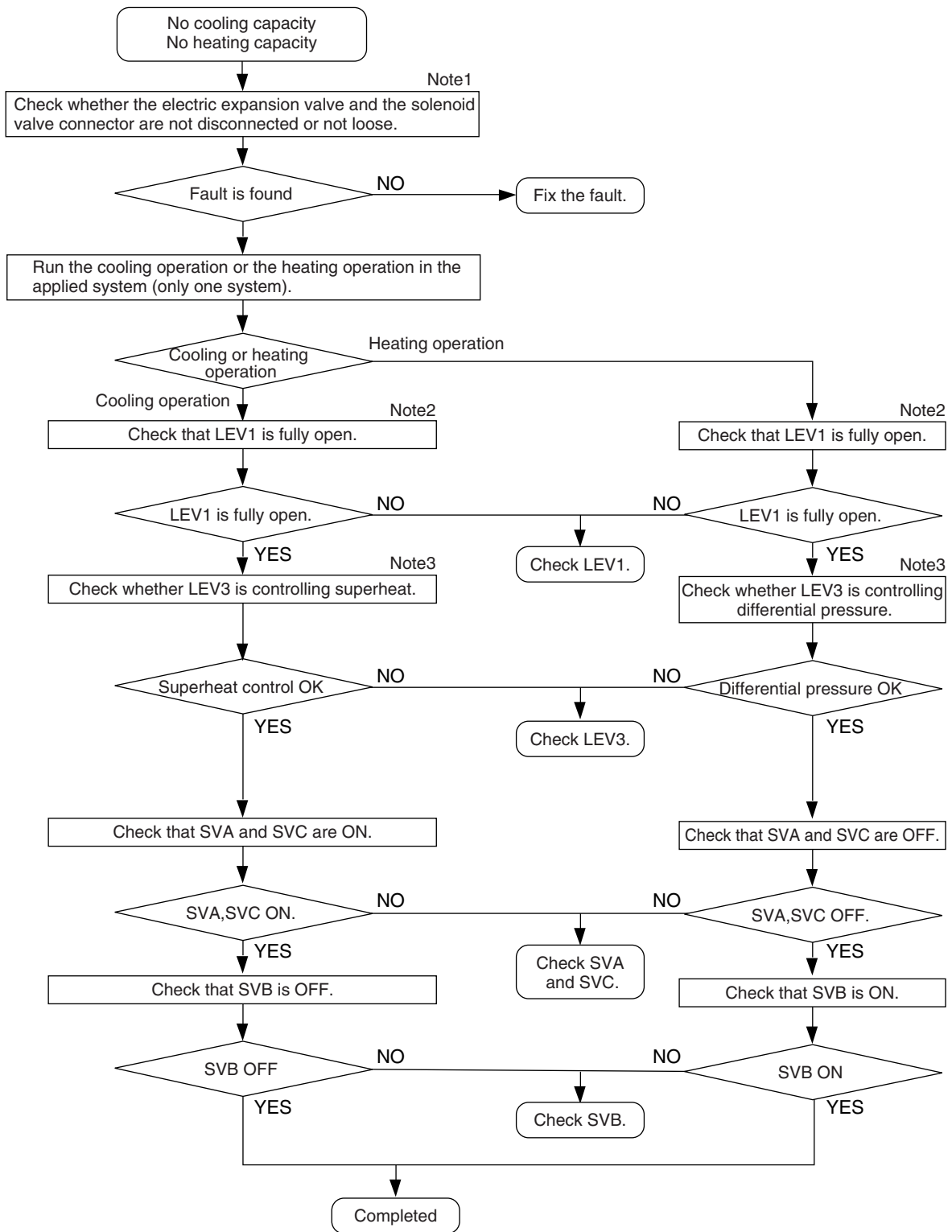

Note1 BC controller: Phenomena when LEV is connected wrongly (reverse connection of LEV1 and LEV3) to the board.

| Phenomena | | | |
|---|---|---|--|
| Cooling-only | Cooling-main | Heating-only | Heating-main |
| Non-cooling SH12 small, SC11 small SH16 small, branch pipe SC small BC controller sound | Non-cooling, non-heating SH12 small, SC11 small SH16 large, but branch pipe SC small BC controller sound Δ PHM large | Indoor heating SC small Δ PHM large | Non-cooling Indoor heating SC small Δ PHM large |

Note2 Check method of LEV fully open of fully closed status

① Check LEV opening (pulse) with the self-diagnosis monitor (Outdoor control board SW1).

Fully open : 200pulse

Fully closed : 110pulse (In the case of heating-only mode, however, the pulse may become 110 or more.)







② When LEV is fully open, measure the front and the rear temperature of the piping, and check that there is no temperature difference.

③ When LEV is fully closed, check that there is no refrigerant flowing sound.

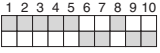
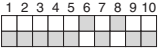
Note3 Refer to the chart below to judge LEV differential control and the opening with superheat control.
(BC controller LEV basic operation characteristic)

| | Site | Malfunction mode | Operation mode | Content | Safety margin judgment standard |
|-----------|-------|-------------------|--|---|---------------------------------|
| G-GA type | LEV1 | Inclined to close | Heating-only Heating-main Cooling-main | High pressure (P1) – Intermediate pressure (P3) is large. | 0.3~0.4MPa |
| | | Inclined to open | | High pressure (P1) – Intermediate pressure (P3) is small. | |
| | LEV3 | Inclined to close | Cooling-only Cooling-main | SH12 is large. | SH12 < 20 |
| | | | Heating-only Heating-main | High pressure (P1) – Intermediate pressure (P3) is small. | 0.3~0.4MPa |
| | | Inclined to open | Cooling-only Cooling-main | SC16 and SH12 are small. | SC16 > 3 SH12 > 3 |
| | | | Heating-only Heating-main | High pressure (P1) – Intermediate pressure (P3) is large. | 0.3~0.4MPa |
| GB type | LEV3a | Inclined to close | Cooling-only Cooling-main | SH22 is large. | SH22 < 20 |
| | | Inclined to open | Cooling-only Cooling-main | SH22 is small. | SH22 > 3 |

<Self-diagnosis monitor>

| | Measurement data | Symbol | SW1 setting value |
|------------------------|---|--------|---|
| G,GA type | LEV1 opening | — | ON  |
| | LEV3 opening | — | ON  |
| | BC controller bypass outlet superheat | SH12 | ON  |
| | BC controller intermediate part subcool | SC16 | ON  |
| | BC controller liquid-side subcool | SC11 | ON  |
| GB type (unit 1) | LEV3a opening | — | ON  |
| GB type (unit 2) | LEV3a opening | — | ON  |

<Troubleshooting flow chart for solenoid valve body>

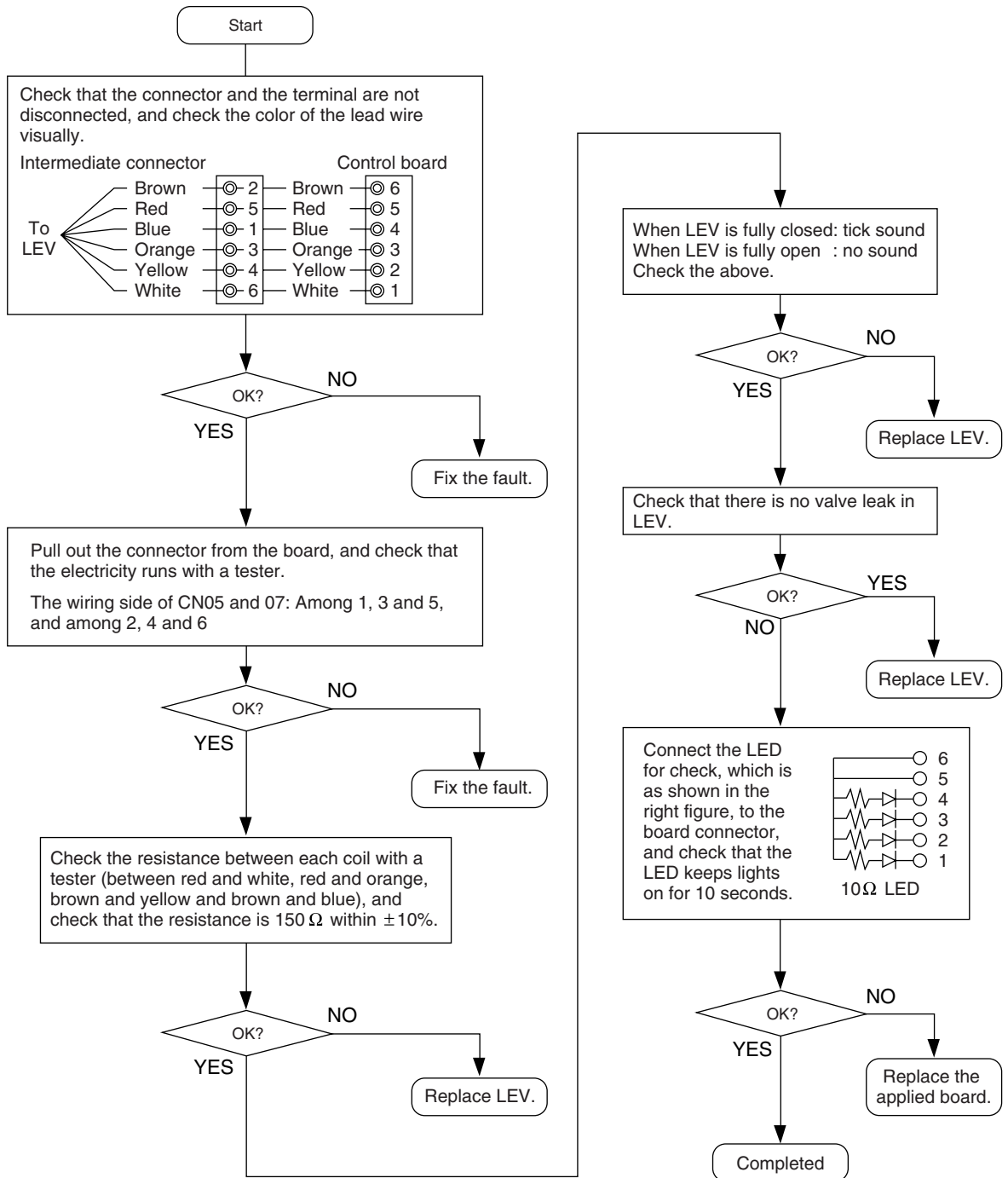

② Solenoid valve (SVA, SVB, SVC)

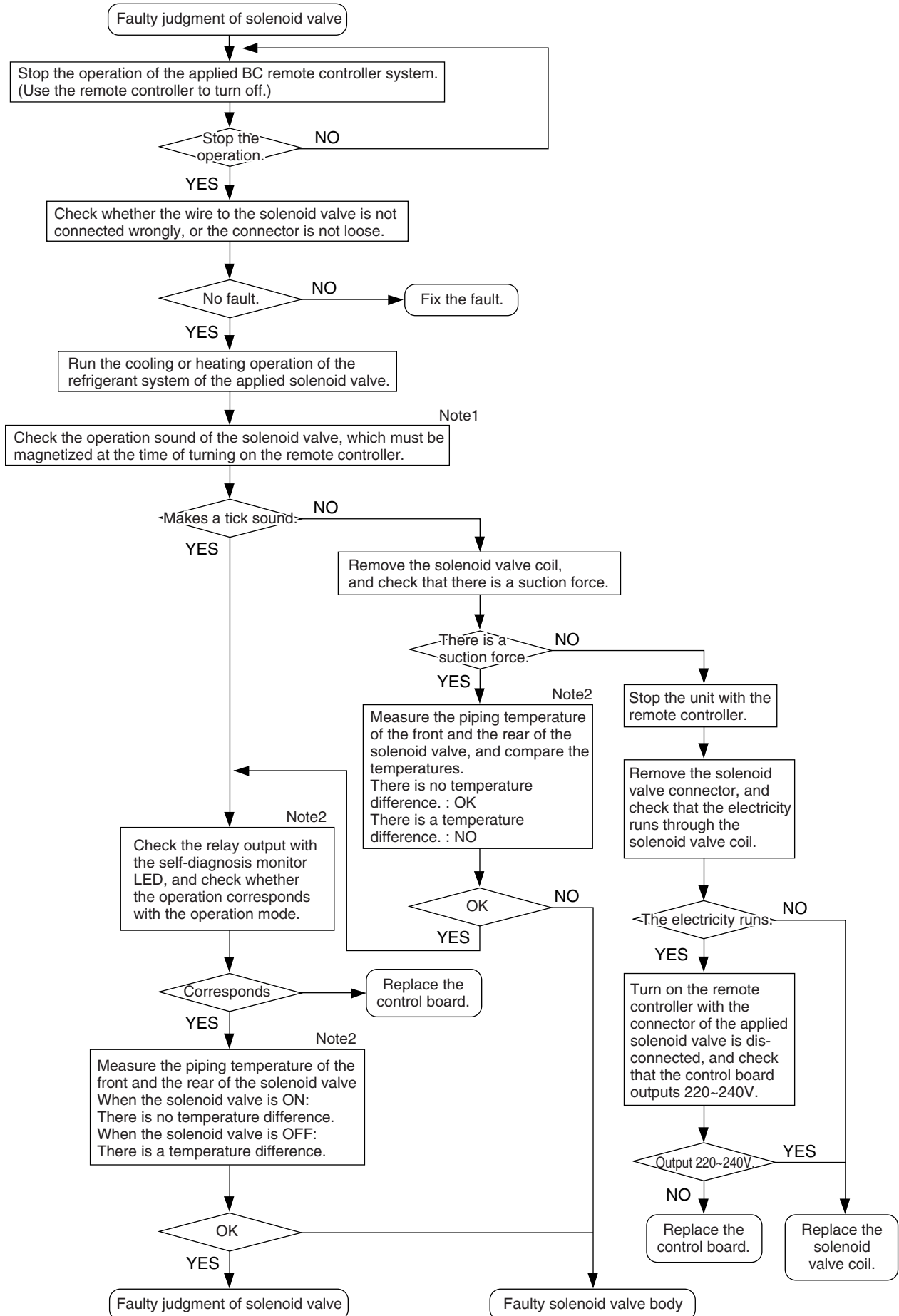

Check whether the BC board output signal and the solenoid valve operation correspond.

Note1 SVA, SVB, SVC

SVA, SVB and SVC turn on or off according to the indoor unit operation mode.

| Mode \ Branch end | Cooling | Heating | Stop | Defrost |
|-------------------|---------|---------|------|---------|
| SVA | ON | OFF | OFF | OFF |
| SVB | OFF | ON | OFF | OFF |
| SVC | ON | OFF | OFF | OFF |

SVM1, SVM2 [P400, P500 types]

SVM1,SVM2 turns on or off according to the operation mode.

| Operation mode | Cooling-only | Cooling-main | Heating-only | Heating-main | Defrost | Stop |
|----------------|--------------|---------------------------------------|---------------------------------------|---------------------------------------|---------|------|
| SVM1 | ON | Pressure difference control OFF or ON | OFF | OFF | ON | OFF |
| SVM2 | OFF | OFF | Pressure difference control OFF or ON | Pressure difference control OFF or ON | OFF | OFF |

Note2 SVA, SVB, SVC

Measure the temperature of the piping ①-② which is in front and behind the SVA.

Measure the temperature of the piping ①-③ which is in front and behind the SVB.

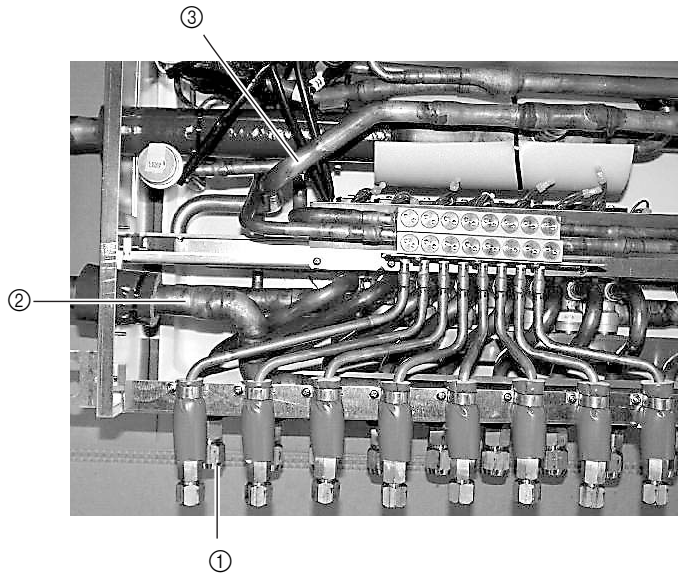

(4) BC controller transformer

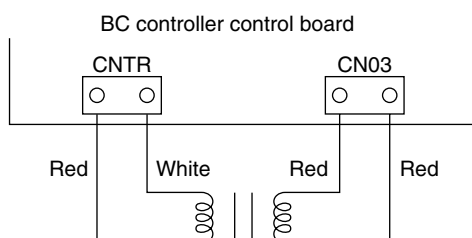

| | Normal | Abnormal |
|-------------|------------|------------------------|
| CNTR(1)-(3) | about 58Ω | Open-phase or shorting |
| CN03(1)-(3) | about 1.6Ω | |

* Before measuring the resistance, pull out the connector.

6. LEV

(1) Indoor, BC controller LEV

The valve opening angle changes in proportion to the number of pulses.

(Connections between the indoor unit's control board and indoor, BC controller LEV.)

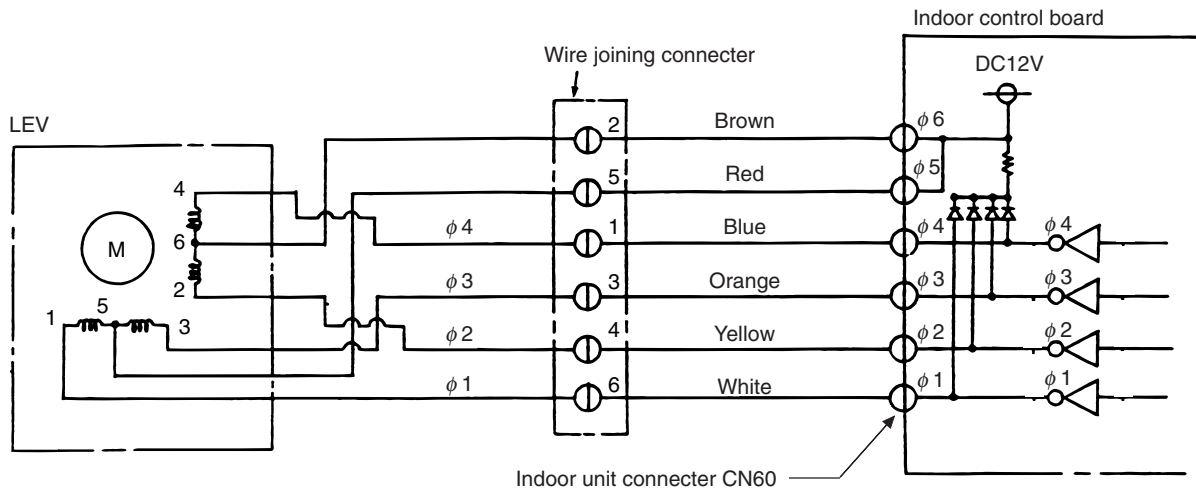

Pulse signal output and valve operation

| Output (Phase) | Output state | | | |
|----------------|--------------|-----|-----|-----|
| | 1 | 2 | 3 | 4 |
| 1 | ON | OFF | OFF | ON |
| 2 | ON | ON | OFF | OFF |
| 3 | OFF | ON | ON | OFF |
| 4 | OFF | OFF | ON | ON |

Output pulses change in the following orders when the Valve is closed; 1 → 2 → 3 → 4 → 1
 Valve is open; 4 → 3 → 2 → 1 → 4

- *1. When the LEV opening angle does not change, all the output phases are off.
- *2. When the output is out of phase or remains ON continuously, the motor cannot run smoothly, but move jerkily and vibrates.

LEV valve closing and valve opening operation

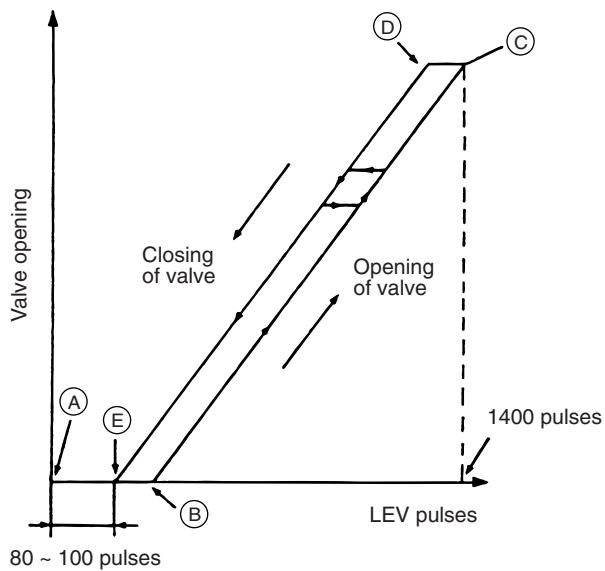

- * When the power is switched ON, a 2200 pulse valve opening signal is output to make sure the valve's position, so that it is definitely at point (A).
- * When the valve operates smoothly, there is no sound from the LEV and no vibration occurs, but when the valve is locked or (E) → (A), it emits a noise .
- * Whether a sound is being emitted or not can be determined by holding a screwdriver, etc. against it, then placing your ear against the handle.

(2) Heat source LEV

The valve opening angle changes in proportion to the number of pulses.
 (Connections between the heat source unit's MAIN board and LEV1/LEV2.)

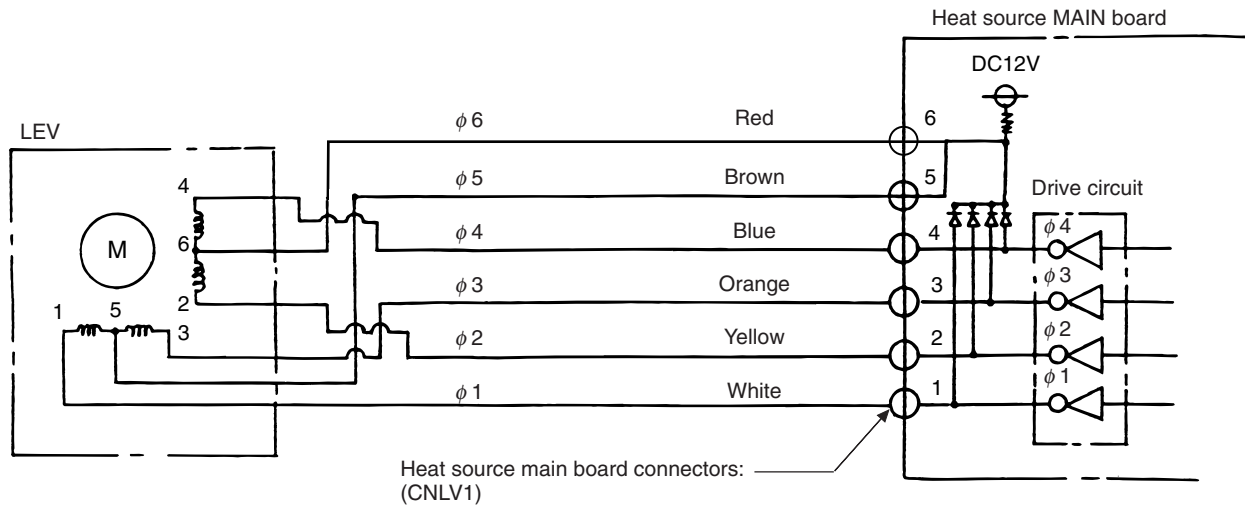

Pulse signal output and valve operation

| Output (Phase) | Output states | | | | | | | |
|----------------|---------------|-----|-----|-----|-----|-----|-----|-----|
| | 1 | 2 | 3 | 4 | 5 | 6 | 7 | 8 |
| φ 1 | ON | OFF | OFF | OFF | OFF | OFF | ON | ON |
| φ 2 | ON | ON | ON | OFF | OFF | OFF | OFF | OFF |
| φ 3 | OFF | OFF | ON | ON | ON | OFF | OFF | OFF |
| φ 4 | OFF | OFF | OFF | OFF | ON | ON | ON | OFF |

Output pulses change in the following orders when the
 Valve is closed; 1 → 2 → 3 → 4 → 5 → 6 → 7 → 8 → 1
 Valve is open; 8 → 7 → 6 → 5 → 4 → 3 → 2 → 1 → 8

- * 1. When the LEV opening angle does not change, all the output phases are off.
- 2. When the output is out of phase or remains ON continuously, the motor cannot run smoothly, but move jerkily and vibrates.

LEV valve closing and valve opening operation

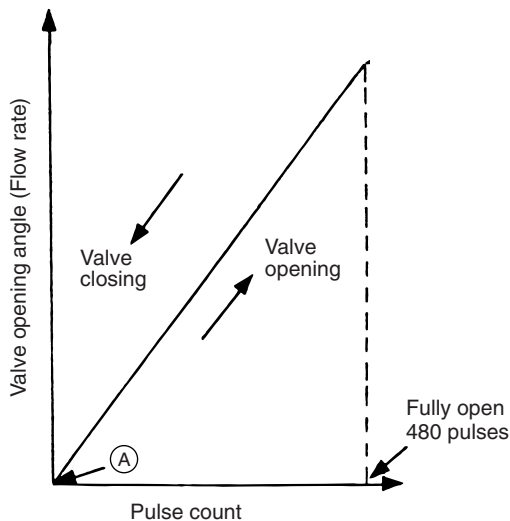

* When the power is switched ON, a 520 pulse valve opening signal is output to make sure the valve's position, so that it is definitely at point (A). Pulse signal is output for approximately 17 seconds.

* When the valve operates smoothly, there is no sound from the LEV and no vibration occurs, but when the valve is locked, it emits a noise.

* Whether a sound is being emitted or not can be determined by holding a screwdriver, etc. against it, then placing your ear against the handle.

* If there is liquid refrigerant inside the LEV, the sound may become lower.

(3) Judgment methods and likely failure mode

Caution:

The specifications of the heat source unit (heat source LEV) and indoor unit (indoor LEV) differ. For this reason, there are cases where the treatment contents differ, so follow the treatment specified for the appropriate LEV as indicated in the right column.

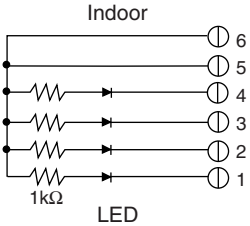
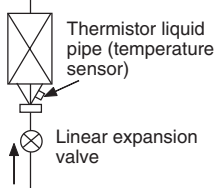
| Failure mode | Judgment method | Treatment | Affected LEV |
|--|---|--|----------------------|
| <p>Microcomputer driver circuit failure</p> | <p>1. Disconnect the control board connector and connect the check LED as shown in the figure below.</p>  <p>When the base power supply is turned on, the indoor LEV outputs pulse signals for 10 seconds, the heat source LEV outputs pulse signals for 17 seconds. If the LED does not light up, or lights up and remains on, the driver circuit is abnormal.</p> | <p>In the case of driver circuit failure, replace the control board.</p> | <p>Indoor BC</p> |
| <p>LEV mechanism is locked</p> | <p>1. If the LEV is locked up, the drive motor turns with no load and a small clicking sound is generated. Generation of this sound when the LEV is fully closed or fully open is abnormal.</p> | <p>Replace the LEV.</p> | <p>Indoor BC</p> |
| <p>The LEV motor coils have a disconnected wire or is shorted</p> | <p>Measure the resistance between the coils (red - white, red - orange, brown - yellow, brown - blue) using a tester. They are normal if the resistance is within $150\Omega \pm 10\%$.</p> | <p>Replace the LEV coils.</p> | <p>Indoor</p> |
| <p>Fully closed failure (valve leaks)</p> | <p>1. If you are checking the indoor unit's LEV, operate the indoor unit's blower and the other indoor units in the cooling mode, then check the piping temperatures (liquid pipe temperatures) of the indoor units by the operation monitor through the heat source unit's control board. When the fan is running, the linear expansion valve is fully closed, so if there is leakage, the temperature sensed by the thermistor (liquid pipe temperature sensor) will become low. If the temperature is considerably low compared to the remote control's intake temperature display, it can be judged that there is not a fully closed failure. In the case of minimal leakage, it is not necessary to replace the LEV if there are no other effects.</p>  | <p>If there is a large amount of leakage, replace the LEV.</p> | <p>Indoor BC</p> |
| <p>Faulty wire connections in the connector or faulty contact.</p> | <p>1. Check for pins not fully inserted on the connector and check the colors of the lead wires visually 2. Disconnect the control board's connector and conduct a continuity check using a tester.</p> | <p>Check the continuity at the places where trouble is found.</p> | <p>Indoor BC</p> |

(4) Heat source LEV coil removal procedure (configuration)

As shown in the figure, the heat source LEV is made in such a way that the coils and the body can be separated.

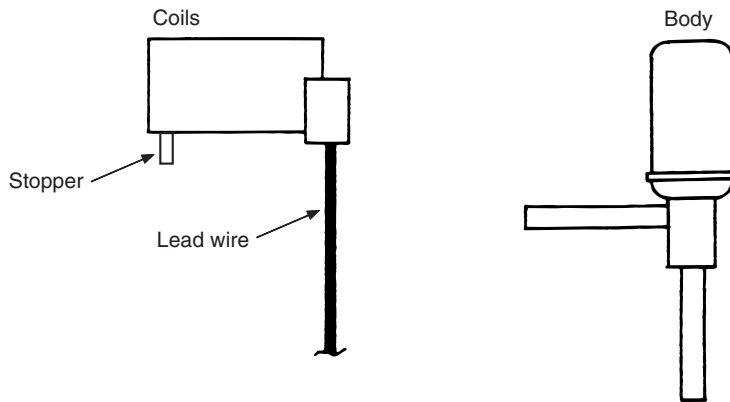

Removing the coils:

Fasten the body tightly at the bottom (Part A in the figure) so that the body will not move, then pull out the coils toward the top. If they catch on the stopper and are difficult to take out, turn the coils left and right until the stoppers are free from the stopper indentations, then pull the coils out.

If you take out the coils without gripping the body, undue force may be applied to the piping and the pipe may be bent, be sure to fasten the body in such a way that it will not move.

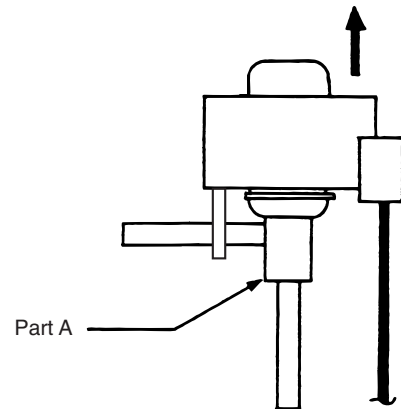

Installing the coils :

Fasten the body tightly at the bottom (Part A in the figure) so that the body will not move, then insert the coils from the top, inserting the coils' stopper securely in one of the indentations on the body. (There are four indentations for the stopper on the body around its circumference, and it doesn't matter which indentation is used. However, be careful not to apply undue force to the lead wires or twist them around inside the body.) If the coils are inserted without gripping the body, it may exert undue force on the piping, causing it to become bent, so be sure to hold the body firmly so that it won't move when installing the coils.

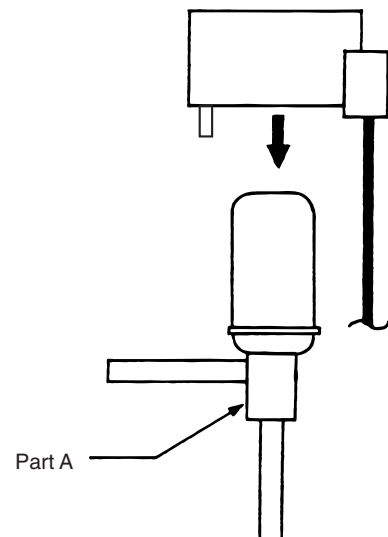

7. Inverter and compressor

- a. **Replace only the compressor** if only the compressor is found to be defective.
(Overcurrent will flow through the inverter if the compressor is damaged, however, the power supply is automatically cut when overcurrent is detected, protecting the inverter from damage.)
- b. Replace the defective components if the inverter is found to be defective.
- c. If both the compressor and the inverter are found to be defective, replace the defective component(s) of both devices.

(1) Inverter related defect identification and countermeasures

| | Error display/failure condition | Measure/inspection item |
|-----|---|---|
| [1] | Inverter related errors 4250, 4220, 4230, 4240, 4260, 5301, 0403, 5110 | Check the details of the inverter error in the error log at [9].[1] Check Code List. Perform the measures corresponding to the error code and error details determined using [9].[2] Responding to Error Display on the Remote Controller. |
| [2] | Main power breaker trip | a. Check the breaker capacity. b. Electrical system short circuit or grounding other than the inverter c. Refer to (3) - [1] if not a, or b. |
| [3] | Main power earth leakage breaker trip | a. Earth leakage breaker capacity/sensitivity current check b. Meg defect for electrical system other than the inverter c. Refer to (3) - [1] if not a, or b. |
| [4] | Only the compressor does not operate. | • Check the inverter frequency at the LED monitor and proceed to (2) - [3] if the status is operational. |
| [5] | The compressor always vibrates strongly or emits an abnormal noise. | Go to (2) - [3]. |
| [6] | Only the fan motor does not operate. | • Check the inverter frequency at the LED monitor and proceed to (2)-[6], [7] if status is operational. |
| [7] | The fan motor shakes violently at all times or makes an abnormal sound. | • Check the inverter frequency at the LED monitor and proceed to (2)-[6], [7] if status is operational. |
| [8] | Noise has penetrated the peripheral device | a. Check to ensure that power supply wiring, etc. of the peripheral device is not in close contact with the power supply wiring of outdoor unit. b. Check to ensure that the inverter output wiring is not in close contact with the power supply wiring and transmission lines. c. Check to ensure that the transmission line shield wiring is being used properly in the necessary environment, and that the shield wire ground is appropriate. d. Meg defect for electrical system other than the inverter. e. Attach a ferrite core to the inverter output wiring. (Please contact the factory for details of the service part settings.) f. Change the power to another system. g. If this problem occurs suddenly, there is a possibility that the inverter output is grounded. Proceed to (2) - [3]. • Contact the factory for cases other than those listed above. |
| [9] | Sudden malfunction (as a result of external noise.) | a. Check to ensure that the unit is grounded. b. Check to ensure that the transmission line shield wiring is being used properly in the necessary environment, and that the shield wire ground is appropriate. c. Check to ensure that the neither the transmission line or external connection wiring run close to another power supply system or run through the same conduct pipe. • Contact the factory for cases other than those listed above. |

- Notes: 1. Due to a large capacity electrolytic capacitor used in the inverter, voltage still flows through even after cutting the main power, creating the possibility of electric shock. As a result, wait for a sufficient length of time (5~10 minutes) after cutting the main power and check the voltage at both terminals of the electrolytic capacitor to performing any checks on the inverter.
2. Damage will result to the components of IPM, etc. if the inverter wiring is not properly secured with screws, or if the connector has not been properly inserted. It is likely that any errors occurring after replacing components are the result of wiring mistakes. Ensure that the wiring, screws, connectors and Faston, etc. are properly inserted.
 3. Do not remove or insert inverter connectors with the main power supply on, as this will result in damage to the PCB.
 4. The current sensor will be damaged if current flows without connecting to the PCB. Always insert connectors into the corresponding PCB when running the inverter.

(2) Treatment of inverter output related troubles

| | Check item | Phenomena | Treatment |
|--|--|--|---|
| [1] Check the INV board error detection circuit. | Perform the following: 1. Disconnect INV board CNDR2. After removing, turn on the outdoor unit and check the error status. (The compressor does not operate because CNDR2, which carries the IPM drive signal, has been disconnected.) | (1) IPM/overcurrent error. (4250 detailed No. 101, 102, 103, 104, 105, 106, 107) | • Replace INV board. |
| | | (2) Logic error (4250 detail No.111) | • Replace the INV board. |
| | | (3) ACCT sensor circuit error. (5301 detailed No. 115) | See to [9].[4].7.(4) "Current Sensor ACCT" Check the resistance and replace if erroneous. Replace the INV board if the ACCT status is normal. |
| | | (4) DCCT sensor circuit error. (5301 detailed No. 116) | • Replace the DCCT After replacing the DCCT, operate the outdoor unit again. In the case when the error occurs again, replace the INV board. (The DCCT may be no problem.) |
| | | (5) IPM open error (5301 detail No.119) | • Normal |
| [2] Check for compressor ground fault or coil error. | Disconnect the compressor wiring, and check the compressor Meg, and coil resistance. | (1) Compressor Meg failure Error if less than 1MΩ. •When no refrigerant is accumulated in the compressor. (2) Compressor coil resistance failure Coil resistance value of 0.16Ω (20°C) | • Replace compressor Check whether the refrigerant is accumulating in the compressor again. |
| [3] Check to see if the inverter is damaged. •Perform this check if an error occurs immediately before or after turning on the compressor. | Perform the following: 1. Reconnect the connector removed at item [1]. 2. Disconnect the compressor wiring. 3. Turn on SW1-1 on the INV board. Operate the outdoor unit after above steps. Check the inverter output voltage. •It is recommend to use the test rused to determine the [9].[4].7.(5) IPM troubleshooting when checking the inverter output voltage. •Measure when the inverter output frequency is stable. | (1) IPM/overcurrent error. (4250 detailed No. 101, 102, 103, 104, 105, 106, 107) | • Refer to item [5] for inverter circuit trouble. |
| | | (2) There is a high possibility of an inverter circuit error if the voltage unbalance across all wiring is greater than the larger of the values represented by 5% or 5V. | |
| | | (3) No voltage unbalance across all wiring | See item [2]. Proceed to item [5] however if there is no problem at [2]. Replace the compressor if there is no problem at [5]. |
| [4] Check to see if the inverter is damaged. •Perform this check if an error occurs during steady operation. | Turn on the outdoor unit. Check the inverter output voltage. •It is recommend to use the test rused to determine the [9].[4].7.(5) IPM troubleshooting when checking the inverter output voltage. •Measure when the inverter output frequency is stable. | (1) There is a high possibility of an inverter circuit error if the voltage unbalance across all wiring is greater than the larger of the values represented by 5% or 5V. | • Refer to item [5] for inverter circuit trouble. |
| | | (2) No voltage unbalance across all wiring | See item [2]. Proceed to item [5] however if there is no problem at [2]. Replace the compressor if there is no problem at [5]. |

| | Check item | Phenomena | Treatment |
|--|--|--|---|
| [5] Check the inverter circuit trouble. | 1. Check to see if the IPM screw terminal is loose. | (1) Screw terminal is loose. | Check all IPM screw terminals and tighten. |
| | 2. Check the exterior of the IPM. | (2) IPM is cracked due to swelling. | <ul style="list-style-type: none"> • IPM replacement Check the operation in [3] or [4] after replacing the IPM. In the case of an output voltage unbalance or error recurrence: →Replace the G/A board In the case of an output voltage unbalance or error recurrence after replacement: →Replace the INV board |
| | 3. Check the resistances between each terminal of IPM. Refer to [9].[4].7.(5) for details on IPM troubleshooting. | (3) Resistance error between each terminal of IPM. | <ul style="list-style-type: none"> • IPM replacement Check the operation in [3] or [4] after replacing the IPM. In the case of an output voltage unbalance or error recurrence: →Replace the G/A board In the case of an output voltage unbalance or error recurrence after replacement: →Replace the INV board |
| | | (4) All normal for items (1) ~ (3) above. | <ul style="list-style-type: none"> • IPM replacement In the case of an output voltage unbalance or error recurrence after replacement: →Replace the G/A board In the case of an output voltage unbalance or error recurrence after replacement: →Replace the INV board |

(3) Trouble measures when main power breaker tripped

| Check item | Phenomena | Treatment |
|--|--|--|
| [1] Perform Meg check between the terminals in the power terminal block TB1. | (1) Zero to several ohm, or Meg failure. | Check each part in the main inverter circuit. • Refer to "Simple checking Procedure for individual components of main inverter circuit". a. Diode Stack b. IPM c. Rush current protection resistor d. Electromagnetic relay e. DC reactor f. Noise filter |
| [2] Turn on the power again and check once more. | (1) Main power breaker trip | |
| | (2) No remote control display | |
| [3] Turn on the outdoor unit and check that it operates normally. | (1) Operates normally without tripping the main breaker. | a. There is a possibility that the wiring shorted momentarily. Trace the short and repair. b. If a. above is not the case, there is a possibility that there was a compressor failure. |
| | (2) Main power breaker trip | • A compressor ground fault can be considered. Go to (2) - [2]. |

(4) Simple checking procedure for individual components of main inverter circuit

* Before checking, cut the power off and remove the required parts from the control box.

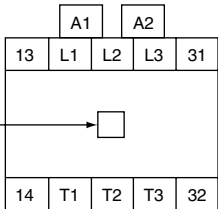
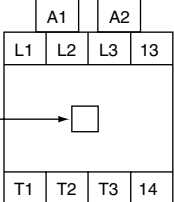
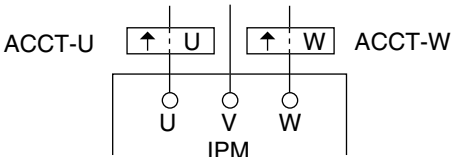
| Part name | Judgement method | | | | | | | | | | | | | | | | | | | | | | | | | | |
|--|--|------------------------|-----------------|-------|------------|-------------------------|-------|------------------------|-------|----|-------|----|-------|----|-------|---|------------|-------|---|-------|----|-------|----|-------|----|-------|------------------------|
| Diode stack | Refer to "Determining diode stack troubleshooting" ([9].[4].7.(6)) | | | | | | | | | | | | | | | | | | | | | | | | | | |
| IPM (Intelligent power module) | Refer to "Determining IPM interference" ([9].[4].7.(5)) | | | | | | | | | | | | | | | | | | | | | | | | | | |
| Rush current protection resistor R11, R12 | Measure the resistance between terminals: $47\Omega \pm 10\%$ | | | | | | | | | | | | | | | | | | | | | | | | | | |
| Electromagnetic contactor (52C1, 52C2, 52F) | <p>[In the case of 52C1, 52C2]</p>  <p>[In the case of 52F]</p>  <table border="1" style="margin-left: 20px;"> <thead> <tr> <th>Checking position</th> <th>Judgement value</th> </tr> </thead> <tbody> <tr> <td>A1-A2</td> <td>0.1k~2.0kΩ</td> </tr> <tr> <td rowspan="5">Button ON (pushdown)</td> <td>L1-T1</td> <td>1Ω or less (Almost 0Ω)</td> </tr> <tr> <td>L2-T2</td> <td>//</td> </tr> <tr> <td>L3-T3</td> <td>//</td> </tr> <tr> <td>13-14</td> <td>//</td> </tr> <tr> <td>31-32</td> <td>∞</td> </tr> <tr> <td rowspan="5">Button OFF</td> <td>L1-T1</td> <td>∞</td> </tr> <tr> <td>L2-T2</td> <td>//</td> </tr> <tr> <td>L3-T3</td> <td>//</td> </tr> <tr> <td>13-14</td> <td>//</td> </tr> <tr> <td>31-32</td> <td>1Ω or less (Almost 0Ω)</td> </tr> </tbody> </table> | Checking position | Judgement value | A1-A2 | 0.1k~2.0kΩ | Button ON (pushdown) | L1-T1 | 1Ω or less (Almost 0Ω) | L2-T2 | // | L3-T3 | // | 13-14 | // | 31-32 | ∞ | Button OFF | L1-T1 | ∞ | L2-T2 | // | L3-T3 | // | 13-14 | // | 31-32 | 1Ω or less (Almost 0Ω) |
| Checking position | Judgement value | | | | | | | | | | | | | | | | | | | | | | | | | | |
| A1-A2 | 0.1k~2.0kΩ | | | | | | | | | | | | | | | | | | | | | | | | | | |
| Button ON (pushdown) | L1-T1 | 1Ω or less (Almost 0Ω) | | | | | | | | | | | | | | | | | | | | | | | | | |
| | L2-T2 | // | | | | | | | | | | | | | | | | | | | | | | | | | |
| | L3-T3 | // | | | | | | | | | | | | | | | | | | | | | | | | | |
| | 13-14 | // | | | | | | | | | | | | | | | | | | | | | | | | | |
| | 31-32 | ∞ | | | | | | | | | | | | | | | | | | | | | | | | | |
| Button OFF | L1-T1 | ∞ | | | | | | | | | | | | | | | | | | | | | | | | | |
| | L2-T2 | // | | | | | | | | | | | | | | | | | | | | | | | | | |
| | L3-T3 | // | | | | | | | | | | | | | | | | | | | | | | | | | |
| | 13-14 | // | | | | | | | | | | | | | | | | | | | | | | | | | |
| | 31-32 | 1Ω or less (Almost 0Ω) | | | | | | | | | | | | | | | | | | | | | | | | | |
| DC reactor DCL | Measure the resistance between terminals: 1Ω or lower (almost 0Ω) Measure the resistance between terminals and the chassis : ∞ | | | | | | | | | | | | | | | | | | | | | | | | | | |
| Current sensor ACCT | <p>Disconnect the CNCT2 target connector and check the resistance between terminals: $280\Omega \pm 30\Omega$ 1-2PIN (U-phase) 3-4PIN (W-phase)</p>  <p style="text-align: right;">* Check the ACCT connecting phase and direction.</p> | | | | | | | | | | | | | | | | | | | | | | | | | | |

(5) Intelligent power module (IPM)

Measure resistances between each terminal of IPM with tester, and use the results for troubleshooting

Notes on measurement

- Make sure the polarity before the measurement. (On the tester, black normally indicates plus.)
- Make sure that the resistance is not open ($\infty\Omega$) or not shorted (to 0Ω).
- For the resistance, the margin of error is allowed.
- The result that is more than double or half than the result that is measured at the same measurement point is not allowed.

Tester restriction

- **Use the tester whose internal electrical power source is 1.5V or greater.**
- **Use the dry-battery-powered tester.**
(※The accurate diode-specific resistance cannot be measured with the button-battery-powered card tester, as the applied voltage is low.)

- **Use the range that measures low resistance as much as possible.**

The more accurate resistance can be measured.

• External view

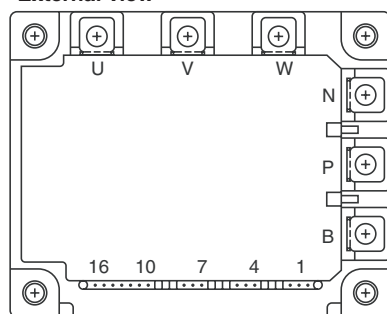

• Internal circuit diagram

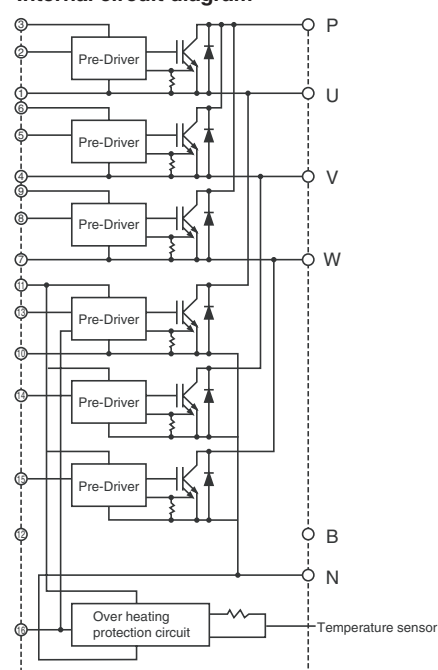

• Judgement value

| Black (+) \ Red (-) | P | N | U | V | W |
|---------------------|----------|----------------|----------------|----------------|----------------|
| P | - | ∞ | 5~200 Ω | 5~200 Ω | 5~200 Ω |
| N | ∞ | - | ∞ | ∞ | ∞ |
| U | ∞ | 5~200 Ω | - | - | - |
| V | ∞ | 5~200 Ω | - | - | - |
| W | ∞ | 5~200 Ω | - | - | - |

(6) Diode stack

Measure resistances between each terminal of diode stack with tester, and use the results for troubleshooting. Refer to (5) "Intelligent power module (IPM)" for notes on measurement and tester restriction.

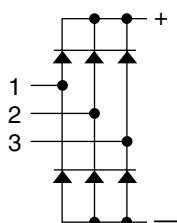
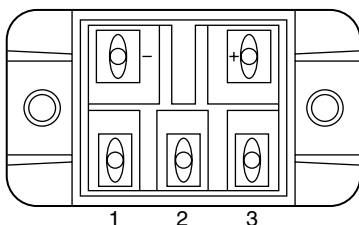

• Judgement value

| Black (+) \ Red (-) | + (P) | - (N) | ~ (1) | ~ (2) | ~ (3) |
|---------------------|----------|----------------|----------------|----------------|----------------|
| + (P) | - | ∞ | 5~200 Ω | 5~200 Ω | 5~200 Ω |
| - (N) | ∞ | - | ∞ | ∞ | ∞ |
| ~ (1) | ∞ | 5~200 Ω | - | - | - |
| ~ (2) | ∞ | 5~200 Ω | - | - | - |
| ~ (3) | ∞ | 5~200 Ω | - | - | - |

(7) Caution at replacement of inverter parts

(1) Fully check wiring for incorrect and loose connection.

The incorrect or loose connection of the power circuit part wiring like IPM and diode module causes to damage the IPM. Therefore, check the wiring fully. As the insufficient tightening of screws is difficult to find, tighten them together additionally after finishing other works. For the wiring of the base for IPM, observe the wiring diagram below carefully as it has many terminals.

(2) Coat the grease for radiation provided uniformly onto the radiation surface of IPM /diode modules.

Coat the grease for radiation on the full surface in a thin layer, and fix the module securely with the screw for fastening. As the radiation grease attached on the wiring terminal causes poor contact, wipe it off if attached.

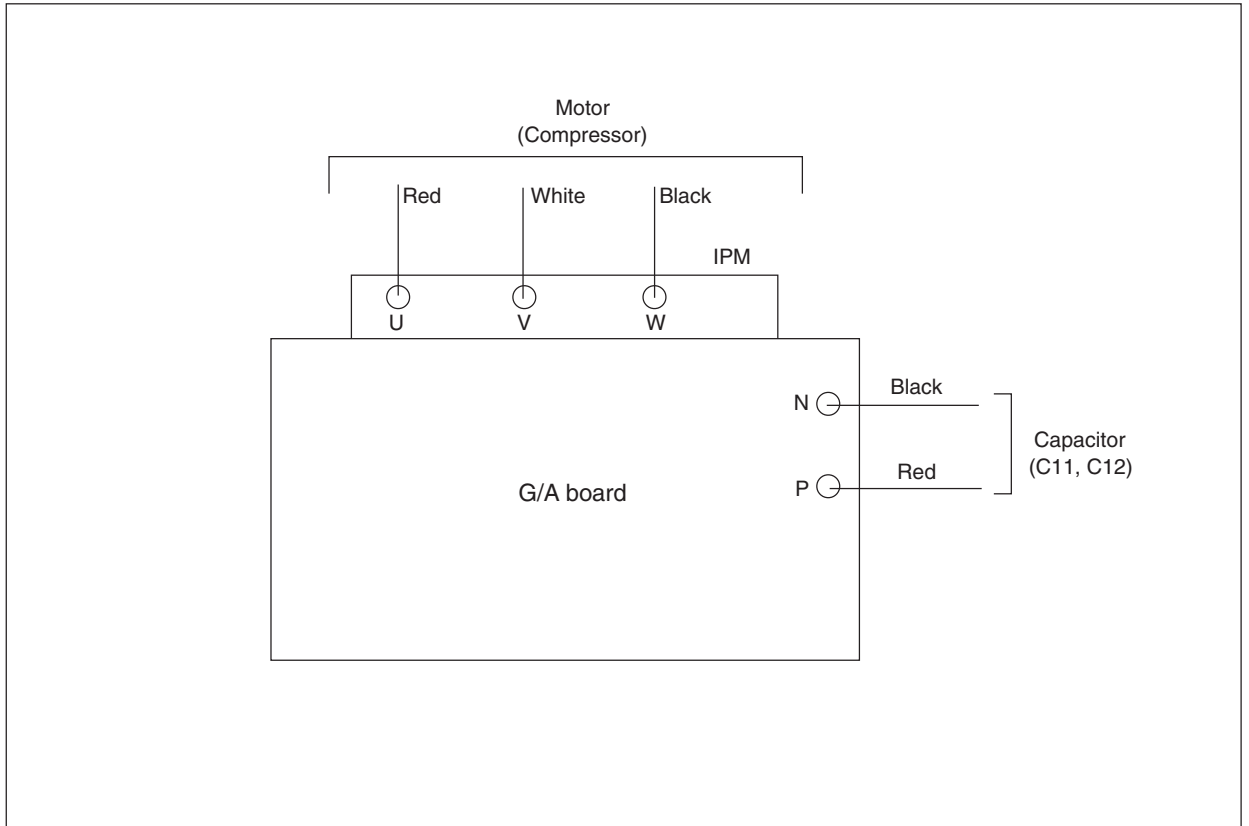

8. Control circuit

(1) Control power source function block

[P200~P500 types]

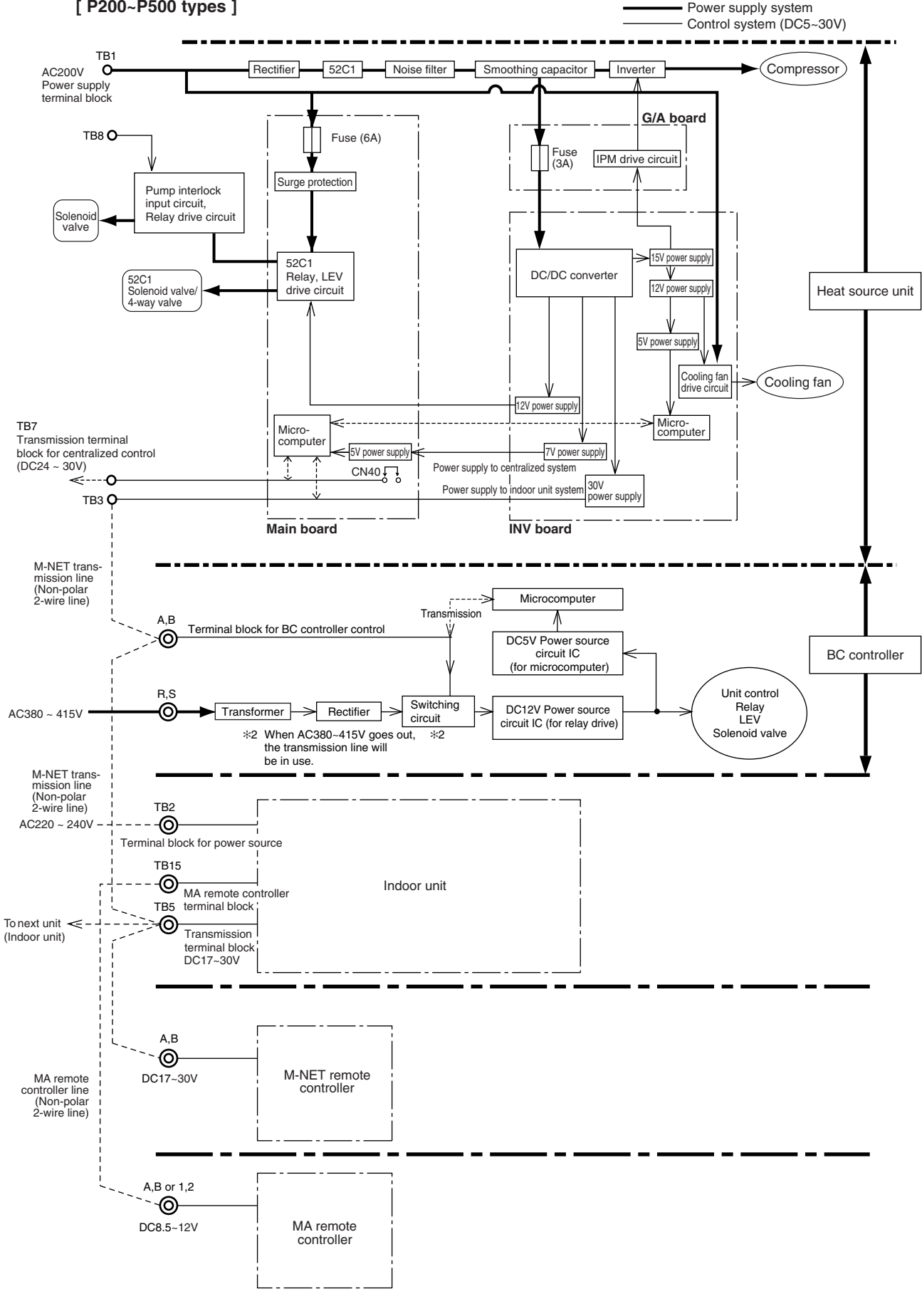

※ M-NET remote controller and MA remote controller can not be used together.

(2) Heat source unit transmission power source circuit failure judgment

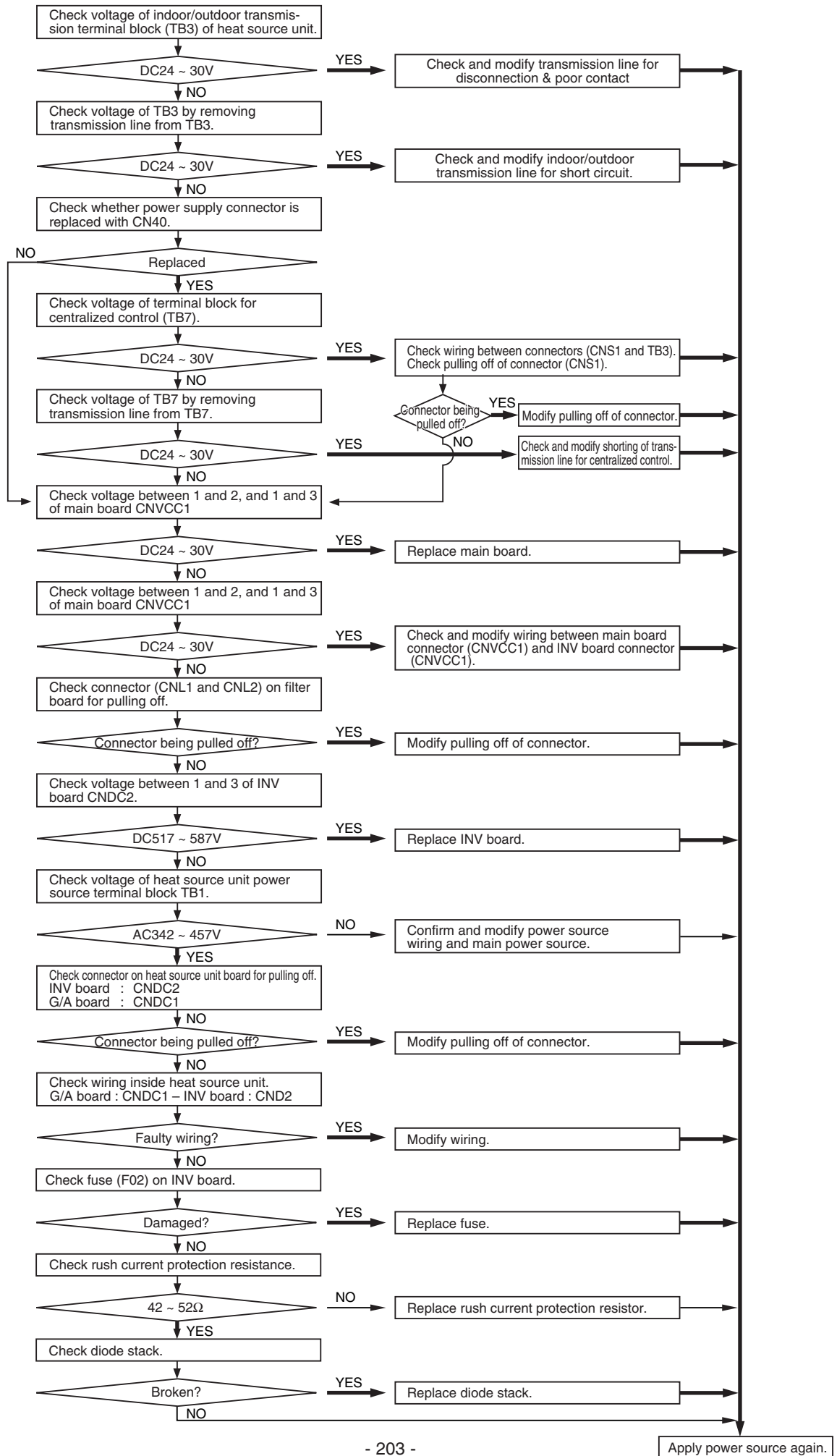

[5] Refrigerant Leak

<PQRY>

1. Leak spot: In the case of extended pipe for indoor unit (Cooling season)

- ① Mount a pressure gauge on the check joint (CJ2) for low-pressure service.
- ② Stop all the indoor units, and close the liquid ball valve (BV2) inside the heat source unit while the compressor is being stopped.
- ③ Stop all the indoor units; turn on SW3-6 on the heat source unit main board while the compressor is being stopped. (Pump down mode will start, and all the indoor unit will perform a test run in cooling mode.)
- ④ Under the pump down mode (SW3-6 is ON), the low-pressure pressure (LPS) becomes 0.382MPa or less, or all the indoor units automatically stop in 15 minutes after the pump mode starts.
When the value of the pressure gauge, which is on the check joint (CJ2) for low-pressure service, is 0.284MPa or when 20 minutes pass, stop all the indoor units and the compressor.
- ⑤ Close the low pressure ball valve (BV1) inside the heat source unit.
- ⑥ Wipe the refrigerant that remains in the extended pipe for the indoor unit.
Do not discharge refrigerant into air into the atmosphere when it is collected.
- ⑦ Repair the leak.
- ⑧ After repairing the leak, vacuum the extended pipe for the indoor unit.
- ⑨ To adjust refrigerant, open the ball valves (BV1 and BV2) inside the heat source unit and turn off SW3-6.

2. Leak spot: In the case of heat source unit (Cooling season)

- ① Conduct a test run for all the indoor units under the cooling mode.
 - (1) To start a test run for all the indoor units, turn on SW3-2 when SW3-1 on the heat source unit main board is ON.
 - (2) Change the setting of the remote controller for all the indoor units to the cooling mode.
 - (3) Check that all the indoor units are performing a cooling operation.
- ② Check the values of Tc and SC16.
(To display the values on the LED screen, use the self-diagnosis switch (SW1) on the heat source unit main board.)
 - (1) When SC16 is 10K or more See the next item ③.
 - (2) When SC16 is less than 10K After the compressor stops, wipe the refrigerant inside the system, repair the leak, perform evacuation, and recharge new refrigerant.
(Leak spot: In the case of heat source unit, handle in the same way as heating season.)

[SC16 self-diagnosis switch]



- ③ Stop all the indoor units, and stop the compressor.
 - (1) To stop all the indoor units and the compressor, turn off SW3-2 when SW3-1 on the heat source unit main board is ON.
 - (2) Check that all the indoor units are being stopped.
- ④ Close the ball valves (BV1 and BV2).
- ⑤ **To prevent the liquid seal, extract small amount of refrigerant from the check joint of the liquid ball valve (BV2), as the liquid seal may cause a malfunction of the unit.**
- ⑥ Collect the refrigerant that remains inside the heat source unit. Do not discharge refrigerant into air into the atmosphere when it is collected.
- ⑦ Repair the leak.
- ⑧ After repairing the leak, replace the dryer with the new one, and perform evacuation inside the heat source unit.
- ⑨ To adjust refrigerant, open the ball valves (BV1 and BV2) inside the heat source unit.

3. Leak spot: In the case of extended pipe for indoor unit (Heating season)

- ① Conduct a test run for all the indoor units under the heating mode.
 - (1) To start a test run for all the indoor units, turn on SW3-2 when SW3-1 on the heat source unit main board is ON.
 - (2) Change the setting of the remote controller for all the indoor units to the heating mode.
 - (3) Check that all the indoor units are performing a heating operation.
- ② Stop all the indoor units, and stop the compressor.
 - (1) To stop all the indoor units and the compressor, turn off SW3-2 when SW3-1 on the heat source unit main board is ON.
 - (2) Check that all the indoor units are being stopped.
- ③ Close the ball valves (BV1 and BV2).
- ④ Collect the refrigerant that remains inside the heat source unit. Do not discharge refrigerant into air into the atmosphere when it is collected.
- ⑤ Repair the leak.
- ⑥ After repairing the leak, perform evacuation of the extended pipe for the indoor unit, and open the ball valves (BV1 and BV2) to adjust refrigerant.

4. Leak spot: In the case of heat source unit (Heating season)

- ① Collect the refrigerant in the entire system (heat source unit, extended pipe and indoor unit). Do not discharge refrigerant into the atmosphere when it is collected.
- ② Repair the leak.
- ③ After repairing the leak, replace the dryer with the new one, and perform evacuation of the entire system, and calculate the standard amount of refrigerant to be added (for heat source unit, extended pipe and indoor unit), and charge the refrigerant. For the amount of refrigerant, refer to [8].[4].3.

<PQHY>

1. Leak spot: In the case of extended pipe for indoor unit (Cooling season)

- ① Mount a pressure gauge on the check joint (CJ2) for low-pressure service.
- ② Stop all the indoor units, and close the liquid ball valve (BV2) inside the heat source unit while the compressor is being stopped.
- ③ Stop all the indoor units; turn on SW3-6 on the heat source unit main board while the compressor is being stopped. (Pump down mode will start, and all the indoor unit will perform a test run in cooling mode.)
- ④ Under the pump down mode (SW3-6 is ON), the low-pressure pressure (LPS) becomes 0.382MPa or less, or all the indoor units automatically stop in 15 minutes after the pump mode starts.
When the value of the pressure gauge, which is on the check joint (CJ2) for low-pressure service, is 0.284MPa or when 20 minutes pass, stop all the indoor units and the compressor.
- ⑤ Close the gas ball valve (BV1) inside the heat source unit.
- ⑥ Wipe the refrigerant that remains in the extended pipe for the indoor unit.
Do not discharge refrigerant into air into the atmosphere when it is collected.
- ⑦ Repair the leak.
- ⑧ After repairing the leak, vacuum the extended pipe for the indoor unit.
- ⑨ To adjust refrigerant, open the ball valves (BV1 and BV2) inside the heat source unit and turn off SW3-6.

2. Leak spot: In the case of heat source unit (Cooling season)

- ① Conduct a test run for all the indoor units under the cooling mode.
 - (1) To start a test run for all the indoor units, turn on SW3-2 when SW3-1 on the heat source unit main board is ON.
 - (2) Change the setting of the remote controller for all the indoor units to the cooling mode.
 - (3) Check that all the indoor units are performing a cooling operation.
- ② Check the values of Tc and TH7.
(To display the values on the LED screen, use the self-diagnosis switch (SW1) on the heat source unit main board.)
 - (1) When Tc-TH7 is 10K or more See the next item ③.
 - (2) When Tc-TH7 is less than 10K After the compressor stops, wipe the refrigerant inside the system, repair the leak, perform evacuation, and recharge new refrigerant.
(Leak spot: In the case of heat source unit, handle in the same way as heating season.)

[Tc self-diagnosis switch]



[TH7 self-diagnosis switch]



- ③ Stop all the indoor units, and stop the compressor.
 - (1) To stop all the indoor units and the compressor, turn off SW3-2 when SW3-1 on the heat source unit main board is ON.
 - (2) Check that all the indoor units are being stopped.
- ④ Close the ball valves (BV1 and BV2).
- ⑤ **To prevent the liquid seal, extract small amount of refrigerant from the check joint of the liquid ball valve (BV2), as the liquid seal may cause a malfunction of the unit.**
- ⑥ Collect the refrigerant that remains inside the heat source unit. Do not discharge refrigerant into air into the atmosphere when it is collected.
- ⑦ Repair the leak.
- ⑧ After repairing the leak, replace the dryer with the new one, and perform evacuation inside the heat source unit.
- ⑨ To adjust refrigerant, open the ball valves (BV1 and BV2) inside the heat source unit.

Note : When the power for the heat source/indoor unit must be turned off to repair the leak after closing the ball valves specified in the item ④, **turn the power off in approximately one hour after the heat source/indoor units stop.**

- a) If the power for the heat source unit is turned off within 30 minutes after the item ④,
→ When the stop mode continues for 30 minutes in a row, the indoor unit LEV turns from fully closed to faintly open to prevent the liquid seal inside the liquid pipe. Therefore, when the power for the indoor unit is turned off within 30 minutes after the heat source unit stops, liquid will be sealed.
- b) Even if the heat source unit LEV turns from fully closed to faintly open within 30 minutes after the heat source unit stops, do not turn off the power for indoor/heat source unit until the refrigerant inside the liquid pipe discharges into the indoor unit and into the gas pipe.
→ When only the power for the indoor unit is turned off, the indoor unit LEV turns from faintly open to fully closed.

3. Leak spot: In the case of extended pipe for indoor unit (Heating season)

- ① Conduct a test run for all the indoor units under the heating mode.
 - (1) To start a test run for all the indoor units, turn on SW3-2 when SW3-1 on the heat source unit main board is ON.
 - (2) Change the setting of the remote controller for all the indoor units to the heating mode.
 - (3) Check that all the indoor units are performing a heating operation.
- ② Stop all the indoor units, and stop the compressor.
 - (1) To stop all the indoor units and the compressor, turn off SW3-2 when SW3-1 on the heat source unit main board is ON.
 - (2) Check that all the indoor units are being stopped.
- ③ Close the ball valves (BV1 and BV2).
- ④ Collect the refrigerant that remains inside the heat source unit. Do not discharge refrigerant into air into the atmosphere when it is collected.
- ⑤ Repair the leak.
- ⑥ After repairing the leak, perform evacuation of the extended pipe for the indoor unit, and open the ball valves (BV1 and BV2) to adjust refrigerant.

4. Leak spot: In the case of heat source unit (Heating season)

- ① Collect the refrigerant in the entire system (heat source unit, extended pipe and indoor unit). Do not discharge refrigerant into the atmosphere when it is collected.
- ② Repair the leak.
- ③ After repairing the leak, replace the dryer with the new one, and perform evacuation of the entire system, and calculate the standard amount of refrigerant to be added (for heat source unit, extended pipe and indoor unit), and charge the refrigerant. For the amount of refrigerant, refer to [8].[4].3.

[6] BC controller service instruction

(1) Service panel

*Special care must be taken when replacing heavy parts.

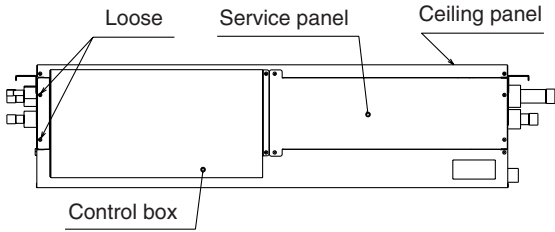
| Work procedure | Explanatory figure |
|---|--|
| <ol style="list-style-type: none"> 1. Remove 2 lock nuts on the control box, loose 2 lock nuts, and remove the control box. 2. Remove 4 fixing screws on the service panel, and remove the service panel. 3. Remove 9 machine screws on the ceiling panel, and remove the ceiling panel. |  |

(2) Control box

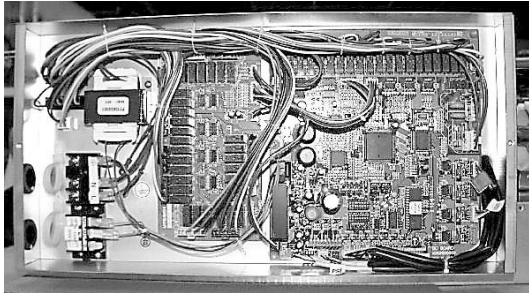
| Work procedure | Explanatory figure |
|--|--|
| <ol style="list-style-type: none"> 1. To check the inside of the control box, remove 2 lock nuts on the control box cover. <ol style="list-style-type: none"> ① Check the power wire and the terminal connection of the transmission line. ② Check the transformer. ③ Check the address switch. 2. When replacing the control board, take special care to the following points. <ol style="list-style-type: none"> ① Check that the board type is G or GA. ② Check that the wire or the connector is not connected wrongly, not disconnected or not loose. <p>Note) It is not required to remove 2 fixing screws on the control box when checking the inside.</p> |  <p style="text-align: center;">CMB-1016V-G, 1016V-GA</p> |

(3) Thermistor (liquid pipe/gas pipe temperature detection)

*Special care must be taken when replacing heavy parts.

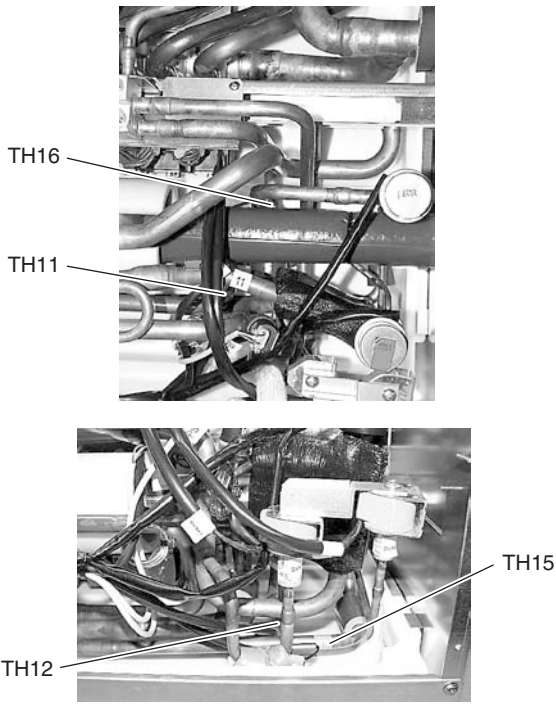
| Work procedure | Explanatory figure |
|---|--|
| <ol style="list-style-type: none"> 1. Remove the service panel. <ol style="list-style-type: none"> ① For TH11, TH12 and TH15, refer to (1)-1.2. ② For TH16, refer to (1)-1.2.3. 2. Remove the lead wire of the piping sensor from the control board. <ol style="list-style-type: none"> ① TH11, TH12 (CN10) ② TH15, TH16 (CN11) <p>Note) It is not required to remove 2 fixing screws on the control box when checking the inside.</p> 3. Pull out the temperature sensor from the temperature sensor housing, and replace the temperature sensor with the new one. 4. Connect the lead wire of the temperature sensor securely on the control board. |  <p style="text-align: center;">CMB-1016V-GA</p> |

(4) Pressure sensor

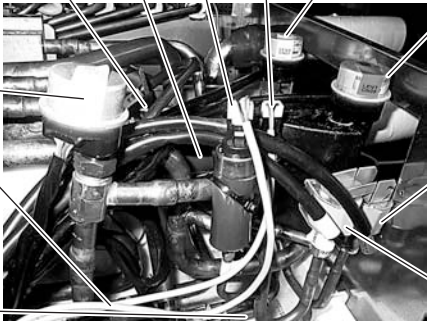
| Work procedure | Explanatory figure |
|---|---|
| <ol style="list-style-type: none"> 1. Remove the service panel. ① For the pressure sensors PS1 and PS3, refer to (1)-1.2. 2. Remove the applied pressure sensor connector from the control board, and insulate the connector. ① Liquid-side pressure sensor (CNP1) ② Intermediate-part pressure sensor (CNP3) 3. Attach a new pressure sensor to the place which is shown in the figure, and insert the connector to the control board. <p>Note) When the gas leaks from the pressure sensor, fix the leakage, and follow the instructions above if required.</p> |  <p style="text-align: center;">CMB-1016V-GA</p> <p>※ For G-type, there is no SVM2.</p> |

(5) LEV

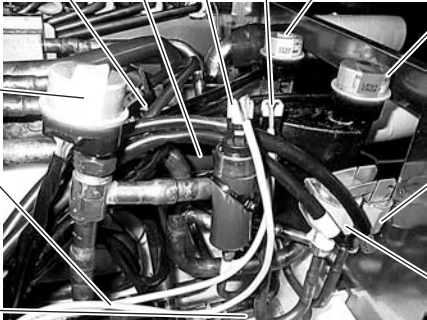
| Work procedure | Explanatory figure |
|--|--|
| <ol style="list-style-type: none"> 1. Remove the service panel. (Refer to (1)-2. 3.) 2. Replace the applied LEV. <p>Note) · Secure enough service space in the ceiling for welding operation, and conduct the work carefully. · If required, dismantle the unit from the ceiling, and conduct the work.</p> |  <p style="text-align: center;">CMB-1016V-GA</p> <p>※ For G-type, there is no SVM2.</p> |

(6) Solenoid valve

*Special care must be taken when replacing heavy parts.

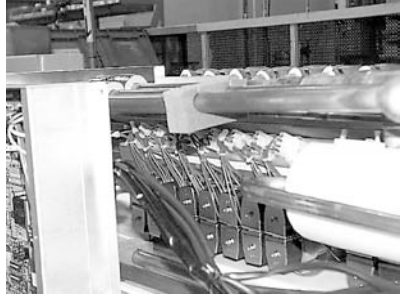
| Work procedure | Explanatory figure |
|---|--|
| <p>1. Remove the service panel. (Refer to (1)-1.2.3.)</p> <p>2. Remove the connector of the applied solenoid valve.</p> <p>3. Remove the solenoid valve coil. ① For the solenoid valve coil of SVA, SVB and SVM1, 2 service from the inspection door is possible. For SVC, however, remove the rear panel (4 machine screws) to replace the coil, if enough service space is secured at the rear. (Only GA type for SVM1 and 2)</p> | <p>Double pipe heat exchanger</p>  <p>Solenoid valve CMB-1016V-G</p>  <p>CMB-1016V-GA</p> |

10 LED display

[1] LED Monitor Display

1. How to read LED for service monitor

By setting of DIP SW1-1 ~ 1-10, the unit operating condition can be observed with the service LED on the control circuit board. (For the relation of each DIP SW to the content, see the table provided.)

As shown in the figure below, the LED consist of 7 segments is put in 4 sets side by side for numerical and graphic display.

| | | |
|---|---------------------------------|--------------------------------|
| OC : Outdoor (Heat source) unit | SV : Solenoid valve | THHS : Inverter radiator panel |
| IC : Indoor unit L | EV : Electronic expansion valve | Th : Thermistor |
| | COMP : Compressor | |
| SW1 : Heat source unit control circuit board | | |
| E : Memory storage for service activities (sampling per minute) | | |

7 seg LED

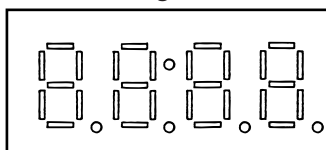

The numerical display includes that of pressure, temperature or the like, while the graphic display includes that of operating condition, solenoid valve ON/OFF state or the like.

- Numerical display

Example : Display at 18.8kg/cm²G (1.84MPa) of pressure sensor data (Item No. 72)

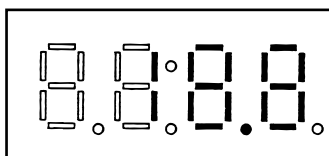

- Graphic display (Two LEDs aligned vertically express a flag.)

Example : At forcible powering in heat source unit operation display (Item No. 14)

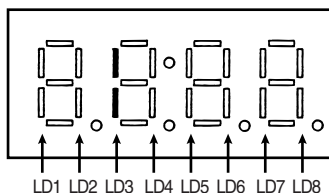

2. LED display at initial setting

After turning the power on, the following model information will be displayed until the initial setting is done.

(Repeat No① → ② → ③ → ④)

| No | SW1 | Item | Display | Remark |
|----|------------|----------------------|---------|---|
| ① | Irrelevant | Software version | 8888 | [0103] Version1.03 |
| ② | | Refrigerant type | 8888 | [410] R410A |
| ③ | | Unit type & capacity | 8888 | [C-08] PUY 8 horsepower [H-20] PUHY 20 horsepower [r-10] PURY 10 horsepower |
| ④ | | M-NET address | 8888 | [51] 51 address |

This LED display can be seen after the initial setting when No517, monitor display, setting is made.

3. Time data storage function

※ This function is not compatible with some units.

The heat source unit has a simple clock function to receive the time setting from the system controller, such as the G-50A, and count the current time with an internal timer.

If an error (prediction) occurs, the error history data and the error detection time are saved in the service memory.

The error detection time saved in the service memory and the current time can be confirmed with the service LEDs.

Notes: 1. This is a simple clock function so the time should be used only for reference.

2. The date and time data is all set to 00 as the default.

If a system controller that sets the time in the heat source unit, such as the G-50A, is not connected, the time and days elapsed from the first time the power was turned on will be displayed.

If the time setting has been received, the count will start from the set date and time.

3. The time data is not updated when the heat source unit's power is off. When the power is turned off and then on again, the count will resume from the time before the power was turned off. Thus, a time differing from the actual time will be saved. (This also applies when a power failure occurs)

The system controller, such as the G-50A, sets the time once a day. Thus, if this type of system controller is connected, the time will be updated to the correct time after the settings are received.

(The data stored in the memory before the settings are received will not be corrected.)

Reading the time data:

- For time display

Example : 9 hours 12 minutes



" ." disappears if the time data is deviated due to a power failure, or if a system controller for setting the time is not connected.

- Date display

(1) When upward controller that can set time is connected

Example : May 10, 2003

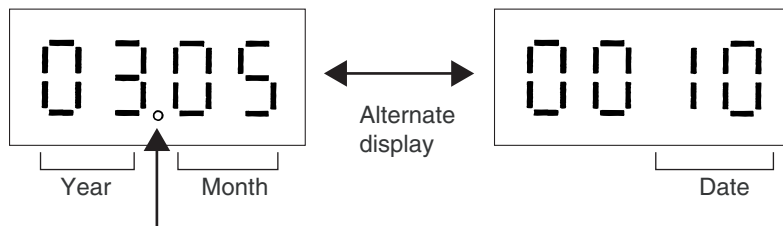

※ The year and month display uses " ." . The date display has no " ." .

(2) When upward controller that can set time is not connected

Example : 52 days after power was turned ON

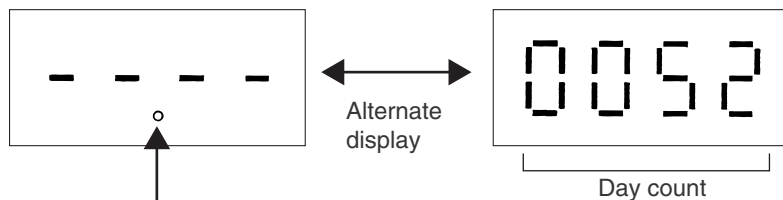

※ The year and month display uses " ." . The date display has no " ." .

4. List of code on the LED monitor

LED monitor display

| No. | SW1 | Item | LED | | | | | | | | Remarks | |
|-----|------------|--|--|------------------|-----------------------------------|----------------------|-------------------|------------|---|-------------------------------------|---|---|
| | 1234567890 | | LD1 | LD2 | LD3 | LD4 | LD5 | LD6 | LD7 | LD8 | | |
| 0 | 0000000000 | Relay output display 1 (lighting to display) | Comp operation | Comp 1 operation | | | | 52C1 | | | Lights for normal operation | LD8 is a relay output which lights up at all times when the microcomputers power is on. |
| | | Check display 1 OC error | 0000 ~ 9999 (Address and error code reversed) | | | | | | | | | |
| 1 | 1000000000 | Check display 2 OC preliminary error | 0000 ~ 9999 (Address and error code reversed) | | | | | | | | Display the latest preliminary error. If there is no error, "----" is displayed. | |
| 2 | 0100000000 | Check code 3 (including IC and BC) | 0000 ~ 9999 (Address and error code reversed) | | | | | | | | If there is no error "----" is displayed. | |
| 3 | 1100000000 | Relay output display 2 | 21S4a | 21S4b | | CH11 | | | | | | |
| 4 | 0010000000 | Relay output display 3 | SV1 | | | SV4a | SV4b | SV4c | | | | |
| 5 | 1010000000 | Relay output display 4 | SV5a | SV5b | | | SV4d | | | | | |
| 6 | 0110000000 | Relay output display 5 | SV7a | SV7b | SV7c | | | | | | | |
| 7 | 1110000000 | | | | | | | | | | | |
| 8 | 0001000000 | | | | | | | | | | | |
| 9 | 1001000000 | Communication demand capacity | 0000 ~ 9999 | | | | | | | | If no demand control, "----" is displayed [%]. | |
| 10 | 0101000000 | Contact demand capacity | 0000 ~ 9999 | | | | | | | | If no demand control, "----" is displayed [%]. | |
| 11 | 1101000000 | External signal [signal during input] | Contact demand | Night mode | | | | | | | | |
| 12 | 0011000000 | External signal | | Pump interlock | | | | | | | | |
| 13 | 1011000000 | | | | | | | | | | | |
| 14 | 0111000000 | Outdoor unit operation display | BC operation | Warm up mode | 3 minutes restart protection mode | Compressor operation | Preliminary error | Error | 3 minutes restart after instantaneous power failure | Vacuum operation protection delayed | | Displayed only by R2 and WR2 systems. |
| 15 | 1111000000 | | | | | | | | | | | |
| 16 | 0000100000 | Indoor unit check | Unit No.1 | Unit No.2 | Unit No.3 | Unit No.4 | Unit No.5 | Unit No.6 | Unit No.7 | Unit No.8 | If the IC makes an error stop, lit up Unit No.1 can be lit out with error rest in order from small address. | |
| 17 | 1000100000 | | Unit No.9 | Unit No.10 | Unit No.11 | Unit No.12 | Unit No.13 | Unit No.14 | Unit No.15 | Unit No.16 | | |
| 18 | 0100100000 | | Unit No.17 | Unit No.18 | Unit No.19 | Unit No.20 | Unit No.21 | Unit No.22 | Unit No.23 | Unit No.24 | | |
| 19 | 1100100000 | | Unit No.25 | Unit No.26 | Unit No.27 | Unit No.28 | Unit No.29 | Unit No.30 | Unit No.31 | Unit No.32 | | |
| 20 | 0010100000 | | | | | | | | | | | |
| 21 | 1010100000 | | | | | | | | | | | |
| 22 | 0110100000 | | | | | | | | | | | |
| 23 | 1110100000 | Indoor unit operation mode | Unit No.1 | Unit No.2 | Unit No.3 | Unit No.4 | Unit No.5 | Unit No.6 | Unit No.7 | Unit No.8 | Lights up during cooling. Blinks during heating. Goes off during stop and blower mode. | |
| 24 | 0001100000 | | Unit No.9 | Unit No.10 | Unit No.11 | Unit No.12 | Unit No.13 | Unit No.14 | Unit No.15 | Unit No.16 | | |
| 25 | 1001100000 | | Unit No.17 | Unit No.18 | Unit No.19 | Unit No.20 | Unit No.21 | Unit No.22 | Unit No.23 | Unit No.24 | | |
| 26 | 0101100000 | | Unit No.25 | Unit No.26 | Unit No.27 | Unit No.28 | Unit No.29 | Unit No.30 | Unit No.31 | Unit No.32 | | |
| 27 | 1101100000 | | | | | | | | | | | |
| 28 | 0011100000 | | | | | | | | | | | |
| 29 | 1011100000 | | | | | | | | | | | |

| No. | SW1 | Item | LED | | | | | | | | Remarks |
|-----|------------|---|------------------|------------------------|-----------------|------------------|---------------|--------------|--------------|------------------------------|---|
| | 1234567890 | | LD1 | LD2 | LD3 | LD4 | LD5 | LD6 | LD7 | LD8 | |
| 30 | 0111100000 | Indoor unit thermostat | Unit No.1 | Unit No.2 | Unit No.3 | Unit No.4 | Unit No.5 | Unit No.6 | Unit No.7 | Unit No.8 | Lights up when thermostat is on. Goes off when thermostat is off. |
| 31 | 1111100000 | | Unit No.9 | Unit No.10 | Unit No.11 | Unit No.12 | Unit No.13 | Unit No.14 | Unit No.15 | Unit No.16 | |
| 32 | 0000010000 | | Unit No.17 | Unit No.18 | Unit No.19 | Unit No.20 | Unit No.21 | Unit No.22 | Unit No.23 | Unit No.24 | |
| 33 | 1000010000 | | Unit No.25 | Unit No.26 | Unit No.27 | Unit No.28 | Unit No.29 | Unit No.30 | Unit No.31 | Unit No.32 | |
| 34 | 0100010000 | | | | | | | | | | |
| 35 | 1100010000 | | | | | | | | | | |
| 36 | 0010010000 | | | | | | | | | | |
| 37 | 1010010000 | BC operation mode | Cooling only ON | Cooling only OFF | Heating only ON | Heating only OFF | Mix ON | Mix OFF | Fan | Stop | Displayed only by R2 and WR2 systems. |
| 38 | 0110010000 | | | | | | | | | | |
| 39 | 1110010000 | Outdoor (Heat source) operation mode | Permissible stop | Standby | Cooling only | Cooling main | Heating only | Heating main | | | |
| 40 | 0001010000 | | | | | | | | | | |
| 41 | 1001010000 | | | | | | | | | | |
| 42 | 0101010000 | Outdoor (Heat source) unit control mode | Stop | Thermo OFF | Error stop | Regular control | Initial start | Defrost | Oil recovery | Low frequency oil collection | |
| 43 | 1101010000 | | Warm up | Refrigerant collection | | | | | | | |
| 44 | 0011010000 | | | | | | | | | | |
| 45 | 1011010000 | TH11 | | | | | | | | | The unit is [°C]. |
| 46 | 0111010000 | | | | | | | | | | |
| 47 | 1111010000 | | | | | | | | | | |
| 48 | 0000110000 | TH5 (WY) | | | | | | | | | |
| 49 | 1000110000 | TH6 | | | | | | | | | |
| 50 | 0100110000 | TH7 (WY) | | | | | | | | | |
| 51 | 1100110000 | TH8 (WY) | | | | | | | | | |
| 52 | 0010110000 | | | | | | | | | | |
| 53 | 1010110000 | | | | | | | | | | |
| 54 | 0110110000 | TH9 | | | | | | | | | |
| 55 | 1110110000 | | | | | | | | | | |
| 56 | 0001110000 | THINV | | | | | | | | | |
| 57 | 1001110000 | | | | | | | | | | |
| 58 | 0101110000 | | | | | | | | | | |
| 59 | 1101110000 | | | | | | | | | | |
| 60 | 0011110000 | THHS1 | | | | | | | | | The unit is [°C]. |
| 61 | 1011110000 | | | | | | | | | | |
| 62 | 0111110000 | | | | | | | | | | |
| 63 | 1111110000 | | | | | | | | | | |
| 64 | 0000001000 | | | | | | | | | | |
| 65 | 1000001000 | | | | | | | | | | |
| 66 | 0100001000 | | | | | | | | | | |
| 67 | 1100001000 | | | | | | | | | | |
| 68 | 0010001000 | | | | | | | | | | |
| 69 | 1010001000 | | | | | | | | | | |
| 70 | 0110001000 | | | | | | | | | | |

| No. | SW1 | Item | LED | | | | | | | | Remarks |
|-----|------------|---|-----|-----|-----|-----|---------------|-----|-----|-----|---|
| | 1234567890 | | LD1 | LD2 | LD3 | LD4 | LD5 | LD6 | LD7 | LD8 | |
| 71 | 1110001000 | | | | | | | | | | |
| 72 | 0001001000 | High pressure | | | | | -99.9 ~ 999.9 | | | | The unit is [kgf/cm ²]. |
| 73 | 1001001000 | Low pressure | | | | | ↑ | | | | |
| 74 | 0101001000 | | | | | | | | | | |
| 75 | 1101001000 | | | | | | | | | | |
| 76 | 0011001000 | | | | | | | | | | |
| 77 | 1011001000 | | | | | | | | | | |
| 78 | 0111001000 | $\Sigma Qj (= \Sigma Qjc + \Sigma Qjh)$ | | | | | 0000 ~ 9999 | | | | |
| 79 | 1111001000 | ΣQjc | | | | | ↑ | | | | |
| 80 | 0000101000 | ΣQjh | | | | | ↑ | | | | |
| 81 | 1000101000 | Target condenser temp. Tc | | | | | -99.9 ~ 999.9 | | | | The unit is [°C]. |
| 82 | 0100101000 | Target condenser temp. Te | | | | | ↑ | | | | |
| 83 | 1100101000 | Tc | | | | | ↑ | | | | |
| 84 | 0010101000 | Te | | | | | ↑ | | | | |
| 85 | 1010101000 | | | | | | | | | | |
| 86 | 0110101000 | | | | | | | | | | |
| 87 | 1110101000 | All temporary frequency | | | | | 0000 ~ 9999 | | | | Control data [Hz]. |
| 88 | 0001101000 | COMP1 control frequency | | | | | ↑ | | | | |
| 89 | 1001101000 | | | | | | | | | | |
| 90 | 0101101000 | | | | | | | | | | Operating frequency of compressor [Hz]. ※1 |
| 91 | 1101101000 | COMP1 output frequency | | | | | 0000 ~ 9999 | | | | |
| 92 | 0011101000 | | | | | | | | | | |
| 93 | 1011101000 | | | | | | | | | | Control data |
| 94 | 0111101000 | AK1 | | | | | 0000 ~ 9999 | | | | |
| 95 | 1111101000 | | | | | | | | | | |
| 96 | 0000011000 | | | | | | | | | | |
| 97 | 1000011000 | | | | | | | | | | |
| 98 | 0100011000 | | | | | | | | | | |
| 99 | 1100011000 | | | | | | | | | | |
| 100 | 0010011000 | | | | | | | | | | |
| 101 | 1010011000 | | | | | | | | | | |
| 102 | 0110011000 | | | | | | | | | | |
| 103 | 1110011000 | LEV2 | | | | | 0 ~ 480 | | | | |
| 104 | 0001011000 | LEV1 (WY) | | | | | ↑ | | | | |
| 105 | 1001011000 | | | | | | | | | | |
| 106 | 0101011000 | | | | | | | | | | |
| 107 | 1101011000 | | | | | | | | | | |
| 108 | 0011011000 | COMP1 operation current (DC) | | | | | -99.9 ~ 999.9 | | | | Peak value [A]. |
| 109 | 1011011000 | | | | | | | | | | |
| 110 | 0111011000 | | | | | | | | | | |

※1 : Output frequency of the inverter depends on the type of compressor and equals the integer multiples (X1, X2 etc.) of the operating frequency of the compressor.

| No. | SW1 | Item | LED | | | | | | | | Remarks |
|-----|------------|---|------------------------|-------|-------|-------|-------|-------|------|-----|--|
| | 1234567890 | | LD1 | LD2 | LD3 | LD4 | LD5 | LD6 | LD7 | LD8 | |
| 111 | 1111011000 | COMP1 bus voltage | 0000 ~ 9999 | | | | | | | | The unit is [V]. |
| 112 | 0000111000 | | | | | | | | | | |
| 113 | 1000111000 | | | | | | | | | | |
| 114 | 0100111000 | | | | | | | | | | |
| 115 | 1100111000 | | | | | | | | | | |
| 116 | 0010111000 | | | | | | | | | | |
| 117 | 1010111000 | Compressor 1 operation time upper 4 digits. | 0000 ~ 9999 | | | | | | | | The unit is [h]. |
| 118 | 0110111000 | Compressor 1 operation time lower 4 digits. | ↑ | | | | | | | | |
| 119 | 1110111000 | | | | | | | | | | |
| 120 | 0001111000 | | | | | | | | | | |
| 121 | 1001111000 | | | | | | | | | | |
| 122 | 0101111000 | | | | | | | | | | |
| 123 | 1101111000 | COMP 1 number of starts and stops upper 4 digits. | 0000 ~ 9999 | | | | | | | | Count up when starting up. [Time] |
| 124 | 0011111000 | COMP 1 number of starts and stops lower 4 digits. | ↑ | | | | | | | | |
| 125 | 1011111000 | | | | | | | | | | |
| 126 | 0111111000 | | | | | | | | | | |
| 127 | 1111111000 | | | | | | | | | | |
| 128 | 0000000100 | | | | | | | | | | |
| 129 | 1000000100 | | | | | | | | | | |
| 130 | 0100000100 | | | | | | | | | | |
| 131 | 1100000100 | | | | | | | | | | |
| 132 | 0010000100 | Relay output BC (Main,Standard) | SVM1 | SVM2 | | | | | | | Displayed only by R2 and WR2 systems. |
| 133 | 1010000100 | | SVA1 | SVB1 | SVC1 | SVA2 | SVB2 | SVC2 | | | |
| 134 | 0110000100 | | SVA3 | SVB3 | SVC3 | SVA4 | SVB4 | SVC4 | | | |
| 135 | 1110000100 | | SVA5 | SVB5 | SVC5 | SVA6 | SVB6 | SVC6 | | | |
| 136 | 0001000100 | | SVA7 | SVB7 | SVC7 | SVA8 | SVB8 | SVC8 | | | |
| 137 | 1001000100 | | SVA9 | SVB9 | SVC9 | SVA10 | SVB10 | SVC10 | | | |
| 138 | 0101000100 | | SVA11 | SVB11 | SVC11 | SVA12 | SVB12 | SVC12 | | | |
| 139 | 1101000100 | | SVA13 | SVB13 | SVC13 | SVA14 | SVB14 | SVC14 | | | |
| 140 | 0011000100 | | SVA15 | SVB15 | SVC15 | SVA16 | SVB16 | SVC16 | | | |
| 141 | 1011000100 | | Relay output BC (Sub1) | SVA1 | SVB1 | SVC1 | SVA2 | SVB2 | SVC2 | | |
| 142 | 0111000100 | SVA3 | | SVB3 | SVC3 | SVA4 | SVB4 | SVC4 | | | |
| 143 | 1111000100 | SVA5 | | SVB5 | SVC5 | SVA6 | SVB6 | SVC6 | | | |
| 144 | 0000100100 | SVA7 | | SVB7 | SVC7 | SVA8 | SVB8 | SVC8 | | | |
| 145 | 1000100100 | Relay output BC (Sub2) | SVA1 | SVB1 | SVC1 | SVA2 | SVB2 | SVC2 | | | |
| 146 | 0100100100 | | SVA3 | SVB3 | SVC3 | SVA4 | SVB4 | SVC4 | | | |
| 147 | 1100100100 | | SVA5 | SVB5 | SVC5 | SVA6 | SVB6 | SVC6 | | | |
| 148 | 0010100100 | | SVA7 | SVB7 | SVC7 | SVA8 | SVB8 | SVC8 | | | |
| 149 | 1010100100 | BC (Main,Standard) TH11 | -99.9 ~ 999.9 | | | | | | | | The unit is [°C]. |

| No. | SW1 | Item | LED | | | | | | | | Remarks |
|-----|------------|--------------------------|-------------------------------------|-----|-----|-----|-----|-----|-----|-----|---|
| | 1234567890 | | LD1 | LD2 | LD3 | LD4 | LD5 | LD6 | LD7 | LD8 | |
| 150 | 0110100100 | BC (Main,Standard) TH12 | -99.9 ~ 999.9 | | | | | | | | The unit is [°C]. |
| 151 | 1110100100 | BC (Main,Standard) TH15 | ↑ | | | | | | | | |
| 152 | 0001100100 | BC (Main,Standard) TH16 | ↑ | | | | | | | | |
| 153 | 1001100100 | BC (Main,Standard) 63HS1 | ↑ | | | | | | | | The unit is [kgf/cm ²]. |
| 154 | 0101100100 | BC (Main,Standard) 63HS3 | ↑ | | | | | | | | |
| 155 | 1101100100 | BC (Main,Standard) SC11 | ↑ | | | | | | | | The unit is [deg]. |
| 156 | 0011100100 | BC (Main,Standard) SH12 | ↑ | | | | | | | | |
| 157 | 1011100100 | BC (Main,Standard) SH13 | ↑ | | | | | | | | |
| 158 | 0111100100 | BC (Main,Standard) SC16 | ↑ | | | | | | | | |
| 159 | 1111100100 | BC (Main,Standard) LEV1 | 0000 ~ 2000 | | | | | | | | |
| 160 | 0000010100 | BC (Main,Standard) LEV3 | ↑ | | | | | | | | LEV3 opening [Fully open: 2000] |
| 161 | 1000010100 | BC (Sub1) TH22 | -99.9 ~ 999.9 | | | | | | | | The unit is [°C]. |
| 162 | 0100010100 | BC (Sub1) TH25 | ↑ | | | | | | | | |
| 163 | 1100010100 | BC (Sub1) LEV3a | 0000 ~ 2000 | | | | | | | | LEV3a opening [Fully open: 2000] |
| 164 | 0010010100 | BC (Sub2) TH22 | -99.9 ~ 999.9 | | | | | | | | The unit is [°C]. |
| 165 | 1010010100 | BC (Sub2) TH25 | ↑ | | | | | | | | |
| 166 | 0110010100 | BC (Sub2) LEV3a | 0000 ~ 2000 | | | | | | | | LEV3a opening [Fully open: 2000] |
| 167 | 1110010100 | BC (Main,Standard) LEV2 | ↑ | | | | | | | | LEV2 opening [Fully open: 2000] |
| 168 | 0001010100 | | | | | | | | | | |
| 169 | 1001010100 | | | | | | | | | | |
| 170 | 0101010100 | | | | | | | | | | |
| 171 | 1101010100 | | | | | | | | | | |
| 172 | 0011010100 | | | | | | | | | | |
| 173 | 1011010100 | | | | | | | | | | |
| 174 | 0111010100 | | | | | | | | | | |
| 175 | 1111010100 | | | | | | | | | | |
| 176 | 0000110100 | | | | | | | | | | |
| 177 | 1000110100 | | | | | | | | | | |
| 178 | 0100110100 | Error history 1 | 0000 ~ 9999 | | | | | | | | Address and error code are reversed and displayed. "----" is displayed when there is no error. |
| 179 | 1100110100 | Inverter error detail | Inverter error detail (0001 ~ 0120) | | | | | | | | |
| 180 | 0010110100 | Error history 2 | 0000 ~ 9999 | | | | | | | | |
| 181 | 1010110100 | Inverter error detail | Inverter error detail (0001 ~ 0120) | | | | | | | | |
| 182 | 0110110100 | Error history 3 | 0000 ~ 9999 | | | | | | | | |
| 183 | 1110110100 | Inverter error detail | Inverter error detail (0001 ~ 0120) | | | | | | | | |
| 184 | 0001110100 | Error history 4 | 0000 ~ 9999 | | | | | | | | |
| 185 | 1001110100 | Inverter error detail | Inverter error detail (0001 ~ 0120) | | | | | | | | |
| 186 | 0101110100 | Error history 5 | 0000 ~ 9999 | | | | | | | | |
| 187 | 1101110100 | Inverter error detail | Inverter error detail (0001 ~ 0120) | | | | | | | | |
| 188 | 0011110100 | Error history 6 | 0000 ~ 9999 | | | | | | | | |
| 189 | 1011110100 | Inverter error detail | Inverter error detail (0001 ~ 0120) | | | | | | | | |
| 190 | 0111110100 | Error history 7 | 0000 ~ 9999 | | | | | | | | |
| 191 | 1111110100 | Inverter error detail | Inverter error detail (0001 ~ 0120) | | | | | | | | |
| 192 | 0000001100 | Error history 8 | 0000 ~ 9999 | | | | | | | | |

* No.150 ~ 169 are displayed only by R2 and WR2 systems.

| No. | SW1 | Item | LED | | | | | | | | Remarks |
|-----|------------|---|-------------------------------------|------------------------|-----------------------------------|----------------------|-------------------|--------------|---|-------------------------------------|--|
| | 1234567890 | | LD1 | LD2 | LD3 | LD4 | LD5 | LD6 | LD7 | LD8 | |
| 193 | 1000001100 | Inverter error detail | Inverter error detail (0001 ~ 0120) | | | | | | | | Address and error code are reversed and displayed. "----" is displayed when there is no error. |
| 194 | 0100001100 | Error history 9 | 0000 ~ 9999 | | | | | | | | |
| 195 | 1100001100 | Inverter error detail | Inverter error detail (0001 ~ 0120) | | | | | | | | |
| 196 | 0010001100 | Error history 10 | 0000 ~ 9999 | | | | | | | | |
| 197 | 1010001100 | Inverter error detail | Inverter error detail (0001 ~ 0120) | | | | | | | | |
| 198 | 0110001100 | Inverter error history (when saving data before an error) | 0000 ~ 9999 | | | | | | | | |
| 199 | 1110001100 | Inverter error detail | Inverter error detail (0001 ~ 0120) | | | | | | | | |
| 200 | 0001001100 | | | | | | | | | | |
| 201 | 1001001100 | Outdoor unit operation display | BC operation | Warm up mode | 3 minutes restart protection mode | Compressor operation | Preliminary error | Error | 3 minutes restart after instantaneous power failure | Vacuum operation protection delayed | |
| 202 | 0101001100 | | | | | | | | | | |
| 203 | 1101001100 | BC operation mode | Cooling only ON | Cooling only OFF | Heating only ON | Heating only OFF | Mix ON | Mix OFF | Fan | Stop | Displayed only by R2 and WR2 systems. |
| 204 | 0011001100 | | | | | | | | | | |
| 205 | 1011001100 | Outdoor (Heat source) operation mode | Permissible stop | Standby | Cooling only | Cooling main | Heating only | Heating main | | | |
| 206 | 0111001100 | | | | | | | | | | |
| 207 | 1111001100 | | | | | | | | | | |
| 208 | 0000101100 | Outdoor (Heat source) unit control mode | Stop | Thermo OFF | Error stop | Regular control | Initial start | Defrost | Oil recovery | Low frequency oil collection | |
| 209 | 1000101100 | | Warm up | Refrigerant collection | | | | | | | |
| 210 | 0100101100 | | | | | | | | | | |
| 211 | 1100101100 | Relay output display 1 (lighting to display) | Comp operation | Comp 1 operation | | | 52C1 | | | | Lights for normal operation |
| 212 | 0010101100 | Relay output display 2 (lighting to display) | 21S4a | | | CH11 | | | | | |
| 213 | 1010101100 | Relay output display 3 (lighting to display) | SV1 | | | SV4a | SV4b | SV4c | | | |
| 214 | 0110101100 | Relay output display 4 (lighting to display) | SV5a | SV5b | | | SV4d | | | | |
| 215 | 1110101100 | Relay output display 5 (lighting to display) | SV7a | SV7b | SV7c | | | | | | |
| 216 | 0001101100 | TH11 | -99.9 ~ 999.9 | | | | | | | | The unit is [°C]. |
| 217 | 1001101100 | | | | | | | | | | |
| 218 | 0101101100 | | | | | | | | | | |
| 219 | 1101101100 | TH5 (WY) | -99.9 ~ 999.9 | | | | | | | | |
| 220 | 0011101100 | TH6 | ↑ | | | | | | | | |
| 221 | 1011101100 | TH7 (WY) | ↑ | | | | | | | | |
| 222 | 0111101100 | TH8 (WY) | ↑ | | | | | | | | |
| 223 | 1111101100 | | | | | | | | | | |
| 224 | 0000011100 | | | | | | | | | | |
| 225 | 1000011100 | TH9 | -99.9 ~ 999.9 | | | | | | | | |
| 226 | 0100011100 | | | | | | | | | | |
| 227 | 1100011100 | THINV | -99.9 ~ 999.9 | | | | | | | | |

| No. | SW1 | Item | LED | | | | | | | | Remarks |
|-----|------------|---------------------------|-----|-----|-----|-----|---------------|-----|-----|-----|---|
| | 1234567890 | | LD1 | LD2 | LD3 | LD4 | LD5 | LD6 | LD7 | LD8 | |
| 228 | 0010011100 | | | | | | | | | | |
| 229 | 1010011100 | | | | | | | | | | |
| 230 | 0110011100 | | | | | | | | | | |
| 231 | 1110011100 | THHS1 | | | | | -99.9 ~ 999.9 | | | | The unit is [°C]. |
| 232 | 0001011100 | | | | | | | | | | |
| 233 | 1001011100 | | | | | | | | | | |
| 234 | 0101011100 | | | | | | | | | | |
| 235 | 1101011100 | | | | | | | | | | |
| 236 | 0011011100 | | | | | | | | | | |
| 237 | 1011011100 | | | | | | | | | | |
| 238 | 0111011100 | | | | | | | | | | |
| 239 | 1111011100 | | | | | | | | | | |
| 240 | 0000111100 | | | | | | | | | | |
| 241 | 1000111100 | | | | | | | | | | |
| 242 | 0100111100 | | | | | | | | | | |
| 243 | 1100111100 | High pressure | | | | | -99.9 ~ 999.9 | | | | The unit is [kgf/cm ²]. |
| 244 | 0010111100 | Low pressure | | | | | ↑ | | | | |
| 245 | 1010111100 | | | | | | | | | | |
| 246 | 0110111100 | | | | | | | | | | |
| 247 | 1110111100 | | | | | | | | | | |
| 248 | 0001111100 | | | | | | | | | | |
| 249 | 1001111100 | Σ Qj (=Σ Qjc+Σ Qjh) | | | | | 0000 ~ 9999 | | | | |
| 250 | 0101111100 | Σ Qjc | | | | | ↑ | | | | |
| 251 | 1101111100 | Σ Qjh | | | | | ↑ | | | | |
| 252 | 0011111100 | Target condenser temp. Tc | | | | | -99.9 ~ 999.9 | | | | The unit is [°C]. |
| 253 | 1011111100 | Target condenser temp. Te | | | | | ↑ | | | | |
| 254 | 0111111100 | Tc | | | | | ↑ | | | | |
| 255 | 1111111100 | Te | | | | | ↑ | | | | |
| 256 | 0000000010 | | | | | | | | | | |
| 257 | 1000000010 | | | | | | | | | | |
| 258 | 0100000010 | All temporary frequency | | | | | 0000 ~ 9999 | | | | Control data [Hz]. |
| 259 | 1100000010 | COMP1 control frequency | | | | | ↑ | | | | |
| 260 | 0010000010 | | | | | | | | | | |
| 261 | 1010000010 | | | | | | | | | | |
| 262 | 0110000010 | COMP1 output frequency | | | | | 0000 ~ 9999 | | | | Operating frequency of compressor [Hz]. ※1 |
| 263 | 1110000010 | | | | | | | | | | |
| 264 | 0001000010 | | | | | | | | | | |
| 265 | 1001000010 | AK1 | | | | | 0000 ~ 9999 | | | | Control data |
| 266 | 0101000010 | | | | | | | | | | |
| 267 | 1101000010 | | | | | | | | | | |
| 268 | 0011000010 | | | | | | | | | | |
| 269 | 1011000010 | | | | | | | | | | |

※1 : Output frequency of the inverter depends on the type of compressor and equals the integer multiples (X1, X2 etc.) of the operating frequency of the compressor.

| No. | SW1 | Item | LED | | | | | | | | Remarks |
|-----|------------|---|-----|-----|-----|-----|---------------|-----|-----|-----|-------------------------------------|
| | 1234567890 | | LD1 | LD2 | LD3 | LD4 | LD5 | LD6 | LD7 | LD8 | |
| 270 | 0111000010 | | | | | | | | | | |
| 271 | 1111000010 | | | | | | | | | | |
| 272 | 0000100010 | | | | | | | | | | |
| 273 | 1000100010 | | | | | | | | | | |
| 274 | 0100100010 | LEV2 | | | | | 0 ~ 480 | | | | LEV opening |
| 275 | 1100100010 | LEV1 (WY) | | | | | ↑ | | | | |
| 276 | 0010100010 | | | | | | | | | | |
| 277 | 1010100010 | | | | | | | | | | |
| 278 | 0110100010 | | | | | | | | | | |
| 279 | 1110100010 | COMP1 operation current (DC) | | | | | -99.9 ~ 999.9 | | | | Peak value [A]. |
| 280 | 0001100010 | | | | | | | | | | |
| 281 | 1001100010 | | | | | | | | | | |
| 282 | 0101100010 | COMP1 bus voltage | | | | | -99.9 ~ 999.9 | | | | The unit is [V]. |
| 283 | 1101100010 | | | | | | | | | | |
| 284 | 0011100010 | | | | | | | | | | |
| 285 | 1011100010 | | | | | | | | | | |
| 286 | 0111100010 | | | | | | | | | | |
| 287 | 1111100010 | | | | | | | | | | |
| 288 | 0000010010 | Compressor 1 operation time upper 4 digits. | | | | | 0000 ~ 9999 | | | | The unit is [h]. |
| 289 | 1000010010 | Compressor 1 operation time lower 4 digits. | | | | | ↑ | | | | |
| 290 | 0100010010 | | | | | | | | | | |
| 291 | 1100010010 | | | | | | | | | | |
| 292 | 0010010010 | | | | | | | | | | |
| 293 | 1010010010 | | | | | | | | | | |
| 294 | 0110010010 | COMP 1 number of starts and stops upper 4 digits. | | | | | 0000 ~ 9999 | | | | Count up when starting up. [Time] |
| 295 | 1110010010 | COMP 1 number of starts and stops lower 4 digits. | | | | | ↑ | | | | |
| 296 | 0001010010 | | | | | | | | | | |
| 297 | 1001010010 | | | | | | | | | | |
| 298 | 0101010010 | | | | | | | | | | |
| 299 | 1101010010 | | | | | | | | | | |
| 300 | 0011010010 | | | | | | | | | | |
| 301 | 1011010010 | | | | | | | | | | |
| 302 | 0111010010 | | | | | | | | | | |
| 303 | 1111010010 | | | | | | | | | | |
| 304 | 0000110010 | | | | | | | | | | |
| 305 | 1000110010 | | | | | | | | | | |
| 306 | 0100110010 | | | | | | | | | | |
| 307 | 1100110010 | | | | | | | | | | |
| 308 | 0010110010 | | | | | | | | | | |

| No. | SW1 | Item | LED | | | | | | | | Remarks |
|-----|------------|---------------------------|-----|-----|-----|-----|---------------|-----|-----|-------------|---|
| | 1234567890 | | LD1 | LD2 | LD3 | LD4 | LD5 | LD6 | LD7 | LD8 | |
| 309 | 1010110010 | | | | | | | | | | |
| 310 | 0110110010 | | | | | | | | | | |
| 311 | 1110110010 | | | | | | | | | | |
| 312 | 0001110010 | | | | | | | | | | |
| 313 | 1001110010 | | | | | | | | | | |
| 314 | 0101110010 | | | | | | | | | | |
| 315 | 1101110010 | | | | | | | | | | |
| 316 | 0011110010 | | | | | | | | | | |
| 317 | 1011110010 | | | | | | | | | | |
| 318 | 0111110010 | | | | | | | | | | |
| 319 | 1111110010 | | | | | | | | | | |
| 320 | 0000001010 | BC (Main,Standard) TH11 | | | | | -99.9 ~ 999.9 | | | | The unit is [°C]. |
| 321 | 1000001010 | BC (Main,Standard) TH12 | | | | | ↑ | | | | |
| 322 | 0100001010 | BC (Main,Standard) TH15 | | | | | ↑ | | | | |
| 323 | 1100001010 | BC (Main,Standard) TH16 | | | | | ↑ | | | | |
| 324 | 0010001010 | BC (Main,Standard) 63HS1 | | | | | ↑ | | | | The unit is [kgf/cm ²]. |
| 325 | 1010001010 | BC (Main,Standard) 63HS3 | | | | | ↑ | | | | |
| 326 | 0110001010 | | | | | | | | | | |
| 327 | 1110001010 | | | | | | | | | | |
| 328 | 0001001010 | | | | | | | | | | |
| 329 | 1001001010 | | | | | | | | | | |
| 330 | 0101001010 | BC (Main,Standard) LEV1 | | | | | 0000 ~ 2000 | | | | LEV1 opening [Fully open: 2000] |
| 331 | 1101001010 | BC (Main,Standard) LEV3 | | | | | ↑ | | | | LEV3 opening [Fully open: 2000] |
| 332 | 0011001010 | BC (Sub1) TH22 | | | | | -99.9 ~ 999.9 | | | | The unit is [°C]. |
| 333 | 1011001010 | BC (Sub1) TH25 | | | | | ↑ | | | | |
| 334 | 0111001010 | BC (Sub1) LEV3a | | | | | 0000 ~ 2000 | | | | LEV3a opening [Fully open: 2000] |
| 335 | 1111001010 | BC (Sub2) TH22 | | | | | -99.9 ~ 999.9 | | | | The unit is [°C]. |
| 336 | 0000101010 | BC (Sub2) TH25 | | | | | ↑ | | | | |
| 337 | 1000101010 | BC (Sub2) LEV3a | | | | | 0000 ~ 2000 | | | | LEV3a opening [Fully open: 2000] |
| 338 | 0100101010 | BC (Main,Standard) LEV2 | | | | | ↑ | | | | LEV2 opening [Fully open: 2000] |
| 339 | 1100101010 | | | | | | | | | | |
| 340 | 0010101010 | | | | | | | | | | |
| 341 | 1010101010 | | | | | | | | | | |
| 342 | 0110101010 | | | | | | | | | | |
| 343 | 1110101010 | | | | | | | | | | |
| 344 | 0001101010 | | | | | | | | | | |
| 345 | 1001101010 | | | | | | | | | | |
| 346 | 0101101010 | | | | | | | | | | |
| 347 | 1101101010 | | | | | | | | | | |
| 348 | 0011101010 | | | | | | | | | | |
| 349 | 1011101010 | | | | | | | | | | |
| 350 | 0111101010 | | | | | | | | | | |
| 351 | 1111101010 | IC1 Address/Capacity code | | | | | 0000 ~ 9999 | | | 0000 ~ 9999 | Displayed alternately every 5 seconds. |

* No.320 ~ 325, No.330 ~ 338 are displayed only by R2 and WR2 systems.

| No. | SW1 | Item | LED | | | | | | | | Remarks |
|-----|------------|----------------------------|-------------|-----|-----|-----|-------------|-----|-----|-----|--|
| | 1234567890 | | LD1 | LD2 | LD3 | LD4 | LD5 | LD6 | LD7 | LD8 | |
| 352 | 0000011010 | IC2 Address/Capacity code | 0000 ~ 9999 | | | | 0000 ~ 9999 | | | | Displayed alternately every 5 seconds. |
| 353 | 1000011010 | IC3 Address/Capacity code | ↑ | | | | ↑ | | | | |
| 354 | 0100011010 | IC4 Address/Capacity code | ↑ | | | | ↑ | | | | |
| 355 | 1100011010 | IC5 Address/Capacity code | ↑ | | | | ↑ | | | | |
| 356 | 0010011010 | IC6 Address/Capacity code | ↑ | | | | ↑ | | | | |
| 357 | 1010011010 | IC7 Address/Capacity code | ↑ | | | | ↑ | | | | |
| 358 | 0110011010 | IC8 Address/Capacity code | ↑ | | | | ↑ | | | | |
| 359 | 1110011010 | IC9 Address/Capacity code | ↑ | | | | ↑ | | | | |
| 360 | 0001011010 | IC10 Address/Capacity code | ↑ | | | | ↑ | | | | |
| 361 | 1001011010 | IC11 Address/Capacity code | ↑ | | | | ↑ | | | | |
| 362 | 0101011010 | IC12 Address/Capacity code | ↑ | | | | ↑ | | | | |
| 363 | 1101011010 | IC13 Address/Capacity code | ↑ | | | | ↑ | | | | |
| 364 | 0011011010 | IC14 Address/Capacity code | ↑ | | | | ↑ | | | | |
| 365 | 1011011010 | IC15 Address/Capacity code | ↑ | | | | ↑ | | | | |
| 366 | 0111011010 | IC16 Address/Capacity code | ↑ | | | | ↑ | | | | |
| 367 | 1111011010 | IC17 Address/Capacity code | ↑ | | | | ↑ | | | | |
| 368 | 0000111010 | IC18 Address/Capacity code | ↑ | | | | ↑ | | | | |
| 369 | 1000111010 | IC19 Address/Capacity code | ↑ | | | | ↑ | | | | |
| 370 | 0100111010 | IC20 Address/Capacity code | ↑ | | | | ↑ | | | | |
| 371 | 1100111010 | IC21 Address/Capacity code | ↑ | | | | ↑ | | | | |
| 372 | 0010111010 | IC22 Address/Capacity code | ↑ | | | | ↑ | | | | |
| 373 | 1010111010 | IC23 Address/Capacity code | ↑ | | | | ↑ | | | | |
| 374 | 0110111010 | IC24 Address/Capacity code | ↑ | | | | ↑ | | | | |
| 375 | 1110111010 | IC25 Address/Capacity code | ↑ | | | | ↑ | | | | |
| 376 | 0001111010 | IC26 Address/Capacity code | ↑ | | | | ↑ | | | | |
| 377 | 1001111010 | IC27 Address/Capacity code | ↑ | | | | ↑ | | | | |
| 378 | 0101111010 | IC28 Address/Capacity code | ↑ | | | | ↑ | | | | |
| 379 | 1101111010 | IC29 Address/Capacity code | ↑ | | | | ↑ | | | | |
| 380 | 0011111010 | IC30 Address/Capacity code | ↑ | | | | ↑ | | | | |
| 381 | 1011111010 | IC31 Address/Capacity code | ↑ | | | | ↑ | | | | |
| 382 | 0111111010 | IC32 Address/Capacity code | ↑ | | | | ↑ | | | | |
| 383 | 1111111010 | | | | | | | | | | |
| 384 | 0000000110 | | | | | | | | | | |
| 385 | 1000000110 | | | | | | | | | | |
| 386 | 0100000110 | | | | | | | | | | |
| 387 | 1100000110 | | | | | | | | | | |
| 388 | 0010000110 | | | | | | | | | | |
| 389 | 1010000110 | | | | | | | | | | |
| 390 | 0110000110 | | | | | | | | | | |
| 391 | 1110000110 | | | | | | | | | | |
| 392 | 0001000110 | | | | | | | | | | |
| 393 | 1001000110 | | | | | | | | | | |
| 394 | 0101000110 | | | | | | | | | | |
| 395 | 1101000110 | | | | | | | | | | |

| No. | SW1 | Item | LED | | | | | | | | Remarks |
|-----|------------|--------------------------|-----|-----|-----|-----|---------------|-----|-----|-----|---------------------|
| | 1234567890 | | LD1 | LD2 | LD3 | LD4 | LD5 | LD6 | LD7 | LD8 | |
| 396 | 0011000110 | | | | | | | | | | |
| 397 | 1011000110 | | | | | | | | | | |
| 398 | 0111000110 | | | | | | | | | | |
| 399 | 1111000110 | | | | | | | | | | |
| 400 | 0000100110 | | | | | | | | | | |
| 401 | 1000100110 | | | | | | | | | | |
| 402 | 0100100110 | | | | | | | | | | |
| 403 | 1100100110 | | | | | | | | | | |
| 404 | 0010100110 | | | | | | | | | | |
| 405 | 1010100110 | | | | | | | | | | |
| 406 | 0110100110 | | | | | | | | | | |
| 407 | 1110100110 | | | | | | | | | | |
| 408 | 0001100110 | IC1 Suction temperature | | | | | -99.9 ~ 999.9 | | | | The unit is [°C]. |
| 409 | 1001100110 | IC2 Suction temperature | | | | | ↑ | | | | |
| 410 | 0101100110 | IC3 Suction temperature | | | | | ↑ | | | | |
| 411 | 1101100110 | IC4 Suction temperature | | | | | ↑ | | | | |
| 412 | 0011100110 | IC5 Suction temperature | | | | | ↑ | | | | |
| 413 | 1011100110 | IC6 Suction temperature | | | | | ↑ | | | | |
| 414 | 0111100110 | IC7 Suction temperature | | | | | ↑ | | | | |
| 415 | 1111100110 | IC8 Suction temperature | | | | | ↑ | | | | |
| 416 | 0000010110 | IC9 Suction temperature | | | | | ↑ | | | | |
| 417 | 1000010110 | IC10 Suction temperature | | | | | ↑ | | | | |
| 418 | 0100010110 | IC11 Suction temperature | | | | | ↑ | | | | |
| 419 | 1100010110 | IC12 Suction temperature | | | | | ↑ | | | | |
| 420 | 0010010110 | IC13 Suction temperature | | | | | ↑ | | | | |
| 421 | 1010010110 | IC14 Suction temperature | | | | | ↑ | | | | |
| 422 | 0110010110 | IC15 Suction temperature | | | | | ↑ | | | | |
| 423 | 1110010110 | IC16 Suction temperature | | | | | ↑ | | | | |
| 424 | 0001010110 | IC17 Suction temperature | | | | | ↑ | | | | |
| 425 | 1001010110 | IC18 Suction temperature | | | | | ↑ | | | | |
| 426 | 0101010110 | IC19 Suction temperature | | | | | ↑ | | | | |
| 427 | 1101010110 | IC20 Suction temperature | | | | | ↑ | | | | |
| 428 | 0011010110 | IC21 Suction temperature | | | | | ↑ | | | | |
| 429 | 1011010110 | IC22 Suction temperature | | | | | ↑ | | | | |
| 430 | 0111010110 | IC23 Suction temperature | | | | | ↑ | | | | |
| 431 | 1111010110 | IC24 Suction temperature | | | | | ↑ | | | | |
| 432 | 0000110110 | IC25 Suction temperature | | | | | ↑ | | | | |
| 433 | 1000110110 | IC26 Suction temperature | | | | | ↑ | | | | |
| 434 | 0100110110 | IC27 Suction temperature | | | | | ↑ | | | | |
| 435 | 1100110110 | IC28 Suction temperature | | | | | ↑ | | | | |
| 436 | 0010110110 | IC29 Suction temperature | | | | | ↑ | | | | |
| 437 | 1010110110 | IC30 Suction temperature | | | | | ↑ | | | | |
| 438 | 0110110110 | IC31 Suction temperature | | | | | ↑ | | | | |

| No. | SW1 | Item | LED | | | | | | | | Remarks |
|-----|------------|--------------------------|---------------|-----|-----|-----|-----|-----|-----|-----|---------------------|
| | 1234567890 | | LD1 | LD2 | LD3 | LD4 | LD5 | LD6 | LD7 | LD8 | |
| 439 | 1110110110 | IC32 Suction temperature | -99.9 ~ 999.9 | | | | | | | | The unit is [°C]. |
| 440 | 0001110110 | | | | | | | | | | |
| 441 | 1001110110 | | | | | | | | | | |
| 442 | 0101110110 | | | | | | | | | | |
| 443 | 1101110110 | | | | | | | | | | |
| 444 | 0011110110 | | | | | | | | | | |
| 445 | 1011110110 | | | | | | | | | | |
| 446 | 0111110110 | | | | | | | | | | |
| 447 | 1111110110 | | | | | | | | | | |
| 448 | 0000001110 | | | | | | | | | | |
| 449 | 1000001110 | | | | | | | | | | |
| 450 | 0100001110 | | | | | | | | | | |
| 451 | 1100001110 | | | | | | | | | | |
| 452 | 0010001110 | | | | | | | | | | |
| 453 | 1010001110 | | | | | | | | | | |
| 454 | 0110001110 | | | | | | | | | | |
| 455 | 1110001110 | | | | | | | | | | |
| 456 | 0001001110 | | | | | | | | | | |
| 457 | 1001001110 | | | | | | | | | | |
| 458 | 0101001110 | IC1 Liquid pipe temp. | -99.9 ~ 999.9 | | | | | | | | |
| 459 | 1101001110 | IC2 Liquid pipe temp. | ↑ | | | | | | | | |
| 460 | 0011001110 | IC3 Liquid pipe temp. | ↑ | | | | | | | | |
| 461 | 1011001110 | IC4 Liquid pipe temp. | ↑ | | | | | | | | |
| 462 | 0111001110 | IC5 Liquid pipe temp. | ↑ | | | | | | | | |
| 463 | 1111001110 | IC6 Liquid pipe temp. | ↑ | | | | | | | | |
| 464 | 0000101110 | IC7 Liquid pipe temp. | ↑ | | | | | | | | |
| 465 | 1000101110 | IC8 Liquid pipe temp. | ↑ | | | | | | | | |
| 466 | 0100101110 | IC9 Liquid pipe temp. | ↑ | | | | | | | | |
| 467 | 1100101110 | IC10 Liquid pipe temp. | ↑ | | | | | | | | |
| 468 | 0010101110 | IC11 Liquid pipe temp. | ↑ | | | | | | | | |
| 469 | 1010101110 | IC12 Liquid pipe temp. | ↑ | | | | | | | | |
| 470 | 0110101110 | IC13 Liquid pipe temp. | ↑ | | | | | | | | |
| 471 | 1110101110 | IC14 Liquid pipe temp. | ↑ | | | | | | | | |
| 472 | 0001101110 | IC15 Liquid pipe temp. | ↑ | | | | | | | | |
| 473 | 1001101110 | IC16 Liquid pipe temp. | ↑ | | | | | | | | |
| 474 | 0101101110 | IC17 Liquid pipe temp. | ↑ | | | | | | | | |
| 475 | 1101101110 | IC18 Liquid pipe temp. | ↑ | | | | | | | | |
| 476 | 0011101110 | IC19 Liquid pipe temp. | ↑ | | | | | | | | |
| 477 | 1011101110 | IC20 Liquid pipe temp. | ↑ | | | | | | | | |
| 478 | 0111101110 | IC21 Liquid pipe temp. | ↑ | | | | | | | | |
| 479 | 1111101110 | IC22 Liquid pipe temp. | ↑ | | | | | | | | |
| 480 | 0000011110 | IC23 Liquid pipe temp. | ↑ | | | | | | | | |
| 481 | 1000011110 | IC24 Liquid pipe temp. | ↑ | | | | | | | | |

| No. | SW1 | Item | LED | | | | | | | | Remarks |
|-----|------------|------------------------|---|-----|-----|-----|-----|-----|-----|-----|---|
| | 1234567890 | | LD1 | LD2 | LD3 | LD4 | LD5 | LD6 | LD7 | LD8 | |
| 482 | 0100011110 | IC25 Liquid pipe temp. | -99.9 ~ 999.9 | | | | | | | | The unit is [°C]. |
| 483 | 1100011110 | IC26 Liquid pipe temp. | ↑ | | | | | | | | |
| 484 | 0010011110 | IC27 Liquid pipe temp. | ↑ | | | | | | | | |
| 485 | 1010011110 | IC28 Liquid pipe temp. | ↑ | | | | | | | | |
| 486 | 0110011110 | IC29 Liquid pipe temp. | ↑ | | | | | | | | |
| 487 | 1110011110 | IC30 Liquid pipe temp. | ↑ | | | | | | | | |
| 488 | 0001011110 | IC31 Liquid pipe temp. | ↑ | | | | | | | | |
| 489 | 1001011110 | IC32 Liquid pipe temp. | ↑ | | | | | | | | |
| 490 | 0101011110 | | | | | | | | | | |
| 491 | 1101011110 | | | | | | | | | | |
| 492 | 0011011110 | | | | | | | | | | |
| 493 | 1011011110 | | | | | | | | | | |
| 494 | 0111011110 | | | | | | | | | | |
| 495 | 1111011110 | | | | | | | | | | |
| 496 | 0000111110 | | | | | | | | | | |
| 497 | 1000111110 | | | | | | | | | | |
| 498 | 0100111110 | | | | | | | | | | |
| 499 | 1100111110 | | | | | | | | | | |
| 500 | 0010111110 | | | | | | | | | | |
| 501 | 1010111110 | | | | | | | | | | |
| 502 | 0110111110 | | | | | | | | | | |
| 503 | 1110111110 | | | | | | | | | | |
| 504 | 0001111110 | | | | | | | | | | |
| 505 | 1001111110 | | | | | | | | | | |
| 506 | 0101111110 | | | | | | | | | | |
| 507 | 1101111110 | | | | | | | | | | |
| 508 | 0011111110 | | | | | | | | | | |
| 509 | 1011111110 | | | | | | | | | | |
| 510 | 0111111110 | | | | | | | | | | |
| 511 | 1111111110 | | | | | | | | | | |
| 512 | 0000000001 | Self-address | Self-address and model code are alternately displayed | | | | | | | | |
| 513 | 1000000001 | IC/FU address | Display count up for the number of connected units | | | | | | | | |
| 514 | 0100000001 | RC address | Display count up for the number of connected units | | | | | | | | |
| 515 | 1100000001 | BC/TU address | Display count up for the number of connected units | | | | | | | | |
| 516 | 0010000001 | OS address | Display count up for the number of connected units | | | | | | | | |
| 517 | 1010000001 | Main board S/W version | S/W version → Refrigerant type → Model & capacity → Address | | | | | | | | Refer to LED display at initial setting |
| 518 | 0110000001 | | | | | | | | | | |
| 519 | 1110000001 | | | | | | | | | | |
| 520 | 0001000001 | | | | | | | | | | |
| 521 | 1001000001 | | | | | | | | | | |
| 522 | 0101000001 | | | | | | | | | | |
| 523 | 1101000001 | IC1 Gas pipe temp. | -99.9 ~ 999.9 | | | | | | | | The unit is [°C]. |
| 524 | 0011000001 | IC2 Gas pipe temp. | ↑ | | | | | | | | |

| No. | SW1 | Item | LED | | | | | | | | Remarks |
|-----|------------|---------------------|---------------|-----|-----|-----|-----|-----|-----|-----|---------------------|
| | 1234567890 | | LD1 | LD2 | LD3 | LD4 | LD5 | LD6 | LD7 | LD8 | |
| 525 | 1011000001 | IC3 Gas pipe temp. | -99.9 ~ 999.9 | | | | | | | | The unit is [°C]. |
| 526 | 0111000001 | IC4 Gas pipe temp. | ↑ | | | | | | | | |
| 527 | 1111000001 | IC5 Gas pipe temp. | ↑ | | | | | | | | |
| 528 | 0000100001 | IC6 Gas pipe temp. | ↑ | | | | | | | | |
| 529 | 1000100001 | IC7 Gas pipe temp. | ↑ | | | | | | | | |
| 530 | 0100100001 | IC8 Gas pipe temp. | ↑ | | | | | | | | |
| 531 | 1100100001 | IC9 Gas pipe temp. | ↑ | | | | | | | | |
| 532 | 0010100001 | IC10 Gas pipe temp. | ↑ | | | | | | | | |
| 533 | 1010100001 | IC11 Gas pipe temp. | ↑ | | | | | | | | |
| 534 | 0110100001 | IC12 Gas pipe temp. | ↑ | | | | | | | | |
| 535 | 1110100001 | IC13 Gas pipe temp. | ↑ | | | | | | | | |
| 536 | 0001100001 | IC14 Gas pipe temp. | ↑ | | | | | | | | |
| 537 | 1001100001 | IC15 Gas pipe temp. | ↑ | | | | | | | | |
| 538 | 0101100001 | IC16 Gas pipe temp. | ↑ | | | | | | | | |
| 539 | 1101100001 | IC17 Gas pipe temp. | ↑ | | | | | | | | |
| 540 | 0011100001 | IC18 Gas pipe temp. | ↑ | | | | | | | | |
| 541 | 1011100001 | IC19 Gas pipe temp. | ↑ | | | | | | | | |
| 542 | 0111100001 | IC20 Gas pipe temp. | ↑ | | | | | | | | |
| 543 | 1111100001 | IC21 Gas pipe temp. | ↑ | | | | | | | | |
| 544 | 0000010001 | IC22 Gas pipe temp. | ↑ | | | | | | | | |
| 545 | 1000010001 | IC23 Gas pipe temp. | ↑ | | | | | | | | |
| 546 | 0100010001 | IC24 Gas pipe temp. | ↑ | | | | | | | | |
| 547 | 1100010001 | IC25 Gas pipe temp. | ↑ | | | | | | | | |
| 548 | 0010010001 | IC26 Gas pipe temp. | ↑ | | | | | | | | |
| 549 | 1010010001 | IC27 Gas pipe temp. | ↑ | | | | | | | | |
| 550 | 0110010001 | IC28 Gas pipe temp. | ↑ | | | | | | | | |
| 551 | 1110010001 | IC29 Gas pipe temp. | ↑ | | | | | | | | |
| 552 | 0001010001 | IC30 Gas pipe temp. | ↑ | | | | | | | | |
| 553 | 1001010001 | IC31 Gas pipe temp. | ↑ | | | | | | | | |
| 554 | 0101010001 | IC32 Gas pipe temp. | ↑ | | | | | | | | |
| 555 | 1101010001 | | | | | | | | | | |
| 556 | 0011010001 | | | | | | | | | | |
| 557 | 1011010001 | | | | | | | | | | |
| 558 | 0111010001 | | | | | | | | | | |
| 559 | 1111010001 | | | | | | | | | | |
| 560 | 0000110001 | | | | | | | | | | |
| 561 | 1000110001 | | | | | | | | | | |
| 562 | 0100110001 | | | | | | | | | | |
| 563 | 1100110001 | | | | | | | | | | |
| 564 | 0010110001 | | | | | | | | | | |
| 565 | 1010110001 | | | | | | | | | | |
| 566 | 0110110001 | | | | | | | | | | |
| 567 | 1110110001 | | | | | | | | | | |

| No. | SW1 | Item | LED | | | | | | | | Remarks |
|-----|------------|--------|-----|-----|-----|-----|---------------|-----|-----|-----|----------------------|
| | 1234567890 | | LD1 | LD2 | LD3 | LD4 | LD5 | LD6 | LD7 | LD8 | |
| 568 | 0001110001 | | | | | | | | | | |
| 569 | 1001110001 | | | | | | | | | | |
| 570 | 0101110001 | | | | | | | | | | |
| 571 | 1101110001 | | | | | | | | | | |
| 572 | 0011110001 | | | | | | | | | | |
| 573 | 1011110001 | IC1SH | | | | | -99.9 ~ 999.9 | | | | The unit is [deg]. |
| 574 | 0111110001 | IC2SH | | | | | ↑ | | | | |
| 575 | 1111110001 | IC3SH | | | | | ↑ | | | | |
| 576 | 0000001001 | IC4SH | | | | | ↑ | | | | |
| 577 | 1000001001 | IC5SH | | | | | ↑ | | | | |
| 578 | 0100001001 | IC6SH | | | | | ↑ | | | | |
| 579 | 1100001001 | IC7SH | | | | | ↑ | | | | |
| 580 | 0010001001 | IC8SH | | | | | ↑ | | | | |
| 581 | 1010001001 | IC9SH | | | | | ↑ | | | | |
| 582 | 0110001001 | IC10SH | | | | | ↑ | | | | |
| 583 | 1110001001 | IC11SH | | | | | ↑ | | | | |
| 584 | 0001001001 | IC12SH | | | | | ↑ | | | | |
| 585 | 1001001001 | IC13SH | | | | | ↑ | | | | |
| 586 | 0101001001 | IC14SH | | | | | ↑ | | | | |
| 587 | 1101001001 | IC15SH | | | | | ↑ | | | | |
| 588 | 0011001001 | IC16SH | | | | | ↑ | | | | |
| 589 | 1011001001 | IC17SH | | | | | ↑ | | | | |
| 590 | 0111001001 | IC18SH | | | | | ↑ | | | | |
| 591 | 1111001001 | IC19SH | | | | | ↑ | | | | |
| 592 | 0000101001 | IC20SH | | | | | ↑ | | | | |
| 593 | 1000101001 | IC21SH | | | | | ↑ | | | | |
| 594 | 0100101001 | IC22SH | | | | | ↑ | | | | |
| 595 | 1100101001 | IC23SH | | | | | ↑ | | | | |
| 596 | 0010101001 | IC24SH | | | | | ↑ | | | | |
| 597 | 1010101001 | IC25SH | | | | | ↑ | | | | |
| 598 | 0110101001 | IC26SH | | | | | ↑ | | | | |
| 599 | 1110101001 | IC27SH | | | | | ↑ | | | | |
| 600 | 0001101001 | IC28SH | | | | | ↑ | | | | |
| 601 | 1001101001 | IC29SH | | | | | ↑ | | | | |
| 602 | 0101101001 | IC30SH | | | | | ↑ | | | | |
| 603 | 1101101001 | IC31SH | | | | | ↑ | | | | |
| 604 | 0011101001 | IC32SH | | | | | ↑ | | | | |
| 605 | 1011101001 | | | | | | | | | | |
| 606 | 0111101001 | | | | | | | | | | |
| 607 | 1111101001 | | | | | | | | | | |
| 608 | 0000011001 | | | | | | | | | | |
| 609 | 1000011001 | | | | | | | | | | |
| 610 | 0100011001 | | | | | | | | | | |

| No. | SW1 | Item | LED | | | | | | | | Remarks |
|-----|------------|--------|-----|-----|-----|-----|---------------|-----|-----|-----|----------------------|
| | 1234567890 | | LD1 | LD2 | LD3 | LD4 | LD5 | LD6 | LD7 | LD8 | |
| 611 | 1100011001 | | | | | | | | | | |
| 612 | 0010011001 | | | | | | | | | | |
| 613 | 1010011001 | | | | | | | | | | |
| 614 | 0110011001 | | | | | | | | | | |
| 615 | 1110011001 | | | | | | | | | | |
| 616 | 0001011001 | | | | | | | | | | |
| 617 | 1001011001 | | | | | | | | | | |
| 618 | 0101011001 | | | | | | | | | | |
| 619 | 1101011001 | | | | | | | | | | |
| 620 | 0011011001 | | | | | | | | | | |
| 621 | 1011011001 | | | | | | | | | | |
| 622 | 0111011001 | | | | | | | | | | |
| 623 | 1111011001 | IC1SC | | | | | -99.9 ~ 999.9 | | | | The unit is [deg]. |
| 624 | 0000111001 | IC2SC | | | | | ↑ | | | | |
| 625 | 1000111001 | IC3SC | | | | | ↑ | | | | |
| 626 | 0100111001 | IC4SC | | | | | ↑ | | | | |
| 627 | 1100111001 | IC5SC | | | | | ↑ | | | | |
| 628 | 0010111001 | IC6SC | | | | | ↑ | | | | |
| 629 | 1010111001 | IC7SC | | | | | ↑ | | | | |
| 630 | 0110111001 | IC8SC | | | | | ↑ | | | | |
| 631 | 1110111001 | IC9SC | | | | | ↑ | | | | |
| 632 | 0001111001 | IC10SC | | | | | ↑ | | | | |
| 633 | 1001111001 | IC11SC | | | | | ↑ | | | | |
| 634 | 0101111001 | IC12SC | | | | | ↑ | | | | |
| 635 | 1101111001 | IC13SC | | | | | ↑ | | | | |
| 636 | 0011111001 | IC14SC | | | | | ↑ | | | | |
| 637 | 1011111001 | IC15SC | | | | | ↑ | | | | |
| 638 | 0111111001 | IC16SC | | | | | ↑ | | | | |
| 639 | 1111111001 | IC17SC | | | | | ↑ | | | | |
| 640 | 0000000101 | IC18SC | | | | | ↑ | | | | |
| 641 | 1000000101 | IC19SC | | | | | ↑ | | | | |
| 642 | 0100000101 | IC20SC | | | | | ↑ | | | | |
| 643 | 1100000101 | IC21SC | | | | | ↑ | | | | |
| 644 | 0010000101 | IC22SC | | | | | ↑ | | | | |
| 645 | 1010000101 | IC23SC | | | | | ↑ | | | | |
| 646 | 0110000101 | IC24SC | | | | | ↑ | | | | |
| 647 | 1110000101 | IC25SC | | | | | ↑ | | | | |
| 648 | 0001000101 | IC26SC | | | | | ↑ | | | | |
| 649 | 1001000101 | IC27SC | | | | | ↑ | | | | |
| 650 | 0101000101 | IC28SC | | | | | ↑ | | | | |
| 651 | 1101000101 | IC29SC | | | | | ↑ | | | | |
| 652 | 0011000101 | IC30SC | | | | | ↑ | | | | |
| 653 | 1011000101 | IC31SC | | | | | ↑ | | | | |

| No. | SW1 | Item | LED | | | | | | | | Remarks |
|-----|------------|-------------------------|------------------------|-----|-----|-----|-----|-----|-----|-----|--|
| | 1234567890 | | LD1 | LD2 | LD3 | LD4 | LD5 | LD6 | LD7 | LD8 | |
| 654 | 0111000101 | IC32SC | -99.9 ~ 999.9 | | | | | | | | The unit is [deg]. |
| 655 | 1111000101 | | | | | | | | | | |
| 656 | 0000100101 | | | | | | | | | | |
| 657 | 1000100101 | | | | | | | | | | |
| 658 | 0100100101 | | | | | | | | | | |
| 659 | 1100100101 | | | | | | | | | | |
| 660 | 0010100101 | | | | | | | | | | |
| 661 | 1010100101 | | | | | | | | | | |
| 662 | 0110100101 | | | | | | | | | | |
| 663 | 1110100101 | | | | | | | | | | |
| 664 | 0001100101 | | | | | | | | | | |
| 665 | 1001100101 | | | | | | | | | | |
| 666 | 0101100101 | | | | | | | | | | |
| 667 | 1101100101 | | | | | | | | | | |
| 668 | 0011100101 | | | | | | | | | | |
| 669 | 1011100101 | | | | | | | | | | |
| 670 | 0111100101 | | | | | | | | | | |
| 671 | 1111100101 | | | | | | | | | | |
| 672 | 0000010101 | | | | | | | | | | |
| 673 | 1000010101 | | | | | | | | | | |
| 674 | 0100010101 | | | | | | | | | | |
| 675 | 1100010101 | | | | | | | | | | |
| 676 | 0010010101 | INV board S/W version | 0.00 ~ 99.99 | | | | | | | | |
| 677 | 1010010101 | | | | | | | | | | |
| 678 | 0110010101 | | | | | | | | | | |
| 679 | 1110010101 | | | | | | | | | | |
| 680 | 0001010101 | | | | | | | | | | |
| 681 | 1001010101 | | | | | | | | | | |
| 682 | 0101010101 | | | | | | | | | | |
| 683 | 1101010101 | | | | | | | | | | |
| 684 | 0011010101 | | | | | | | | | | |
| 685 | 1011010101 | | | | | | | | | | |
| 686 | 0111010101 | | | | | | | | | | |
| 687 | 1111010101 | | | | | | | | | | |
| 688 | 0000110101 | Current time | 00:00 ~ 23:59 | | | | | | | | Hour : minute |
| 689 | 1000110101 | Current time-2 | 00.00 ~ 99.12 / 1 ~ 31 | | | | | | | | Display alternately year/month and day |
| 690 | 0100110101 | Error detection time1 | 00:00 ~ 23:59 | | | | | | | | Hour : minute |
| 691 | 1100110101 | Error detection time1-2 | 00.00 ~ 99.12 / 1 ~ 31 | | | | | | | | Display alternately year/month and day |
| 692 | 0010110101 | Error detection time2 | 00:00 ~ 23:59 | | | | | | | | Hour : minute |
| 693 | 1010110101 | Error detection time2-2 | 00.00 ~ 99.12 / 1 ~ 31 | | | | | | | | Display alternately year/month and day |
| 694 | 0110110101 | Error detection time3 | 00:00 ~ 23:59 | | | | | | | | Hour : minute |
| 695 | 1110110101 | Error detection time3-2 | 00.00 ~ 99.12 / 1 ~ 31 | | | | | | | | Display alternately year/month and day |

| No. | SW1 | Item | LED | | | | | | | | Remarks |
|-----|------------|--|------------------------|-----|-----|-----|-----|-----|-----|-----|--|
| | 1234567890 | | LD1 | LD2 | LD3 | LD4 | LD5 | LD6 | LD7 | LD8 | |
| 696 | 0001110101 | Error detection time4 | 00:00 ~ 23:59 | | | | | | | | Hour : minute |
| 697 | 1001110101 | Error detection time4-2 | 00.00 ~ 99.12 / 1 ~ 31 | | | | | | | | Display alternately year/month and day |
| 698 | 0101110101 | Error detection time5 | 00:00 ~ 23:59 | | | | | | | | Hour : minute |
| 699 | 1101110101 | Error detection time5-2 | 00.00 ~ 99.12 / 1 ~ 31 | | | | | | | | Display alternately year/month and day |
| 700 | 0011110101 | Error detection time6 | 00:00 ~ 23:59 | | | | | | | | Hour : minute |
| 701 | 1011110101 | Error detection time6-2 | 00.00 ~ 99.12 / 1 ~ 31 | | | | | | | | Display alternately year/month and day |
| 702 | 0111110101 | Error detection time7 | 00:00 ~ 23:59 | | | | | | | | Hour : minute |
| 703 | 1111110101 | Error detection time7-2 | 00.00 ~ 99.12 / 1 ~ 31 | | | | | | | | Display alternately year/month and day |
| 704 | 0000001101 | Error detection time8 | 00:00 ~ 23:59 | | | | | | | | Hour : minute |
| 705 | 1000001101 | Error detection time8-2 | 00.00 ~ 99.12 / 1 ~ 31 | | | | | | | | Display alternately year/month and day |
| 706 | 0100001101 | Error detection time9 | 00:00 ~ 23:59 | | | | | | | | Hour : minute |
| 707 | 1100001101 | Error detection time9-2 | 00.00 ~ 99.12 / 1 ~ 31 | | | | | | | | Display alternately year/month and day |
| 708 | 0010001101 | Error detection time10 | 00:00 ~ 23:59 | | | | | | | | Hour : minute |
| 709 | 1010001101 | Error detection time10-2 | 00.00 ~ 99.12 / 1 ~ 31 | | | | | | | | Display alternately year/month and day |
| 710 | 0110001101 | Time when data before error is saved | 00:00 ~ 23:59 | | | | | | | | Hour : minute |
| 711 | 1110001101 | Time when data before error is saved-2 | 00.00 ~ 99.12 / 1 ~ 31 | | | | | | | | Display alternately year/month and day |
| 712 | 0001001101 | | | | | | | | | | |
| 713 | 1001001101 | | | | | | | | | | |
| 714 | 0101001101 | IC1 LEV opening pulses | 0000 ~ 2000 | | | | | | | | Fully open : 2000 |
| 715 | 1101001101 | IC2 LEV opening pulses | ↑ | | | | | | | | |
| 716 | 0011001101 | IC3 LEV opening pulses | ↑ | | | | | | | | |
| 717 | 1011001101 | IC4 LEV opening pulses | ↑ | | | | | | | | |
| 718 | 0111001101 | IC5 LEV opening pulses | ↑ | | | | | | | | |
| 719 | 1111001101 | IC6 LEV opening pulses | ↑ | | | | | | | | |
| 720 | 0000101101 | IC7 LEV opening pulses | ↑ | | | | | | | | |
| 721 | 1000101101 | IC8 LEV opening pulses | ↑ | | | | | | | | |
| 722 | 0100101101 | IC9 LEV opening pulses | ↑ | | | | | | | | |
| 723 | 1100101101 | IC10 LEV opening pulses | ↑ | | | | | | | | |
| 724 | 0010101101 | IC11 LEV opening pulses | ↑ | | | | | | | | |
| 725 | 1010101101 | IC12 LEV opening pulses | ↑ | | | | | | | | |
| 726 | 0110101101 | IC13 LEV opening pulses | ↑ | | | | | | | | |
| 727 | 1110101101 | IC14 LEV opening pulses | ↑ | | | | | | | | |
| 728 | 0001101101 | IC15 LEV opening pulses | ↑ | | | | | | | | |
| 729 | 1001101101 | IC16 LEV opening pulses | ↑ | | | | | | | | |
| 730 | 0101101101 | IC17 LEV opening pulses | ↑ | | | | | | | | |
| 731 | 1101101101 | IC18 LEV opening pulses | ↑ | | | | | | | | |
| 732 | 0011101101 | IC19 LEV opening pulses | ↑ | | | | | | | | |
| 733 | 1011101101 | IC20 LEV opening pulses | ↑ | | | | | | | | |
| 734 | 0111101101 | IC21 LEV opening pulses | ↑ | | | | | | | | |
| 735 | 1111101101 | IC22 LEV opening pulses | ↑ | | | | | | | | |
| 736 | 0000011101 | IC23 LEV opening pulses | ↑ | | | | | | | | |
| 737 | 1000011101 | IC24 LEV opening pulses | ↑ | | | | | | | | |

| No. | SW1 | Item | LED | | | | | | | | Remarks |
|-----|------------|-------------------------|--|-----|-----|-----|-----|-----|-----|-----|-------------------|
| | 1234567890 | | LD1 | LD2 | LD3 | LD4 | LD5 | LD6 | LD7 | LD8 | |
| 738 | 0100011101 | IC25 LEV opening pulses | 0000 ~ 2000 | | | | | | | | Fully open : 2000 |
| 739 | 1100011101 | IC26 LEV opening pulses | ↑ | | | | | | | | |
| 740 | 0010011101 | IC27 LEV opening pulses | ↑ | | | | | | | | |
| 741 | 1010011101 | IC28 LEV opening pulses | ↑ | | | | | | | | |
| 742 | 0110011101 | IC29 LEV opening pulses | ↑ | | | | | | | | |
| 743 | 1110011101 | IC30 LEV opening pulses | ↑ | | | | | | | | |
| 744 | 0001011101 | IC31 LEV opening pulses | ↑ | | | | | | | | |
| 745 | 1001011101 | IC32 LEV opening pulses | ↑ | | | | | | | | |
| 746 | 0101011101 | | | | | | | | | | |
| 747 | 1101011101 | | | | | | | | | | |
| 748 | 0011011101 | | | | | | | | | | |
| 749 | 1011011101 | | | | | | | | | | |
| 750 | 0111011101 | | | | | | | | | | |
| 751 | 1111011101 | | | | | | | | | | |
| 752 | 0000111101 | | | | | | | | | | |
| 753 | 1000111101 | | | | | | | | | | |
| 754 | 0100111101 | | | | | | | | | | |
| 755 | 1100111101 | | | | | | | | | | |
| 756 | 0010111101 | | | | | | | | | | |
| 757 | 1010111101 | | | | | | | | | | |
| 758 | 0110111101 | | | | | | | | | | |
| 759 | 1110111101 | | | | | | | | | | |
| 760 | 0001111101 | | | | | | | | | | |
| 761 | 1001111101 | | | | | | | | | | |
| 762 | 0101111101 | | | | | | | | | | |
| 763 | 1101111101 | | | | | | | | | | |
| 764 | 0011111101 | IC1 Operation mode | 0000 : Off 0001 : Fan 0002 : Cooling 0003 : Heating 0004 : Dry | | | | | | | | |
| 765 | 1011111101 | IC2 Operation mode | | | | | | | | | |
| 766 | 0111111101 | IC3 Operation mode | | | | | | | | | |
| 767 | 1111111101 | IC4 Operation mode | | | | | | | | | |
| 768 | 0000000011 | IC5 Operation mode | | | | | | | | | |
| 769 | 1000000011 | IC6 Operation mode | | | | | | | | | |
| 770 | 0100000011 | IC7 Operation mode | | | | | | | | | |
| 771 | 1100000011 | IC8 Operation mode | | | | | | | | | |
| 772 | 0010000011 | IC9 Operation mode | | | | | | | | | |
| 773 | 1010000011 | IC10 Operation mode | | | | | | | | | |
| 774 | 0110000011 | IC11 Operation mode | | | | | | | | | |
| 775 | 1110000011 | IC12 Operation mode | | | | | | | | | |
| 776 | 0001000011 | IC13 Operation mode | | | | | | | | | |
| 777 | 1001000011 | IC14 Operation mode | | | | | | | | | |
| 778 | 0101000011 | IC15 Operation mode | | | | | | | | | |
| 779 | 1101000011 | IC16 Operation mode | | | | | | | | | |
| 780 | 0011000011 | IC17 Operation mode | | | | | | | | | |

| No. | SW1 | Item | LED | | | | | | | | Remarks | |
|-----|------------|---------------------|-----|-----|-----|-----|-----|-----|-----|-----|---------|--|
| | 1234567890 | | LD1 | LD2 | LD3 | LD4 | LD5 | LD6 | LD7 | LD8 | | |
| 781 | 1011000011 | IC18 Operation mode | | | | | | | | | | |
| 782 | 0111000011 | IC19 Operation mode | | | | | | | | | | |
| 783 | 1111000011 | IC20 Operation mode | | | | | | | | | | |
| 784 | 0000100011 | IC21 Operation mode | | | | | | | | | | |
| 785 | 1000100011 | IC22 Operation mode | | | | | | | | | | |
| 786 | 0100100011 | IC23 Operation mode | | | | | | | | | | |
| 787 | 1100100011 | IC24 Operation mode | | | | | | | | | | |
| 788 | 0010100011 | IC25 Operation mode | | | | | | | | | | |
| 789 | 1010100011 | IC26 Operation mode | | | | | | | | | | |
| 790 | 0110100011 | IC27 Operation mode | | | | | | | | | | |
| 791 | 1110100011 | IC28 Operation mode | | | | | | | | | | |
| 792 | 0001100011 | IC29 Operation mode | | | | | | | | | | |
| 793 | 1001100011 | IC30 Operation mode | | | | | | | | | | |
| 794 | 0101100011 | IC31 Operation mode | | | | | | | | | | |
| 795 | 1101100011 | IC32 Operation mode | | | | | | | | | | |
| 796 | 0011100011 | | | | | | | | | | | |
| 797 | 1011100011 | | | | | | | | | | | |
| 798 | 0111100011 | | | | | | | | | | | |
| 799 | 1111100011 | | | | | | | | | | | |
| 800 | 0000010011 | | | | | | | | | | | |
| 801 | 1000010011 | | | | | | | | | | | |
| 802 | 0100010011 | | | | | | | | | | | |
| 803 | 1100010011 | | | | | | | | | | | |
| 804 | 0010010011 | | | | | | | | | | | |
| 805 | 1010010011 | | | | | | | | | | | |
| 806 | 0110010011 | | | | | | | | | | | |
| 807 | 1110010011 | | | | | | | | | | | |
| 808 | 0001010011 | | | | | | | | | | | |
| 809 | 1001010011 | | | | | | | | | | | |
| 810 | 0101010011 | | | | | | | | | | | |
| 811 | 1101010011 | | | | | | | | | | | |
| 812 | 0011010011 | | | | | | | | | | | |
| 813 | 1011010011 | | | | | | | | | | | |
| 814 | 0111010011 | IC1 Filter | | | | | | | | | | |
| 815 | 1111001001 | IC2 Filter | | | | | | | | | | |
| 816 | 0000101011 | IC3 Filter | | | | | | | | | | |
| 817 | 1000101011 | IC4 Filter | | | | | | | | | | |
| 818 | 0100101011 | IC5 Filter | | | | | | | | | | |
| 819 | 1100101011 | IC6 Filter | | | | | | | | | | |
| 820 | 0010101011 | IC7 Filter | | | | | | | | | | |
| 821 | 1010101011 | IC8 Filter | | | | | | | | | | |
| 822 | 0110101011 | IC9 Filter | | | | | | | | | | |
| 823 | 1110101011 | IC10 Filter | | | | | | | | | | |

0000 : Off
0001 : Fan
0002 : Cooling
0003 : Heating
0004 : Dry

Hours since previous maintenance [h]

| No. | SW1 | Item | LED | | | | | | | | Remarks |
|-----|------------|-------------|-------------|-----|-----|-----|-----|-----|-----|-----|--|
| | 1234567890 | | LD1 | LD2 | LD3 | LD4 | LD5 | LD6 | LD7 | LD8 | |
| 824 | 0001101011 | IC11 Filter | 0000 ~ 9999 | | | | | | | | Hours since previous maintenance [h] |
| 825 | 1001101011 | IC12 Filter | ↑ | | | | | | | | |
| 826 | 0101101011 | IC13 Filter | ↑ | | | | | | | | |
| 827 | 1101101011 | IC14 Filter | ↑ | | | | | | | | |
| 828 | 0011101011 | IC15 Filter | ↑ | | | | | | | | |
| 829 | 1011101011 | IC16 Filter | ↑ | | | | | | | | |
| 830 | 0111101011 | IC17 Filter | ↑ | | | | | | | | |
| 831 | 1111101011 | IC18 Filter | ↑ | | | | | | | | |
| 832 | 0000011011 | IC19 Filter | ↑ | | | | | | | | |
| 833 | 1000011011 | IC20 Filter | ↑ | | | | | | | | |
| 834 | 0100011011 | IC21 Filter | ↑ | | | | | | | | |
| 835 | 1100011011 | IC22 Filter | ↑ | | | | | | | | |
| 836 | 0010011011 | IC23 Filter | ↑ | | | | | | | | |
| 837 | 1010011011 | IC24 Filter | ↑ | | | | | | | | |
| 838 | 0110011011 | IC25 Filter | ↑ | | | | | | | | |
| 839 | 1110011011 | IC26 Filter | ↑ | | | | | | | | |
| 840 | 0001011011 | IC27 Filter | ↑ | | | | | | | | |
| 841 | 1001011011 | IC28 Filter | ↑ | | | | | | | | |
| 842 | 0101011011 | IC29 Filter | ↑ | | | | | | | | |
| 843 | 1101011011 | IC30 Filter | ↑ | | | | | | | | |
| 844 | 0011011011 | IC31 Filter | ↑ | | | | | | | | |
| 845 | 1011011011 | IC32 Filter | ↑ | | | | | | | | |
| 846 | 0111001001 | | | | | | | | | | |
| 847 | 1111001011 | | | | | | | | | | |
| 848 | 0000101011 | | | | | | | | | | |
| 849 | 1000101011 | | | | | | | | | | |
| 850 | 0100101011 | | | | | | | | | | |
| 851 | 1100101011 | | | | | | | | | | |
| 852 | 0010101011 | | | | | | | | | | |
| 853 | 1010101011 | | | | | | | | | | |
| 854 | 0110101011 | | | | | | | | | | |
| 855 | 1110101011 | | | | | | | | | | |
| 856 | 0001101011 | | | | | | | | | | |
| 857 | 1001101011 | | | | | | | | | | |
| 858 | 0101101011 | | | | | | | | | | |
| 859 | 1101101011 | | | | | | | | | | |
| 860 | 0011101011 | | | | | | | | | | |
| 861 | 1011101011 | | | | | | | | | | |
| 862 | 0111101011 | | | | | | | | | | |
| 863 | 1111101011 | | | | | | | | | | |
| 864 | 0000011011 | | | | | | | | | | |
| 865 | 1000011011 | | | | | | | | | | |
| 866 | 0100011011 | | | | | | | | | | |

| No. | SW1 | Item | LED | | | | | | | | Remarks |
|-----|------------|-----------------------------------|-----|-----|-----|-----|---------------|-----|-----|-----|-----------------------|
| | 1234567890 | | LD1 | LD2 | LD3 | LD4 | LD5 | LD6 | LD7 | LD8 | |
| 867 | 1100011011 | | | | | | | | | | |
| 868 | 0010011011 | | | | | | | | | | |
| 869 | 1010011011 | | | | | | | | | | |
| 870 | 0110011011 | | | | | | | | | | |
| 871 | 1110011011 | U phase current effective value 1 | | | | | -99.9 ~ 999.9 | | | | The unit is [A]. |
| 872 | 0001011011 | W phase current effective value 1 | | | | | ↑ | | | | |
| 873 | 1001011011 | Power factor phase angle 1 (deg) | | | | | ↑ | | | | The unit is [deg]. |
| 874 | 0101011011 | | | | | | | | | | |
| 875 | 1101011011 | | | | | | | | | | |
| 876 | 0011011011 | | | | | | | | | | |
| 877 | 1011011011 | | | | | | | | | | |
| 878 | 0111011011 | | | | | | | | | | |
| 879 | 1111011011 | | | | | | | | | | |
| 880 | 0000111011 | Main circuit board reset counter | | | | | 0 ~ 254 | | | | The unit is [Time]. |
| 881 | 1000111011 | INV board reset counter | | | | | ↑ | | | | |
| 882 | 0100111011 | | | | | | | | | | |
| 883 | 1100111011 | | | | | | | | | | |
| 884 | 0010111011 | | | | | | | | | | |
| 885 | 1010111011 | | | | | | | | | | |
| 886 | 0110111011 | | | | | | | | | | |
| 887 | 1110111011 | | | | | | | | | | |
| 888 | 0001111011 | | | | | | | | | | |
| 889 | 1001111011 | | | | | | | | | | |
| 890 | 0101111011 | | | | | | | | | | |
| 891 | 1101111011 | | | | | | | | | | |
| 892 | 0011111011 | | | | | | | | | | |
| 893 | 1011111011 | | | | | | | | | | |
| 894 | 0111111011 | | | | | | | | | | |
| 895 | 1111111011 | | | | | | | | | | |
| 896 | 000000111 | | | | | | | | | | |
| 897 | 100000111 | | | | | | | | | | |
| 898 | 010000111 | | | | | | | | | | |
| 899 | 110000111 | | | | | | | | | | |
| 900 | 001000111 | | | | | | | | | | |
| 901 | 101000111 | | | | | | | | | | |
| 902 | 011000111 | | | | | | | | | | |
| 903 | 111000111 | | | | | | | | | | |
| 904 | 0001000111 | | | | | | | | | | |
| 905 | 1001000111 | | | | | | | | | | |
| 906 | 0101000111 | | | | | | | | | | |

| No. | SW1 | Item | LED | | | | | | | | Remarks |
|------|------------|------|-----|-----|-----|-----|-----|-----|-----|-----|---------|
| | 1234567890 | | LD1 | LD2 | LD3 | LD4 | LD5 | LD6 | LD7 | LD8 | |
| 907 | 1101000111 | | | | | | | | | | |
| 1020 | 0011111111 | | | | | | | | | | |
| 1021 | 1011111111 | | | | | | | | | | |
| 1022 | 0111111111 | | | | | | | | | | |
| 1023 | 1111111111 | | | | | | | | | | |