



# PMFY-P20VBM-E

Indoor Unit

1-Way Blow Ceiling Cassette



Utilising a compact and lightweight body, the unit is perfect for applications where ceiling space is limited. A total body weight of 14kg makes it one of the lightest available, latest fan technology also makes it one of the quietest.

- **Compact size for handy installation and easy maintenance**
- **Newly developed airflow control technology reduces noise levels to only 27dBA**
- **Drain lift pump mechanism allows the drain to be positioned anywhere up to 600mm from the ceiling's surface**
- **Only 230mm high**
- **Fresh air duct facility**

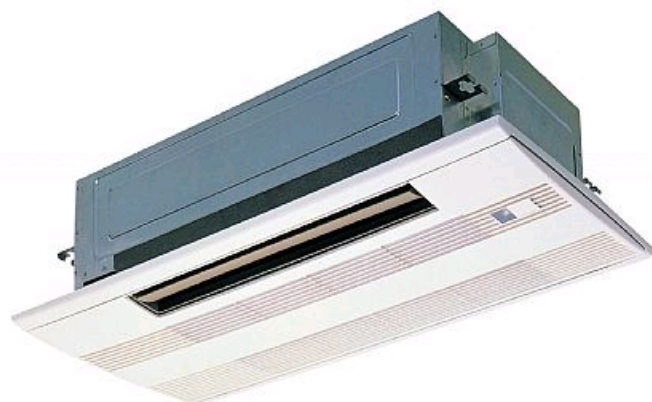

Pictures not to scale

## Product Details

PMFY-P20VBM-E	
Capacity (kW):	
Heating (Nominal)	2.5
Cooling (Nominal)	2.2
Heating (UK)	2.5
Cooling (UK)	2.1
R410A High Sensible Cooling (UK)	1.6
SHF R410A (UK)	0.86
SHF High Sensible R410A (UK)	1.0
Power Input (kW) Heating (Nominal)	0.042
Power Input (kW) Cooling (Nominal)	0.042
Airflow(m <sup>3</sup> /min) - Lo-Mi1-Mi2-Hi	6.5-7.2-8-8.7
Noise (dBA) - Lo-Mi1-Mi2-Hi	27-30-33-35
Width (grille) - mm	812 (1000)
Depth (grille) - mm	395 (470)
Height (grille) - mm	230 (30)
Weight (grille) - kg	14 (3)
Electrical Supply	220-240v, 50Hz
Phase	Single
Mains Cable No. Cores	3
Running Current (A) - Heating	0.2
Running Current (A) - Cooling	0.2
Fuse Rating (BS88) - HRC (A)	6
Grille Ref	PMP-40BMW WHITE GRILLE FOR PMFY- P VBM-E

## Dimensions

PMFY-P20VBM-E

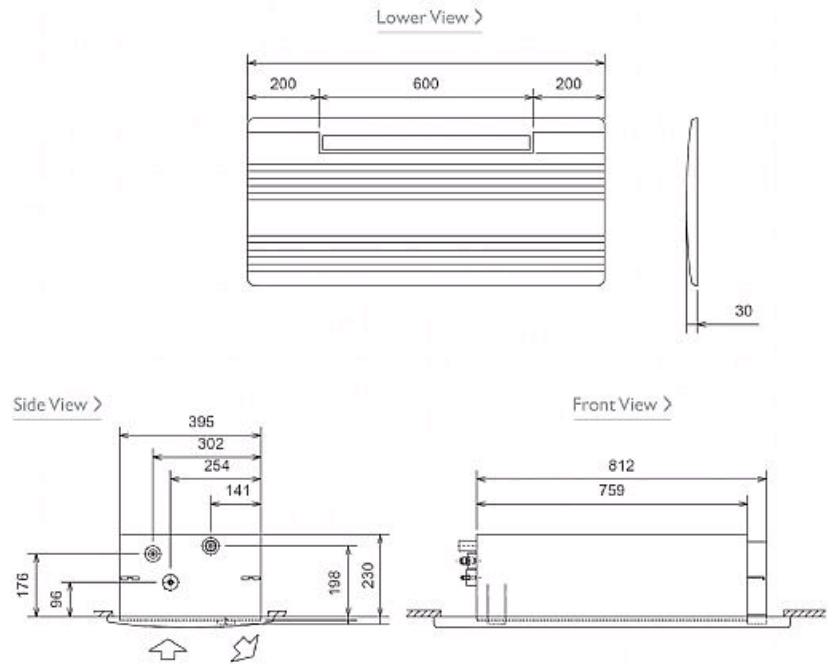

**Telephone: 01707 282880**

Email: [air.conditioning@meuk.mee.com](mailto:air.conditioning@meuk.mee.com) Website: <http://www.mitsubishielectric.co.uk/aircon>

Mitsubishi Electric reserves the right to make any variation in technical specification to the equipment described, or to withdraw or replace products without prior notification or public announcement.

Tel:  
Fax:

