

Air-Conditioners For Building Application**INDOOR UNIT****CE****PLFY-P-VLMD-E****INSTALLATION MANUAL**

For safe and correct use, please read this installation manual thoroughly before installing the air-conditioner unit.

INSTALLATIONSHANDBUCH

Zum sicheren und ordnungsgemäßen Gebrauch der Klimageräte das Installationshandbuch gründlich durchlesen.

MANUEL D'INSTALLATION

Veillez lire le manuel d'installation en entier avant d'installer ce climatiseur pour éviter tout accident et vous assurer d'une utilisation correcte.

MANUAL DE INSTALACIÓN

Para un uso seguro y correcto, lea detalladamente este manual de instalación antes de montar la unidad de aire acondicionado.

MANUALE DI INSTALLAZIONE

Per un uso sicuro e corretto, leggere attentamente questo manuale di installazione prima di installare il condizionatore d'aria.

INSTALLATIEHANDLEIDING

Voor een veilig en juist gebruik moet u deze installatiehandleiding grondig doorlezen voordat u de airconditioner installeert.

MANUAL DE INSTALAÇÃO

Para segurança e utilização correctas, leia atentamente este manual de instalação antes de instalar a unidade de ar condicionado.

ΕΓΧΕΙΡΙΔΙΟ ΟΔΗΓΙΩΝ ΕΓΚΑΤΑΣΤΑΣΗΣ

Για ασφάλεια και σωστή χρήση, παρακαλείστε διαβάσετε προσεχτικά αυτό το εγχειρίδιο εγκατάστασης πριν αρχίσετε την εγκατάσταση της μονάδας κλιματισμού.

РУКОВОДСТВО ПО УСТАНОВКЕ

Для осторожного и правильного использования прибора необходимо тщательно ознакомиться с данным руководством по установке до выполнения установки кондиционера.

MONTAJ ELKİTABI

Emniyetli ve doğru biçimde nasıl kullanılacağını öğrenmek için lütfen klima cihazını monte etmeden önce bu elkitabını dikkatle okuyunuz.

安装手册

为了安全和正确地使用本空调器，请在安装前仔细阅读本安装手册。

PŘÍRUČKA K INSTALACI

V zájmu bezpečného a správného používání si před instalací klimatizační jednotky důkladně pročtěte tuto příručku k instalaci.

NÁVOD NA INŠTALÁCIU

Pre bezpečné a správne použitie si pred inštalovaním klimatizačnej jednotky, prosím, starostlivo prečítajte tento návod na inštaláciu.

TELEPÍTÉSI KÉZIKÖNYV

A biztonságos és helyes használatához, kérjük, olvassa el alaposan ezt a telepítési kézikönyvet, mielőtt telepítené a légkondicionáló egységet.

PODRECZNIK INSTALACJI

W celu bezpiecznego i poprawnego korzystania należy przed zainstalowaniem klimatyzatora dokładnie zapoznać się z niniejszym podręcznikiem instalacji.

GB

D

F

E

I

NL

P

GR

RU

TR

中

CZ

SV

HG

PO

[Fig. 3.1.1]

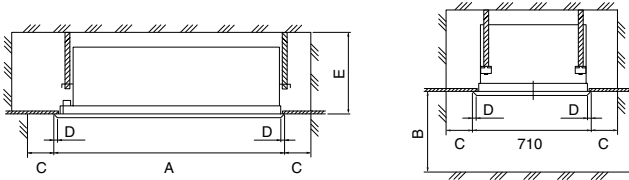

Model name	20-40	50 - 63	80 - 100	125
A	1080	1250	1750	2010
B	More than 1000			
C	More than 500			
D	Lap: 20			
E	More than 350			

[Fig. 3.2.1]

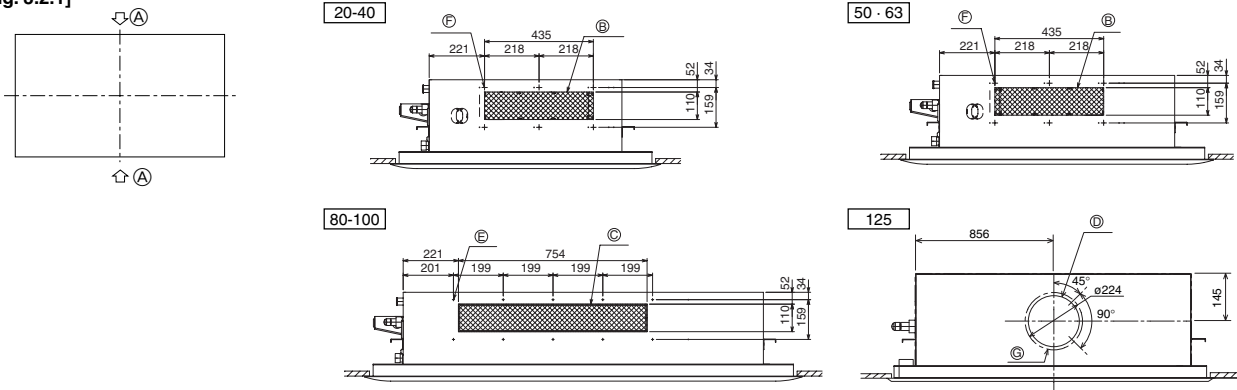

• Knockouts are provided at each position as shown in the figure. Use them for your purposes when installing the unit.

- (A) Split flow duct end connection
- (B) Split flow duct end connection (435 × 110 knock out on both sides)
- (C) Split flow duct end connection (754 × 110 knock out on both sides)
- (D) Split flow duct end connection (ø200 knock out on both sides)
- (E) 10-ø2.9 mounting hole
- (F) 6-ø2.9 mounting hole
- (G) 4-ø2.9 mounting hole

[Fig. 3.3.1]

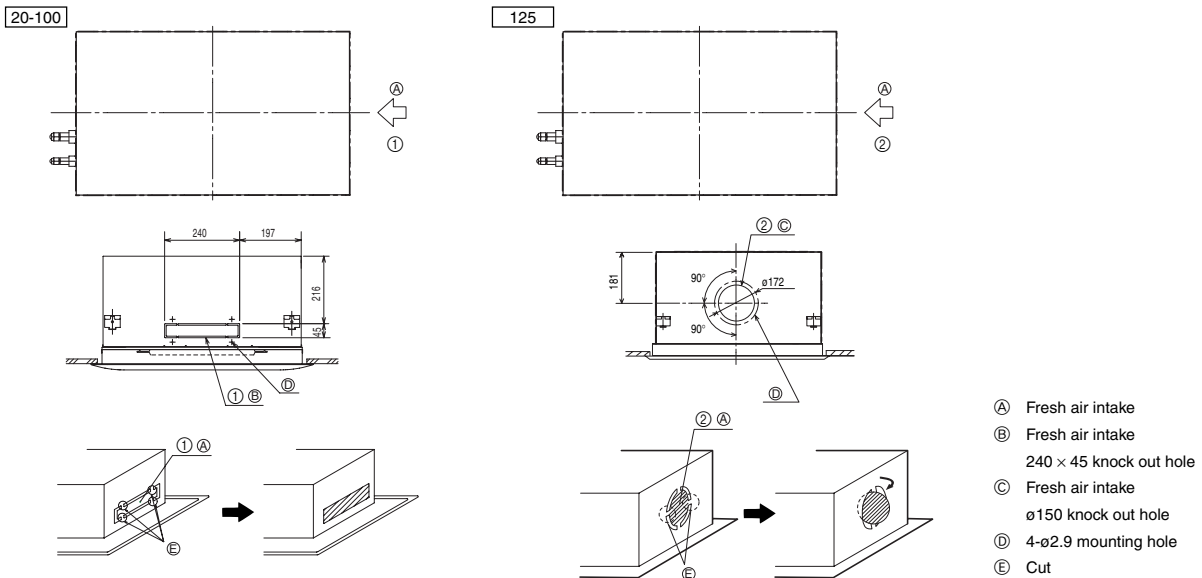

- (A) Fresh air intake
- (B) Fresh air intake
240 × 45 knock out hole
- (C) Fresh air intake
ø150 knock out hole
- (D) 4-ø2.9 mounting hole
- (E) Cut

[Fig. 4.1.1]

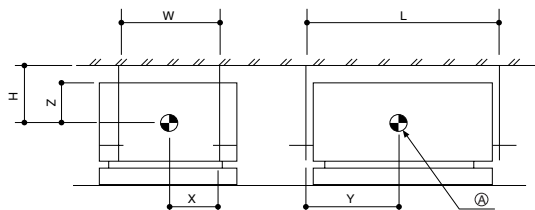

- (A) Center of gravity

4.2

[Fig. 4.2.1]

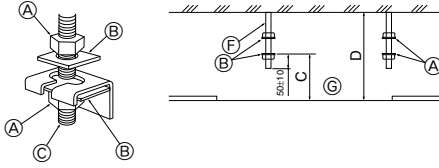

- A Nut
- B Washer (supplied with the unit body)
- C Hanging bolt $\phi 10$ (M10 screw)
- D Ceiling hole dimensions
- E Hanging bolt pitch
- F Finished ceiling surface
- G Hanging bracket

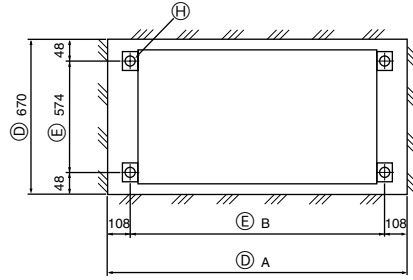

Model name	20-40	50-63	80-100	125
A	1040	1210	1710	1970
B	824	994	1494	1756
C	157~167			155~165
D	More than 350			

5

5.1

[Fig. 5.1.1]

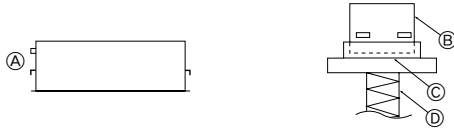

- A Drain pipe side
- B Unit body
- C Packing cap
- D Lifting machine

5.2

[Fig. 5.2.1]

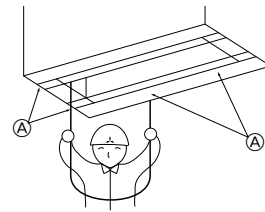

- A Indoor unit's bottom surface
(Surface to which a decorative panel is attached)

6

6.1

[Fig. 6.1.1]

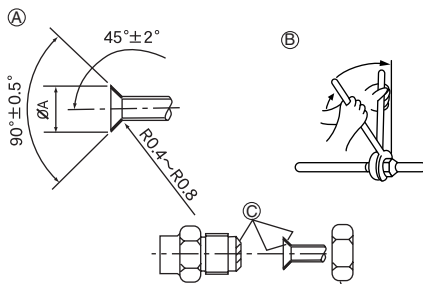

- A Flare cutting dimensions
- B Refrigerant pipe sizes & Flare nut tightening torque
- C Apply refrigerating machine oil over the entire flare seat surface

6.2

[Fig. 6.2.1]

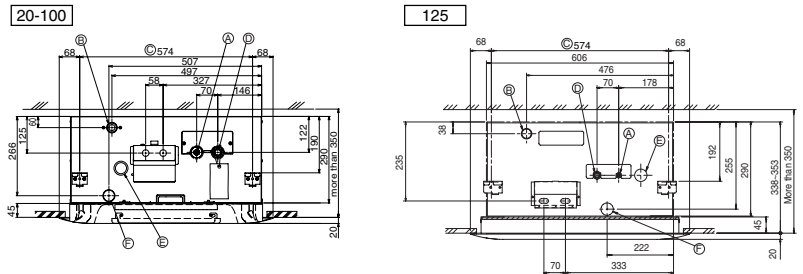

- A Refrigerant pipe (liquid pipe): HP
- B Drain pipe
- C Hanging bolt pitch
- D Refrigerant pipe (gas pipe): LP
- E Filling port
- F Drain hole

6.3

[Fig. 6.3.1]

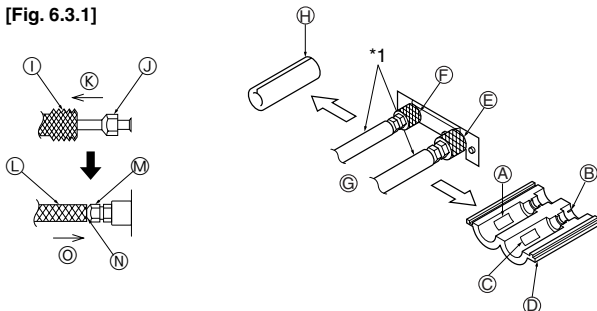

- A "0-0 gas" mark
- B "INNER" mark
- C "OUTER" mark
- D Flare insulation (2)
- E Refrigerant piping (gas)
- F Refrigerant piping (liquid)
- G Field refrigerant piping
- H Pipe insulation (1)
- I Insulation material
- J Flare
- K Pull in this direction.
- L Insulation material
- M Flare
- N There must be no gap.
- O Move to the original position.

[Fig. 6.3.2]

(figure showing the flare insulation)

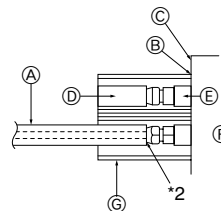

- A Field refrigerant piping
- B There must be no gap.
- C Unit body plate
- D OUTER
- E INNER
- F Unit body
- G Provided flare insulation (2)

[Fig. 6.3.3]

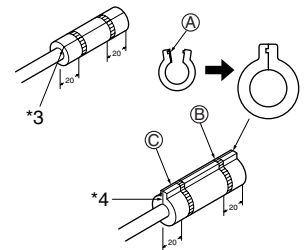

- A Tape (3)
- B Fasten with tape.
- C Provided tie band (4)

[Fig. 7.2.1]

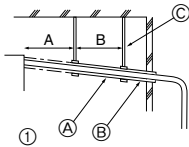

- A: 25 cm
- B: 1.5 – 2 m
- Ⓐ Downward pitch of more than 1/100
- Ⓑ Insulating material
- Ⓒ Metal brace

[Fig. 7.2.2]

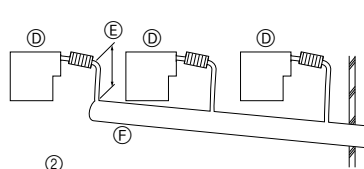

- Ⓓ Indoor unit
- Ⓔ Take as large as possible. About 10 cm
- Ⓕ Collected pipes

[Fig. 7.2.3]

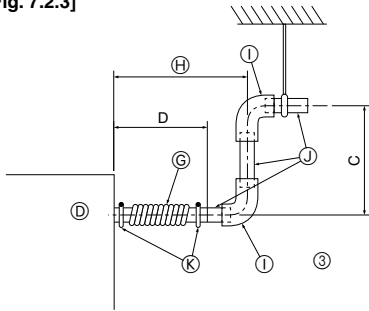

- C: 28 cm D: 170 ± 5 mm
- Ⓖ Drain hose (Accessory)
- ▶ Be sure to use the supplied drain hose (Accessory).
- Ⓗ Less than 300 mm
- Ⓘ Hard vinyl chloride 90° elbow (field supply)
- ⓵ Hard vinyl chloride (VP-25) (field supply)
- Ⓚ Tie band (small) (Accessory)

[Fig. 7.3.1]

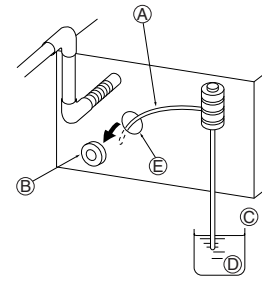

- Ⓐ Insert the pump's end 2 to 4 cm.
- Ⓑ Remove the polyethylene plug.
- Ⓒ About 1000 cc
- Ⓓ Water
- Ⓔ Filling port

[Fig. 8.1.1]

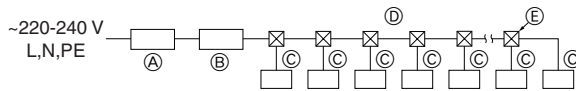

- Ⓐ Switch 16 A (Breakers for Current Leakage)
- Ⓑ Switch 16 A (Breakers for Wiring or Main Switch)
- Ⓒ Indoor unit
- Ⓓ Total operating current be less than 16 A
- Ⓔ Pull box

[Fig. 8.2.1]

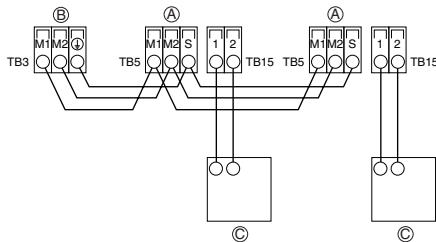

[Fig. 8.2.2]

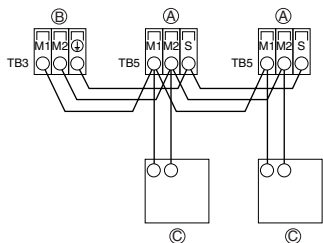

- Ⓐ Terminal block for indoor transmission cable
- Ⓑ Terminal block for outdoor transmission cable
- Ⓒ Remote controller

[Fig. 8.2.7]

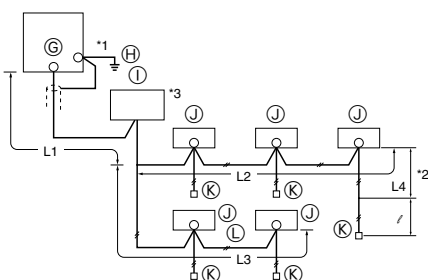

- Ⓖ Outdoor unit
- Ⓗ Earth
- Ⓘ BC controller
- ⓵ Indoor unit
- Ⓚ Remote controller
- Ⓛ Non-polarized 2-wire

[Fig. 8.2.3]

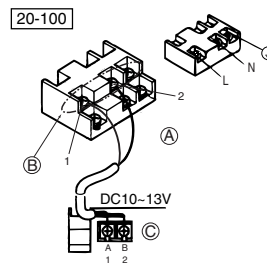

[Fig. 8.2.4]

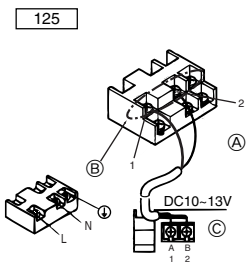

[Fig. 8.2.5]

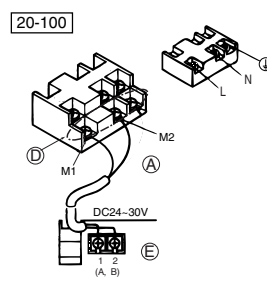

[Fig. 8.2.6]

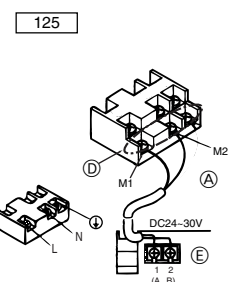

- Ⓐ Non-polarized
- Ⓑ Upper level (TB15)
- Ⓒ MA Remote Controller
- Ⓓ Lower level (TB5)
- Ⓔ M-NET Remote Controller

1. Safety precautions	6	5.2. Confirming the unit's position and fixing hanging bolts	9
1.1. Before installation and electric work	6	6. Refrigerant pipe and drain pipe specifications	9
1.2. Precautions for devices that use R410A or R407C refrigerant ..	6	6.1. Refrigerant pipe and drain pipe specifications	9
1.3. Before getting installed	7	6.2. Refrigerant pipe, drain pipe and filling port	9
1.4. Before getting installed (moved) - electrical work	7	6.3. Request for refrigerant piping connection	9
1.5. Before starting the test run	7	7. Connecting refrigerant pipes and drain pipes	10
2. Indoor unit accessories	7	7.1. Refrigerant piping work	10
3. Selecting an installation site	7	7.2. Drain piping work	10
3.1. Securing installation and service space	8	7.3. Confirming drain discharge	10
3.2. Split flow duct end connection - fresh air intake	8	8. Electrical wiring	11
3.3. Outdoor air inlet	8	8.1. Power supply wiring	11
3.4. Combining indoor units with outdoor units	8	8.2. Connecting remote controller, indoor and outdoor transmission cables	12
4. Fixing hanging bolts	8	8.3. Connecting electrical connections	12
4.1. Fixing hanging bolts	8	8.4. Setting addresses	12
4.2. Ceiling hole and hanging bolt positions	8	8.5. Sensing room temperature with the built-in sensor in a remote controller	12
5. Installing the unit	8		
5.1. Hanging the unit body	8		

1. Safety precautions

1.1. Before installation and electric work





- ▶ **Before installing the unit, make sure you read all the "Safety precautions".**
- ▶ **The "Safety precautions" provide very important points regarding safety. Make sure you follow them.**

Symbols used in the text

 **Warning:**
Describes precautions that should be observed to prevent danger of injury or death to the user.

 **Caution:**
Describes precautions that should be observed to prevent damage to the unit.

Symbols used in the illustrations

-  : Indicates an action that must be avoided.
-  : Indicates that important instructions must be followed.
-  : Indicates a part which must be grounded.
-  : Indicates that caution should be taken with rotating parts. (This symbol is displayed on the main unit label.) <Color: yellow>
-  : Beware of electric shock (This symbol is displayed on the main unit label.) <Color: yellow>

 **Warning:**
Carefully read the labels affixed to the main unit.

-  **Warning:**
- **Ask the dealer or an authorized technician to install the air conditioner.**
 - Improper installation by the user may result in water leakage, electric shock, or fire.
 - **Install the air unit at a place that can withstand its weight.**
 - Inadequate strength may cause the unit to fall down, resulting in injuries.
 - **Use the specified cables for wiring. Make the connections securely so that the outside force of the cable is not applied to the terminals.**
 - Inadequate connection and fastening may generate heat and cause a fire.
 - **Prepare for typhoons and other strong winds and earthquakes and install the unit at the specified place.**
 - Improper installation may cause the unit to topple and result in injury.
 - **Always use an air cleaner, humidifier, electric heater, and other accessories specified by Mitsubishi Electric.**
 - Ask an authorized technician to install the accessories. Improper installation by the user may result in water leakage, electric shock, or fire.
 - **Never repair the unit. If the air conditioner must be repaired, consult the dealer.**
 - If the unit is repaired improperly, water leakage, electric shock, or fire may result.
 - **Do not touch the heat exchanger fins.**
 - Improper handling may result in injury.
 - **When handling this product, always wear protective equipment.**
EG: Gloves, full arm protection namely boiler suit, and safety glasses.
 - Improper handling may result in injury.
 - **If refrigerant gas leaks during installation work, ventilate the room.**
 - If the refrigerant gas comes into contact with a flame, poisonous gases will be released.

- **Install the air conditioner according to this Installation Manual.**
 - If the unit is installed improperly, water leakage, electric shock, or fire may result.
- **Have all electric work done by a licensed electrician according to "Electric Facility Engineering Standard" and "Interior Wire Regulations" and the instructions given in this manual and always use a special circuit.**
 - If the power source capacity is inadequate or electric work is performed improperly, electric shock and fire may result.
- **Securely install the outdoor unit terminal cover (panel).**
 - If the terminal cover (panel) is not installed properly, dust or water may enter the outdoor unit and fire or electric shock may result.
- **When installing and moving the air conditioner to another site, do not charge the it with a refrigerant different from the refrigerant specified on the unit.**
 - If a different refrigerant or air is mixed with the original refrigerant, the refrigerant cycle may malfunction and the unit may be damaged.
- **If the air conditioner is installed in a small room, measures must be taken to prevent the refrigerant concentration from exceeding the safety limit even if the refrigerant should leak.**
 - Consult the dealer regarding the appropriate measures to prevent the safety limit from being exceeded. Should the refrigerant leak and cause the safety limit to be exceeded, hazards due to lack of oxygen in the room could result.
- **When moving and reinstalling the air conditioner, consult the dealer or an authorized technician.**
 - If the air conditioner is installed improperly, water leakage, electric shock, or fire may result.
- **After completing installation work, make sure that refrigerant gas is not leaking.**
 - If the refrigerant gas leaks and is exposed to a fan heater, stove, oven, or other heat source, it may generate noxious gases.
- **Do not reconstruct or change the settings of the protection devices.**
 - If the pressure switch, thermal switch, or other protection device is shorted and operated forcibly, or parts other than those specified by Mitsubishi Electric are used, fire or explosion may result.
- **To dispose of this product, consult your dealer.**
- **Do not use a leak detection additive.**

1.2. Precautions for devices that use R410A or R407C refrigerant

-  **Caution:**
- **Do not use the existing refrigerant piping.**
 - The old refrigerant and refrigerator oil in the existing piping contains a large amount of chlorine which may cause the refrigerator oil of the new unit to deteriorate.
 - **Use refrigerant piping made of phosphorus deoxidized copper and copper alloy seamless pipes and tubes. In addition, be sure that the inner and outer surfaces of the pipes are clean and free of hazardous sulphur, oxides, dust/dirt, shaving particles, oils, moisture, or any other contaminant.**
 - Contaminants on the inside of the refrigerant piping may cause the refrigerant residual oil to deteriorate.
 - **Store the piping to be used during installation indoors and keep both ends of the piping sealed until just before brazing. (Store elbows and other joints in a plastic bag.)**
 - If dust, dirt, or water enters the refrigerant cycle, deterioration of the oil and compressor trouble may result.
 - **Use ester oil, ether oil or alkylbenzene (small amount) as the refrigerator oil to coat flares and flange connections.**
 - The refrigerator oil will degrade if it is mixed with a large amount of mineral oil.

- **Use liquid refrigerant to fill the system.**
 - If gas refrigerant is used to seal the system, the composition of the refrigerant in the cylinder will change and performance may drop.
- **Do not use a refrigerant other than R410A or R407C.**
 - If another refrigerant (R22, etc.) is used, the chlorine in the refrigerant may cause the refrigerator oil to deteriorate.
- **Use a vacuum pump with a reverse flow check valve.**
 - The vacuum pump oil may flow back into the refrigerant cycle and cause the refrigerator oil to deteriorate.
- **Do not use the following tools that are used with conventional refrigerants.**

(Gauge manifold, charge hose, gas leak detector, reverse flow check valve, refrigerant charge base, vacuum gauge, refrigerant recovery equipment)

 - If the conventional refrigerant and refrigerant oil are mixed in the R410A or R407C, the refrigerant may deteriorate.
 - If water is mixed in the R410A or R407C, the refrigerator oil may deteriorate.
 - Since R410A or R407C does not contain any chlorine, gas leak detectors for conventional refrigerants will not react to it.
- **Do not use a charging cylinder.**
 - Using a charging cylinder may cause the refrigerant to deteriorate.
- **Be especially careful when managing the tools.**
 - If dust, dirt, or water gets in the refrigerant cycle, the refrigerant may deteriorate.

- **Install the power cable so that tension is not applied to the cable.**
 - Tension may cause the cable to break and generate heat and cause a fire.
- **Install an leak circuit breaker, as required.**
 - If an leak circuit breaker is not installed, electric shock may result.
- **Use power line cables of sufficient current carrying capacity and rating.**
 - Cables that are too small may leak, generate heat, and cause a fire.
- **Use only a circuit breaker and fuse of the specified capacity.**
 - A fuse or circuit breaker of a larger capacity or a steel or copper wire may result in a general unit failure or fire.
- **Do not wash the air conditioner units.**
 - Washing them may cause an electric shock.
- **Be careful that the installation base is not damaged by long use.**
 - If the damage is left uncorrected, the unit may fall and cause personal injury or property damage.
- **Install the drain piping according to this Installation Manual to ensure proper drainage. Wrap thermal insulation around the pipes to prevent condensation.**
 - Improper drain piping may cause water leakage and damage to furniture and other possessions.
- **Be very careful about product transportation.**
 - Only one person should not carry the product if it weighs more than 20 kg.
 - Some products use PP bands for packaging. Do not use any PP bands for a means of transportation. It is dangerous.
 - Do not touch the heat exchanger fins. Doing so may cut your fingers.
 - When transporting the outdoor unit, suspend it at the specified positions on the unit base. Also support the outdoor unit at four points so that it cannot slip sideways.
- **Safely dispose of the packing materials.**
 - Packing materials, such as nails and other metal or wooden parts, may cause stabs or other injuries.
 - Tear apart and throw away plastic packaging bags so that children will not play with them. If children play with a plastic bag which was not torn apart, they face the risk of suffocation.

1.3. Before getting installed

⚠ Caution:

- **Do not install the unit where combustible gas may leak.**
 - If the gas leaks and accumulates around the unit, an explosion may result.
- **Do not use the air conditioner where food, pets, plants, precision instruments, or artwork are kept.**
 - The quality of the food, etc. may deteriorate.
- **Do not use the air conditioner in special environments.**
 - Oil, steam, sulfuric smoke, etc. can significantly reduce the performance of the air conditioner or damage its parts.
- **When installing the unit in a hospital, communication station, or similar place, provide sufficient protection against noise.**
 - The inverter equipment, private power generator, high-frequency medical equipment, or radio communication equipment may cause the air conditioner to operate erroneously, or fail to operate. On the other hand, the air conditioner may affect such equipment by creating noise that disturbs medical treatment or image broadcasting.
- **Do not install the unit on a structure that may cause leakage.**
 - When the room humidity exceeds 80 % or when the drain pipe is clogged, condensation may drip from the indoor unit. Perform collective drainage work together with the outdoor unit, as required.
- **The indoor models should be installed the ceiling over than 2.5 m from floor.**

1.4. Before getting installed (moved) - electrical work

⚠ Caution:

- **Ground the unit.**
 - Do not connect the ground wire to gas or water pipes, lightning rods, or telephone ground lines. Improper grounding may result in electric shock.

2. Indoor unit accessories

The unit is provided with the following accessories:

Part No.	Accessories	Qty	Place to Set
1	Insulation pipe (small)	1	On the body frame casing
2	Insulating cover	1	
3	Tie band (large)	4	
4	Drain hose	1	
5	Washer	8	

Part No.	Accessories	Qty	Place to Set
6	Tie band (small)	2	On the body frame casing
7	Connector for drain pump test	1	

3. Selecting an installation site

- Select a location so that air can be blown into all corners of the room.
- Avoid locations exposed to outside air.
- Select a location free of obstructions to the airflow in and out of the unit.
- Avoid locations exposed to steam or oil vapour.
- Avoid locations where combustible gas may leak, settle or be generated.
- Avoid installation near machines emitting high-frequency waves (high-frequency welders, etc.).
- Avoid locations where the airflow is directed at a fire alarm sensor. (Hot air could trigger the alarm during the heating operation.)
- Avoid places where acidic solutions are frequently handled.
- Avoid places where sulphur-based or other sprays are frequently used.
- If the unit is run for long hours when the air above the ceiling is at high temperature/high humidity (dew point above 26 °C), dew condensation may be produced in the indoor unit. When operating the units in this condition, add insulation material (10-20 mm) to the entire surface of the indoor unit to avoid dew condensation.

⚠ Warning:

Install the indoor unit on a ceiling strong enough to sustain its weight. If the ceiling lacks strength, it may cause the unit to fall down, resulting in an injury.

3.1. Securing installation and service space

[Fig. 3.1.1] (P.2)

- Select a blowout direction suited for room shape, installation site and so on.
- Piping, wiring and maintenance are all done on the bottom and the side. So, secure the space given above for such work. Also, taking into consideration serviceability and safety in hanging, secure as large space as possible.

Model name	20-40	50 · 63	80 · 100	125
A	1080	1250	1750	2010
B	More than 1000			
C	More than 500			
D	Lap: 20			
E	More than 350			

3.2. Split flow duct end connection - fresh air intake

[Fig. 3.2.1] (P.2)

- Knockouts are provided at each position as shown in the figure. Use them for your purposes when installing the unit.
 - Ⓐ Split flow duct end connection
 - Ⓑ Split flow duct end connection (435 × 110 knock out on both sides)
 - Ⓒ Split flow duct end connection (754 × 110 knock out on both sides)
 - Ⓓ Split flow duct end connection (ø200 knock out on both sides)
 - Ⓔ 10-ø2.9 mounting hole
 - Ⓕ 6-ø2.9 mounting hole
 - Ⓖ 4-ø2.9 mounting hole

4. Fixing hanging bolts

4.1. Fixing hanging bolts

(Give site of suspension strong structure.)

Hanging structure

- Ceiling: The ceiling structure varies from building to one another. For detailed information, consult your construction company.
 - If necessary, reinforce the hanging bolts with anti-quake supporting members as countermeasures against earthquakes.
 - * Use M10 for hanging bolts and anti-quake supporting members (field supply).
- ① Reinforcing the ceiling with additional members (edge beam, etc.) must be required to keep the ceiling at level and to prevent the ceiling from vibrations.
 - ② Cut and remove the ceiling members.
 - ③ Reinforce the ceiling members, and add other members for fixing the ceiling boards.

[Fig. 4.1.1] (P.2)

- Ⓐ Center of gravity

Center of gravity and Product Weight

Model name	W	L	H	X	Y	Z	Unit Weight (kg)	Panel Weight (kg)
PLFY-P20VLMD-E	574	824	172	287	370	160	23	6.5
PLFY-P25VLMD-E	574	824	172	287	370	160	23	6.5
PLFY-P32VLMD-E	574	824	172	287	370	160	24	6.5
PLFY-P40VLMD-E	574	824	172	287	370	160	24	6.5
PLFY-P50VLMD-E	574	994	172	287	445	160	27	7.5
PLFY-P63VLMD-E	574	994	172	287	445	160	28	7.5
PLFY-P80VLMD-E	574	1494	172	287	655	160	44	12.5
PLFY-P100VLMD-E	574	1494	172	287	655	160	47	12.5
PLFY-P125VLMD-E	574	1756	203	287	758	181	56	13

5. Installing the unit

5.1. Hanging the unit body

- ▶ Bring the indoor unit to an installation site as it is packed.
- ▶ To hang the indoor unit, use a lifting machine to lift and pass through the hanging bolts.
- ▶ When lifting with a lifting machine, in order to protect against damage, reverse the unit body as is packed with the packing cap and lift it.

Note:

- Affixed on the back surface of each split flow duct end connection is insulating material. Use a cutter knife to cut the insulating material along the end connection.

3.3. Outdoor air inlet

[Fig. 3.3.1] (P.2)

- Ⓐ Fresh air intake
- Ⓑ Fresh air intake
240 × 45 knock out hole
- Ⓒ Fresh air intake
ø150 knock out hole
- Ⓓ 4-ø2.9 mounting hole
- Ⓔ Cut

Notes:

- ① Make 4 cuts on the outdoor air inlet. When connecting a round flexible duct, mount an optional outdoor air intake duct flange PAC-KH 110F (ø150).
- ② The amount of suction air coming through the outdoor air inlet can be adjusted by making two cuts on the outdoor air inlet as shown in the figure above.

3.4. Combining indoor units with outdoor units

For combining indoor units with outdoor units, refer to the outdoor unit installation manual.

4.2. Ceiling hole and hanging bolt positions

- Use the gauge supplied with the panel to fix hanging bolts so that the unit body and ceiling hole are positioned in place as shown in the figure below. For how to use the gauge, refer to the instruction manual supplied with the panel.

Notes:

- The gauge may expand or shrink with changes in the temperature and humidity. First be sure to check the product dimensions, and then use the gauge.
- The ceiling hole is adjustable as shown in the figure below. Align the centers of both ceiling hole and unit body so that the unit body is not biased to the ceiling hole and that the gaps between the ceiling hole edges and the unit body's external dimensions come to be identical.

- Use M10 hanging bolts (for all bolts). (field supply)
- Each hanging bolt must extrude C mm from the ceiling. It is possible to slide the unit body 10 mm max. within part of the heights of the unit body and decorative panel in order to make fine installation adjustments to the finished ceiling surface. Sliding the unit body and incorporating a high-performance filter requires the dimensions given in the figure below. To this, attach nuts which will fix a hanging bracket as shown in the figure.

[Fig. 4.2.1] (P.3)

- Ⓐ Nut
- Ⓑ Washer (supplied with the unit body)
- Ⓒ Hanging bolt ø10 (M10 screw)
- Ⓓ Ceiling hole dimensions
- Ⓔ Hanging bolt pitch
- Ⓕ Hanging bolt
- Ⓖ Finished ceiling surface
- Ⓗ Hanging bracket

Model name	20 - 40	50 · 63	80 · 100	125
A	1040	1210	1710	1970
B	824	994	1494	1756
C	157 - 167			155 - 165
D	More than 350			

[Fig. 5.1.1] (P.3)

- Ⓐ Drain pipe side
- Ⓑ Unit body
- Ⓒ Packing cap
- Ⓓ Lifting machine

5.2. Confirming the unit's position and fixing hanging bolts

- ▶ Use the gage supplied with the panel to confirm that the unit body and hanging bolts are positioned in place. If they are not positioned in place, it may result in dew drops due to wind leak. Be sure to check the positional relationship.
- ▶ Use a level to check that the surface indicated by **A** is at level. Ensure that the hanging bolt nuts are tightened to fix the hanging bolts.

▶ To ensure that drain is discharged, be sure to hang the unit at level using a level.

Caution:
Be sure to install the unit body at level.

[Fig. 5.2.1] (P.3)

- A** Indoor unit's bottom surface
(Surface to which a decorative panel is attached)

6. Refrigerant pipe and drain pipe specifications

To avoid dew drops, provide sufficient antisweating and insulating work to the refrigerant and drain pipes.

When using commercially available refrigerant pipes, be sure to wind commercially available insulating material (with a heat-resisting temperature of more than 100 °C and thickness given below) onto both liquid and gas pipes.

Be also sure to wind commercially available insulating material (with a form polyethylene's specific gravity of 0.03 and thickness given below) onto all pipes which pass through rooms.

- ① Select the thickness of insulating material by pipe size.

Pipe size	Insulating material's thickness
6.4 mm to 25.4 mm	More than 10 mm
28.6 mm to 38.1 mm	More than 15 mm

- ② If the unit is used on the highest story of a building and under conditions of high temperature and humidity, it is necessary to use pipe size and insulating material's thickness more than those given in the table above.
- ③ If there are customer's specifications, simply follow them.

6.1. Refrigerant pipe and drain pipe specifications

[Fig. 6.1.1] (P.3)

- A** Flare cutting dimensions
- B** Refrigerant pipe sizes & Flare nut tightening torque
- C** Apply refrigerating machine oil over the entire flare seat surface

A Flare cutting dimensions

Copper pipe O.D. (mm)	Flare dimensions	øA dimensions (mm)
ø6.35	8.7 – 9.1	
ø9.52	12.8 – 13.2	
ø12.7	16.2 – 16.6	
ø15.88	19.3 – 19.7	
ø19.05	22.9 – 23.3	

B Refrigerant pipe sizes & Flare nut tightening torque

	R410A				R407C or R22				Flare nut O.D.	
	Liquid pipe		Gas pipe		Liquid pipe		Gas pipe		Liquid pipe (mm)	Gas pipe (mm)
	Pipe size	Tightening torque (N-m)	Pipe size	Tightening torque (N-m)	Pipe size	Tightening torque (N-m)	Pipe size	Tightening torque (N-m)		
P20/25/32/40	O.D.ø6.35 (1/4")	14 – 18	O.D.ø12.7 (1/2")	49 – 61	O.D.ø6.35 (1/4")	14 – 18	O.D.ø12.7 (1/2")	49 – 61	17	27
P50	O.D.ø6.35 (1/4")	34 – 42	O.D.ø12.7 (1/2")	68 – 82	O.D.ø9.52 (3/8")	34 – 42*	O.D.ø15.88 (5/8")	68 – 82*	22	29
P63/80	O.D.ø9.52 (3/8")	34 – 42	O.D.ø15.88 (5/8")	68 – 82	O.D.ø9.52 (3/8")	34 – 42	O.D.ø15.88 (5/8")	68 – 82	22	29
P100/125	O.D.ø9.52 (3/8")	34 – 42	O.D.ø15.88 (5/8")	100 – 120	O.D.ø9.52 (3/8")	34 – 42	O.D.ø19.05 (3/4")	100 – 120*	22	36

* Use the provided flare nut for the following pipes: Liquid pipe of P50, P100, P125, and gas pipe of P50.

6.2. Refrigerant pipe, drain pipe and filling port

[Fig. 6.2.1] (P.3)

- A** Refrigerant pipe (liquid pipe): HP
- B** Drain pipe
- C** Hanging bolt pitch
- D** Refrigerant pipe (gas pipe): LP
- E** Filling port
- F** Drain hole

6.3. Request for refrigerant piping connection

Description of parts to be used

No.	Work procedures	Detail of work	Item to be observed	Reference drawing
1	Mount the provided pipe insulation (1) on the liquid pipe of the refrigerant piping, and then mount the flare insulation (2) on the gas pipe.	"INNER" and "OUTER" are marked on the inside of the flare insulation. Mount the portion marked "INNER" near the unit body and the portion marked "OUTER" on the field piping side.	<ul style="list-style-type: none"> Using the flare insulation of a different model may result in condensation forming. Check the model name on the insulation and be sure to use the correct one. To prevent a gap from forming near the unit's side plate, be sure that the flare insulation firmly contacts the unit's side plate before mounting. Incorrectly mounting the "INNER" and "OUTER" sides of the insulation may result in condensation forming. 	<p>[Fig. 6.3.1] (P.3)</p> <p>[Fig. 6.3.2] (P.3)</p> <p>[Fig. 6.3.2] (P.3)</p>
2	Fixing of insulated pipe	<ul style="list-style-type: none"> Fasten the insulated pipe with the insulation tape. Firmly secure the insulation with the provided tie band (4) at the position indicated on the drawing. 	Seal the slit securely so that there are no openings. Be sure to mount the insulation so that the slit is on the top.	[Fig. 6.3.3] (P.3) (Note *3)
3	Fixing of flare insulation	<ul style="list-style-type: none"> Fasten the flare insulation with the provided tape (3). Fasten with the provided tie band (4) at the position indicated on the drawing. 	Seal the slit securely so that there are no openings. Be sure to mount the insulation so that the slit is on the top.	[Fig. 6.3.3] (P.3) (Note *4)

[Fig. 6.3.1] (P.3)

- | | |
|----------------------------------|-------------------------------|
| Ⓐ "0-0 gas" mark | Ⓑ "INNER" mark |
| Ⓒ "OUTER" mark | Ⓓ Flare insulation (2) |
| Ⓔ Refrigerant piping (gas) | Ⓕ Refrigerant piping (liquid) |
| Ⓖ Field refrigerant piping | Ⓗ Pipe insulation (1) |
| Ⓘ Insulation material | Ⓙ Flare |
| Ⓚ Pull in this direction. | Ⓛ Insulation material |
| Ⓜ Flare | Ⓝ There must be no gap. |
| Ⓞ Move to the original position. | |

[Fig. 6.3.2] (P.3)

(figure showing the flare insulation)

- | | |
|---------------------------------|-------------------------|
| Ⓐ Field refrigerant piping | Ⓑ There must be no gap. |
| Ⓒ Unit body plate | Ⓓ OUTER |
| Ⓔ INNER | Ⓕ Unit body |
| Ⓖ Provided flare insulation (2) | |

[Fig. 6.3.3] (P.3)

- | | |
|-------------------------|---------------------|
| Ⓐ Tape (3) | Ⓑ Fasten with tape. |
| Ⓒ Provided tie band (4) | |

Notes:

- *1 Insert the flare nut into the field refrigerant piping. Pull the insulation material back at the area where it will be flared, then return it to its original position after performing the flare work. Exposing copper piping may result in condensation forming. Be extremely careful when performing this operation.
- *2 There must be no gap.
- *3, *4 There must be no gap. Slit should be on the top.

7. Connecting refrigerant pipes and drain pipes

7.1. Refrigerant piping work

This piping work must be done in accordance with the installation manuals for both outdoor unit and BC controller (simultaneous cooling and heating series R2).

- Series R2 is designed to operate in a system that the refrigerant pipe from an outdoor unit is received by BC controller and branches at the BC controller to connect between indoor units.
- For constraints on pipe length and allowable difference of elevation, refer to the outdoor unit manual.
- The method of pipe connection is flare connection.

Cautions on refrigerant piping

- ▶ **Be sure to use non-oxidative brazing for brazing to ensure that no foreign matter or moisture enter into the pipe.**
- ▶ **Be sure to apply refrigerating machine oil over the flare connection seating surface and tighten the connection using a double spanner.**
- ▶ **Provide a metal brace to support the refrigerant pipe so that no load is imparted to the indoor unit end pipe. This metal brace should be provided 50 cm away from the indoor unit's flare connection.**

⚠ Warning:

When installing and moving the unit, do not charge it with refrigerant other than the refrigerant specified on the unit.

- Mixing of a different refrigerant, air, etc. may cause the refrigerant cycle to malfunction and result in severe damage.

⚠ Caution:

- **Use refrigerant piping made of phosphorus deoxidized copper and copper alloy seamless pipes and tubes. In addition, be sure that the inner and outer surfaces of the pipes are clean and free of hazardous sulphur, oxides, dust/dirt, shaving particles, oils, moisture, or any other contaminant.**
- **Never use existing refrigerant piping.**
 - The large amount of chlorine in conventional refrigerant and refrigerant oil in the existing piping will cause the new refrigerant to deteriorate.
- **Store the piping to be used during installation indoors and keep both ends of the piping sealed until just before brazing.**
 - If dust, dirt, or water gets into the refrigerant cycle, the oil will deteriorate and the compressor may fail.
- **Use Suniso 4GS or 3GS (small amount) refrigerant oil to coat the flare and flange connection part. (For models using R22)**
- **Use ester oil, ether oil or alkylbenzene (small amount) as the refrigerant oil to coat flares and flange connections. (For models using R410A or R407C)**
 - The refrigerant used in the unit is highly hygroscopic and mixes with water and will degrade the refrigerant oil.

7.2. Drain piping work

[Fig. 7.2.1] (P.4)

- A: 25 cm
B: 1.5 – 2 m
- | |
|-------------------------------------|
| Ⓐ Downward pitch of more than 1/100 |
| Ⓑ Insulating material |
| Ⓒ Metal brace |

[Fig. 7.2.2] (P.4)

- | |
|--|
| Ⓓ Indoor unit |
| Ⓔ Take as large as possible. About 10 cm |
| Ⓕ Collected pipes |

[Fig. 7.2.3] (P.4)

- C: 28 cm
D: 170 ± 5 mm
Ⓖ Drain hose (Accessory)

▶ Be sure to use the supplied drain hose (Accessory).

- | |
|--|
| Ⓗ Less than 300 mm |
| Ⓘ Hard vinyl chloride 90° elbow (field supply) |
| Ⓙ Hard vinyl chloride (VP-25) (field supply) |
| Ⓚ Tie band (small) (Accessory) |

▶ Connect each connection with vinyl chloride adhesive. But never use any adhesive over the indoor unit discharge port. Otherwise the drain-up mechanism cannot be serviced later. Also, the end connection may be eroded by resin and so cracked.

1. Ensure that the drain piping is downward (pitch of more than 1/100) to the outdoor (discharge) side. Do not provide any trap or irregularity on the way. (Ⓘ)
2. Ensure that any cross-wise drain piping is less than 20 m (excluding the difference of elevation). If the drain piping is long, provide metal braces to prevent it from waving. Never provide any air vent pipe. Otherwise drain may be ejected.
3. Use a hard vinyl chloride pipe VP-25 (with an external diameter of 32 mm) for drain piping.
4. Ensure that collected pipes are 10 cm lower than the unit body's drain port as shown in ②.
5. Do not provide any odor trap at the drain discharge port.
6. Put the end of the drain piping in a position where no odor is generated.
7. Do not put the end of the drain piping in any drain where ionic gases are generated.
8. The intake of the drain piping can be made 28 cm higher than the drain discharge port. If there are some obstacles under the ceiling, use elbows to make it at least height according to the site. (Ⓝ)

Note:

If the rise portion is long, there will be a lot of returned water in an operation stop, generating slime or odor during off-season. Ensure that the rise portion is at a minimum.

⚠ Caution:

Pipe the drain piping to ensure that it discharges drain, and insulate it to prevent dew condensation. A failure to the piping work may cause water leakage and so wet your property.

7.3. Confirming drain discharge

▶ Make sure that the drain-up mechanism operates normally for discharge and that there is no water leakage from the connections.

- Be sure to confirm the above in a period of heating operation.
- Be sure to confirm the above before ceiling work is done in the case of a new construction.

1. Plug the drain pump test connector (accessory) into the connector on the same side as the control box. For more details, see the information on the control box cover.
2. Remove the polyethylene plug on the same side as the indoor unit piping.
3. Fill water into the feed water pump using a feed water tank. In filling, be sure to put the end of the pump or tank in a drain pan. (If the insertion is incomplete, water may flow over the machine.)
4. Turn on the main power. The drain pump is forced to operate without any remote controller operation. Make sure using a transparent hose that drain is discharged.

5. After confirmation, turn off the main power, remove the connector, and insert the polyethylene plug into its original position.

[Fig. 7.3.1] (P.4)

- Ⓐ Insert the pump's end 2 to 4 cm.
- Ⓑ Remove the polyethylene plug.
- Ⓒ About 1000 cc
- Ⓓ Water
- Ⓔ Filling port

8. Electrical wiring

Precautions on electrical wiring

Warning:

Electrical work should be done by qualified electrical engineers in accordance with "Engineering Standards For Electrical Installation" and supplied installation manuals. Special circuits should also be used. If the power circuit lacks capacity or has an installation failure, it may cause a risk of electric shock or fire.

1. Be sure to take power from the special branch circuit.
2. Be sure to install an earth leakage breaker to the power.
3. Install the unit to prevent that any of the control circuit cables (remote controller, transmission cables) is brought in direct contact with the power cable outside the unit.
4. Ensure that there is no slack on all wire connections.
5. Some cables (power, remote controller, transmission cables) above the ceiling may be bitten by mice. Use as many metal pipes as possible to insert the cables into them for protection.

6. Never connect the power cable to leads for the transmission cables. Otherwise the cables would be broken.
7. Be sure to connect control cables to the indoor unit, remote controller, and the outdoor unit.
8. Put the unit to the ground on the outdoor unit side.
9. Select control cables from the conditions given in below.

Caution:

Be sure to put the unit to the ground on the outdoor unit side. Do not connect the earth cable to any gas pipe, water pipe, lightning rod, or telephone earth cable. Incomplete grounding may cause a risk of electric shock.

Types of control cables

1. Wiring transmission cables

- Types of transmission cables
Design wiring in accordance with the following table <Table 1>.
- Cable diameter
More than 1.25 mm²

<Table 1>

System configuration	For a single-refrigerant system		For a multi-refrigerant system
Transmission cable length	Less than 120 m		More than 120 m
Facility example (for noise judgment)	Residence or independent store without noise	Building, clinic, hospital or communications station without noise supposedly generated from inverter equipment, private power generator, high-frequency medical equipment, radio-used communications equipment and so on	Regardless of length
Types of transmission cables	VCTF, VCTFK, CVV, CVS, VVR, VVF, VCT or shielding wire CVVS or CPEVS		Shielding wire CVVS or CPEVS
Length	Less than 120 m		Less than 200 m

2. Remote controller cables

	MA remote controller	M-NET remote controller
Types of cables	2-core cable (unshielded)	Non-shielding wire for up to 10 m; the same specifications as "1." Wiring transmission cables for more than 10 m
Cable diameter	0.3 to 1.25 mm ²	0.3 to 1.25 mm ²
Length	Less than 200 m	Add any portion in excess of 10 m to within the longest allowable transmission cable length 200 m (Shielding portion is more than 1.25 mm ²)

8.1. Power supply wiring

- Power supply cords of appliances shall not be lighter than design 245 IEC 57 or 227 IEC 57.
- A switch with at least 3 mm contact separation in each pole shall be provided by the Air conditioner installation.

Power cable size: more than 1.5 mm²

[Fig. 8.1.1] (P.4)

- Ⓐ Switch 16 A (Breakers for Current Leakage)
- Ⓑ Switch 16 A (Breakers for Wiring or Main Switch)
- Ⓒ Indoor unit
- Ⓓ Total operating current be less than 16 A
- Ⓔ Pull box

[Selecting non-fuse breaker (NF) or earth leakage breaker (NV)]

To select NF or NV instead of a combination of Class B fuse with switch, use the following:

- In the case of Class B fuse rated 15 A or 20 A,
NF model name (MITSUBISHI): NF30-CS (15 A) (20 A)
NV model name (MITSUBISHI): NV30-CA (15 A) (20 A)
 Use an earth leakage breaker with a sensitivity of less than 30 mA 0.1 s.

Caution:

Do not use anything other than the correct capacity breaker and fuse. Using fuse, wire or copper wire with too large capacity may cause a risk of malfunction or fire.

8.2. Connecting remote controller, indoor and outdoor transmission cables

(Remote controller is optionally available.)

- Connect indoor unit TB5 and outdoor unit TB3. (Non-polarized 2-wire)
The "S" on indoor unit TB5 is a shielding wire connection. For specifications about the connecting cables, refer to the outdoor unit installation manual.
- Install a remote controller following the manual supplied with the remote controller.
- Connect the "1" and "2" on indoor unit TB15 to a MA remote controller. (Non-polarized 2-wire)
- Connect the "M1" and "M2" on indoor unit TB5 to a M-NET remote controller. (Non-polarized 2-wire)
- Connect the remote controller's transmission cable within 10 m using a 0.75 mm² core cable. If the distance is more than 10 m, use a 1.25 mm² junction cable.

[Fig. 8.2.1] (P.4) MA Remote controller

[Fig. 8.2.2] (P.4) M-NET Remote controller

- Ⓐ Terminal block for indoor transmission cable
- Ⓑ Terminal block for outdoor transmission cable
- Ⓒ Remote controller
- DC 9 to 13 V between 1 and 2 (MA remote controller)
- DC 24 to 30 V between M1 and M2 (M-NET remote controller)

[Fig. 8.2.3] / [Fig. 8.2.4] (P.4) MA Remote controller

[Fig. 8.2.5] / [Fig. 8.2.6] (P.4) M-NET Remote controller

- Ⓐ Non-polarized
- Ⓑ Upper level (TB15)
- Ⓒ MA Remote Controller
- Ⓓ Lower level (TB5)
- Ⓔ M-NET Remote Controller

- The MA remote controller and the M-NET remote controller cannot be used at the same time or interchangeably.

Note:

Ensure that the wiring is not pinched when fitting the terminal box cover. Pinching the wiring may cut it.

⚠ Caution:

Install wiring so that it is not tight and under tension. Wiring under tension may break, or overheat and burn.

- Fix power source wiring to control box by using buffer bushing for tensile force. (PG connection or the like.) Connect transmission wiring to transmission terminal block through the knockout hole of control box using ordinary bushing.
- After wiring is complete, make sure again that there is no slack on the connections, and attach the cover onto the control box in the reverse order removal.

⚠ Caution:

Wire the power supply so that no tension is imparted. Otherwise disconnection, heating or fire result.

[Fig. 8.2.7] (P.4)

<Constraints on transmission cable>

- Ⓒ Outdoor unit
- Ⓓ Earth
- Ⓐ BC controller
- Ⓔ Indoor unit
- Ⓒ Remote controller
- Ⓓ Non-polarized 2-wire

Notes:

- *1 Put the transmission cable earth via the outdoor unit's earth terminal ⊕ to the ground.
- *2 If the remote controller cable exceeds 10 m, use a 1.25 mm² cable over the exceeded portion, and add that exceeded portion to within 200 m.
- *3 The BC controller is required only for simultaneous cooling and heating series R2.

8.3. Connecting electrical connections

(Be sure to prevent terminal screws from loosening.)

1. Remove 2 screws which secures the terminal bed box cover using a screwdriver. (1)

[Fig. 8.3.1] / [Fig. 8.3.2] (P.5)

- Ⓐ Side frame
- Ⓑ Cover
- Ⓒ Screw (2 places)

2. As shown at ②, wire the power supply, transmission cable and remote controller. There is no need to remove the terminal bed box.

[Fig. 8.3.3] / [Fig. 8.3.4] (P.5)

<Viewed from bottom of the terminal bed box>

- Ⓓ Terminal bed for transmission cable
- Ⓔ Transmission cable
(To terminal bed for M-NET remote controller, indoor unit and BC controller)
- Ⓕ To single-phase power supply
- Ⓖ Terminal bed for power supply
- Ⓗ To terminal bed for outdoor transmission cable
(Use shielding earth cable ⊕ on outdoor unit side.)

- Fix power source wiring to terminal bed box by using buffer bushing for tensile force. (PG connection or the like.) Connect transmission wiring to transmission terminal bed through the knockout hole of terminal bed box using ordinary bushing.
- 3. After wiring is complete, make sure again that there is no slack on the connections, and attach the cover onto the terminal bed box in the reverse order of removal.

⚠ Caution:

Wire the power supply so that no tension is imparted. Otherwise disconnection, heating or fire may result.

8.4. Setting addresses

(Be sure to operate with the main power turned OFF.)

[Fig. 8.4.1] / [Fig. 8.4.2] (P.5)

<Address Switch>
<Address board>

- There are two types of rotary switch setting available: setting addresses 1 to 9 and over 10, and setting branch numbers.
 - ① How to set addresses
Example: If Address is "3", remain SW12 (for over 10) at "0", and match SW11 (for 1 to 9) with "3".
 - ② How to set branch numbers SW14 (Series R2 only)
Match the indoor unit's refrigerant pipe with the BC controller's end connection number. Remain other than series R2 at "0".
- The rotary switches are all set to "0" when shipped from the factory. These switches can be used to set unit addresses and branch numbers at will.
- The determination of indoor unit addresses varies with the system at site. Set them referring to technical data.

Note:

Please set the switch SW5 according to the power supply voltage.

200-100	volts	SW5	125	volts	SW5
	220	ON		220	ON
	230	ON		230	OFF
	240	OFF		240	OFF

8.5. Sensing room temperature with the built-in sensor in a remote controller

If you want to sense room temperature with the built-in sensor in a remote controller, set SW1-1 on the control board to "ON". The setting of SW1-7 and SW1-8 as necessary also makes it possible to adjust the air flow at a time when the heating thermometer is OFF.

This product is designed and intended for use in the residential, commercial and light-industrial environment.

The product at hand is based on the following EU regulations:

- Low Voltage Directive 73/23/EEC
- Electromagnetic Compatibility Directive 89/336/EEC

Please be sure to put the contact address/telephone number on this manual before handing it to the customer.