

February 2009

**No. OCH442  
REVISED EDITION-A**

# TECHNICAL & SERVICE MANUAL

## Series PKFY Wall Mounted R410A / R407C / R22

**Indoor unit  
[Model names]**

PKFY-P32VHM-E

PKFY-P40VHM-E

PKFY-P50VHM-E

**[Service Ref.]**

**PKFY-P32VHM-E**  
**PKFY-P32VHM-ER1**  
**PKFY-P40VHM-E**  
**PKFY-P40VHM-ER1**  
**PKFY-P50VHM-E**  
**PKFY-P50VHM-ER1**

**Revision:**

- PKFY-P32/40/50VHM-ER1 are added in REVISED EDITION-A.
- Some descriptions have been modified.

- Please void OCH442.

**Note:**

- This manual describes only service data of the indoor units.
- RoHS compliant products have <G> mark on the spec name plate.

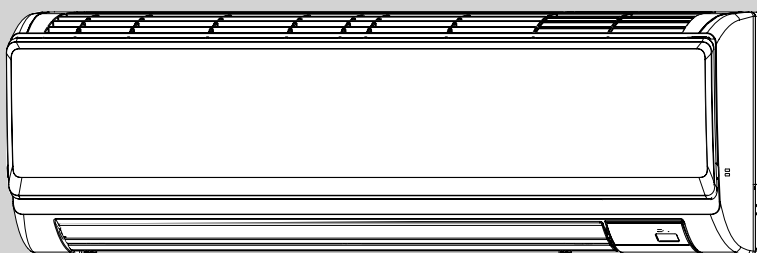

INDOOR UNIT

## CONTENTS

1. TECHNICAL CHANGES.....	2
2. SAFETY PRECAUTION.....	2
3. PART NAMES AND FUNCTIONS .....	6
4. SPECIFICATION .....	8
5. OUTLINES AND DIMENSIONS.....	11
6. WIRING DIAGRAM .....	12
7. REFRIGERANT SYSTEM DIAGRAM.....	13
8. TROUBLESHOOTING .....	13
9. DISASSEMBLY PROCEDURE .....	21

**PARTS CATALOG (OCB442)**

# 1

## TECHNICAL CHANGES

PKFY-P32VHM-E → PKFY-P32VHM-ER1  
PKFY-P40VHM-E → PKFY-P40VHM-ER1  
PKFY-P50VHM-E → PKFY-P50VHM-ER1

1. INDOOR CONTROLLER BOARD (I.B.) has been changed. (S/W version up)
2. Fan speed has been changed. (4 speed → 3 speed)
3. Heat exchanger has been changed.

PKFY-P32VHM-E  
PKFY-P40VHM-E  
PKFY-P50VHM-E

Service parts of room temp. thermistor (TH21) has been changed. (T7W E05 202 → R01 N20 202)  
(The position to be attached has been changed. Band/PVC tube have been added.)

# 2

## SAFETY PRECAUTION

### CAUTIONS RELATED TO NEW REFRIGERANT

#### Cautions for units utilizing refrigerant R407C

##### **Do not use the existing refrigerant piping.**

The old refrigerant and lubricant in the existing piping contain a large amount of chlorine which may cause the lubricant deterioration of the new unit.

##### **Use liquid refrigerant to charge the system.**

If gas refrigerant is used to seal the system, the composition of the refrigerant in the cylinder will change and performance may drop.

##### **Use "low residual oil piping"**

If there is a large amount of residual oil (hydraulic oil, etc.) inside the piping and joints, deterioration of the lubricant will result.

##### **Do not use a refrigerant other than R407C.**

If another refrigerant (R22, etc.) is used, the chlorine in the refrigerant may cause the lubricant deterioration.

##### **Store the piping to be used indoors during installation and both ends sealed until just before brazing. (Store elbows and other joints in a plastic bag.)**

If dust, dirt, or water enters the refrigerant cycle, deterioration of the oil and compressor trouble may result.

##### **Use a vacuum pump with a reverse flow check valve.**

The vacuum pump oil may flow back into the refrigerant cycle and cause the lubricant deterioration.

##### **Use ESTR, ETHER or HAB as the lubricant to coat flares and flange connection parts.**

If large amount of mineral oil enters, that can cause deterioration of refrigerant oil etc.

##### **Ventilate the room if refrigerant leaks during operation. If refrigerant comes into contact with a flame, poisonous gases will be released.**

### [1] Cautions for service

- After recovering all the refrigerant in the unit, proceed to working.
- Do not release refrigerant in the air.
- After completing the repair service, recharge the cycle with the specified amount of liquid refrigerant.

## [2] Refrigerant recharging

### (1) Refrigerant recharging process

#### ① Direct charging from the cylinder.

- R407C cylinder available on the market has a syphon pipe.
  - Leave the syphon pipe cylinder standing and recharge it.
- (By liquid refrigerant)

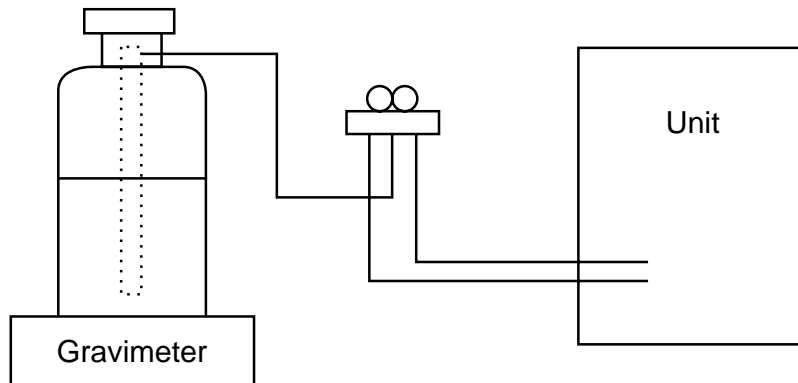

### (2) Recharge in refrigerant leakage case

- After recovering the all refrigerant in the unit, proceed to working.
- Do not release the refrigerant in the air.
- After completing the repair service, recharge the cycle with the specified amount of liquid refrigerant.

## [3] Service tools

Use the below service tools as exclusive tools for R407C refrigerant.

No.	Tool name	Specifications
①	Gauge manifold	·Only for R407C
		·Use the existing fitting SPECIFICATIONS. (UNF7/16)
		·Use high-tension side pressure of 3.43MPa·G or over.
②	Charge hose	·Only for R407C
		·Use pressure performance of 5.10MPa·G or over.
③	Electronic scale	_____
④	Gas leak detector	·Use the detector for R134a or R407C.
⑤	Adapter for reverse flow check	·Attach to vacuum pump.
⑥	Refrigerant charge base	_____
⑦	Refrigerant cylinder	·For R407C
		·Top of cylinder (Brown) ·Cylinder with syphon
⑧	Refrigerant recovery equipment	_____

## Cautions for units utilizing refrigerant R410A

### Do not use the existing refrigerant piping.

The old refrigerant and lubricant in the existing piping contains a large amount of chlorine which may cause the lubricant deterioration of the new unit.

### Use "low residual oil piping"

If there is a large amount of residual oil (hydraulic oil, etc.) inside the piping and joints, deterioration of the lubricant will result.

### Store the piping to be used indoors during installation and both ends of the piping sealed until just before brazing. (Leave elbow joints, etc. in their packaging.)

If dirt, dust or moisture enters into refrigerant cycle, that can cause deterioration of refrigerant oil or malfunction of compressor.

### Use ester oil, ether oil or alkylbenzene oil (small amount) as the refrigerant oil applied to flares and flange connections.

If large amount of mineral oil enters, that can cause deterioration of refrigerant oil etc.

### Charge refrigerant from liquid phase of gas cylinder.

If the refrigerant is charged from gas phase, composition change may occur in refrigerant and the efficiency will be lowered.

### Do not use refrigerant other than R410A.

If other refrigerant (R22 etc.) is used, chlorine in refrigerant can cause deterioration of refrigerant oil etc.

### Use a vacuum pump with a reverse flow check valve.

Vacuum pump oil may flow back into refrigerant cycle and that can cause deterioration of refrigerant oil etc.

### Use the following tools specifically designed for use with R410A refrigerant.

The following tools are necessary to use R410A refrigerant.

Tools for R410A	
Gauge manifold	Flare tool
Charge hose	Size adjustment gauge
Gas leak detector	Vacuum pump adaptor
Torque wrench	Electronic refrigerant charging scale

### Handle tools with care.

If dirt, dust or moisture enters into refrigerant cycle, that can cause deterioration of refrigerant oil or malfunction of compressor.

### Do not use a charging cylinder.

If a charging cylinder is used, the composition of refrigerant will change and the efficiency will be lowered.

### Ventilate the room if refrigerant leaks during operation. If refrigerant comes into contact with a flame, poisonous gases will be released.

### [1] Cautions for service

- (1) Perform service after recovering the refrigerant left in unit completely.
- (2) Do not release refrigerant in the air.
- (3) After completing service, charge the cycle with specified amount of refrigerant.
- (4) When performing service, install a filter drier simultaneously.  
Be sure to use a filter drier for new refrigerant.

### [2] Additional refrigerant charge

#### When charging directly from cylinder

- Check that cylinder for R410A on the market is syphon type.
- Charging should be performed with the cylinder of syphon stood vertically. (Refrigerant is charged from liquid phase.)

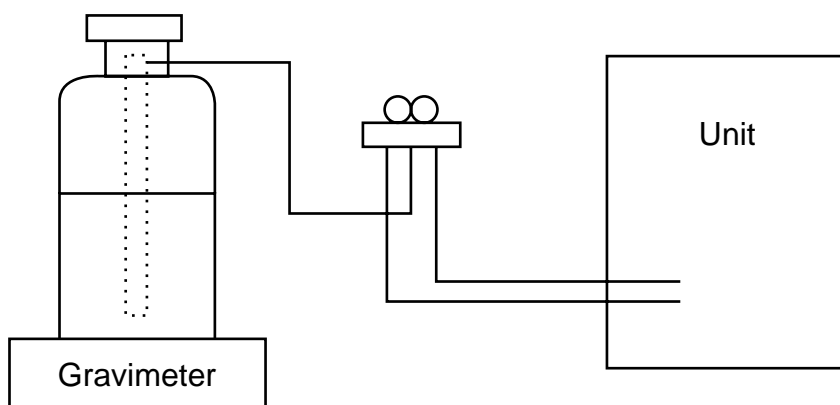

### [3] Service tools

Use the below service tools as exclusive tools for R410A refrigerant.

No.	Tool name	Specifications
①	Gauge manifold	·Only for R410A
		·Use the existing fitting specifications. (UNF1/2)
		·Use high-tension side pressure of 5.3MPa-G or over.
②	Charge hose	·Only for R410A
		·Use pressure performance of 5.09MPa-G or over.
③	Electronic scale	—
④	Gas leak detector	·Use the detector for R134a, R407C or R410A.
⑤	Adaptor for reverse flow check	·Attach to vacuum pump.
⑥	Refrigerant charge base	—
⑦	Refrigerant cylinder	·Only for R410A
		·Top of cylinder (Pink) ·Cylinder with syphon
⑧	Refrigerant recovery equipment	—

● Indoor unit

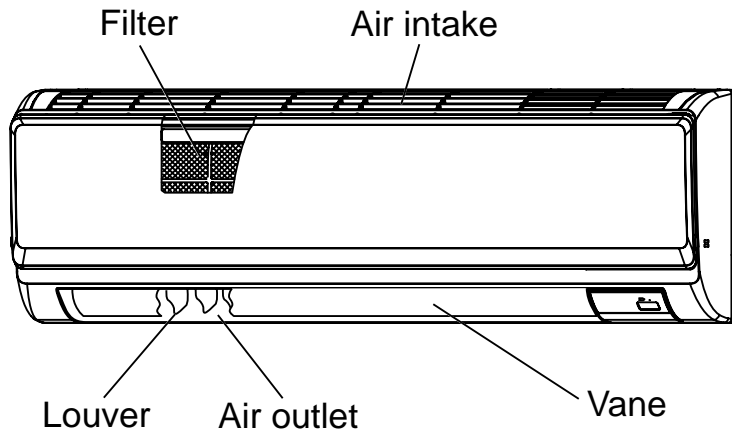

● Wireless remote controller

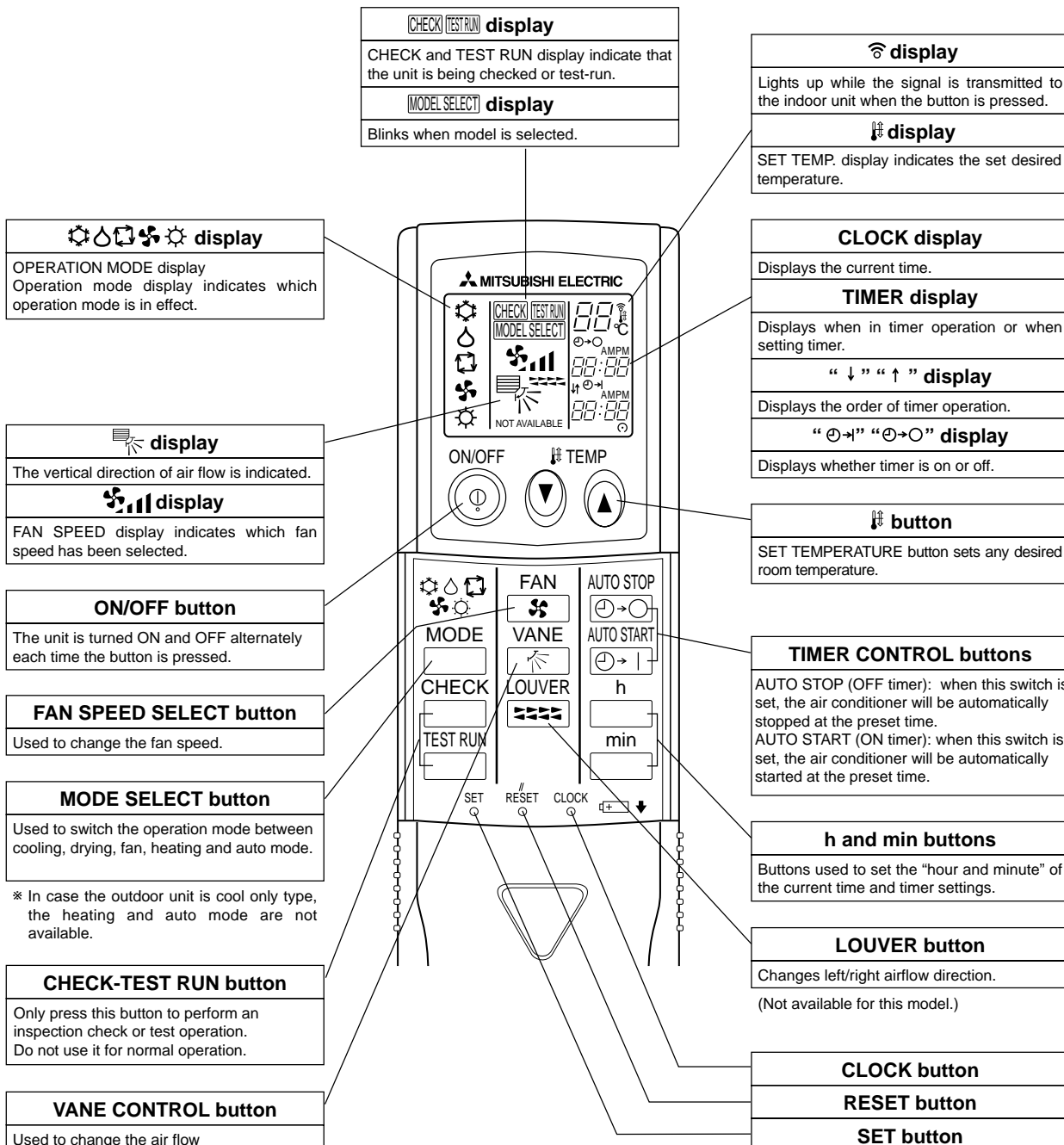

## • Wired remote controller

### Display Section

For purposes of this explanation, all parts of the display are shown as lit. During actual operation, only the relevant items will be lit.

**Identifies the current operation**  
Shows the operating mode, etc.  
\*Multilanguage display is available.

**“Centrally Controlled” indicator**  
Indicates that operation from the remote controller has been prohibited by a master controller.

**“Timer is Off” indicator**  
Indicates that the timer is off.

**Temperature Setting**  
Shows the target temperature.

**Day-of-Week**  
Shows the current day of the week.

**Time/Timer Display**  
Shows the current time, unless the simple or Auto Off timer is set.  
If the simple or Auto Off timer is set, the time to be switched off is shown.

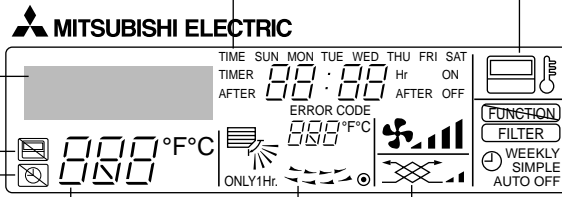

**Up/Down Air Direction indicator**  
The indicator \ shows the direction of the outcoming airflow.

**“One Hour Only” indicator**  
Displayed if the airflow is set to Low or downward during COOL or DRY mode. (Operation varies according to model.)  
The indicator goes off in one hour, at which time the airflow direction also changes.

**Room Temperature display**  
Shows the room temperature. The room temperature display range is 8–39°C .  
The display blinks if the temperature is less than 8°C or 39°C or more.

**Louver display**  
Indicates the action of the swing louver. Does not appear if the louver is not running.

**(Power On indicator)**  
Indicates that the power is on.

**“Sensor” indication**  
Displayed when the remote controller sensor is used.

**“Locked” indicator**  
Indicates that remote controller buttons have been locked.

**“Clean The Filter” indicator**  
To be displayed on when it is time to clean the filter.

**Timer indicators**  
The indicator comes on if the corresponding timer is set.

**Fan Speed indicator**  
Shows the selected fan speed.

**Ventilation indicator**  
Appears when the unit is running in Ventilation mode.

### Operation Section

Temperature setting buttons

- ▽ Down
- △ Up

Timer Menu button (Monitor/Set button)

Mode button (Return button)

Set Time buttons

- ▽ Back
- △ Ahead

Timer On/Off button (Set Day button)

ON/OFF button

Fan Speed button

Filter button (<Enter> button)

Test Run button

Check button (Clear button)

Airflow Up/Down button

Louver button (▽ Operation button)

▽ To return operation number

Ventilation button (△ Operation button)

△ To go to next operation number

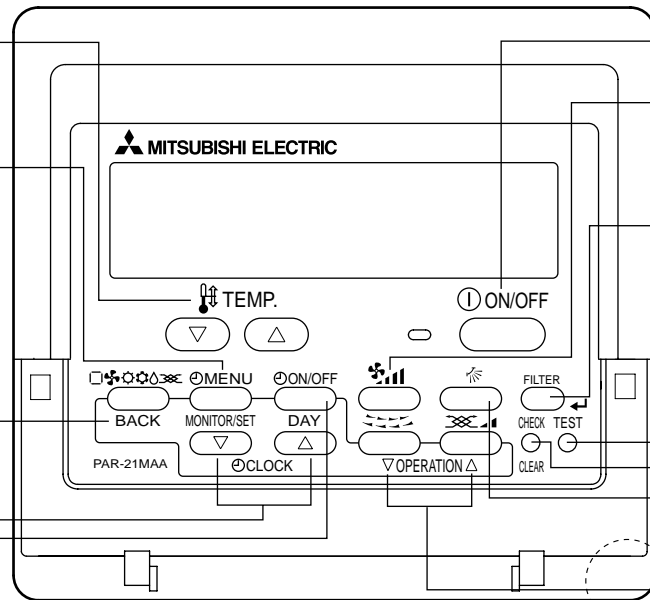
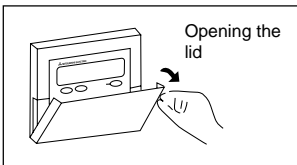

Built-in temperature sensor

#### Note:

- “PLEASE WAIT” message  
This message is displayed for approximately 3 minutes when power is supplied to the indoor unit or when the unit is recovering from a power failure.
- “NOT AVAILABLE” message  
This message is displayed if an invalid button is pressed (to operate a function that the indoor unit does not have).  
If a single remote controller is used to operate multiple indoor units simultaneously that are different types, this message will not be displayed as far as any of the indoor units is equipped with the function.

## 4-1. Specifications

Service Ref.			PKFY-P32VHM-E	PKFY-P40VHM-E	PKFY-P50VHM-E	
Power source			1-phase 220-240V 50Hz, 1-phase 220V 60Hz			
Cooling capacity (Nominal)	*1	kW	3.6	4.5	5.6	
	*1	kcal/h	3,100	3,900	4,800	
	*1	Btu/h	12,300	15,400	19,100	
	*2	kcal/h	3,150	4,000	5,000	
		Power input	kW	0.03	0.03	0.03
		Current input	A	0.30	0.30	
Heating capacity (Nominal)	*3	kW	4.0	5.0	6.3	
	*3	kcal/h	3,400	4,300	5,400	
	*3	Btu/h	13,600	17,100	21,500	
		Power input	kW	0.03	0.03	0.03
			Current input	A	0.30	0.30
External finish			Plastic, MUNSELL (1.OY 9.2/0.2)			
External dimension H x W x D		mm	295 x 898 x 249			
		in.	11-5/8" x 35-3/8" x 9-13/16"			
Net weight		kg (lb)	13 (29)			
Heat exchanger			Cross fin (Aluminum fin and copper tube)			
Fan	Type x Quantity		Line flow fan x 1			
	External static press.	Pa	0			
		mmH <sub>2</sub> O	0			
	Motor type		DC motor			
	Motor output		kW			
			0.030			
	Driving mechanism		Direct-drive			
Airflow rate (Low-Mid2-Mid1-High)	m <sup>3</sup> /min		8 - 9.5 - 10.5 - 11.5		9 - 10 - 11 - 12	
	L/s		133 - 158 - 175 - 192		150 - 167 - 183 - 200	
	cfm		283 - 335 - 371 - 406		318 - 353 - 388 - 424	
Noise level (Low-Mid2-Mid1-High) (measured in anechoic room)		dB <A>	33 - 36 - 38 - 41		34 - 37 - 40 - 43	
Insulation material			Polyethylene sheet			
Air filter			PP honeycomb			
Protection device			Fuse			
Refrigerant control device			LEV			
Connectable outdoor unit			R410A, R407C, R22 CITY MULTI			
Diameter of refrigerant pipe	Liquid (R410A) (R22, R407C)	mm (in.)	ø6.35 (ø1/4") Flare	ø6.35 (ø1/4") Flare	ø6.35 (ø1/4") Flare	
	Gas (R410A) (R22, R407C)	mm (in.)	ø12.7 (ø1/2") Flare	ø12.7 (ø1/2") Flare	ø12.7 (ø1/2") Flare	
			ø12.7 (ø1/2") Flare	ø12.7 (ø1/2") Flare	ø15.88 (ø5/8") Flare	
Field drain pipe size		mm (in.)	I.D. 16mm (5/8")			
Standard attachment	Document		Installation Manual, Instruction Book			
	Accessory		—	—	Flare nut 3/8F, 5/8F	
Remarks		Optional parts				
Installation		Details on foundation work, insulation work, electrical wiring, power source switch, and other items shall be referred to the Installation Manual.				
<b>Note :</b>		*1 Nominal cooling conditions	*2 Nominal cooling conditions	*3 Nominal heating conditions	Unit converter	
Indoor :		27°CDB/19°CWB (81°FDB/66°FWB)	27°CDB/19.5°CWB (81°FDB/67°FWB)	20°CDB (68°FDB)	kcal/h = kW x 860	
Outdoor :		35°CDB (95°FDB)	35°CDB (95°FDB)	7°CDB/6°CWB (45°FDB/43°FWB)	Btu/h = kW x 3,412	
Pipe length :		7.5 m (24-9/16 ft)	5 m (16-3/8 ft)	7.5 m (24-9/16 ft)	cfm = m <sup>3</sup> /min x 35.31	
Level difference :		0 m (0 ft)	0 m (0 ft)	0 m (0 ft)	lb = kg/0.4536	
* Nominal conditions *1, *3 are subject to JIS B8615-1.					*Above specification data is subject to rounding variation.	
* Due to continuing improvement, above specification may be subject to change without notice.						





Service Ref.		PKFY-P32VHM-ER1	PKFY-P40VHM-ER1	PKFY-P50VHM-ER1		
Power source		1-phase 220-240V 50Hz, 1-phase 220V 60Hz				
Cooling capacity (Nominal)	*1	kW	3.6	4.5	5.6	
	*1	kcal/h	3,100	3,900	4,800	
	*1	Btu/h	12,300	15,400	19,100	
	*2	kcal/h	3,150	4,000	5,000	
		Power input	*4 kW	0.04	0.04	0.04
	Current input	*4 A	0.40	0.40	0.40	
Heating capacity (Nominal )	*3	kW	4.0	5.0	6.3	
	*3	kcal/h	3,400	4,300	5,400	
	*3	Btu/h	13,600	17,100	21,500	
		Power input	kW	0.03	0.03	0.03
		Current input	A	0.30	0.30	0.30
External finish		Plastic, MUNSELL (1.0Y 9.2/0.2)				
External dimension H x W x D		mm	295 x 898 x 249			
		in.	11-5/8" x 35-3/8" x 9-13/16"			
Net weight		kg (lb)	13 (29)			
Heat exchanger		Cross fin (Aluminum fin and copper tube)				
Fan	Type x Quantity		Line flow fan x 1			
	External static press.	Pa	0			
		mmH <sub>2</sub> O	0			
	Motor type		DC motor			
	Motor output	kW	0.030			
	Driving mechanism		Direct-drive			
	Airflow rate (Low-Mid-High)	m <sup>3</sup> /min	9 - 10 - 11	9 - 10.5 - 11.5	9 - 10.5 - 12	
L/s		150 - 167 - 183	150 - 175 - 192	150 - 175 - 200		
cfm		318 - 353 - 388	318 - 371 - 406	318 - 371 - 424		
Noise level (Low-Mid-High) (measured in anechoic room)		dB <A>	34 - 37 - 41	34 - 38 - 41	34 - 39 - 43	
Insulation material		Polyethylene sheet				
Air filter		PP honeycomb				
Protection device		Fuse				
Refrigerant control device		LEV				
Connectable outdoor unit		R410A, R407C, R22 CITY MULTI				
Diameter of refrigerant pipe	Liquid (R410A) (R22, R407C)	mm (in.)	ø6.35 (ø1/4") Flare	ø6.35 (ø1/4") Flare	ø6.35 (ø1/4") Flare	
			ø6.35 (ø1/4") Flare	ø6.35 (ø1/4") Flare	ø9.52 (ø3/8") Flare *5	
	Gas (R410A) (R22, R407C)	mm (in.)	ø12.7 (ø1/2") Flare	ø12.7 (ø1/2") Flare	ø12.7 (ø1/2") Flare	
			ø12.7 (ø1/2") Flare	ø12.7 (ø1/2") Flare	ø15.88 (ø5/8") Flare *5	
Field drain pipe size		mm (in.)	I.D. 16mm (5/8")			
Standard attachment	Document		Installation Manual, Instruction Book			
	Accessory		—			
Remarks	Optional parts		Drain pump kit PAC-SH75DM-E			
	Installation		Details on foundation work, insulation work, electrical wiring, power source switch, and other items shall be referred to the Installation Manual.			
<b>Note :</b>	*1 Nominal cooling conditions		*2 Nominal cooling conditions		Unit converter kcal/h = kW x 860 Btu/h = kW x 3,412 cfm = m <sup>3</sup> /min x 35.31 lb = kg/0.4536	
	Indoor : 27°CDB/19°CWB (81°FDB/66°FWB)		27°CDB/19.5°CWB (81°FDB/67°FWB)			
	Outdoor : 35°CDB (95°FDB)		35°CDB (95°FDB)			
	Pipe length : 7.5 m (24-9/16 ft)		5 m (16-3/8 ft)			
Level difference : 0 m (0 ft)		0 m (0 ft)				
*4 Electrical characteristics of cooling are included optional drain-pump.		*5 Connect the joint (purchased locally) for R407C/R22.		*Above specification data is subject to rounding variation.		
* Nominal conditions *1, *3 are subject to JIS B8615-1.						
* Due to continuing improvement, above specification may be subject to change without notice.						

## 4-2. Electrical parts specifications

Service Ref. Parts name	Symbol	PKFY-P32VHM-E PKFY-P32VHM-ER1	PKFY-P40VHM-E PKFY-P40VHM-ER1	PKFY-P50VHM-E PKFY-P50VHM-ER1
Room temperature thermistor	TH21	Resistance 0°C/15kΩ, 10°C/9.6kΩ, 20°C/6.3kΩ, 25°C/5.4kΩ, 30°C/4.3kΩ, 40°C/3.0kΩ		
Liquid pipe thermistor	TH22	Resistance 0°C/15kΩ, 10°C/9.6kΩ, 20°C/6.3kΩ, 25°C/5.4kΩ, 30°C/4.3kΩ, 40°C/3.0kΩ		
Gas pipe thermistor	TH23 TH24	Resistance 0°C/15kΩ, 10°C/9.6kΩ, 20°C/6.3kΩ, 25°C/5.4kΩ, 30°C/4.3kΩ, 40°C/3.0kΩ		
Fuse (Indoor controller board)	FUSE	250V 3.15A		
Fan motor	MF	8-Pole Output 30W / RCOJ30-CK		
Vane motor (with limit switch)	MV	MSFBC20 DC12V		
Linear expansion valve	LEV	DC12V Stepping motor drive Port φ3.2 (0~2000pulse)		
Power supply terminal block	TB2	(L, N, ⊕) 250V 20A		
Transmission terminal block	TB5	(M1, M2, S) 250V 20A		
MA remote controller terminal block	TB15	(1, 2) 250V 10A		

## 4-3. Sound levels

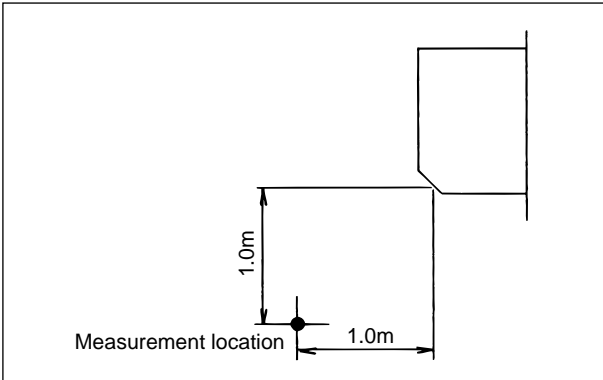

Sound level at anechoic room : Low-(Middle2-Middle1)-High

Service Ref.	Sound level dB (A)
PKFY-P32VHM-E	33-36-38-41
PKFY-P40VHM-E	34-38-41
PKFY-P50VHM-E	34-37-40-43

Sound level at anechoic room : Low-Middle-High

Service Ref.	Sound level dB (A)
PKFY-P32VHM-ER1	34-37-41
PKFY-P40VHM-ER1	34-38-41
PKFY-P50VHM-ER1	34-39-43

\* Measured in anechoic room.

## 4-4. NC curves

### PKFY-P32, 40VHM-E

External static pressure : 0Pa

Power source : 220,230,240V, 50Hz / 220V, 60Hz

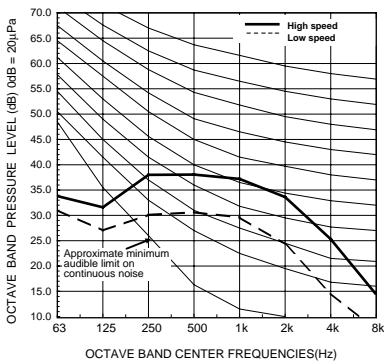

### PKFY-P32, 40VHM-ER1

External static pressure : 0Pa

Power source : 220,230,240V, 50Hz / 220V, 60Hz

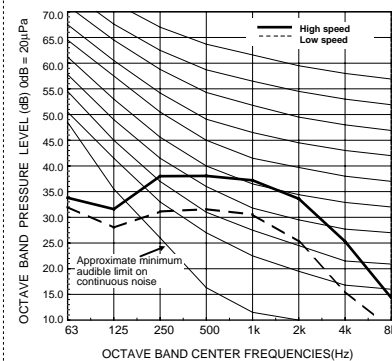

### PKFY-P50VHM-E PKFY-P50VHM-ER1

External static pressure : 0Pa

Power source : 220,230,240V, 50Hz / 220V, 60Hz

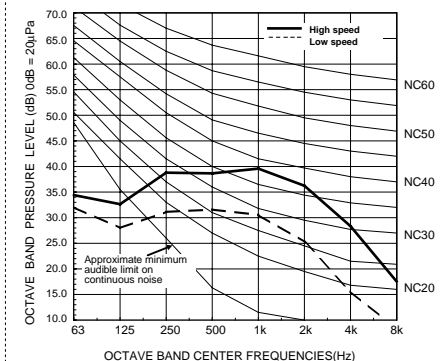

PKFY-P32, 40, 50VHM-E  
PKFY-P32, 40, 50VHM-ER1

Unit : mm

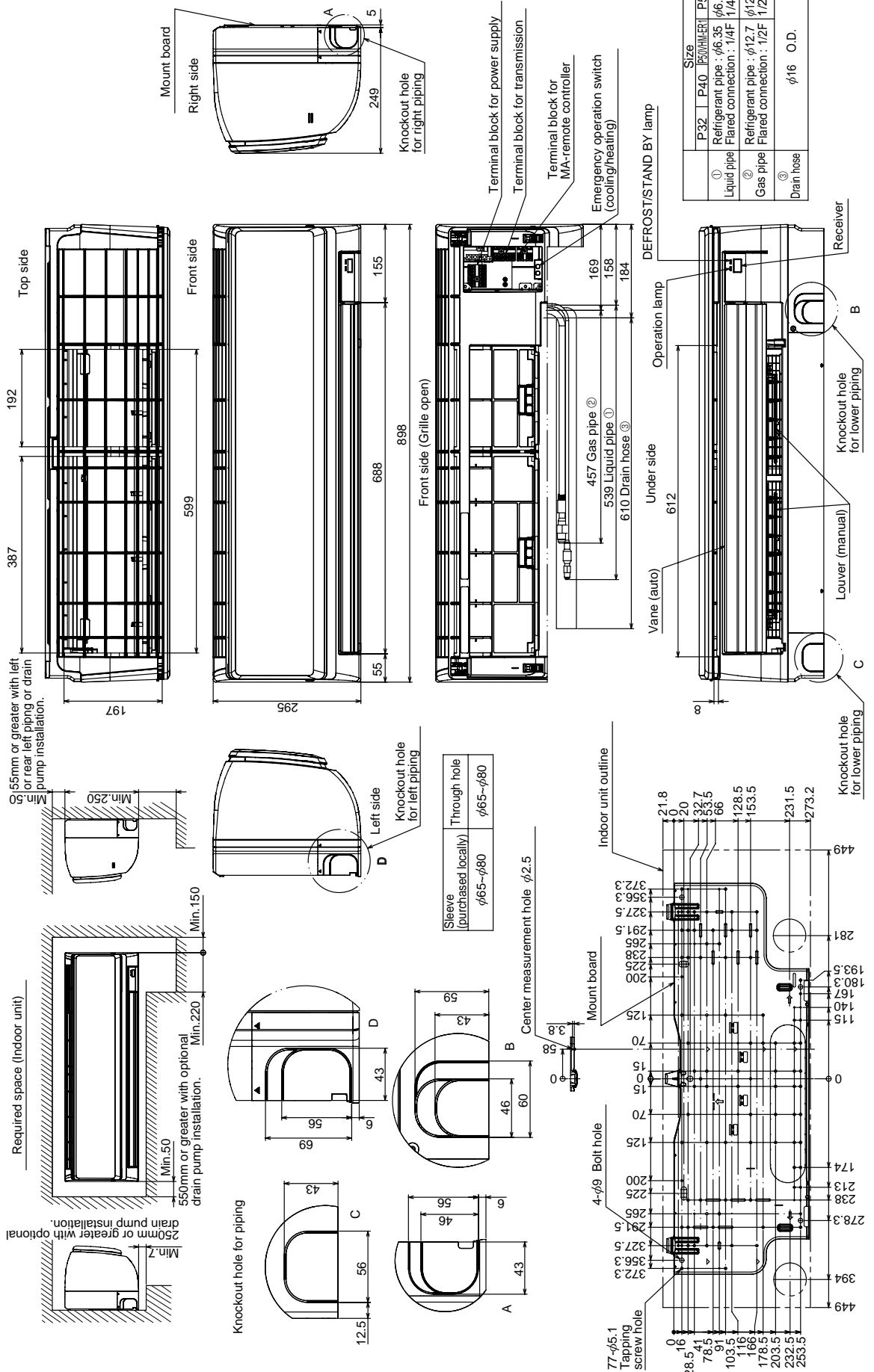

PKFY-P32, 40, 50VHM-E  
PKFY-P32, 40, 50VHM-ER1

SYMBOL	NAME	SYMBOL	NAME
I.B	INDOOR CONTROLLER BOARD	TH21	THERMISTOR ROOM TEMP. DETECTION (0°C/15kΩ, 25°C/5.4kΩ)
CN32	CONNECTOR REMOTE SWITCH	TH22	PIPE TEMP. DETECTION / LIQUID (0°C/15kΩ, 25°C/5.4kΩ)
CN51	CENTRALLY CONTROL	TH23	PIPE TEMP. DETECTION / GAS1 (0°C/15kΩ, 25°C/5.4kΩ)
CN52	REMOTE INDICATION	TH24	PIPE TEMP. DETECTION / GAS2 (0°C/15kΩ, 25°C/5.4kΩ)
BZ	BUZZER	A.B	ADDRESS BOARD
DSA	SURGE ABSORBER	SWA	SWITCH FAN SPEED SELECTOR
FUSE	FUSE (T3.15AL 250V)	SW1	MODE SELECTION
LED1	POWER SUPPLY (I.B)	SW11	ADDRESS SETTING 1s DIGIT
LED2	POWER SUPPLY (I.B)	SW12	ADDRESS SETTING 10ths DIGIT
SW2	SWITCH CAPACITY CODE	SW14	BRANCH No.
SW3	MODE SELECTION	S.B	SWITCH BOARD
SW4	MODEL SELECTOR	SWE1	EMERGENCY OPERATION(HEAT)
SWE	DRAIN PUMP (TEST MODE)	SWE2	EMERGENCY OPERATION(COOL)
X1	AUX.RELAY DRAIN PUMP (OPTION)	W.B	PCB FOR WIRELESS REMOTE CONTROLLER
MOV 01.02	VARISTOR	LED1	LED(OPERATION INDICATOR: GREEN)
LEV	LINEAR EXPANSION VALVE	LED2	LED(OPERATION FOR HEATING : ORANGE)
MF	FAN MOTOR	RU	RECEIVING UNIT
MV	VANE MOTOR	DP	DRAIN PUMP (OPTION)
TB2	TERMINAL POWER SUPPLY	FS	DRAIN FLOAT SWITCH (OPTION)
TB5	BLOCK TRANSMISSION		
TB15	BLOCK MA-REMOTE CONTROLLER		

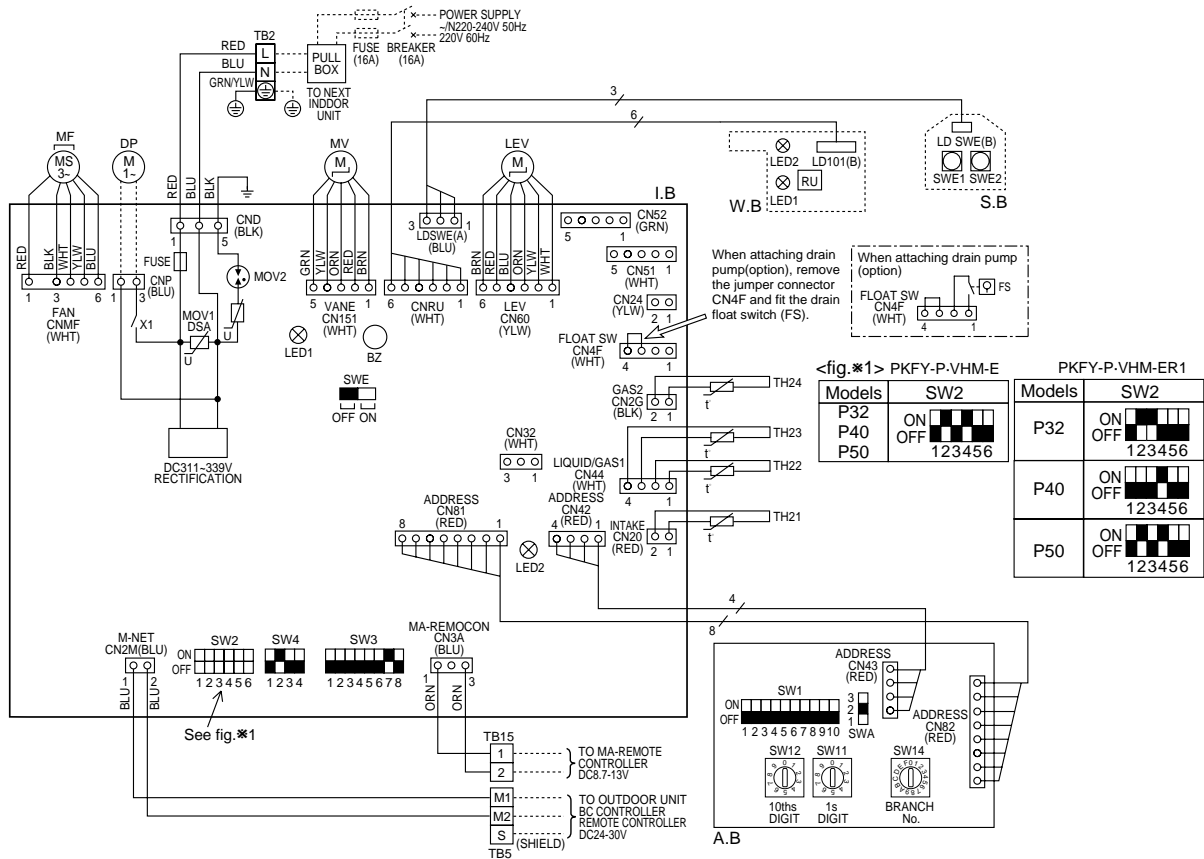

## LED on indoor board for service

Mark	Meaning	Function
LED1	Main power supply	Main power supply (Indoor unit: 220-240V) Power on → lamp is lit
LED2	Power supply for MA-Remote controller	Power supply for MA-Remote controller on → lamp is lit

## NOTES:

- At servicing for outdoor unit, always follow the wiring diagram of outdoor unit.
- In case of using MA-Remote controller, please connect to TB15.  
(Remote controller wire is non-polar.)
- In case of using M-NET, please connect to TB5. (Transmission line is non-polar.)
- Symbol [S] of TB5 is the shield wire connection.
- Symbols used in wiring diagram above are, : terminal block, : connector.
- The setting of the SW2 dip switches differs in the capacity. For the detail, refer to the fig. #1.

# 7

# REFRIGERANT SYSTEM DIAGRAM

PKFY-P32, 40, 50VHM-E  
 PKFY-P32, 40, 50VHM-ER1

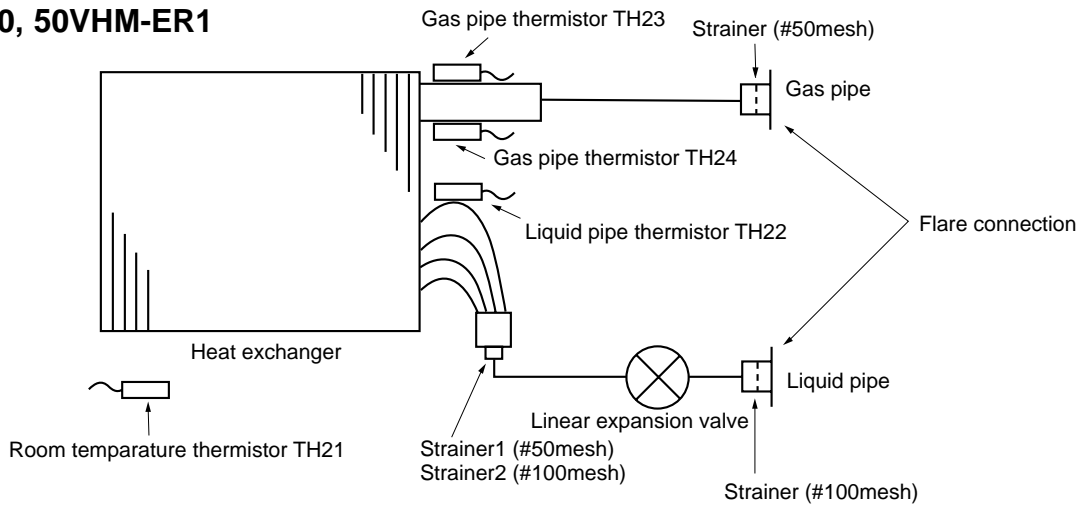

Unit : mm (inch)

Item	Service Ref.	PKFY-P32VHM-E(R1) PKFY-P40VHM-E(R1)	PKFY-P50VHM-ER1	PKFY-P50VHM-E
Gas pipe		$\phi 12.7(1/2)$	$\phi 12.7(1/2)$	$\phi 12.7(1/2)/\phi 15.88(5/8)$
Liquid pipe		$\phi 6.35(1/4)$	$\phi 6.35(1/4)$	$\phi 6.35(1/4)/\phi 9.52(3/8)$

# 8

# TROUBLESHOOTING

## 8-1. HOW TO CHECK THE PARTS

PKFY-P32, 40, 50VHM-E PKFY-P32, 40, 50VHM-ER1

Parts name	Check points														
Room temperature thermistor (TH21) Liquid pipe temperature thermistor (TH22) Gas pipe temperature thermistor (TH23, 24)	Disconnect the connector then measure the resistance using a tester. (At the ambient temperature 10°C ~30°C) <table border="1" style="margin-left: 20px;"> <thead> <tr> <th>Normal</th> <th>Abnormal</th> </tr> </thead> <tbody> <tr> <td>4.3kΩ~9.6kΩ</td> <td>Open or short</td> </tr> </tbody> </table> Refer to the next page for the details.	Normal	Abnormal	4.3kΩ~9.6kΩ	Open or short										
Normal	Abnormal														
4.3kΩ~9.6kΩ	Open or short														
Vane motor (MV)	Measure the resistance between the terminals using a tester. (Coil temperature 25°C) <table border="1" style="margin-left: 20px;"> <thead> <tr> <th colspan="4">Normal</th> <th>Abnormal</th> </tr> </thead> <tbody> <tr> <td>①-② Brown-Red</td> <td>①-③ Brown-Orange</td> <td>①-④ Brown-Yellow</td> <td>①-⑤ Brown-Green</td> <td rowspan="2">Open or short</td> </tr> <tr> <td colspan="4" style="text-align: center;">350Ω ± 7%</td> </tr> </tbody> </table>	Normal				Abnormal	①-② Brown-Red	①-③ Brown-Orange	①-④ Brown-Yellow	①-⑤ Brown-Green	Open or short	350Ω ± 7%			
Normal				Abnormal											
①-② Brown-Red	①-③ Brown-Orange	①-④ Brown-Yellow	①-⑤ Brown-Green	Open or short											
350Ω ± 7%															
Fan motor (MF)	Refer to 8-1-3.														
Linear expansion valve (LEV)	Disconnect the connector then measure the resistance value using a tester. (Coil temperature 20°C) <table border="1" style="margin-left: 20px;"> <thead> <tr> <th colspan="4">Normal</th> <th>Abnormal</th> </tr> </thead> <tbody> <tr> <td>(1)-(5) White-Red</td> <td>(2)-(6) Yellow-Brown</td> <td>(3)-(5) Orange-Red</td> <td>(4)-(6) Blue-Brown</td> <td rowspan="2">Open or short</td> </tr> <tr> <td colspan="4" style="text-align: center;">200Ω ± 10%</td> </tr> </tbody> </table>	Normal				Abnormal	(1)-(5) White-Red	(2)-(6) Yellow-Brown	(3)-(5) Orange-Red	(4)-(6) Blue-Brown	Open or short	200Ω ± 10%			
Normal				Abnormal											
(1)-(5) White-Red	(2)-(6) Yellow-Brown	(3)-(5) Orange-Red	(4)-(6) Blue-Brown	Open or short											
200Ω ± 10%															

## 8-1-1. Thermistor

<Thermistor Characteristic graph>

Thermistor for lower temperature

Room temperature thermistor (TH21)  
Liquid pipe temperature thermistor (TH22)  
Gas pipe temperature thermistor (TH23)  
(TH24)

Thermistor  $R_0=15k\Omega \pm 3\%$

Fixed number of  $B=3480 \pm 2\%$

$$R_t = 15 \exp \left\{ 3480 \left( \frac{1}{273+t} - \frac{1}{273} \right) \right\}$$

0°C	15kΩ
10°C	9.6kΩ
20°C	6.3kΩ
25°C	5.4kΩ
30°C	4.3kΩ
40°C	3.0kΩ

< Thermistor for lower temperature >

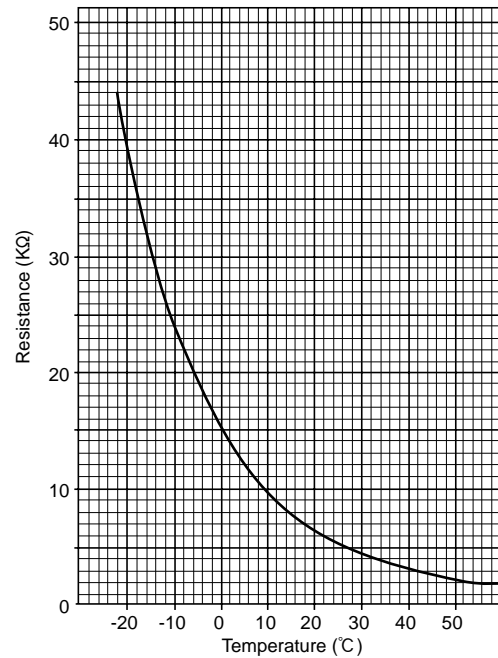

## 8-1-2. Liner expansion valve

### ① Operation summary of the linear expansion valve

- Linear expansion valve opens/closes through stepping motor after receiving the pulse signal from the indoor controller board.
- Valve position can be changed in proportion to the number of pulse signal.

<Connection between the indoor controller board and the linear expansion valve>

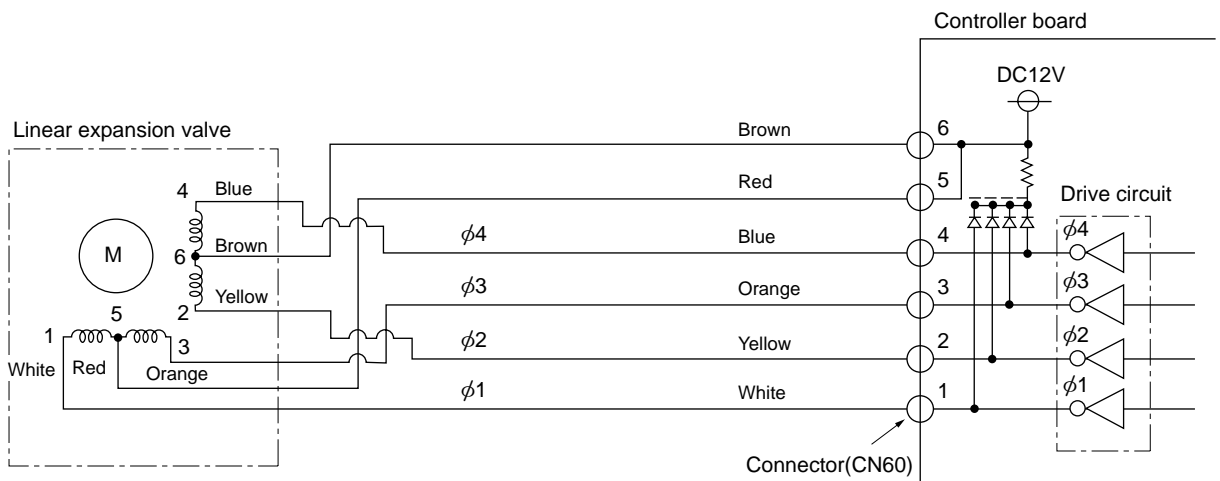

### <Output pulse signal and the valve operation>

Output (Phase)	Output			
	1	2	3	4
$\phi 1$	ON	OFF	OFF	ON
$\phi 2$	ON	ON	OFF	OFF
$\phi 3$	OFF	ON	ON	OFF
$\phi 4$	OFF	OFF	ON	ON

Closing a valve : 1 → 2 → 3 → 4 → 1  
 Opening a valve : 4 → 3 → 2 → 1 → 4  
 The output pulse shifts in above order.

#### ② Linear expansion valve operation

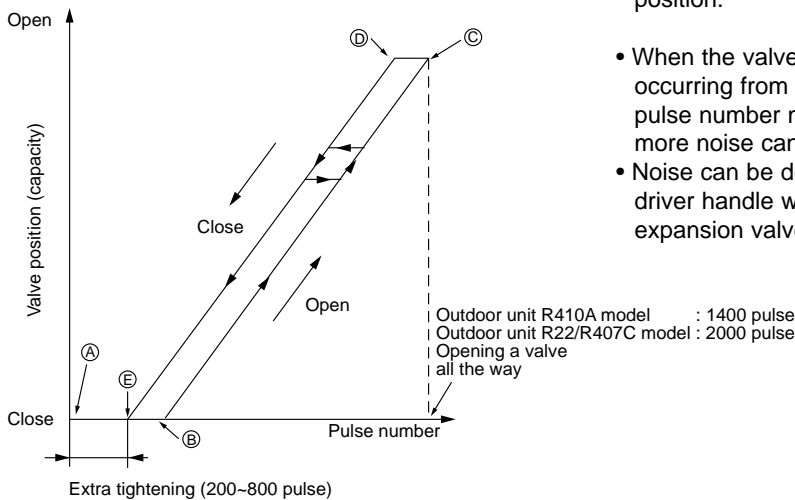

- When linear expansion valve operation stops, all output phase become OFF.
- At phase interruption or when phase does not shift in order, motor does not rotate smoothly and motor will lock and vibrate.
- When the switch is turned on, 2200 pulse closing valve signal will be sent till it goes to point A in order to define the valve position.
- When the valve moves smoothly, there is no noise or vibration occurring from the linear expansion valves; however, when the pulse number moves from E to A or when the valve is locked, more noise can be heard than in a normal situation.
- Noise can be detected by placing the ear against the screw driver handle while putting the screw driver tip to the linear expansion valve.

#### ③ Trouble shooting

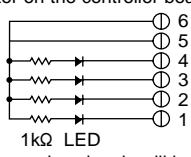
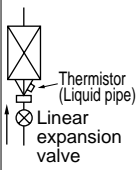
Symptom	Check points	Countermeasures
Operation circuit failure of the micro processor	Disconnect the connector on the controller board, then connect LED for checking.  1kΩ LED When power is turned on, pulse signals will be output for 10 seconds. There must be some defects in the operation circuit if the LED does not light while the signals are output or keeps lighting even after the signals stop.	Exchange the indoor controller board in case of drive circuit failure.
Linear expansion valve mechanism is locked.	Motor will idle and make a ticking noise when the motor is operated while the linear expansion valve is locked. This ticking sound is the sign of the abnormality.	Exchange the linear expansion valve.
Short or breakage of the motor coil of the linear expansion valve	Measure the resistance between each coil (white-red, yellow-brown, orange-red, blue-brown) using a tester. It is normal if the resistance is in the range of $200\Omega \pm 10\%$ .	Exchange the linear expansion valve.
Valve does not close completely.	To check the linear expansion valve, operate the indoor unit in fan mode and at the same time operate other indoor units in cooling mode, then check the pipe temperature <liquid pipe temperature> of the indoor unit by the outdoor multi controller board operation monitor. During fan operation, linear expansion valve is closed completely and if there is any leaking, detecting temperature of the thermistor will go lower. If the detected temperature is much lower than the temperature indicated in the remote controller, it means the valve is not closed all the way. It is not necessary to exchange the linear expansion valve, if the leakage is small and not affecting normal operation. 	If large amount of refrigerant is leaked, exchange the linear expansion valve.
Wrong connection of the connector or contact failure	Check the color of lead wire and missing terminal of the connector.	Disconnect the connector at the controller board, then check the continuity.

### 8-1-3. DC Fan motor (fan motor/indoor controller circuit board)

#### Check method of DC fan motor (fan motor/indoor controller circuit board)

① Notes

- High voltage is applied to the connector (CNMF) for the fan motor. Pay attention to the service.
- Do not pull out the connector (CNMF) for the motor with the power supply on.  
(It causes trouble of the indoor controller circuit board and fan motor.)

② Self check



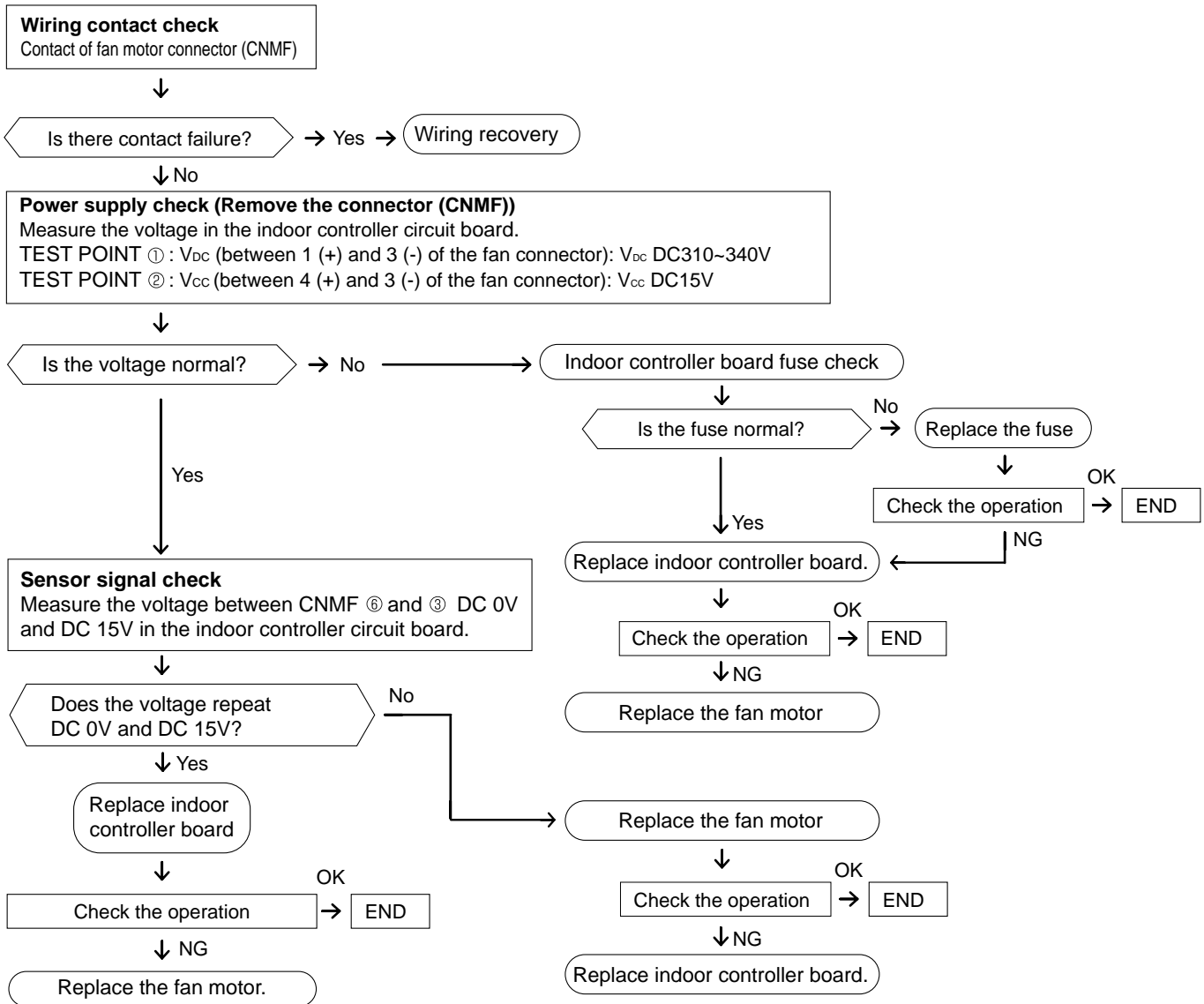









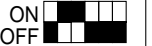
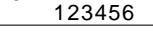
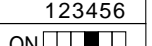

Symptom : The indoor fan cannot turn around.

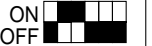
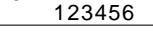
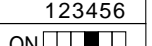



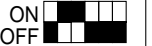
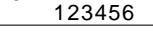
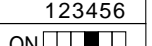

## 8-2. Function of Dip switch

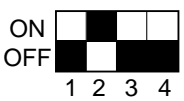
### PKFY-P32, 40, 50VHM-E PKFY-P32, 40, 50VHM-ER1

Switch	Pole	Function	Operation by switch		Effective timing	Remarks																		
			ON	OFF																				
SW1 Mode selection	1	Thermistor<Room temperature> position	Built-in remote controller	Indoor unit	Under suspension	<div style="border: 1px solid black; padding: 5px;"> <b>Address board</b>                       &lt;Initial setting&gt;                      ON                       OFF                      1 2 3 4 5 6 7 8 9 10                       NOTE:                      *1  <table border="1" style="font-size: small;"> <tr> <td>SW1-7</td> <td>SW1-8</td> <td>Fan speed</td> </tr> <tr> <td>OFF</td> <td>OFF</td> <td>Extra low</td> </tr> <tr> <td>ON</td> <td>OFF</td> <td>Low</td> </tr> <tr> <td>OFF</td> <td>ON</td> <td>Setting air flow</td> </tr> <tr> <td>ON</td> <td>ON</td> <td>Stop</td> </tr> </table> </div>	SW1-7	SW1-8	Fan speed	OFF	OFF	Extra low	ON	OFF	Low	OFF	ON	Setting air flow	ON	ON	Stop			
	SW1-7	SW1-8	Fan speed																					
	OFF	OFF	Extra low																					
	ON	OFF	Low																					
	OFF	ON	Setting air flow																					
	ON	ON	Stop																					
	2	Filter clogging detection	Provide	Not provide																				
	3	Filter cleaning sign	2,500 hr	100 hr																				
	4	Fresh air intake *2	Not effective	Not effective																				
	5	Switching remote controller display	Thermo ON signal indication	Fan output indication																				
6	Humidifier control	Fan operation at Heating mode	Thermo ON operation at heating mode																					
7	Air flow set in case of heat thermo OFF	Low *1	Extra low *1																					
8		Setting air flow *1	Depends on SW1-7																					
9	Auto restart function	Effective	Not effective																					
10	Power ON/OFF by breaker	Effective	Not effective																					
SW2 Capacity code switch	1~6	<table border="1" style="font-size: small; margin: auto;"> <tr> <th colspan="2">PKFY-P-VHM-E</th> <th colspan="2">PKFY-P-VHM-ER1</th> </tr> <tr> <th>Models</th> <th>SW2</th> <th>Models</th> <th>SW2</th> </tr> <tr> <td>P32</td> <td>ON </td> <td>P32</td> <td>ON </td> </tr> <tr> <td>P40</td> <td>OFF </td> <td>P40</td> <td>ON </td> </tr> <tr> <td>P50</td> <td>OFF </td> <td>P50</td> <td>ON </td> </tr> </table>	PKFY-P-VHM-E		PKFY-P-VHM-ER1		Models	SW2	Models	SW2	P32	ON 	P32	ON 	P40	OFF 	P40	ON 	P50	OFF 	P50	ON 	Before power supply ON	Indoor controller board
PKFY-P-VHM-E		PKFY-P-VHM-ER1																						
Models	SW2	Models	SW2																					
P32	ON 	P32	ON 																					
P40	OFF 	P40	ON 																					
P50	OFF 	P50	ON 																					
SW3 Function selection	1	Heat pump/Cool only	Cooling only	Heat pump	Under suspension	<div style="border: 1px solid black; padding: 5px;"> <b>Indoor controller board</b>                       &lt;Initial setting&gt;                      ON                       OFF                      1 2 3 4 5 6 7 8                       *1 Second setting is same as first setting.                      *2 Please do not use SW3-7,8 as trouble might be caused by the usage condition.                 </div>																		
	2	Not used	—	—																				
	3	Not used	—	—																				
	4	Vane horizontal angle	Second setting *1	First setting																				
	5	Changing the opening of linear expansion valve during thermo OFF	Effective	Not effective																				
	6	Heating 4 degree up	Not effective	Effective																				
	7	Target superheat setting *2	—	—																				
	8	Target subcool *2	—	—																				
SW4 Model selection	1~4	<p>In case of replacing the indoor controller board, make sure to set the switch to the initial setting, which is shown below.</p> 	Before power supply ON	Indoor controller board																				

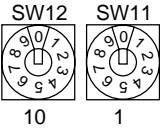
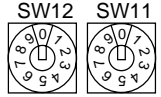

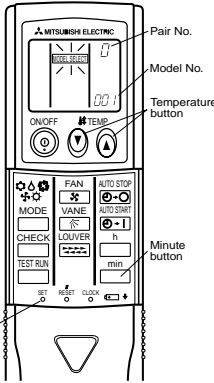
Switch		Operation by switch	Effective timing	Remarks																											
SW11 1s digit address setting SW12 10ths digit address setting	Rotary Switch	 <p>How to set addresses Example : If address is "3", remain SW12 (for over 10) at "0", and match SW11 (for 1 to 9) with "3".</p>	Before power supply ON	<div style="border: 1px solid black; padding: 5px; width: fit-content; margin: 0 auto;">Address board</div> <p>&lt;Initial setting&gt;</p> 																											
SW14 Branch No. Setting	Rotary switch	 <p>How to set branch numbers SW14 (Series R2 only) Match the indoor unit's refrigerant pipe with the BC controller's end connection number. Remain other than series R2 at "0".</p>			<div style="border: 1px solid black; padding: 5px; width: fit-content; margin: 0 auto;">Address board</div> <p>&lt;Initial setting&gt;</p> 																										
J41, J42 Wireless remote controller Pair No.	Jumper	<ul style="list-style-type: none"> <li>To operate each indoor unit by each remote controller when installed 2 indoor units or more are near, Pair No. setting is necessary.               <ul style="list-style-type: none"> <li>● Pair No. setting is available with the 4 patterns (Setting patterns A to D).</li> <li>● Make setting for J41, J42 of indoor controller board and the Pair No. of wireless remote controller.</li> </ul> </li> <li>You may not set it when operating it by one remote controller.               <ul style="list-style-type: none"> <li>● Setting for indoor unit Cut jumper wire J41, J42 on the indoor controller board according to the table below.</li> <li>● Wireless remote controller pair number: Setting operation                   <ol style="list-style-type: none"> <li>Press the SET button (using a pointed implement). Check that the remote controller's display has stopped before continuing. MODEL SELECT flashes, and the model No. (3 digits) appears (steadily-lit).</li> <li>Press the MINUTE button twice. The pair number appears flashing.</li> <li>Press the temperature (M) (A) buttons to select the pair number to set.</li> <li>Press the SET button (using a pointed implement). The set pair number is displayed (steadily-lit) for 3 seconds, then disappears.</li> </ol> </li> </ul> </li> </ul> <table border="1" data-bbox="277 1406 959 1608" style="width: 100%; border-collapse: collapse; text-align: center;"> <thead> <tr> <th rowspan="2">Setting pattern</th> <th colspan="2">Indoor controller jumper wire</th> <th rowspan="2">Pair No. of wireless remote controller*</th> <th rowspan="2"></th> </tr> <tr> <th>J41</th> <th>J42</th> </tr> </thead> <tbody> <tr> <td>A</td> <td>—</td> <td>—</td> <td>0</td> <td>Initial setting</td> </tr> <tr> <td>B</td> <td>Cut</td> <td>—</td> <td>1</td> <td>—</td> </tr> <tr> <td>C</td> <td>—</td> <td>Cut</td> <td>2</td> <td>—</td> </tr> <tr> <td>D</td> <td>Cut</td> <td>Cut</td> <td>3</td> <td>—</td> </tr> </tbody> </table> <p>* Pair No.4-9 of wireless remote controller is setting pattern D.</p>	Setting pattern	Indoor controller jumper wire		Pair No. of wireless remote controller*		J41	J42	A	—	—	0	Initial setting	B	Cut	—	1	—	C	—	Cut	2	—	D	Cut	Cut	3	—	Under operation or suspension	<p>&lt;Initial setting&gt; Pattern A</p> 
Setting pattern	Indoor controller jumper wire			Pair No. of wireless remote controller*																											
	J41	J42																													
A	—	—	0	Initial setting																											
B	Cut	—	1	—																											
C	—	Cut	2	—																											
D	Cut	Cut	3	—																											

## 8-3. TEST POINT DIAGRAM

### 8-3-1. Indoor controller board

PKFY-P32VHM-E      PKFY-P32VHM-ER1  
 PKFY-P40VHM-E      PKFY-P40VHM-ER1  
 PKFY-P50VHM-E      PKFY-P50VHM-ER1

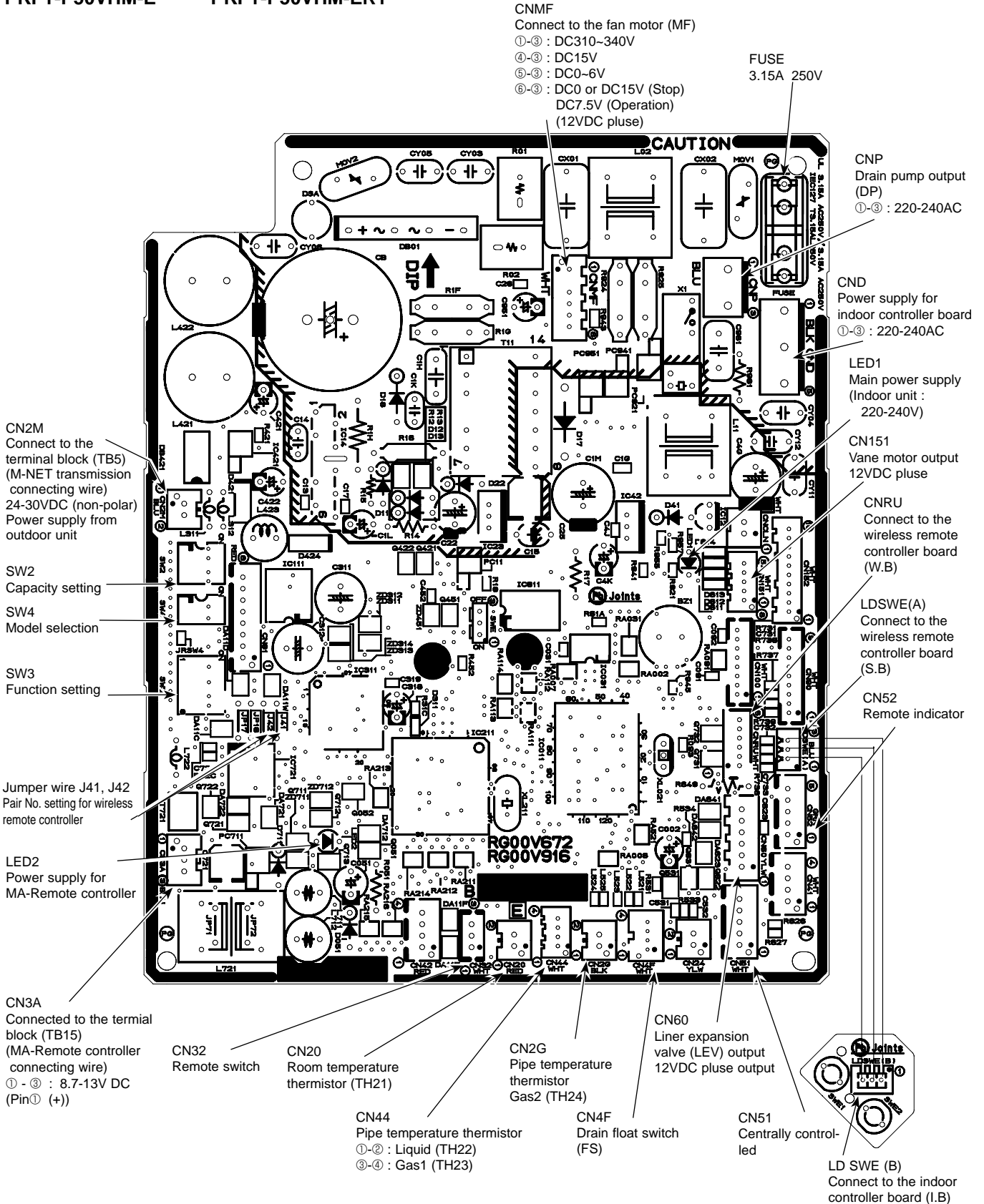

**8-3-2. Wireless remote controller board**  
 PKFY-P32VHM-E      PKFY-P32VHM-ER1  
 PKFY-P40VHM-E      PKFY-P40VHM-ER1  
 PKFY-P50VHM-E      PKFY-P50VHM-ER1

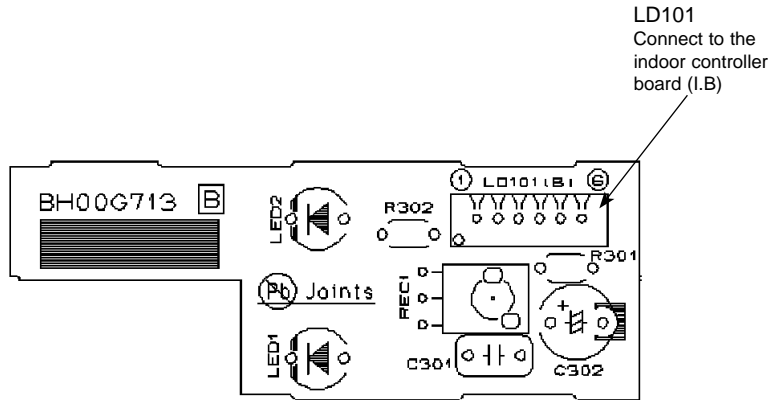

**8-3-3. Address board**  
 PKFY-P32VHM-E      PKFY-P32VHM-ER1  
 PKFY-P40VHM-E      PKFY-P40VHM-ER1  
 PKFY-P50VHM-E      PKFY-P50VHM-ER1

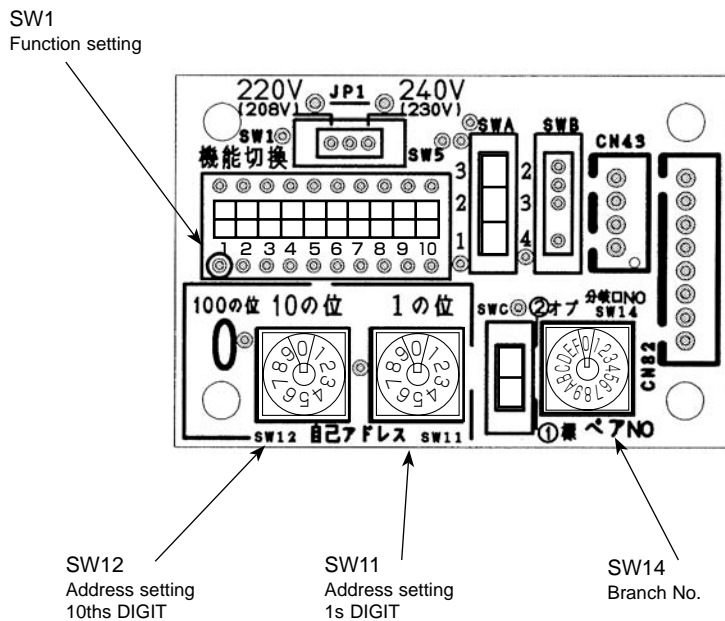

PKFY-P32VHM-E  
PKFY-P32VHM-ER1

PKFY-P40VHM-E  
PKFY-P40VHM-ER1

PKFY-P50VHM-E  
PKFY-P50VHM-ER1

Be careful when removing heavy parts.

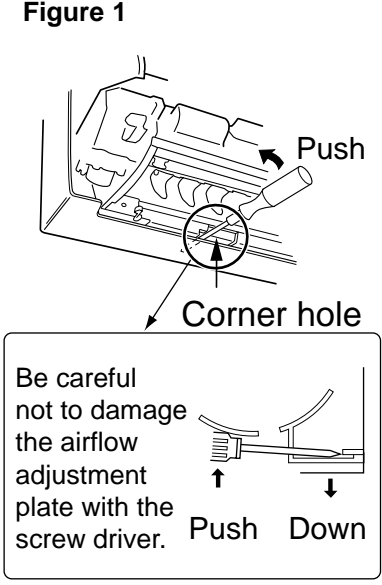
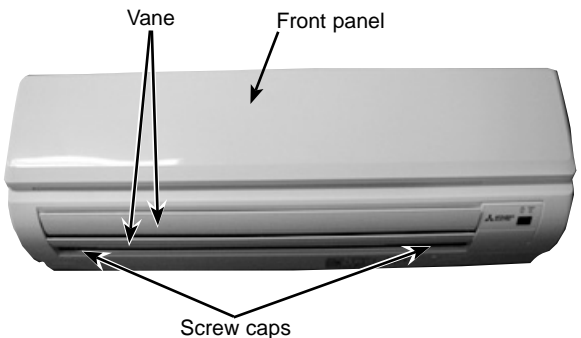
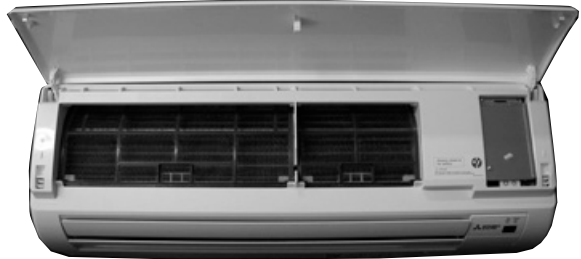
OPERATION PROCEDURE	PHOTOS & ILLUSTRATIONS
<p><b>1. REMOVING THE LOWER SIDE OF THE INDOOR UNIT FROM THE INSTALLATION PLATE</b></p> <p>(1) Remove the front panel.</p> <p>(2) Insert the screw driver to the corner hole at both left and right side as shown in the figure 1.</p> <p>(3) Push it up, then pull down the lower side of indoor unit and remove the hook.</p>	<p><b>Figure 1</b></p> 
<p><b>2. REMOVING THE FRONT PANEL</b></p> <p>(1) Press and unlock the knobs on both sides of the front panel and lift the front panel until it is level. Pull the hinges forward to remove the front panel. (See Photo 2)</p> <p>(2) Move the horizontal vanes in a downward direction.</p> <p>(3) Remove the screw caps of the panel. Remove the screws. (See Photo 1)</p> <p>(4) Hold the lower part of both ends of the panel and pull it slightly toward you, and then remove the panel by pushing it upward.</p>	<p><b>Photo 1</b></p>  <p><b>Photo 2</b></p> 

## OPERATION PROCEDURE

### 3. REMOVING THE INDOOR CONTROLLER BOARD AND WIRELESS CONTROLLER BOARD

- (1) Remove the front panel. (Refer to 2.)
- (2) Remove the room temp. thermistor TH21. (see Photo 3)
- (3) Remove the electrical box covers (screw 4 × 12). (See Photo 3)
- (4) Disconnect the connectors on the indoor controller board.
- (5) Remove the switch board cover.
- (6) Pull out the indoor controller board toward you, then disconnect the rest of connectors.  
Remove the indoor controller board and switch board.
- (7) Remove the holder of wireless controller board.
- (8) Disconnect the connector of wireless controller board and remove the wireless controller board from the holder.

## PHOTOS

**Photo 3**

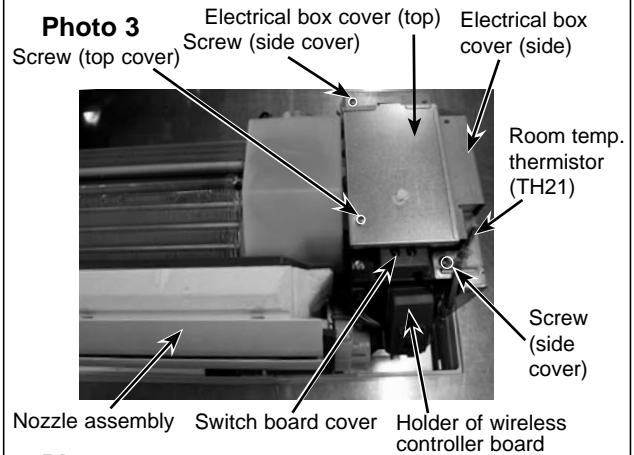

**Photo 4**

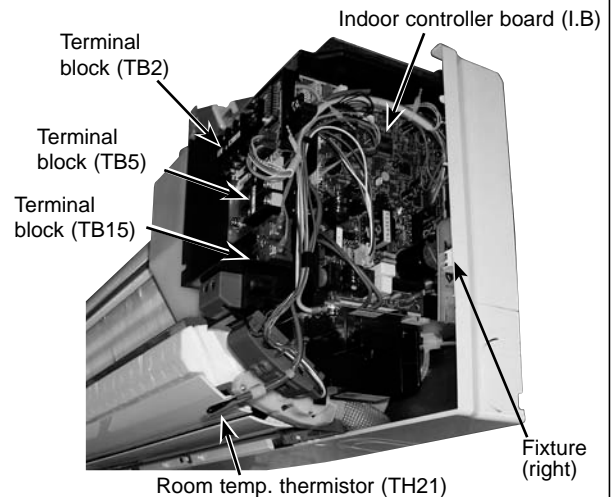

### 4. REMOVING THE ELECTRICAL BOX

- (1) Remove the front panel. (Refer to 2.)
- (2) Remove the electrical box covers. (See Photo 3)
- (3) Remove the nozzle assembly. (Refer to 5.)
- (4) Disconnect the transmission wiring of TB5.
- (5) Disconnect the power supply wiring of TB2.
- (6) Disconnect the wiring of MA-remote controller (TB15).
- (7) Disconnect the connectors on the indoor controller board.
- (8) Disconnect the connector for the ground wire. (See Photo 5)
- (9) Pull the disconnected lead wire out from the electrical box.
- (10) Remove the screw of electrical box. (See Photo 6)
- (11) Push up the upper fixture (See Photo 5) catch to remove the box, then pull the right fixture (See Photo 4) and remove it from the box fixture.

**Photo 5**

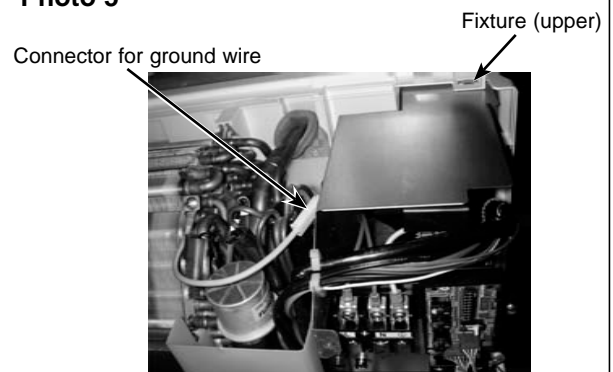

**Photo 6**

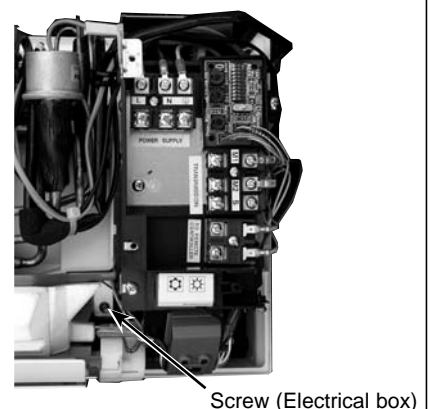



**OPERATION PROCEDURE**

**5. REMOVING THE NOZZLE ASSEMBLY (with VANE and VANE MOTOR) AND DRAIN HOSE**

- (1) Remove the front panel (Refer to 2.).
- (2) Remove the electrical box cover.
- (3) Disconnect the vane motor connector (CN151) on the indoor controller board.
- (4) Remove the corner box.
- (5) Pull the nozzle assembly and detach.
- (6) Push the fixture and remove the drain hose.

**PHOTOS**

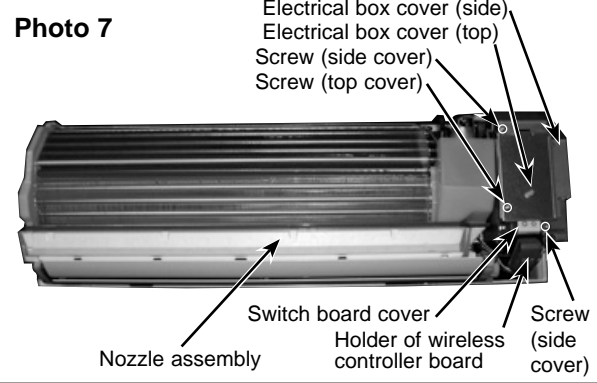

**6. REMOVING THE INDOOR FAN MOTOR AND THE LINE FLOW FAN**

- (1) Remove the front panel (Refer to 2.) and the corner box at right lower side.
- (2) Remove the electrical box (Refer to 4.) and the nozzle assembly (Refer to 5.).
- (3) Remove the screws fixing the motor bed. (See Photo 8)
- (4) Loosen the screw fixing the line flow fan. (See Photo 9)
- (5) Remove the motor bed together with fan motor and motor band.
- (6) Release the hooks of the motor band. Remove the motor band. Pull out the indoor fan motor.
- (7) Remove the screws fixing the left side of the heat exchanger. (See Photo 10)
- (8) Lift the heat exchanger, and pull out the line flow fan to the lower-left.

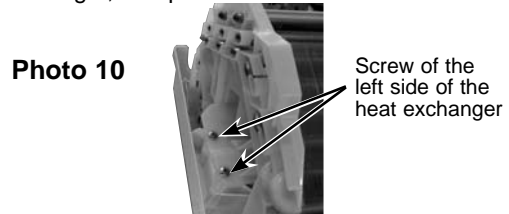
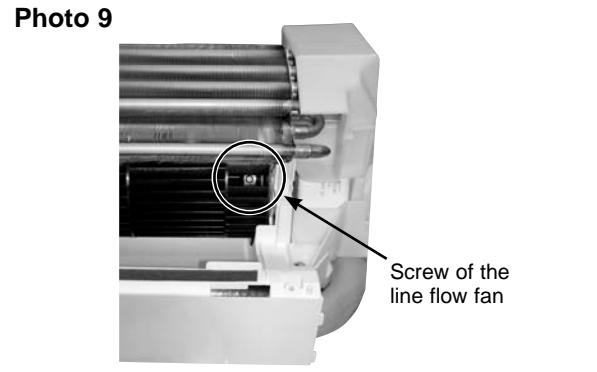
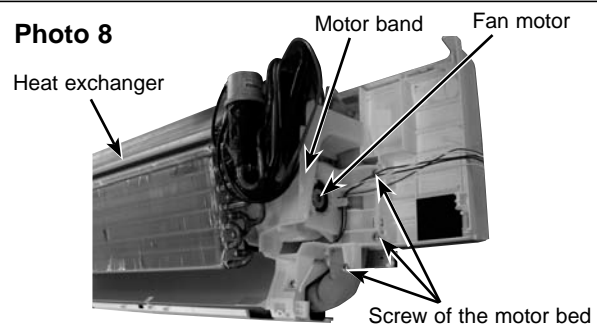

**7. REMOVING THE VANE MOTOR**

- (1) Remove the nozzle assembly. (Refer to 5.)
- (2) Remove the screws of the vane motor unit, and pull out the vane motor unit.
- (3) Remove the screws of the vane motor unit cover.
- (4) Remove the vane motor from the vane motor unit.
- (5) Disconnect the connector from the vane motor.

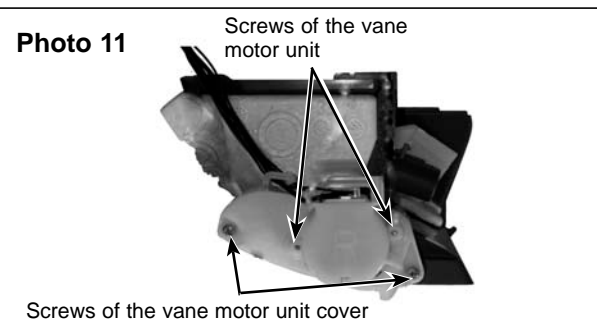

**8. REMOVING THE LIQUID PIPE THERMISTOR AND GAS PIPE THERMISTOR**

- (1) Remove the front panel. (Refer to 2)
- (2) Remove the electrical box cover.
- (3) Remove the motor band.
- (4) Cut the wiring fixed band.
- (5) Remove the liquid pipe thermistor and gas pipe thermistors.
- (6) Disconnect the connector (CN44) (CN2G) on the indoor controller board. (TH22 and TH23/CN44, TH24/CN2G)

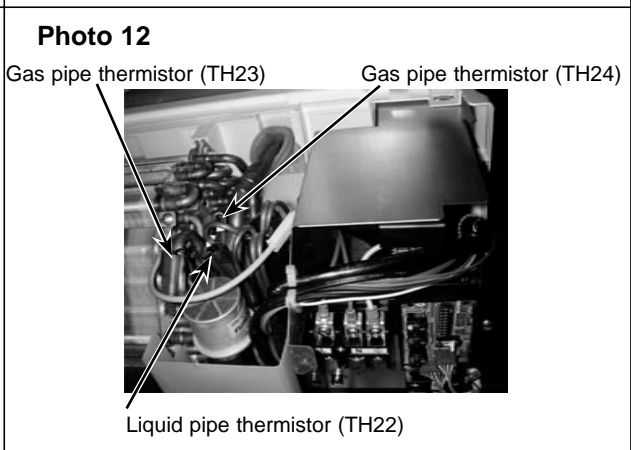

## OPERATION PROCEDURE

### 9. REMOVING THE HEAT EXCHANGER AND LEV

- (1) Remove the front panel (Refer to 2.) and the corner panel at right lower side.
- (2) Remove the electrical box (Refer to 4.) and the nozzle assembly (Refer to 5.).
- (3) Remove the motor band.
- (4) Remove the pipe thermistors (Refer to 8.).
- (5) Disconnect the connector (CN60) on the indoor controller board and the connector for ground wire. (See Photo 5)
- (6) Remove the screws fixing the left side of the heat exchanger. (See Photo 9)
- (7) Remove the heat exchanger with LEV.

## PHOTOS

Photo 13

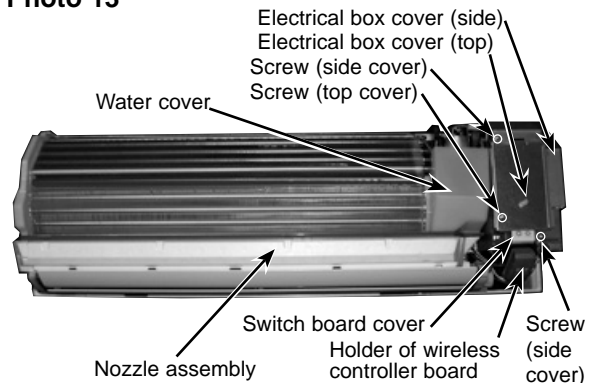
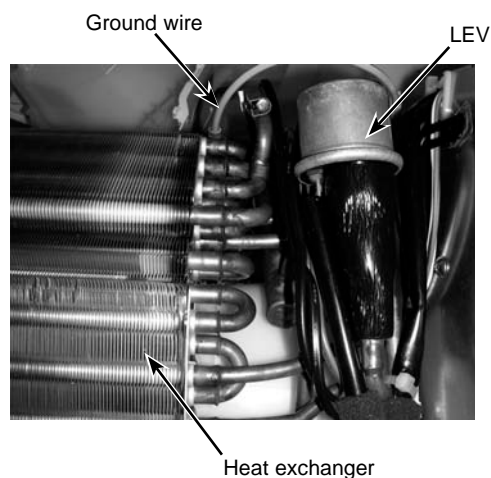

Photo 14



### 10. REMOVING THE ROOM TEMPERATURE THERMISTOR

- (1) Remove the front panel (Refer to 2.).
- (2) Remove the electrical box cover.
- (3) Remove the room temperature thermistor.
- (4) Disconnect the connector (CN20) on the indoor controller board.

**NOTE: When room temp. thermistor is replaced, be sure to use service parts No. R01 N20 202.**

Photo 16



Room temp. thermistor (TH21)

Wire clip

**Caution:**  
There is a case that room temp. thermistor (TH21) is fixed with electrical box side cover screw.

Photo 15

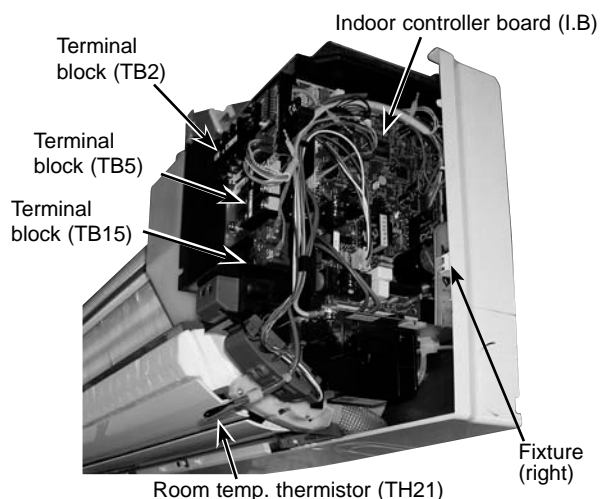

**MITSUBISHI ELECTRIC CORPORATION**

HEAD OFFICE : TOKYO BLDG., 2-7-3, MARUNOUCHI, CHIYODA-KU TOKYO 100-8310, JAPAN