

Air-Conditioners For Building Application**INDOOR UNIT****CE****PFFY-P-VLRMM-E****INSTALLATION MANUAL**

For safe and correct use, please read this installation manual thoroughly before installing the air-conditioner unit.

INSTALLATIONSHANDBUCH

Zum sicheren und ordnungsgemäßen Gebrauch der Klimageräte das Installationshandbuch gründlich durchlesen.

MANUEL D'INSTALLATION

Veillez lire le manuel d'installation en entier avant d'installer ce climatiseur pour éviter tout accident et vous assurer d'une utilisation correcte.

MANUAL DE INSTALACIÓN

Para un uso seguro y correcto, lea detalladamente este manual de instalación antes de montar la unidad de aire acondicionado.

MANUALE DI INSTALLAZIONE

Per un uso sicuro e corretto, leggere attentamente questo manuale di installazione prima di installare il condizionatore d'aria.

INSTALLATIEHANDLEIDING

Voor een veilig en juist gebruik moet u deze installatiehandleiding grondig doorlezen voordat u de airconditioner installeert.

MANUAL DE INSTALAÇÃO

Para segurança e utilização correctas, leia atentamente este manual de instalação antes de instalar a unidade de ar condicionado.

ΕΓΧΕΙΡΙΔΙΟ ΟΔΗΓΙΩΝ ΕΓΚΑΤΑΣΤΑΣΗΣ

Για ασφάλεια και σωστή χρήση, παρακαλείστε διαβάσετε προσεχτικά αυτό το εγχειρίδιο εγκατάστασης πριν αρχίσετε την εγκατάσταση της μονάδας κλιματισμού.

РУКОВОДСТВО ПО УСТАНОВКЕ

Для осторожного и правильного использования прибора необходимо тщательно ознакомиться с данным руководством по установке до выполнения установки кондиционера.

MONTAJ ELKİTABI

Emniyetli ve doğru biçimde nasıl kullanılacağını öğrenmek için lütfen klima cihazını monte etmeden önce bu elkitabını dikkatle okuyunuz.

安装手册

为了安全和正确地使用本空调器，请在安装前仔细阅读本安装手册。

PŘÍRUČKA K INSTALACI

V zájmu bezpečného a správného používání si před instalací klimatizační jednotky důkladně pročtěte tuto příručku k instalaci.

NÁVOD NA INŠTALÁCIU

Pre bezpečné a správne použitie si pred inštalovaním klimatizačnej jednotky, prosím, starostlivo prečítajte tento návod na inštaláciu.

TELEPÍTÉSI KÉZIKÖNYV

A biztonságos és helyes használatához, kérjük, olvassa el alaposan ezt a telepítési kézikönyvet, mielőtt telepítené a légkondicionáló egységet.

PODRĘCZNIK INSTALACJI

W celu bezpiecznego i poprawnego korzystania należy przed zainstalowaniem klimatyzatora dokładnie zapoznać się z niniejszym podręcznikiem instalacji.

PRIROČNIK ZA NAMESTITEV

Za varno in pravilno uporabo pred namestitvijo klimatske naprave skrbno preberite priročnik za namestitev.

GB

D

F

E

I

NL

P

GR

RU

TR

#

CZ

SV

HG

PO

SL

[Fig. 3.1.1]
<Upward blowing type>

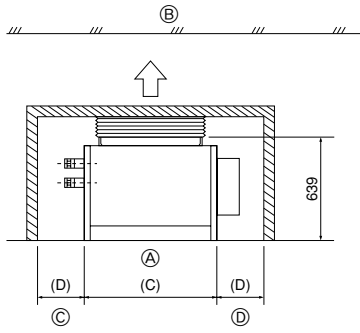

For PFFY-P-VLRMM-E (mm)

Model name	(C)	(D)
20 · 25	660	More than 240
32 · 40	780	More than 240
50 · 63	1030	More than 240

- Ⓐ Floor
- Ⓑ Ceiling
- Ⓒ Piping space
- Ⓓ Electrical part service space

[Fig. 4.1.1]

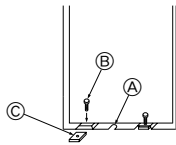

- Ⓐ Floor hole for fixing
- Ⓑ Level adjusting screws (supplied)
- Ⓒ Screw plate (supplied)

[Fig. 4.1.2]

For fixing on the floor
<Viewed from bottom of the unit>

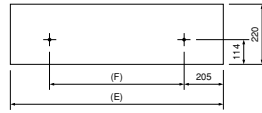

[Fig. 4.1.3]

For fixing on the wall
<Viewed from front of the unit>

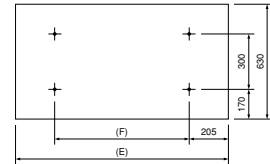

Model name	(E)	(F)
20 · 25	1050	640
32 · 40	1170	760
50 · 63	1410	1000

PFFY-VLRMM-E

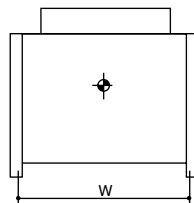
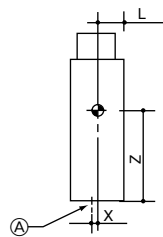

- Ⓐ Floor hole for fixing

5

5.1

[Fig. 5.1.1]

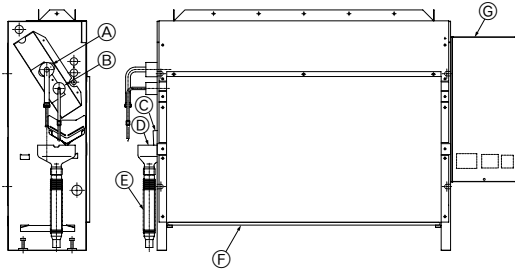

- Ⓐ Refrigerant pipe brazing (for gas): LP
- Ⓑ Refrigerant pipe brazing (for liquid): HP
- Ⓒ Main drain pan
- Ⓓ Sub drain pan
- Ⓔ Hose (accessory) (External diameter $\varnothing 27$ (end $\varnothing 20$))
- Ⓕ Air filter
- Ⓖ Electrical part box

6

6.1

[Fig. 6.1.1]

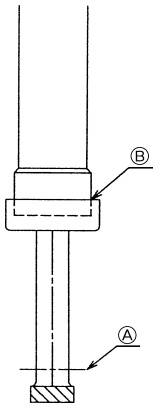

- Ⓐ Cut here
- Ⓑ Remove brazed cap

[Fig. 6.1.2]

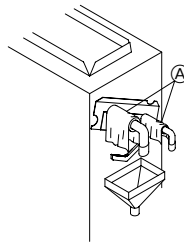

- Ⓐ Cool by a wet cloth

[Fig. 6.1.3]

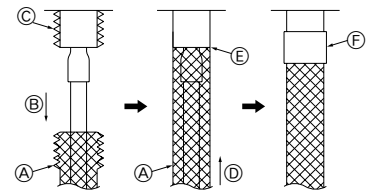

- Ⓐ Thermal insulation
- Ⓑ Pull out insulation
- Ⓒ Wrap with damp cloth
- Ⓓ Return to original position
- Ⓔ Ensure that there is no gap here
- Ⓕ Wrap with insulating tape

6.2

[Fig. 6.2.1]

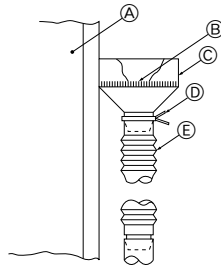

- Ⓐ Indoor unit
- Ⓑ Strainer (accessory)
- Ⓒ Sub drain pan
- Ⓓ Hose band (accessory)
- Ⓔ Drain hose (accessory)

7

7.1

[Fig. 7.1.1]

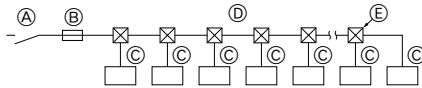

- Ⓐ Switch 16 A
- Ⓑ Overcurrent protection 16 A
- Ⓒ Indoor unit
- Ⓓ Total operating current be less than 16 A
- Ⓔ Pull box

[Fig. 7.2.1]

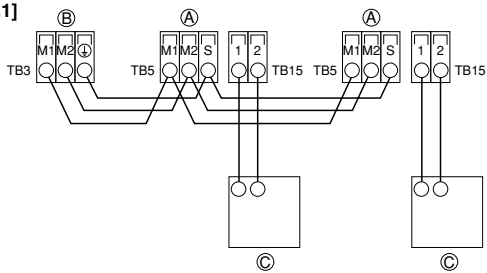

[Fig. 7.2.2]

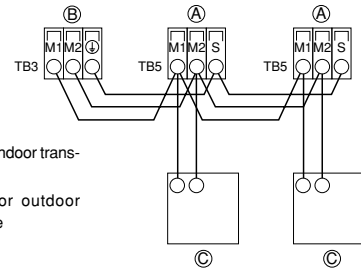

- Ⓐ Terminal block for indoor transmission cable
- Ⓑ Terminal block for outdoor transmission cable
- Ⓒ Remote controller

[Fig. 7.2.3]

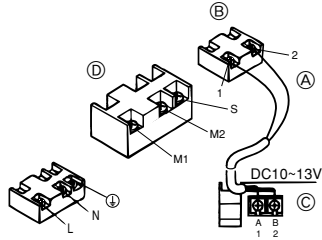

[Fig. 7.2.4]

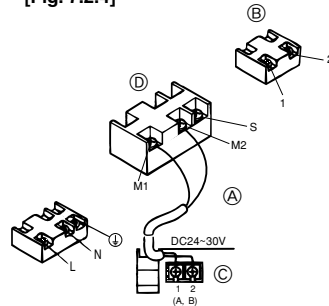

- Ⓐ Non-polarized
- Ⓑ TB15
- Ⓒ Remote Controller
- Ⓓ TB5

[Fig. 7.2.5]

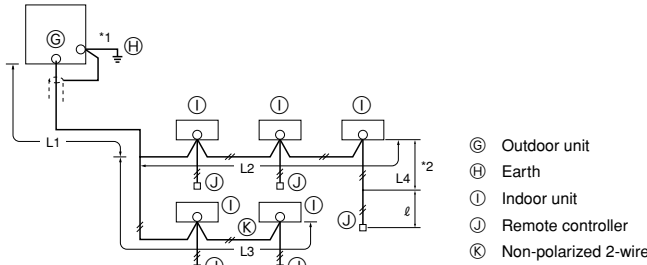

- Ⓒ Outdoor unit
- Ⓓ Earth
- Ⓘ Indoor unit
- Ⓧ Remote controller
- Ⓨ Non-polarized 2-wire

[Fig. 7.3.1]

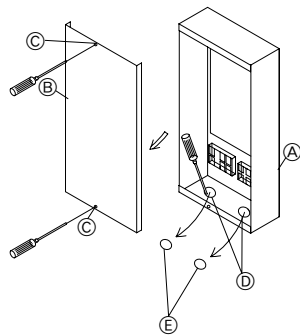

- Ⓐ Control box
- Ⓑ Cover
- Ⓒ Screw
- Ⓓ Knockout hole
- Ⓔ Remove

[Fig. 7.3.2]

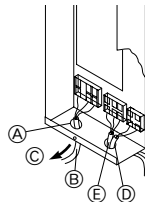

- Ⓐ Use PG bushing to keep the weight of the cable and external force from being applied to the power supply terminal connector. Use a cable tie to secure the cable.
- Ⓑ Power source wiring
- Ⓒ Tensile force
- Ⓓ Use ordinary bushing
- Ⓔ Transmission wiring

[Fig. 7.3.3]

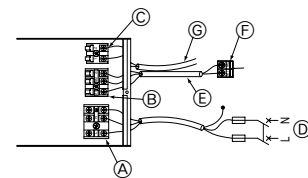

- Ⓐ Power source terminal block
- Ⓑ Terminal block for indoor transmission
- Ⓒ Terminal block for remote controller
- Ⓓ To 1-phase power source
- Ⓔ Transmission line DC 30 V
- Ⓛ Terminal block for outdoor transmission line (TB3)
- Ⓜ Transmission line to the remote controller, terminal block for indoor unit and BC controller

[Fig. 7.3.4]

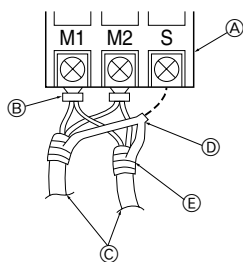

- Ⓐ Terminal block
- Ⓑ Round terminal
- Ⓒ Shield wire
- Ⓓ The earth wire from two cables are connected together to the S terminal. (Dead-end connection)
- Ⓔ Insulation tape (To keep the earth wire of the shielded cable from coming in contact with the transmission terminal)

[Fig. 7.4.1]

<Address board>

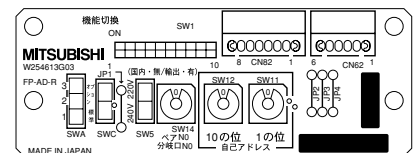

Contents

1. Safety precautions	5	5. Refrigerant pipe and drain pipe specifications	7
1.1. Before installation and electric work	5	5.1. Refrigerant pipe and drain pipe size	7
1.2. Precautions for devices that use R410A refrigerant	5	6. Connecting refrigerant pipes and drain pipes	8
1.3. Before getting installed	6	6.1. Refrigerant piping work	8
1.4. Before getting installed (moved) - electrical work	6	6.2. Drain piping work	8
1.5. Before starting the test run	6	7. Electrical wiring	8
2. Indoor unit accessories	6	7.1. Power supply wiring	9
3. Selecting an installation site	6	7.2. Connecting remote controller, indoor and outdoor transmission cables	9
3.1. Securing installation and service space	7	7.3. Connecting electrical wires	9
3.2. Combining indoor units with outdoor units	7	7.4. Selecting the external static pressure	10
4. Installing the unit	7	7.5. Setting addresses	10
4.1. Assembling the unit	7	7.6. Sensing room temperature with the built-in sensor in a remote controller	10
4.2. Center of gravity and product weight	7		

1. Safety precautions

1.1. Before installation and electric work

- ▶ Before installing the unit, make sure you read all the “Safety precautions”.
- ▶ The “Safety precautions” provide very important points regarding safety. Make sure you follow them.

Symbols used in the text





Warning:

Describes precautions that should be observed to prevent danger of injury or death to the user.

Caution:

Describes precautions that should be observed to prevent damage to the unit.

Symbols used in the illustrations

-  : Indicates an action that must be avoided.
-  : Indicates that important instructions must be followed.
-  : Indicates a part which must be grounded.
-  : Indicates that caution should be taken with rotating parts. (This symbol is displayed on the main unit label.) <Color: yellow>
-  : Beware of electric shock (This symbol is displayed on the main unit label.) <Color: yellow>

Warning:

Carefully read the labels affixed to the main unit.

Warning:

- **Ask the dealer or an authorized technician to install the air conditioner.**
 - Improper installation by the user may result in water leakage, electric shock, or fire.
- **Install the air unit at a place that can withstand its weight.**
 - Inadequate strength may cause the unit to fall down, resulting in injuries.
- **Use the specified cables for wiring. Make the connections securely so that the outside force of the cable is not applied to the terminals.**
 - Inadequate connection and fastening may generate heat and cause a fire.
- **Prepare for typhoons and other strong winds and earthquakes and install the unit at the specified place.**
 - Improper installation may cause the unit to topple and result in injury.
- **Always use an air cleaner, humidifier, electric heater, and other accessories specified by Mitsubishi Electric.**
 - Ask an authorized technician to install the accessories. Improper installation by the user may result in water leakage, electric shock, or fire.
- **Never repair the unit. If the air conditioner must be repaired, consult the dealer.**
 - If the unit is repaired improperly, water leakage, electric shock, or fire may result.
- **Do not touch the heat exchanger fins.**
 - Improper handling may result in injury.
- **When handling this product, always wear protective equipment.**
 - EG: Gloves, full arm protection namely boiler suit, and safety glasses.**
 - Improper handling may result in injury.
- **If refrigerant gas leaks during installation work, ventilate the room.**
 - If the refrigerant gas comes into contact with a flame, poisonous gases will be released.
- **Install the air conditioner according to this Installation Manual.**
 - If the unit is installed improperly, water leakage, electric shock, or fire may result.

- **Have all electric work done by a licensed electrician according to “Electric Facility Engineering Standard” and “Interior Wire Regulations” and the instructions given in this manual and always use a special circuit.**
 - If the power source capacity is inadequate or electric work is performed improperly, electric shock and fire may result.
- **Keep the electric parts away from water (washing water etc.).**
 - It might result in electric shock, catching fire or smoke.
- **Securely install the outdoor unit terminal cover (panel).**
 - If the terminal cover (panel) is not installed properly, dust or water may enter the outdoor unit and fire or electric shock may result.
- **When installing and moving the air conditioner to another site, do not charge the it with a refrigerant different from the refrigerant specified on the unit.**
 - If a different refrigerant or air is mixed with the original refrigerant, the refrigerant cycle may malfunction and the unit may be damaged.
- **If the air conditioner is installed in a small room, measures must be taken to prevent the refrigerant concentration from exceeding the safety limit even if the refrigerant should leak.**
 - Consult the dealer regarding the appropriate measures to prevent the safety limit from being exceeded. Should the refrigerant leak and cause the safety limit to be exceeded, hazards due to lack of oxygen in the room could result.
- **When moving and reinstalling the air conditioner, consult the dealer or an authorized technician.**
 - If the air conditioner is installed improperly, water leakage, electric shock, or fire may result.
- **After completing installation work, make sure that refrigerant gas is not leaking.**
 - If the refrigerant gas leaks and is exposed to a fan heater, stove, oven, or other heat source, it may generate noxious gases.
- **Do not reconstruct or change the settings of the protection devices.**
 - If the pressure switch, thermal switch, or other protection device is shorted and operated forcibly, or parts other than those specified by Mitsubishi Electric are used, fire or explosion may result.
- **To dispose of this product, consult your dealer.**
- **Do not use a leak detection additive.**

1.2. Precautions for devices that use R410A refrigerant

Caution:

- **Do not use the existing refrigerant piping.**
 - The old refrigerant and refrigerator oil in the existing piping contains a large amount of chlorine which may cause the refrigerator oil of the new unit to deteriorate.
- **Use refrigerant piping made of C1220 (Cu-DHP) phosphorus deoxidized copper as specified in the JIS H3300 “Copper and copper alloy seamless pipes and tubes”. In addition, be sure that the inner and outer surfaces of the pipes are clean and free of hazardous sulphur, oxides, dust/dirt, shaving particles, oils, moisture, or any other contaminant.**
 - Contaminants on the inside of the refrigerant piping may cause the refrigerant residual oil to deteriorate.
- **Store the piping to be used during installation indoors and keep both ends of the piping sealed until just before brazing. (Store elbows and other joints in a plastic bag.)**
 - If dust, dirt, or water enters the refrigerant cycle, deterioration of the oil and compressor trouble may result.
- **Use liquid refrigerant to fill the system.**
 - If gas refrigerant is used to seal the system, the composition of the refrigerant in the cylinder will change and performance may drop.
- **Do not use a refrigerant other than R410A.**
 - If another refrigerant (R22, etc.) is used, the chlorine in the refrigerant may cause the refrigerator oil to deteriorate.

- **Use a vacuum pump with a reverse flow check valve.**
 - The vacuum pump oil may flow back into the refrigerant cycle and cause the refrigerator oil to deteriorate.
- **Do not use the following tools that are used with conventional refrigerants.**

(Gauge manifold, charge hose, gas leak detector, reverse flow check valve, refrigerant charge base, vacuum gauge, refrigerant recovery equipment)

 - If the conventional refrigerant and refrigerator oil are mixed in the R410A, the refrigerant may deteriorate.
 - If water is mixed in the R410A, the refrigerator oil may deteriorate.
 - Since R410A does not contain any chlorine, gas leak detectors for conventional refrigerants will not react to it.
- **Do not use a charging cylinder.**
 - Using a charging cylinder may cause the refrigerant to deteriorate.
- **Be especially careful when managing the tools.**
 - If dust, dirt, or water gets in the refrigerant cycle, the refrigerant may deteriorate.

1.3. Before getting installed

⚠ Caution:

- **Do not install the unit where combustible gas may leak.**
 - If the gas leaks and accumulates around the unit, an explosion may result.
- **Do not use the air conditioner where food, pets, plants, precision instruments, or artwork are kept.**
 - The quality of the food, etc. may deteriorate.
- **Do not use the air conditioner in special environments.**
 - Oil, steam, sulfuric smoke, etc. can significantly reduce the performance of the air conditioner or damage its parts.
- **When installing the unit in a hospital, communication station, or similar place, provide sufficient protection against noise.**
 - The inverter equipment, private power generator, high-frequency medical equipment, or radio communication equipment may cause the air conditioner to operate erroneously, or fail to operate. On the other hand, the air conditioner may affect such equipment by creating noise that disturbs medical treatment or image broadcasting.
- **Do not install the unit on a structure that may cause leakage.**
 - When the room humidity exceeds 80 % or when the drain pipe is clogged, condensation may drip from the indoor unit. Perform collective drainage work together with the outdoor unit, as required.
- **The indoor models should be installed the ceiling over than 2.5 m from floor.**

1.4. Before getting installed (moved) - electrical work

⚠ Caution:

- **Ground the unit.**
 - Do not connect the ground wire to gas or water pipes, lightning rods, or telephone ground lines. Improper grounding may result in electric shock.
- **Install the power cable so that tension is not applied to the cable.**
 - Tension may cause the cable to break and generate heat and cause a fire.

2. Indoor unit accessories

The unit is provided with the following accessories:

Part No.	Accessories	Qty	Place to set
1	Screw plate	4	Set inside the packaging material
2	Level adjusting screw	4	
3	Strainer	1	
4	Drain hose	1	
5	Hose band	1	

3. Selecting an installation site

- Select a location so that air can be blown into all corners of the room.
- Avoid locations exposed to outside air.
- Select a location free of obstructions to the airflow in and out of the unit.
- Avoid locations exposed to steam or oil vapour.
- Avoid locations where combustible gas may leak, settle or be generated.
- Avoid installation near machines emitting high-frequency waves (high-frequency welders, etc.).
- Avoid locations where the airflow is directed at a fire alarm sensor. (Hot air could trigger the alarm during the heating operation.)
- Avoid places where acidic solutions are frequently handled.
- Avoid places where sulphur-based or other sprays are frequently used.

- **Install an leak circuit breaker, as required.**
 - If an leak circuit breaker is not installed, electric shock may result.
- **Use power line cables of sufficient current carrying capacity and rating.**
 - Cables that are too small may leak, generate heat, and cause a fire.
- **Use only a circuit breaker and fuse of the specified capacity.**
 - A fuse or circuit breaker of a larger capacity or a steel or copper wire may result in a general unit failure or fire.
- **Do not wash the air conditioner units.**
 - Washing them may cause an electric shock.
- **Be careful that the installation base is not damaged by long use.**
 - If the damage is left uncorrected, the unit may fall and cause personal injury or property damage.
- **Install the drain piping according to this Installation Manual to ensure proper drainage. Wrap thermal insulation around the pipes to prevent condensation.**
 - Improper drain piping may cause water leakage and damage to furniture and other possessions.
- **Be very careful about product transportation.**
 - Only one person should not carry the product if it weighs more than 20 kg.
 - Some products use PP bands for packaging. Do not use any PP bands for a means of transportation. It is dangerous.
 - Do not touch the heat exchanger fins. Doing so may cut your fingers.
 - When transporting the outdoor unit, suspend it at the specified positions on the unit base. Also support the outdoor unit at four points so that it cannot slip sideways.
- **Safely dispose of the packing materials.**
 - Packing materials, such as nails and other metal or wooden parts, may cause stabs or other injuries.
 - Tear apart and throw away plastic packaging bags so that children will not play with them. If children play with a plastic bag which was not torn apart, they face the risk of suffocation.

1.5. Before starting the test run

⚠ Caution:

- **Turn on the power at least 12 hours before starting operation.**
 - Starting operation immediately after turning on the main power switch can result in severe damage to internal parts. Keep the power switch turned on during the operational season.
- **Do not touch the switches with wet fingers.**
 - Touching a switch with wet fingers can cause electric shock.
- **Do not touch the refrigerant pipes during and immediately after operation.**
 - During and immediately after operation, the refrigerant pipes are may be hot and may be cold, depending on the condition of the refrigerant flowing through the refrigerant piping, compressor, and other refrigerant cycle parts. Your hands may suffer burns or frostbite if you touch the refrigerant pipes.
- **Do not operate the air conditioner with the panels and guards removed.**
 - Rotating, hot, or high-voltage parts can cause injuries.
- **Do not turn off the power immediately after stopping operation.**
 - Always wait at least five minutes before turning off the power. Otherwise, water leakage and trouble may occur.

⚠ Warning:

Ensure that the unit is installed in a place strong enough to sustain its weight. If there is a lack of strength, it may cause the unit to fall down, resulting in an injury.

3.1. Securing installation and service space

For PFFY-P-VLRMM-E

(mm)

Model name	(C)	(D)
20 · 25	660	More than 240
32 · 40	780	More than 240
50 · 63	1030	More than 240

[Fig. 3.1.1] (P.2)

<Upward blowing type>

- Ⓐ Floor
- Ⓑ Ceiling
- Ⓒ Piping space
- Ⓓ Electrical part service space

4. Installing the unit

4.1. Assembling the unit

- Install the unit frame in parallel with the floor securely when installing. If the floor is not flat, be sure to use the supplied level adjusting screws to maintain the unit body at level.

[Fig. 4.1.1] (P.2)

- Ⓐ Floor hole for fixing
- Ⓑ Level adjusting screws (supplied)
- Ⓒ Screw plate (supplied)

Note:

There are two level adjusting screws on both sides each, a total of four.

There are the following two methods of fixing the unit for purposes of preventing the unit from falling down. Where fixing is necessary, screw the unit at the specified position given below.

For fixing on the floor

[Fig. 4.1.2] (P.2)

<Viewed from bottom of the unit>

For fixing on the wall

[Fig. 4.1.3] (P.2)

<Viewed from front of the unit>

Model name	(E)	(F)
20 · 25	1050	640
32 · 40	1170	760
50 · 63	1410	1000

Note:

When fixing on the wall, fix the unit with the electrical parts removed from the unit.

5. Refrigerant pipe and drain pipe specifications

To avoid dew drops, provide sufficient antisweating and insulating work to the refrigerant and drain pipes.

When using commercially available refrigerant pipes, be sure to wind commercially available insulating material (with a heat-resisting temperature of more than 100°C and thickness given below) onto both liquid and gas pipes.

Be also sure to wind commercially available insulating material (with a form polyethylene's specific gravity of 0.03 and thickness given below) onto all pipes which pass through rooms.

- Select the thickness of insulating material by pipe size.

Pipe size	Insulating material's thickness
6.4 mm to 25.4 mm	More than 10 mm
28.6 mm to 38.1 mm	More than 15 mm

- If the unit is used on the highest story of a building and under conditions of high temperature and humidity, it is necessary to use pipe size and insulating material's thickness more than those given in the table above.

- If there are customer's specifications, simply follow them.

3.2. Combining indoor units with outdoor units

For combining indoor units with outdoor units, refer to the outdoor unit installation manual.

4.2. Center of gravity and product weight

[Fig. 4.2.1] (P.2)

- Ⓐ Floor hole for fixing

For PFFY-P-VLRMM-E

Model name	W	L	X	Z	Product Weight (kg)
PFFY-P20VLRMM-E	640	100	17	335	18.5
PFFY-P25VLRMM-E	640	100	17	335	18.5
PFFY-P32VLRMM-E	760	100	17	335	20
PFFY-P40VLRMM-E	760	100	17	335	21
PFFY-P50VLRMM-E	1000	100	17	335	25
PFFY-P63VLRMM-E	1000	100	17	335	27

GB

5.1. Refrigerant pipe and drain pipe size

- Ⓐ Refrigerant pipe sizes

Model name	Liquid pipe	Gas pipe
P20/25/32/40/50	ø 6.35	ø 12.7
P63	ø 9.52	ø 15.88

[Fig. 5.1.1] (P.3)

- Ⓐ Refrigerant pipe brazing (for gas): LP
- Ⓑ Refrigerant pipe brazing (for liquid): HP
- Ⓒ Main drain pan
- Ⓓ Sub drain pan
- Ⓔ Hose (accessory) (External diameter ø 27 (end ø 20))
- Ⓕ Air filter
- Ⓖ Electrical part box

6. Connecting refrigerant pipes and drain pipes

6.1. Refrigerant piping work

This piping work must be done in accordance with the installation manuals for both outdoor unit and BC controller (simultaneous cooling and heating series R2).

- Series R2 is designed to operate in a system that the refrigerant pipe from an outdoor unit is received by BC controller and branches at the BC controller to connect between indoor units.
- For constraints on pipe length and allowable difference of elevation, refer to the outdoor unit manual.
- The method of pipe connection is brazing connection.

⚠ Caution:

- **Install the refrigerant piping for the indoor unit in accordance with the following.**

1. Cut the tip of the indoor unit piping, remove the gas, and then remove the brazed cap.

[Fig. 6.1.1] (P.3)

- Ⓐ Cut here
- Ⓑ Remove brazed cap

2. Pull out the thermal insulation on the site refrigerant piping, braze the unit piping, and replace the insulation in its original position. Wrap the piping with insulating tape.

Note:

- **When brazing the refrigerant pipes, be sure to blaze, after covering a wet cloth to the pipes of the units in order to prevent it from burning and shrinking by heat.**

[Fig. 6.1.2] (P.3)

- Ⓐ Cool by a wet cloth

- **Pay strict attention when wrapping the copper piping since wrapping the piping may cause condensation instead of preventing it.**

[Fig. 6.1.3] (P.3)

- Ⓐ Thermal insulation
- Ⓑ Pull out insulation
- Ⓒ Wrap with damp cloth
- Ⓓ Return to original position
- Ⓔ Ensure that there is no gap here
- Ⓕ Wrap with insulating tape

Cautions On Refrigerant Piping

- ▶ **Be sure to use non-oxidative brazing for brazing to ensure that no foreign matter or moisture enter into the pipe.**
- ▶ **Be sure to apply refrigerating machine oil over the flare connection seating surface and tighten the connection using a double spanner.**
- ▶ **Provide a metal brace to support the refrigerant pipe so that no load is imparted to the indoor unit end pipe. This metal brace should be provided 50 cm away from the indoor unit's flare connection.**

⚠ Warning:

When installing and moving the unit, do not charge it with refrigerant other than the refrigerant specified on the unit.

- Mixing of a different refrigerant, air, etc. may cause the refrigerant cycle to malfunction and result in severe damage.

⚠ Caution:

- **Use refrigerant piping made of C1220 (Cu-DHP) phosphorus deoxidized copper as specified in the JIS H3300 "Copper and copper alloy seamless pipes and tubes". In addition, be sure that the inner and outer surfaces of the pipes are clean and free of hazardous sulphur, oxides, dust/dirt, shaving particles, oils, moisture, or any other contaminant.**
- **Never use existing refrigerant piping.**
 - The large amount of chlorine in conventional refrigerant and refrigerator oil in the existing piping will cause the new refrigerant to deteriorate.
- **Store the piping to be used during installation indoors and keep both ends of the piping sealed until just before brazing.**
 - If dust, dirt, or water gets into the refrigerant cycle, the oil will deteriorate and the compressor may fail.
- **The refrigerant used in the unit is highly hygroscopic and mixes with water and will degrade the refrigerator oil.**

6.2. Drain piping work

1. Ensure that the drain piping is downward (pitch of more than 1/100) to the outdoor (discharge) side. Do not provide any trap or irregularity on the way.
2. Ensure that any cross-wise drain piping is less than 20 m (excluding the difference of elevation). If the drain piping is long, provide metal braces to prevent it from waving. Never provide any air vent pipe. Otherwise drain may be ejected.
3. Put the supplied strainer at the bottom of the sub drain pan on the side of the body frame, and connect the supplied drain hose to the end connection. Tighten this end connection using the supplied hose hand.
4. Use a VP30 pipe or equivalent for collecting pipe if it is needed, and pipe it giving a downward pitch of more than 1/100.
5. Provide sufficient insulation just as for refrigerant piping.

[Fig. 6.2.1] (P.3)

- Ⓐ Indoor unit
- Ⓑ Strainer (accessory)
- Ⓒ Sub drain pan
- Ⓓ Hose band (accessory)
- Ⓔ Drain hose (accessory)

⚠ Caution:

Pipe the drain piping to ensure that it discharges drain, and insulate it to prevent dew condensation. A failure to the piping work may cause water leakage and so wet your property.

7. Electrical wiring

Precautions on electrical wiring

⚠ Warning:

Electrical work should be done by qualified electrical engineers in accordance with "Engineering Standards For Electrical Installation" and supplied installation manuals. Special circuits should also be used. If the power circuit lacks capacity or has an installation failure, it may cause a risk of electric shock or fire.

1. Be sure to take power from the special branch circuit.
2. Be sure to install an earth leakage breaker to the power.
3. Install the unit to prevent that any of the control circuit cables (remote controller, transmission cables) is brought in direct contact with the power cable outside the unit.
4. Ensure that there is no slack on all wire connections.
5. Some cables (power, remote controller, transmission cables) above the ceiling may be bitten by mice. Use as many metal pipes as possible to insert the cables into them for protection.

6. Never connect the power cable to leads for the transmission cables. Otherwise the cables would be broken.
7. Be sure to connect control cables to the indoor unit, remote controller, and the outdoor unit.
8. Put the unit to the ground on the outdoor unit side.
9. Select control cables from the conditions given in page 9.

⚠ Caution:

Be sure to put the unit to the ground on the outdoor unit side. Do not connect the earth cable to any gas pipe, water pipe, lightning rod, or telephone earth cable. Incomplete grounding may cause a risk of electric shock.

Types of control cables

1. Wiring transmission cables

- Types of transmission cables
Design wiring in accordance with the following table <Table 1>.
- Cable diameter
More than 1.25 mm²

<Table 1>

System configuration	For a single-refrigerant system		For a multi-refrigerant system
Transmission cable length	Less than 120 m		More than 120 m
Facility example (for noise judgment)	Residence or independent store without noise	Building, clinic, hospital or communications station without noise supposedly generated from inverter equipment, private power generator, high-frequency medical equipment, radio-used communications equipment and so on	Regardless of length
Facility example (for noise judgment)	All facilities		
Types of transmission cables	VCTF, VCTFK, CVV, CVS, VVR, VVF, VCT or shielding wire CVVS or CPEVS	Shielding wire CVVS or CPEVS	
Length	Less than 120 m		Less than 200 m

2. Remote controller cables

	MA remote controller	M-NET remote controller
Types of cables	Sheathed 2-core cable (unshielded) CVV	Sheathed 2-core cable (unshielded) CVV
Cable diameter	0.3 to 1.25 mm ²	0.3 to 1.25 mm ²
Length	Less than 200 m	Add any portion in excess of 10 m to within the longest allowable transmission cable length 200 m (Shielding portion is more than 1.25 mm ²)

7.1. Power supply wiring

- Power supply cords of appliances shall not be lighter than design 245 IEC 57 or 227 IEC 57.
- A switch with at least 3 mm contact separation in each pole shall be provided by the Air conditioner installation.

Power cable size: more than 1.5 mm²

[Fig. 7.1.1] (P.3)

- Ⓐ Switch 16 A
- Ⓑ Overcurrent protection 16 A
- Ⓒ Indoor unit
- Ⓓ Total operating current be less than 16 A
- Ⓔ Pull box

[Selecting non-fuse breaker (NF) or earth leakage breaker (NV)]

To select NF or NV instead of a combination of Class B fuse with switch, use the following:

- In the case of Class B fuse rated 15 A or 20 A,
NF model name (MITSUBISHI): NF30-CS (15 A) (20 A)
NV model name (MITSUBISHI): NV30-CA (15 A) (20 A)

Use an earth leakage breaker with a sensitivity of less than 30 mA 0.1 s.

⚠ Caution:

Do not use anything other than the correct capacity breaker and fuse. Using fuse, wire or copper wire with too large capacity may cause a risk of malfunction or fire.

7.2. Connecting remote controller, indoor and outdoor transmission cables

(Remote controller is optionally available.)

- Connect indoor unit TB5 and outdoor unit TB3. (Non-polarized 2-wire)
 The "S" on indoor unit TB5 is a shielding wire connection. For specifications about the connecting cables, refer to the outdoor unit installation manual.
- Install a remote controller following the manual supplied with the remote controller.
- Connect the "1" and "2" on indoor unit TB15 to a MA remote controller. (Non-polarized 2-wire)
- Connect the "M1" and "M2" on indoor unit TB5 to a M-NET remote controller. (Non-polarized 2-wire)
- Connect the remote controller's transmission cable within 10 m using a 0.75 mm² core cable. If the distance is more than 10 m, use a 1.25 mm² junction cable.

[Fig. 7.2.1] (P.4) MA Remote controller

[Fig. 7.2.2] (P.4) M-NET Remote controller

- Ⓐ Terminal block for indoor transmission cable
- Ⓑ Terminal block for outdoor transmission cable
- Ⓒ Remote controller

- DC 9 to 13 V between 1 and 2 (MA remote controller)
- DC 24 to 30 V between M1 and M2 (M-NET remote controller)

[Fig. 7.2.3] (P.4) MA Remote controller

[Fig. 7.2.4] (P.4) M-NET Remote controller

- Ⓐ Non-polarized
- Ⓑ TB15
- Ⓒ Remote Controller
- Ⓓ TB5

- The MA remote controller and the M-NET remote controller cannot be used at the same time or interchangeably.

Note:

Ensure that the wiring is not pinched when fitting the terminal box cover. Pinching the wiring may cut it.

⚠ Caution:

Install wiring so that it is not tight and under tension. Wiring under tension may break, or overheat and burn.

- Fix power source wiring to control box by using buffer bushing for tensile force. (PG connection or the like.) Connect transmission wiring to transmission terminal block through the knockout hole of control box using ordinary bushing.
- After wiring is complete, make sure again that there is no slack on the connections, and attach the cover onto the control box in the reverse order removal.

⚠ Caution:

Wire the power supply so that no tension is imparted. Otherwise disconnection, heating or fire result.

Note:

Put the transmission cable earth via the outdoor unit's earth terminal Ⓧ to the ground.

[Constraints on transmission cable]

[Fig. 7.2.5] (P.4)

- Ⓧ Outdoor unit
- Ⓨ Earth
- Ⓩ Indoor unit
- ⓓ Remote controller
- ⓔ Non-polarized 2-wire

7.3. Connecting electrical wires

(Ensure that there is no slack on terminal screws.)

Make sure that the model name in the operation manual attached to the control box cover is the same as that on the rating plate.

- Remove the screw (2pcs) holding the cover to dismount the cover.
- Open knockout holes.
 (Recommend to use a screwdriver or the like for this work.)

[Fig. 7.3.1] (P.4)

- Ⓐ Control box
- Ⓑ Cover
- Ⓒ Screw
- Ⓓ Knockout hole
- Ⓔ Remove

- Fix power source wiring to control box by using buffer bushing for tensile force. (PG connection or the like.) Connect transmission wiring to transmission terminal block through the knockout hole of control box using ordinary bushing.

[Fig. 7.3.2] (P.4)

- Ⓐ Use PG bushing to keep the weight of the cable and external force from being applied to the power supply terminal connector. Use a cable tie to secure the cable.
- Ⓑ Power source wiring
- Ⓒ Tensile force
- Ⓓ Use ordinary bushing
- Ⓔ Transmission wiring

- Connect the power source, Earth, transmission and remote controller wiring.

[Fig. 7.3.3] (P.4)

- Ⓐ Power source terminal block
- Ⓑ Terminal block for indoor transmission
- Ⓒ Terminal block for remote controller
- Ⓓ To 1-phase power source
- Ⓔ Transmission line DC 30 V
- Ⓛ Terminal block for outdoor transmission line (TB3)
- Ⓧ Transmission line to the remote controller, terminal block for indoor unit and BC controller



[Shield wire connection]

[Fig. 7.3.4] (P.4)

- Ⓐ Terminal block
- Ⓑ Round terminal
- Ⓒ Shield wire
- Ⓓ The earth wire from two cables are connected together to the S terminal. (Dead-end connection)
- Ⓔ Insulation tape (To keep the earth wire of the shielded cable from coming in contact with the transmission terminal)

5. After wiring is complete, make sure again that there is no slack on the connections, and attach the cover onto the terminal block box in the reverse order of removal.

Notes:

- Do not pinch the cables or wires when attaching the terminal block box cover. Doing so may cause a risk of disconnection.
- When accommodating the terminal block box, make sure that the connectors on the box side are not removed. If removed, it cannot operate normally.

⚠ Caution:

Fix the electrical wires at site using clamps.

⚠ Caution:

Wire the power supply so that no tension is imparted. Otherwise disconnection, heating or fire may result.

7.4. Selecting the external static pressure

As the factory setting is for use under an external static pressure of 20 Pa, no switch operation is needed when using under the standard condition.

External static pressure	Switch operation
20 Pa	
40 Pa	
60 Pa	

[Fig. 7.4.1] (P.4)

<Address board>

7.5. Setting addresses

(Be sure to operate with the main power turned OFF.)

[Fig. 7.4.1] (P.4)

<Address board>

- There are two types of rotary switch setting available: setting addresses 1 to 9 and over 10, and setting branch numbers.
 - ① How to set addresses
Example: If Address is "3", remain SW12 (for over 10) at "0", and match SW11 (for 1 to 9) with "3".
 - ② How to set branch numbers SW14 (Series R2 only)
The branch number assigned to each indoor unit is the port number of the BC controller to which the indoor unit is connected.
Leave it to "0" on the non-R2 series of units.
- The rotary switches are all set to "0" when shipped from the factory. These switches can be used to set unit addresses and branch numbers at will.
- The determination of indoor unit addresses varies with the system at site. Set them referring to the Data Book.

7.6. Sensing room temperature with the built-in sensor in a remote controller

If you want to sense room temperature with the built-in sensor in a remote controller, set SW1-1 on the control board to "ON". The setting of SW1-7 and SW1-8 as necessary also makes it possible to adjust the air flow at a time when the heating thermometer is OFF.

This product is designed and intended for use in the residential, commercial and light-industrial environment.

The product at hand is based on the following EU regulations:

- Low Voltage Directive 73/23/EEC
- Electromagnetic Compatibility Directive 89/336/EEC

Please be sure to put the contact address/telephone number on this manual before handing it to the customer.