



PFFY-P25VLRMM-E

Indoor Unit

Floor Standing Concealed



A compact concealed unit providing simple, effective air conditioning in perimeter zones. The unit is easy to install and at only 220mm deep offers an unobtrusive method of delivering highly efficient air-conditioning performance.

- **3 Static Pressure settings (20/40/60Pa) - ideal for ducting in the perimeter zone**
- **Concealed unit for hidden installation, ideal for hotels**
- **Reduced noise levels compared to PFFY-P-VLRM-E version**
- **Cooling operation set temperature can be set down to 14°C db when used with R410A**



Pictures not to scale

Product Details

PFFY-P25VLRMM-E	
Capacity (kW):	
Heating (Nominal)	3.2
Cooling (Nominal)	2.8
Heating (UK)	3.0
Cooling (UK)	2.5
R410A High Sensible Cooling (UK)	2.0
SHF R410A (UK)	0.76
SHF High Sensible R410A (UK)	0.8
Power Input (kW) Heating (Nominal)	0.04
Power Input (kW) Cooling (Nominal)	0.04
Airflow(m ³ /min) - Lo-Mi1-Mi2	4.5-5.5-6.5
External Static Pressure Pa - Lo-Mi-Hi	20-40-60
Noise (dBA) - Lo-Mi1-Mi2	31-36-40
Width - mm	886
Depth - mm	220
Height - mm	639
Weight - kg	18.5
Electrical Supply	220-240v, 50Hz
Phase	Single
Mains Cable No. Cores	3
Running Current (A) - Heating	0.34
Running Current (A) - Cooling	0.34
Fuse Rating (BS88) - HRC (A)	6

Dimensions

PFFY-P25VLRMM-E

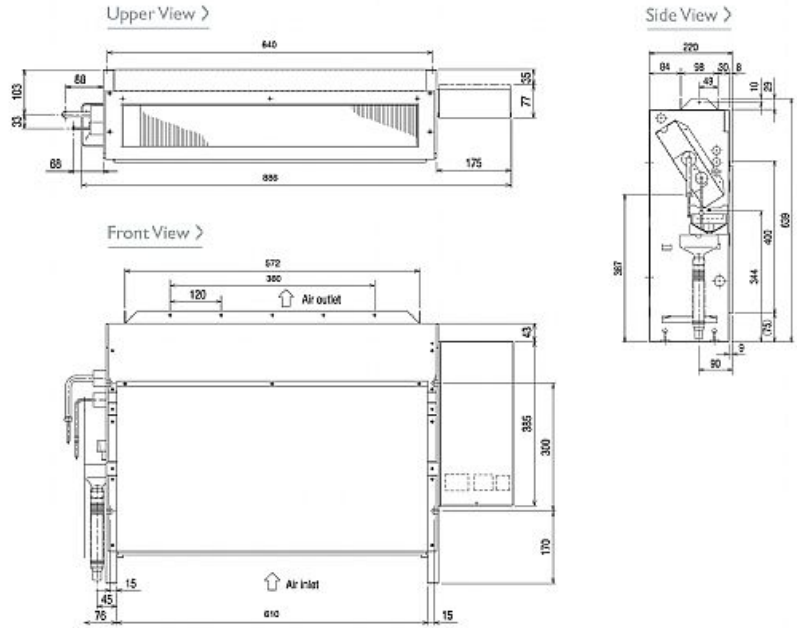

Telephone: 01707 282880

Email: air.conditioning@meuk.mee.com Website: <http://www.mitsubishielectric.co.uk/aircon>

Mitsubishi Electric reserves the right to make any variation in technical specification to the equipment described, or to withdraw or replace products without prior notification or public announcement.

Tel:
Fax:

