

PFFY-P-VKM-E
PFFY-P-VLEM-E
PFFY-P-VLRM-E
PFFY-P-VLRMM-E

1. SPECIFICATIONS	1 - 164
2. EXTERNAL DIMENSIONS	1 - 170
3. CENTER OF GRAVITY	1 - 174
4. ELECTRICAL WIRING DIAGRAMS	1 - 176
5. SOUND LEVELS	
5-1. Sound levels	1 - 179
5-2. NC curves	1 - 179
5-3. Fan characteristics curves	1 - 182
6. TEMPERATURE/AIRFLOW DISTRIBUTIONS	
6-1. Temperature distributions	1 - 185
6-2. Airflow distributions	1 - 186

1. SPECIFICATIONS

R410A Data G8

Model		PFFY-P20VKM-E	PFFY-P25VKM-E	PFFY-P32VKM-E	PFFY-P40VKM-E		
Power source		1-phase 220-230-240V 50Hz					
Cooling capacity (Nominal)	*:1	kW	2.2	2.8	3.6	4.5	
	*:1	kcal / h	1,900	2,400	3,100	3,900	
	*:1	Btu / h	7,500	9,600	12,300	15,400	
	*:2	kcal / h	2,000	2,500	3,200	4,000	
	*:4	Power input	kW	0.025	0.025	0.025	0.028
	*:4	Current input	A	0.20	0.20	0.20	0.24
Heating capacity (Nominal)	*:3	kW	2.5	3.2	4.0	5.0	
	*:3	kcal / h	2,200	2,800	3,400	4,300	
	*:3	Btu / h	8,500	10,900	13,600	17,100	
	*:4	Power input	kW	0.025	0.025	0.025	0.028
	*:4	Current input	A	0.20	0.20	0.20	0.24
External finish		Plastic (Pure White)					
External dimension H x W x D		mm	600 x 700 x 200				
		in.	23-5/8 x 27-9/16 x 7-7/8				
Net weight		kg (lb)	15 (34)				
Heat exchanger		Cross fin (Aluminium fin and copper tube)					
FAN	Type x Quantity		Line flow fan x 2				
	External static press.	Pa	0				
		mmH ₂ O	0				
	Motor type		DC motor				
	Motor output		0.03 x 2				
	Driving mechanism		Direct-drive				
	Airflow rate (Low-Mid-High-SHigh)	m ³ / min	5.9 - 6.8 - 7.6 - 8.7	6.1 - 7.0 - 8.0 - 9.1	6.1 - 7.0 - 8.0 - 9.1	8.0 - 9.0 - 9.5 - 10.7	
L / s		98 - 113 - 127 - 145	102 - 117 - 133 - 152	102 - 117 - 133 - 152	133 - 150 - 158 - 178		
	cfm	208 - 240 - 268 - 307	215 - 247 - 283 - 321	215 - 247 - 283 - 321	283 - 318 - 335 - 378		
Sound pressure level (Low-Mid-High-SHigh) (measured in anechoic room) *:4		dB <A>	27 - 31 - 34 - 37	28 - 32 - 35 - 38	28 - 32 - 35 - 38	35 - 38 - 42 - 44	
Insulation material		Polyethylene sheet					
Air filter		PP honeycomb fabric (Catechin air filter)					
Protection device		Fuse					
Refrigerant control device		LEV					
Connectable outdoor unit		R410A CITY MULTI					
Diameter of refrigerant pipe	Liquid (R410A)	mm (in.)	ø6.35 (ø1/4) Flare				
	Gas (R410A)	mm (in.)	ø12.7 (ø1/2) Flare				
Field drain pipe size		mm (in.)	I.D. 16mm (5/8)				
Drawing	External		IU-BK01-B517				
	Wiring		IU-RG79-V367				
	Refrigerant cycle		-				
Standard attachment	Document		Installation Manual, Instruction Book				
	Accessory						
Remark	Optional parts		-				
	Installation		Details on foundation work, duct work, insulation work, electrical wiring, power source switch, and other items shall be referred to the Installation Manual.				
Note :		*:1 Nominal cooling conditions	*:2 Nominal cooling conditions	*:3 Nominal heating conditions	Unit converter		
Indoor :		27°CDB/19°CWB (81°FDB/66°FWB)	27°CDB/19.5°CWB (81°FDB/67°FWB)	20°CDB (68°FDB)	kcal/h = kW x 860		
Outdoor :		35°CDB (95°FDB)	35°CDB (95°FDB)	7°CDB/6°CWB (45°FDB/43°FWB)	Btu/h = kW x 3,412		
Pipe length :		7.5 m (24-9/16 ft)	5 m (16-3/8 ft)	7.5 m (24-9/16 ft)	cfm = m ³ /min x 35.31		
Level difference :		0 m (0 ft)	0 m (0 ft)	0 m (0 ft)	lb = kg / 0.4536		
* Nominal conditions *:1, *:3 are subject to JIS B8615-1.					*Above specification data is subject to rounding variation.		
* Due to continuing improvement, above specification may be subject to change without notice.							
*:4 The values are measured at the rated external static pressure.							

Ref.: Spec_PFFY-P-VKM-E_1

1. SPECIFICATIONS

R410A Data G8

Model			PFFY-P20VLEM-E	PFFY-P25VLEM-E	PFFY-P32VLEM-E	PFFY-P40VLEM-E	
Power source			1-phase 220-240V 50Hz, 1-phase 208-230V 60Hz				
Cooling capacity (Nominal)	*1	kW	2.2	2.8	3.6	4.5	
		kcal / h	1,900	2,400	3,100	3,900	
		Btu / h	7,500	9,600	12,300	15,400	
	*2	kcal / h	2,000	2,500	3,150	4,000	
		Power input	kW	0.04 / 0.06	0.04 / 0.06	0.06 / 0.07	0.065 / 0.075
*4	Current input	A	0.19 / 0.25	0.19 / 0.25	0.29 / 0.30	0.32 / 0.33	
Heating capacity (Nominal)	*3	kW	2.5	3.2	4.0	5.0	
		kcal / h	2,200	2,800	3,400	4,300	
		Btu / h	8,500	10,900	13,600	17,100	
	*4	Power input	kW	0.04 / 0.06	0.04 / 0.06	0.06 / 0.07	0.065 / 0.075
		Current input	A	0.19 / 0.25	0.19 / 0.25	0.29 / 0.30	0.32 / 0.33
External finish			Acrylic painted, MUNSELL (5Y 8/1)				
External dimension H x W x D		mm	630 x 1,050 x 220	630 x 1,050 x 220	630 x 1,170 x 220	630 x 1,170 x 220	
		in.	24-13/16 x 41-3/8 x 8-11/16	24-13/16 x 41-3/8 x 8-11/16	24-13/16 x 46-1/8 x 8-11/16	24-13/16 x 46-1/8 x 8-11/16	
Net weight		kg (lb)	23 (51)	23 (51)	25 (56)	26 (58)	
Heat exchanger			Cross fin (Aluminium fin and copper tube)				
FAN	Type x Quantity		Sirocco fan x 1	Sirocco fan x 1	Sirocco fan x 2	Sirocco fan x 2	
	External static press.	Pa	0	0	0	0	
		mmHzO	0	0	0	0	
	Motor type		1-phase induction motor				
	Motor output		kW	0.015	0.015	0.018	0.030
	Driving mechanism		Direct-driven by motor				
	Airflow rate (Low-High)	m ³ / min		5.5 - 6.5	5.5 - 6.5	7.0 - 9.0	9.0 - 11.0
L / s		92 - 108	92 - 108	117 - 150	150 - 183		
cfm		194 - 230	194 - 230	247 - 318	318 - 388		
Sound pressure level (Low-High) (measured in anechoic room)	dB <A>		32 - 38 (220V, 50Hz)	32 - 38 (220V, 50Hz)	33 - 38 (220V, 50Hz)	36 - 41 (220V, 50Hz)	
	dB <A>		33 - 39 (230V, 50Hz)	33 - 39 (230V, 50Hz)	34 - 39 (230V, 50Hz)	37 - 42 (230V, 50Hz)	
	*4	dB <A>	34 - 40 (240V, 50Hz)	34 - 40 (240V, 50Hz)	35 - 40 (240V, 50Hz)	38 - 43 (240V, 50Hz)	
Insulation material			Polyethylene foam, Urethane foam				
Air filter			PP honeycomb fabric (washable)				
Protection device			Fuse				
Refrigerant control device			LEV				
Connectable outdoor unit			R410A CITY MULTI				
Diameter of refrigerant pipe	Liquid (R410A)	mm (in.)	ø6.35 (ø1/4) Flare	ø6.35 (ø1/4) Flare	ø6.35 (ø1/4) Flare	ø6.35 (ø1/4) Flare	
		Gas (R410A)	mm (in.)	ø12.7 (ø1/2) Flare	ø12.7 (ø1/2) Flare	ø12.7 (ø1/2) Flare	ø12.7 (ø1/2) Flare
Field drain pipe size		mm (in.)	I.D. 26mm (1)				
Drawing	External		IU-W65-3950				
	Wiring		IU-W65-3960				
	Refrigerant cycle		-				
Standard attachment	Document		Installation Manual, Instruction Book				
	Accessory		Drain hose (O.D.27mm(1-3/32), (End O.D.20mm(13/16))) (flexible joint)				
Remark	Optional parts		-				
	Installation		Details on foundation work, duct work, insulation work, electrical wiring, power source switch, and other items shall be referred to the Installation Manual.				
Note :			*1 Nominal cooling conditions	*2 Nominal cooling conditions	*3 Nominal heating conditions	Unit converter	
			Indoor : 27°CDB/19°CWB (81°FDB/66°FWB)	27°CDB/19.5°CWB (81°FDB/67°FWB)	20°CDB (68°FDB)	kcal/h = kW x 860	
			Outdoor : 35°CDB (95°FDB)	35°CDB (95°FDB)	7°CDB/6°CWB (45°FDB/43°FWB)	Btu/h = kW x 3,412	
			Pipe length : 7.5 m (24-9/16 ft)	5 m (16-3/8 ft)	7.5 m (24-9/16 ft)	cfm = m ³ /min x 35.31	
			Level difference : 0 m (0 ft)	0 m (0 ft)	0 m (0 ft)	lb = kg / 0.4536	
			* Nominal conditions *1, *3 are subject to JIS B8615-1.			*Above specification data is subject to rounding variation.	
			* Due to continuing improvement, above specification may be subject to change without notice.				
			*4 The values are measured at the rated external static pressure.				

Ref.: Spec_PFFY-P-VLE(R)M-E_1

PFFY

1. SPECIFICATIONS

R410A Data G8

Model			PFFY-P50VLEM-E	PFFY-P63VLEM-E	PFFY-P20VLRM-E	PFFY-P25VLRM-E				
Power source			1-phase 220-240V 50Hz, 1-phase 208-230V 60Hz							
Cooling capacity (Nominal)	*1	kW	5.6	7.1	2.2	2.8				
	*1	kcal / h	4,800	6,100	1,900	2,400				
	*1	Btu / h	19,100	24,200	7,500	9,600				
	*2	kcal / h	5,000	6,300	2,000	2,500				
	*4	Power input	kW	0.085 / 0.09	0.1 / 0.11	0.04 / 0.06	0.04 / 0.06			
	*4	Current input	A	0.40 / 0.41	0.46 / 0.47	0.19 / 0.25	0.19 / 0.25			
Heating capacity (Nominal)	*3	kW	6.3	8.0	2.5	3.2				
	*3	kcal / h	5,400	6,900	2,200	2,800				
	*3	Btu / h	21,500	27,300	8,500	10,900				
	*4	Power input	kW	0.085 / 0.09	0.1 / 0.11	0.04 / 0.06	0.04 / 0.06			
	*4	Current input	A	0.40 / 0.41	0.46 / 0.47	0.19 / 0.25	0.19 / 0.25			
External finish			Acrylic painted, MUNSELL (5Y 8/1)		Galvanized					
External dimension H x W x D		mm	630 x 1,410 x 220	630 x 1,410 x 220	639 x 886 x 220	639 x 886 x 220				
		in.	24-13/16 x 55-9/16 x 8-11/16	24-13/16 x 55-9/16 x 8-11/16	25-3/16 x 34-15/16 x 8-11/16	25-3/16 x 34-15/16 x 8-11/16				
Net weight		kg (lb)	30 (67)	32 (71)	18.5 (41)	18.5 (41)				
Heat exchanger			Cross fin (Aluminium fin and copper tube)							
FAN	Type x Quantity		Sirocco fan x 2	Sirocco fan x 2	Sirocco fan x 1	Sirocco fan x 1				
	External static press.	Pa	0	0	0	0				
		mmH ₂ O	0	0	0	0				
	Motor type		1-phase induction motor							
	Motor output		kW	0.035	0.050	0.015	0.015			
	Driving mechanism		Direct-driven by motor							
	Airflow rate (Low-High)	m ³ / min		12.0 - 14.0	12.0 - 15.5	5.5 - 6.5	5.5 - 6.5			
L / s		200 - 233	200 - 258	92 - 108	92 - 108					
cfm		424 - 494	424 - 547	194 - 230	194 - 230					
Sound pressure level (Low-High) (measured in anechoic room)	dB <A>		36 - 41 (220V, 50Hz)	38 - 44 (220V, 50Hz)	32 - 38 (220V, 50Hz)	32 - 38 (220V, 50Hz)				
	dB <A>		37 - 42 (230V, 50Hz)	39 - 45 (230V, 50Hz)	33 - 39 (230V, 50Hz)	33 - 39 (230V, 50Hz)				
	*4 dB <A>		38 - 43 (240V, 50Hz)	40 - 46 (240V, 50Hz)	34 - 40 (240V, 50Hz)	34 - 40 (240V, 50Hz)				
Insulation material			Polyethylene foam, Urethane foam							
Air filter			PP honeycomb fabric (washable)							
Protection device			Fuse							
Refrigerant control device			LEV							
Connectable outdoor unit			R410A CITY MULTI							
Diameter of refrigerant pipe	Liquid (R410A)	mm (in.)	ø6.35 (ø1/4) Flare	ø9.52 (ø3/8) Flare	ø6.35 (ø1/4) Flare	ø6.35 (ø1/4) Flare				
	Gas (R410A)	mm (in.)	ø12.7 (ø1/2) Flare	ø15.88 (ø5/8) Flare	ø12.7 (ø1/2) Flare	ø12.7 (ø1/2) Flare				
Field drain pipe size		mm (in.)	I.D. 26mm (1)							
Drawing	External		IU-W65-3950	IU-W65-3950	IU-W65-3951	IU-W65-3951				
	Wiring		IU-W65-3960	IU-W65-3960	IU-W65-3960	IU-W65-3960				
	Refrigerant cycle		-	-	-	-				
Standard attachment	Document		Installation Manual, Instruction Book							
	Accessory		Drain hose (O.D.27mm(1-3/32), (End O.D.20mm(13/16))) (flexible joint)							
Remark	Optional parts		-							
	Installation		Details on foundation work, duct work, insulation work, electrical wiring, power source switch, and other items shall be referred to the Installation Manual.							
Note : <table border="0" style="width:100%; border-collapse: collapse;"> <tr> <td style="width:25%; vertical-align: top;"> *1 Nominal cooling conditions Indoor : 27°CDB/19°CWB (81°FDB/66°FWB) Outdoor : 35°CDB (95°FDB) Pipe length : 7.5 m (24-9/16 ft) Level difference : 0 m (0 ft) </td> <td style="width:25%; vertical-align: top;"> *2 Nominal cooling conditions 27°CDB/19.5°CWB (81°FDB/67°FWB) 35°CDB (95°FDB) 5 m (16-3/8 ft) 0 m (0 ft) </td> <td style="width:25%; vertical-align: top;"> *3 Nominal heating conditions 20°CDB (68°FDB) 7°CDB/6°CWB (45°FDB/43°FWB) 7.5 m (24-9/16 ft) 0 m (0 ft) </td> <td style="width:25%; vertical-align: top;"> Unit converter kcal/h = kW x 860 Btu/h = kW x 3,412 cfm = m³/min x 35.31 lb = kg / 0.4536 </td> </tr> </table>							*1 Nominal cooling conditions Indoor : 27°CDB/19°CWB (81°FDB/66°FWB) Outdoor : 35°CDB (95°FDB) Pipe length : 7.5 m (24-9/16 ft) Level difference : 0 m (0 ft)	*2 Nominal cooling conditions 27°CDB/19.5°CWB (81°FDB/67°FWB) 35°CDB (95°FDB) 5 m (16-3/8 ft) 0 m (0 ft)	*3 Nominal heating conditions 20°CDB (68°FDB) 7°CDB/6°CWB (45°FDB/43°FWB) 7.5 m (24-9/16 ft) 0 m (0 ft)	Unit converter kcal/h = kW x 860 Btu/h = kW x 3,412 cfm = m ³ /min x 35.31 lb = kg / 0.4536
*1 Nominal cooling conditions Indoor : 27°CDB/19°CWB (81°FDB/66°FWB) Outdoor : 35°CDB (95°FDB) Pipe length : 7.5 m (24-9/16 ft) Level difference : 0 m (0 ft)	*2 Nominal cooling conditions 27°CDB/19.5°CWB (81°FDB/67°FWB) 35°CDB (95°FDB) 5 m (16-3/8 ft) 0 m (0 ft)	*3 Nominal heating conditions 20°CDB (68°FDB) 7°CDB/6°CWB (45°FDB/43°FWB) 7.5 m (24-9/16 ft) 0 m (0 ft)	Unit converter kcal/h = kW x 860 Btu/h = kW x 3,412 cfm = m ³ /min x 35.31 lb = kg / 0.4536							
* Nominal conditions *1, *3 are subject to JIS B8615-1. * Due to continuing improvement, above specification may be subject to change without notice. *4 The values are measured at the rated external static pressure. *Above specification data is subject to rounding variation.										

Ref.: Spec_PFFY-P-VLE(R)M-E_2

1. SPECIFICATIONS

R410A Data G8

Model			PFFY-P32VLRM-E	PFFY-P40VLRM-E	PFFY-P50VLRM-E	PFFY-P63VLRM-E	
Power source			1-phase 220-240V 50Hz, 1-phase 208-230V 60Hz				
Cooling capacity (Nominal)	*1	kW	3.6	4.5	5.6	7.1	
		kcal / h	3,100	3,900	4,800	6,100	
		Btu / h	12,300	15,400	19,100	24,200	
	*2	kcal / h	3,150	4,000	5,000	6,300	
		Power input	kW	0.06 / 0.07	0.065 / 0.075	0.085 / 0.09	0.1 / 0.11
*4	Current input	A	0.29 / 0.30	0.32 / 0.33	0.40 / 0.41	0.46 / 0.47	
Heating capacity (Nominal)	*3	kW	4.0	5.0	6.3	8.0	
		kcal / h	3,400	4,300	5,400	6,900	
		Btu / h	13,600	17,100	21,500	27,300	
	*4	Power input	kW	0.06 / 0.07	0.065 / 0.075	0.085 / 0.09	0.1 / 0.11
		Current input	A	0.29 / 0.30	0.32 / 0.33	0.40 / 0.41	0.46 / 0.47
External finish			Galvanized				
External dimension H x W x D		mm	639 x 1,006 x 220	639 x 1,006 x 220	639 x 1,246 x 220	639 x 1,246 x 220	
		in.	25-3/16 x 39-5/8 x 8-11/16	25-3/16 x 39-5/8 x 8-11/16	25-3/16 x 49-1/16 x 8-11/16	25-3/16 x 49-1/16 x 8-11/16	
Net weight		kg (lb)	20 (45)	21 (47)	25 (56)	27 (60)	
Heat exchanger			Cross fin (Aluminium fin and copper tube)				
FAN	Type x Quantity		Sirocco fan x 2	Sirocco fan x 2	Sirocco fan x 2	Sirocco fan x 2	
	External static press.	Pa	0	0	0	0	
		mmHzO	0	0	0	0	
	Motor type		1-phase induction motor				
	Motor output		kW	0.018	0.030	0.035	0.050
	Driving mechanism		Direct-driven by motor				
	Airflow rate (Low-High)	m ³ / min	7.0 - 9.0	9.0 - 11.0	12.0 - 14.0	12.0 - 15.5	
		L / s	117 - 150	150 - 183	200 - 233	200 - 258	
cfm		247 - 318	318 - 388	424 - 494	424 - 547		
Sound pressure level (Low-High) (measured in anechoic room)	dB <A>	33 - 38 (220V, 50Hz)	36 - 41 (220V, 50Hz)	36 - 41 (220V, 50Hz)	38 - 44 (220V, 50Hz)		
		34 - 39 (230V, 50Hz)	37 - 42 (230V, 50Hz)	37 - 42 (230V, 50Hz)	39 - 45 (230V, 50Hz)		
	*4 dB <A>	35 - 40 (240V, 50Hz)	38 - 43 (240V, 50Hz)	38 - 43 (240V, 50Hz)	40 - 46 (240V, 50Hz)		
Insulation material			Polyethylene foam, Urethane foam				
Air filter			PP honeycomb fabric (washable)				
Protection device			Fuse				
Refrigerant control device			LEV				
Connectable outdoor unit			R410A CITY MULTI				
Diameter of refrigerant pipe	Liquid (R410A)	mm (in.)	ø6.35 (ø1/4) Flare	ø6.35 (ø1/4) Flare	ø6.35 (ø1/4) Flare	ø9.52 (ø3/8) Flare	
		Gas (R410A)	mm (in.)	ø12.7 (ø1/2) Flare	ø12.7 (ø1/2) Flare	ø12.7 (ø1/2) Flare	ø15.88 (ø5/8) Flare
Field drain pipe size		mm (in.)	I.D. 26mm (1)				
Drawing	External		IU-W65-3951				
	Wiring		IU-W65-3960				
	Refrigerant cycle		-				
Standard attachment	Document		Installation Manual, Instruction Book				
	Accessory		Drain hose (O.D.27mm(1-3/32), (End O.D.20mm(13/16))) (flexible joint)				
Remark	Optional parts		-				
	Installation		Details on foundation work, duct work, insulation work, electrical wiring, power source switch, and other items shall be referred to the Installation Manual.				
Note :			*1 Nominal cooling conditions	*2 Nominal cooling conditions	*3 Nominal heating conditions	Unit converter	
			Indoor : 27°CDB/19°CWB (81°FDB/66°FWB)	27°CDB/19.5°CWB (81°FDB/67°FWB)	20°CDB (68°FDB)	kcal/h = kW x 860	
			Outdoor : 35°CDB (95°FDB)	35°CDB (95°FDB)	7°CDB/6°CWB (45°FDB/43°FWB)	Btu/h = kW x 3,412	
			Pipe length : 7.5 m (24-9/16 ft)	5 m (16-3/8 ft)	7.5 m (24-9/16 ft)	cfm = m ³ /min x 35.31	
			Level difference : 0 m (0 ft)	0 m (0 ft)	0 m (0 ft)	lb = kg / 0.4536	
			* Nominal conditions *1, *3 are subject to JIS B8615-1.			*Above specification data is subject to rounding variation.	
			* Due to continuing improvement, above specification may be subject to change without notice.				
			*4 The values are measured at the rated external static pressure.				

Ref.: Spec_PFFY-P-VLE(R)M-E_3

PFFY

1. SPECIFICATIONS

R410A Data G8

Model		PFFY-P20VLRMM-E	PFFY-P25VLRMM-E	PFFY-P32VLRMM-E	PFFY-P40VLRMM-E		
Power source		1-phase 220-240V (50/60Hz)					
Cooling capacity (Nominal)	*:1	kW	2.2	2.8	3.6	4.5	
	*:1	kcal / h	1,900	2,400	3,100	3,900	
	*:1	Btu / h	7,500	9,600	12,300	15,400	
	*:2	kcal / h	2,000	2,500	3,150	4,000	
	*:4	Power input	kW	0.04	0.04	0.04	0.05
	*:4	Current input	A	0.34	0.38	0.43	
Heating capacity (Nominal)	*:3	kW	2.5	3.2	4.0	5.0	
	*:3	kcal / h	2,200	2,800	3,400	4,300	
	*:3	Btu / h	8,500	10,900	13,600	17,100	
	*:4	Power input	kW	0.04	0.04	0.04	0.05
	*:4	Current input	A	0.34	0.34	0.38	0.43
External finish		Galvanized steel plate					
External dimension H x W x D		mm	639 x 886 x 220	639 x 886 x 220	639 x 1006 x 220	639 x 1006 x 220	
		in.	25-3/16 x 34-15/16 x 8-11/16	25-3/16 x 34-15/16 x 8-11/16	25-3/16 x 39-5/8 x 8-11/16	25-3/16 x 39-5/8 x 8-11/16	
Net weight		kg (lb)	18.5 (41)	18.5 (41)	20 (45)	21(47)	
Heat exchanger		Cross fin (Aluminium fin and copper tube)					
FAN	Type x Quantity		Sirocco fan x 1	Sirocco fan x 1	Sirocco fan x 2	Sirocco fan x 2	
	External static press.	Pa	20 - <40> - <60>	20 - <40> - <60>	20 - <40> - <60>	20 - <40> - <60>	
		mmH ₂ O	2.0 - <4.1> - <6.1>	2.0 - <4.1> - <6.1>	2.0 - <4.1> - <6.1>	2.0 - <4.1> - <6.1>	
	Motor type		DC blushless motor				
	Motor output		kW	0.096	0.096	0.096	0.096
	Driving mechanism		Direct-driven				
	Airflow rate (Low-Mid-High)	m ³ / min		4.5 - 5.5 - 6.5	4.5 - 5.5 - 6.5	6.5 - 7.5 - 9.0	8.0 - 9.5 - 11.0
		L / s		75 - 92 - 108	75 - 92 - 108	108 - 125 - 150	133 - 158 - 183
cfm		159 - 194 - 230	159 - 194 - 230	230 - 265 - 318	283 - 335 - 388		
Sound pressure level (Low-Mid-High) (measured in anechoic room)	dB <A>		31 - 36 - 40 (20Pa)	31 - 36 - 40 (20Pa)	27 - 32 - 37 (20Pa)	30 - 36 - 40 (20Pa)	
	dB <A>		34 - 39 - 42 (40Pa)	34 - 39 - 42 (40Pa)	30 - 35 - 41 (40Pa)	32 - 38 - 42 (40Pa)	
	dB <A>		35 - 40 - 43 (60Pa)	35 - 40 - 43 (60Pa)	32 - 37 - 42 (60Pa)	35 - 39 - 44 (60Pa)	
Insulation material		Polyethylene foam, Urethane foam					
Air filter		PP honeycomb fabric (washable)					
Protection device		Fuse					
Refrigerant control device		LEV					
Connectable outdoor unit		R410A CITY MULTI					
Diameter of refrigerant pipe	Liquid (R410A)	mm (in.)	ø6.35 (ø1/4) Brazed	ø6.35 (ø1/4) Brazed	ø6.35 (ø1/4) Brazed	ø6.35 (ø1/4) Brazed	
	Gas (R410A)	mm (in.)	ø12.7 (ø1/2) Brazed	ø12.7 (ø1/2) Brazed	ø12.7 (ø1/2) Brazed	ø12.7 (ø1/2) Brazed	
Field drain pipe size		mm (in.)	I.D. 26mm (1)<Accessory hose O.D.27mm(top end:O.D.20mm)>				
Drawing	External		IU-KB94-L081	IU-KB94-L081	IU-KB94-L081	IU-KB94-L081	
	Wiring		IU-KB94-G985	IU-KB94-G985	IU-KB94-G985	IU-KB94-G985	
	Refrigerant cycle		-	-	-	-	
Standard attachment	Document		Installation Manual, Instruction Book				
	Accessory		Screw plate, Level adjusting screw, Strainer, Drain hose (flexible joint), Hose band				
Remark	Optional parts		-				
	Installation		Details on foundation work, duct work, insulation work, electrical wiring, power source switch, and other items shall be referred to the Installation Manual.				
Note :		*:1 Nominal cooling conditions	*:2 Nominal cooling conditions	*:3 Nominal heating conditions	Unit converter		
		Indoor : 27°CDB/19°CWB (81°FDB/66°FWB)	27°CDB/19.5°CWB (81°FDB/67°FWB)	20°CDB (68°FDB)	kcal/h = kW x 860		
		Outdoor : 35°CDB (95°FDB)	35°CDB (95°FDB)	7°CDB/6°CWB (45°FDB/43°FWB)	Btu/h = kW x 3,412		
		Pipe length : 7.5 m (24-9/16 ft)	5 m (16-3/8 ft)	7.5 m (24-9/16 ft)	cfm = m ³ /min x 35.31		
		Level difference : 0 m (0 ft)	0 m (0 ft)	0 m (0 ft)	lb = kg / 0.4536		
		* Nominal conditions *:1, *:3 are subject to JIS B8615-1.				*Above specification data is subject to rounding variation.	
		* Due to continuing improvement, above specification may be subject to change without notice.					
		*:4 The values are measured at the rated external static pressure.					

Ref.: Spec_PFFY-P-VLRMM-E_1

1. SPECIFICATIONS

R410A Data G8

Model			PFFY-P50VLRMM-E	PFFY-P63VLRMM-E						
Power source			1-phase 220-240V (50/60Hz)							
Cooling capacity (Nominal)	*1	kW	5.6	7.1						
		kcal / h	4,800	6,100						
		Btu / h	19,100	24,200						
	*2	kcal / h	5,000	6,300						
		Power input	kW	0.05	0.07					
*4	Current input	A	0.48	0.59						
Heating capacity (Nominal)	*3	kW	6.3	8.0						
		kcal / h	5,400	6,900						
		Btu / h	21,500	27,300						
	*4	Power input	kW	0.05	0.07					
		Current input	A	0.48	0.59					
External finish			Galvanized steel plate							
External dimension H x W x D		mm	639 x 1246 x 220	639 x 1246 x 220						
		in.	25-3/16 x 49-1/16 x 8-11/16	25-3/16 x 49-1/16 x 8-11/16						
Net weight		kg (lb)	25 (56)	27 (60)						
Heat exchanger			Cross fin (Aluminium fin and copper tube)							
FAN	Type x Quantity		Sirocco fan x 2	Sirocco fan x 2						
	External static press.	Pa	20 - <40> - <60>	20 - <40> - <60>						
		mmH ₂ O	2.0 - <4.1> - <6.1>	2.0 - <4.1> - <6.1>						
	Motor type		DC brushless motor							
	Motor output		kW	0.096	0.096					
	Driving mechanism		Direct-driven							
	Airflow rate (Low-Mid-High)	m ³ / min		10.0 - 12.0 - 14.0	11.0 - 13.0-15.5					
L / s		167 - 200 - 233	183 - 217 - 258							
cfm		353 - 424 - 494	388 - 459 - 547							
Sound pressure level (Low-Mid-High) (measured in anechoic room)	*4	dB <A>	32 - 37 - 41 (20Pa)	35 - 40 - 44 (20Pa)						
		dB <A>	35 - 40 - 44 (40Pa)	36 - 42 - 47 (40Pa)						
	dB <A>	36 - 41 - 45 (60Pa)	38 - 43 - 48 (60Pa)							
Insulation material			Polyethylene foam, Urethane foam							
Air filter			PP honeycomb fabric (washable)							
Protection device			Fuse							
Refrigerant control device			LEV							
Connectable outdoor unit			R410A CITY MULTI							
Diameter of refrigerant pipe	Liquid (R410A)	mm (in.)	ø6.35 (ø1/4) Brazed	ø9.52 (ø3/8) Brazed						
	Gas (R410A)	mm (in.)	ø12.7 (ø1/2) Brazed	ø15.88 (ø5/8) Brazed						
Field drain pipe size		mm (in.)	I.D. 26mm (1)<Accessory hose O.D.27mm(top end:O.D.20mm)>							
Drawing	External		IU-KB94-L081	IU-KB94-L081						
	Wiring		IU-KB94-G985	IU-KB94-G985						
	Refrigerant cycle		-	-						
Standard attachment	Document		Installation Manual, Instruction Book							
	Accessory		Screw plate, Level adjusting screw, Strainer, Drain hose (flexible joint), Hose band							
Remark	Optional parts		-							
	Installation		Details on foundation work, duct work, insulation work, electrical wiring, power source switch, and other items shall be referred to the Installation Manual.							
Note : <table border="0" style="width:100%; border-collapse: collapse;"> <tr> <td style="width:33%; vertical-align: top;"> *1 Nominal cooling conditions Indoor : 27°CDB/19°CWB (81°FDB/66°FWB) Outdoor : 35°CDB (95°FDB) Pipe length : 7.5 m (24-9/16 ft) Level difference : 0 m (0 ft) </td> <td style="width:33%; vertical-align: top;"> *2 Nominal cooling conditions 27°CDB/19.5°CWB (81°FDB/67°FWB) 35°CDB (95°FDB) 5 m (16-3/8 ft) 0 m (0 ft) </td> <td style="width:33%; vertical-align: top;"> *3 Nominal heating conditions 20°CDB (68°FDB) 7°CDB/6°CWB (45°FDB/43°FWB) 7.5 m (24-9/16 ft) 0 m (0 ft) </td> <td style="width:15%; vertical-align: top;"> Unit converter kcal/h = kW x 860 Btu/h = kW x 3,412 cfm = m³/min x 35.31 lb = kg / 0.4536 </td> </tr> </table> <p>* Nominal conditions *1, *3 are subject to JIS B8615-1. * Due to continuing improvement, above specification may be subject to change without notice. *4 The values are measured at the rated external static pressure.</p>							*1 Nominal cooling conditions Indoor : 27°CDB/19°CWB (81°FDB/66°FWB) Outdoor : 35°CDB (95°FDB) Pipe length : 7.5 m (24-9/16 ft) Level difference : 0 m (0 ft)	*2 Nominal cooling conditions 27°CDB/19.5°CWB (81°FDB/67°FWB) 35°CDB (95°FDB) 5 m (16-3/8 ft) 0 m (0 ft)	*3 Nominal heating conditions 20°CDB (68°FDB) 7°CDB/6°CWB (45°FDB/43°FWB) 7.5 m (24-9/16 ft) 0 m (0 ft)	Unit converter kcal/h = kW x 860 Btu/h = kW x 3,412 cfm = m ³ /min x 35.31 lb = kg / 0.4536
*1 Nominal cooling conditions Indoor : 27°CDB/19°CWB (81°FDB/66°FWB) Outdoor : 35°CDB (95°FDB) Pipe length : 7.5 m (24-9/16 ft) Level difference : 0 m (0 ft)	*2 Nominal cooling conditions 27°CDB/19.5°CWB (81°FDB/67°FWB) 35°CDB (95°FDB) 5 m (16-3/8 ft) 0 m (0 ft)	*3 Nominal heating conditions 20°CDB (68°FDB) 7°CDB/6°CWB (45°FDB/43°FWB) 7.5 m (24-9/16 ft) 0 m (0 ft)	Unit converter kcal/h = kW x 860 Btu/h = kW x 3,412 cfm = m ³ /min x 35.31 lb = kg / 0.4536							

PFFY

Ref.: Spec_PFFY-P-VLRMM-E_2

2. EXTERNAL DIMENSIONS

R410A Data G8

PFFY-P20,25,32,40VKM-E

Drw. : IU-BK01-B517
Unit : mm

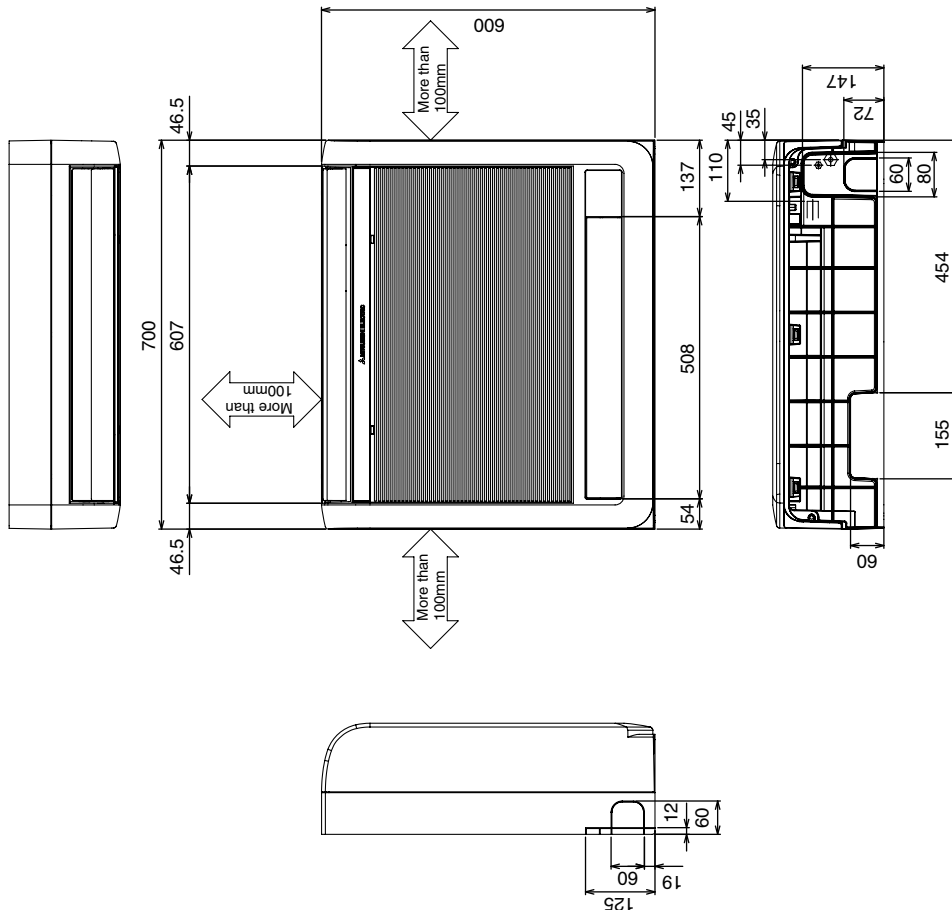
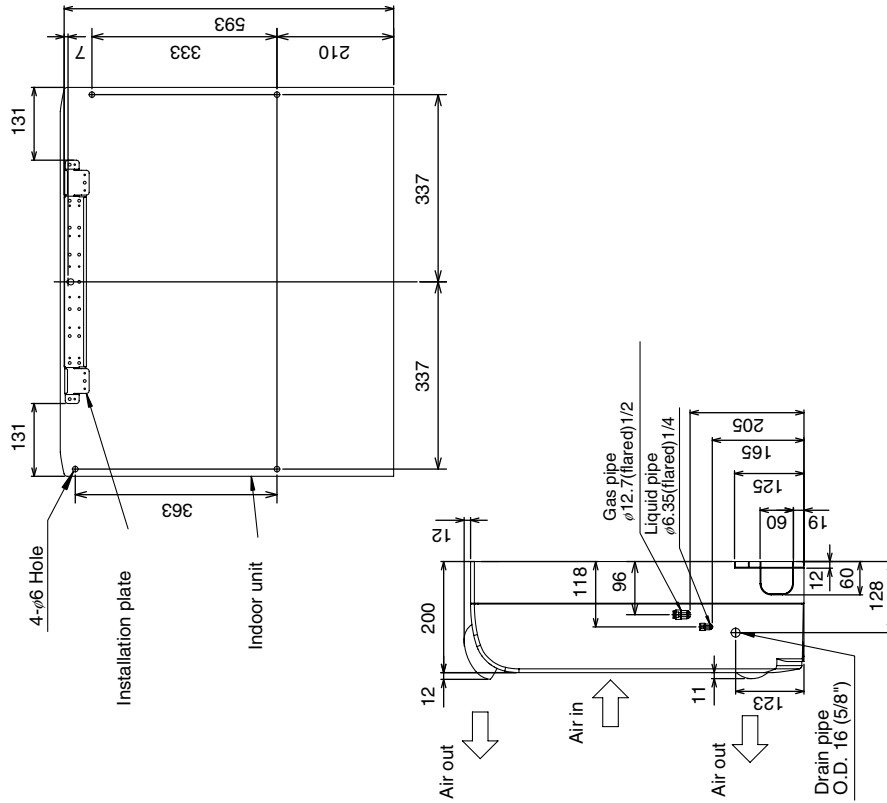

PFFY

2. EXTERNAL DIMENSIONS

PFFY-P20,25,32,40,50,63VLEM-E

Draw : IU-W65-3950
Unit : mm

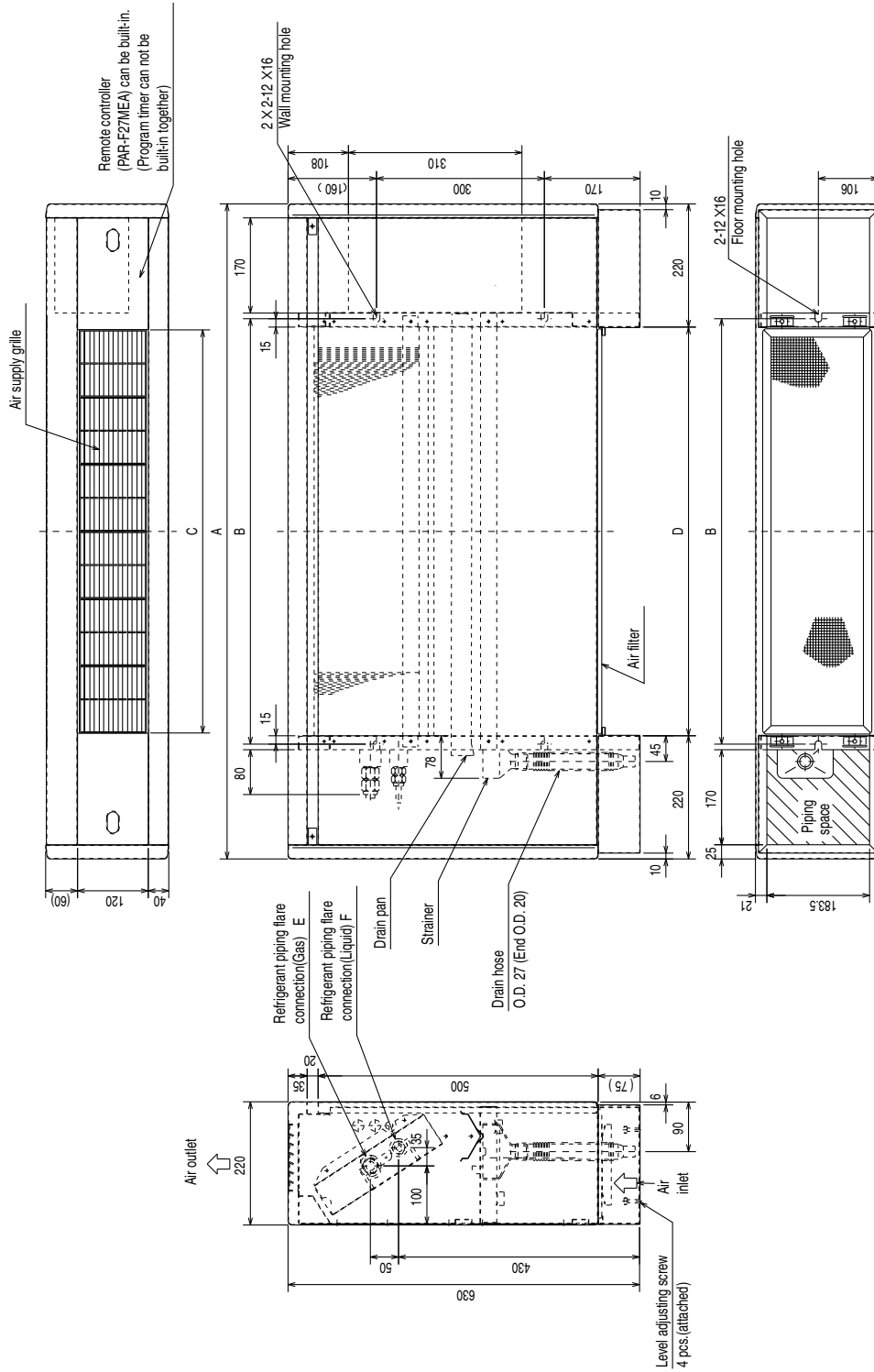

Dimensions

Model	A	B	C	D	E (Gas)	F (Liquid)
PFFY-P20VLEM-E	1050	640	600	610	φ12.7	φ6.35
PFFY-P25VLEM-E	1050	640	600	610	φ12.7	φ6.35
PFFY-P32VLEM-E	1170	760	720	730	φ12.7	φ6.35
PFFY-P40VLEM-E	1170	760	720	730	φ12.7	φ6.35
PFFY-P50VLEM-E	1410	1000	960	970	φ12.7	φ6.35
PFFY-P63VLEM-E	1410	1000	960	970	φ15.88	φ9.52

PFFY

PFFY-P20,25,32,40,50,63VLRM-E

Draw. : IU-W65-3951
Unit : mm

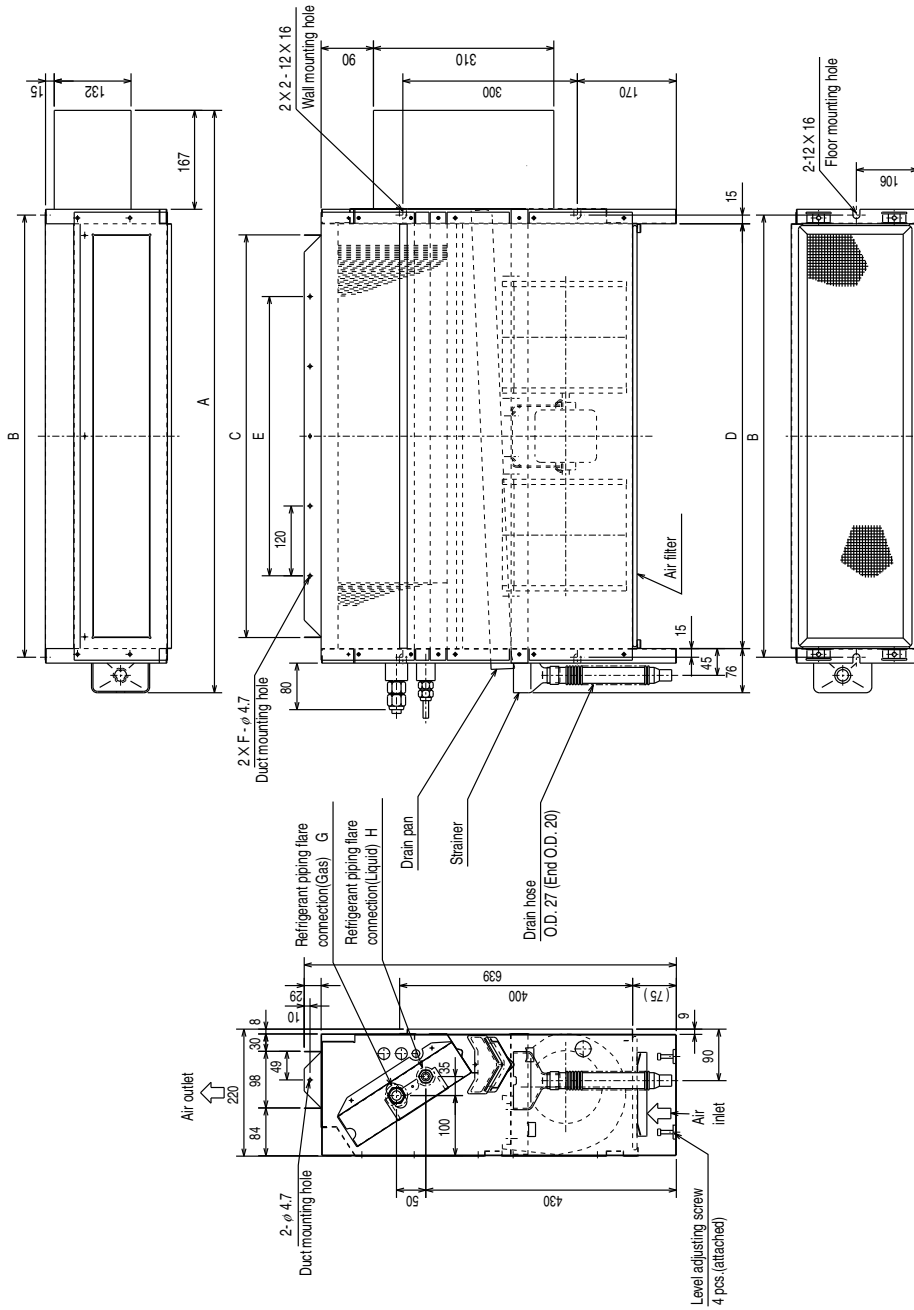

Dimensions

Model	A	B	C	D	E	F	G (Gas)	H (Liquid)
PFFY-P20VLRM-E	886	640	572	610	360	4	φ12.7	φ6.35
PFFY-P25VLRM-E	886	640	572	610	360	4	φ12.7	φ6.35
PFFY-P32VLRM-E	1006	760	692	730	480	5	φ12.7	φ6.35
PFFY-P40VLRM-E	1006	760	692	730	480	5	φ12.7	φ6.35
PFFY-P50VLRM-E	1246	1000	932	970	720	7	φ12.7	φ6.35
PFFY-P63VLRM-E	1246	1000	932	970	720	7	φ15.88	φ9.52

2. EXTERNAL DIMENSIONS

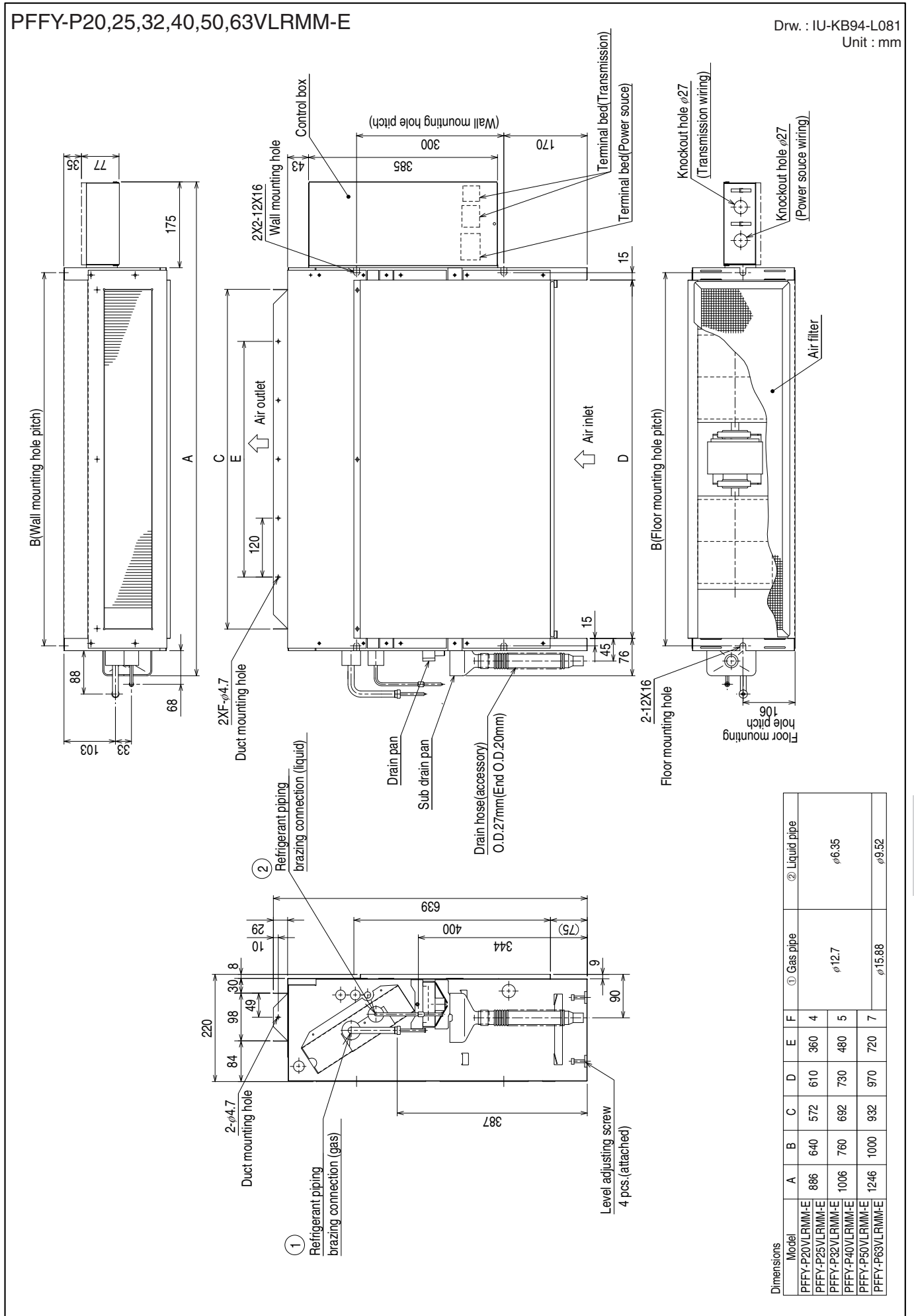

PFFY

PFFY-P20,25,32,40VKM-E

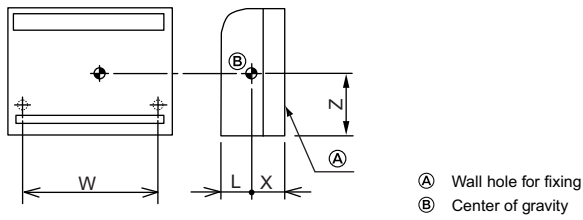

(mm)[in]

Model name	W	L	X	Z
PFFY-P20VKM-E	674 [26-9/16]	85 [3-3/8]	115 [4-9/16]	330 [13]
PFFY-P25VKM-E	674 [26-9/16]	85 [3-3/8]	115 [4-9/16]	330 [13]
PFFY-P32VKM-E	674 [26-9/16]	85 [3-3/8]	115 [4-9/16]	330 [13]
PFFY-P40VKM-E	674 [26-9/16]	85 [3-3/8]	115 [4-9/16]	330 [13]

PFFY-P20,25,32,40,50,63VLEM-E

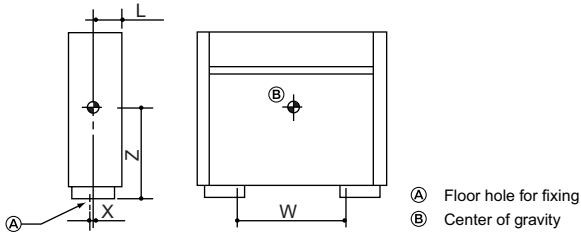

(mm)[in]

Model name	W	L	X	Z
PFFY-P20VLEM-E	640 [25-1/4]	100 [3-15/16]	17 [11/16]	335 [13-1/4]
PFFY-P25VLEM-E	640 [25-1/4]	100 [3-15/16]	17 [11/16]	335 [13-1/4]
PFFY-P32VLEM-E	760 [29-15/16]	100 [3-15/16]	17 [11/16]	335 [13-1/4]
PFFY-P40VLEM-E	760 [29-15/16]	100 [3-15/16]	17 [11/16]	335 [13-1/4]
PFFY-P50VLEM-E	1000 [39-3/8]	100 [3-15/16]	17 [11/16]	335 [13-1/4]
PFFY-P63VLEM-E	1000 [39-3/8]	100 [3-15/16]	17 [11/16]	335 [13-1/4]

PFFY-P20,25,32,40,50,63VLRM-E

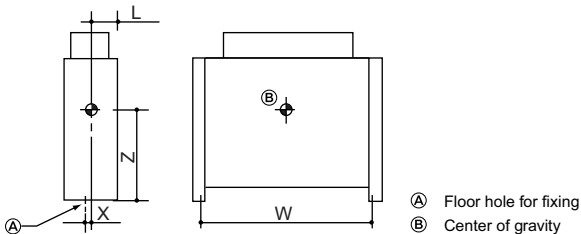

(mm)[in]

Model name	W	L	X	Z
PFFY-P20VLRM-E	640 [25-1/4]	100 [3-15/16]	17 [11/16]	335 [13-1/4]
PFFY-P25VLRM-E	640 [25-1/4]	100 [3-15/16]	17 [11/16]	335 [13-1/4]
PFFY-P32VLRM-E	760 [29-15/16]	100 [3-15/16]	17 [11/16]	335 [13-1/4]
PFFY-P40VLRM-E	760 [29-15/16]	100 [3-15/16]	17 [11/16]	335 [13-1/4]
PFFY-P50VLRM-E	1000 [39-3/8]	100 [3-15/16]	17 [11/16]	335 [13-1/4]
PFFY-P63VLRM-E	1000 [39-3/8]	100 [3-15/16]	17 [11/16]	335 [13-1/4]

PFFY-P20,25,32,40,50,63VLRMM-E

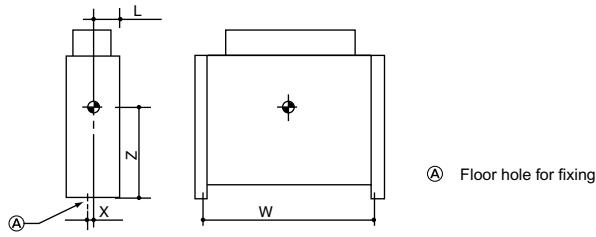

(mm)[in]

Model name	W	L	X	Z
PFFY-P20VLRMM-E	640 [25-1/4]	100 [3-15/16]	17 [11/16]	335 [13-1/4]
PFFY-P25VLRMM-E	640 [25-1/4]	100 [3-15/16]	17 [11/16]	335 [13-1/4]
PFFY-P32VLRMM-E	760 [29-15/16]	100 [3-15/16]	17 [11/16]	335 [13-1/4]
PFFY-P40VLRMM-E	760 [29-15/16]	100 [3-15/16]	17 [11/16]	335 [13-1/4]
PFFY-P50VLRMM-E	1000 [39-3/8]	100 [3-15/16]	17 [11/16]	335 [13-1/4]
PFFY-P63VLRMM-E	1000 [39-3/8]	100 [3-15/16]	17 [11/16]	335 [13-1/4]

PFFY-P20,25,32,40VKM-E

Drw. : IU-RG79-V367

[LEGEND]

SYMBOL	NAME	SYMBOL	NAME	SYMBOL	NAME	
I. B	INDOOR CONTROLLER BOARD	MF1	FAN MOTOR (UPPER)	TH23	PIPE TEMP. DETECTION/GAS (0°C/15kΩ, 25°C/5.4kΩ)	
CN32	CONNECTOR	MF2	FAN MOTOR (LOWER)	A. B		ADDRESS BOARD
CN51	CENTRALLY CONTROL	MV1	VANE MOTOR	SW1	SWITCH	MODE SELECTION
CN52		MV2	DAMPER MOTOR	SW11	SW11	ADDRESS SETTING 1ST DIGIT
SW2	SWITCH	LS	DAMPER LIMIT SWITCH (CLOSE)	SW12	SW12	ADDRESS SETTING 2ND DIGIT
SW3	MODE SELECTION	LEV	LINEAR EXPANSION VALVE	SW14	SW14	CONNECTION NO.
SW4		MODEL SELECTOR	TB2	TERMINAL BLOCK	SWC	SWC
ZNR	VARISTOR	TB5	TERMINAL BLOCK			
FUSE	FUSE (T6.3A/250V)	TH21	THERMISTOR			
LED1	POWER SUPPLY (I.B)		ROOM TEMP. DETECTION (0°C/15kΩ, 25°C/5.4kΩ)			
LED2	POWER SUPPLY (I.B)	TH22	PIPE TEMP. DETECTION/LIQUID (0°C/15kΩ, 25°C/5.4kΩ)			

NOTES

1. At servicing for outdoor unit, always follow the wiring diagram of outdoor unit.
2. In case of connecting MA-Remote controller, please connect MA remote controller cable in an accessory to the connector [1|2]. (Remote controller wire is non-polar.)
3. In case of using M-NET, please connect to TB5. (Transmission line is non-polar.)
4. Symbol [S] of TB5 is the shield wire connection.
5. Symbols used in wiring diagram above are, ⊙: terminal block, □□□: connector.
6. The setting of the SW2 dip switches differs in the capacity for the detail, refer to the fig:*1.

LED on indoor board for service

MARK	MEANING	FUNCTION
LED1	Main power supply	Main power supply (Indoor unit:220-240V) power on → lamp is lit
LED2	Power supply for MA-Remote controller	Power supply for MA-remote controller on → lamp is lit

<fig:*1>

MODELS	SW2
P20	ON OFF 1 2 3 4 5 6
P25	ON OFF 1 2 3 4 5 6
P32	ON OFF 1 2 3 4 5 6
P40	ON OFF 1 2 3 4 5 6

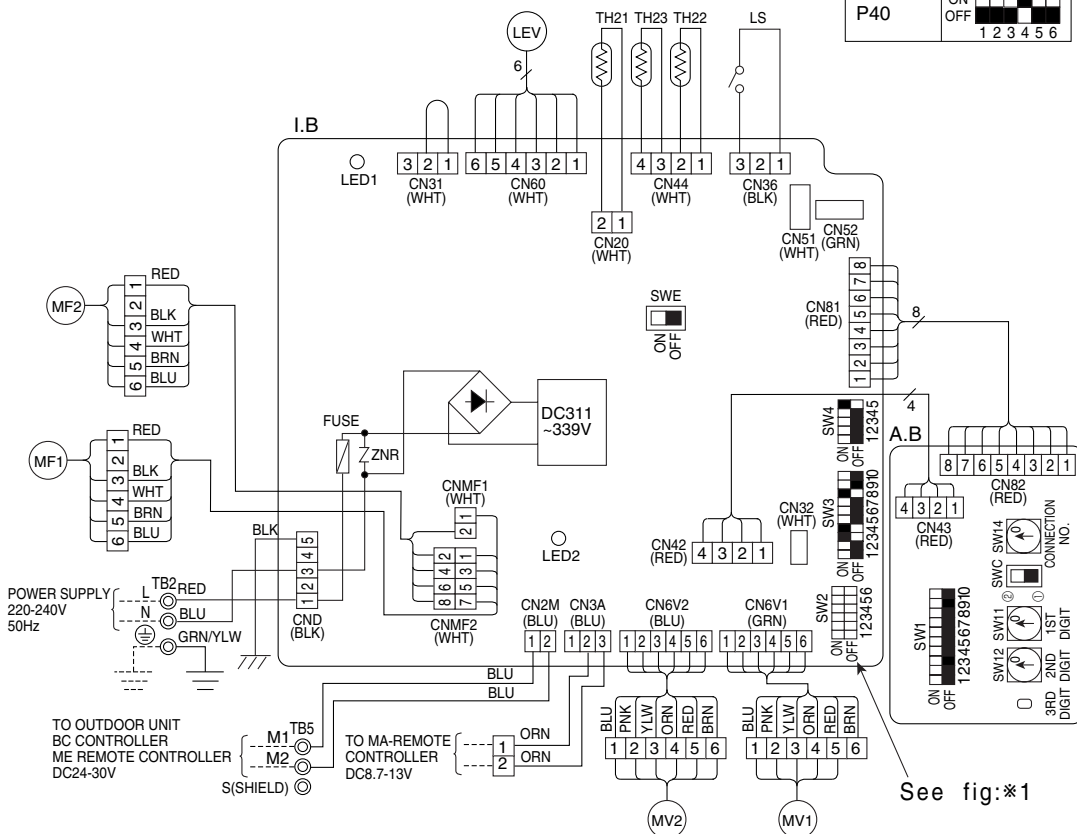

PFFY

PFFY-P20,25,32,40,50,63VLEM-E,VLRM-E

Drw. : IU-W65-3960

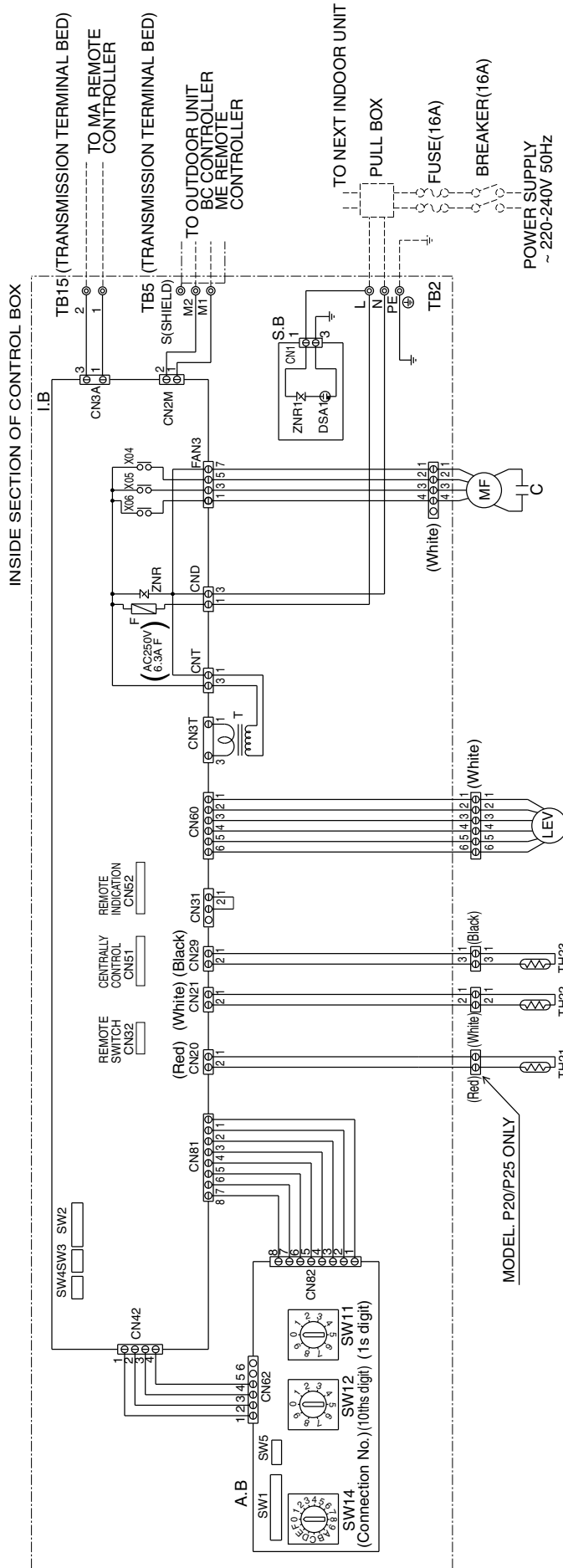

SYMBOL EXPLANATION

SYMBOL	NAME	SYMBOL	NAME
MF	Fan motor	TH 22	Thermistor (piping temp.detection/liquid)
C	Capacitor (for MF)	TH 23	Thermistor (piping temp.detection/gas)
I . B	Indoor controller board	SW 11 (A . B)	Switch (1s digit address set)
A . B	Address board	SW 12 (A . B)	Switch (10ths digit address set)
T B 2	Power source terminal bed	SW 14 (A . B)	Switch (connection No.set)
T B 5	Transmission terminal bed	SW 1 (A . B)	Switch (for mode selection)
T B 15	Transmission terminal bed	SW 2 (I . B)	Switch (for capacity code)
F	Fuse AC250V 6.3A F	SW 3 (I . B)	Switch (for mode selection)
T	Transformer	SW 4 (I . B)	Switch (for model selection)
LE.V	Electronic linear expan. valve	SW 5 (A . B)	Switch (for voltage selection)
S . B	Surge absorber board	X 0 4 ~ 0 6	Aux.relay
TH 21	Thermistor (inlet temp.detection)		

PFFY-P20,25,32,40,50,63VLRMM-E

Drw. : IU-KB94-G985

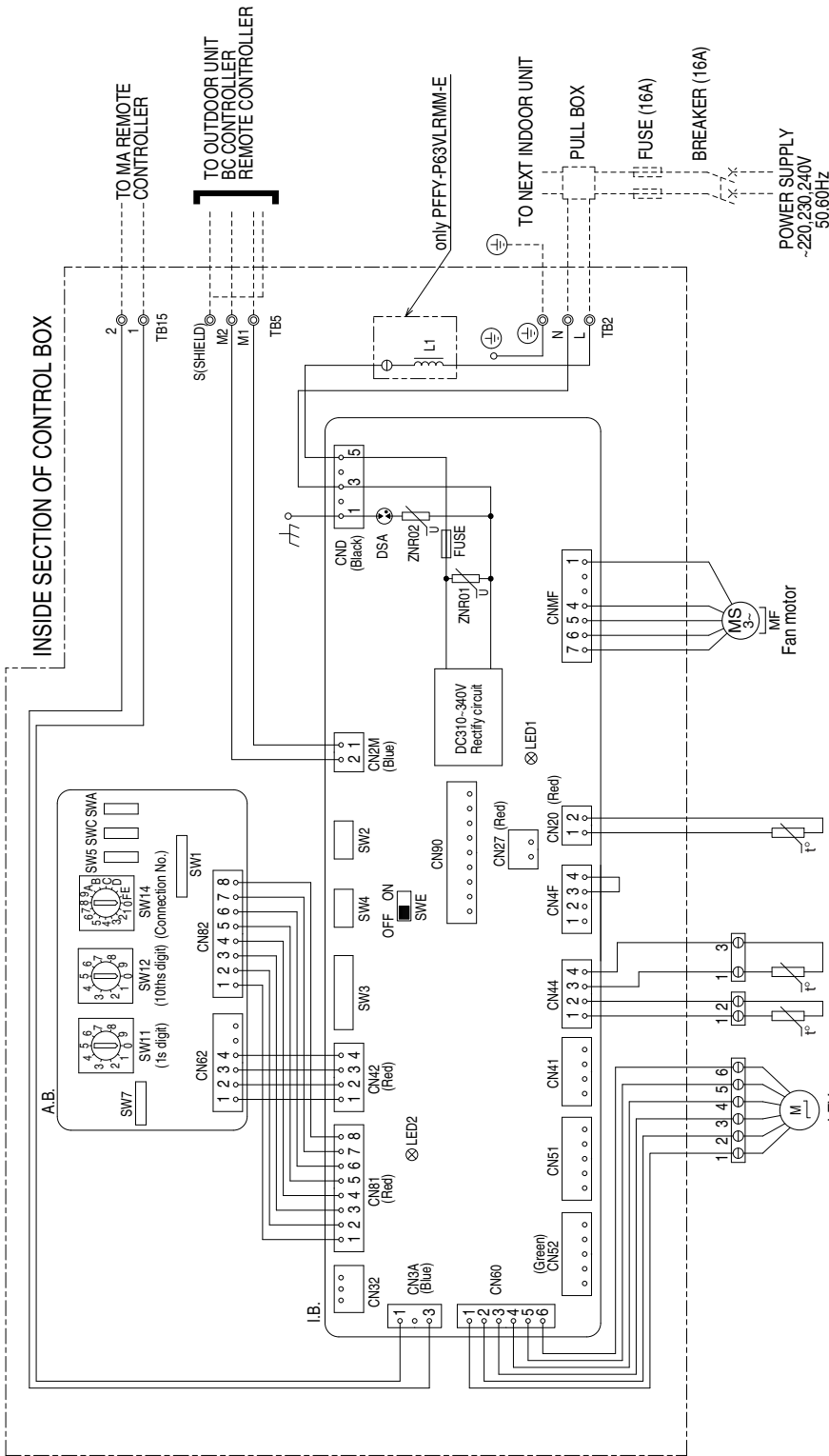

NOTE:1.The wirings to TB2,TB5,TB15 shown in dotted line are field work.
2.Mark ⊕ indicates terminal bed, ⊖ connector.

OPERATION OF LED FOR INDOOR CIRCUIT BOARD SERVICE

SYMBOL	LED operation under normal state
LED1	At applying main power source → Lighting
LED2	At receiving MA transmission power source → Lighting

SYMBOL EXPLANATION

SYMBOL	NAME	SYMBOL	NAME
I.B.	Indoor controller board	A.B.	Address board
FUSE	Fuse <AC250V 6.3A>	SW1	Switch (for mode selection)
ZNR01.02	Variistor	SW5	Switch (for mode selection)
DSA	Arrester	SW7	Switch (for mode selection)
CN27	Connector (Damper)	SW11	Switch (1s digit address set)
CN32	Connector (Remote switch)	SW12	Switch (10ths digit address set)
CN41	Connector (HA terminal-A)	SW14	Switch (connection No.set)
CN51	Connector (Centrally control)	SWA	Switch (for static pressure selection)
CN52	Connector (Remote indication)	SWC	Switch (for static pressure selection)
CN90	Connector (Wireless)	TB2	Power source terminal bed
SW2	Switch (for capacity code)	TB5	Transmission terminal bed
SW3	Switch (for mode selection)	TB15	Transmission terminal bed
SW4	Switch (for model selection)	TH21	Thermistor (inlet air temp.detection)
SWE	Connector (emergency operation)	TH22	Thermistor (piping temp.detection/liquid)
L1	AC reactor(Power factor improvement)	TH23	Thermistor (piping temp.detection/gas)
		LEV	Electronic linear expan. valve

5-1. Sound levels

PFFY-P-VKM-E,VLEM-E,VLRM-E

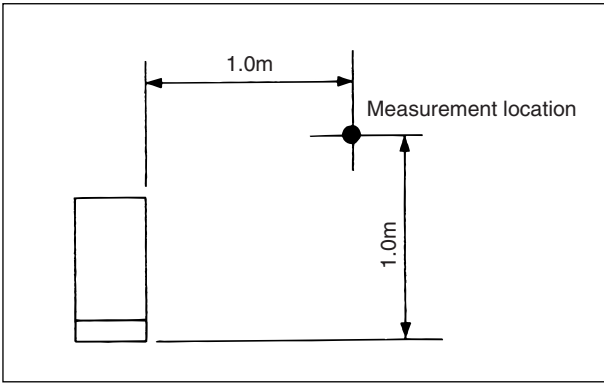

* Measured in anechoic room.

Sound level at anechoic room : Low-High

	Sound level dB (A)
PFFY-P20VKM-E	27-31-34-37
PFFY-P25VKM-E	28-32-35-38
PFFY-P32VKM-E	28-32-35-38
PFFY-P40VKM-E	35-38-42-44
PFFY-P20VLEM-E	34-40
PFFY-P20VLRM-E	
PFFY-P25VLEM-E	
PFFY-P32VLEM-E	35-40
PFFY-P32VLRM-E	
PFFY-P40VLEM-E	38-43
PFFY-P40VLRM-E	
PFFY-P50VLEM-E	
PFFY-P50VLRM-E	
PFFY-P63VLEM-E	40-46
PFFY-P63VLRM-E	

PFFY-P-VLRMM-E

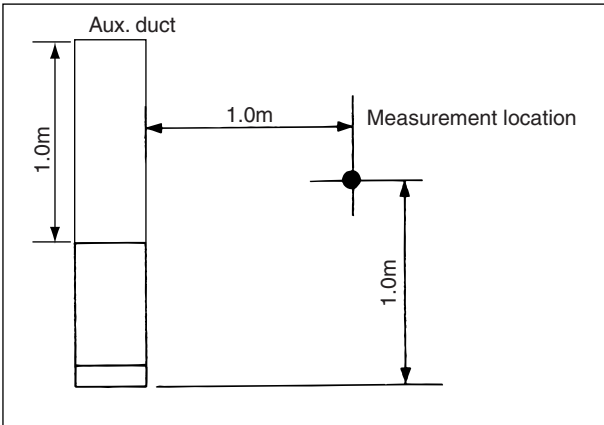

* Measured in anechoic room.

Sound level at anechoic room : Low-middle-High

	Sound level dB (A)		
	20Pa	40Pa	60Pa
PFFY-P20VLRMM-E	31-36-40	34-39-42	35-40-43
PFFY-P25VLRMM-E	31-36-40	34-39-42	35-40-43
PFFY-P32VLRMM-E	27-32-37	30-35-41	32-37-42
PFFY-P40VLRMM-E	30-36-40	32-38-42	35-39-44
PFFY-P50VLRMM-E	32-37-41	35-40-44	36-41-45
PFFY-P63VLRMM-E	35-40-44	36-42-47	38-43-48

5-2. NC curves

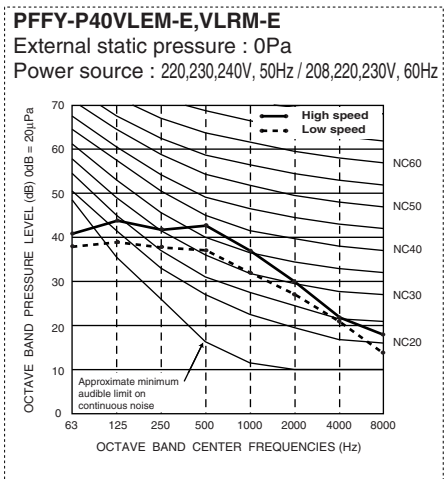
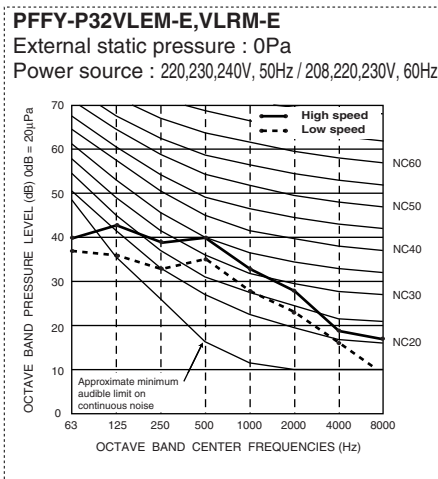
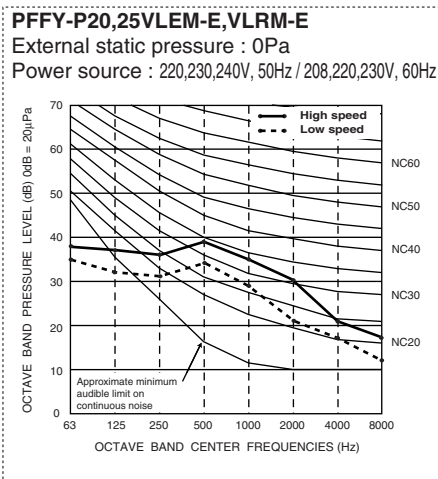
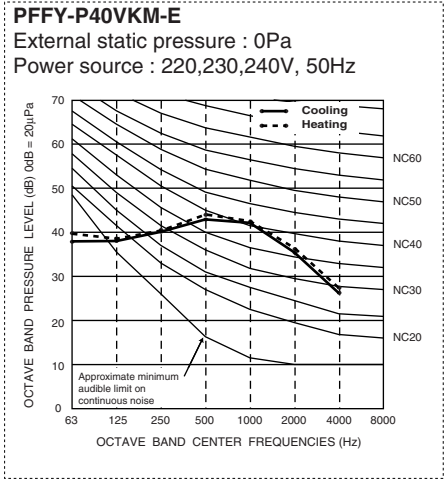
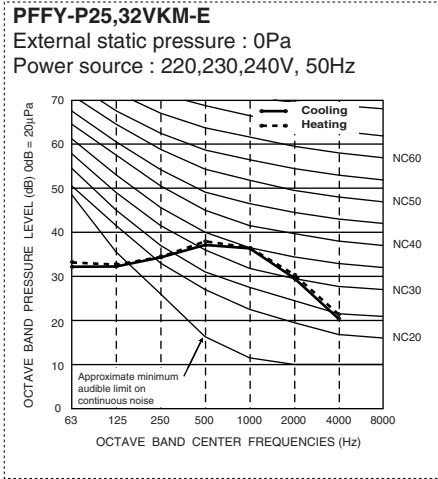
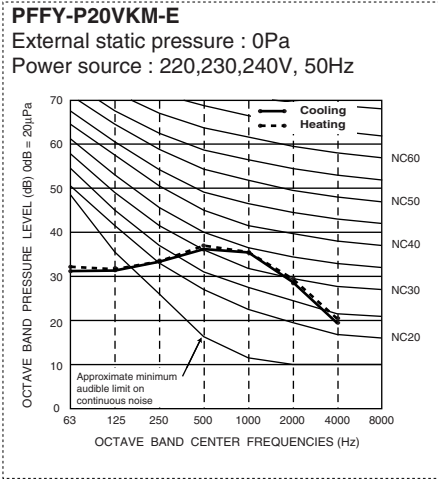

PFFY

5-2. NC curves

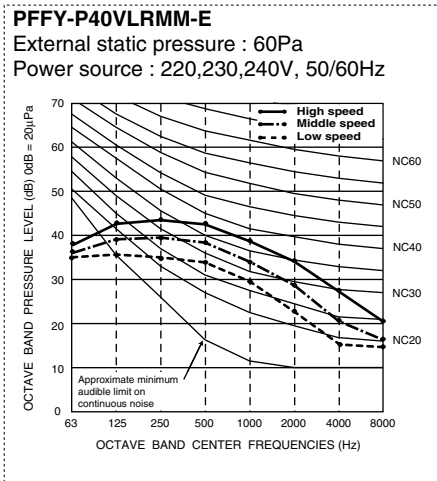
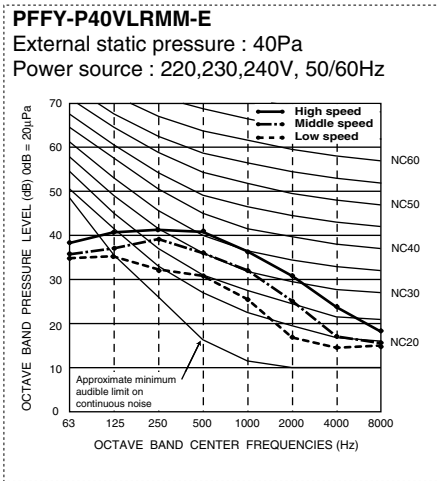
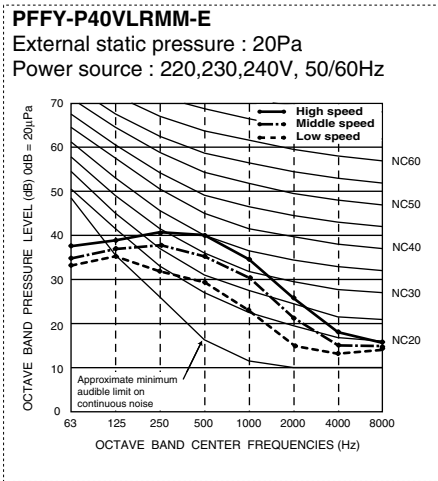
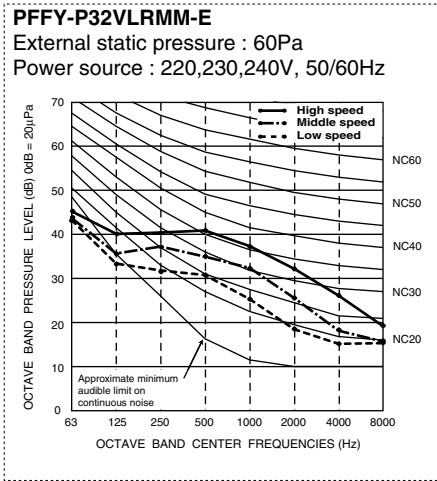
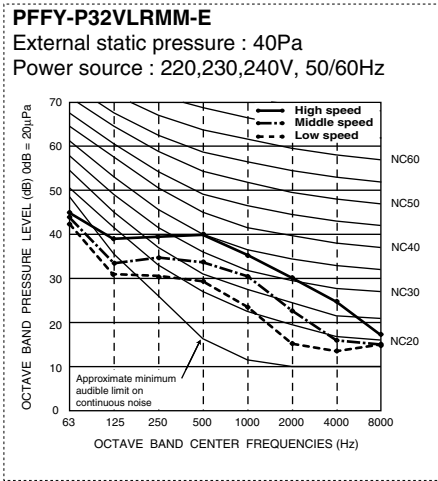
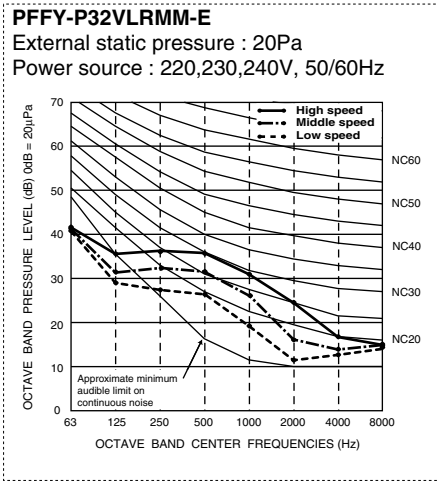
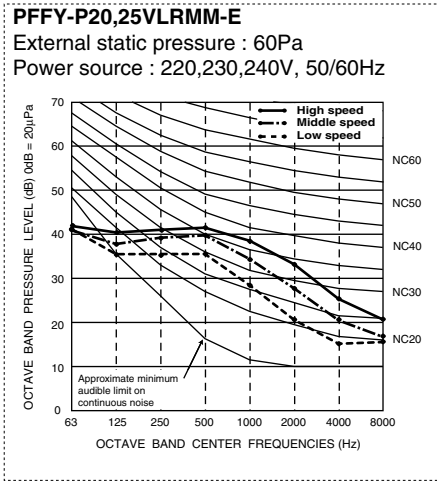
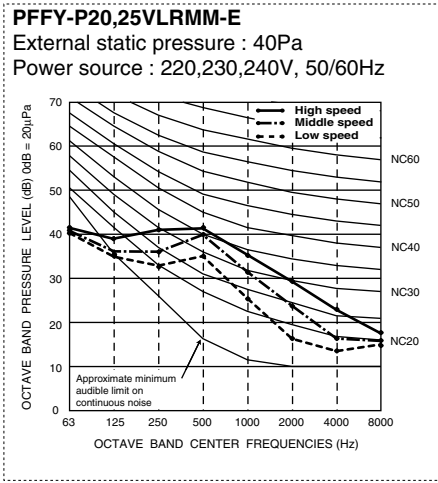
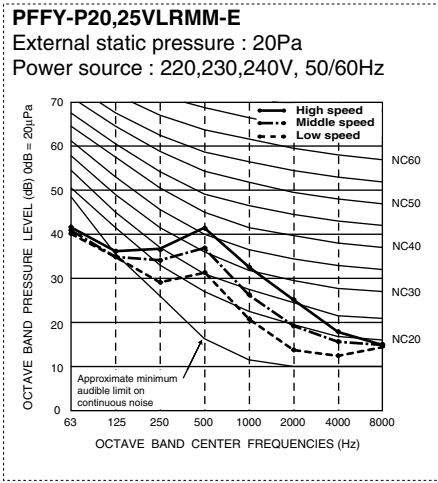
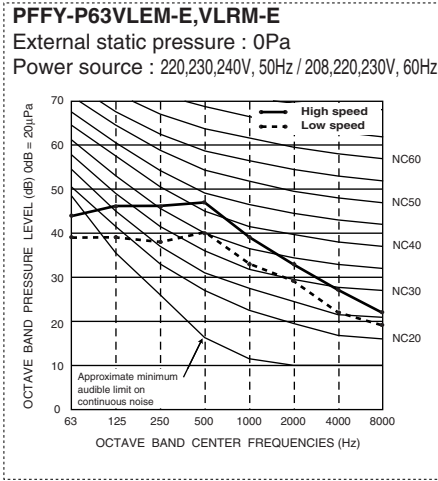
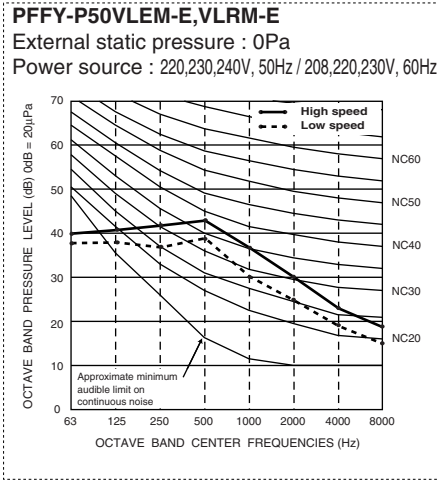

PFFY

5-2. NC curves

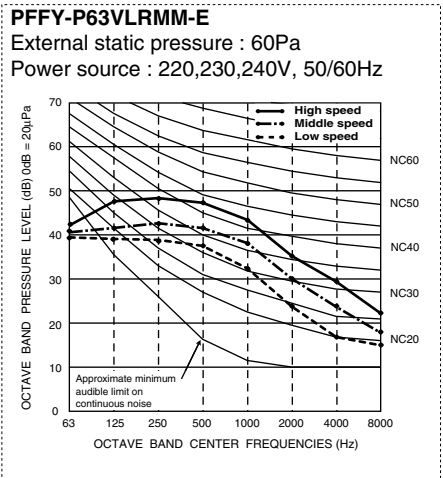
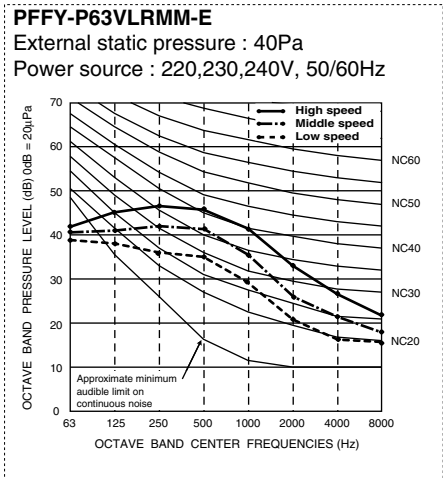
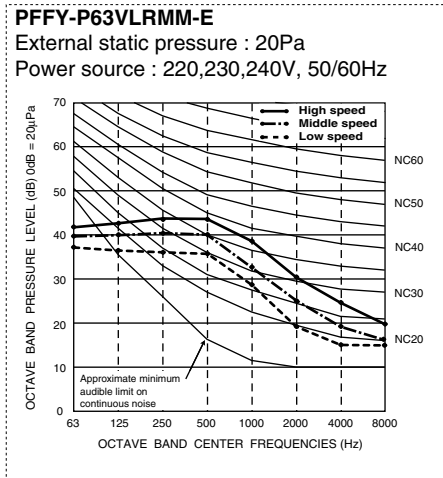
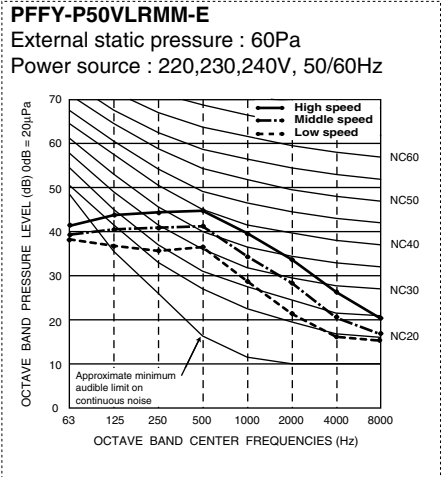
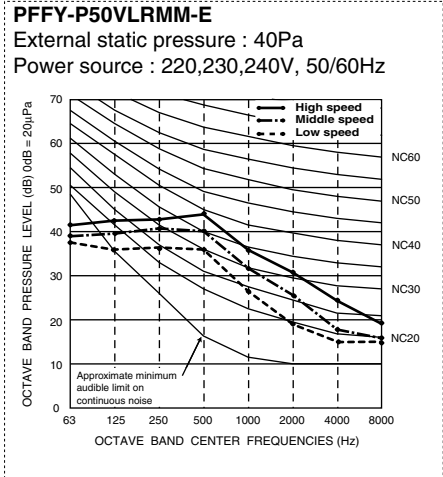
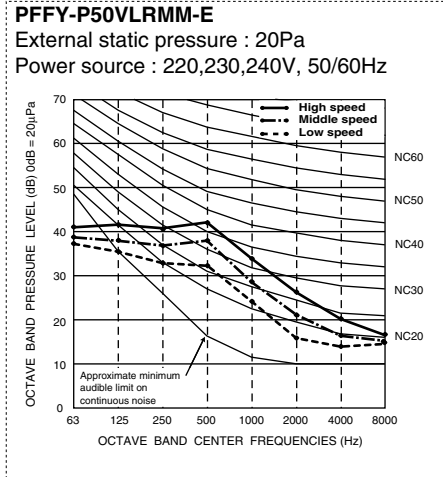

5-3. Fan characteristics curves

PFFY-P20,25VLRMM-E

External static pressure : 20Pa
Power source : 220,230,240V, 50/60Hz

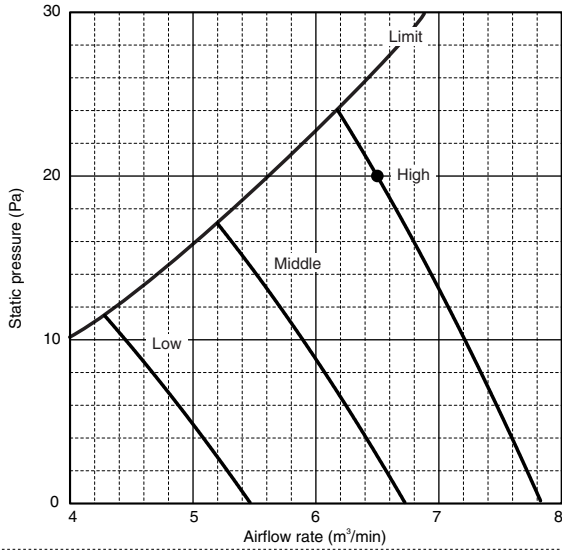

PFFY-P20,25VLRMM-E

External static pressure : 40Pa
Power source : 220,230,240V, 50/60Hz

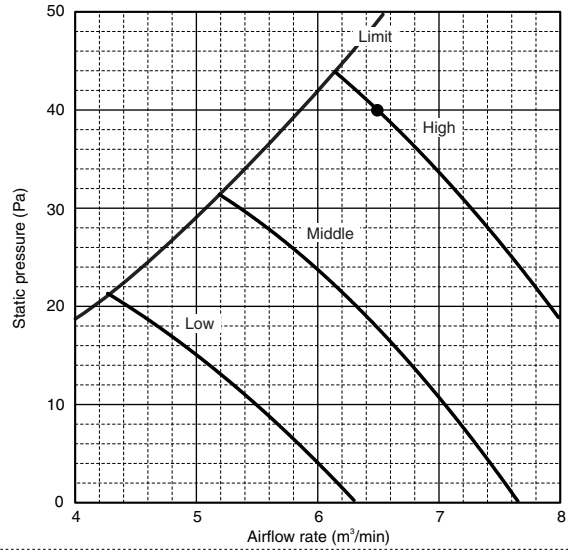

PFFY-P20,25VLRMM-E

External static pressure : 60Pa
Power source : 220,230,240V, 50/60Hz

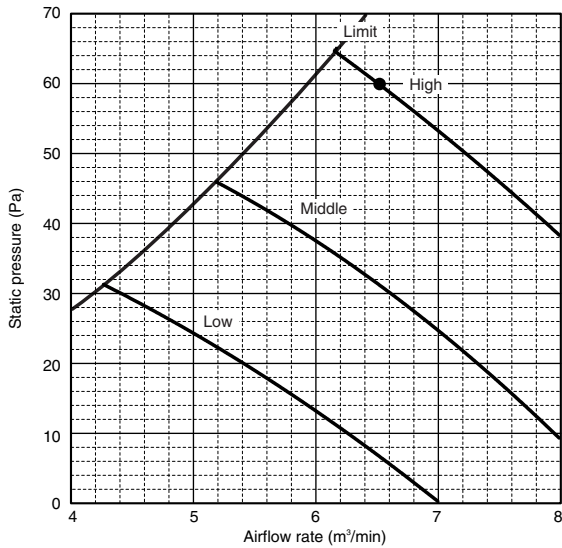

PFFY-P32VLRMM-E

External static pressure : 20Pa
Power source : 220,230,240V, 50/60Hz

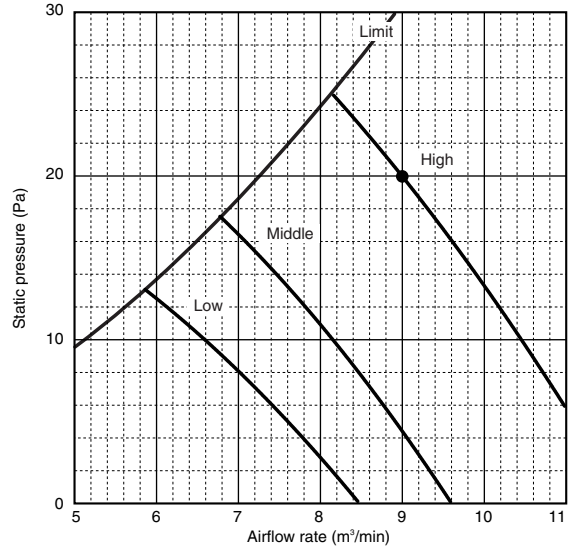

PFFY-P32VLRMM-E

External static pressure : 40Pa
Power source : 220,230,240V, 50/60Hz

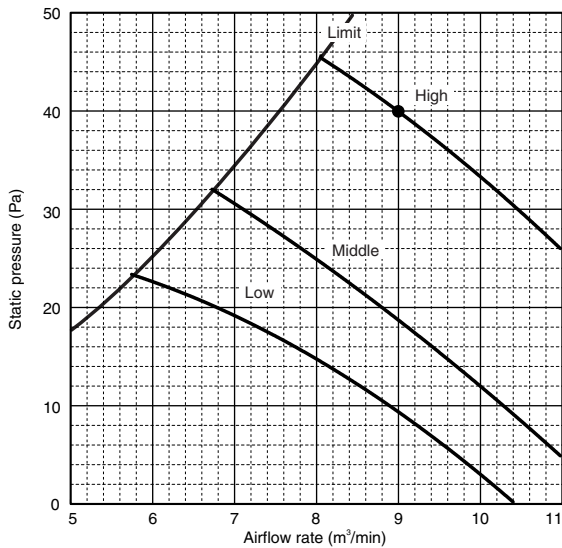

PFFY-P32VLRMM-E

External static pressure : 60Pa
Power source : 220,230,240V, 50/60Hz

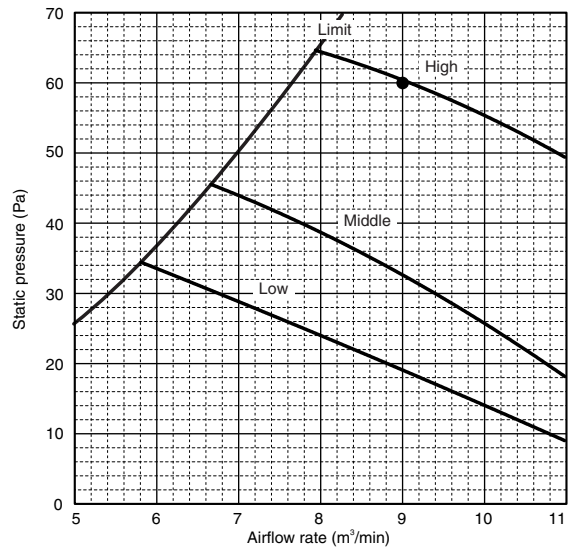

PFFY

5-3. Fan characteristics curves

PFFY-P40VLRMM-E

External static pressure : 20Pa
Power source : 220,230,240V, 50/60Hz

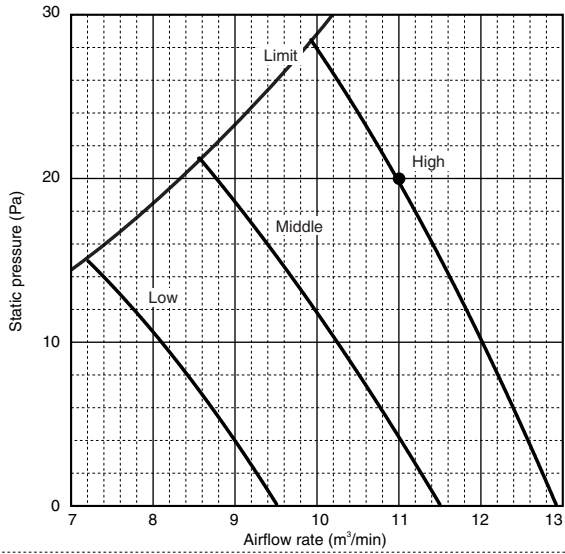

PFFY-P40VLRMM-E

External static pressure : 40Pa
Power source : 220,230,240V, 50/60Hz

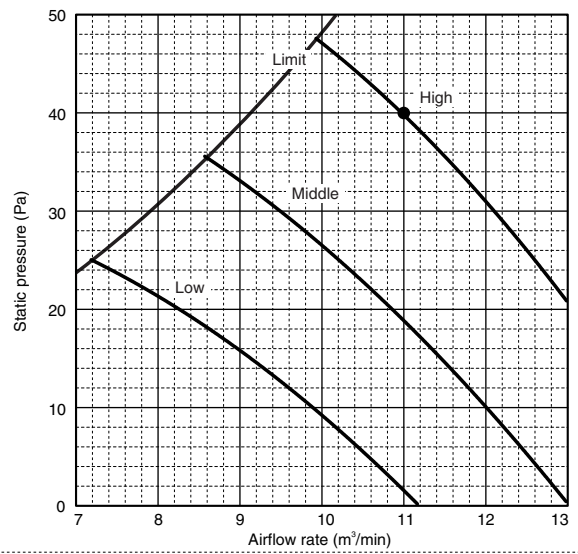

PFFY-P40VLRMM-E

External static pressure : 60Pa
Power source : 220,230,240V, 50/60Hz

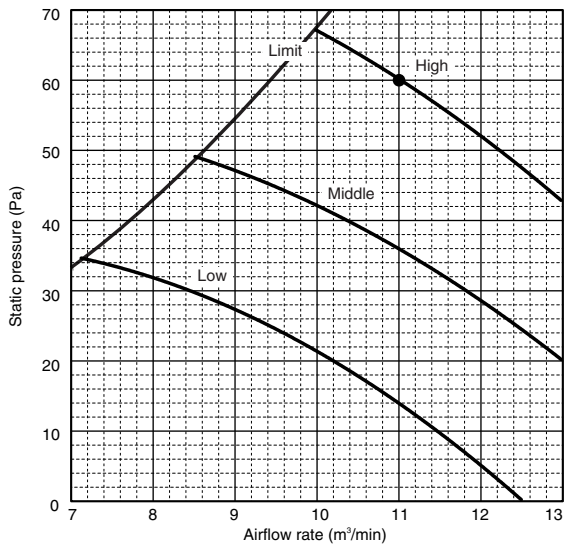

PFFY-P50VLRMM-E

External static pressure : 20Pa
Power source : 220,230,240V, 50/60Hz

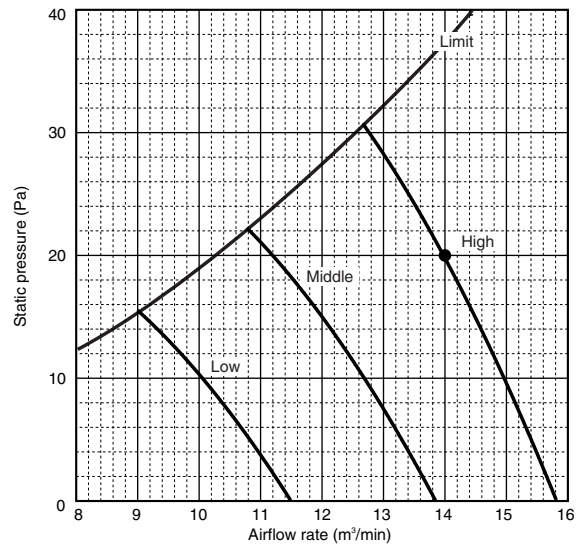

PFFY-P50VLRMM-E

External static pressure : 40Pa
Power source : 220,230,240V, 50/60Hz

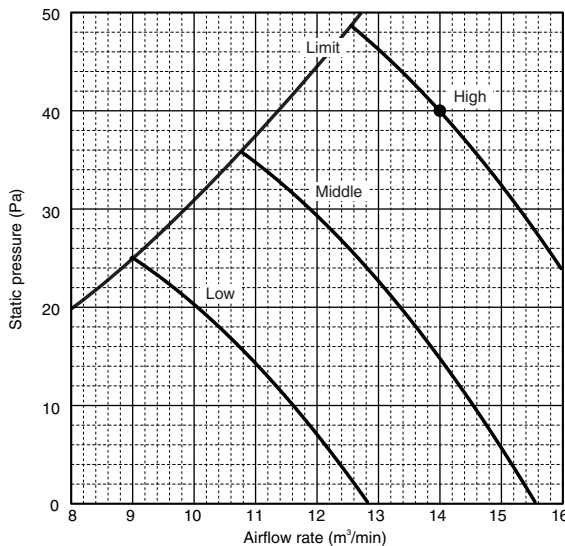

PFFY-P50VLRMM-E

External static pressure : 60Pa
Power source : 220,230,240V, 50/60Hz

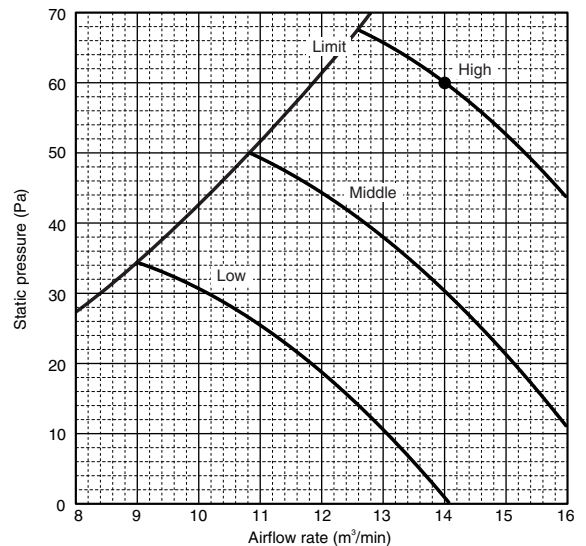

PFFY

5-3. Fan characteristics curves

PFFY-P63VLRMM-E

External static pressure : 20Pa

Power source : 220,230,240V, 50/60Hz

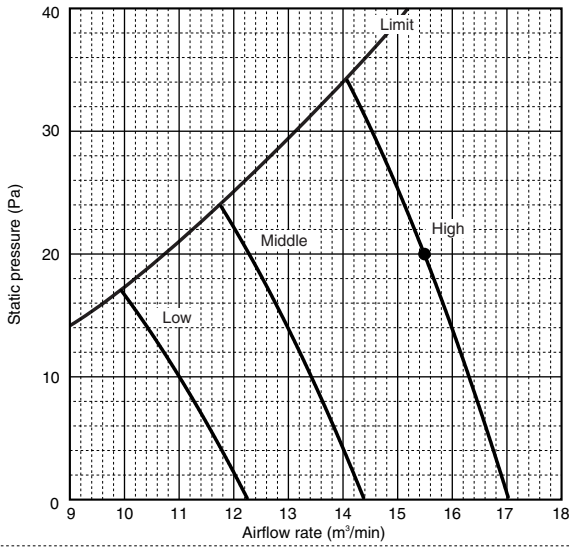

PFFY-P63VLRMM-E

External static pressure : 40Pa

Power source : 220,230,240V, 50/60Hz

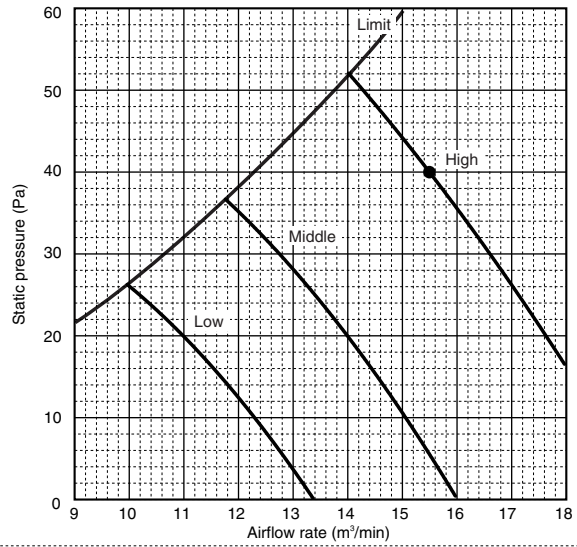

PFFY-P63VLRMM-E

External static pressure : 60Pa

Power source : 220,230,240V, 50/60Hz

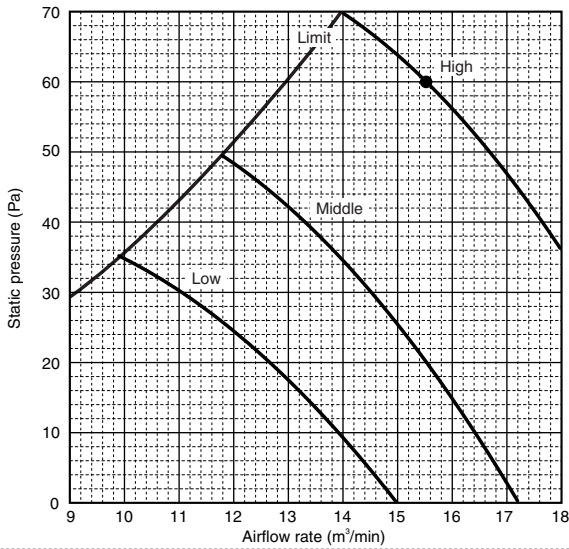

6-1. Temperature distributions

PFFY-P20-63VLEM-E

<Cooling mode>

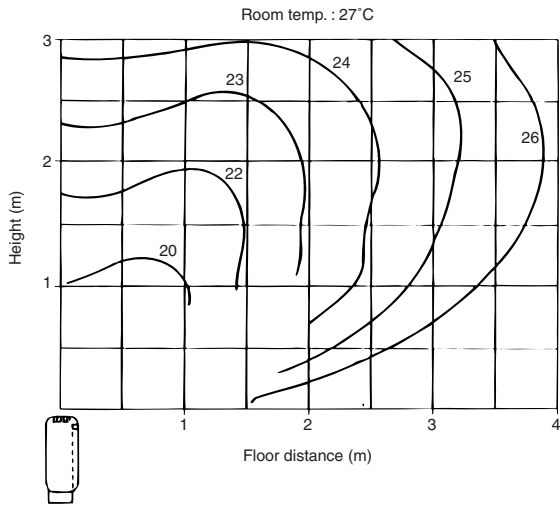

<Heating mode>

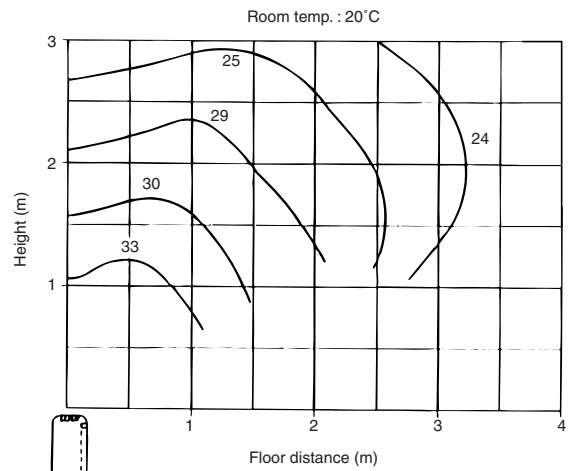

PFFY-P20-40VKM-E

<Cooling mode>

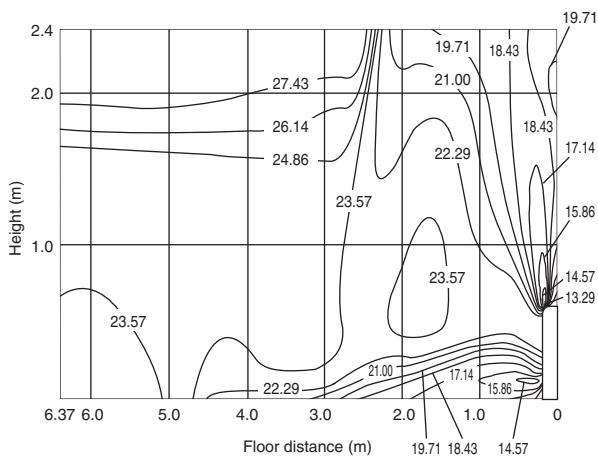

<Heating mode>

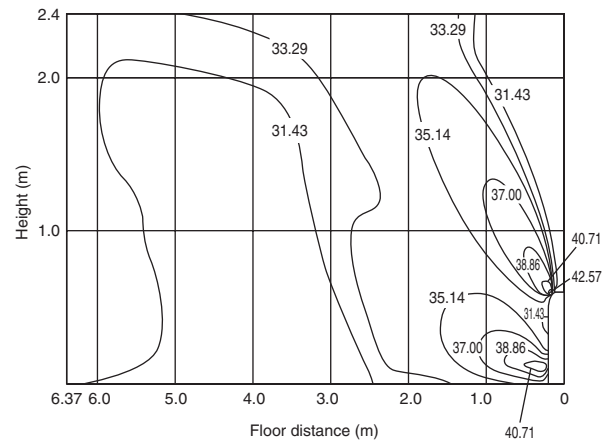

Note : These figures show typical temperature distributions in the conditions above. In the actual installation, they may differ from these figures under the influence of air temperature conditions, ceiling height, cooling/heating load, obstacles, etc.

6-2. Airflow distributions

PFFY-P20-63VLEM-E

<Cooling mode>

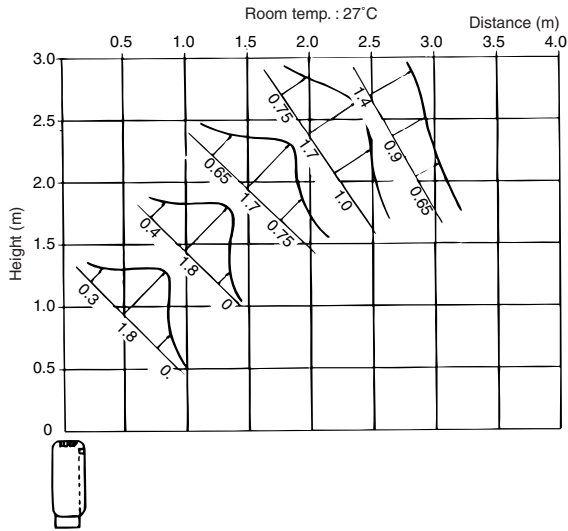

<Heating mode>

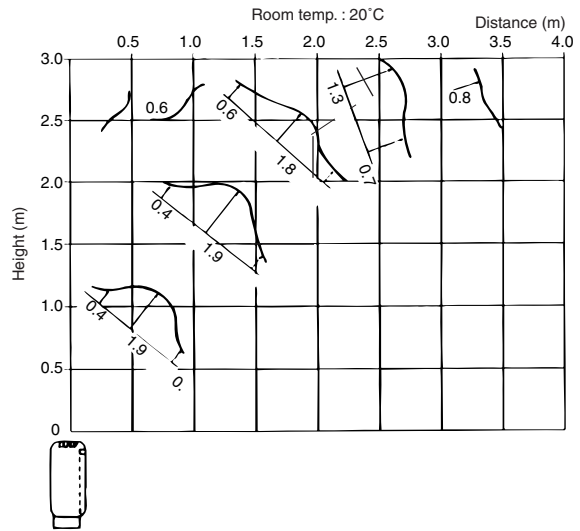

PFFY-P20-40VKM-E

<Cooling mode>

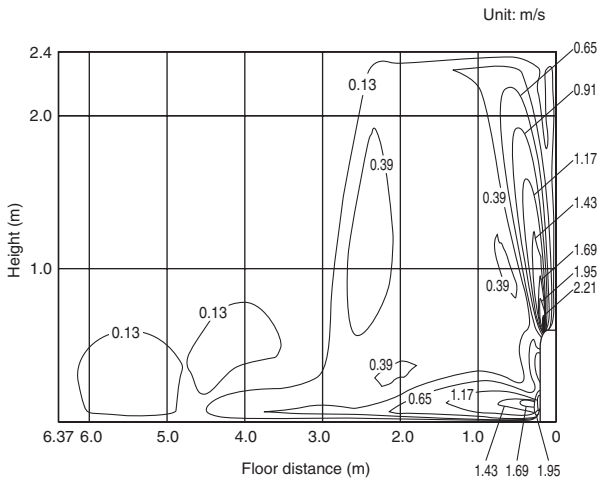

<Heating mode>

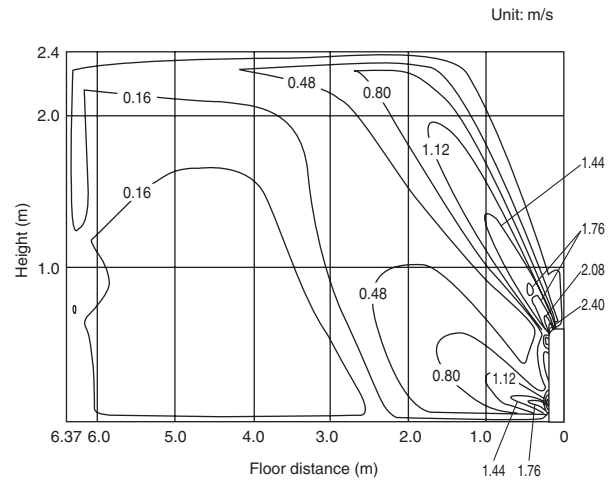

Note : These figures show typical airflow distributions in the conditions above. In the actual installation, they may differ from these figures under the influence of air temperature conditions, ceiling height, cooling/heating load, obstacles, etc.