

**PFFY-P-VKM-E**  
**PFFY-P-VLEM-E**  
**PFFY-P-VLRM-E**  
**PFFY-P-VLRMM-E**

1. SPECIFICATIONS	1 - 122
2. EXTERNAL DIMENSIONS	1 - 128
3. CENTER OF GRAVITY	1 - 132
4. ELECTRICAL WIRING DIAGRAMS	1 - 134
5. SOUND LEVELS	
5-1. Sound levels	1 - 137
5-2. NC curves	1 - 137
5-3. Fan characteristics curves	1 - 140
6. TEMPERATURE/AIRFLOW DISTRIBUTIONS	
6-1. Temperature distributions	1 - 143
6-2. Airflow distributions	1 - 144

# 1. SPECIFICATIONS

Model		PFFY-P20VKM-E	PFFY-P25VKM-E	PFFY-P32VKM-E	PFFY-P40VKM-E
Power source		1-phase 220-230-240V 50Hz			
Cooling capacity (Nominal)	*1 kW	2.2	2.8	3.6	4.5
	*1 kcal / h	1,900	2,400	3,100	3,900
	*1 Btu / h	7,500	9,600	12,300	15,400
	*2 kcal / h	2,000	2,500	3,200	4,000
	*4 Power input kW	0.025	0.025	0.025	0.028
*4 Current input A	0.20	0.20	0.20	0.24	
Heating capacity (Nominal)	*3 kW	2.5	3.2	4.0	5.0
	*3 kcal / h	2,200	2,800	3,400	4,300
	*3 Btu / h	8,500	10,900	13,600	17,100
	*4 Power input kW	0.025	0.025	0.025	0.028
	*4 Current input A	0.20	0.20	0.20	0.24
External finish		Plastic (Pure White)			
External dimension H x W x D		600 x 700 x 200			
		23-5/8 x 27-9/16 x 7-7/8			
Net weight		15 (34)			
Heat exchanger		Cross fin (Aluminium fin and copper tube)			
FAN	Type x Quantity		Line flow fan x 2		
	External static press.	Pa	0		
		mmH <sub>2</sub> O	0		
	Motor type		DC motor		
	Motor output		0.03 x 2		
	Driving mechanism		Direct-drive		
	Airflow rate (Low-Mid-High-SHigh)	m <sup>3</sup> / min	5.9 - 6.8 - 7.6 - 8.7	6.1 - 7.0 - 8.0 - 9.1	6.1 - 7.0 - 8.0 - 9.1
L / s cfm		98 - 113 - 127 - 145 208 - 240 - 268 - 307	102 - 117 - 133 - 152 215 - 247 - 283 - 321	102 - 117 - 133 - 152 215 - 247 - 283 - 321	133 - 150 - 158 - 178 283 - 318 - 335 - 378
Sound pressure level (Low-Mid-High-SHigh) (measured in anechoic room) *4		dB <A> 27 - 31 - 34 - 37	28 - 32 - 35 - 38	28 - 32 - 35 - 38	35 - 38 - 42 - 44
Insulation material		Polyethylene sheet			
Air filter		PP honeycomb fabric (Catechin air filter)			
Protection device		Fuse			
Refrigerant control device		LEV			
Connectable outdoor unit		R410A, R407C, R22 CITY MULTI			
Diameter of refrigerant pipe	Liquid (R410A) (R22, R407C)	mm (in.)	ø6.35 (ø1/4) Flare		
			ø6.35 (ø1/4) Flare		
	Gas (R410A) (R22, R407C)	mm (in.)	ø12.7 (ø1/2) Flare		
			ø12.7 (ø1/2) Flare		
Field drain pipe size		I.D. 16mm (5/8)			
Drawing	External		IU-BK01-B517		
	Wiring		IU-RG79-V367		
	Refrigerant cycle		-		
Standard attachment	Document Accessory	Installation Manual, Instruction Book			
Remark	Optional parts		-		
	Installation		Details on foundation work, duct work, insulation work, electrical wiring, power source switch, and other items shall be referred to the Installation Manual.		
<b>Note :</b>		*1 Nominal cooling conditions	*2 Nominal cooling conditions	*3 Nominal heating conditions	Unit converter
Indoor :		27°CDB/19°CWB (81°FDB/66°FWB)	27°CDB/19.5°CWB (81°FDB/67°FWB)	20°CDB (68°FDB)	kcal/h = kW x 860
Outdoor :		35°CDB (95°FDB)	35°CDB (95°FDB)	7°CDB/6°CWB (45°FDB/43°FWB)	Btu/h = kW x 3,412
Pipe length :		7.5 m (24-9/16 ft)	5 m (16-3/8 ft)	7.5 m (24-9/16 ft)	cfm = m <sup>3</sup> /min x 35.31
Level difference :		0 m (0 ft)	0 m (0 ft)	0 m (0 ft)	lb = kg / 0.4536
* Nominal conditions *1, *3 are subject to JIS B8615-1.					*Above specification data is subject to rounding variation.
* Due to continuing improvement, above specification may be subject to change without notice.					
*4 The values are measured at the rated external static pressure.					

# 1. SPECIFICATIONS

R410A Data G6

Model			PFFY-P20VLEM-E	PFFY-P25VLEM-E	PFFY-P32VLEM-E	PFFY-P40VLEM-E	
Power source			1-phase 220-240V 50Hz, 1-phase 208-230V 60Hz				
Cooling capacity (Nominal)	*1	kW	2.2	2.8	3.6	4.5	
		kcal / h	1,900	2,400	3,100	3,900	
		Btu / h	7,500	9,600	12,300	15,400	
	*2	kcal / h	2,000	2,500	3,150	4,000	
		*4 Power input	kW	0.04 / 0.06	0.04 / 0.06	0.06 / 0.07	0.065 / 0.075
	*4	Current input	A	0.19 / 0.25	0.19 / 0.25	0.29/0.30	0.32 / 0.33
Heating capacity (Nominal )	*3	kW	2.5	3.2	4.0	5.0	
		kcal / h	2,200	2,800	3,400	4,300	
		Btu / h	8,500	10,900	13,600	17,100	
	*4	Power input	kW	0.04 / 0.06	0.04 / 0.06	0.06 / 0.07	0.065 / 0.075
		Current input	A	0.19 / 0.25	0.19 / 0.25	0.29 / 0.30	0.32 / 0.33
	External finish			Acrylic painted, MUNSELL (5Y 8/1)			
External dimension H x W x D		mm	630 x 1,050 x 220	630 x 1,050 x 220	630 x 1,170 x 220	630 x 1,170 x 220	
		in.	24-13/16 x 41-3/8 x 8-11/16	24-13/16 x 41-3/8 x 8-11/16	24-13/16 x 46-1/8 x 8-11/16	24-13/16 x 46-1/8 x 8-11/16	
Net weight		kg (lb)	23 (51)	23 (51)	25 (56)	26 (58)	
Heat exchanger			Cross fin (Aluminium fin and copper tube)				
FAN	Type x Quantity		Sirocco fan x 1	Sirocco fan x 1	Sirocco fan x 2	Sirocco fan x 2	
	External static press.	Pa	0	0	0	0	
		mmH <sub>2</sub> O	0	0	0	0	
	Motor type		1-phase induction motor				
	Motor output		kW	0.015	0.015	0.018	0.030
	Driving mechanism		Direct-driven by motor				
	Airflow rate (Low-High)	m <sup>3</sup> / min		5.5 - 6.5	5.5 - 6.5	7.0 - 9.0	9.0 - 11.0
			L / s	92 - 108	92 - 108	117 - 150	150 - 183
cfm			194 - 230	194 - 230	247 - 318	318 - 388	
Sound pressure level (Low-High) (measured in anechoic room)	*4	dB <A>	32 - 38 (220V, 50Hz)	32 - 38 (220V, 50Hz)	33 - 38 (220V, 50Hz)	36 - 41 (220V, 50Hz)	
		dB <A>	33 - 39 (230V, 50Hz)	33 - 39 (230V, 50Hz)	34 - 39 (230V, 50Hz)	37 - 42 (230V, 50Hz)	
		dB <A>	34 - 40 (240V, 50Hz)	34 - 40 (240V, 50Hz)	35 - 40 (240V, 50Hz)	38 - 43 (240V, 50Hz)	
Insulation material			Polyethylene foam, Urethane foam				
Air filter			PP honeycomb fabric (washable)				
Protection device			Fuse				
Refrigerant control device			LEV				
Connectable outdoor unit			R410A, R407C, R22 CITY MULTI				
Diameter of refrigerant pipe	Liquid (R410A) (R22, R407C)	mm (in.)	ø6.35 (ø1/4) Flare	ø6.35 (ø1/4) Flare	ø6.35 (ø1/4) Flare	ø6.35 (ø1/4) Flare	
			ø6.35 (ø1/4) Flare	ø6.35 (ø1/4) Flare	ø6.35 (ø1/4) Flare	ø6.35 (ø1/4) Flare	
	Gas (R410A) (R22, R407C)	mm (in.)	ø12.7 (ø1/2) Flare	ø12.7 (ø1/2) Flare	ø12.7 (ø1/2) Flare	ø12.7 (ø1/2) Flare	
Field drain pipe size		mm (in.)	I.D. 26mm (1)				
Drawing	External		IU-W65-3950				
	Wiring		IU-W65-3960				
	Refrigerant cycle		-				
Standard attachment	Document	Installation Manual, Instruction Book					
	Accessory	Drain hose (O.D.27mm(1-3/32), (End O.D.20mm(13/16))) (flexible joint)					
Remark	Optional parts		-				
	Installation		Details on foundation work, duct work, insulation work, electrical wiring, power source switch, and other items shall be referred to the Installation Manual.				
<b>Note :</b>			*:1 Nominal cooling conditions	*:2 Nominal cooling conditions	*:3 Nominal heating conditions	Unit converter	
Indoor :			27°CDB/19°CWB (81°FDB/66°FWB)	27°CDB/19.5°CWB (81°FDB/67°FWB)	20°CDB (68°FDB)	kcal/h = kW x 860	
Outdoor :			35°CDB (95°FDB)	35°CDB (95°FDB)	7°CDB/6°CWB (45°FDB/43°FWB)	Btu/h = kW x 3,412	
Pipe length :			7.5 m (24-9/16 ft)	5 m (16-3/8 ft)	7.5 m (24-9/16 ft)	cfm = m <sup>3</sup> /min x 35.31	
Level difference :			0 m (0 ft)	0 m (0 ft)	0 m (0 ft)	lb = kg / 0.4536	
* Nominal conditions *:1, *:3 are subject to JIS B8615-1.						*Above specification data is subject to rounding variation.	
* Due to continuing improvement, above specification may be subject to change without notice.							
*:4 The values are measured at the rated external static pressure.							

Ref.: Spec\_PFFY-P-VLE(R)M-E\_1

PFFY

# 1. SPECIFICATIONS

R410A Data G6

Model		PFFY-P50VLEM-E	PFFY-P63VLEM-E	PFFY-P20VLRM-E	PFFY-P25VLRM-E	
Power source		1-phase 220-240V 50Hz, 1-phase 208-230V 60Hz				
Cooling capacity (Nominal)	*1 kW	5.6	7.1	2.2	2.8	
	*1 kcal / h	4,800	6,100	1,900	2,400	
	*1 Btu / h	19,100	24,200	7,500	9,600	
	*2 kcal / h	5,000	6,300	2,000	2,500	
	*4 Power input kW	0.085 / 0.09	0.1 / 0.11	0.04 / 0.06	0.04 / 0.06	
*4 Current input	A	0.40 / 0.41	0.46 / 0.47	0.19 / 0.25	0.19 / 0.25	
Heating capacity (Nominal)	*3 kW	6.3	8.0	2.5	3.2	
	*3 kcal / h	5,400	6,900	2,200	2,800	
	*3 Btu / h	21,500	27,300	8,500	10,900	
	*4 Power input kW	0.085 / 0.09	0.1 / 0.11	0.04 / 0.06	0.04 / 0.06	
	*4 Current input	A	0.40 / 0.41	0.46 / 0.47	0.19 / 0.25	0.19 / 0.25
External finish		Acrylic painted, MUNSELL (5Y 8/1)		Galvanized		
External dimension H x W x D		630 x 1,410 x 220	630 x 1,410 x 220	639 x 886 x 220	639 x 886 x 220	
		in.	24-13/16 x 55-9/16 x 8-11/16	24-13/16 x 55-9/16 x 8-11/16	25-3/16 x 34-15/16 x 8-11/16	
Net weight		kg (lb)	30 (67)	32 (71)	18.5 (41)	
Heat exchanger		Cross fin (Aluminium fin and copper tube)				
FAN	Type x Quantity		Sirocco fan x 2	Sirocco fan x 2	Sirocco fan x 1	Sirocco fan x 1
	External static press.	Pa	0	0	0	0
		mmH <sub>2</sub> O	0	0	0	0
	Motor type		1-phase induction motor			
	Motor output	kW	0.035	0.050	0.015	0.015
	Driving mechanism		Direct-driven by motor			
	Airflow rate (Low-High)	m <sup>3</sup> / min	12.0 - 14.0	12.0 - 15.5	5.5 - 6.5	5.5 - 6.5
L / s		200 - 233	200 - 258	92 - 108	92 - 108	
cfm		424 - 494	424 - 547	194 - 230	194 - 230	
Sound pressure level (Low-High) (measured in anechoic room)	dB <A>	36 - 41 (220V, 50Hz)	38 - 44 (220V, 50Hz)	32 - 38 (220V, 50Hz)	32 - 38 (220V, 50Hz)	
	dB <A>	37 - 42 (230V, 50Hz)	39 - 45 (230V, 50Hz)	33 - 39 (230V, 50Hz)	33 - 39 (230V, 50Hz)	
	*4 dB <A>	38 - 43 (240V, 50Hz)	40 - 46 (240V, 50Hz)	34 - 40 (240V, 50Hz)	34 - 40 (240V, 50Hz)	
Insulation material		Polyethylene foam, Urethane foam				
Air filter		PP honeycomb fabric (washable)				
Protection device		Fuse				
Refrigerant control device		LEV				
Connectable outdoor unit		R410A, R407C, R22 CITY MULTI				
Diameter of refrigerant pipe	Liquid (R410A) (R22, R407C)	mm (in.)	ø6.35 (ø1/4) Flare	ø9.52 (ø3/8) Flare	ø6.35 (ø1/4) Flare	ø6.35 (ø1/4) Flare
		mm (in.)	ø9.52 (ø3/8) Flare	ø9.52 (ø3/8) Flare	ø6.35 (ø1/4) Flare	ø6.35 (ø1/4) Flare
	Gas (R410A) (R22, R407C)	mm (in.)	ø12.7 (ø1/2) Flare	ø15.88 (ø5/8) Flare	ø12.7 (ø1/2) Flare	ø12.7 (ø1/2) Flare
Field drain pipe size		mm (in.)	I.D. 26mm (1)			
Drawing	External	IU-W65-3950	IU-W65-3950	IU-W65-3951	IU-W65-3951	
	Wiring	IU-W65-3960	IU-W65-3960	IU-W65-3960	IU-W65-3960	
	Refrigerant cycle	-	-	-	-	
Standard attachment	Document	Installation Manual, Instruction Book				
	Accessory	Drain hose (O.D.27mm(1-3/32), (End O.D.20mm(13/16))) (flexible joint)				
Remark	Optional parts	-				
	Installation	Details on foundation work, duct work, insulation work, electrical wiring, power source switch, and other items shall be referred to the Installation Manual.				
Note :	*1 Nominal cooling conditions	*2 Nominal cooling conditions	*3 Nominal heating conditions	Unit converter		
	Indoor : 27°CDB/19°CWB (81°FDB/66°FWB) Outdoor : 35°CDB (95°FDB) Pipe length : 7.5 m (24-9/16 ft) Level difference : 0 m (0 ft)	27°CDB/19.5°CWB (81°FDB/67°FWB) 35°CDB (95°FDB) 5 m (16-3/8 ft) 0 m (0 ft)	20°CDB (68°FDB) 7°CDB/6°CWB (45°FDB/43°FWB) 7.5 m (24-9/16 ft) 0 m (0 ft)	kcal/h = kW x 860 Btu/h = kW x 3,412 cfm = m <sup>3</sup> /min x 35.31 lb = kg / 0.4536		
* Nominal conditions *1, *3 are subject to JIS B8615-1.				*Above specification data is subject to rounding variation.		
* Due to continuing improvement, above specification may be subject to change without notice.						
*4 The values are measured at the rated external static pressure.						

Ref.: Spec\_PFFY-P-VLE(R)M-E\_2

# 1. SPECIFICATIONS

R410A Data G6

Model			PFFY-P32VLRM-E	PFFY-P40VLRM-E	PFFY-P50VLRM-E	PFFY-P63VLRM-E	
Power source			1-phase 220-240V 50Hz, 1-phase 208-230V 60Hz				
Cooling capacity (Nominal)	*1	kW	3.6	4.5	5.6	7.1	
		kcal / h	3,100	3,900	4,800	6,100	
		Btu / h	12,300	15,400	19,100	24,200	
	*2	kcal / h	3,150	4,000	5,000	6,300	
		Power input	kW	0.06 / 0.07	0.065 / 0.075	0.085 / 0.09	0.1 / 0.11
*4	Current input	A	0.29 / 0.30	0.32 / 0.33	0.40 / 0.41	0.46 / 0.47	
Heating capacity (Nominal)	*3	kW	4.0	5.0	6.3	8.0	
		kcal / h	3,400	4,300	5,400	6,900	
		Btu / h	13,600	17,100	21,500	27,300	
	*4	Power input	kW	0.06 / 0.07	0.065 / 0.075	0.085 / 0.09	0.1 / 0.11
		Current input	A	0.29 / 0.30	0.32 / 0.33	0.40 / 0.41	0.46 / 0.47
External finish			Galvanized				
External dimension H x W x D		mm	639 x 1,006 x 220	639 x 1,006 x 220	639 x 1,246 x 220	639 x 1,246 x 220	
		in.	25-3/16 x 39-5/8 x 8-11/16	25-3/16 x 39-5/8 x 8-11/16	25-3/16 x 49-1/16 x 8-11/16	25-3/16 x 49-1/16 x 8-11/16	
Net weight		kg (lb)	20 (45)	21 (47)	25 (56)	27 (60)	
Heat exchanger			Cross fin (Aluminium fin and copper tube)				
FAN	Type x Quantity		Sirocco fan x 2	Sirocco fan x 2	Sirocco fan x 2	Sirocco fan x 2	
	External static press.	Pa	0	0	0	0	
		mmH <sub>2</sub> O	0	0	0	0	
	Motor type		1-phase induction motor				
	Motor output		kW	0.018	0.030	0.035	0.050
	Driving mechanism		Direct-driven by motor				
	Airflow rate (Low-High)	m <sup>3</sup> / min	7.0 - 9.0	9.0 - 11.0	12.0 - 14.0	12.0 - 15.5	
L / s			117 - 150	150 - 183	200 - 233	200 - 258	
cfm			247 - 318	318 - 388	424 - 494	424 - 547	
Sound pressure level (Low-High) (measured in anechoic room)	*4	dB <A>	33 - 38 (220V, 50Hz)	36 - 41 (220V, 50Hz)	36 - 41 (220V, 50Hz)	38 - 44 (220V, 50Hz)	
		dB <A>	34 - 39 (230V, 50Hz)	37 - 42 (230V, 50Hz)	37 - 42 (230V, 50Hz)	39 - 45 (230V, 50Hz)	
		dB <A>	35 - 40 (240V, 50Hz)	38 - 43 (240V, 50Hz)	38 - 43 (240V, 50Hz)	40 - 46 (240V, 50Hz)	
Insulation material			Polyethylene foam, Urethane foam				
Air filter			PP honeycomb fabric (washable)				
Protection device			Fuse				
Refrigerant control device			LEV				
Connectable outdoor unit			R410A, R407C, R22 CITY MULTI				
Diameter of refrigerant pipe	Liquid (R410A) (R22, R407C)	mm (in.)	ø6.35 (ø1/4) Flare	ø6.35 (ø1/4) Flare	ø6.35 (ø1/4) Flare	ø9.52 (ø3/8) Flare	
		mm (in.)	ø6.35 (ø1/4) Flare	ø6.35 (ø1/4) Flare	ø9.52 (ø3/8) Flare	ø9.52 (ø3/8) Flare	
	Gas (R410A) (R22, R407C)	mm (in.)	ø12.7 (ø1/2) Flare	ø12.7 (ø1/2) Flare	ø12.7 (ø1/2) Flare	ø15.88 (ø5/8) Flare	
Field drain pipe size		mm (in.)	I.D. 26mm (1)				
Drawing	External		IU-W65-3951				
	Wiring		IU-W65-3960				
	Refrigerant cycle		-				
Standard attachment	Document		Installation Manual, Instruction Book				
	Accessory		Drain hose (O.D.27mm(1-3/32), (End O.D.20mm(13/16))) (flexible joint)				
Remark	Optional parts		-				
	Installation		Details on foundation work, duct work, insulation work, electrical wiring, power source switch, and other items shall be referred to the Installation Manual.				
<b>Note :</b>			*:1 Nominal cooling conditions	*:2 Nominal cooling conditions	*:3 Nominal heating conditions	Unit converter	
			Indoor : 27°CDB/19°CWB (81°FDB/66°FWB)	27°CDB/19.5°CWB (81°FDB/67°FWB)	20°CDB (68°FDB)	kcal/h = kW x 860	
			Outdoor : 35°CDB (95°FDB)	35°CDB (95°FDB)	7°CDB/6°CWB (45°FDB/43°FWB)	Btu/h = kW x 3,412	
			Pipe length : 7.5 m (24-9/16 ft)	5 m (16-3/8 ft)	7.5 m (24-9/16 ft)	cfm = m <sup>3</sup> /min x 35.31	
			Level difference : 0 m (0 ft)	0 m (0 ft)	0 m (0 ft)	lb = kg / 0.4536	
			* Nominal conditions *:1, *:3 are subject to JIS B8615-1.			*Above specification data is subject to rounding variation.	
			* Due to continuing improvement, above specification may be subject to change without notice.				
			*:4 The values are measured at the rated external static pressure.				

Ref.: Spec\_PFFY-P-VLE(R)M-E\_3

PFFY

# 1. SPECIFICATIONS

R410A Data G6

Model		PFFY-P20VLRMM-E	PFFY-P25VLRMM-E	PFFY-P32VLRMM-E	PFFY-P40VLRMM-E	
Power source		1-phase 220-240V (50/60Hz)				
Cooling capacity (Nominal)	*1 kW	2.2	2.8	3.6	4.5	
	*1 kcal / h	1,900	2,400	3,100	3,900	
	*1 Btu / h	7,500	9,600	12,300	15,400	
	*2 kcal / h	2,000	2,500	3,150	4,000	
	*4 Power input kW	0.04	0.04	0.04	0.05	
	*4 Current input A	0.34	0.34	0.38	0.43	
Heating capacity (Nominal)	*3 kW	2.5	3.2	4.0	5.0	
	*3 kcal / h	2,200	2,800	3,400	4,300	
	*3 Btu / h	8,500	10,900	13,600	17,100	
	*4 Power input kW	0.04	0.04	0.04	0.05	
	*4 Current input A	0.34	0.34	0.38	0.43	
	External finish		Galvanized steel plate			
External dimension H x W x D		639 x 886 x 220	639 x 886 x 220	639 x 1006 x 220	639 x 1006 x 220	
		in. 25-3/16 x 34-15/16 x 8-11/16	25-3/16 x 34-15/16 x 8-11/16	25-3/16 x 39-5/8 x 8-11/16	25-3/16 x 39-5/8 x 8-11/16	
Net weight		kg (lb) 18.5 (41)	18.5 (41)	20 (45)	21(47)	
Heat exchanger		Cross fin (Aluminium fin and copper tube)				
FAN	Type x Quantity		Sirocco fan x 1	Sirocco fan x 1	Sirocco fan x 2	Sirocco fan x 2
	External static press.	Pa	20 - <40> - <60>	20 - <40> - <60>	20 - <40> - <60>	20 - <40> - <60>
		mmH <sub>2</sub> O	2.0 - <4.1> - <6.1>	2.0 - <4.1> - <6.1>	2.0 - <4.1> - <6.1>	2.0 - <4.1> - <6.1>
	Motor type		DC blushless motor			
	Motor output		0.096	0.096	0.096	0.096
	Driving mechanism		Direct-driven			
	Airflow rate (Low-Mid-High)	m <sup>3</sup> / min	4.5 - 5.5 - 6.5	4.5 - 5.5 - 6.5	6.5 - 7.5 - 9.0	8.0 - 9.5 - 11.0
		L / s	75 - 92 - 108	75 - 92 - 108	108 - 125 - 150	133 - 158 - 183
		cfm	159 - 194 - 230	159 - 194 - 230	230 - 265 - 318	283 - 335 - 388
	Sound pressure level (Low-Mid-High) (measured in anechoic room)	dB <A>	31 - 36 - 40 (20Pa)	31 - 36 - 40 (20Pa)	27 - 32 - 37 (20Pa)	30 - 36 - 40 (20Pa)
dB <A>		34 - 39 - 42 (40Pa)	34 - 39 - 42 (40Pa)	30 - 35 - 41 (40Pa)	32 - 38 - 42 (40Pa)	
*4 dB <A>		35 - 40 - 43 (60Pa)	35 - 40 - 43 (60Pa)	32 - 37 - 42 (60Pa)	35 - 39 - 44 (60Pa)	
Insulation material		Polyethylene foam, Urethane foam				
Air filter		PP honeycomb fabric (washable)				
Protection device		Fuse				
Refrigerant control device		LEV				
Connectable outdoor unit		R410A CITY MULTI				
Diameter of refrigerant pipe	Liquid (R410A)	mm (in.) ø6.35 (ø1/4) Brazed	ø6.35 (ø1/4) Brazed	ø6.35 (ø1/4) Brazed	ø6.35 (ø1/4) Brazed	
	Gas (R410A)	mm (in.) ø12.7 (ø1/2) Brazed	ø12.7 (ø1/2) Brazed	ø12.7 (ø1/2) Brazed	ø12.7 (ø1/2) Brazed	
Field drain pipe size		mm (in.) I.D. 26mm (1)<Accessory hose O.D.27mm(top end:O.D.20mm)>				
Drawing	External	IU-KB94-L081	IU-KB94-L081	IU-KB94-L081	IU-KB94-L081	
	Wiring	IU-KB94-G985	IU-KB94-G985	IU-KB94-G985	IU-KB94-G985	
	Refrigerant cycle	-	-	-	-	
Standard attachment	Document	Installation Manual, Instruction Book				
	Accessory	Screw plate, Level adjusting screw, Strainer, Drain hose (flexible joint), Hose band				
Remark	Optional parts	-				
	Installation	Details on foundation work, duct work, insulation work, electrical wiring, power source switch, and other items shall be referred to the Installation Manual.				
Note :	*1 Nominal cooling conditions	*2 Nominal cooling conditions	*3 Nominal heating conditions	Unit converter		
	Indoor : 27°CDB/19°CWB (81°FDB/66°FWB)	27°CDB/19.5°CWB (81°FDB/67°FWB)	20°CDB (68°FDB)	kcal/h = kW x 860		
	Outdoor : 35°CDB (95°FDB)	35°CDB (95°FDB)	7°CDB/6°CWB (45°FDB/43°FWB)	Btu/h = kW x 3,412		
	Pipe length : 7.5 m (24-9/16 ft)	5 m (16-3/8 ft)	7.5 m (24-9/16 ft)	cfm = m <sup>3</sup> /min x 35.31		
	Level difference : 0 m (0 ft)	0 m (0 ft)	0 m (0 ft)	lb = kg / 0.4536		
* Nominal conditions *1, *3 are subject to JIS B8615-1.				*Above specification data is subject to rounding variation.		
* Due to continuing improvement, above specification may be subject to change without notice.						
*4 The values are measured at the rated external static pressure.						

Ref.: Spec\_PFFY-P-VLRMM-E\_1

# 1. SPECIFICATIONS

Model			PFFY-P50VLRMM-E	PFFY-P63VLRMM-E			
Power source			1-phase 220-240V (50/60Hz)				
Cooling capacity (Nominal)	*1	kW	5.6	7.1			
		kcal / h	4,800	6,100			
		Btu / h	19,100	24,200			
	*2	kcal / h	5,000	6,300			
		*4 Power input	kW	0.05	0.07		
*4	Current input	A	0.48	0.59			
Heating capacity (Nominal)	*3	kW	6.3	8.0			
		kcal / h	5,400	6,900			
		Btu / h	21,500	27,300			
	*4	Power input	kW	0.05	0.07		
	*4	Current input	A	0.48	0.59		
External finish			Galvanized steel plate				
External dimension H x W x D		mm	639 x 1246 x 220	639 x 1246 x 220			
		in.	25-3/16 x 49-1/16 x 8-11/16	25-3/16 x 49-1/16 x 8-11/16			
Net weight		kg (lb)	25 (56)	27 (60)			
Heat exchanger			Cross fin (Aluminium fin and copper tube)				
FAN	Type x Quantity		Sirocco fan x 2	Sirocco fan x 2			
	External static press.	Pa	20 - <40> - <60>	20 - <40> - <60>			
		mmH <sub>2</sub> O	2.0 - <4.1> - <6.1>	2.0 - <4.1> - <6.1>			
	Motor type		DC blushless motor				
	Motor output	kW	0.096	0.096			
	Driving mechanism		Direct-driven				
	Airflow rate (Low-Mid-High)	m <sup>3</sup> / min	10.0 - 12.0 - 14.0	11.0 - 13.0-15.5			
L / s			167 - 200 - 233	183 - 217 - 258			
cfm			353 - 424 - 494	388 - 459 - 547			
Sound pressure level (Low-Mid-High) (measured in anechoic room)	*4	dB <A>	32 - 37 - 41 (20Pa)	35 - 40 - 44 (20Pa)			
		dB <A>	35 - 40 - 44 (40Pa)	36 - 42 - 47 (40Pa)			
		dB <A>	36 - 41 - 45 (60Pa)	38 - 43 - 48 (60Pa)			
Insulation material			Polyethylene foam, Urethane foam				
Air filter			PP honeycomb fabric (washable)				
Protection device			Fuse				
Refrigerant control device			LEV				
Connectable outdoor unit			R410A CITY MULTI				
Diameter of refrigerant pipe	Liquid (R410A)	mm (in.)	ø6.35 (ø1/4) Brazed	ø9.52 (ø3/8) Brazed			
	Gas (R410A)	mm (in.)	ø12.7 (ø1/2) Brazed	ø15.88 (ø5/8) Brazed			
Field drain pipe size		mm (in.)	I.D. 26mm (1) <Accessory hose O.D.27mm(top end:O.D.20mm)>				
Drawing	External		IU-KB94-L081	IU-KB94-L081			
	Wiring		IU-KB94-G985	IU-KB94-G985			
	Refrigerant cycle		-	-			
Standard attachment	Document		Installation Manual, Instruction Book				
	Accessory		Screw plate, Level adjusting screw, Strainer, Drain hose (flexible joint), Hose band				
Remark	Optional parts		-				
	Installation		Details on foundation work, duct work, insulation work, electrical wiring, power source switch, and other items shall be referred to the Installation Manual.				
<b>Note :</b>			*:1 Nominal cooling conditions	*:2 Nominal cooling conditions	*:3 Nominal heating conditions	Unit converter	
			Indoor : 27°CDB/19°CWB (81°FDB/66°FWB)	27°CDB/19.5°CWB (81°FDB/67°FWB)	20°CDB (68°FDB)	kcal/h = kW x 860	
			Outdoor : 35°CDB (95°FDB)	35°CDB (95°FDB)	7°CDB/6°CWB (45°FDB/43°FWB)	Btu/h = kW x 3,412	
			Pipe length : 7.5 m (24-9/16 ft)	5 m (16-3/8 ft)	7.5 m (24-9/16 ft)	cfm = m <sup>3</sup> /min x 35.31	
			Level difference : 0 m (0 ft)	0 m (0 ft)	0 m (0 ft)	lb = kg / 0.4536	
			* Nominal conditions *:1, *:3 are subject to JIS B8615-1.			*Above specification data is subject to rounding variation.	
			* Due to continuing improvement, above specification may be subject to change without notice.				
			*:4 The values are measured at the rated external static pressure.				

# 2. EXTERNAL DIMENSIONS

R410A Data G6

PFFY-P20,25,32,40VKM-E

Drw. : IU-BK01-B517  
Unit : mm

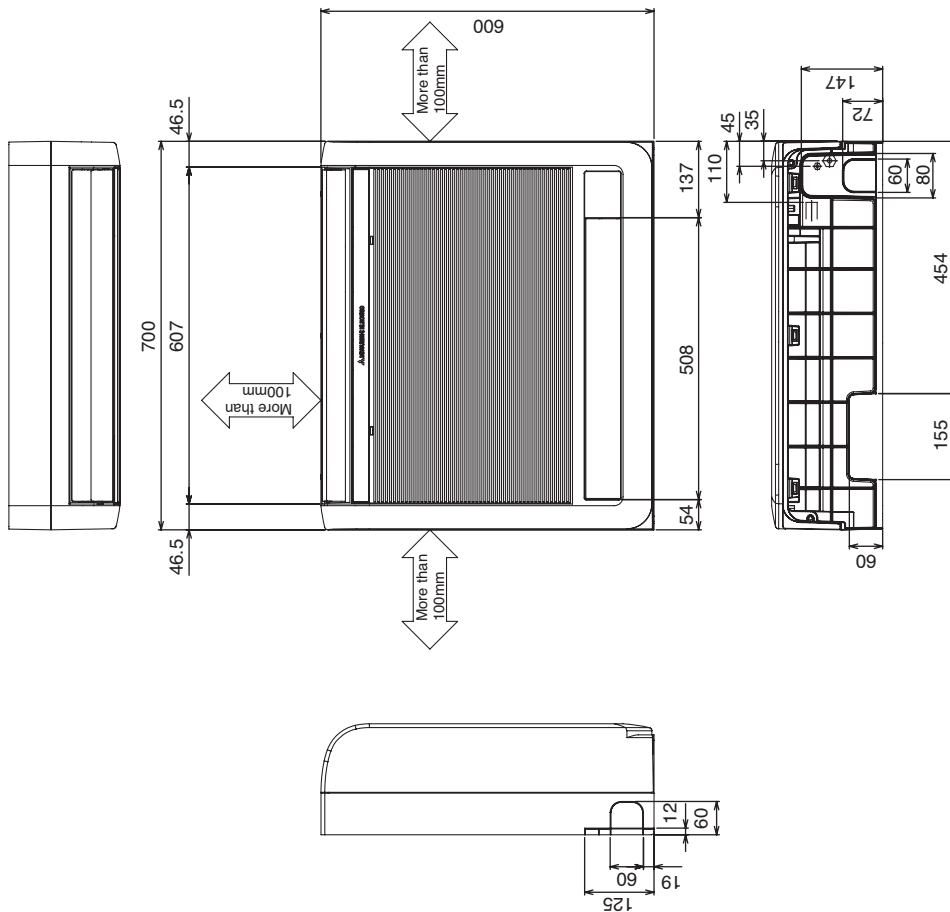
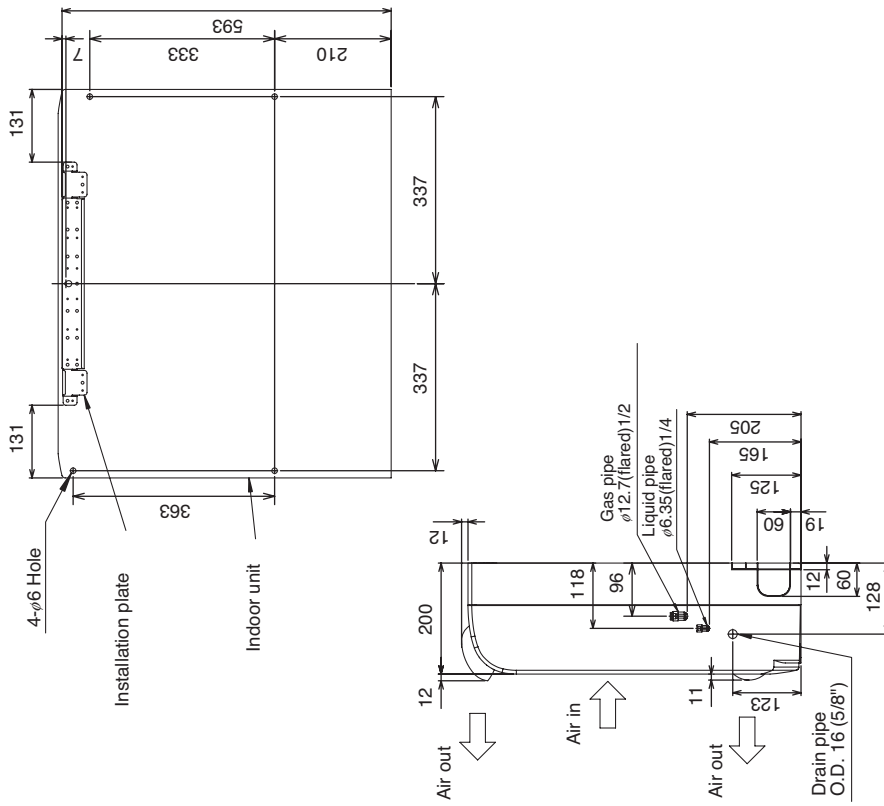

PFFY



# 2. EXTERNAL DIMENSIONS

R410A Data G6

## PFFY-P20,25,32,40,50,63VLEM-E

Drw. : IU-W65-3950  
Unit : mm

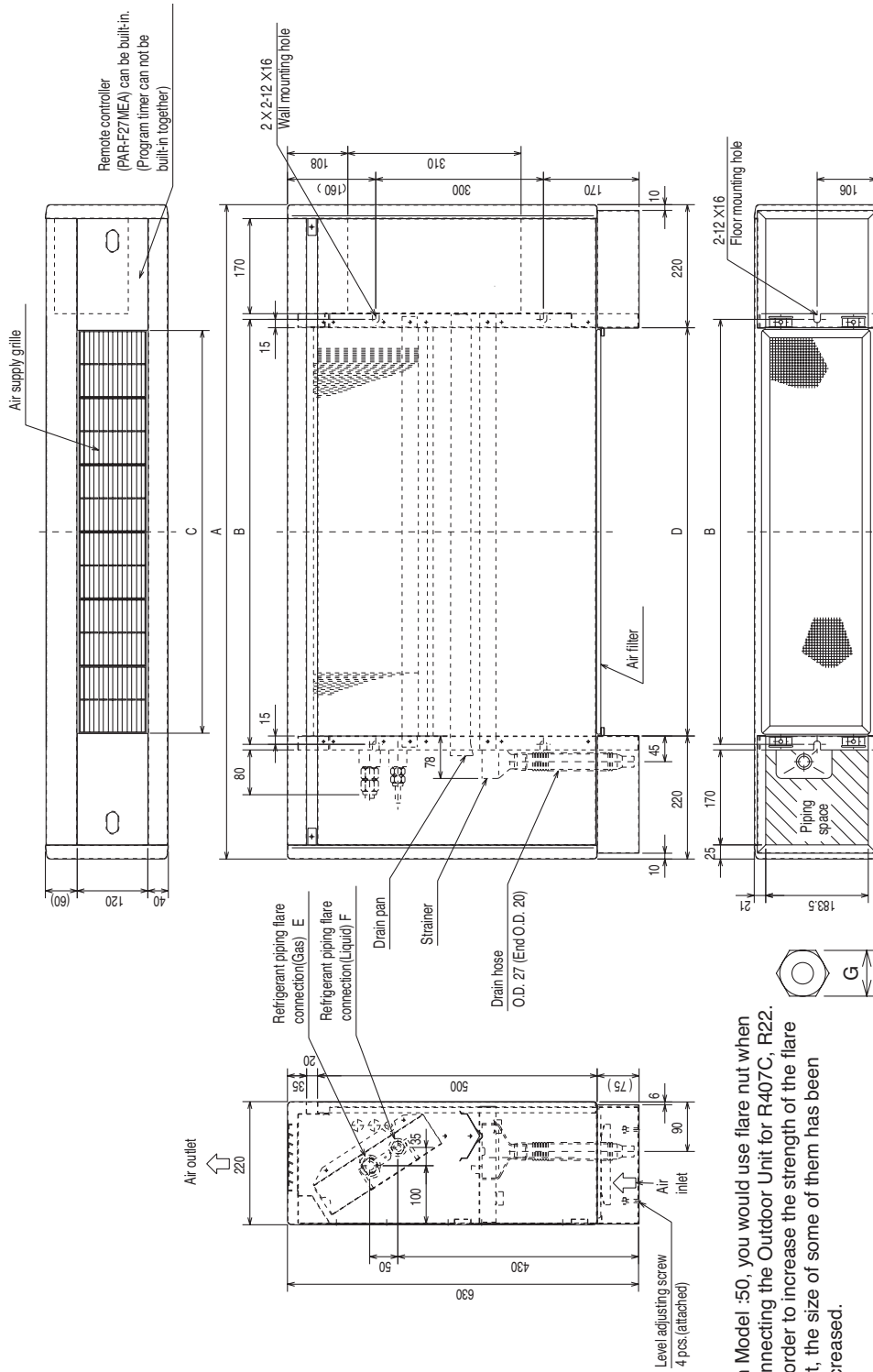

Note: 1. On Model :50, you would use flare nut when connecting the Outdoor Unit for R407C, R22.  
2. In order to increase the strength of the flare nut, the size of some of them has been increased.

Dimensions

Model	A	B	C	D	E (Gas)	F (Liquid)	G (Liquid)	G (Gas)
PFFY-P20VLEM-E	1050	640	600	610	ø12.7	ø6.35	17	27
PFFY-P25VLEM-E	1050	640	600	610	ø12.7	ø6.35	17	27
PFFY-P32VLEM-E	1170	760	720	730	ø12.7	ø6.35	17	27
PFFY-P40VLEM-E	1170	760	720	730	ø12.7	ø6.35	17	27
PFFY-P50VLEM-E	1410	1000	960	970	*1 ø12.7 *2 ø15.88	*1 ø6.35 *2 ø9.52	*1 22 *2 22	*1 29 *2 29
PFFY-P63VLEM-E	1410	1000	960	970	ø15.88	ø9.52	22	29

\*1:R410A outdoor unit  
\*2:R407C,R22 outdoor unit

# 2. EXTERNAL DIMENSIONS

R410A Data G6

PFFY-P20,25,32,40,50,63VLRM-E

Drw. : IU-W65-3951  
Unit : mm

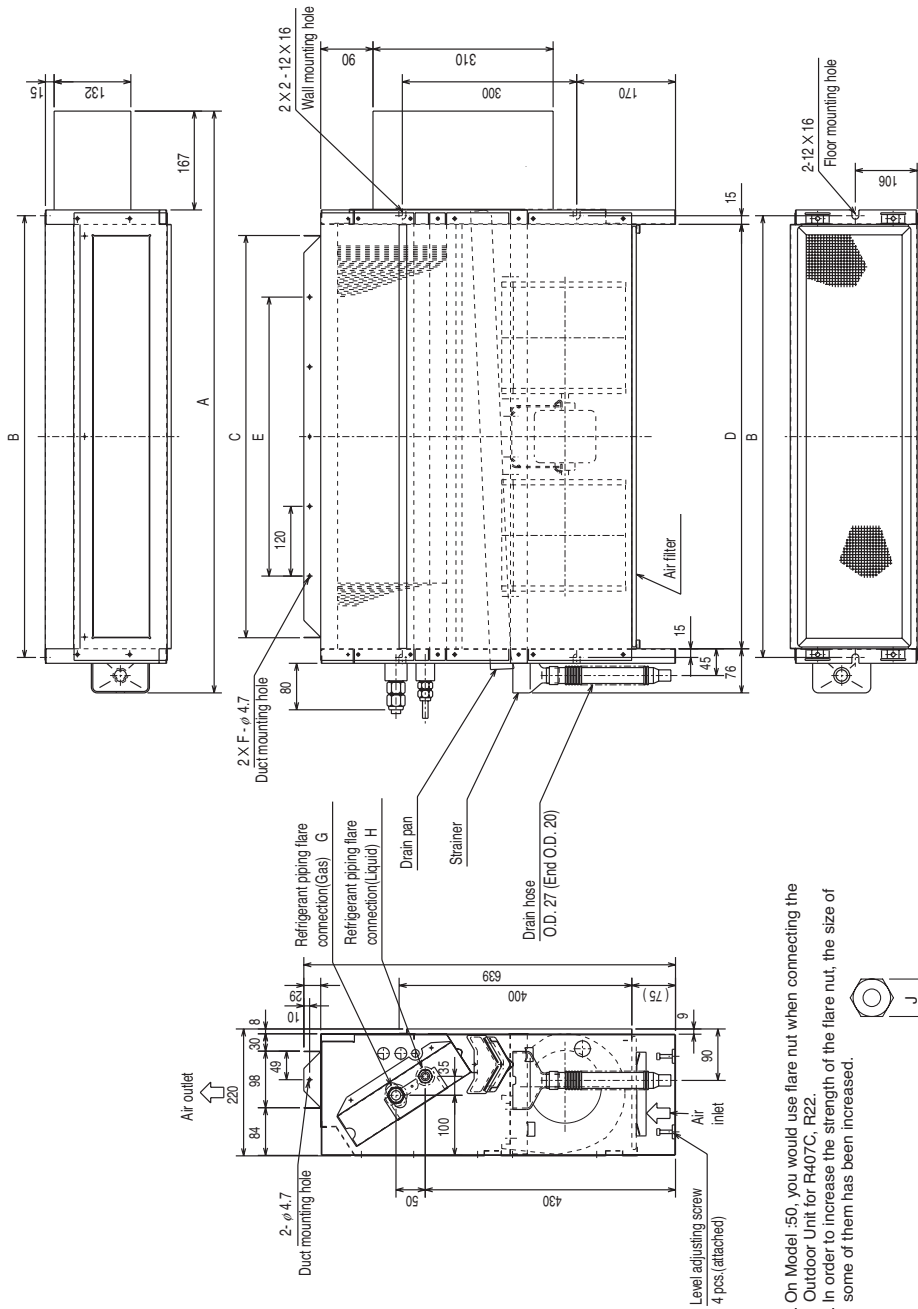

Note: 1. On Model :50, you would use flare nut when connecting the Outdoor Unit for R407C, R22.  
2. In order to increase the strength of the flare nut, the size of some of them has been increased.



\*1:R410A outdoor unit  
\*2:R407C,R22 outdoor unit

Dimensions

Model	A	B	C	D	E	F	G (Gas)	H (Liquid)	J (Liquid)	J (Gas)
PFFY-P20VLRM-E	886	640	572	610	360	4	φ12.7	φ6.35	17	27
PFFY-P25VLRM-E	886	640	572	610	360	4	φ12.7	φ6.35	17	27
PFFY-P32VLRM-E	1006	760	692	730	480	5	φ12.7	φ6.35	17	27
PFFY-P40VLRM-E	1006	760	692	730	480	5	φ12.7	φ6.35	17	27
PFFY-P50VLRM-E	1246	1000	932	970	720	7	*1 φ12.7 *2 φ15.88	*1 φ6.35 *2 φ9.52	*1 22 *2 22	*1 29 *2 29
PFFY-P63VLRM-E	1246	1000	932	970	720	7	φ15.88	φ9.52	22	29

# 2. EXTERNAL DIMENSIONS

PFFY-P20,25,32,40,50,63VLRMM-E

Drw. : IU-KB94-L081  
Unit : mm

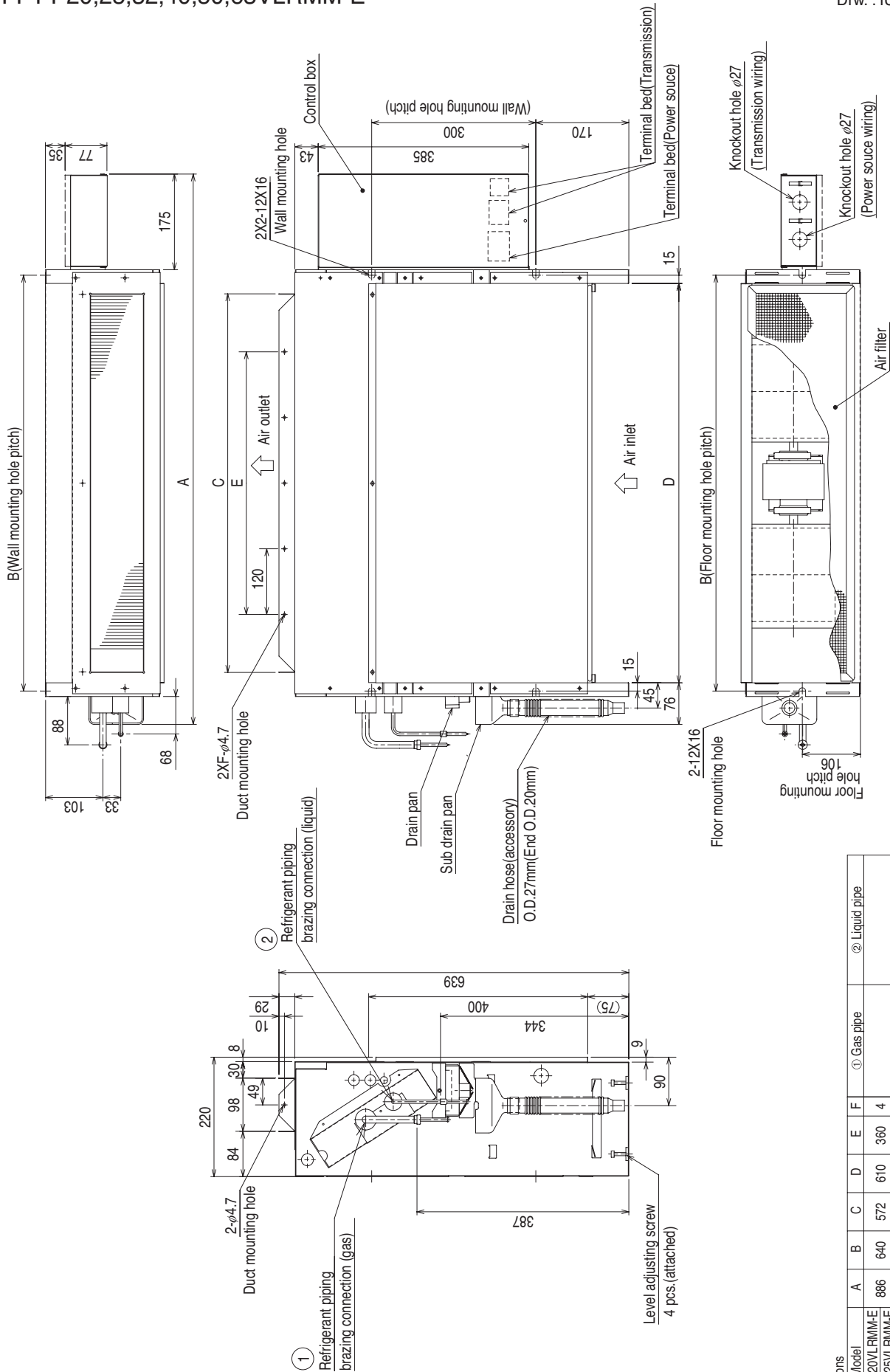

Dimensions	A	B	C	D	E	F	① Gas pipe	② Liquid pipe
Model								
PFFY-P20VLRMM-E	886	640	572	610	360	4		
PFFY-P25VLRMM-E	1006	760	692	730	480	5	φ12.7	φ6.35
PFFY-P32VLRMM-E	1246	1000	932	970	720	7	φ15.88	φ9.52

PFFY

#### PFFY-P20,25,32,40VKM-E

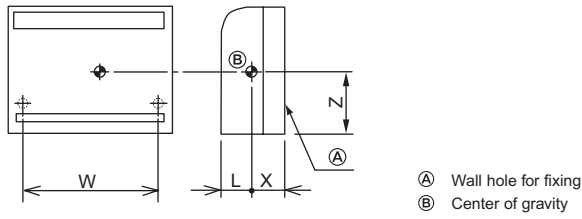

(mm)[in]

Model name	W	L	X	Z
PFFY-P20VKM-E	674 [26-9/16]	85 [3-3/8]	115 [4-9/16]	330 [13]
PFFY-P25VKM-E	674 [26-9/16]	85 [3-3/8]	115 [4-9/16]	330 [13]
PFFY-P32VKM-E	674 [26-9/16]	85 [3-3/8]	115 [4-9/16]	330 [13]
PFFY-P40VKM-E	674 [26-9/16]	85 [3-3/8]	115 [4-9/16]	330 [13]

#### PFFY-P20,25,32,40,50,63VLEM-E

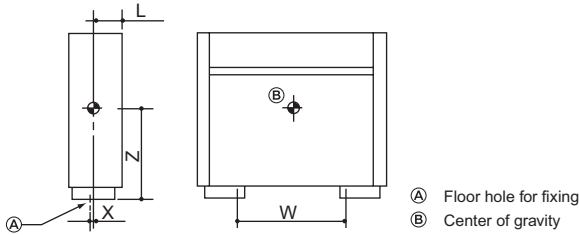

(mm)[in]

Model name	W	L	X	Z
PFFY-P20VLEM-E	640 [25-1/4]	100 [3-15/16]	17 [11/16]	335 [13-1/4]
PFFY-P25VLEM-E	640 [25-1/4]	100 [3-15/16]	17 [11/16]	335 [13-1/4]
PFFY-P32VLEM-E	760 [29-15/16]	100 [3-15/16]	17 [11/16]	335 [13-1/4]
PFFY-P40VLEM-E	760 [29-15/16]	100 [3-15/16]	17 [11/16]	335 [13-1/4]
PFFY-P50VLEM-E	1000 [39-3/8]	100 [3-15/16]	17 [11/16]	335 [13-1/4]
PFFY-P63VLEM-E	1000 [39-3/8]	100 [3-15/16]	17 [11/16]	335 [13-1/4]

#### PFFY-P20,25,32,40,50,63VLRM-E

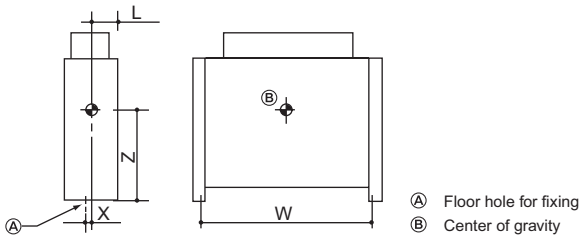

(mm)[in]

Model name	W	L	X	Z
PFFY-P20VLRM-E	640 [25-1/4]	100 [3-15/16]	17 [11/16]	335 [13-1/4]
PFFY-P25VLRM-E	640 [25-1/4]	100 [3-15/16]	17 [11/16]	335 [13-1/4]
PFFY-P32VLRM-E	760 [29-15/16]	100 [3-15/16]	17 [11/16]	335 [13-1/4]
PFFY-P40VLRM-E	760 [29-15/16]	100 [3-15/16]	17 [11/16]	335 [13-1/4]
PFFY-P50VLRM-E	1000 [39-3/8]	100 [3-15/16]	17 [11/16]	335 [13-1/4]
PFFY-P63VLRM-E	1000 [39-3/8]	100 [3-15/16]	17 [11/16]	335 [13-1/4]

#### PFFY-P20,25,32,40,50,63VLRMM-E

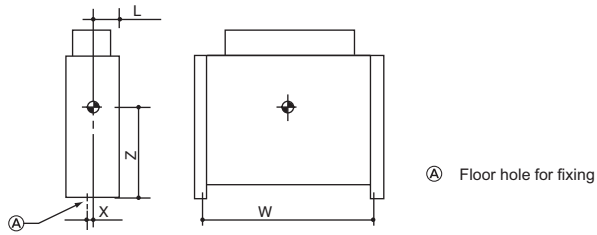

(mm)[in]

Model name	W	L	X	Z
PFFY-P20VLRMM-E	640 [25-1/4]	100 [3-15/16]	17 [11/16]	335 [13-1/4]
PFFY-P25VLRMM-E	640 [25-1/4]	100 [3-15/16]	17 [11/16]	335 [13-1/4]
PFFY-P32VLRMM-E	760 [29-15/16]	100 [3-15/16]	17 [11/16]	335 [13-1/4]
PFFY-P40VLRMM-E	760 [29-15/16]	100 [3-15/16]	17 [11/16]	335 [13-1/4]
PFFY-P50VLRMM-E	1000 [39-3/8]	100 [3-15/16]	17 [11/16]	335 [13-1/4]
PFFY-P63VLRMM-E	1000 [39-3/8]	100 [3-15/16]	17 [11/16]	335 [13-1/4]

PFFY-P20,25,32,40VKM-E

Drw. : IU-RG79-V367

[LEGEND]

SYMBOL	NAME	SYMBOL	NAME	SYMBOL	NAME	
I. B	INDOOR CONTROLLER BOARD	MF1	FAN MOTOR (UPPER)	TH23	PIPE TEMP. DETECTION/GAS (0°C/15kΩ, 25°C/5.4kΩ)	
CN32	CONNECTOR	REMOTE SWITCH	MF2	FAN MOTOR (LOWER)		
CN51		CENTRALLY CONTROL	MV1	VANE MOTOR	A. B	
CN52		REMOTE INDICATION	MV2	DAMPER MOTOR	ADDRESS BOARD	
SW2	SWITCH	CAPACITY CODE	LS	DAMPER LIMIT SWITCH (CLOSE)	SW1	SWITCH
SW3		MODE SELECTION	LEV	LINEAR EXPANSION VALVE	SW11	ADDRESS SETTING 1ST DIGIT
SW4		MODEL SELECTOR	TB2	TERMINAL BLOCK	SW12	ADDRESS SETTING 2ND DIGIT
ZNR	VARISTOR		TB5	TERMINAL BLOCK	SW14	CONNECTION NO.
FUSE	FUSE (T6.3AL250V)		TB5	TERMINAL BLOCK	SWC	AIR OUTLET SELECTION
LED1	POWER SUPPLY (I.B)	TH21	THERMISTOR			
LED2	POWER SUPPLY (I.B)					

NOTES

1. At servicing for outdoor unit, always follow the wiring diagram of outdoor unit.
2. In case of connecting MA-Remote controller, please connect MA remote controller cable in an accessory to the connector [1][2]. (Remote controller wire is non-polar.)
3. In case of using M-NET, please connect to TB5. (Transmission line is non-polar.)
4. Symbol [S] of TB5 is the shield wire connection.
5. Symbols used in wiring diagram above are, ⊙: terminal block, □□□: connector.
6. The setting of the SW2 dip switches differs in the capacity for the detail, refer to the fig:\*1.

LED on indoor board for service

MARK	MEANING	FUNCTION
LED1	Main power supply	Main power supply (Indoor unit:220-240V) power on → lamp is lit
LED2	Power supply for MA-Remote controller	Power supply for MA-remote controller on → lamp is lit

<fig:\*1>

MODELS	SW2
P20	ON OFF  1 2 3 4 5 6
P25	ON OFF  1 2 3 4 5 6
P32	ON OFF  1 2 3 4 5 6
P40	ON OFF  1 2 3 4 5 6

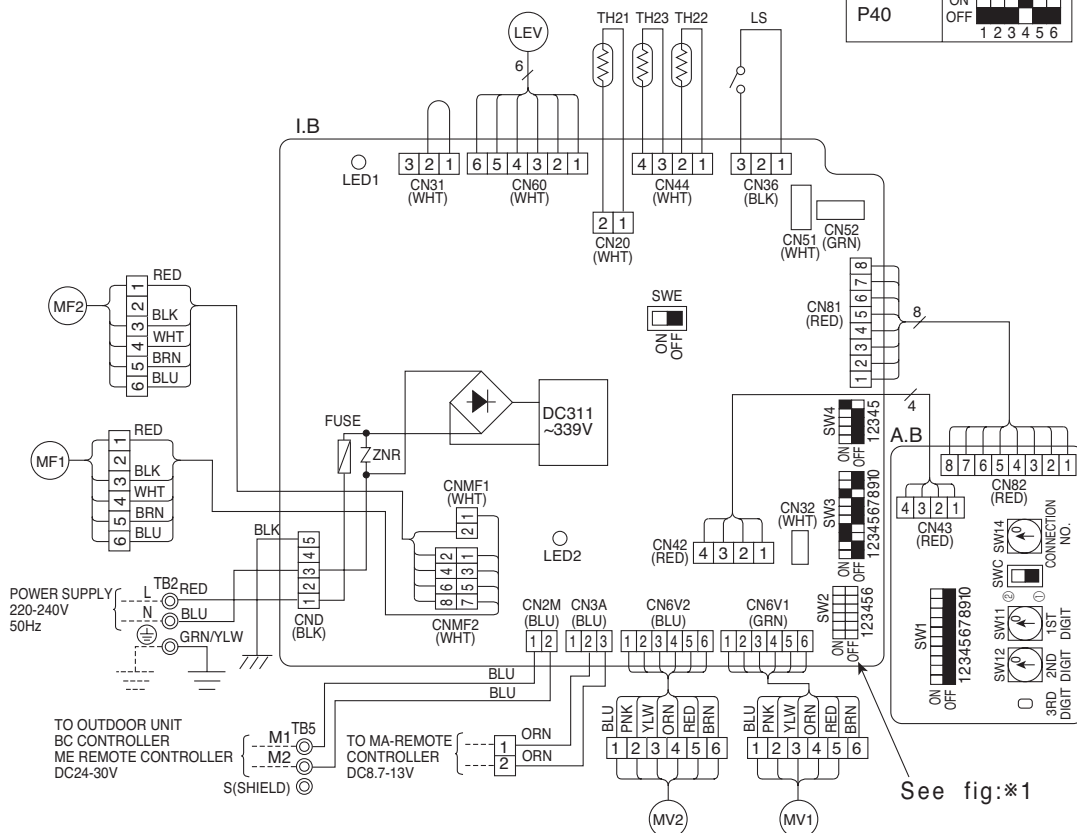

See fig:\*1

PFFY

PFFY-P20,25,32,40,50,63VLEM-E, VLRM-E

Drw. : IU-W65-3960

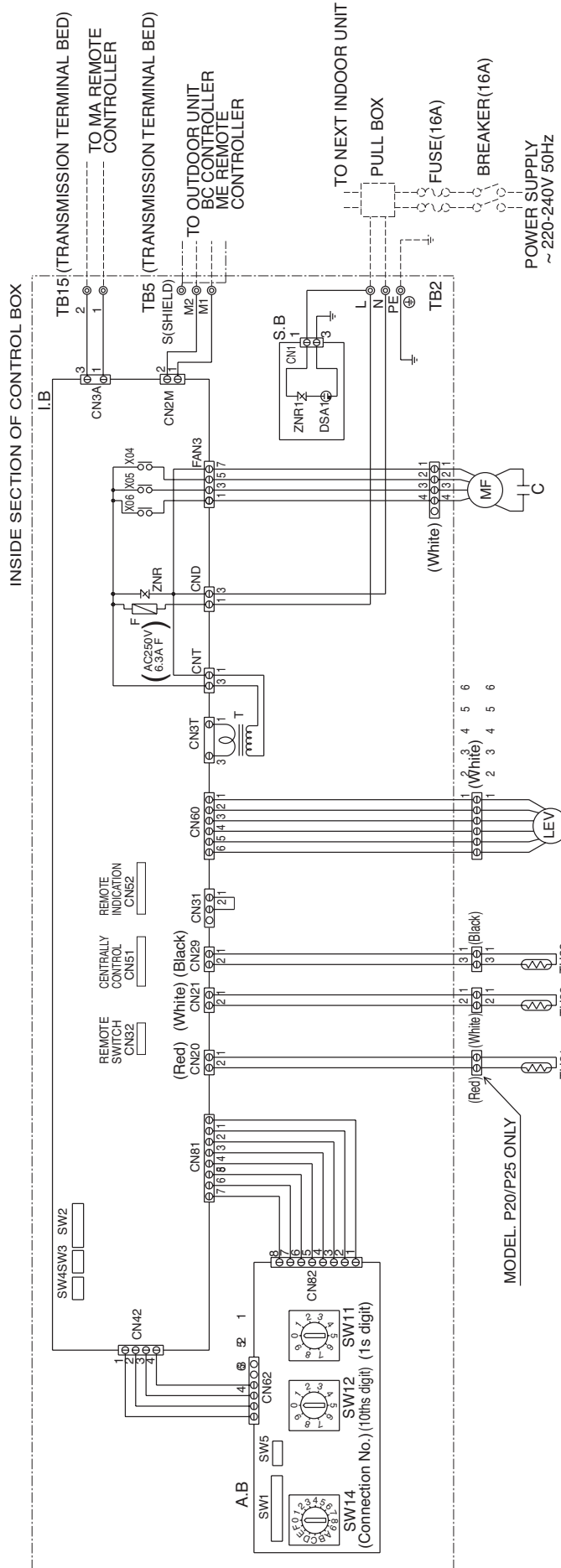

SYMBOL EXPLANATION

SYMBOL	NAME	SYMBOL	NAME
MF	Fan motor	TH22	Thermistor (piping temp.detection/liquid)
C	Capacitor (for MF)	TH23	Thermistor (piping temp.detection/gas)
I.B	Indoor controller board	SW11 (A.B)	Switch (1s digit address set)
A.B	Address board	SW12 (A.B)	Switch (10ths digit address set)
TB2	Power source terminal bed	SW14 (A.B)	Switch (connection No.set)
TB5	Transmission terminal bed	SW1 (A.B)	Switch(for mode selection)
TB15	Transmission terminal bed	SW2 (I.B)	Switch(for capacity code)
F	Fuse AC250V 6.3A F	SW3 (I.B)	Switch(for mode selection)
T	Transformer	SW4 (I.B)	Switch(for model selection)
LEV	Electronic linear expan. valve	SW5 (A.B)	Switch(for voltage selection)
S.B	Surge absorber board	X04~06	Aux.relay
TH21	Thermistor (inlet temp.detection)		

PFFY-P20,25,32,40,50,63VLRMM-E

Drw. : IU-KB94-G985

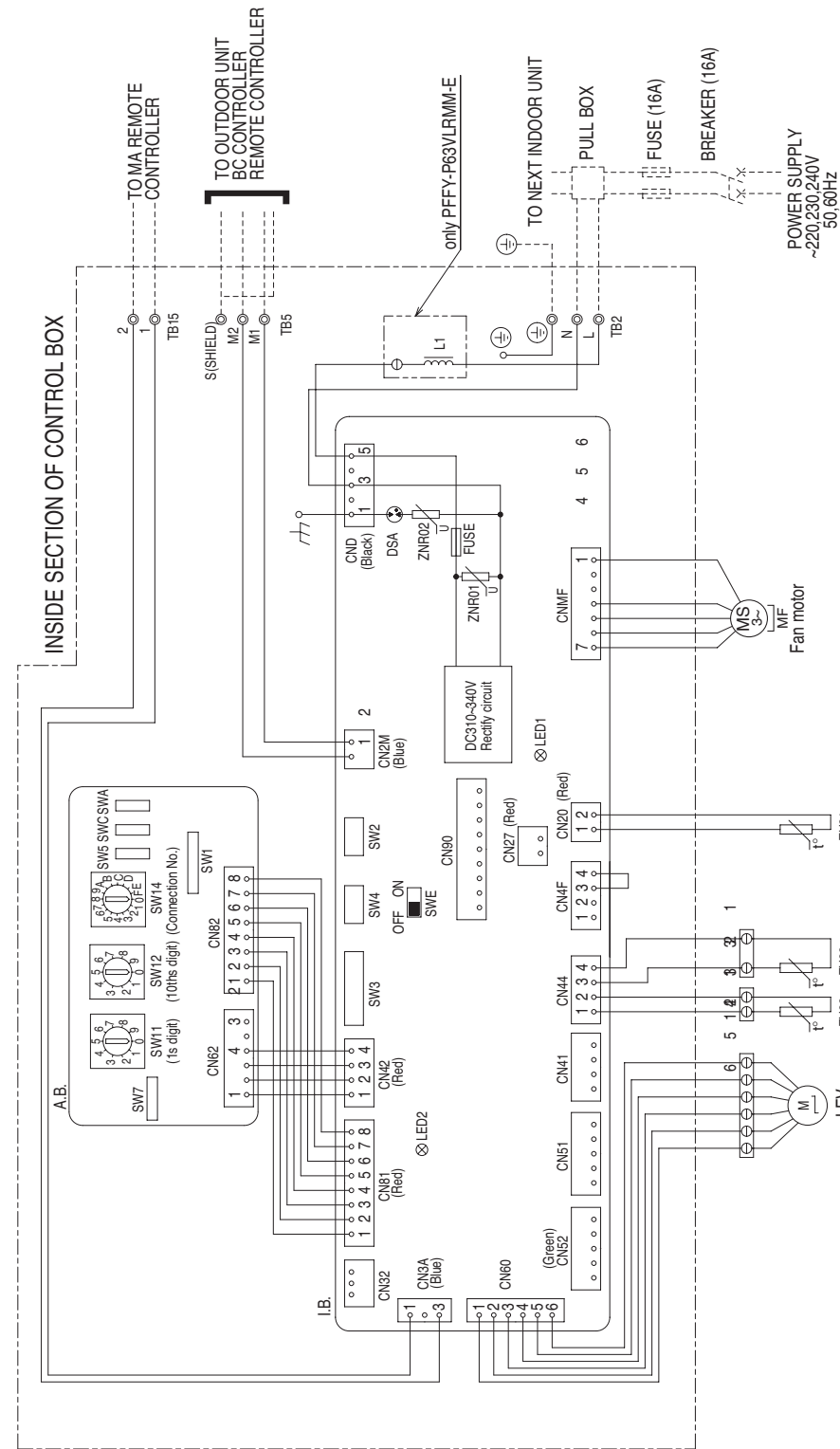

NOTE:1. The wirings to TB2, TB5, TB15 shown in dotted line are field work.  
2. Mark ⊙ indicates terminal bed, ⊖ connector.

OPERATION OF LED FOR INDOOR CIRCUIT BOARD SERVICE

SYMBOL	LED operation under normal state
LED1	At applying main power source → Lighting
LED2	At receiving MA transmission power source → Lighting

SYMBOL EXPLANATION

SYMBOL	NAME	SYMBOL	NAME
I.B.	Indoor controller board	A.B.	Address board
FUSE	Fuse <AC250V 6.3A>	SW1	Switch (for mode selection)
ZNR01,02	Varistor	SW5	Switch (for mode selection)
DSA	Arrester	SW7	Switch (for model selection)
CN27	Connector (Dampner)	SW11	Switch (1s digit address set)
CN32	Connector (Remote switch)	SW12	Switch (10ths digit address set)
CN41	Connector (HA terminal-A)	SW14	Switch (connection No.set)
CN51	Connector (Centrally control)	SWA	Switch (for static pressure selection)
CN52	Connector (Remote indication)	SWC	Switch (for static pressure selection)
CN90	Connector (Wireless)	TB2	Power source terminal bed
SW2	Switch (for capacity code)	TB5	Transmission terminal bed
SW3	Switch (for mode selection)	TB15	Transmission terminal bed
SW4	Switch (for model selection)	TH21	Thermistor (inlet air temp.detection)
SW6	Connector (emergency operation)	TH22	Thermistor (piping temp.detection/liquid)
L1	AC reactor(Power factor improvement)	TH23	Thermistor (piping temp.detection/gas)
		LEV	Electronic linear expans.valve



# 5. SOUND LEVELS

## 5-1. Sound levels

PFFY-P-VKM-E,VLEM-E,VLRM-E

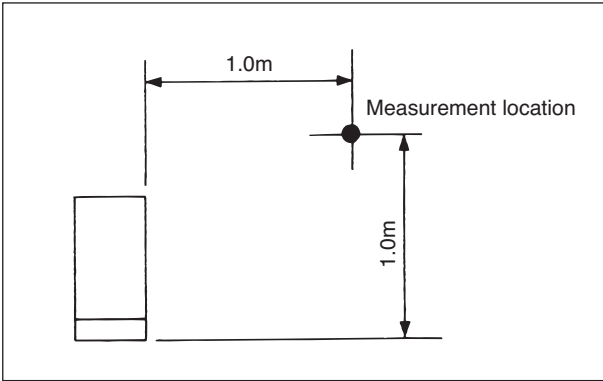

\* Measured in anechoic room.

Sound level at anechoic room : Low-High

	Sound level dB (A)
PFFY-P20VKM-E	27-31-34-37
PFFY-P25VKM-E	28-32-35-38
PFFY-P32VKM-E	28-32-35-38
PFFY-P40VKM-E	35-38-42-44
PFFY-P20VLEM-E	34-40
PFFY-P20VLRM-E	
PFFY-P25VLEM-E	
PFFY-P25VLRM-E	35-40
PFFY-P32VLEM-E	
PFFY-P32VLRM-E	
PFFY-P40VLEM-E	38-43
PFFY-P40VLRM-E	
PFFY-P50VLEM-E	
PFFY-P50VLRM-E	
PFFY-P63VLEM-E	40-46
PFFY-P63VLRM-E	

PFFY-P-VLRMM-E

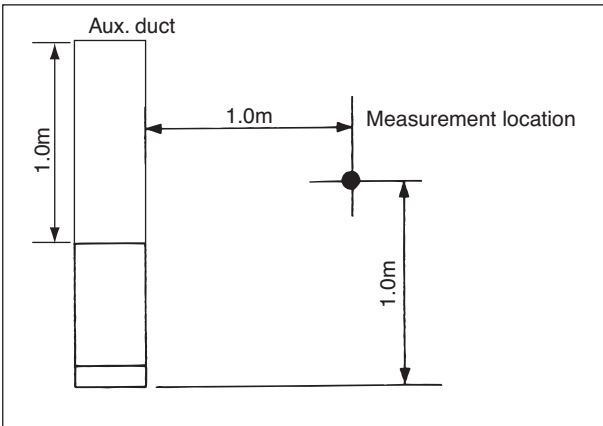

\* Measured in anechoic room.

Sound level at anechoic room : Low-middle-High

	Sound level dB (A)		
	20Pa	40Pa	60Pa
PFFY-P20VLRMM-E	31-36-40	34-39-42	35-40-43
PFFY-P25VLRMM-E	31-36-40	34-39-42	35-40-43
PFFY-P32VLRMM-E	27-32-37	30-35-41	32-37-42
PFFY-P40VLRMM-E	30-36-40	32-38-42	35-39-44
PFFY-P50VLRMM-E	32-37-41	35-40-44	36-41-45
PFFY-P63VLRMM-E	35-40-44	36-42-47	38-43-48

## 5-2. NC curves

PFFY-P20VKM-E

External static pressure : 0Pa  
Power source : 220,230,240V, 50Hz

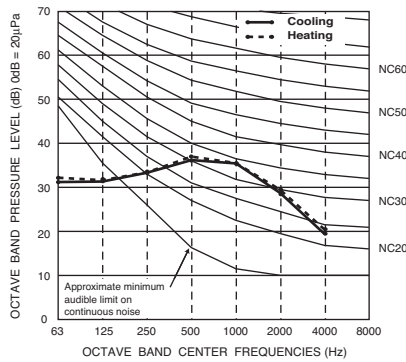

PFFY-P25,32VKM-E

External static pressure : 0Pa  
Power source : 220,230,240V, 50Hz

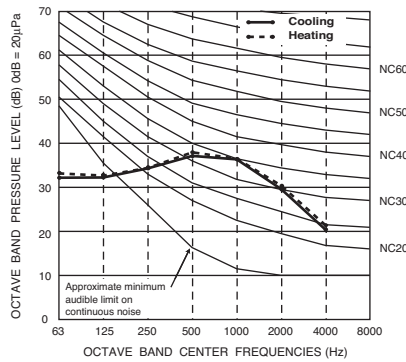

PFFY-P40VKM-E

External static pressure : 0Pa  
Power source : 220,230,240V, 50Hz

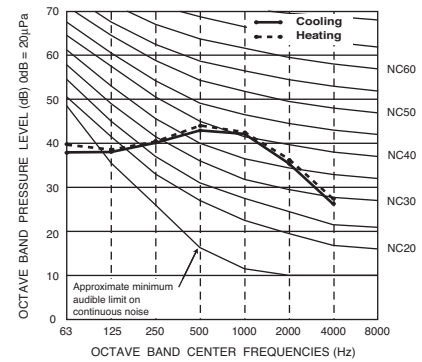

PFFY-P20,25VLEM-E,VLRM-E

External static pressure : 0Pa  
Power source : 220,230,240V, 50Hz / 208,220,230V, 60Hz

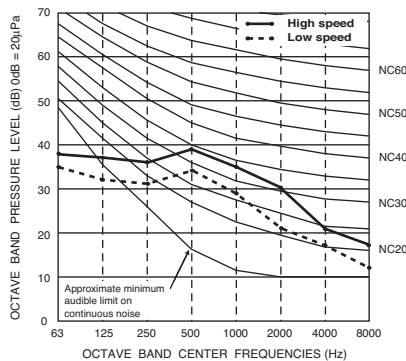

PFFY-P32VLEM-E,VLRM-E

External static pressure : 0Pa  
Power source : 220,230,240V, 50Hz / 208,220,230V, 60Hz

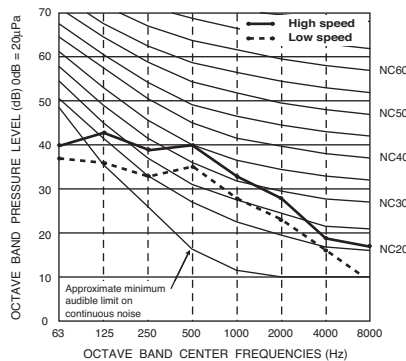

PFFY-P40VLEM-E,VLRM-E

External static pressure : 0Pa  
Power source : 220,230,240V, 50Hz / 208,220,230V, 60Hz

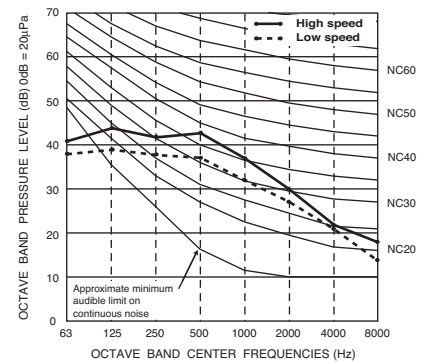

# 5. SOUND LEVELS

## 5-2. NC curves

### PFFY-P50VLEM-E, VLRM-E

External static pressure : 0Pa

Power source : 220,230,240V, 50Hz / 208,220,230V, 60Hz

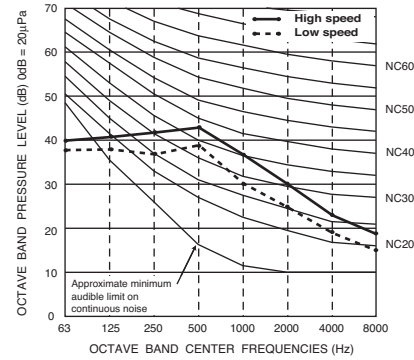

### PFFY-P63VLEM-E, VLRM-E

External static pressure : 0Pa

Power source : 220,230,240V, 50Hz / 208,220,230V, 60Hz

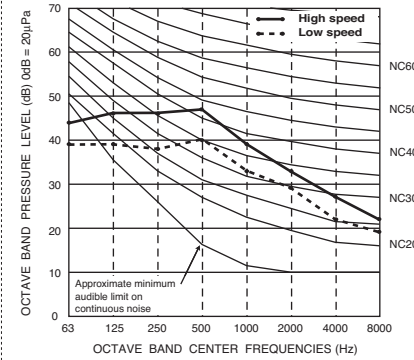

### PFFY-P20,25VLRMM-E

External static pressure : 20Pa

Power source : 220,230,240V, 50/60Hz

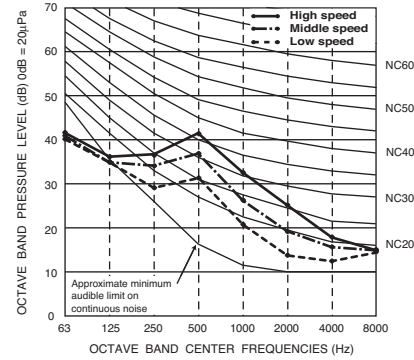

### PFFY-P20,25VLRMM-E

External static pressure : 40Pa

Power source : 220,230,240V, 50/60Hz

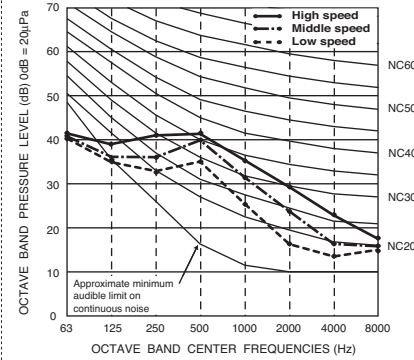

### PFFY-P20,25VLRMM-E

External static pressure : 60Pa

Power source : 220,230,240V, 50/60Hz

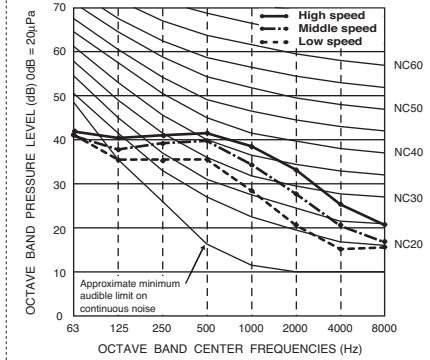

### PFFY-P32VLRMM-E

External static pressure : 20Pa

Power source : 220,230,240V, 50/60Hz

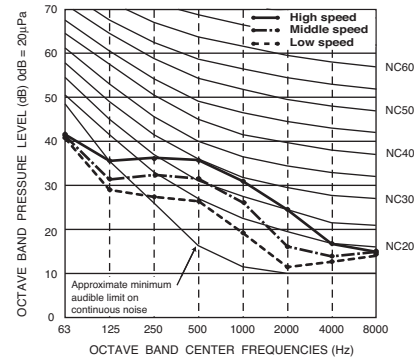

### PFFY-P32VLRMM-E

External static pressure : 40Pa

Power source : 220,230,240V, 50/60Hz

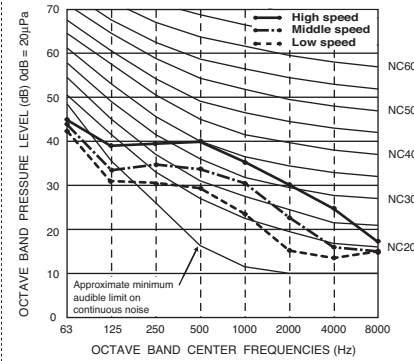

### PFFY-P32VLRMM-E

External static pressure : 60Pa

Power source : 220,230,240V, 50/60Hz

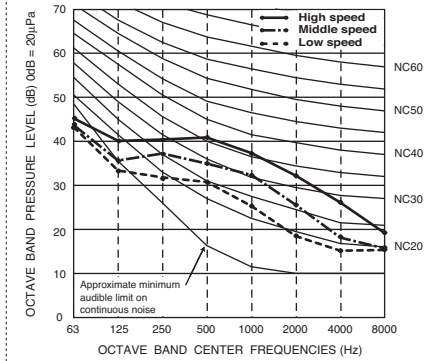

### PFFY-P40VLRMM-E

External static pressure : 20Pa

Power source : 220,230,240V, 50/60Hz

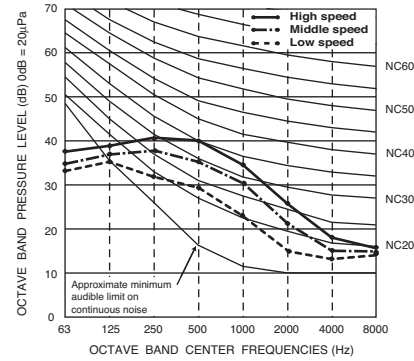

### PFFY-P40VLRMM-E

External static pressure : 40Pa

Power source : 220,230,240V, 50/60Hz

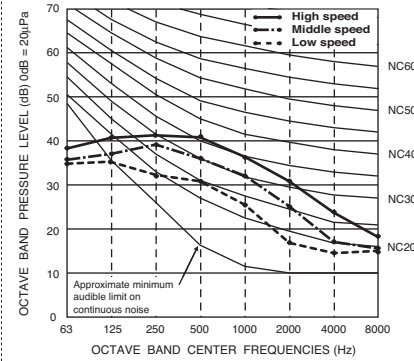

### PFFY-P40VLRMM-E

External static pressure : 60Pa

Power source : 220,230,240V, 50/60Hz

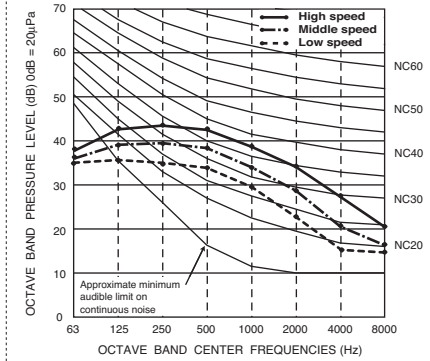

PFFY

## 5-2. NC curves

### PFFY-P50VLRMM-E

External static pressure : 20Pa  
Power source : 220,230,240V, 50/60Hz

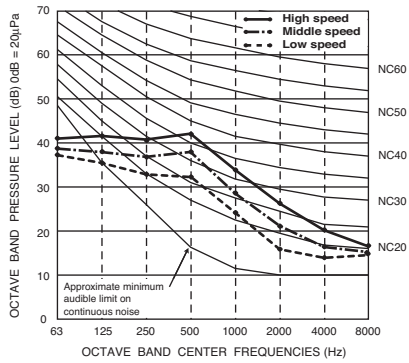

### PFFY-P50VLRMM-E

External static pressure : 40Pa  
Power source : 220,230,240V, 50/60Hz

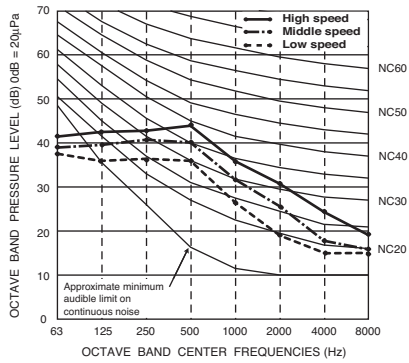

### PFFY-P50VLRMM-E

External static pressure : 60Pa  
Power source : 220,230,240V, 50/60Hz

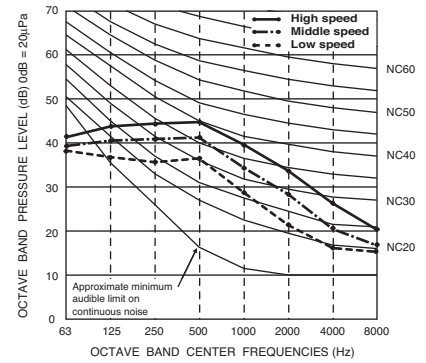

### PFFY-P63VLRMM-E

External static pressure : 20Pa  
Power source : 220,230,240V, 50/60Hz

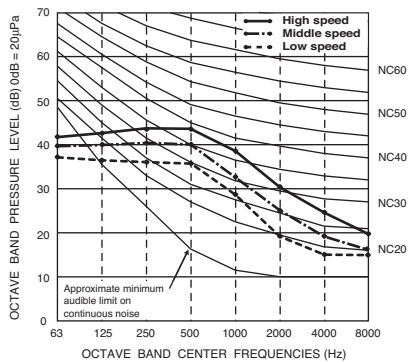

### PFFY-P63VLRMM-E

External static pressure : 40Pa  
Power source : 220,230,240V, 50/60Hz

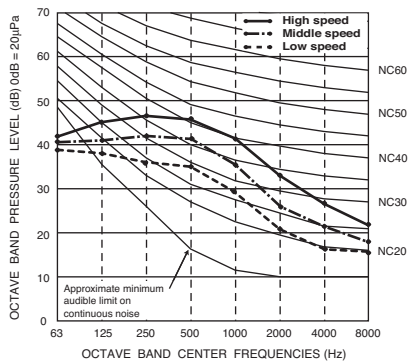

### PFFY-P63VLRMM-E

External static pressure : 60Pa  
Power source : 220,230,240V, 50/60Hz

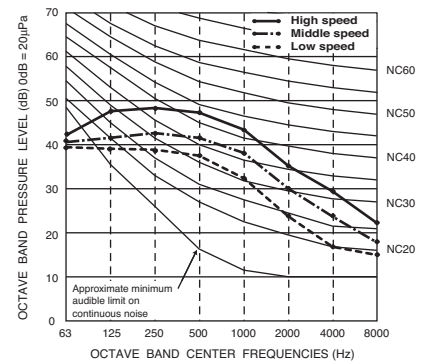

# 5. SOUND LEVELS

## 5-3. Fan characteristics curves

### PFFY-P20,25VLRMM-E

External static pressure : 20Pa  
Power source : 220,230,240V, 50/60Hz

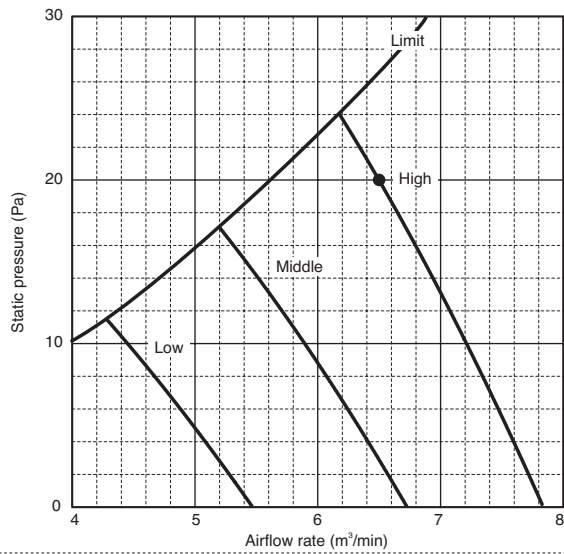

### PFFY-P20,25VLRMM-E

External static pressure : 40Pa  
Power source : 220,230,240V, 50/60Hz

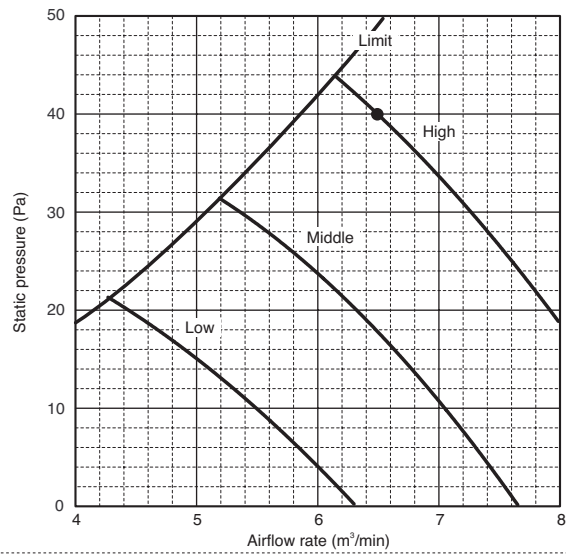

### PFFY-P20,25VLRMM-E

External static pressure : 60Pa  
Power source : 220,230,240V, 50/60Hz

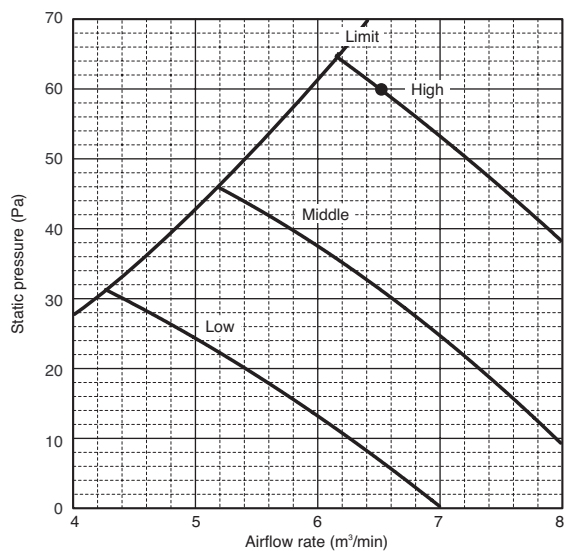

### PFFY-P32VLRMM-E

External static pressure : 20Pa  
Power source : 220,230,240V, 50/60Hz

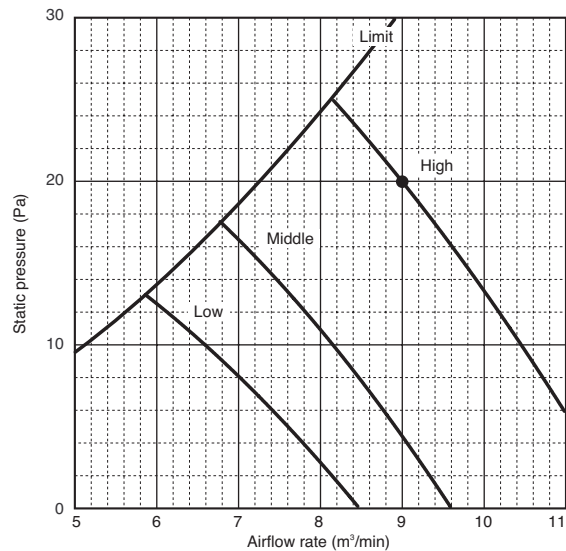

### PFFY-P32VLRMM-E

External static pressure : 40Pa  
Power source : 220,230,240V, 50/60Hz

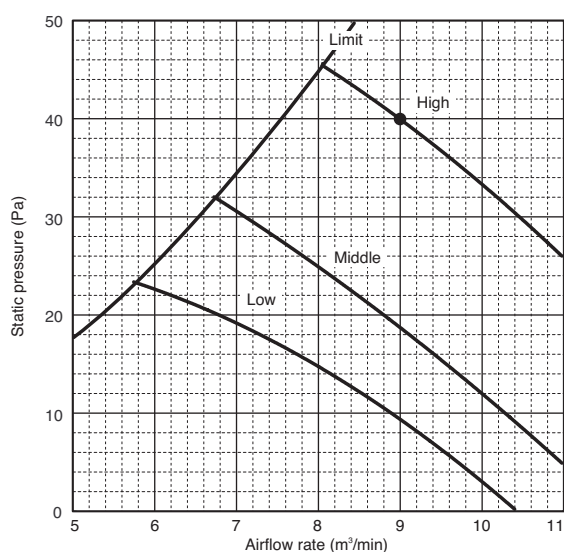

### PFFY-P32VLRMM-E

External static pressure : 60Pa  
Power source : 220,230,240V, 50/60Hz

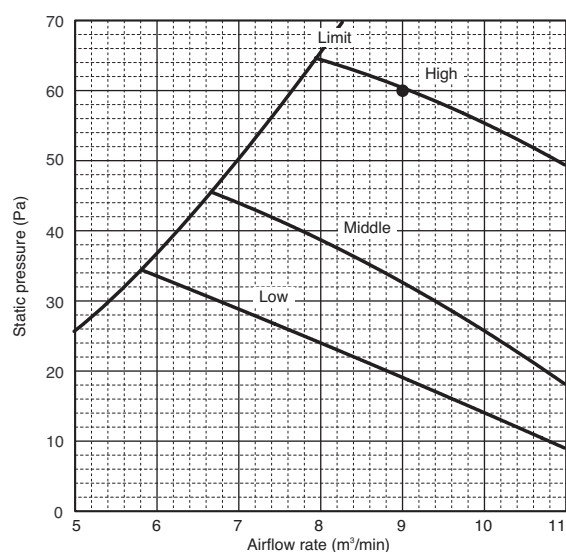

PFFY



## 5-3. Fan characteristics curves

### PFFY-P40VLRMM-E

External static pressure : 20Pa  
Power source : 220,230,240V, 50/60Hz

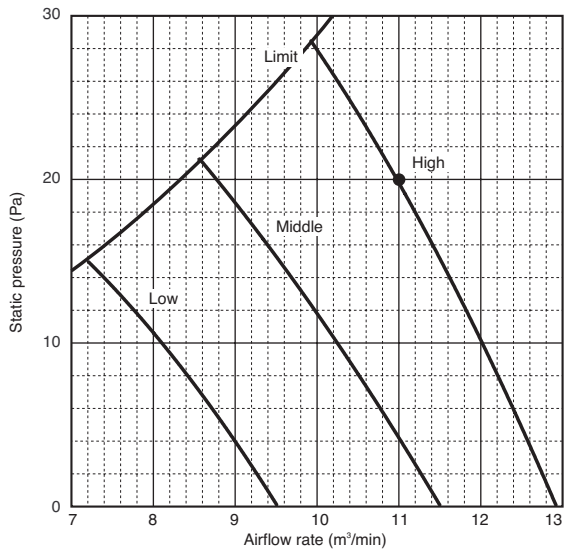

### PFFY-P40VLRMM-E

External static pressure : 40Pa  
Power source : 220,230,240V, 50/60Hz

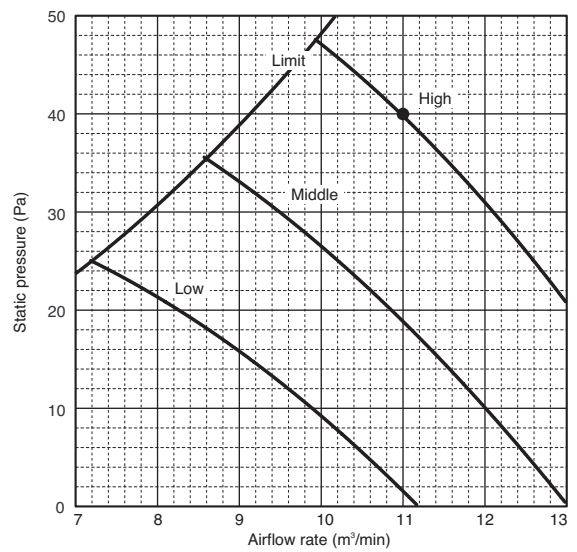

### PFFY-P40VLRMM-E

External static pressure : 60Pa  
Power source : 220,230,240V, 50/60Hz

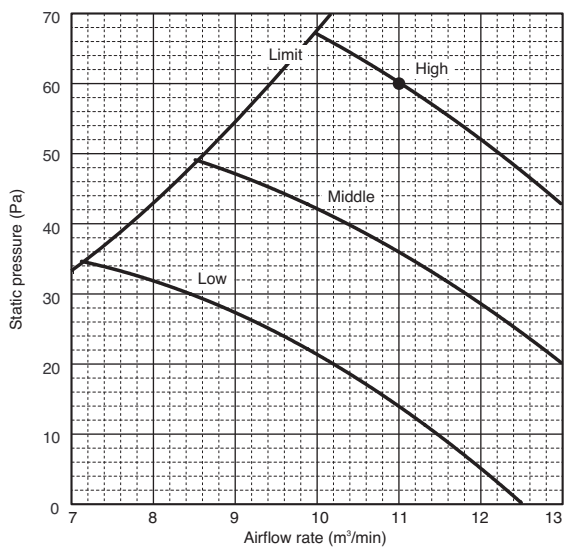

### PFFY-P50VLRMM-E

External static pressure : 20Pa  
Power source : 220,230,240V, 50/60Hz

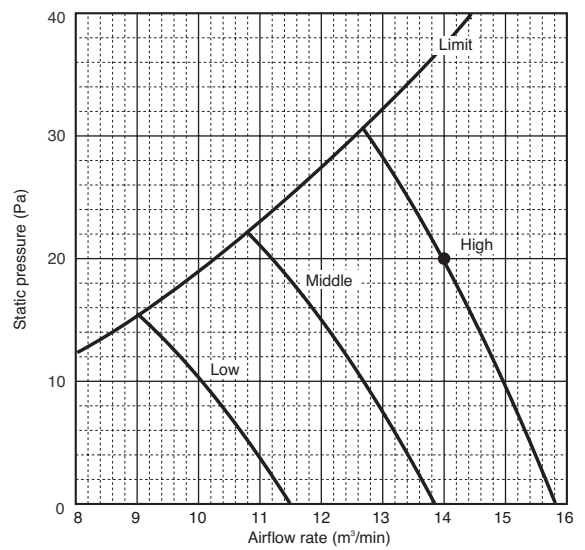

### PFFY-P50VLRMM-E

External static pressure : 40Pa  
Power source : 220,230,240V, 50/60Hz

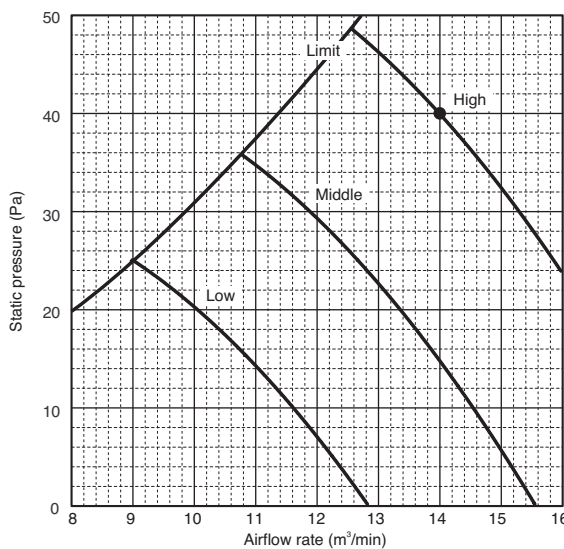

### PFFY-P50VLRMM-E

External static pressure : 60Pa  
Power source : 220,230,240V, 50/60Hz

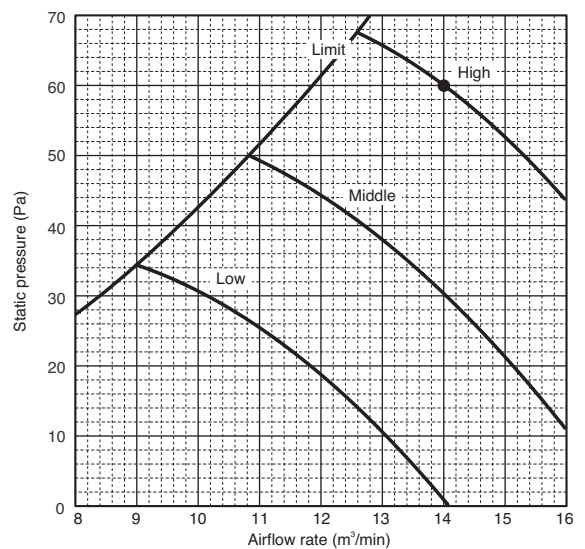

PFFY

## 5-3. Fan characteristics curves

### PFFY-P63VLRMM-E

External static pressure : 20Pa  
 Power source : 220,230,240V, 50/60Hz

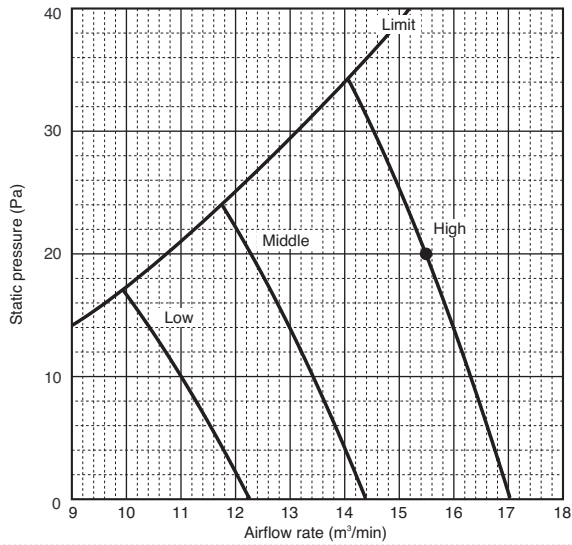

### PFFY-P63VLRMM-E

External static pressure : 40Pa  
 Power source : 220,230,240V, 50/60Hz

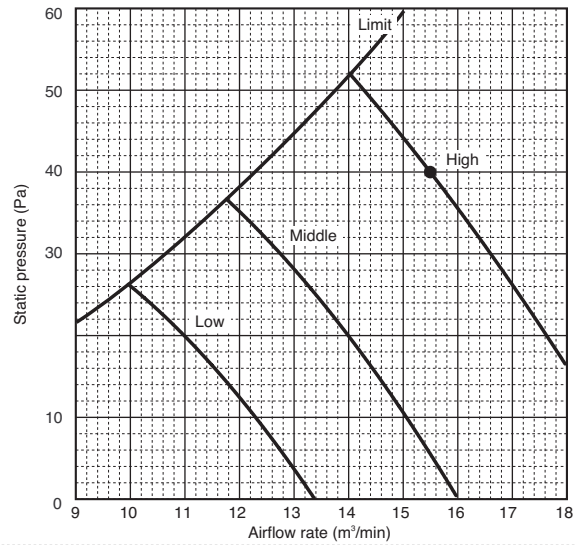

### PFFY-P63VLRMM-E

External static pressure : 60Pa  
 Power source : 220,230,240V, 50/60Hz

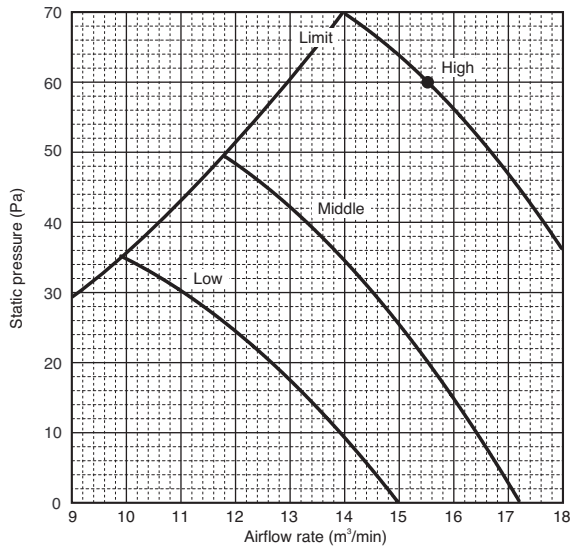

PFFY

## 6-1. Temperature distributions

PFFY-P-VLEM-E, VLRM-E

<Cooling mode>

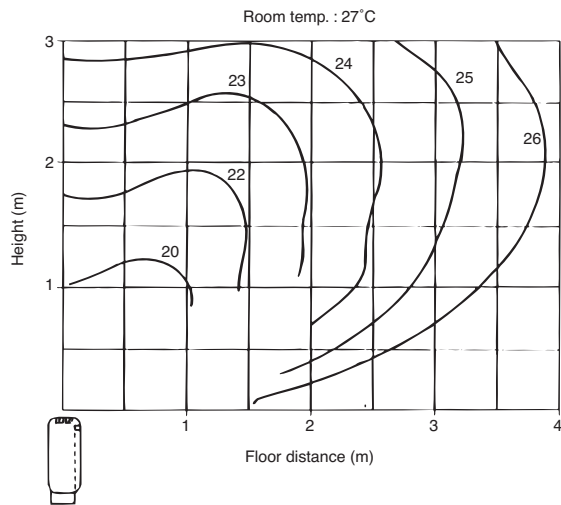

<Heating mode>

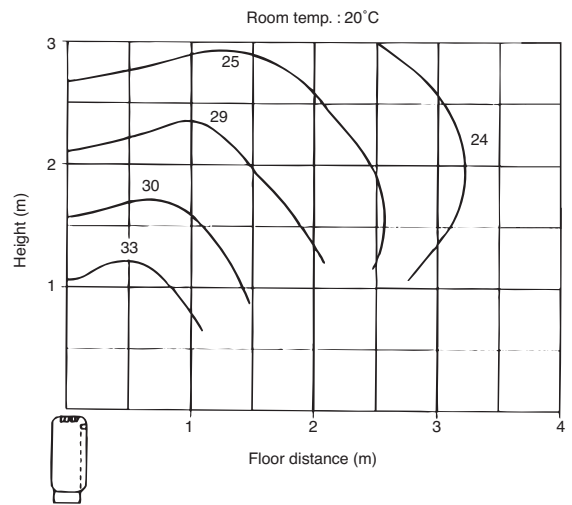

PFFY-P-VKM-E

<Cooling mode>

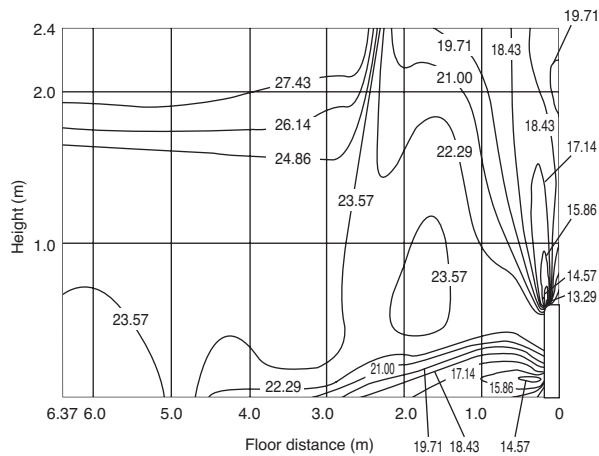

<Heating mode>

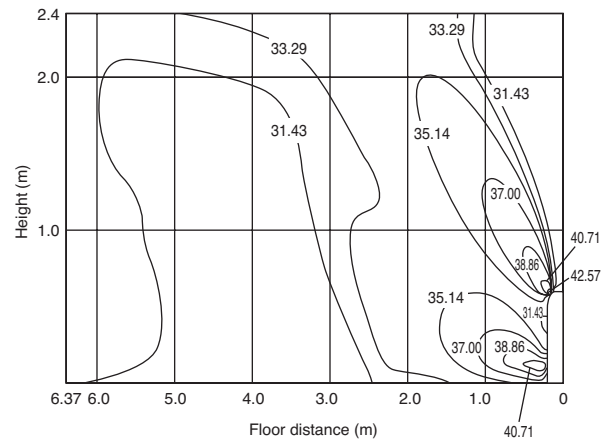

Note : These figures show typical temperature distributions in the conditions above. In the actual installation, they may differ from these figures under the influence of air temperature conditions, ceiling height, cooling/heating load, obstacles, etc.

## 6-2. Airflow distributions

PFFY-P-VLEM-E,VLRM-E

<Cooling mode>

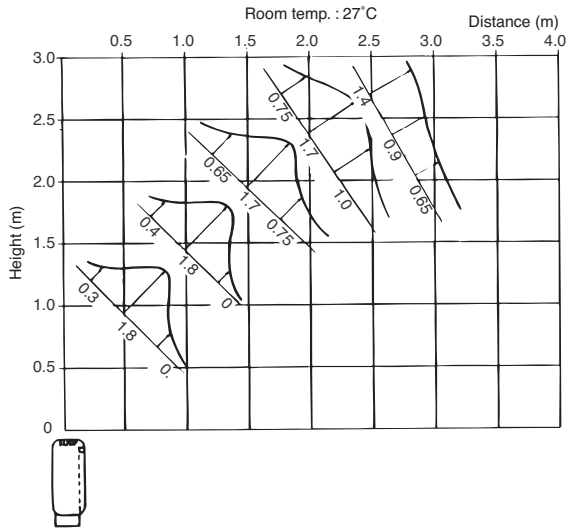

<Heating mode>

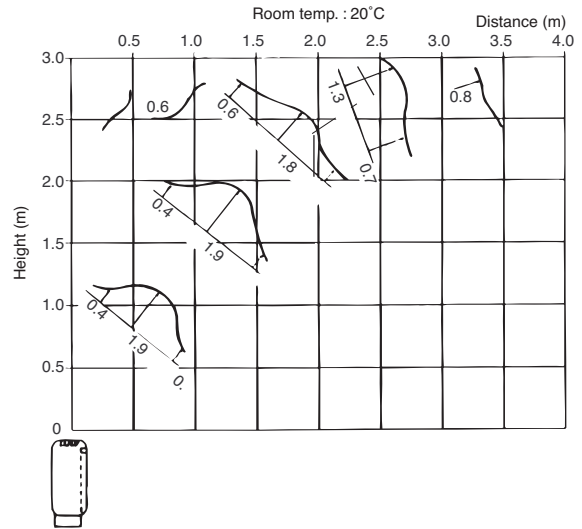

PFFY-P-VKM-E

<Cooling mode>

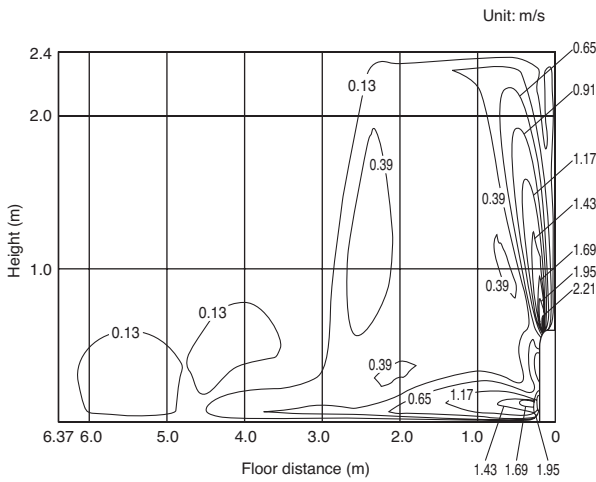

<Heating mode>

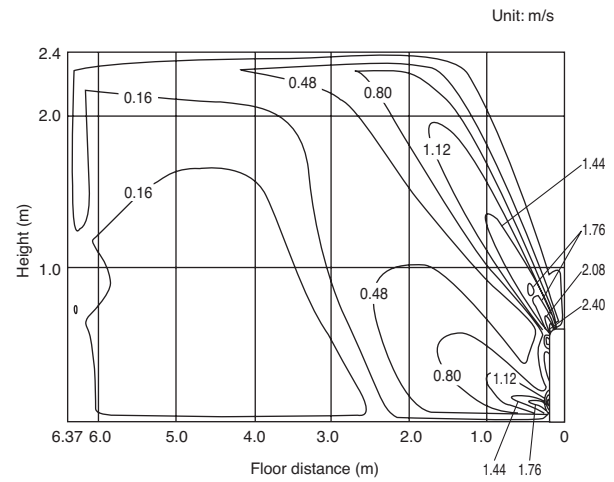

Note : These figures show typical airflow distributions in the conditions above. In the actual installation, they may differ from these figures under the influence of air temperature conditions, ceiling height, cooling/heating load, obstacles, etc.