

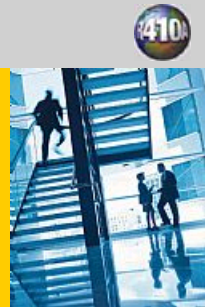

# PFFY-P40VKM-E

Indoor Unit

Floor Standing Exposed



The PFFY-P-VKM-E series is extremely versatile and is designed for wall attached installation at floor level. The auto swing vane provides a more natural and comfortable airflow throughout the room and the lightweight, compact design makes installation easy.

- **Pure white, slimline design**
- **Upper and lower vanes for optimum, powerful and efficient air distribution**



Pictures not to scale

## Product Details

PFFY-P40VKM-E	
Capacity (kW):	
Heating (Nominal)	5.0
Cooling (Nominal)	4.5
Heating (UK)	5.0
Cooling (UK)	4.3
R410A High Sensible Cooling (UK)	3.3
SHF R410A (UK)	0.7
SHF High Sensible R410A (UK)	0.76
Power Input (kW) Heating (Nominal)	0.028
Power Input (kW) Cooling (Nominal)	0.028
Airflow(m <sup>3</sup> /min) - Lo-Mi1-Mi2-Hi	8-9-9.5-10.7
Noise (dBA) - Lo-Mi1-Mi2-Hi	35-38-42-44
Width - mm	700
Depth - mm	200
Height - mm	600
Weight - kg	15
Electrical Supply	220-240v, 50Hz
Phase	Single
Mains Cable No. Cores	3
Running Current (A) - Heating	0.24
Running Current (A) - Cooling	0.24
Fuse Rating (BS88) - HRC (A)	6

## Dimensions

### PFFY-P40VKM-E

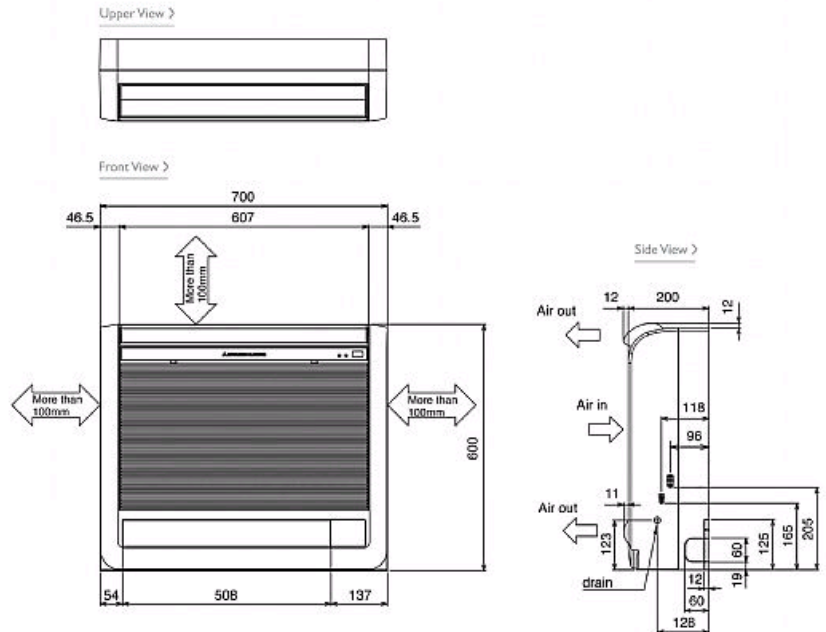

Telephone: 01707 282880

Email: [air.conditioning@meuk.mee.com](mailto:air.conditioning@meuk.mee.com) Website: <http://www.mitsubishielectric.co.uk/aircon>

Mitsubishi Electric reserves the right to make any variation in technical specification to the equipment described, or to withdraw or replace products without prior notification or public announcement.

Tel:  
Fax:

