



PFFY-P32VKM-E

Indoor Unit

Floor Standing Exposed

The PFFY-P-VKM-E series is extremely versatile and is designed for wall attached installation at floor level. The auto swing vane provides a more natural and comfortable airflow throughout the room and the lightweight, compact design makes installation easy.

- **Pure white, slimline design**
- **Upper and lower vanes for optimum, powerful and efficient air distribution**



Pictures not to scale



Product Details

PFFY-P32VKM-E	
Capacity (kW):	
Heating (Nominal)	4.0
Cooling (Nominal)	3.6
R410A Heating (UK)	3.7
R407c Heating (UK)	3.7
R410A Cooling (UK)	3.4
R407c Cooling (UK)	3.4
R410A High Sensible Cooling (UK)	2.6
SHF R410A (UK)	0.71
SHF R407c (UK)	0.71
SHF High Sensible R410A (UK)	0.77
Power Input (kW) Heating (Nominal)	0.025
Power Input (kW) Cooling (Nominal)	0.025
Airflow(m ³ /min) - Lo-Mi1-Mi2-Hi	6.1-7-8-9.1
Noise (dBA) - Lo-Mi1-Mi2-Hi	28-32-35-38
Width - mm	700
Depth - mm	200
Height - mm	600
Weight - kg	15
Electrical Supply	220-240v, 50Hz
Phase	Single
Mains Cable No. Cores	3
Running Current (A) - Heating	0.2
Running Current (A) - Cooling	0.2
Fuse Rating (BS88) - HRC (A)	6

Dimensions

PFFY-P32VKM-E

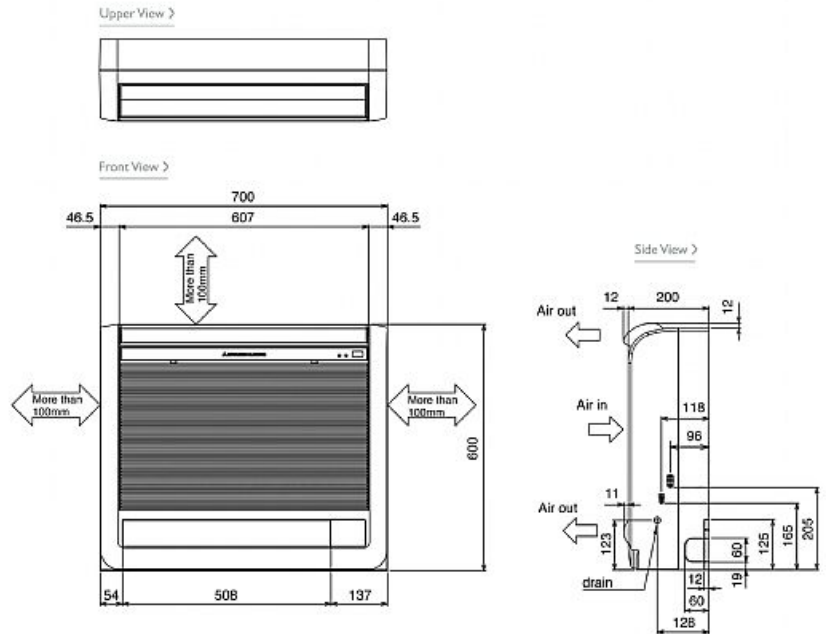

Telephone: 01707 282880

Email: air.conditioning@meuk.mee.com Website: <http://www.mitsubishielectric.co.uk/aircon>

Mitsubishi Electric reserves the right to make any variation in technical specification to the equipment described, or to withdraw or replace products without prior notification or public announcement.

Tel:
Fax:

