

Changes for the Better

Models **PU(H)Y-P250YGM-A**
PUHY-P500YGM-A
PFD-P250VM-E
PFD-P500VM-E

R410A

Service Handbook

Safety Precautions

- Before installing the unit, thoroughly read the following safety precautions.
- Observe these safety precautions for your safety.

⚠ WARNING

This symbol is intended to alert the user to the presence of important instructions that must be followed to avoid the risk of serious injury or death.

⚠ CAUTION

This symbol is intended to alert the user to the presence of important instructions that must be followed to avoid the risk of serious injury or damage to the unit.

- After reading this manual, give it to the user to retain for future reference.
 - Keep this manual for easy reference. When the unit is moved or repaired, give this manual to those who provide these services.
- When the user changes, make sure that the new user receives this manual.

⚠ WARNING

Ask your dealer or a qualified technician to install the unit.

Improper installation by the user may result in water leakage, electric shock, smoke, and/or fire.

Properly install the unit on a surface that can withstand the weight of the unit.

Unit installed on an unstable surface may fall and cause injury.

Only use specified cables. Securely connect each cable so that the terminals do not carry the weight of the cable.

Improperly connected or fixed cables may produce heat and start a fire.

Take appropriate safety measures against strong winds and earthquakes to prevent the unit from falling.

If the unit is not installed properly, the unit may fall and cause serious injury to the person or damage to the unit.

Do not make any modifications or alterations to the unit. Consult your dealer for repair.

Improper repair may result in water leakage, electric shock, smoke, and/or fire.

Do not touch the heat exchanger fins.

The fins are sharp and dangerous.

In the event of a refrigerant leak, thoroughly ventilate the room.

If refrigerant gas leaks and comes in contact with an open flame, poisonous gases will be produced.

Properly install the unit according to the instructions in the installation manual.

Improper installation may result in water leakage, electric shock, smoke, and/or fire.

Have all electrical work performed by an authorized electrician according to the local regulations and instructions in this manual, and a dedicated circuit must be used.

Insufficient capacity of the power supply circuit or improper installation may result in malfunctions of the unit, electric shock, smoke, and/or fire.

Securely attach the terminal block cover (panel) to the unit.

If the terminal block cover (panel) is not installed properly, dust and/or water may infiltrate and pose a risk of electric shock, smoke, and/or fire.

Only use the type of refrigerant that is indicated on the unit when installing or reinstalling the unit.

Infiltration of any other type of refrigerant or air into the unit may adversely affect the refrigerant cycle and may cause the pipes to burst or explode.

 **WARNING**

When installing the unit in a small room, exercise caution and take measures against leaked refrigerant reaching the limiting concentration.

Consult your dealer with any questions regarding limiting concentrations and for precautionary measures before installing the unit. Leaked refrigerant gas exceeding the limiting concentration causes oxygen deficiency.

Consult your dealer or a specialist when moving or reinstalling the unit.

Improper installation may result in water leakage, electric shock, and/or fire.

After completing the service work, check for a gas leak.

If leaked refrigerant is exposed to a heat source, such as a fan heater, stove, or electric grill, poisonous gases may be produced.

Do not try to defeat the safety features of the unit.

Forced operation of the pressure switch or the temperature switch by defeating the safety features of these devices, or the use of accessories other than the ones that are recommended by MITSUBISHI may result in smoke, fire, and/or explosion.

Only use accessories recommended by MITSUBISHI.

Ask a qualified technician to install the unit. Improper installation by the user may result in water leakage, electric shock, smoke, and/or fire.

Precautions for handling units for use with R410A

CAUTION

Do not use the existing refrigerant piping.

- ♦A large amount of chlorine that may be contained in the residual refrigerant and refrigerating machine oil in the existing piping may cause the refrigerating machine oil in the new unit to deteriorate.
- ♦R410A is a high-pressure refrigerant and can cause the existing pipes to burst.

Use refrigerant pipes made of phosphorus deoxidized copper. Keep the inner and outer surfaces of the pipes clean and free of such contaminants as sulfur, oxides, dust, dirt, shaving particles, oil, and water.

These types of contaminants inside the refrigerant pipes may cause the refrigerant oil to deteriorate.

Store the pipes to be installed indoors, and keep both ends of the pipes sealed until immediately before brazing. (Keep elbows and other joints wrapped in plastic.)

Infiltration of dust, dirt, or water into the refrigerant system may cause the refrigerating machine oil to deteriorate or cause the unit to malfunction.

Use a small amount of ester oil, ether oil, or alkylbenzene to coat flares and flanges.

Infiltration of a large amount of mineral oil may cause the refrigerating machine oil to deteriorate.

Charge liquid refrigerant (as opposed to gaseous refrigerant) into the system.

If gaseous refrigerant is charged into the system, the composition of the refrigerant in the cylinder will change and may result in performance loss.

Use a vacuum pump with a reverse-flow check valve.

If a vacuum pump that is not equipped with a reverse-flow check valve is used, the vacuum pump oil may flow into the refrigerant cycle and cause the refrigerating machine oil to deteriorate.

Prepare tools for exclusive use with R410A. Do not use the following tools if they have been used with the conventional refrigerant (gauge manifold, charging hose, gas leak detector, reverse-flow check valve, refrigerant charge base, vacuum gauge, and refrigerant recovery equipment.).

- ♦If the refrigerant or the refrigerating machine oil left on these tools are mixed in with R410A, it may cause the refrigerating machine oil to deteriorate.
- ♦Infiltration of water may cause the refrigerating machine oil to deteriorate.
- ♦Gas leak detectors for conventional refrigerants will not detect an R410A leak because R410A is free of chlorine.

Do not use a charging cylinder.

If a charging cylinder is used, the composition of the refrigerant will change, and the unit may experience power loss.

Exercise special care when handling the tools for use with R410A.

Infiltration of dust, dirt, or water into the refrigerant system may cause the refrigerating machine oil to deteriorate.

Only use refrigerant R410A.

The use of other types of refrigerant that contain chlorine (i.e. R22) may cause the refrigerating machine oil to deteriorate.

Before installing the unit

 **WARNING**

Do not install the unit where a gas leak may occur.

If gaseous refrigerant leaks and piles up around the unit, it may be ignited.

Do not use the unit to keep food items, animals, plants, artifacts, or for other special purposes.

The unit is not designed to preserve food products.

Do not use the unit in an unusual environment.

- ♦ Do not install the unit where a large amount of oil or steam is present or where acidic or alkaline solutions or chemical sprays are used frequently. Doing so may lead to a remarkable drop in performance, electric shock, malfunctions, smoke, and/or fire.

- ♦ The presence of organic solvents or corrosive gas (i.e. ammonia, sulfur compounds, and acid) may cause gas leakage or water leakage.

When installing the unit in a hospital, take appropriate measures to reduce noise interference.

High-frequency medical equipment may interfere with the normal operation of the air conditioner or vice versa.

Do not install the unit on or over things that cannot get wet.

When the humidity level exceeds 80% or if the drainage system is clogged, the indoor unit may drip water. Drain water is also discharged from the outdoor unit. Install a centralized drainage system if necessary.

Before installing the unit (moving and reinstalling the unit) and performing electrical work

CAUTION

Properly ground the unit.

Do not connect the grounding wire to a gas pipe, water pipe, lightning rod, or grounding wire from a telephone pole. Improper grounding may result in electric shock, smoke, fire, and/or malfunction due to noise interference.

Do not put tension on the power supply wires.

If tension is put on the wires, they may break and result in excessive heat, smoke, and/or fire.

Install an earth leakage breaker to avoid the risk of electric shock.

Failure to install an earth leakage breaker may result in electric shock, smoke, and/or fire.

Use the kind of power supply wires that are specified in the installation manual.

The use of wrong kind of power supply wires may result in current leak, electric shock, and/or fire.

Use breakers and fuses (current breaker, remote switch <switch + Type-B fuse>, moulded case circuit breaker) with the proper current capacity.

The use of wrong capacity fuses, steel wires, or copper wires may result in malfunctions, smoke, and/or fire.

Do not spray water on the air conditioner or immerse the air conditioner in water.

Otherwise, electric shock and/or fire may result.

Periodically check the installation base for damage.

If the unit is left on a damaged platform, it may fall and cause injury.

Properly install the drain pipes according to the instructions in the installation manual. Keep them insulated to avoid dew condensation.

Improper plumbing work may result in water leakage and damage to the furnishings.

Exercise caution when transporting products.

- ♦Products weighing more than 20 kg should not be carried alone.
- ♦Do not carry the product by the PP bands that are used on some products.
- ♦Do not touch the heat exchanger fins. They are sharp and dangerous.
- ♦When lifting the unit with a crane, secure all four corners to prevent the unit from falling.

Properly dispose of the packing materials.

- ♦Nails and wood pieces in the package may pose a risk of injury.
- ♦Plastic bags may pose a risk of choking hazard to children. Tear plastic bags into pieces before disposing of them.

Before the test run

 CAUTION

Turn on the unit at least 12 hours before the test run.

Keep the unit turned on throughout the season. If the unit is turned off in the middle of a season, it may result in malfunctions.

To avoid the risk of electric shock or malfunction of the unit, do not operate switches with wet hands.

Do not touch the refrigerant pipes with bare hands during and immediately after operation.

During or immediately after operation, certain parts of the unit such as pipes and compressor may be either very cold or hot, depending on the state of the refrigerant in the unit at the time. To reduce the risk of frost bites and burns, do not touch these parts with bare hands.

Do not operate the unit without panels and safety guards.

Rotating, high-temperature, or high-voltage parts on the unit pose a risk of burns and/or electric shock.

Do not turn off the power immediately after stopping the operation.

Keep the unit on for at least five minutes before turning off the power to prevent water leakage or malfunction.

Do not operate the unit without the air filter.

Dust particles may build up in the system and cause malfunctions.

I	Read Before Servicing	
	[1] Read Before Servicing.....	3
	[2] Necessary Tools and Materials	4
	[3] Piping Materials	5
	[4] Storage of Piping.....	7
	[5] Pipe Processing.....	7
	[6] Brazing	8
	[7] Air Tightness Test.....	9
	[8] Vacuum Drying (Evacuation).....	10
	[9] Refrigerant Charging	11
	[10] Remedies to be taken in case of a Refrigerant Leak.....	11
	[11] Characteristics of the Conventional and the New Refrigerants	12
	[12] Notes on Refrigerating Machine Oil.....	13
II	Restrictions	
	[1] System configuration.....	17
	[2] Types and Maximum allowable Length of Cables	18
	[3] Switch Settings and Address Settings.....	20
	[4] An Example of a System to which an MA Remote Controller is connected	22
	[5] Restrictions on Pipe Length.....	30
III	Outdoor Unit Components	
	[1] Outdoor Unit Components and Refrigerant Circuit.....	33
	[2] Control Box of the Outdoor Unit	37
	[3] Outdoor Unit Circuit Board	39
IV	Indoor Unit Components	
	[1] External Dimensions.....	45
	[2] Indoor Unit Components and Internal Structure	47
	[3] Control Box of the Indoor Unit	51
	[4] Indoor Unit Circuit Board	52
	[5] Separating the top and bottom of the unit	53
V	Electrical Wiring Diagram	
	[1] Electrical Wiring Diagram of the Outdoor Unit.....	59
	[2] Electrical Wiring Diagram of the Indoor Unit.....	61
VI	Refrigerant Circuit	
	[1] Refrigerant Circuit Diagram	65
	[2] Principal Parts and Functions.....	68
VII	Control	
	[1] Functions and Factory Settings of the Dipswitches.....	75
	[2] Controlling the Outdoor Unit	80
	[3] Controlling the Indoor Unit.....	88
	[4] Operation Flow Chart	92
VIII	Test Run Mode	
	[1] Items to be checked before a Test Run.....	99
	[2] Test Run Method	100
	[3] Operating Characteristic and Refrigerant Amount.....	101
	[4] Adjusting the Refrigerant Amount.....	102
	[5] Refrigerant Amount Adjust Mode	104
	[6] The following symptoms are normal.....	106
	[7] Standard Operation Data (Reference Data)	107
IX	Troubleshooting	
	[1] Error code Lists	111
	[2] Responding to Error Display on the Remote Controller	114
	[3] Investigation of Transmission Wave Shape/Noise	144
	[4] Troubleshooting Principal Parts.....	147
	[5] Refrigerant Leak	167
	[6] Compressor Replacement Instructions (Only P500 type)	168
	[7] Collecting the Cooling Liquid from the Accumulator (Only P500 type).....	169
	[8] Maintenance/Inspection Schedule.....	170
X	LED Monitor Display on the Outdoor Unit Board	
	[1] How to Read the LED on the Service Monitor.....	175

I Read Before Servicing

[1] Read Before Servicing.....	3
[2] Necessary Tools and Materials	4
[3] Piping Materials	5
[4] Storage of Piping	7
[5] Pipe Processing.....	7
[6] Brazing.....	8
[7] Air Tightness Test.....	9
[8] Vacuum Drying (Evacuation)	10
[9] Refrigerant Charging	11
[10] Remedies to be taken in case of a Refrigerant Leak.....	11
[11] Characteristics of the Conventional and the New Refrigerants	12
[12] Notes on Refrigerating Machine Oil.....	13

[1] Read Before Servicing

1. Check the type of refrigerant used in the system to be serviced.
Refrigerant Type New refrigerant series split-type air-conditioners for computer rooms: R410A
2. Check the symptoms exhibited by the unit to be serviced.
Refer to this service handbook for symptoms relating to the refrigerant cycle.
3. Thoroughly read the safety precautions at the beginning of this manual.
4. Preparing necessary tools: Prepare a set of tools to be used exclusively with each type of refrigerant.
Refer to next page for information on the use of tools.
5. For new refrigerant series split-type air-conditioners for computer rooms, it is necessary to replace a dryer when the refrigerant circuit is open (e.g. repairing refrigerant leak).
 - Prepare a dryer dedicated for new refrigerant series split-type air-conditioners for computer rooms. Using a dryer other than the dedicated one may cause a malfunction.
 - Replace a dryer after the refrigerant circuit has been repaired. (If the dryer is left in the air, it absorbs moisture. Replace the dryer immediately.)
6. Verification of the connecting pipes: Verify the type of refrigerant used for the unit to be moved or replaced.
 - Use refrigerant pipes made of phosphorus deoxidized copper. Keep the inner and outer surfaces of the pipes clean and free of such contaminants as sulfur, oxides, dust, dirt, shaving particles, oil, and water.
 - These types of contaminants inside the refrigerant pipes may cause the refrigerant oil to deteriorate.
7. If there is a leak of gaseous refrigerant and the remaining refrigerant is exposed to an open flame, a poisonous gas hydrofluoric acid may form. Keep workplace well ventilated.

 CAUTION

- Install new pipes immediately after removing old ones to keep moisture out of the refrigerant circuit.
- The use of refrigerant that contains chloride, such as R22, will cause the refrigerating machine oil to deteriorate.

[2] Necessary Tools and Materials

Prepare the following tools and materials necessary for installing and servicing the unit.

Tools for use with R410A (Adaptability of tools that are for use with R22 or R407C)

1. To be used exclusively with R410A (not to be used if used with R22 or R407C)

Tools/Materials	Use	Notes
Gauge Manifold	Evacuation and refrigerant charging	Higher than 5.09MPa on the high-pressure side
Charging Hose	Evacuation and refrigerant charging	The hose diameter is larger than the conventional model.
Refrigerant Recovery Cylinder	Refrigerant recovery	
Refrigerant Cylinder	Refrigerant charging	The refrigerant type is indicated. The cylinder is pink.
Charging Port on the Refrigerant Cylinder	Refrigerant charging	The charge port diameter is larger than that of the current port.
Flare Nut	Connection of the unit with the pipes	Use Type-2 Flare nuts.

2. Tools and materials that may be used with R410A with some restrictions

Tools/Materials	Use	Notes
Gas Leak Detector	Gas leak detection	The ones for use with HFC refrigerant may be used.
Vacuum Pump	Vacuum drying	May be used if a check valve adapter is attached.
Flare Tool	Flare processing	Flare processing dimensions for the piping in the system using the new refrigerant differ from those of R22. Refer to next page.
Refrigerant Recovery Equipment	Refrigerant recovery	May be used if compatible with R410A.

3. Tools and materials that are used with R22 or R407C that may also be used with R410A

Tools/Materials	Use	Notes
Vacuum Pump with a Check Valve	Vacuum drying	
Bender	Bending pipes	
Torque Wrench	Tightening flare nuts	Only the flare processing dimensions for pipes that have a diameter of $\phi 12.70$ (1/2") and $\phi 15.88$ (5/8") have been changed.
Pipe Cutter	Cutting pipes	
Welder and Nitrogen Cylinder	Welding pipes	
Refrigerant Charging Meter	Refrigerant charging	
Vacuum Gauge	Vacuum level check	

4. Tools and materials that must not be used with R410A

Tools/Materials	Use	Notes
Charging Cylinder	Refrigerant charging	Prohibited to use

Tools for R410A must be handled with special care to keep moisture and dust from infiltrating the cycle.

[3] Piping Materials

Do not use the existing piping!

OK

New Piping

NO

Existing Piping

1. Copper pipe materials

O-material (Annealed)	Soft copper pipes (annealed copper pipes). They can easily be bent with hands.
1/2H-material (Drawn)	Hard copper pipes (straight pipes). They are stronger than the O-material (Annealed) at the same radial thickness.

- The distinction between O-materials (Annealed) and 1/2H-materials (Drawn) is made based on the strength of the pipes themselves.
- O-materials (Annealed) can easily be bent with hands.
- 1/2H-materials (Drawn) are considerably stronger than O-material (Annealed) at the same thickness.

2. Types of copper pipes

Maximum working pressure	Refrigerant type
3.45 MPa	R22, R407C etc.
4.30 MPa	R410A etc.

3. Piping materials/Radial thickness

Use refrigerant pipes made of phosphorus deoxidized copper.

The operation pressure of the units that use R410A is higher than that of the units that use R22.

Use pipes that have at least the radial thickness specified in the chart below.

(Pipes with a radial thickness of 0.7 mm or less may not be used.)

Pipe size (mm[in])	Radial thickness (mm)	Type
ø6.35 [1/4"]	0.8t	O-material (Annealed)
ø9.52 [3/8"]	0.8t	
ø12.7 [1/2"]	0.8t	
ø15.88 [5/8"]	1.0t	
ø19.05 [3/4"]	1.0t	1/2H-material, H-material (Drawn)
ø22.2 [7/8"]	1.0t	
ø25.4 [1"]	1.0t	
ø28.58 [1-1/8"]	1.0t	
ø31.75 [1-1/4"]	1.1t	

- The pipes in the system that uses the refrigerant currently on the market are made with O-material (Annealed), even if the pipe diameter is less than ø19.05 (3/4"). For a system that uses R410A, use pipes that are made with 1/2H-material (Drawn) unless the pipe diameter is at least ø19.05 (3/4") and the radial thickness is at least 1.2t.
- The figures in the radial thickness column are based on the Japanese standards and provided only as a reference. Use pipes that meet the local standards.

4. Thickness and refrigerant type indicated on the piping materials

Ask the pipe manufacturer for the symbols indicated on the piping material for new refrigerant.

5. Flare processing (O-material (Annealed) and OL-material only)

The flare processing dimensions for the pipes that are used in the R410A system are larger than those in the R22 system.

Flare processing dimensions (mm[in])

Pipe size (mm[in])	A dimension (mm)	
	R410A	R22, R407C
ø6.35 [1/4"]	9.1	9.0
ø9.52 [3/8"]	13.2	13.0
ø12.7 [1/2"]	16.6	16.2
ø15.88 [5/8"]	19.7	19.4
ø19.05 [3/4"]	24.0	23.3

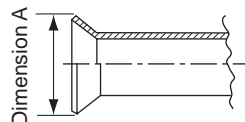

If a clutch-type flare tool is used to flare the pipes in the system using R410A, the length of the pipes must be between 1.0 and 1.5 mm. For margin adjustment, a copper pipe gauge is necessary.

6. Flare nut

The flare nut type has been changed to increase the strength. The size of some of the flare nuts have also been changed.

Flare nut dimensions (mm[in])

Pipe size (mm[in])	B dimension (mm)	
	R410A	R22, R407C
ø6.35 [1/4"]	17.0	17.0
ø9.52 [3/8"]	22.0	22.0
ø12.7 [1/2"]	26.0	24.0
ø15.88 [5/8"]	29.0	27.0
ø19.05 [3/4"]	36.0	36.0

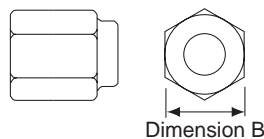

The figures in the radial thickness column are based on the Japanese standards and provided only as a reference. Use pipes that meet the local standards.

[4] Storage of Piping

1. Storage location



Store the pipes to be used indoors. (Warehouse at site or owner's warehouse)
If they are left outdoors, dust, dirt, or moisture may infiltrate and contaminate the pipe.

2. Sealing the pipe ends

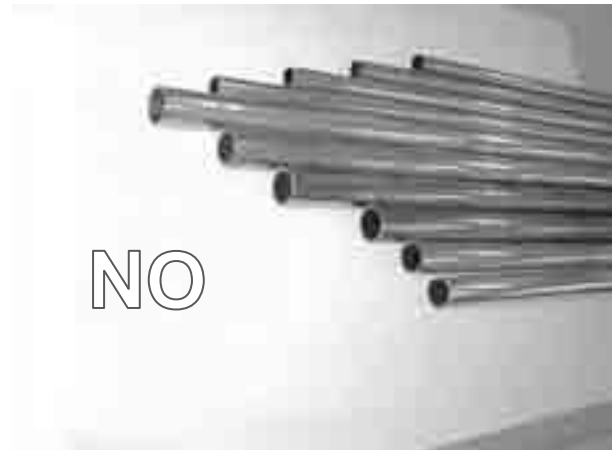
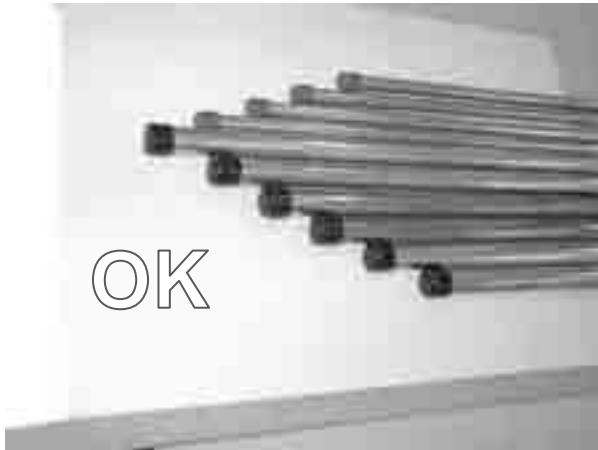

Both ends of the pipes should be sealed until just before brazing.
Keep elbow pipes and T-joints in plastic bags.

The new refrigerator oil is 10 times as hygroscopic as the conventional refrigerating machine oil (such as Suniso) and, if not handled with care, could easily introduce moisture into the system. Keep moisture out of the pipes, for it will cause the oil to deteriorate and cause a compressor failure.

[5] Pipe Processing

Use a small amount of ester oil, ether oil, or alkylbenzene to coat flares and flanges.

1. Notes

- Use a minimum amount of oil.
- Use only ester oil, ether oil, and alkylbenzene.

[6] Brazing

No changes have been made in the brazing procedures. Perform brazing with special care to keep foreign objects (such as oxide scale, water, and dust) out of the refrigerant system.

Example: Inside the brazed connection

Use of oxidized solder for brazing

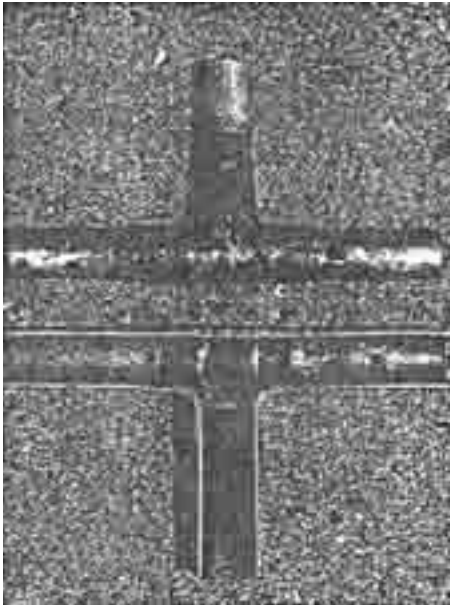

Use of non-oxidized solder for brazing



1. Items to be strictly observed

- ♦Do not conduct refrigerant piping work outdoors if raining.
- ♦Use non-oxidized solder.
- ♦Use a brazing material (BCuP-3) that requires no flux when brazing between copper pipes or between a copper pipe and copper coupling.
- ♦If installed refrigerant pipes are not immediately connected to the equipment, then braze and seal both ends.

2. Reasons

- ♦The new refrigerating machine oil is 10 times as hygroscopic as the conventional oil and is more likely to cause unit failure if water infiltrates into the system.
- ♦Flux generally contains chloride. Residual flux in the refrigerant circuit will cause sludge to form.

3. Notes

Do not use commercially available antioxidants because they may cause the pipes to corrode or refrigerating machine oil to deteriorate.

[7] Air Tightness Test

No changes have been made in the detection method. Note that a refrigerant leak detector for R22 will not detect an R410A leak.

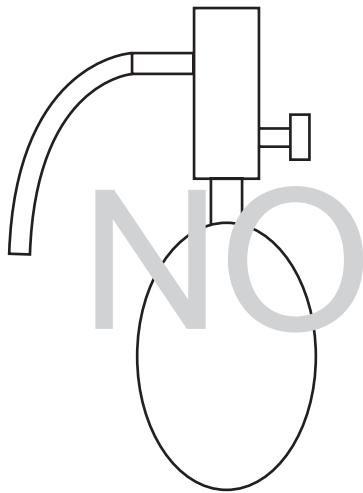

Halide torch

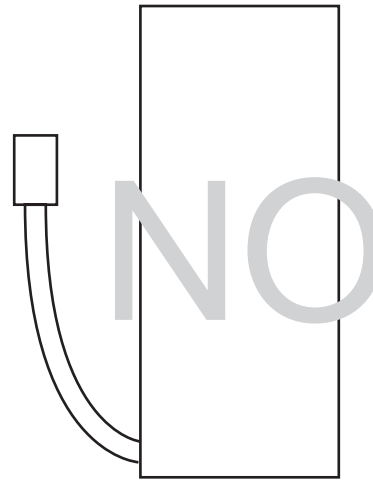

R22 leakage detector

1. Items to be strictly observed

- Pressurize the equipment with nitrogen up to the design pressure (4.15MPa), and then judge the equipment's air tightness, taking temperature variations into account.
- When using refrigerant instead of a leak detector to find the location of a leak, use R410A.
- Refrigerant R410A must be charged in its liquid state (vs. gaseous state).

2. Reasons

- Oxygen, if used for an air tightness test, poses a risk of explosion. (Only use nitrogen to check air tightness.)
- Refrigerant R410A must be charged in its liquid state. If gaseous refrigerant in the cylinder is drawn out first, the composition of the remaining refrigerant in the cylinder will change and become unsuitable for use.

3. Notes

Procure a leak detector that is specifically designed to detect an HFC leak. A leak detector for R22 will not detect an HFC(R410A, R407C) leak.

[8] Vacuum Drying (Evacuation)



(Photo1) 15010H



(Photo2) 14010

Recommended vacuum gauge:
ROBINAIR 14010 Thermistor Vacuum Gauge

1. Vacuum pump with a reverse-flow check valve (Photo1)
To prevent the vacuum pump oil from flowing into the refrigerant circuit during power OFF or power failure, use a vacuum pump with a reverse-flow check valve.
A reverse-flow check valve may also be added to the vacuum pump currently in use.
2. Standard of vacuum degree (Photos 2)
Use a vacuum pump that attains 65Pa or lower degree of vacuum after 5 minutes of operation, and connect it directly to the vacuum gauge. Use a pump well-maintained with an appropriate lubricant. A poorly maintained vacuum pump may not be able to attain the desired degree of vacuum.
3. Required precision of vacuum gauge
Use a vacuum gauge that registers a vacuum degree of 650Pa and measures at intervals of 130Pa. (A recommended vacuum gauge is shown in Photo2.)
Do not use a commonly used gauge manifold because it cannot register a vacuum degree of 650Pa.
4. Evacuation time
 - After the degree of vacuum has reached 650Pa, evacuate for an additional 1 hour. (A thorough vacuum drying removes moisture in the pipes.)
 - Verify that the vacuum degree has not risen by more than 130Pa 1 hour after evacuation. A rise by less than 130Pa is acceptable.
 - If the vacuum is lost by more than 130Pa, conduct evacuation, following the instructions in section 6. Special vacuum drying.
5. Procedures for stopping vacuum pump
To prevent the reverse flow of vacuum pump oil, open the relief valve on the vacuum pump side, or draw in air by loosening the charge hose, and then stop the operation.
The same procedures should be followed when stopping a vacuum pump with a reverse-flow check valve.
6. Special vacuum drying
 - When 650Pa or lower degree of vacuum cannot be attained after 3 hours of evacuation, it is likely that water has penetrated the system or that there is a leak.
 - If water infiltrates the system, break the vacuum with nitrogen. Pressurize the system with nitrogen gas to 0.05MPa and evacuate again. Repeat this cycle of pressurizing and evacuation either until the degree of vacuum below 650Pa is attained or until the pressure stops rising.
 - Only use nitrogen gas for vacuum breaking. (The use of oxygen may result in an explosion.)

[9] Refrigerant Charging

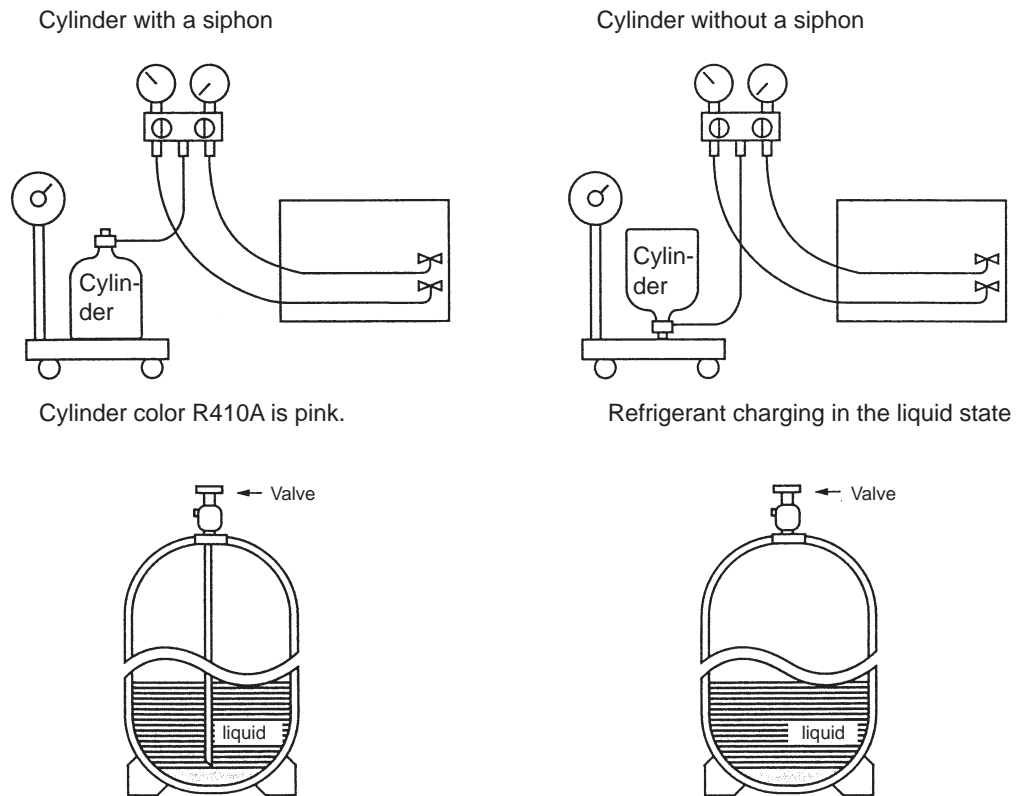

1. Reasons

R410A is a pseudo-azeotropic HFC blend (boiling point R32=-52°C, R125=-49°C) and can almost be handled the same way as a single refrigerant, such as R22. To be safe, however, draw out the refrigerant from the cylinder in the liquid phase. If the refrigerant in the gaseous phase is drawn out, the composition of the remaining refrigerant will change and become unsuitable for use.

2. Notes

When using a cylinder with a siphon, refrigerant is charged in the liquid state without the need for turning it upside down. Check the type of the cylinder on the label before use.

[10] Remedies to be taken in case of a Refrigerant Leak

If the refrigerant leaks out, it may be replenished. The entire refrigerant does not need to be replaced. (Charge refrigerant in the liquid state.)

Refer to "9. (5) Refrigerant leak".

[11] Characteristics of the Conventional and the New Refrigerants

1. Chemical property

As with R22, the new refrigerant (R410A) is low in toxicity and chemically stable nonflammable refrigerant. However, because the specific gravity of vapor refrigerant is greater than that of air, leaked refrigerant in a closed room will accumulate at the bottom of the room and may cause hypoxia. If exposed to an open flame, refrigerant will generate poisonous gases. Do not perform installation or service work in a confined area.

	New Refrigerant (HFC type)		Conventional Refrigerant (HFC type)
	R410A	R407C	R22
	R32/R125	R32/R125/R134a	R22
Composition (wt%)	(50/50)	(23/25/52)	(100)
Type of Refrigerant	Pseudo-azeotropic Refrigerant	Non-azeotropic Refrigerant	Single Refrigerant
Chloride	Not included	Not included	Included
Safety Class	A1/A1	A1/A1	A1
Molecular Weight	72.6	86.2	86.5
Boiling Point (°C)	-51.4	-43.6	-40.8
Steam Pressure (25°C,MPa) (gauge)	1.557	0.9177	0.94
Saturated Steam Density (25°C,kg/m ³)	64.0	42.5	44.4
Flammability	Nonflammable	Nonflammable	Nonflammable
Ozone Depletion Coefficient (ODP) ^{*1}	0	0	0.055
Global Warming Coefficient (GWP) ^{*2}	1730	1530	1700
Refrigerant Charging Method	Refrigerant charging in the liquid state	Refrigerant charging in the liquid state	Refrigerant charging in the gaseous state
Replenishment of Refrigerant after a Refrigerant Leak	Available	Available	Available

*1 When CFC11 is used as a reference

*2 When CO₂ is used as a reference

2. Refrigerant composition

R410A is a pseudo-azeotropic HFC blend and can almost be handled the same way as a single refrigerant, such as R22. To be safe, however, draw out the refrigerant from the cylinder in the liquid phase. If the refrigerant in the gaseous phase is drawn out, the composition of the remaining refrigerant will change and become unsuitable for use. If the refrigerant leaks out, it may be replenished. The entire refrigerant does not need to be replaced.

3. Pressure characteristics

The pressure in the system using R410A is 1.6 times as great as that in the system using R22.

Temperature (°C)	Pressure (gauge)		
	R410A	R407C	R22
	MPa	MPa	MPa
-20	0.30	0.18	0.14
0	0.70	0.47	0.40
20	1.34	0.94	0.81
40	2.31	1.44	1.44
60	3.73	2.44	2.33
65	4.17	2.75	2.60

[12] Notes on Refrigerating Machine Oil

1. Refrigerating machine oil in the HFC refrigerant system

HFC type refrigerants use a refrigerating machine oil different from that used in the R22 system. Note that the ester oil used in the system has properties that are different from commercially available ester oil.

Refrigerant	Refrigerating machine oil
R22	Mineral oil
R407C	Ester oil
R410A	Ester oil

2. Effects of contaminants*¹

Refrigerating machine oil used in the HFC system must be handled with special care to keep contaminants out. The table below shows the effect of contaminants in the refrigerating machine oil on the refrigeration cycle.

3. The effects of contaminants in the refrigerating machine oil on the refrigeration cycle.

Cause		Symptoms	Effects on the refrigerant cycle
Water infiltration		Frozen expansion valve and capillary tubes	Clogged expansion valve and capillary tubes Poor cooling performance Compressor overheat
		Hydrolysis Sludge formation and adhesion Acid generation Oxidization Oil degradation	Motor insulation failure Burnt motor Coppering of the orbiting scroll Lock Burn-in on the orbiting scroll
Air infiltration		Oxidization	
Infiltration of contaminants	Dust, dirt	Adhesion to expansion valve and capillary tubes	Clogged expansion valve, capillary tubes, and drier Poor cooling performance Compressor overheat
		Infiltration of contaminants into the compressor	Burn-in on the orbiting scroll
	Mineral oil etc.	Sludge formation and adhesion	Clogged expansion valve and capillary tubes Poor cooling performance Compressor overheat
		Oil degradation	Burn-in on the orbiting scroll

*1. Contaminants is defined as moisture, air, processing oil, dust/dirt, wrong types of refrigerant, and refrigerating machine oil.

II Restrictions

[1] System configuration	17
[2] Types and Maximum allowable Length of Cables	18
[3] Switch Settings and Address Settings	20
[4] An Example of a System to which an MA Remote Controller is connected	22
[5] Restrictions on Pipe Length	30

[1] System configuration

Indoor unit model	Outdoor unit model
PFD-P250VM-E	PU(H)Y-P250YGM-A
PFD-P500VM-E	PUHY-P500YGM-A
	PU(H)Y-P250YGM-A x 2 *1

*1 When two outdoor units are connected to one indoor unit, two refrigerant circuits must be connected.

Only one refrigerant circuit can be connected to the indoor unit at factory shipment. To connect two refrigerant circuits, perform some work on the unit.

1. Restrictions when the PFD-type indoor units are connected (related to the system)

- (1) It is necessary to rewrite the S/W on the controller circuit board of the outdoor unit connected to the PFD-type indoor units to the dedicated S/W.
 - ◆When it is necessary to replace the controller circuit board at servicing, the controller board must be replaced with the dedicated controller circuit board.
- (2) The outdoor units on which the S/W is rewritten to the dedicated S/W cannot be connected to the indoor units other than the PFD-type indoor units.
- (3) The PFD-type indoor units cannot be connected to the ME remote controller.
- (4) The address settings must be made on this system.
- (5) The following functions cannot be selected on the PFD-type indoor units.
 - 1) Switching between automatic power recovery Enabled/Disabled (Fixed to "Enabled" in the PFD-type indoor units)
 - 2) Switching between power source start/stop (Fixed to "Disabled" in the PFD-type indoor units)
- (6) The PFD-type indoor units and other types of indoor units cannot be grouped.
- (7) The following functions are limited when the system controller (such as G-50A) is connected.
 - 1) To perform group operation in the system with two refrigerant circuits (combination of two outdoor units and one indoor unit: P500 model only), the addresses of the controller boards No.1 and No.2 on a indoor unit must be set within a group.
 - 2) The local operation cannot be prohibited with the main remote controller.
 - 3) When the switches of the PFD-type indoor units are set as follows, the unit ON/OFF operation cannot be made with the main remote controller.
 - ◆When the Normal/Local switching switch is set to "Local"
 - ◆When the DipSW1-10 on the controller circuit board is set to "ON"

[2] Types and Maximum allowable Length of Cables

1. Wiring work

(1) Notes

- 1) Have all electrical work performed by an authorized electrician according to the local regulations and instructions in this manual.

⚠ WARNING

Have all electrical work performed by an authorized electrician according to the local regulations and instructions in this manual, and a dedicated circuit must be used. Insufficient capacity of the power supply circuit or improper installation may result in malfunctions of the unit, electric shock, smoke, and/or fire.

- 2) Install the control cable at least 5cm away from the power supply cable to avoid noise interference. (Do not put the control cable and power supply cable in the same conduit tube.)
- 3) Provide the specified grounding.

⚠ CAUTION

Properly ground the unit. Do not connect the grounding wire to a gas pipe, water pipe, lightning rod, or grounding wire from a telephone pole. Improper grounding may result in electric shock, smoke, fire, and/or malfunction due to noise interference.

- 4) Run the cable from the electric box of the indoor or outdoor unit in such way that the box is accessible for servicing.
- 5) Do not connect the terminal block for transmission line to supply voltage of 380V~415V. Doing so will damage the electronic components on the terminal block.
- 6) Use 2-core shielded cables as control cables. (Marked with OK in the figure below) Use a separate 2-core control cable for each refrigerant system. Do not use a single multiple-core cable to connect indoor units that belong to different refrigerant systems. The use of a multiple-core cable may result in signal transmission errors and malfunctions. (Marked with NO in the figure below)

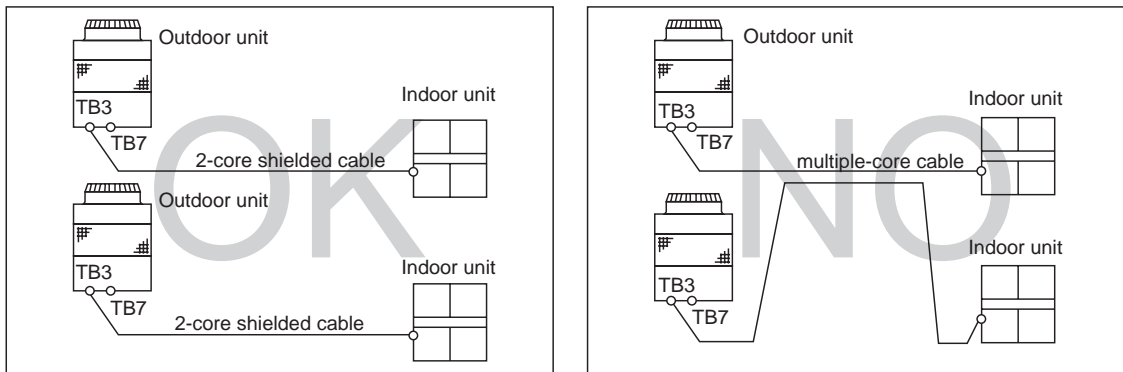

TB3:Terminal block for transmission line connection

TB7:Terminal block for transmission line for centralized control

(2) Control wiring

Different types of control wiring are used for different systems.

Refer to section "[4] An Example of a System to which an MA Remote Controller is connected " before performing wiring work.

[Types and maximum allowable length of cables]

Control lines are categorized into 2 types: transmission line and remote controller line. Use the appropriate type of cables and observe the maximum allowable length specified for a given system. If a given system has a long transmission line or if a noise source is located near the unit, place the unit away from the noise source to reduce noise interference.

1) M-NET transmission line

Cable type	Facility type	All facility types
	Type	Shielded cable CVVS, CPEVS, MVVS
	Number of cores	2-core cable
	Cable size	Larger than 1.25mm ²
Maximum transmission line distance between the outdoor unit and the farthest indoor unit		200 m max.
Maximum transmission line distance for centralized control and Indoor/outdoor transmission line (Maximum line distance via outdoor unit)		500 m max. *The maximum overall line length from the power supply unit on the transmission lines for centralized control to each outdoor unit or to the system controller is 200m max.

2) Remote controller wiring

		MA remote controller
Cable type	Type	VCTF, VCTFK, CVV, CVS, VVR, VVF, VCT
	Number of cores	2-core cable
	Cable size	0.3 to 1.25mm ² *1
Maximum overall line length		200 m max.

*1 The use of cables that are smaller than 0.75mm² is recommended for easy handling.

[3] Switch Settings and Address Settings

1. Switch setting

Switch settings are necessary depending on the system configuration. Refer to the "[4] An Example of a System to which an MA Remote Controller is connected " before starting the wiring work. Shut down the power supply before making the switch settings. If the switch settings are made with the power ON, the settings cannot be changed, and the operation cannot be performed normally.

2. Address settings

(1) Address settings table

The need for address settings and the range of address setting depend on the configuration of the system.

Unit or controller		Symbols	Address setting range	Setting method	Address setting
Indoor unit	Main/sub unit	IC	01 to 50 ^{*1}	In case of 10HP system or 20HP system with one refrigerant circuit, assign an odd number starting with "01". In case of 20HP system with two refrigerant circuits, assign a sequential odd number starting with "01" to the upper indoor controller, and assign "the address of the upper indoor controller + 1" to the lower indoor controller. (The lower circuit board of the system with one refrigerant circuit is not used.)	00
MA remote controller		MA	No address settings required. (The main/sub switch must be configured if two remote controllers are connected to the system or if the indoor units are connected to different outdoor units.)		Main
Outdoor unit		OC	51 to 100 ^{*1}	Assign an address of the indoor units in the same refrigerant system and 50.	00

*1 If a given address overlaps any of the addresses that are assigned to other outdoor units, use a different, unused address within the setting range.

(2) Power supply switch connector connection on the outdoor unit

(Factory setting: The male power supply switch connector is connected to CN41.)

System configuration	Connection to the system controller	Power supply unit for transmission lines	Group operation of units in a system with multiple outdoor units	Power supply switch connector connection
System with one outdoor unit	—	—	—	Leave CN41 as it is (Factory setting)
System with multiple outdoor units	Not connected	—	Not grouped	Disconnect the male connector from the female power supply switch connector (CN41) and connect it to the female power supply switch connector (CN40) on only one of the outdoor units. *Connect the S (shielded) terminal on the terminal block (TB7) on the outdoor unit whose CN41 was replaced with CN40 to the ground terminal (⌚) on the electric box.
	With connection to the indoor unit system	Not required	Grouped/not grouped	
	With connection to the centralized control system	Not required (Powered from the outdoor unit)	Grouped/not grouped	Leave CN41 as it is (Factory setting)
		Required	Grouped/not grouped	

- (3) Settings of MA remote controller Main/Sub switching switch (When MA remote controller is used: factory setting "Main")
Main/sub settings are available on the MA remote controller. When two remote controllers are connected, set either of them to "Sub".
- (4) Selecting the position of temperature detection for the indoor unit (Factory setting: SWC "Standard")
To use a suction temperature sensor, set SWC to "Option". (The suction temperature sensor is supplied as standard specification.)
- (5) Connection of two refrigerant circuits
When two refrigerant circuits are connected on site, make the switch settings on the controller circuit board following the instructions described in the installation manual for the indoor unit.

[4] An Example of a System to which an MA Remote Controller is connected

1. System with one refrigerant

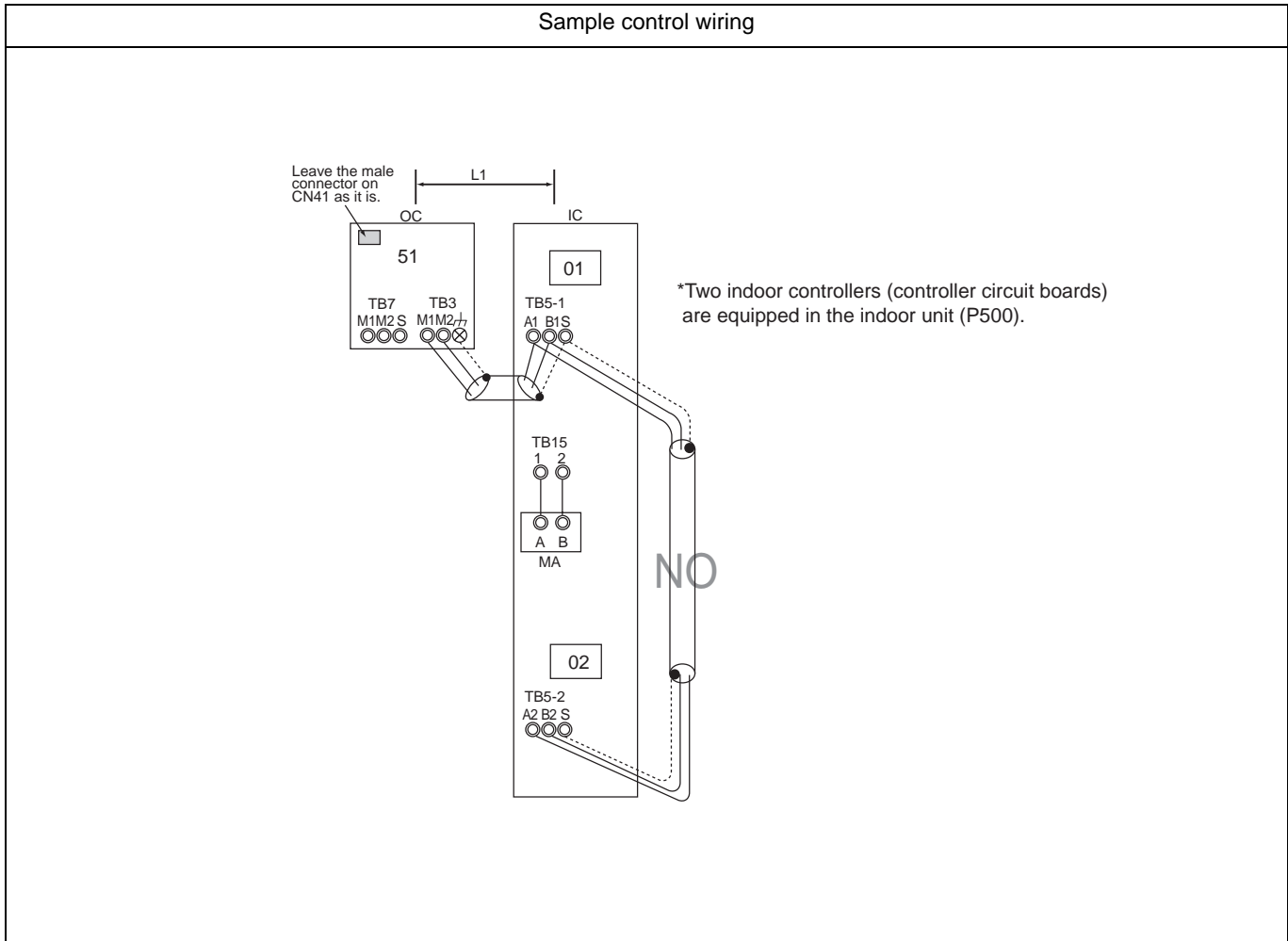

Notes	Maximum allowable length
<p>1. Leave the male connector on the female power supply switch connector (CN41) on the outdoor unit as it is.</p> <p>2. It is not necessary to provide grounding to S terminal on the terminal block for transmission line for centralized control (TB7).</p> <p>3. Although two indoor controllers (controller circuit boards) are equipped inside the indoor unit, the board on No.2 side (lower side) is not used. Do not connect wiring to the lower controller circuit board.</p>	<p>(1) Indoor/outdoor transmission line Maximum distance (1.25mm² or larger) $L1 \leq 200m$</p>

Wiring method/address setting method

1) Indoor/outdoor transmission line

Connect M1, M2 terminals of the indoor/outdoor transmission line terminal block (TB3) on the outdoor unit (OC) and A1, B1 terminals of the indoor/outdoor terminal block (TB5-1) on the indoor unit (IC). (Non-polarized 2-core cable)

•Only use shielded cables.

[Shielded cable connection]

Connect the earth terminal of the OC and S terminal of the IC terminal block (TB5-1).

2) Switch setting

Address setting is required as follows.

Pro- ce- dure s	Unit or controller			Address- settin- grange	Setting method	Notes	Facto- ry set- ting
1	Indoor unit	Main unit	IC	01 to 50	Assign a sequential odd number starting with "01" to the upper indoor controller.		00
		Sub unit	IC	01 to 50	Assign sequential numbers starting with the address of the main unit in the same group. (Main unit address +1)		
2	Outdoor unit		OC	51 to 100	Add 50 to the address assigned to the indoor unit connected to the system with one outdoor unit.		00
3	MA remote controller	Main remote control- ler	MA	No settings required.	-		Main
		Sub remote control- ler	MA	Sub remote controller	Settings to be made with the sub/ main switch		

2. System with two refrigerant circuits

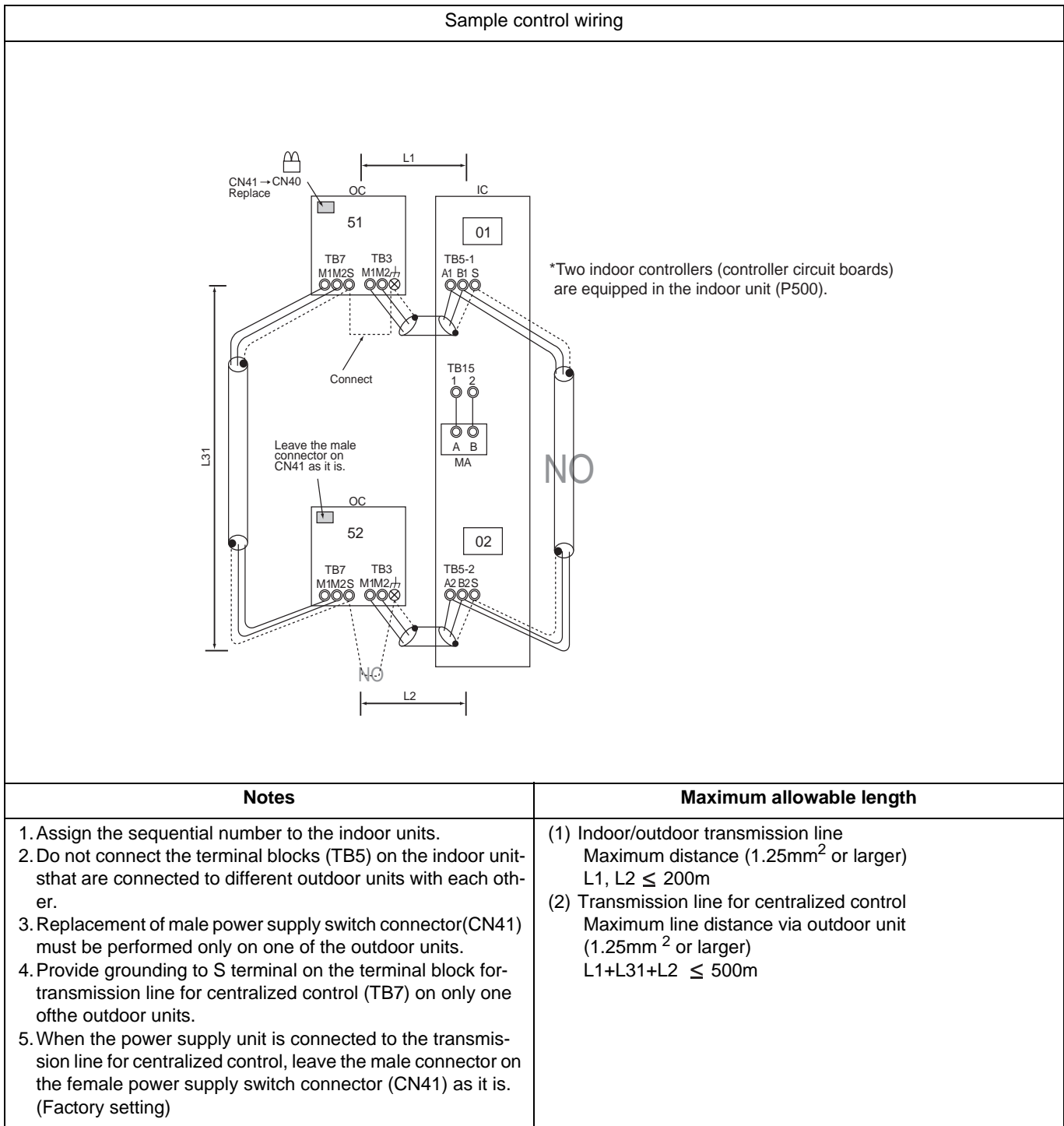

Wiring method/address setting method

- 1) Indoor/outdoor transmission line
 Connect M1, M2 terminals of the indoor/outdoor transmission line terminal block (TB3) on the outdoor unit (OC) and A1, B1 terminals of the indoor/outdoor terminal block (TB5-1) on the indoor unit (IC). (Non-polarized 2-core cable)
 •Only use shielded cables.
[Shielded cable connection]
 Connect the earth terminal of the OC and S terminal of the IC terminal block (TB5-1).
- 2) Transmission line for centralized control
 Daisy-chain terminals M1 and M2 on the terminal block for transmission line for centralized control (TB7) on each outdoor unit (OC). Disconnect the male connector on the controller board from the female power supply switch connector (CN41), and connect it to the female power supply switch connector (CN40) on only one of the outdoor units.
 •Only use shielded cables.
[Shielded cable connection]
 To ground the shielded cable, daisy-chain the S-terminals on the terminal block (TB7) on each of the outdoor units. Connect the S (shielded) terminal on the terminal block (TB7) on the outdoor unit whose male connector on CN41 was disconnected and connected to CN40 to the earth terminal(⌚) on the electric box.
- 3) Switch setting
 Address setting is required as follows.

Pro- ce- du- res	Unit or controller			Address- settin- grange	Setting method	Notes	Facto- ry set- ting
1	Indoor unit	Main unit	IC	01 to 50	Assign a sequential odd number starting with "01" to the upper indoor controller.		00
		Sub unit	IC	01 to 50			
2	Outdoor unit		OC	51 to 100	Add 50 to the address assigned to the indoor unit connected to the system with one outdoor unit.		00
3	MA remote controller	Main remote controller	MA	No set- tings re- quired.	-		Main
		Sub remote controller	MA	Sub remote controller	Settings to be made with the sub/ main switch		

3. System in which two MA remote controllers are connected to one indoor unit

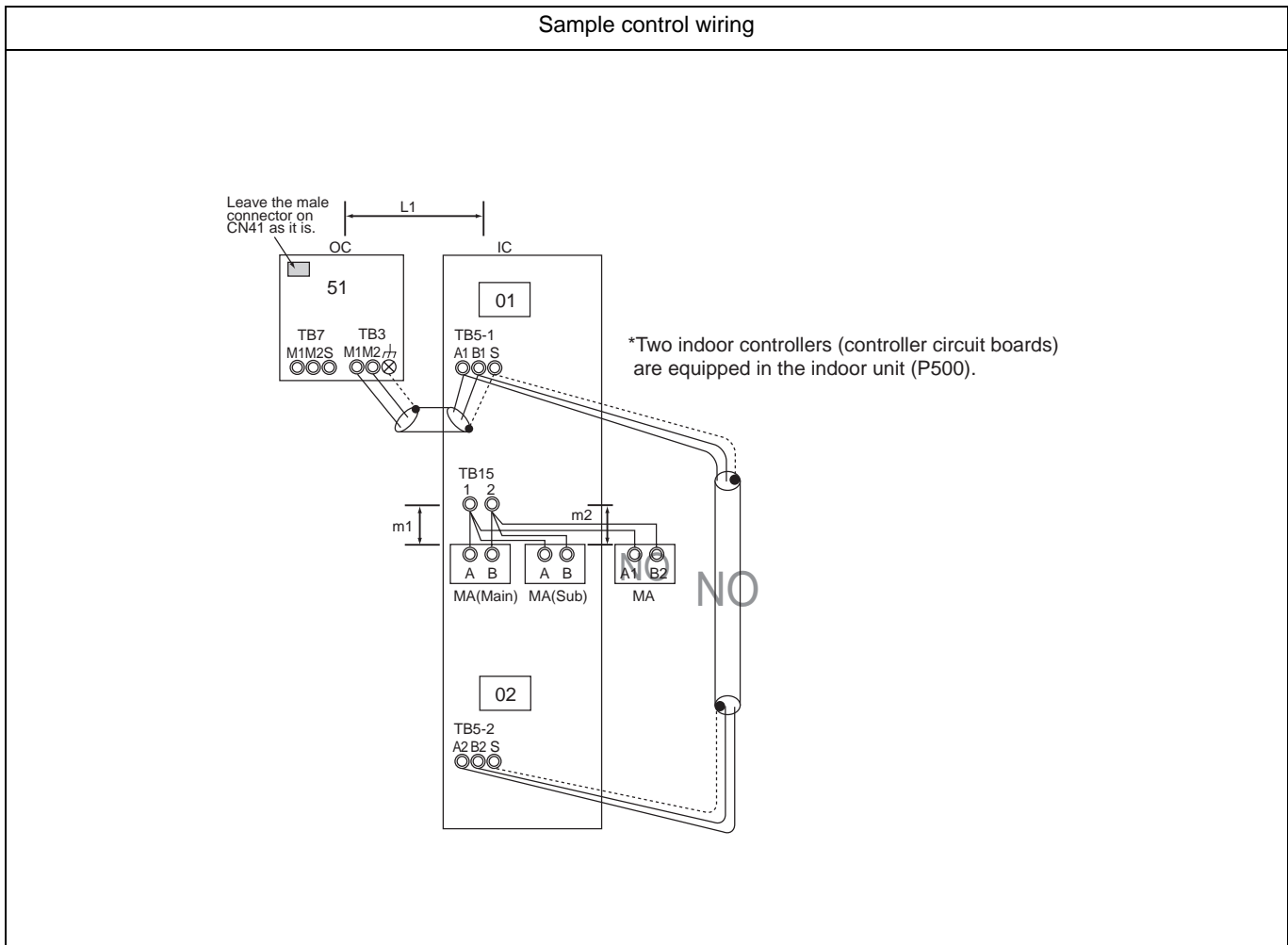

Notes	Maximum allowable length
<ol style="list-style-type: none"> 1. Leave the male connector on the female power supply switch connector (CN41) on the outdoor unit as it is. 2. It is not necessary to provide grounding to S terminal on the terminal block for transmission line for centralized control (TB7). 3. Although two indoor controllers (controller circuit boards) are equipped inside the indoor unit, the board on No.2 side (lower side) is not used. Do not connect wiring to the lower controller circuit board. 4. No more than two MA remote controllers (including both main and sub controllers) can be connected to a group of indoor units. If three or more MA remote controllers are connected, remove the wire for the MA remote controller from the terminal block (TB15). 	<ol style="list-style-type: none"> (1) Indoor/outdoor transmission line Same as [4] 1. (2) MA remote controller wiring Maximum overall line length (0.3 to 1.25mm²) $m1+m2 \leq 200m$

Wiring method/address setting method

- 1) Indoor/outdoor transmission line
Same as [4] 1.
- 2) MA remote controller wiring
[When 2 remote controllers are connected to the system]
 When two remote controllers are connected to the system, connect terminals 1 and 2 of the terminal block (TB15) on the indoor unit (IC) to the terminal block on the MA remote controllers (option).
 •Set the Main/Sub switch on the connected MA remote controllers (option) to SUB.(See the installation manual for the MA remote controller for the setting method.)
- 3) Switch setting
Address setting is required as follows.

Pro- ce- du- res	Unit or controller			Address- settin- grange	Setting method	Notes	Facto- ry set- ting
1	Indoor unit	Main unit	IC	01 to 50	Assign a sequential odd number starting with "01" to the upper indoor controller.		00
		Sub unit	IC	01 to 50	Assign sequential numbers starting with the address of the main unit in the same group. (Main unit address +1)		
2	Outdoor unit		OC	51 to 100	Add 50 to the address assigned to the indoor unit connected to the system with one outdoor unit.		00
3	MA remote controller	Main remote controller	MA	No set- tings re- quired.	-		Main
		Sub remote controller	MA	Sub remote controller	Settings to be made with the sub/ main switch		

4. System in which two indoor units are grouped with the MA remote controller

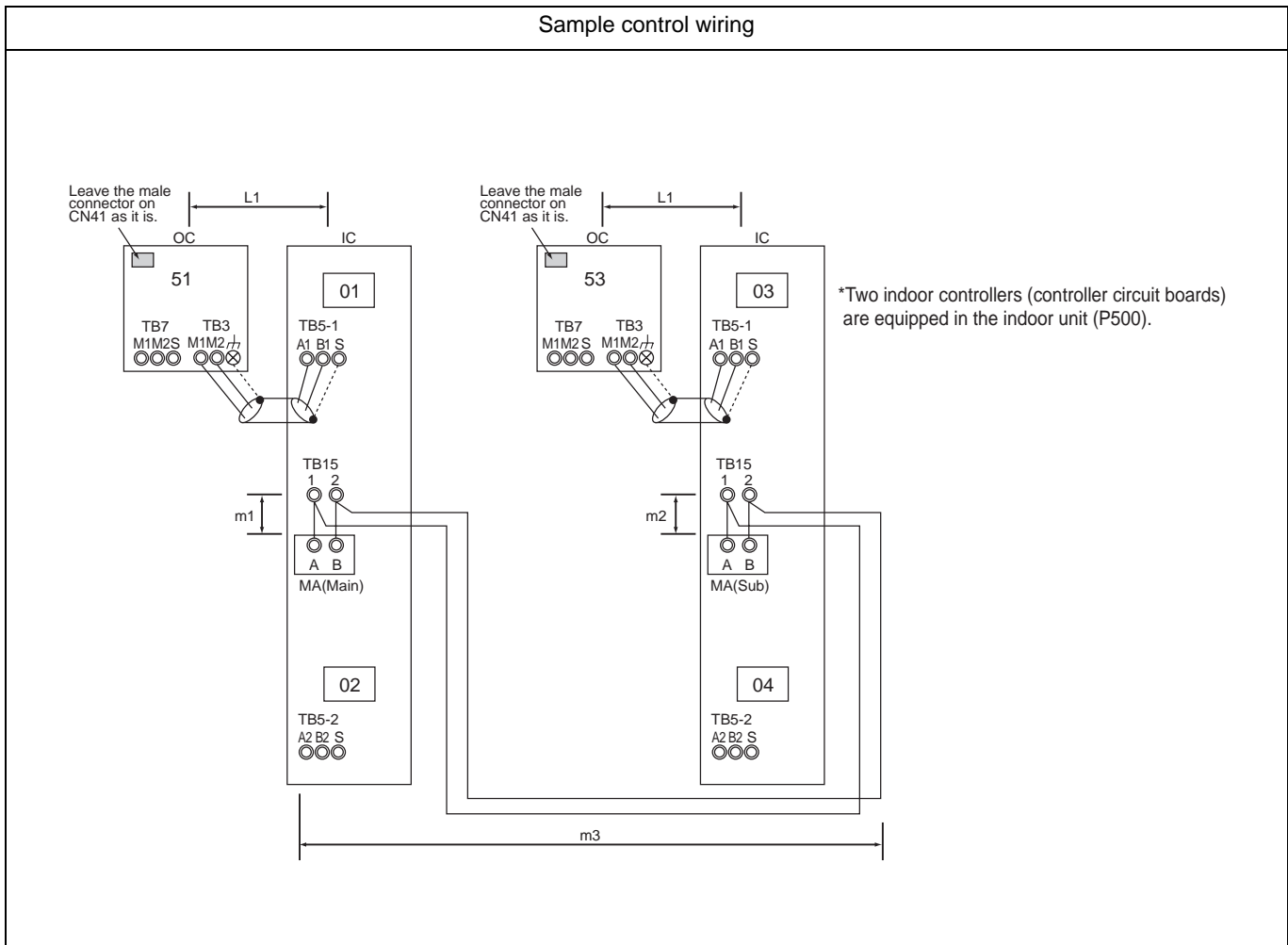

Notes	Maximum allowable length
<ol style="list-style-type: none"> 1. Leave the male connector on the female power supply switch connector (CN41) on the outdoor unit as it is. 2. It is not necessary to provide grounding to S terminal on the terminal block for transmission line for centralized control (TB7). 3. Although two indoor controllers (controller circuit boards) are equipped inside the indoor unit, the board on No.2 side (lower side) is not used. Do not connect wiring to the lower controller circuit board. 4. No more than two MA remote controllers (including both main and sub controllers) can be connected to a group of indoor units. If three or more MA remote controllers are connected, remove the wire for the MA remote controller from the terminal block (TB15). 	<ol style="list-style-type: none"> (1) Indoor/outdoor transmission line Same as [4] 1. (2) MA remote controller wiring Maximum overall line length (0.3 to 1.25mm²) $m1+m2+m3 \leq 200m$

Wiring method/address setting method

- 1) Indoor/outdoor transmission line
Same as [4] 1.
- 2) MA remote controller wiring
[Group operation of indoor units]
 To perform a group operation of indoor units (IC), daisy-chain terminals 1 and 2 on the terminal block (TB15) on all indoor units (IC). (Non-polarized 2-core cable)
 ♦Set the Main/Sub switch on one of the MA remote controllers to SUB.
- 3) Switch setting
Address setting is required as follows.

Pro- ce- du- res	Unit or controller			Address- settin- grange	Setting method	Notes	Facto- ry set- ting
1	Indoor unit	Main unit	IC	01 to 50	Assign a sequential odd number starting with "01" to the upper indoor controller.		00
		Sub unit	IC	01 to 50	Assign sequential numbers starting with the address of the main unit in the same group. (Main unit address +1)		
2	Outdoor unit		OC	51 to 100	Add 50 to the address assigned to the indoor unit connected to the system with one outdoor unit.		00
3	MA remote controller	Main remote control- ler	MA	No set- tings re- quired.	-		Main
		Sub remote control- ler	MA	Sub remote controller	Settings to be made with the sub/ main switch		

[5] Restrictions on Pipe Length

1. Sample connection

(1) System with one refrigerant circuit

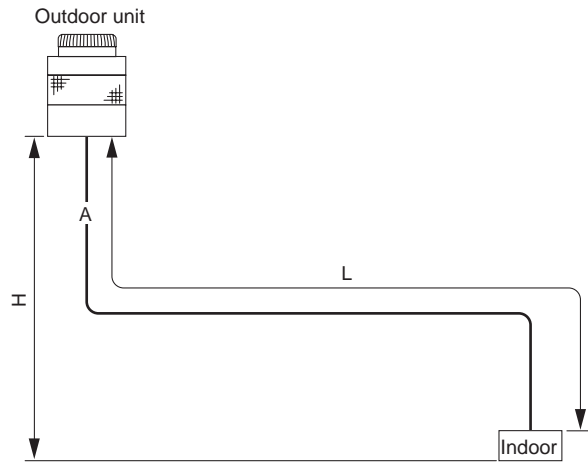

(2) System with two refrigerant circuits

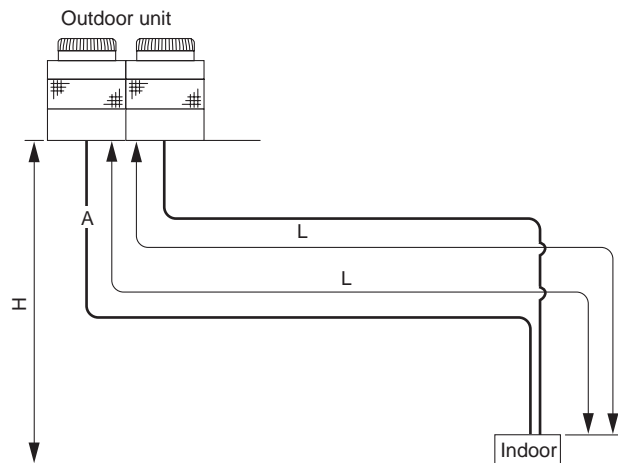

Allowable length	Total pipe length (L) from the outdoor unit to the farthest indoor unit	Actual length 150m or less
Allowable height difference	Height difference between the indoor and the outdoor units (H)	50m or less (40m or less when the outdoor unit is lower, 15m when the outdoor temperature is 10°C or lower)

2. Refrigerant pipe size

Outdoor unit model	Liquid pipe	Gas pipe
P250 model	ø9.52 *1	ø22.2
P500 model	ø15.88	ø28.58

*1 Use the pipe whose size is ø12.7 when the pipe length is 90m or more.

III Outdoor Unit Components

[1] Outdoor Unit Components and Refrigerant Circuit	33
[2] Control Box of the Outdoor Unit.....	37
[3] Outdoor Unit Circuit Board.....	39

[1] Outdoor Unit Components and Refrigerant Circuit

1. PU(H)Y-P250YGM-A model
 - (1) Front view of a outdoor unit

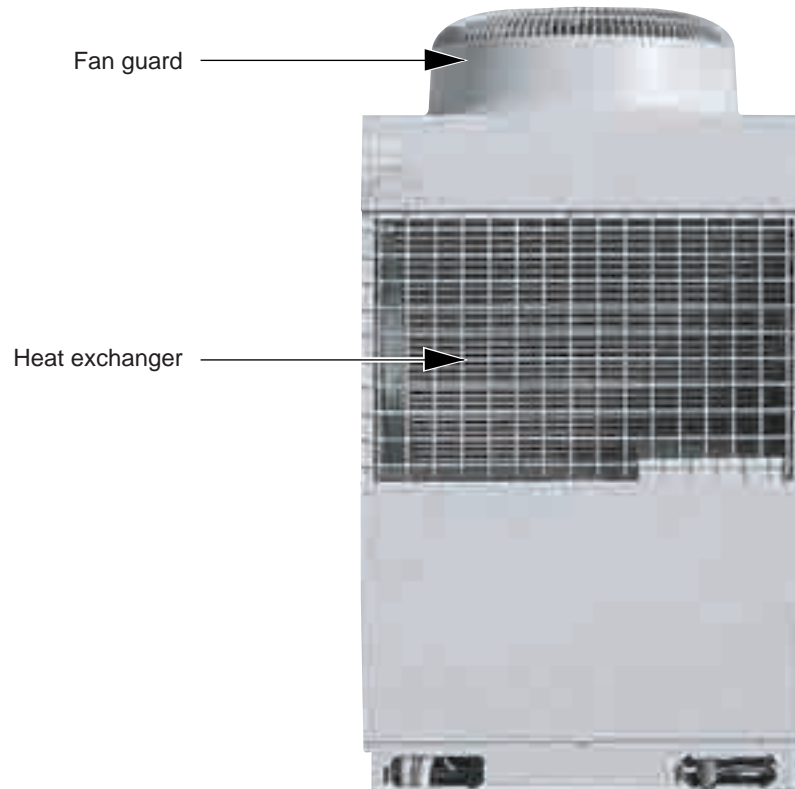

- (2) Rear view of a outdoor unit

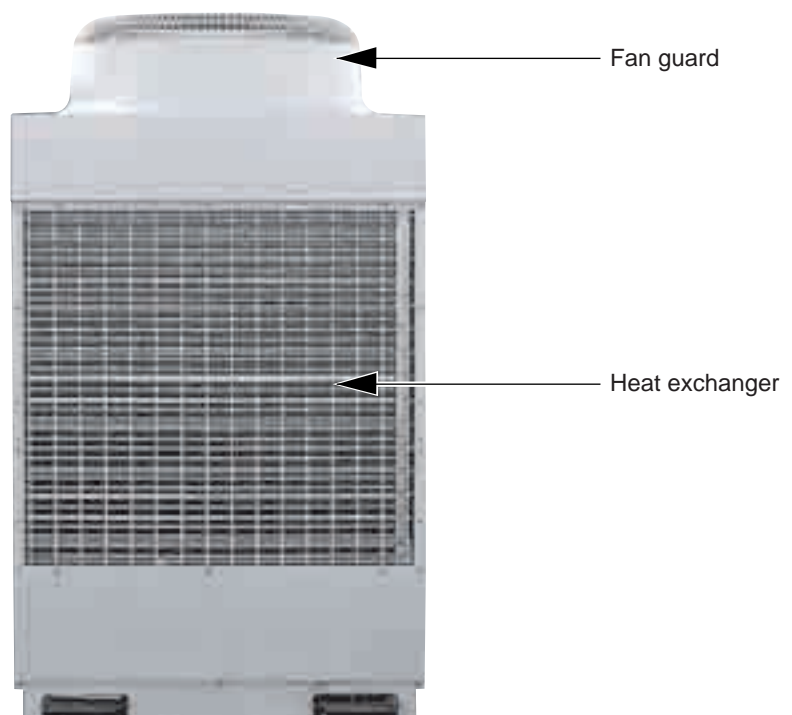

(3) Front view of a refrigerant circuit

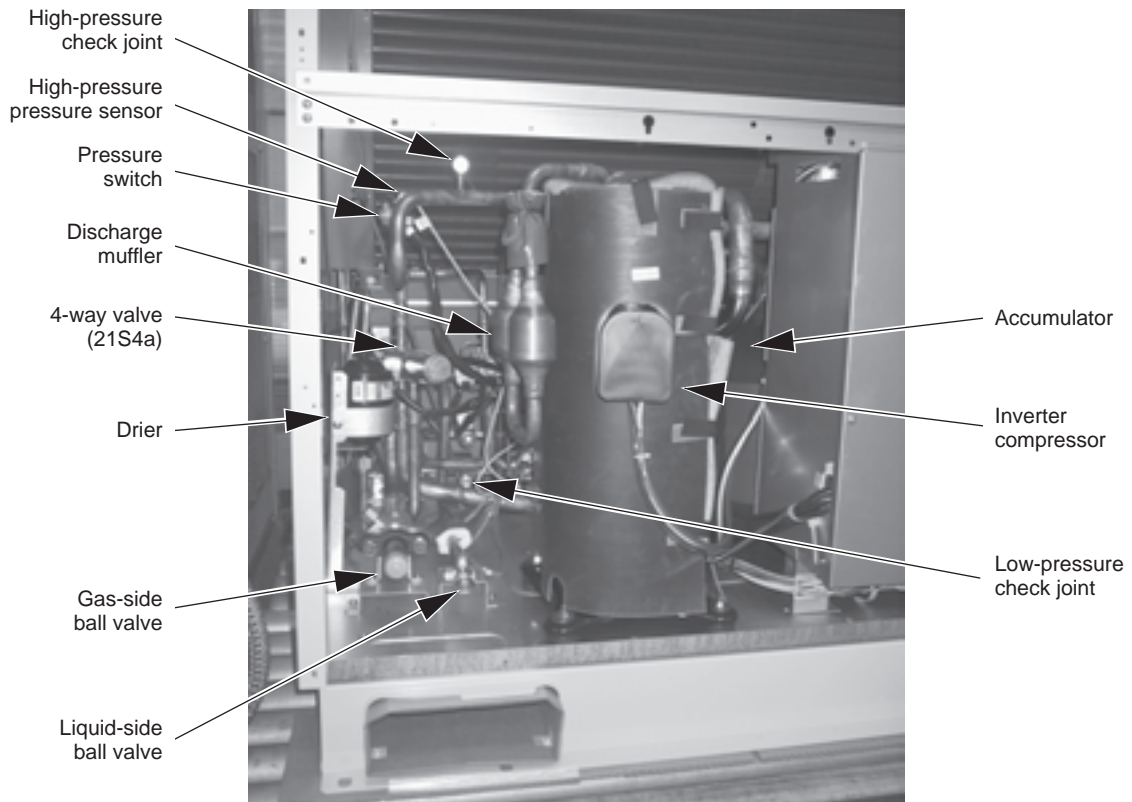

(4) Rear view of a refrigerant circuit

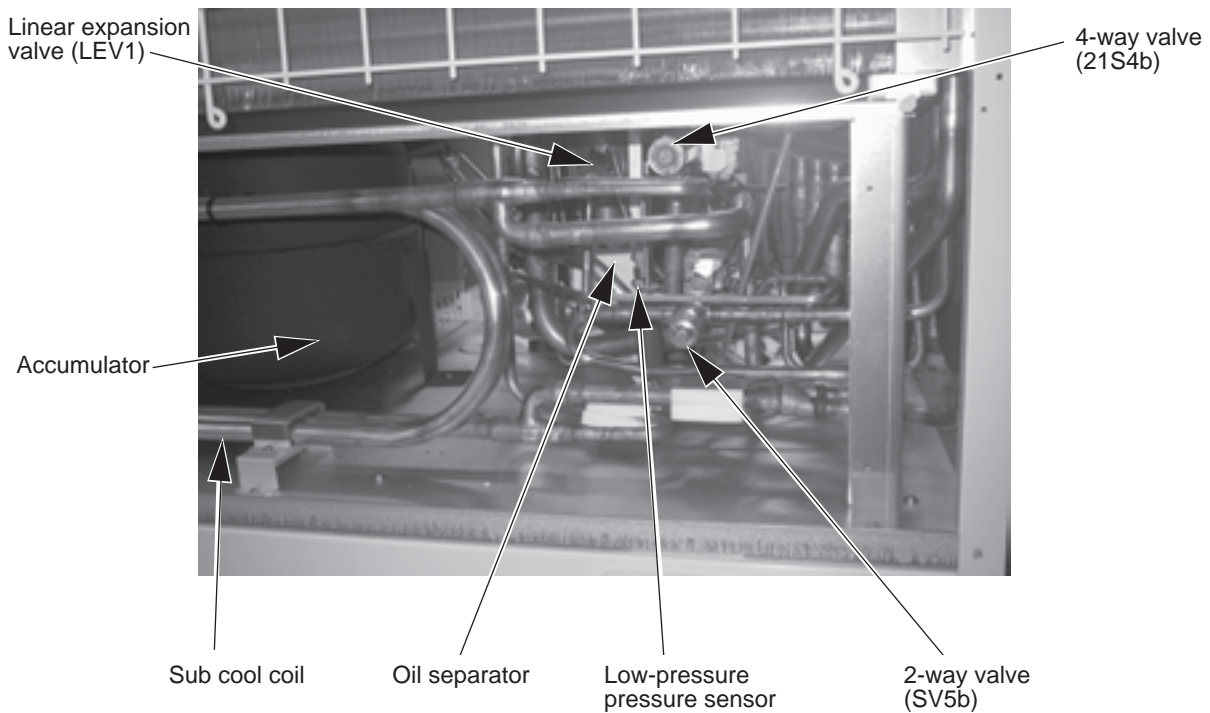

2. PUHY-P500YGM-A model
(1) Front view of a outdoor unit

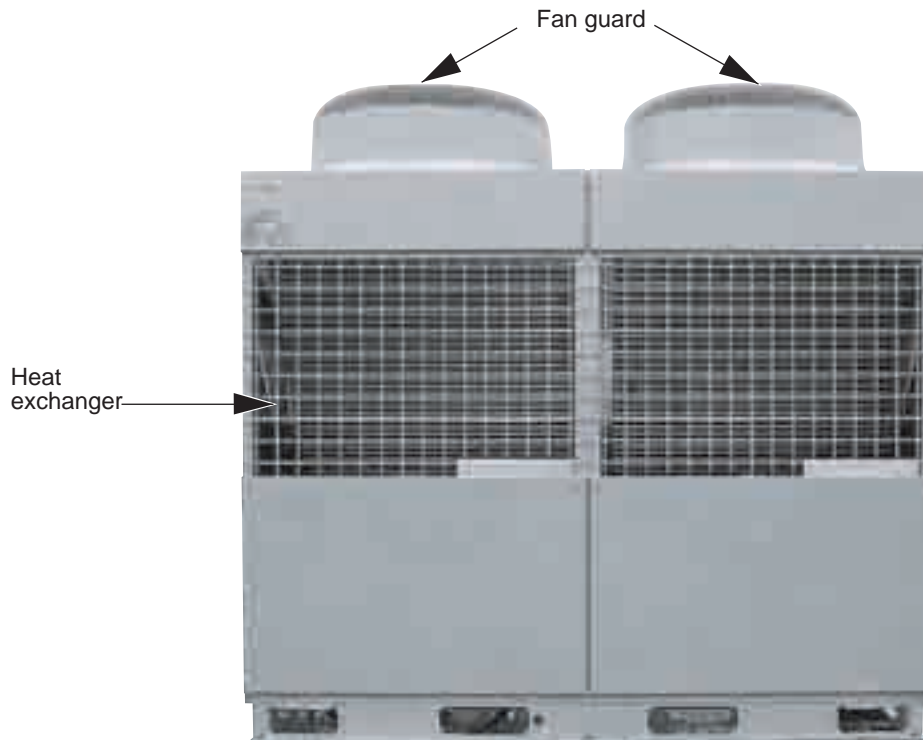

(2) Rear view of a outdoor unit

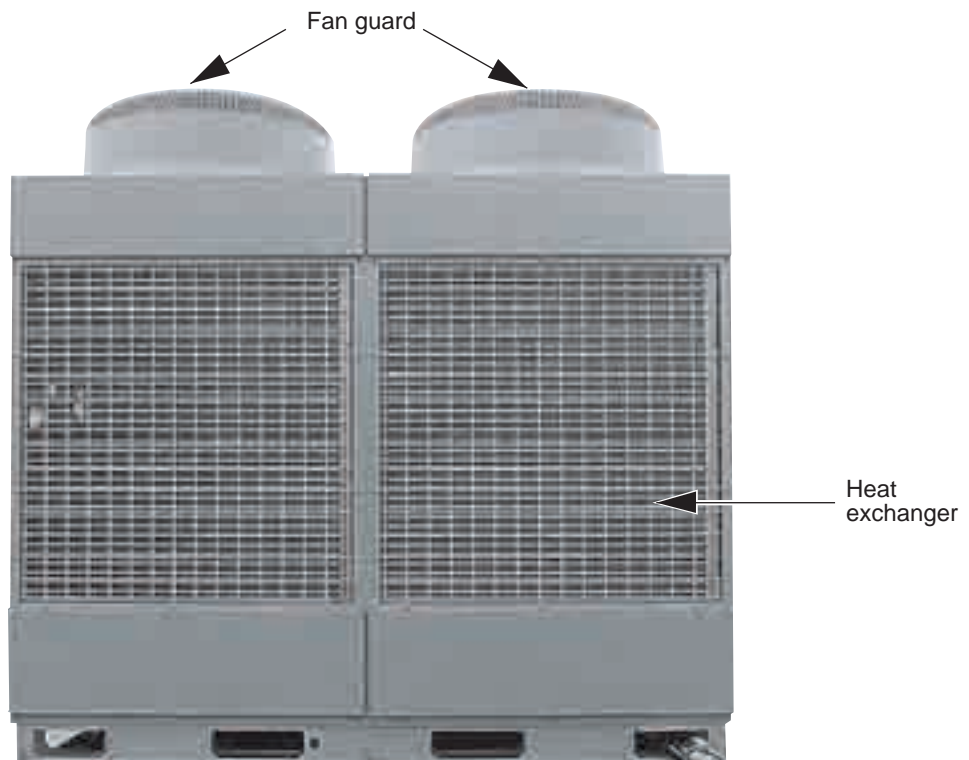

(3) Front view of a refrigerant circuit

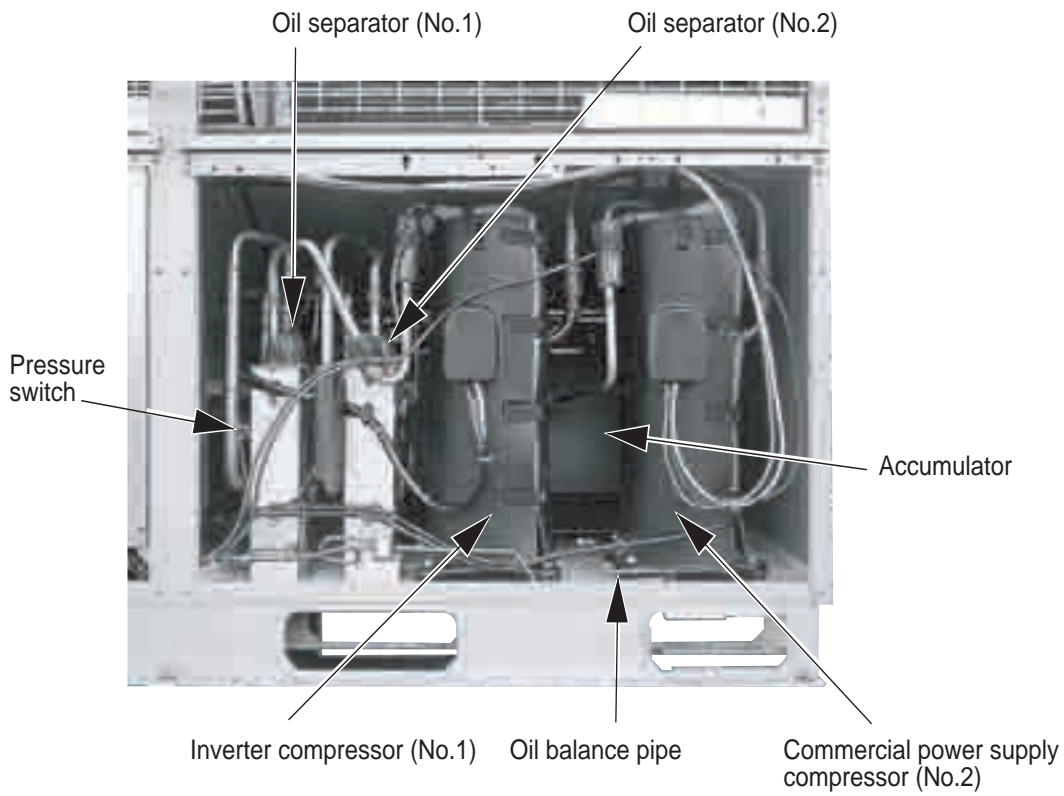

(4) Rear view of a refrigerant circuit

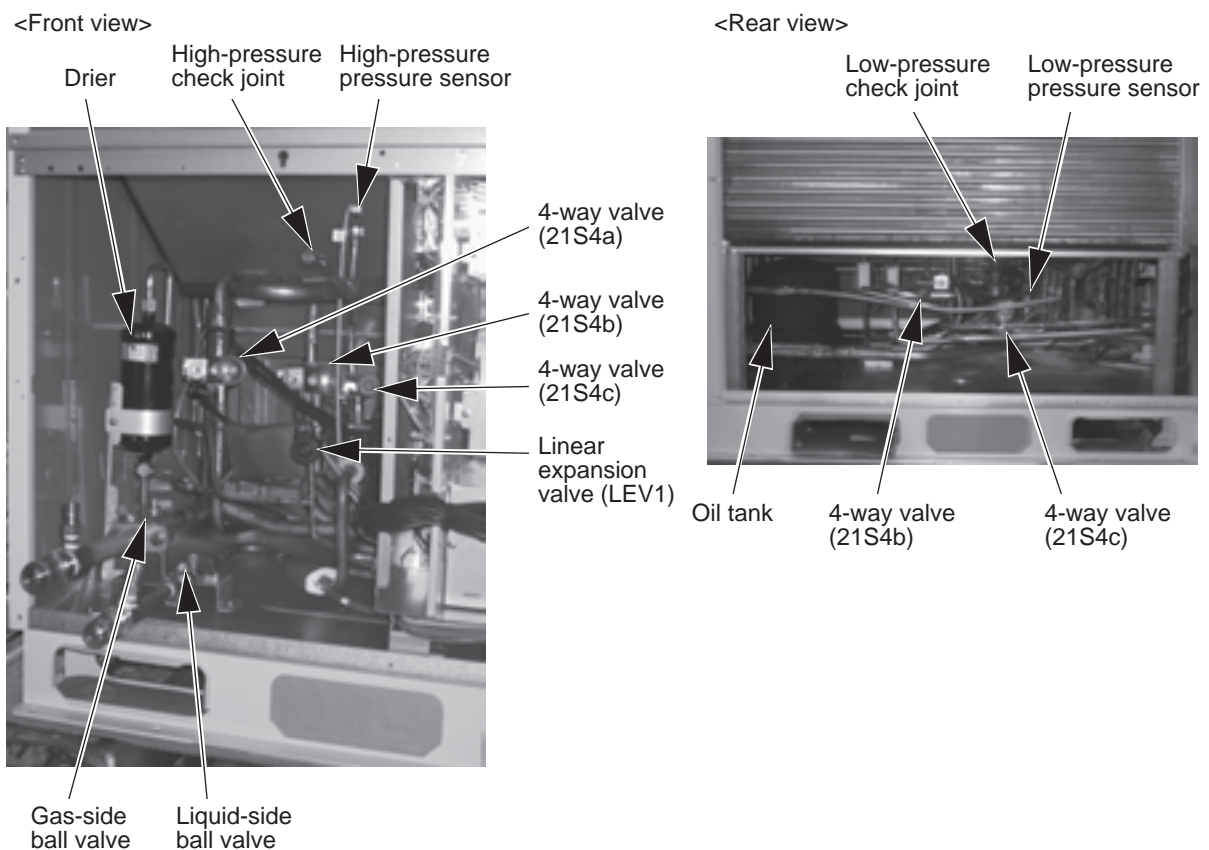

[2] Control Box of the Outdoor Unit

1. PU(H)Y-P250YGM-A model
 - (1) Appearance

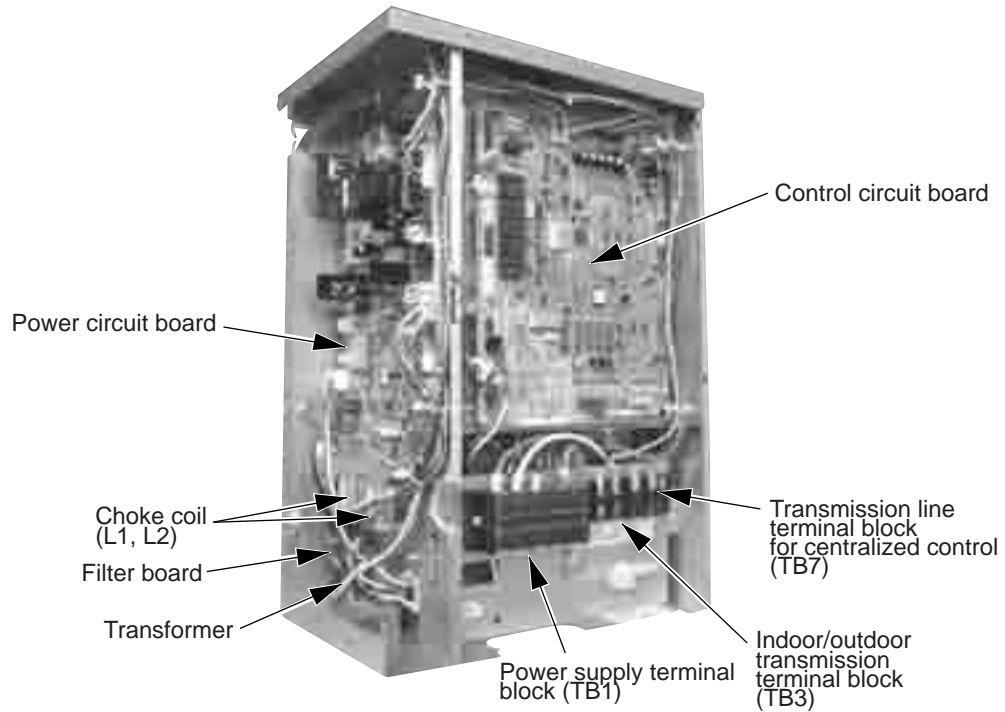

- (2) Under the circuit board cover

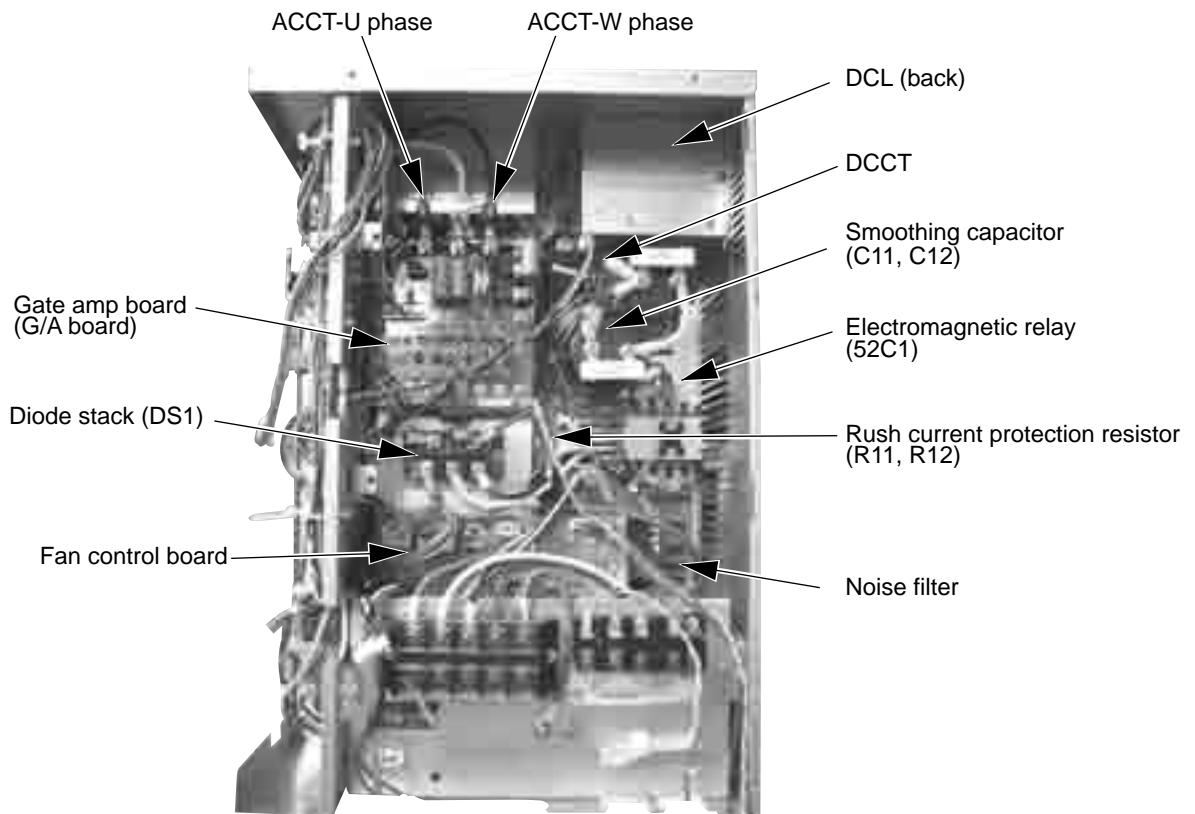

2. PUHY-P500YGM-A model
 (1) Appearance

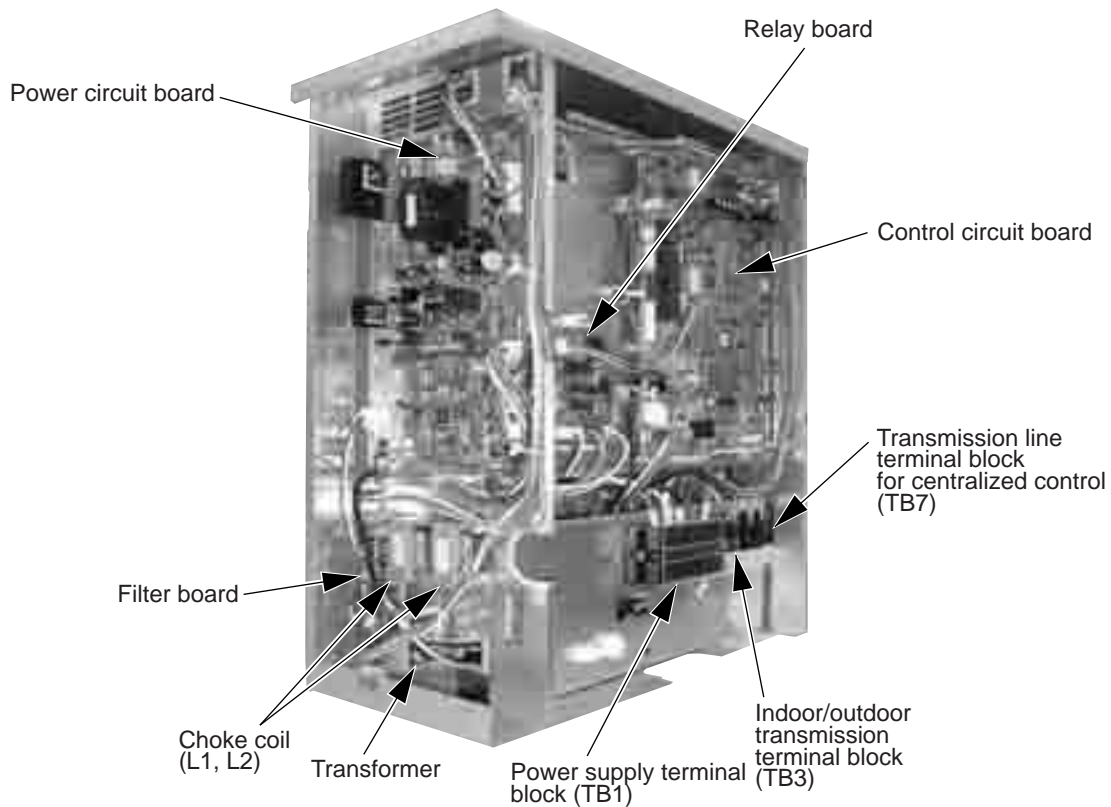

(2) Under the circuit board cover

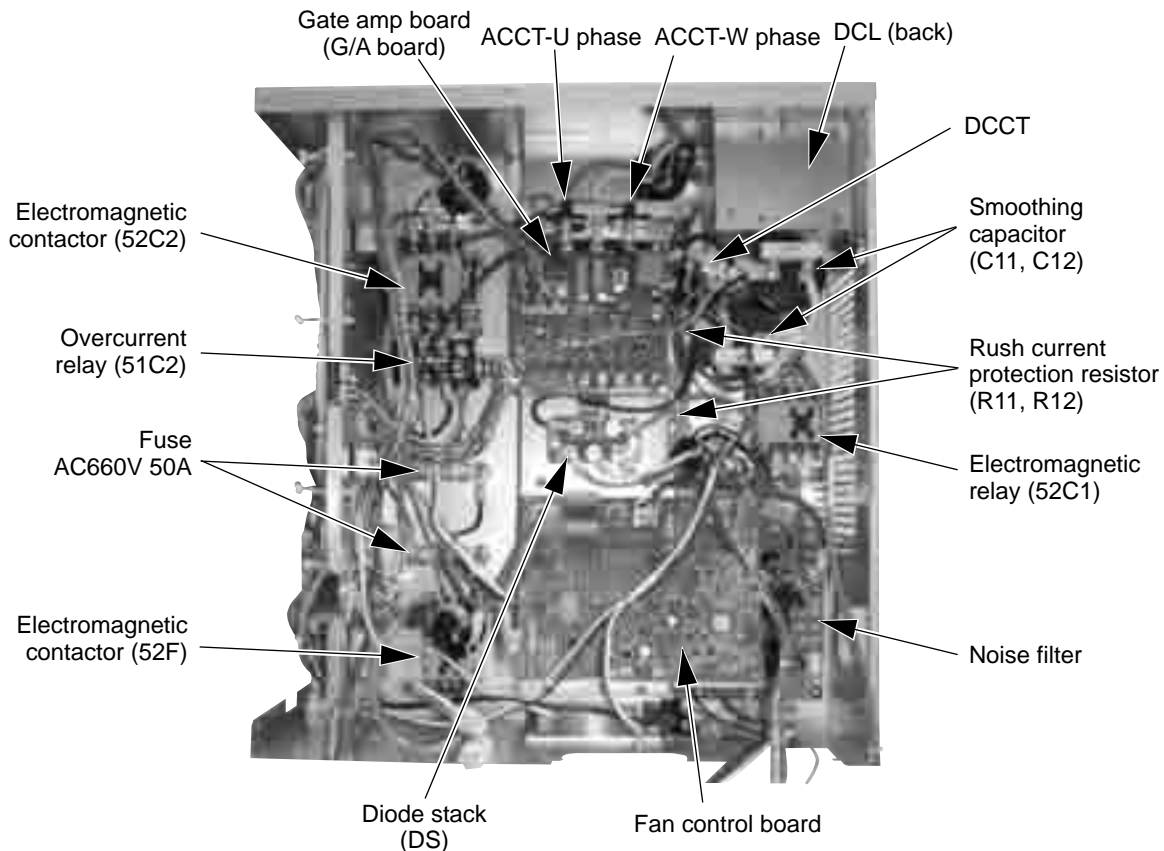

[3] Outdoor Unit Circuit Board

1. Control circuit board

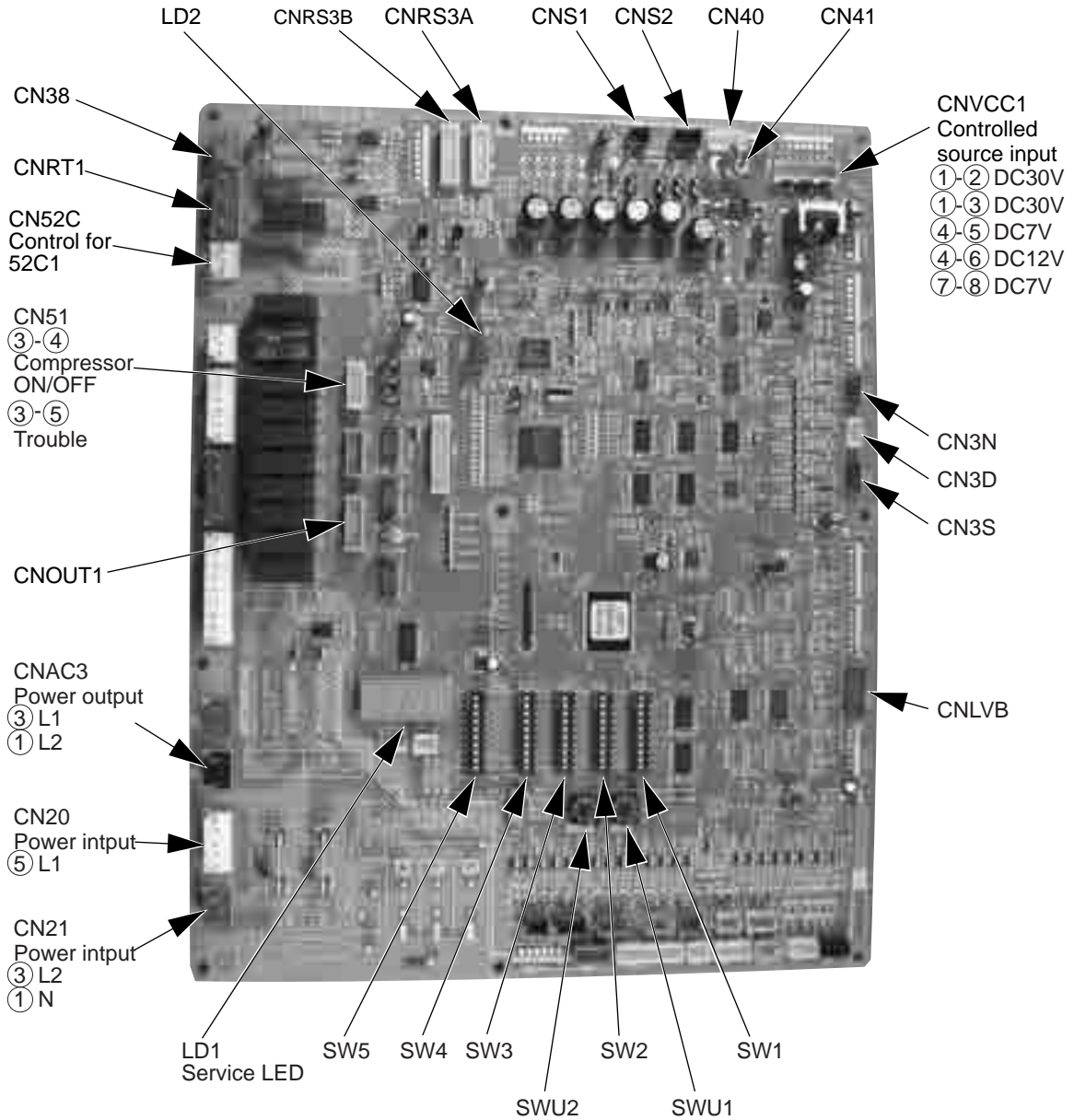

2. Power circuit board

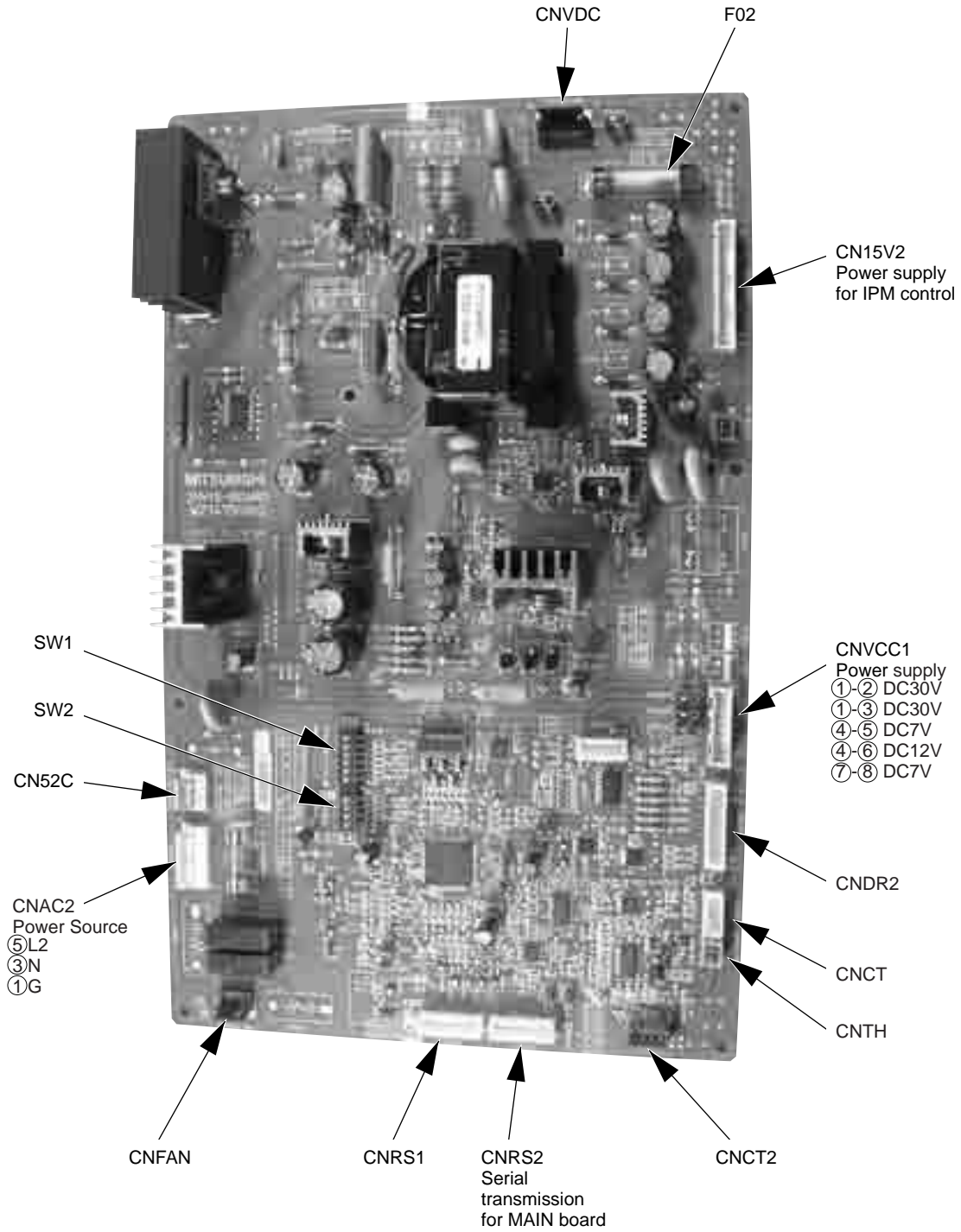

3. Fan control board

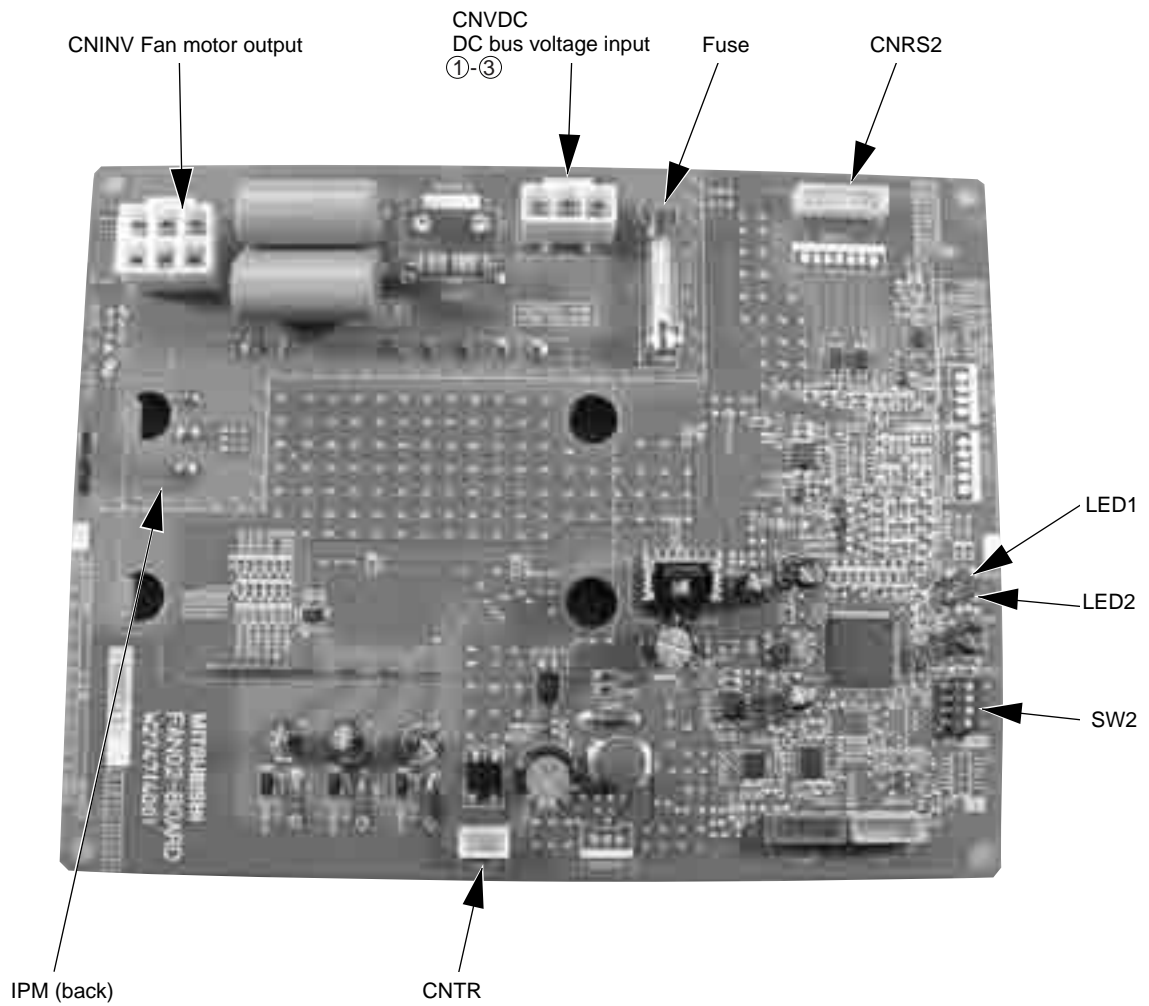

4. Relay board

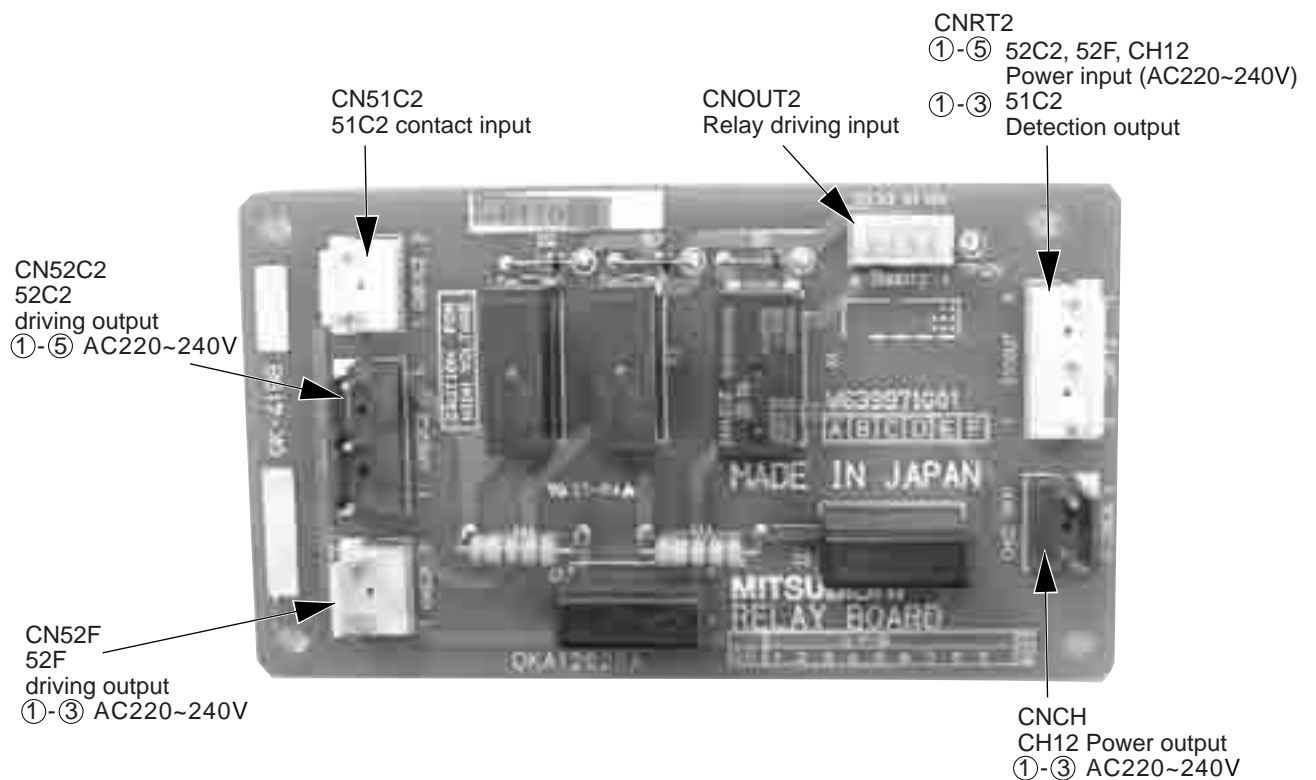

5. Filter board

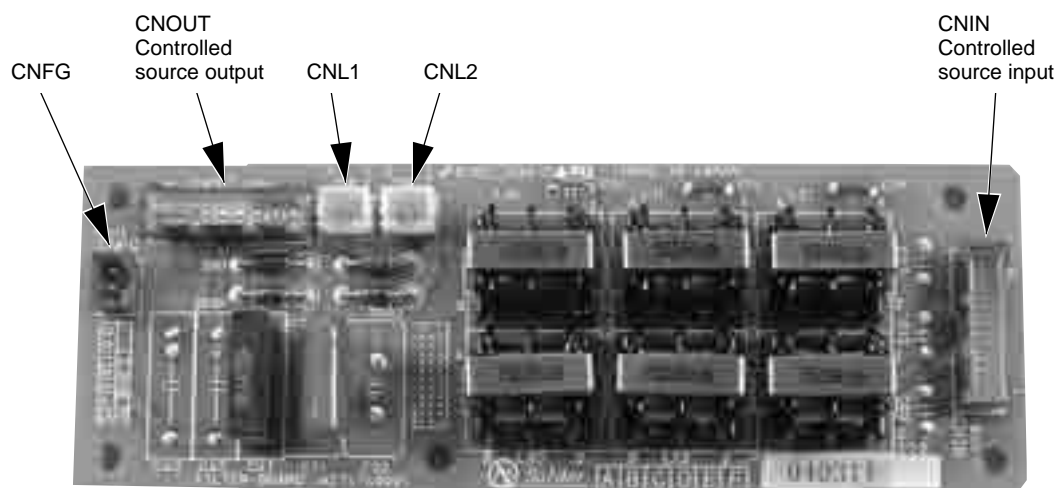

6. G/A board

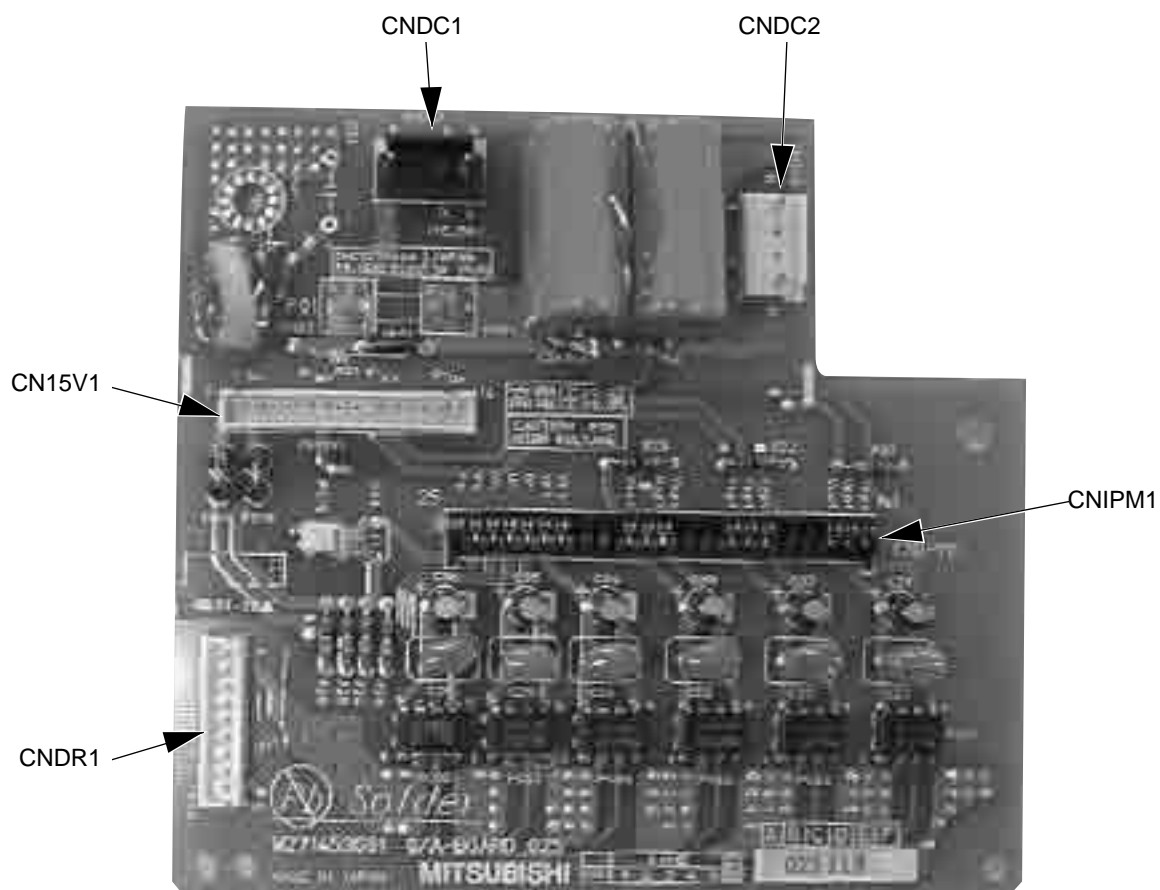

IV Indoor Unit Components

[1] External Dimensions.....	45
[2] Indoor Unit Components and Internal Structure	47
[3] Control Box of the Indoor Unit	51
[4] Indoor Unit Circuit Board	52
[5] Separating the top and bottom of the unit.....	53



[1] External Dimensions

1. PFD-P250VM-E model

Unit : mm

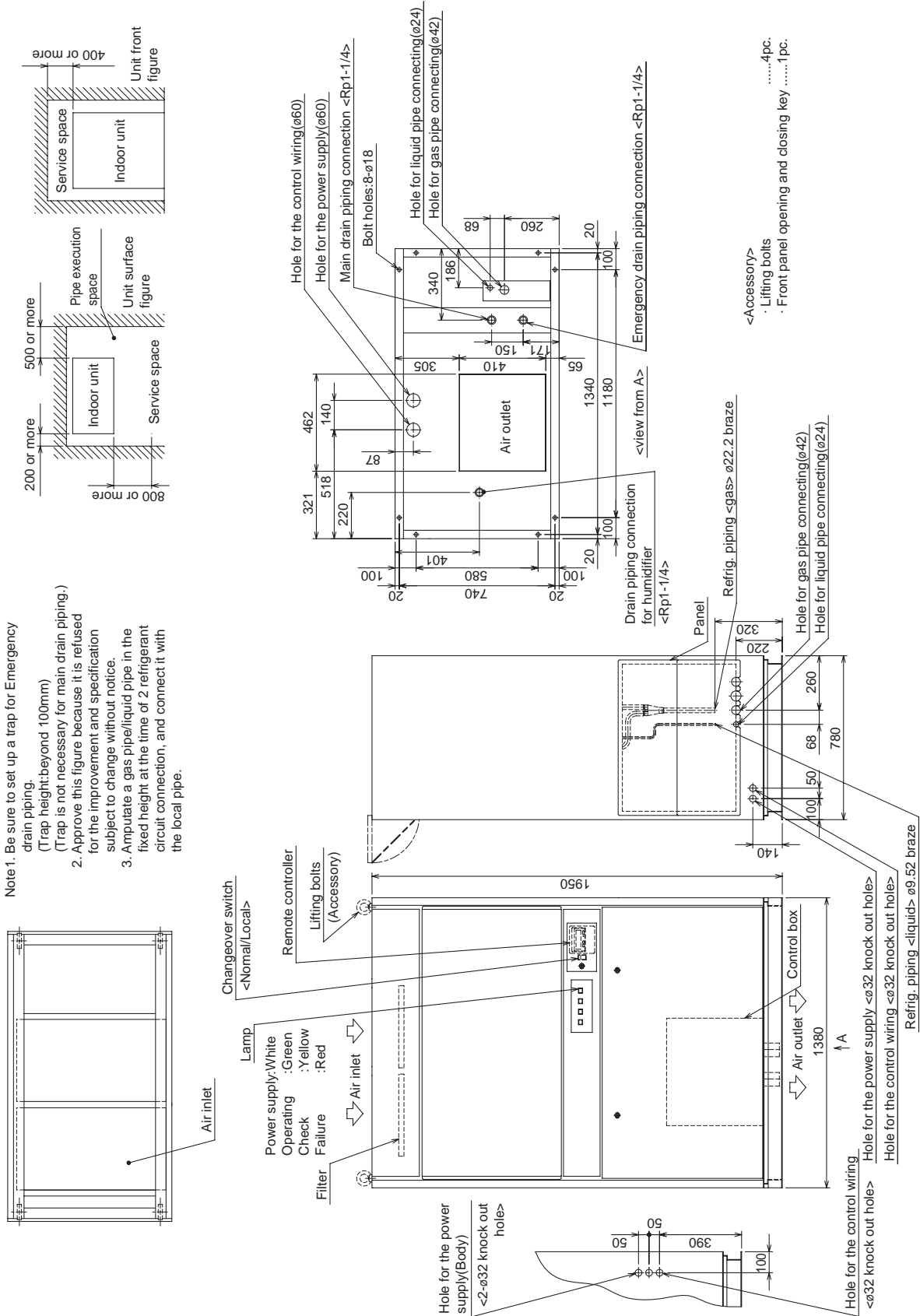

2. PFD-P500VM-E model

Unit : mm

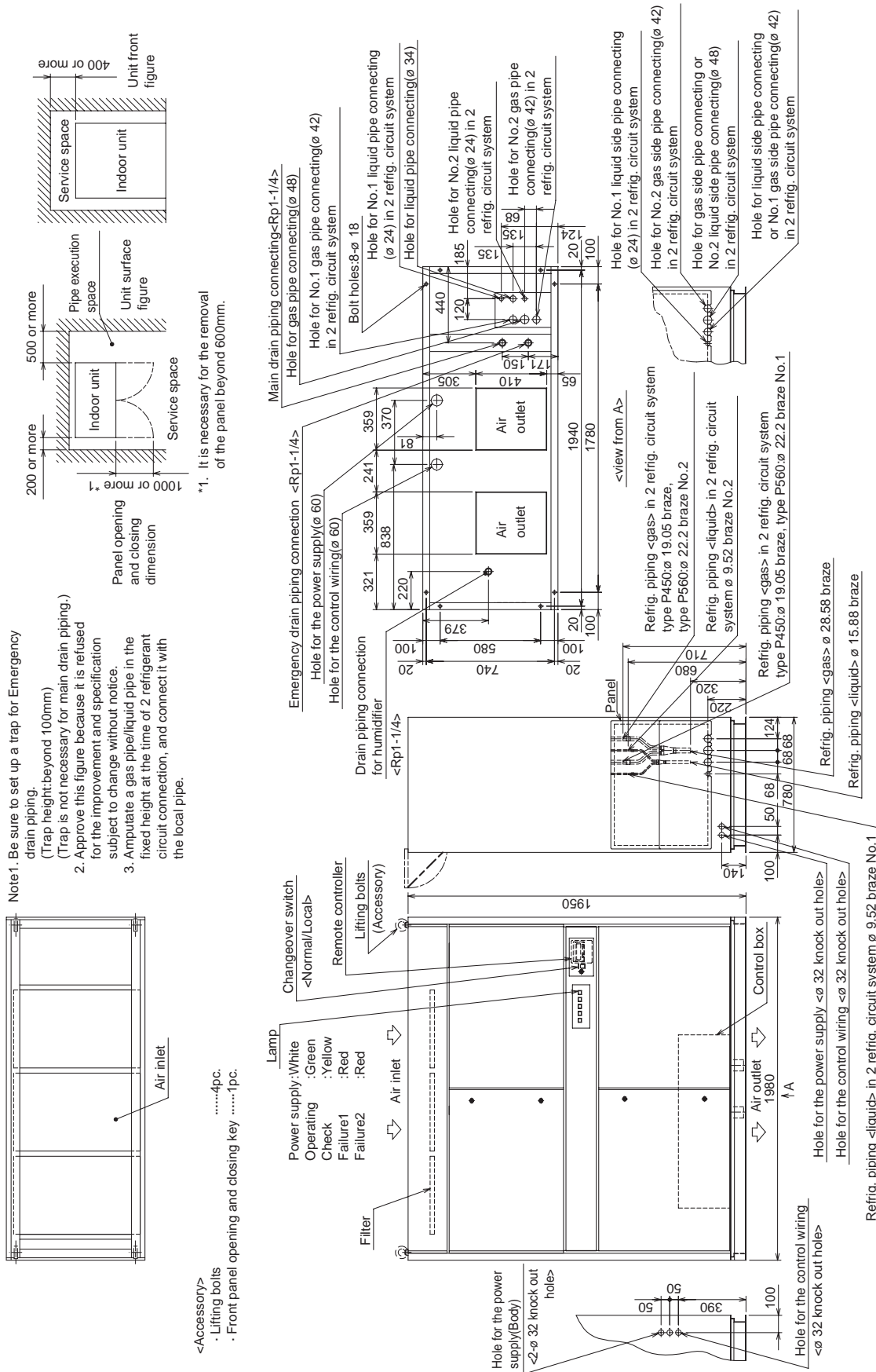

Note 1. Be sure to set up a trap for Emergency drain piping.
(Trap height:beyond 100mm)
(Trap is not necessary for main drain piping.)
2. Approve this figure because it is refused for the improvement and specification subject to change without notice.
3. Amputate a gas pipe/liquid pipe in the fixed height at the time of 2 refrigerant circuit connection, and connect it with the local pipe.

*1. It is necessary for the removal of the panel beyond 600mm.

- <Accessory>
- Lifting bolts4pc.
- Front panel opening and closing key1pc.

[2] Indoor Unit Components and Internal Structure

1. PFD-P250VM-E model
 - (1) Front view of a indoor unit

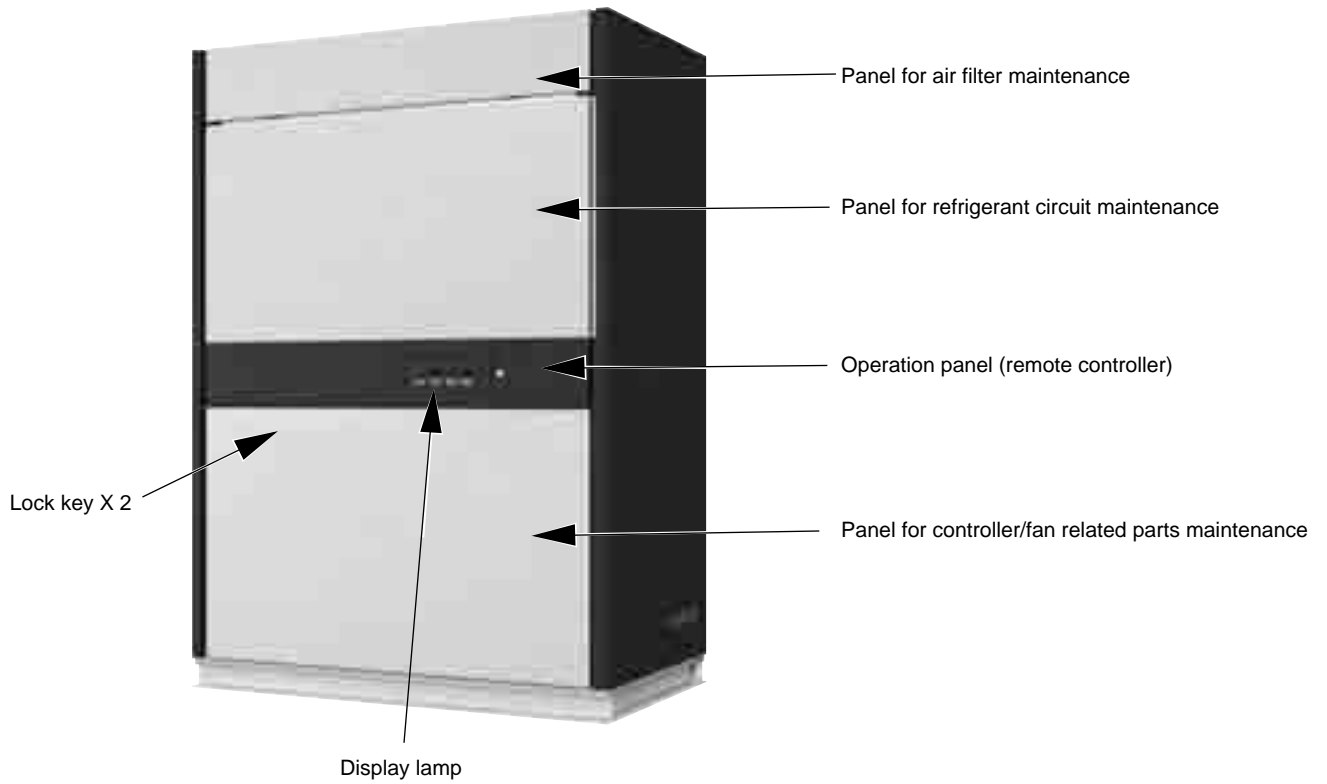

- (2) Rear view of a indoor unit



(3) Front view of internal structure

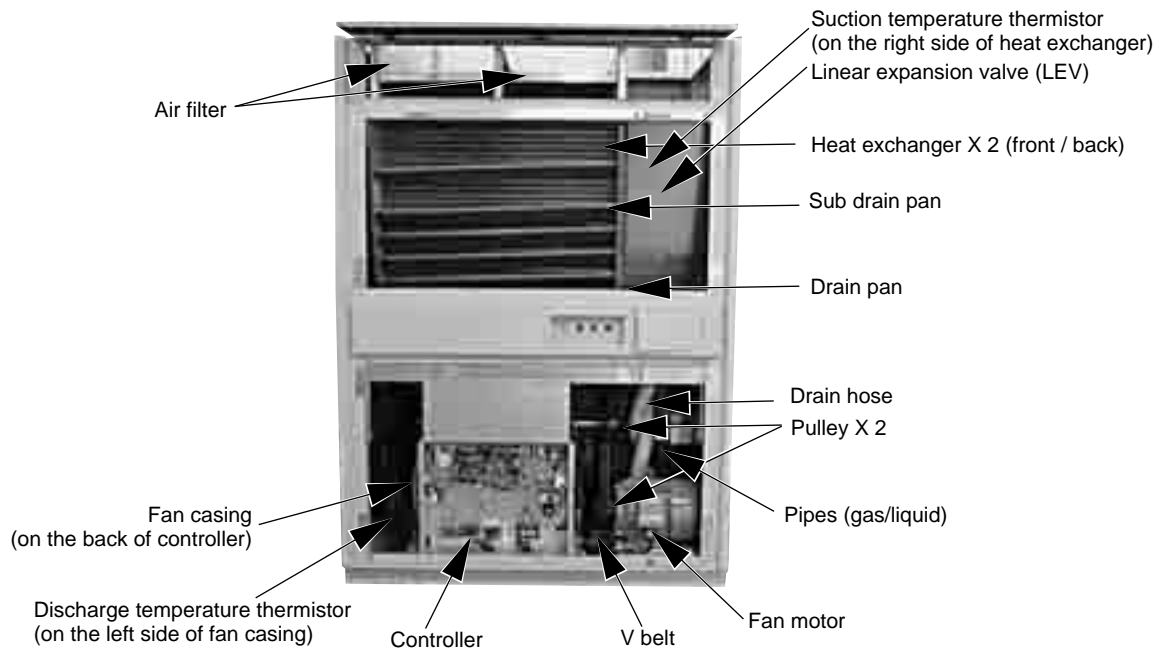

(4) Rear view of internal structure

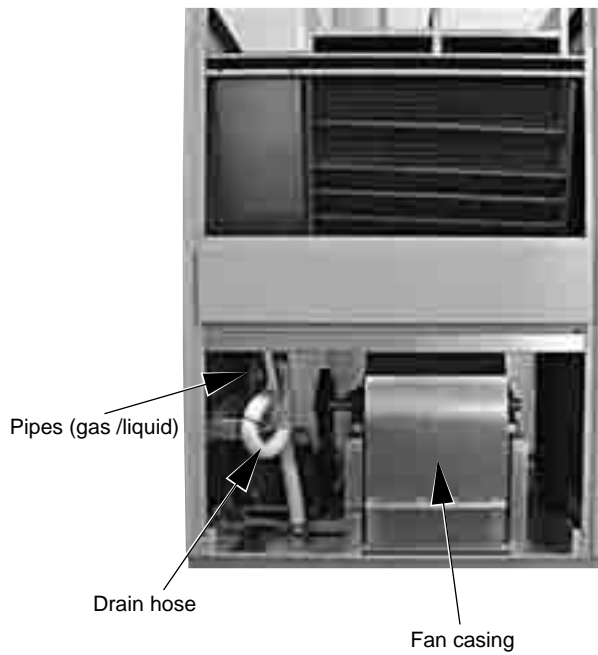

2. PFD-P500VM-E model
(1) Front view of a indoor unit

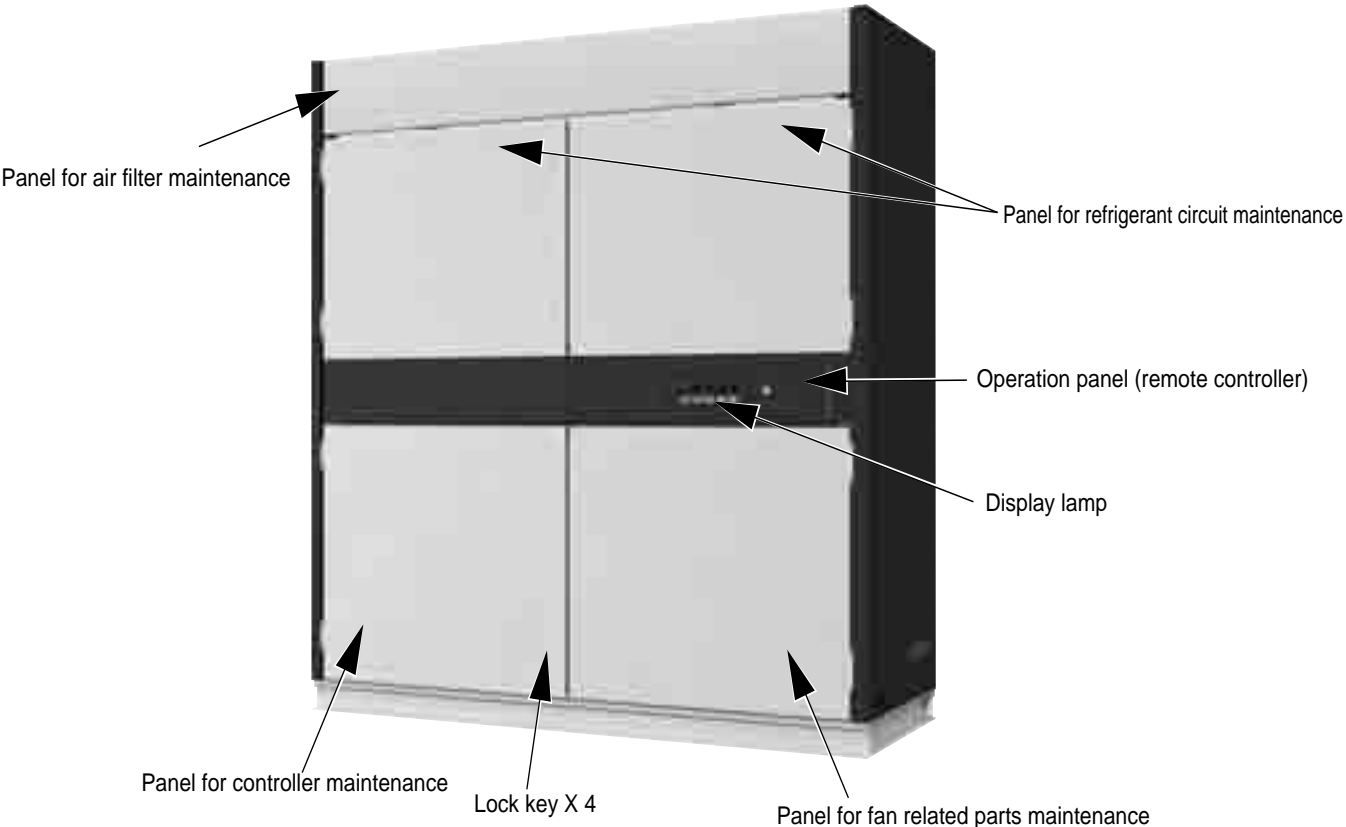

(2) Rear view of a indoor unit



(3) Front view of internal structure

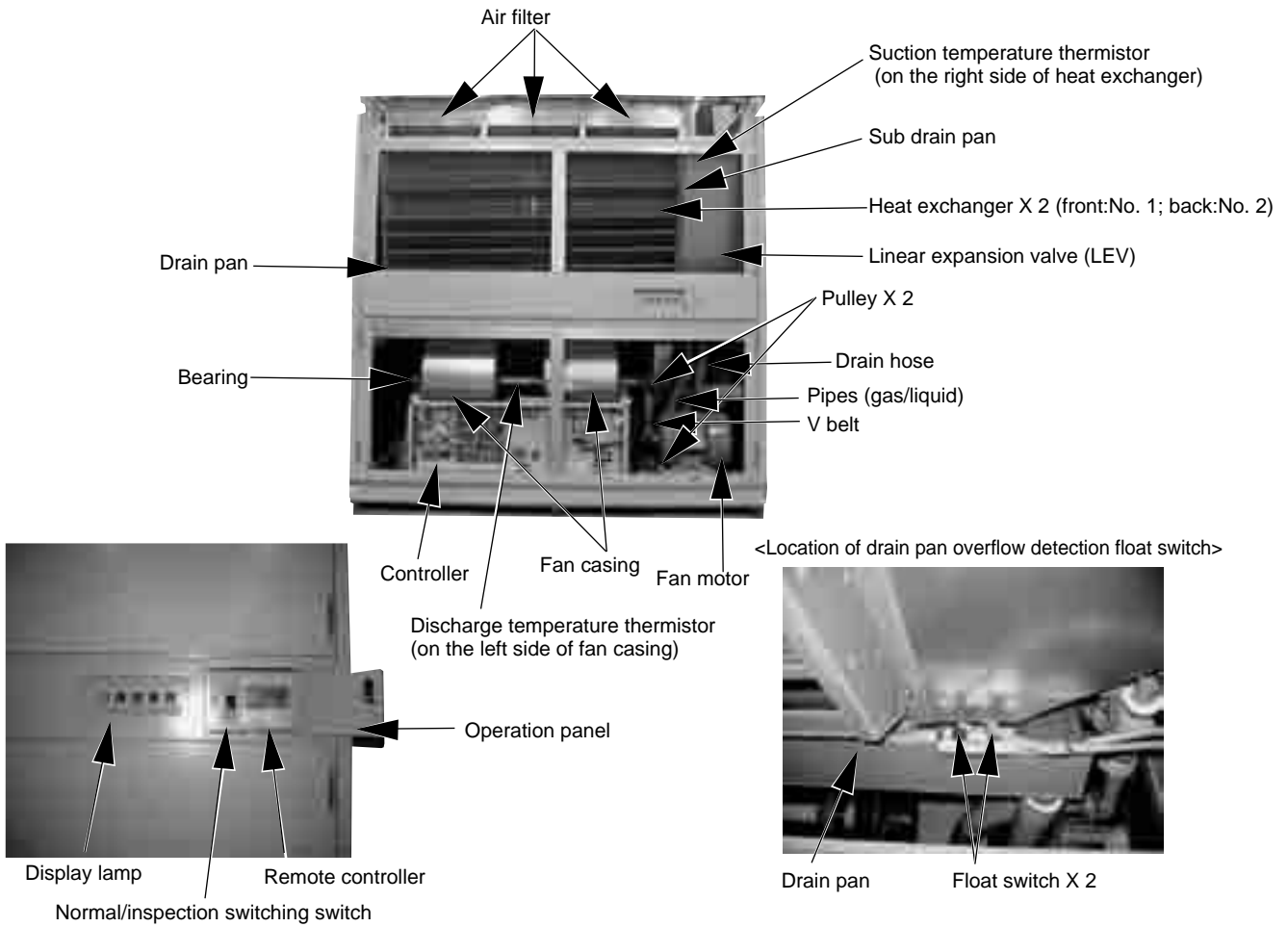

(4) Rear view of internal structure



[3] Control Box of the Indoor Unit

1. PFD-P250VM-E model

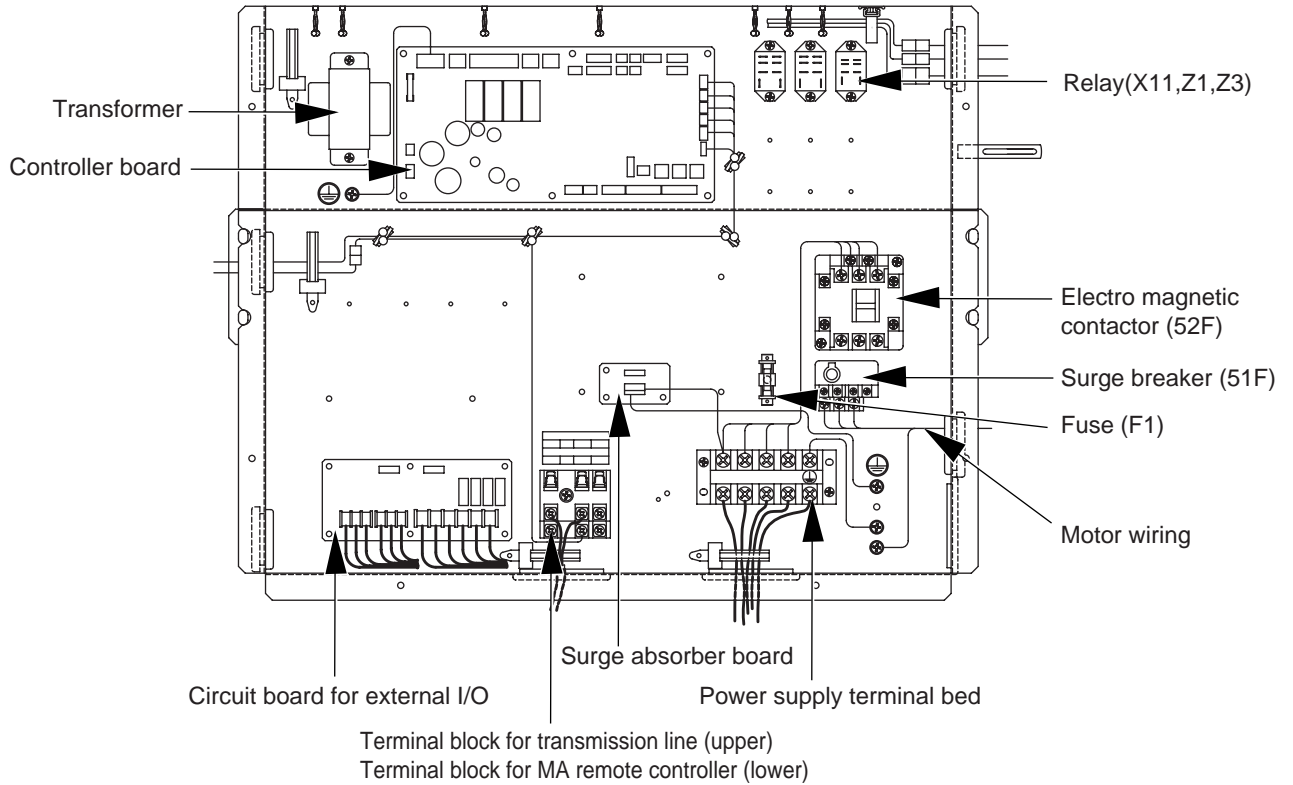

2. PFD-P500VM-E model

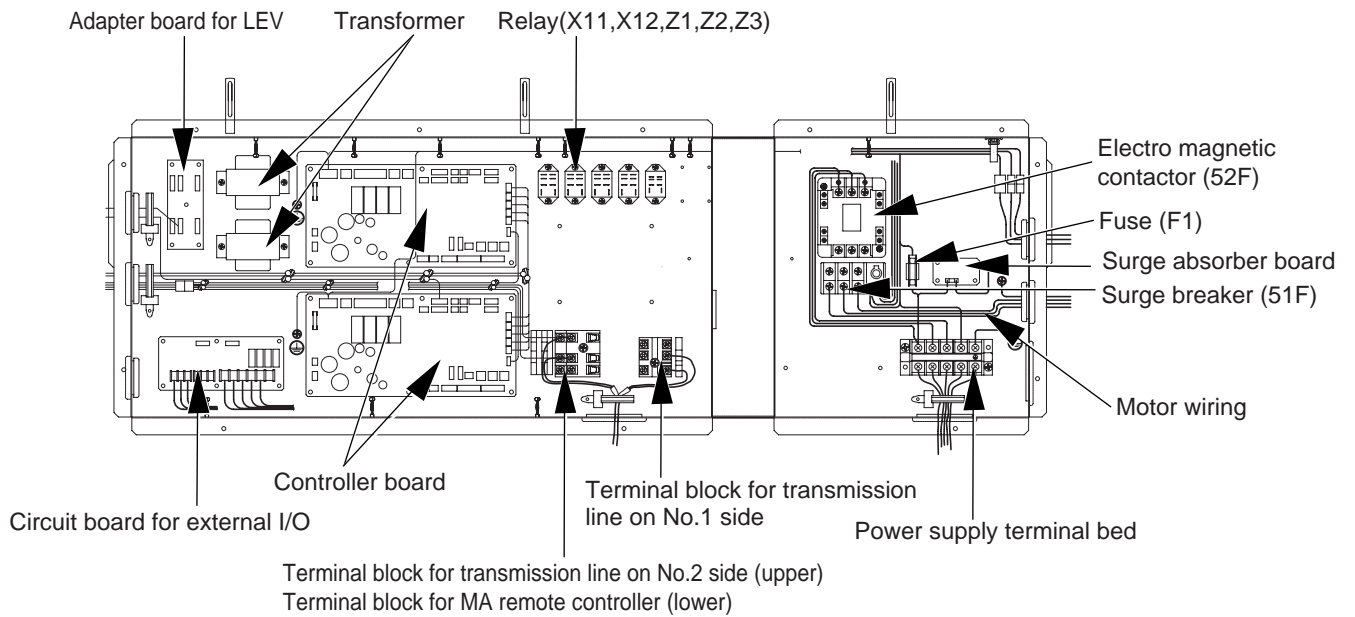

[4] Indoor Unit Circuit Board

1. PFD-P250,P500VM-E models

(1) Indoor Control Board

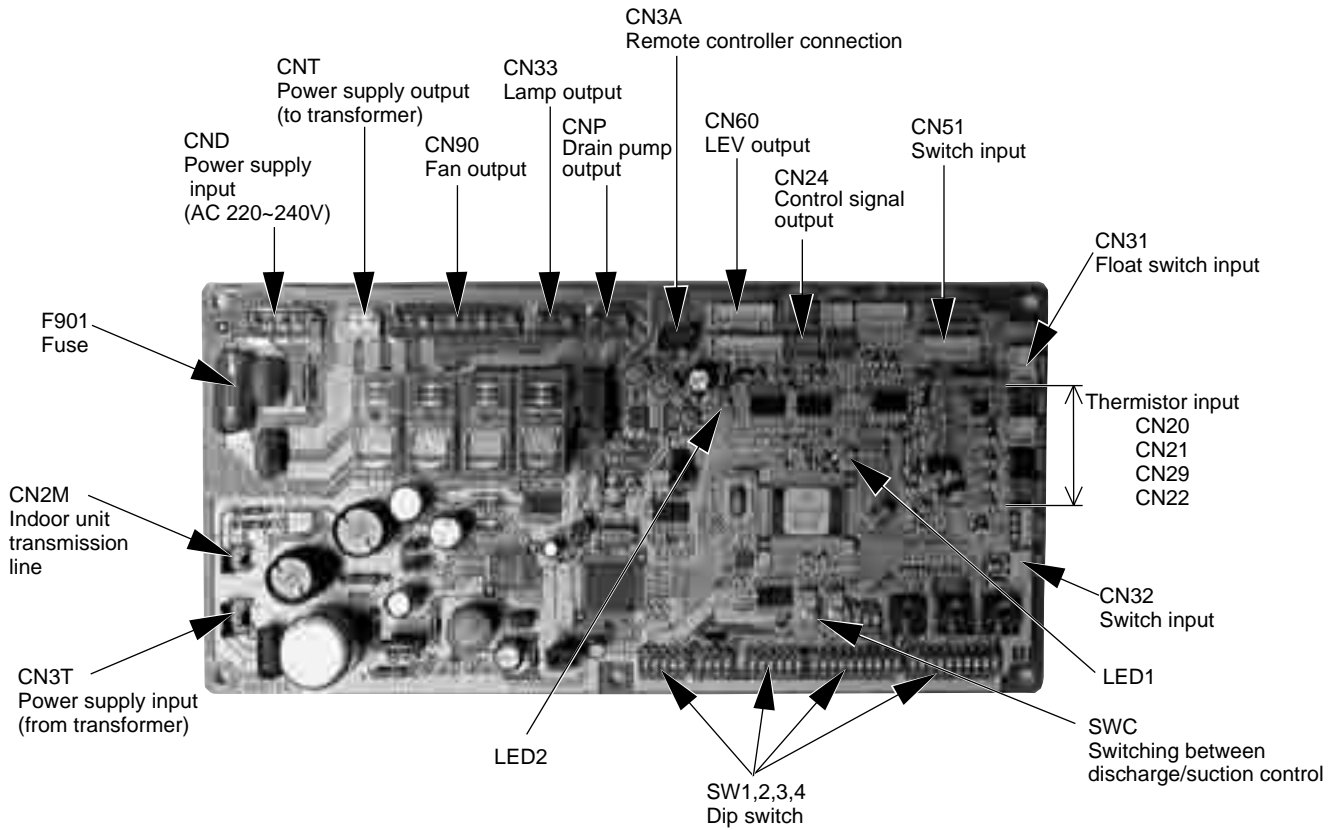

(2) External Input/Output Circuit Board

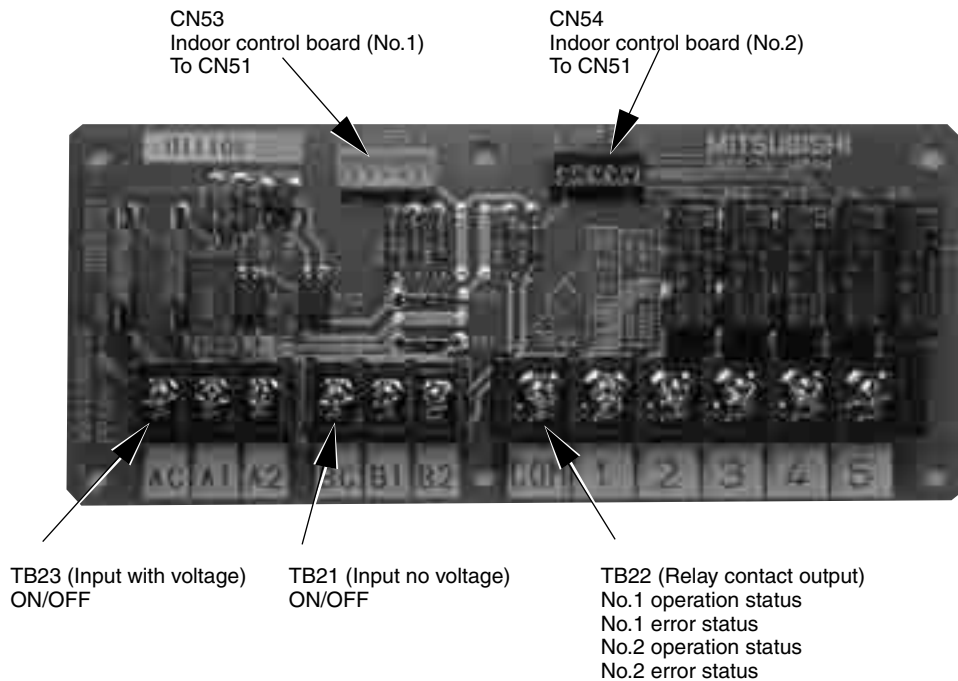

[5] Separating the top and bottom of the unit

The top and the bottom of the unit can be separated. (Requires brazing)
 When separating the top and the bottom of the unit, perform the work on a level surface.

Follow the procedures below when separating the sections.

Necessary tools and materials:

- Ratchet wrench with a socket size of 17 mm (for M10)
- General tools
- Cable ties (for wires)
- Gray vinyl tape (for pipes)
- Supporting wood piece Height 800 mm x width 100 mm x thickness 20 (mm) 1 piece

(1) Removing the decoration panel and filter

<Model 250>

- Remove the front panels (2), rear panels (2), and the side panels (2) in this order by removing the hinges and the screws on the unit as shown in [Fig.1].
- Open the filter cover and remove the filters (2 filters).

<Model 500>

- Remove the front panels (4), rear panels (3), and the side panels (2) in this order by removing the hinges and screws on the unit as shown in [Fig.1].
- Open the filter cover and remove the filters (3 filters).

(2) Disconnecting the electric wires

- Disconnect the wiring connectors from the remote controller, thermistor, float switch, lamp, and linear expansion valve as shown in [Fig.2].
- After removing the connectors, pull out the wires from the control box.
- Unclamp the wires from the frame.
- Put all wires together in a bundle on the unit.

(3) Removing the drain hose and the pipes from the brazed section of the pipe

- Remove the drain hose by unscrewing the screws on both ends of the hose band.
 - Peel off the pipe cover on the pipe so that the torch flame will not reach the cover. Remove the pipe from the brazed section as shown in [Fig.3].
- *Protect the section around the area to be worked on from the torch flame (drain pan, wiring, insulation material on the frame etc).

(4) Separate the top and the bottom of the unit

- Unscrew the screws and loosen bolt ① that are marked with the letter A in [Fig.1] (on four corners)
- Loosen bolt ② loose enough to allow the top and the bottom of the unit to be separated. Be sure to re-tighten bolt ② after separating the top and bottom (Tightening torque: 74N·m).

Separation work is now complete. Exercise caution not to damage or scratch the unit during transportation or get your fingers caught between the units.

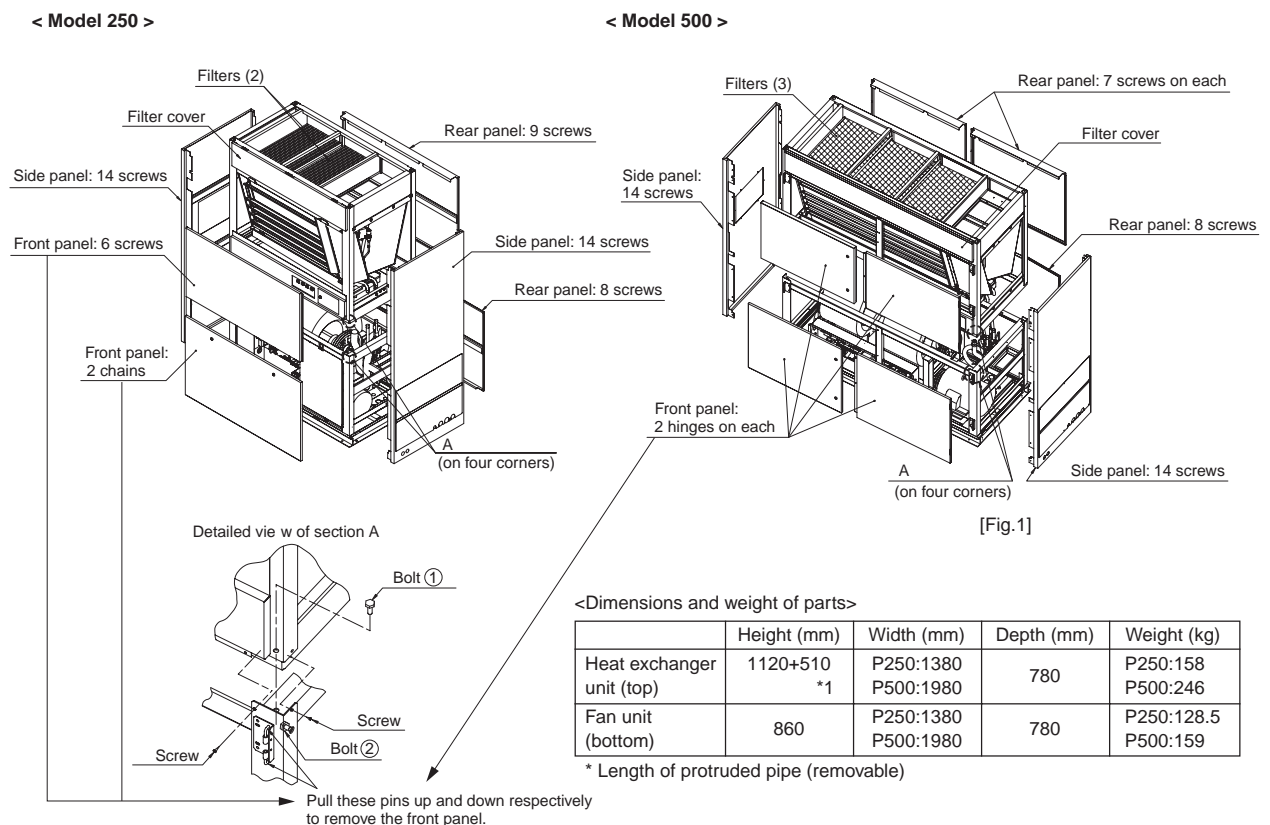

<Model 250>

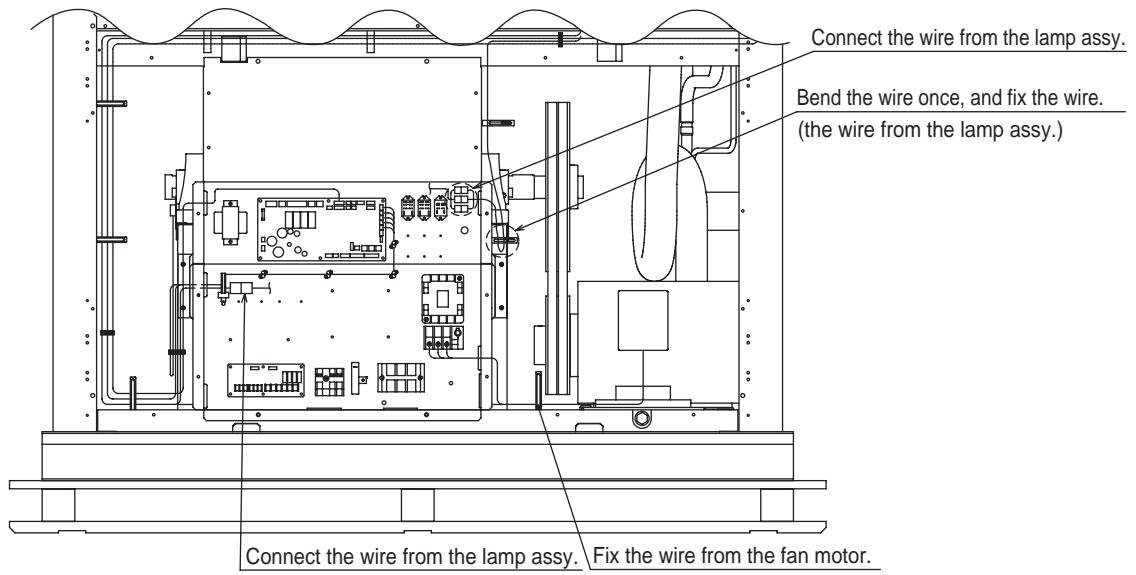

<Model 500>

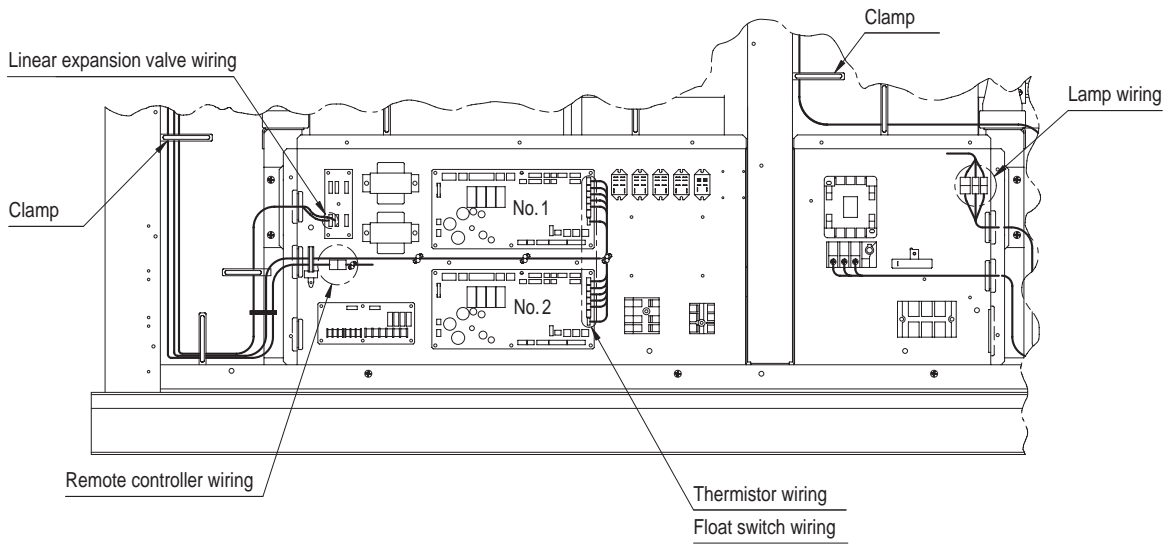

[Fig.2]

<Model 250>

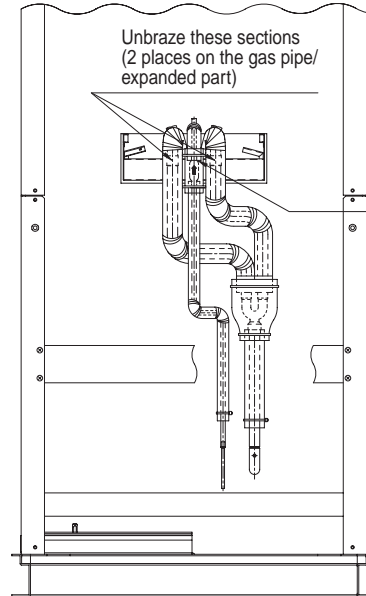
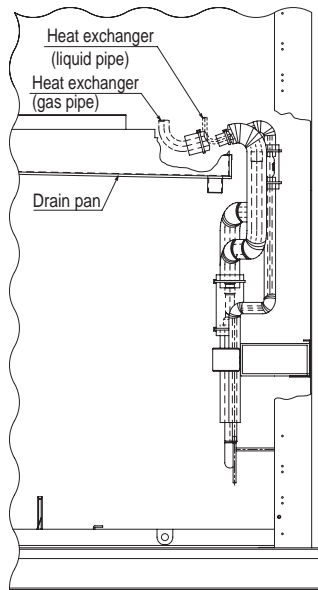

<Model 500>

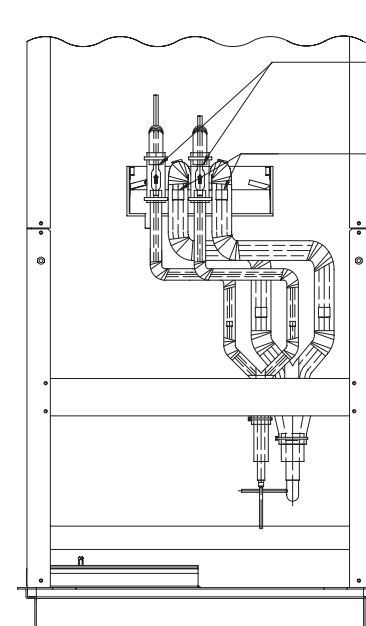
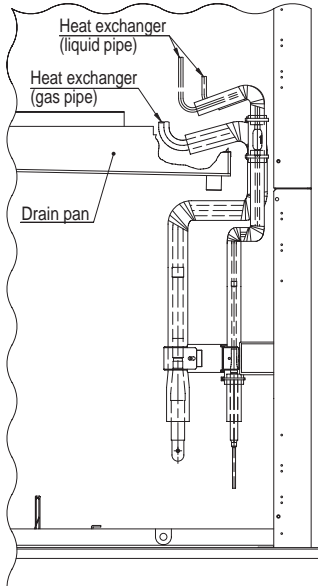

[Fig. 3]

Note

1. Peel off the pipe cover carefully. The cover will be needed again when putting the units together.
2. When loading the unit on an elevator, place the separated sections upright as shown below.
(Place the right side up.) Place a piece of wood at the bottom of the bottom section for support to keep it level.

<Model 250>

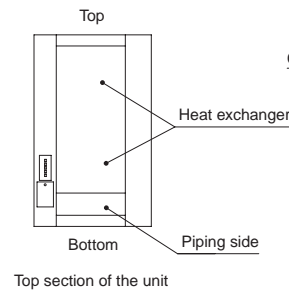
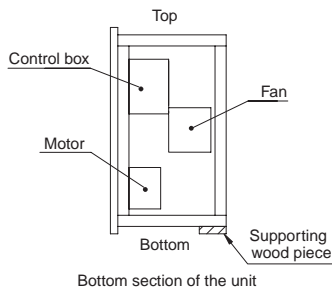

<Model 500>

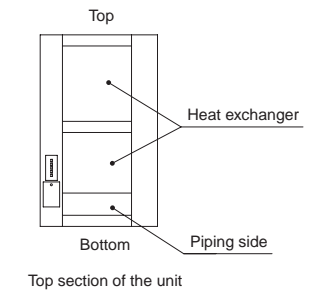
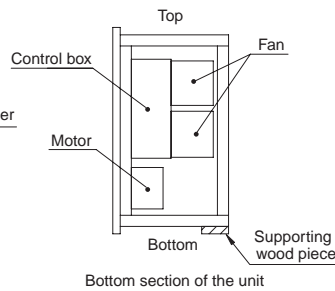

- To put the top and bottom sections of the unit together, follow the procedures above in the reverse order.
- Check to make sure that the frame is perpendicular to the horizontal plane before putting the panels together.
 - When the frames will not fit back into place, loosen bolt ② as shown in [Fig.1], place the frames, and tighten bolt ②.
 - Be sure to securely tighten all screws and bolts. (tightening torque: 74N·m)
 - Using [Fig.4] and Table 1 as a reference, connect all connectors correctly.
Use a cable tie and bundle the wires as they were before.
 - Keep torch flame away from the insulation material on the drain pan and from other flammable materials when performing brazing work. Use the shielding board that is supplied.
 - Perform a test run and check for abnormal sound, rattling, and water leaks.

<Model 250>

Table 1

Board No.	Connector	Wire mark	Connector color	No. of pins	Parts name
No.1	CN31	1	White	3	Float switch
	CN20	S1	Red	2	Inlet thermistor
	CN21	E1	White	2	Liquid pipe thermistor
	CN29	G1	Black	2	Gas pipe thermistor
	CN60	V1	White	6	Linear expansion valve

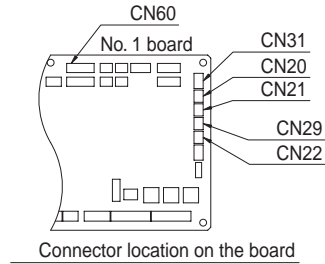

[Fig. 4]

<Model 500>

Table 1

Board No.	Connector	Wire mark	Connector color	No. of pins	Parts name
No.1	CN31	1	White	3	Float switch
	CN20	S1	Red	2	Inlet thermistor
	CN21	E1	White	2	Liquid pipe thermistor
	CN29	G1	Black	2	Gas pipe thermistor
	LEV2A	V1	White	6	Linear expansion valve
No.2	CN31	2	White	3	Float switch
	CN20	S2	Red	2	Inlet thermistor
	CN21	E2	White	2	Liquid pipe thermistor
	CN29	G2	Black	2	Gas pipe thermistor
	LEV2B	V2	White	6	Linear expansion valve

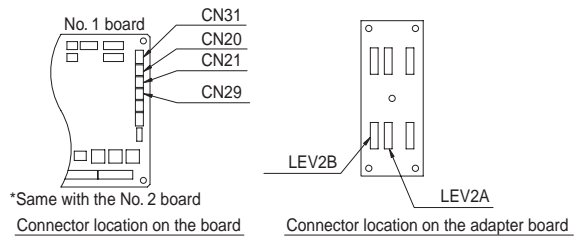

[Fig. 4]

⚠ Caution

Use a hand-lift truck to transport the units; they are heavy even when the top and bottom sections are separated. Carrying the units by hand is dangerous and may result in personal injury if the units fall or topple over. Exercise caution not to get your fingers caught when separating or assembling the top and bottom sections of the unit.

V Electrical Wiring Diagram

[1] Electrical Wiring Diagram of the Outdoor Unit.....	59
[2] Electrical Wiring Diagram of the Indoor Unit.....	61



[1] Electrical Wiring Diagram of the Outdoor Unit

1. PU(H)Y-P250YGM-A model

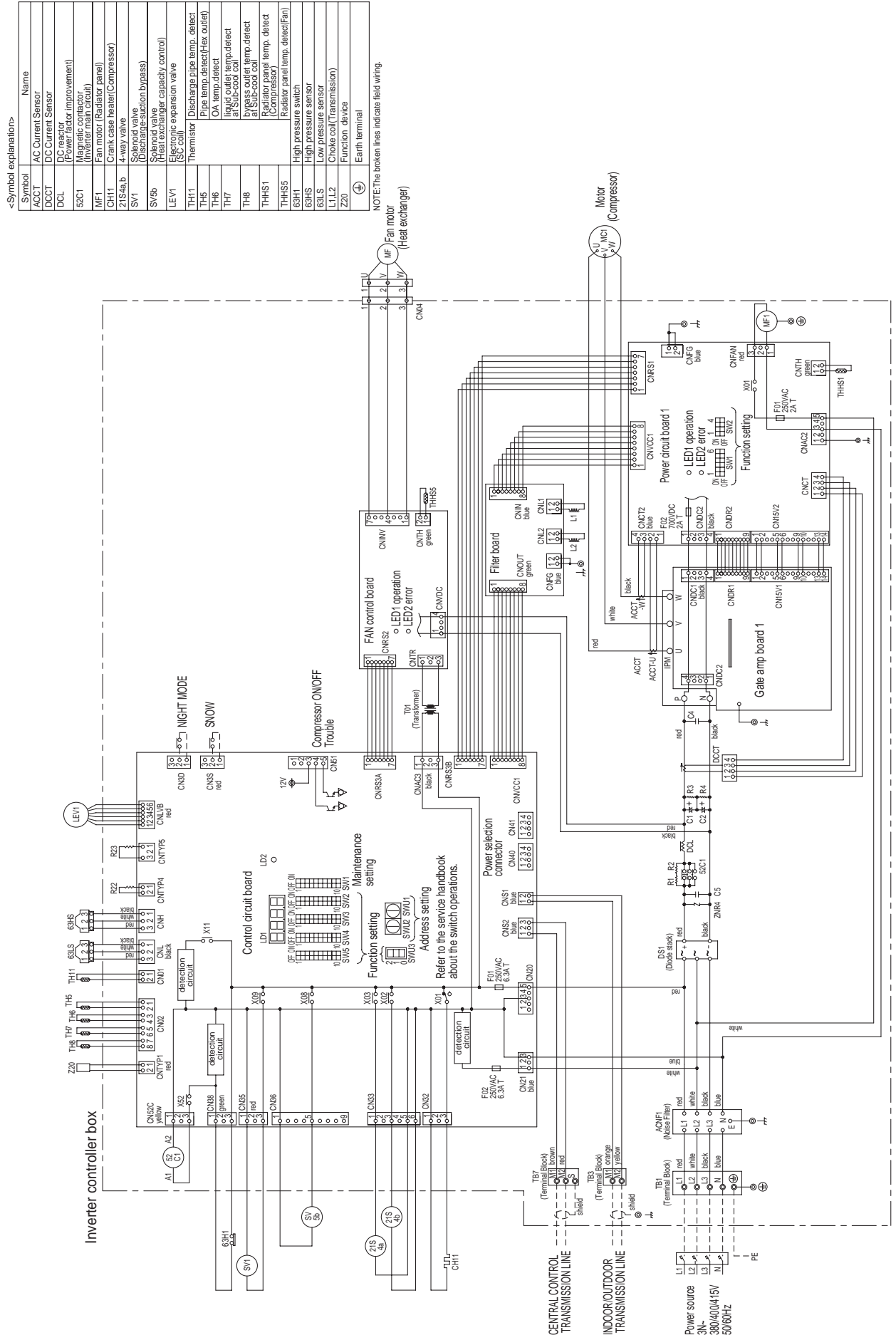

2. PUHY-P500YGM-A model

<Symbol explanation>

Symbol	Name
ACCT	AC Current Sensor
DCCT	DC Current Sensor
DCL	DC reactor
52C1	(Magnetic contactor (Power factor improvement))
52C2	(Magnetic contactor (No.2 Compressor))
52F	Magnetic contactor (Fan motor)
CH11,12	Crank case heater (Compressor)
21Sa,b,c	4-way valve
SV1,3	Solenoid valve (Discharge-stubon bypass)
SV5b,c	Heat exchanger capacity control)
LEV1	Electronic expansion valve (SC coil)
TH11,12	Thermistor (Discharge pipe temp. detect (Hex outlet))
TH2	(Hex outlet)
TH5	Pipe temp. detect (Hex outlet)
TH6	OA temp. detect
TH7	liquid outlet temp. detect at Sub-cool coil
TH8	liquid outlet temp. detect at Sub-cool coil
THHS1	Radiator panel temp. detect (Compressor)
THHS2	Radiator panel temp. detect (Fan)
E3H1,2	High pressure sensor
E3HS	High pressure sensor
E3LS	Low pressure sensor
L1,L2	Crank coil (transmission)
Z20	Function device
⊕	Earth terminal

NOTE: The broken lines indicate field wiring.

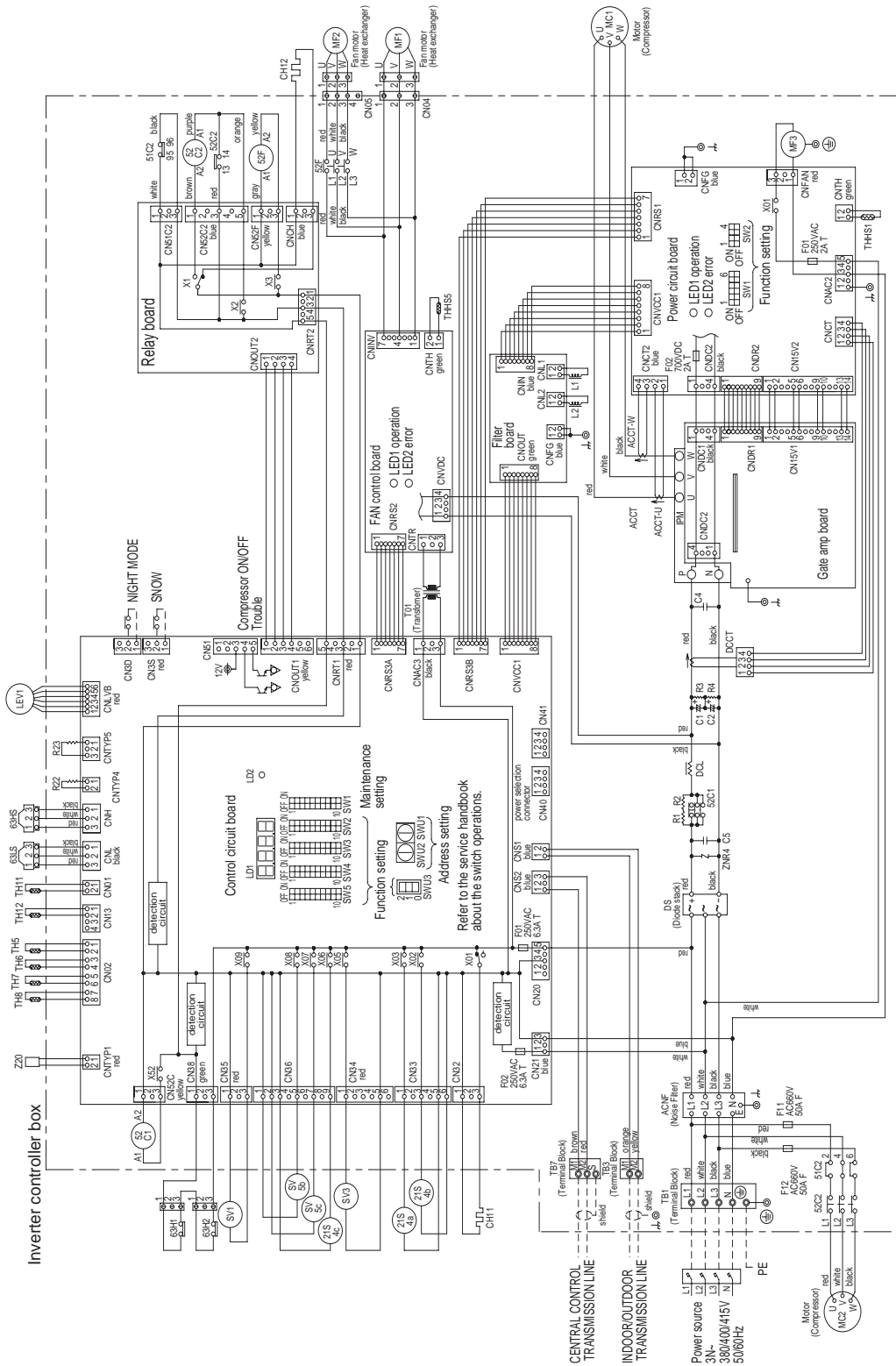

2. PFD-P500VM-E model

SYMBOL	NAME
MF	Fan motor
IB.1, IB.2	Indoor controller board
AD.B.	Adapter board
S.B.	Surge absorber board
IFB	External input/output board
TB2	Power source terminal bed
TB5-1, -2	Transmission terminal bed
TB15	Terminal bed for distant location on/off
TB21	Terminal bed for distant location on/off <No voltage or current>
TB22	Terminal bed for distant location display
TB23	Terminal bed for distant location on/off <With voltage and current>
F901	Fuse <6.3/16A>
F1	Fuse <5A>
ZNR1, ZNR2, ZNR901	Varistor
DSA1	Surge absorber
T	Transformer
LEV1, 2	Electronic linear expansion valve
52F	Contactor (fan I/D)
51F	Over current relay (fan I/D)
33P1, 33P2	Float switch
TH21-1, TH21-2	Thermistor (inlet temp.detection)
TH22-1, TH22-2	Thermistor (piping temp.detection/liquid)
TH23-1, TH23-2	Thermistor (piping temp.detection/gas)
TH24-1, TH24-2	Thermistor (outlet temp.detection)
SW1(1.B.)	Switch (for mode selection)
SW2(1.B.)	Switch (for capacity code)
SW3(1.B.)	Switch (for mode selection)
SW4(1.B.)	Switch (for model selection)
SW9	Switch (normal/local)
SW11(1.B.)	Switch (1st digit address set)
SW12(1.B.)	Switch (2nd digit address set)
SWC(1.B.)	Switch (connection No.set)
SW14(1.B.)	Switch (outlet/inlet temp.control)
X11, X12	Auxiliary relay/check
Z1, Z2	Auxiliary relay/fan
Z3	Auxiliary relay(fan failure detection)
L1	LED display (No.1 failure)
L2	LED display (No.2 failure)
L3	LED display (status)
L4	LED display (check)
L5	LED display (power supply)
RC	MA Remote controller

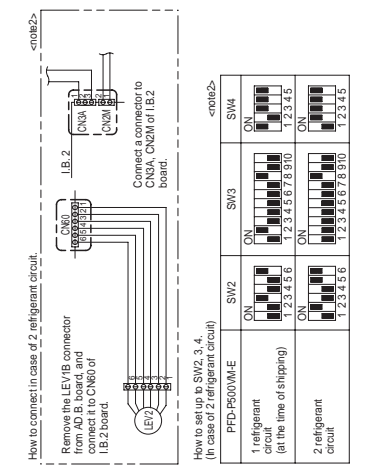
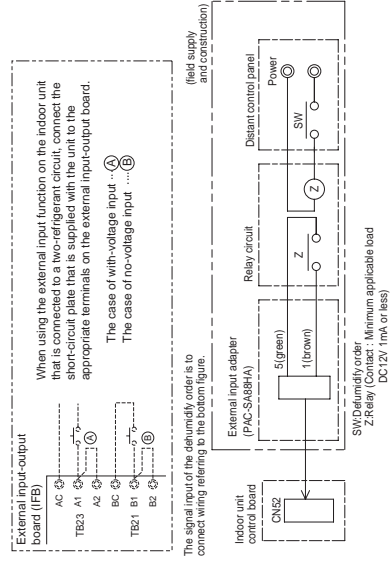
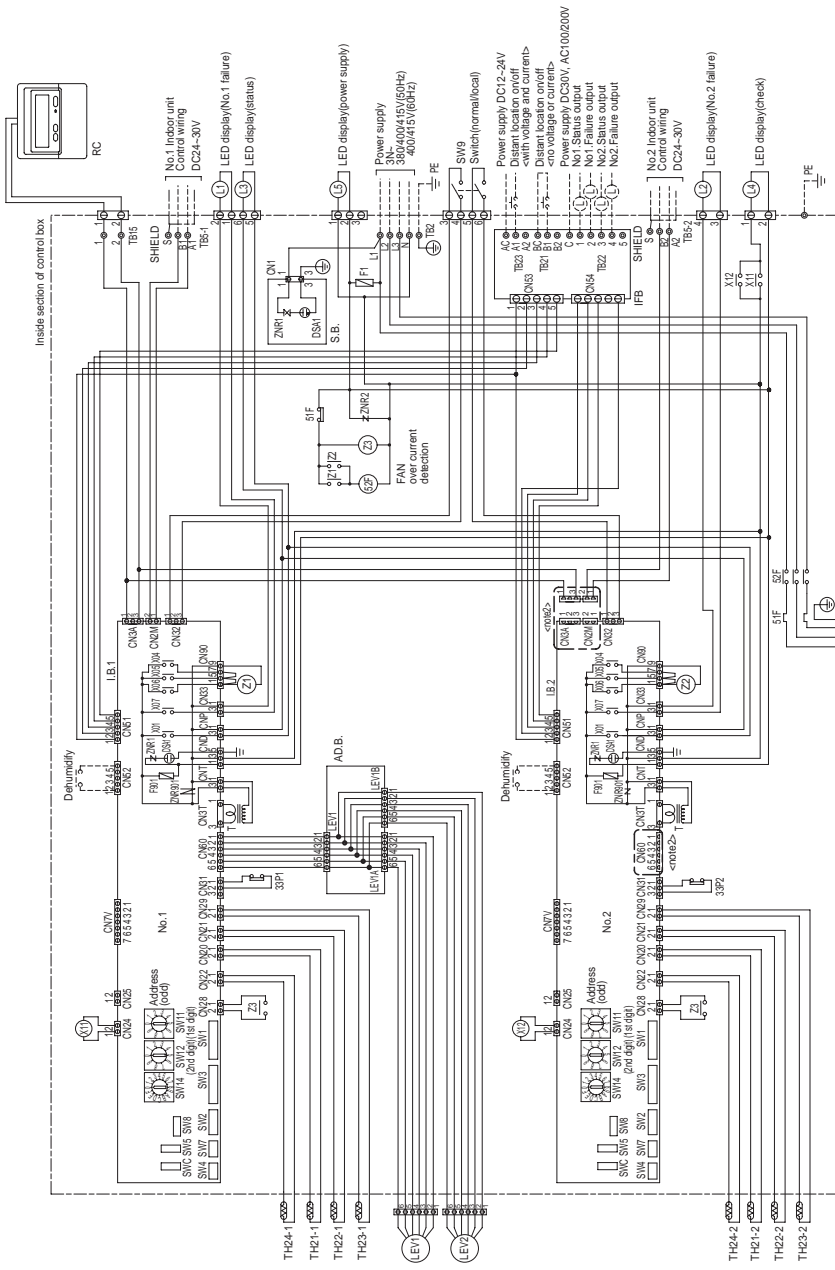

- Note:
- The dotted lines show field wiring.
 - It is wiring for 1 refrigerant system at the time of shipping. Change wiring and SW2, 3, 4 (No.1&No.2) as this figure in field when you change it to 2 refrigerant circuit. But, set up the address of No.1 board in the odd number, and set up the address of No.2 board in the even number.
 - Set up the address of the No.1 board in the No.1 board +1. The outdoor unit to which the indoor unit is connected with the transmission line, the address of the outdoor unit should be the indoor unit +50.
 - Set up the zone No. (SW14) from 1 to 5 when you connect a concentration controller. (Install an indoor unit within 20 units in the all 5 zone.)
 - Mark ⊕ indicates terminal bed, ⊖ connector, ⊞ board insertion connector or fastening connector of control board.

VI Refrigerant Circuit

[1] Refrigerant Circuit Diagram	65
[2] Principal Parts and Functions	68

(2) PUHY-P500YGM-A model

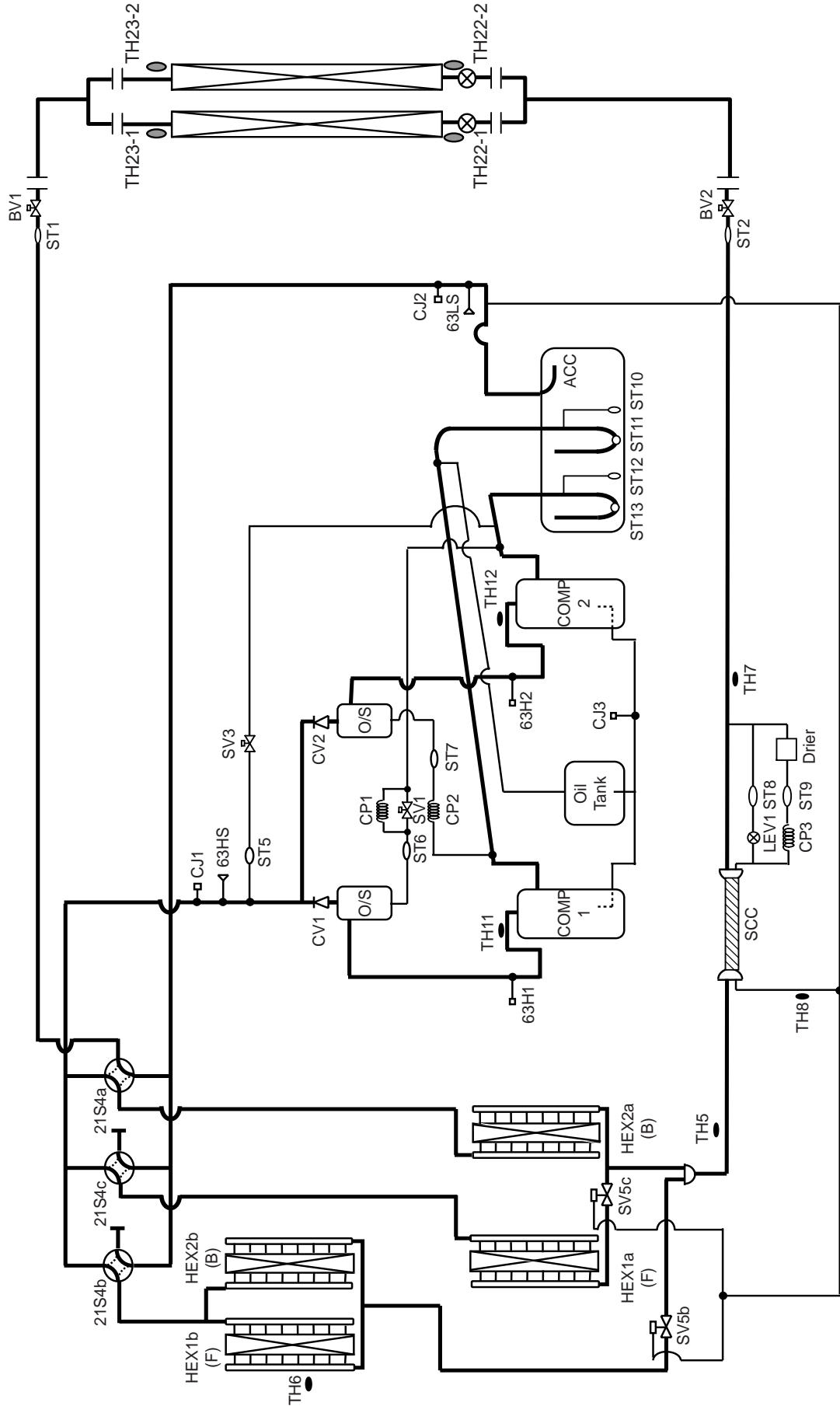

2. System with two refrigerant circuits
 (1) PU(H)Y-P250YGM-A model

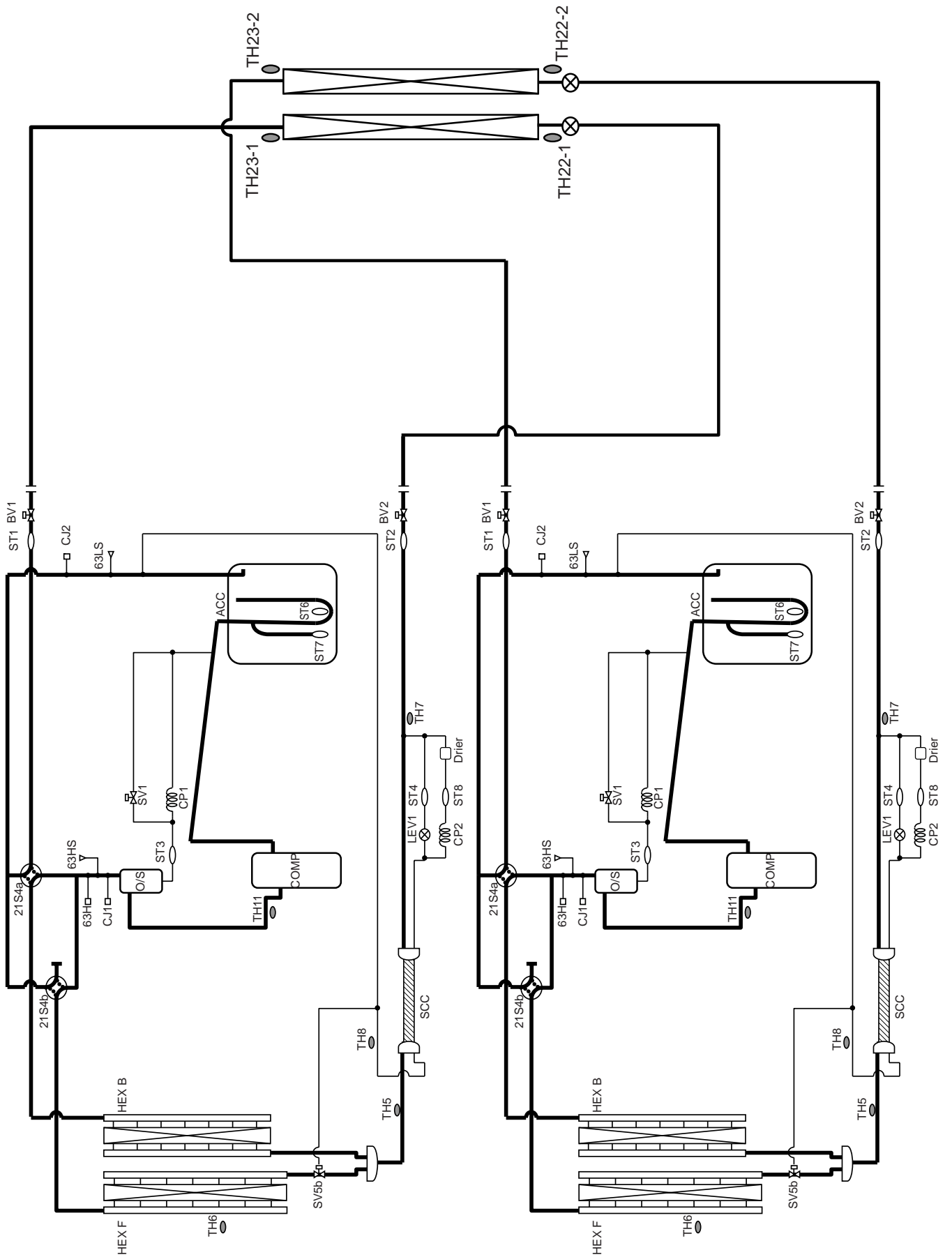

[2] Principal Parts and Functions

1. Outdoor unit

Part name	Symbols (functions)	Notes	Usage	Specifications	Check method
Compressor	MC1 MC2		Adjusts the amount of circulating refrigerant by adjusting the operating frequency based on the operating pressure data	Low-pressure shell scroll compressor Wirewound resistance 20°C : 0.583 ohm	
High pressure sensor	63HS		1. Detects high pressure 2. Regulates frequency and provides high-pressure protection	<p>63HS Pressure 0-4.15 MPa Vout 0.5-3.5V 0.071V/0.098 MPa Pressure [MPa] =1.38 x Vout [V]-0.69</p> <p>Connector 1 2 3 1 GND (Black) 2 Vout (White) 3 Vcc (DC5V) (Red)</p>	
Low pressure sensor	63LS		1. Detects low pressure 2. Provides low-pressure protection	<p>63LS Pressure 0-1.7 MPa Vout 0.5-3.5V 0.173V/0.098 MPa Pressure [MPa] =-0.566 x Vout [V] - 0.283</p> <p>Connector 1 2 3 1 GND (Black) 2 Vout (White) 3 Vcc (DC5V) (Red)</p>	
Pressure switch	63H1 63H2	63H2 is available only on P500 model	1. Detects high pressure 2. Provides high-pressure protection	4.15MPa OFF setting	

Part name	Symbols (functions)	Notes	Usage	Specifications	Check method
Ther-mistor	TH11 TH12 (Discharge)	TH12 is available only on P500 model	1. Detects discharge air temperature 2. Provides high-pressure protection 0°C :698kohm 10°C :413kohm 20°C :250kohm 30°C :160kohm 40°C :104kohm 50°C : 70kohm 60°C : 48kohm 70°C : 34kohm 80°C : 24kohm 90°C :17.5kohm 100°C :13.0kohm 110°C : 9.8kohm	$R_{120} = 7.465k\Omega$ $R_{25/120} = 4057$ $R_t = 7.465 \exp\{4057(\frac{1}{273+t} - \frac{1}{393})\}$	Resistance check
	TH5 (Pipe temperature)		1. Controls frequency 2. Controls defrosting during heating operation 3. Detects subcool at the heat exchanger outlet and controls LEV1 based on HPS data and TH5 data	$R_0 = 15k\Omega$ $R_{0/80} = 3460$ $R_t = 15 \exp\{3460(\frac{1}{273+t} - \frac{1}{273})\}$ 0°C :15kohm 10°C :9.7kohm 20°C :6.4kohm 25°C :5.3kohm 30°C :4.3kohm 40°C :3.1kohm	Resistance check
	TH6 (Outdoor temperature)		1. Detects outdoor air temperature 2. Controls fan operation	0°C :15kohm 10°C :9.7kohm 20°C :6.4kohm 25°C :5.3kohm 30°C :4.3kohm 40°C :3.1kohm	
	TH7 TH8		Controls LEV1 based on TH5, TH7, and TH8 data.		
	THHS Inverter heat sink temperature	Heat sink	Controls inverter cooling fan based on THHS temperature	$R_{50} = 17k\Omega$ $R_{25/120} = 4170$ $R_t = 17 \exp\{4170(\frac{1}{273+t} - \frac{1}{323})\}$ 0°C :181kohm 10°C :105kohm 20°C :64kohm 25°C :50kohm 30°C :40kohm 40°C :26kohm	
Solenoid valve	SV1 Discharge-suction bypass		1. High/low pressure bypass at start-up and stopping, and capacity control during low-load operation 2. High-pressure-rise prevention	AC220~240V Open while being powered/ closed while not being powered	Continuity check with a tester
	SV3 Discharge-suction bypass	P500 model only	Provides compressor protection while compressor No. 2 is stopped		
	SV5b Heat exchanger capacity control		Controls outdoor unit heat exchanger capacity	AC220~240V Closed while being powered/ open while not being powered	
	SV5c Heat exchanger capacity control	P500 model only			

[VI Refrigerant Circuit]

Part name	Symbols (functions)	Notes	Usage	Specifications	Check method
Linear expansion valve (LEV)	LEV (SC coil)		Adjusts the amount of bypass flow from the liquid pipe on the outdoor unit during cooling	DC12V Opening of a valve driven by a stepping motor 0-480 pulses (direct driven type)	Same as indoor LEV The resistance value differs from that of the indoor LEV. (Refer to the section "LEV Troubleshooting.")
Heater	CH11 CH12 Crankcase heater	CH12 is available only on P500 model	Heats the refrigerant in the compressor	Cord heater AC220~240V CH11, CH12: 1280ohm 45W	Resistance check
4-way valve	21S4a		Changeover between heating and cooling	AC220~240V Dead: cooling cycle Live: heating cycle	Continuity check with a tester
	21S4b		1. Changeover between heating and cooling 2. Controls outdoor unit heat exchanger capacity	AC220~240V Dead: cooling cycle Outdoor unit heat exchanger capacity at 100% Live: heating cycle Outdoor unit heat exchanger capacity at 50% or heating cycle	
	21S4c	P500 model only			

2. Indoor unit

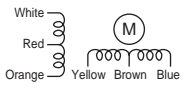
Part name	Symbols (functions)	Notes	Usage	Specifications	Check method
Linear expansion valve (LEV)	LEV		1. Adjusts superheat at the heat exchanger outlet of the indoor unit during cooling 2. Adjusts subcool at the heat exchanger outlet of the indoor unit during cooling	DC12V Opening of a valve driven by a stepping motor 0-(2000) pulses	Continuity check with a tester Continuity between white, red, and orange. Continuity between yellow, brown, and blue. 
Thermistor	TH21 (Suction air temperature)		Indoor unit control (Thermo)	$R_0 = 15k\Omega$ $R_{0/80} = 3460$ $R_t = 15 \exp\{3460 (\frac{1}{273+t} - \frac{1}{273})\}$ 0°C : 15kohm 10°C : 9.7kohm 20°C : 6.4kohm 25°C : 5.3kohm 30°C : 4.3kohm 40°C : 3.1kohm	Resistance check
	TH22 (Pipe temperature)		Indoor unit control (Freeze prevention, Pre-heating stand-by)		
	TH23 (Gas pipe temperature)		LEV control during cooling operation (Superheat detection)		
	TH24 (Discharge air temperature)		Controls indoor unit discharge (thermostat)		
Float Switch	33P1		Detects drain pan water level	Contact Resistance: Under 250 mohm B contact type	Continuity check with a tester
	33P2	P500 model only			
Motor	MF		Sends air	PFD-P250VM-E AC380~415V Type E 4P Output 3.7kW	Rotation number check Standard 930rpm
				PFD-P500VM-E AC380~415V Type B 4P Output 5.5kW	Rotation number check Standard 978rpm

VII Control

[1] Functions and Factory Settings of the Dipswitches	75
[2] Controlling the Outdoor Unit	80
[3] Controlling the Indoor Unit	88
[4] Operation Flow Chart.....	92



[1] Functions and Factory Settings of the Dipswitches

1. Outdoor unit

(1) Main board

Switch		Function	Function according to switch setting		Switch setting timing	
			OFF	ON	OFF	ON
SWU	1-2	Unit address setting	Set to 00 or 51-100 with the dial switch		Before power on	
SW1	1-10	For self-diagnosis/operation monitoring	Refer to the LED monitor display on the outdoor unit board.		Anytime after power on	
SW2	1	-	-	-	-	
	2	Deletion of connection information	Normal control	Deletion	Before power on	
	3	Deletion of error history SW	Storage of IC/OC error history	Deletion of IC/OC error history	Anytime after power on (When switched from OFF to ON)	
	4	Refrigerant amount adjustment	Normal control	Refrigerant amount adjustment mode	Anytime after power on (Will be disabled 2 hours after compressor start up except during initial start up mode)	
	5	-	-	-	-	
	6	-	-	-	-	
	7	Forced defrost	Normal control	Forced defrost starts	Anytime after power on (When switched from OFF to ON)	10 minutes after compressor start-up
	8	Defrost timer setting	50 minutes	90 minutes	Anytime after power on (When switched from OFF to ON)	
	9	-	-	-	-	
	10	-	-	-	-	
SW3	1	SW3-2 function: enabled/disabled	SW3-2 disabled	SW3-2 enabled	Anytime after power on	
	2	Test run mode: ON/OFF	Stops all ICs	Sends a test-run signal to all IC	After power on and when SW3-1 is on.	
	3	Defrost start temperature	-10°C (-8 °C for 500 model unit)	-7°C (-5 °C for 500 model unit)	Anytime after power on	
	4	Defrost end temperature	10°C (7°C for 500 model unit)	15°C (12°C for 500 model unit)	Anytime after power on (except during defrost operation)	
	5	-	-	-	-	
	6	Pump down operation	Normal control	Pump down operation	After power on and while compressor is stopped	
	7	Target condensing temperature on the heating mode Tcm	49°C	53°C	Anytime after power on	
	8	-	-	-	-	
	9	-	-	-	-	
	10	-	-	-	-	

Note: All are set to OFF at factory shipment. (* For PUY series, only the SW4-9 is set to ON.)

Unless otherwise specified, set the switch to OFF where indicated by "-", which may be set to a certain setting for a reason.

Switch		Function	Function according to switch setting		Switch setting timing	
			OFF	ON	OFF	ON
SW4	1	-	-	-	-	
	2	-	-	-	-	
	3	-	-	-	-	
	4	Reset of the integrated operation time Valid/Invalid (comp 1 side)	Disabled	Enabled	Anytime after power on	
	5	Reset of the integrated operation time Valid/Invalid (comp 2 side)	Disabled	Enabled	Anytime after power on	
	6	-	-	-	-	
	7	-	-	-	-	
	8	-	-	-	-	
	9	-	-	-	-	
	10	Dehumidification priority control Valid/Invalid	Enabled	Disabled	Anytime after power on	
SW5	1	-	-	-	-	
	2	Rotation time under two-refrigerant circuit system	240hr	120hr	Anytime after power on	
	3	-	-	-	-	
	4	Thermo-ON/OFF conditions control	Valid	Invalid	Anytime after power on	
	5	-	-	-	-	
	6	-	-	-	-	
	7	-	-	-	-	
	8	-	-	-	-	
	9	-	-	-	-	
	10	-	-	-	-	
SWU	3	Reset of the integrated operation time	Resetting the integrated operation time according to the settings of SW4-4 and 4-5		After power on. (when switching from 0 or 1 to 2)	

Note: All are set to OFF at factory shipment. (* For PUY series, only the SW4-9 is set to ON.)
 Unless otherwise specified, set the switch to OFF where indicated by "-", which may be set to a certain setting for a reason.

(2) Compressor INV board

Switch		Function	Function according to switch setting		Switch setting timing	
			OFF	ON	OFF	ON
SW1	1	Enabling/disabling the following error detection functions; ACCT or DCCT sensor circuit error (530X Detail No. 115, 116) ACCT or DCCT sensor failure (530X Detail No.117,118) IPM open/Disconnected CNCT2 (530X Detail No. 119) Detection of erroneous wiring (530X Detail No.120)	Error detection enabled	Error detection disabled	Anytime after power on	
	2	-	-	-	-	
	3	-	-	-	-	
	4	-	-	-	-	
SW2	1	Inverter address	0	1	Always leave it to ON	
	2	-	-	-	-	
	3	-	-	-	-	
	4	-	-	-	-	

Note1 Except for SW2-1, all are set to OFF at factory shipment. Unless otherwise specified, set the switch to OFF where indicated by "-", which may be set to a certain setting for a reason.

Note2 Leave SW1-1 to OFF during normal operation. If it is set to ON, errors cannot be detected and the unit may be damaged.

(3) FAN INV board

Switch		Function	Function according to switch setting		Switch setting timing	
			OFF	ON	OFF	ON
SW2	1	Inverter address	0	5	Always leave it to ON	
	2	-	-	-	-	
	3	-	-	-	-	
	4	-	-	-	-	

Note: Except for SW2-1, all are set to OFF at factory shipment. Unless otherwise specified, set the switch to OFF where indicated by "-", which may be set to a certain setting for a reason.

2. Function of the switch (Indoor unit)





(1) Dipswitches [SW1,3,7]

Switch	Function	Function according to switch setting		Switch setting timing		Notes
		OFF	ON	OFF	ON	
SW1	1	Function selection	Heat pump	Cooling only	While the unit is stopped (Remote controller OFF)	
	2	Clogged filter detection	Not available	Available		
	3	Filter check reminder time setting	100h	2500h		
	4	-	-	-		
	5	Remote display option	Fan output	Thermo-ON signal		
	6	-	-	-		
	7	-	-	-		
	8	-	-	-		
	9	External input	Level	Pulse		
	10	Operation switching	External input	MA remote controller		
SW3	1	-	-	-		
	2	Capacity code	Refer to the combination with SW2			
	3	-	-	-		
	4	-	-	-		
	5	-	-	-		
	6	-	-	-		
	7	LEV setting conversion function	Not available	Available		
	8	-	-	-		
	9	-	-	-		
	10	-	-	-		
SW7	1	Reset of the integrated operation time Valid/Invalid (fan belt)	Not available	Available		
	2	Reset of the integrated operation time Valid/Invalid (fan motor)	Not available	Available		
	3	-	-	-		
	4	-	-	-		

Note 1. Setting timing for DIPSW 1 and 3 is during unit stoppage (remote controller OFF). It is not necessary to reset the settings by power-off.

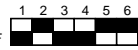
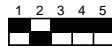
Note 2. Settings in the shaded areas are factory settings.

[SW2,SW3-2,SW4]

Model	System	Capacity code	SW3-2	SW2	SW4
P250	One-refrigerant circuit connection	50	OFF	ON OFF 	ON OFF 
P500	One-refrigerant circuit connection	100	ON	ON OFF 	ON OFF 
	Two-refrigerant circuit connection*	50	OFF	ON OFF 	ON OFF 

* The setting is changed at site under two-refrigerant circuit connection

<Capacity code and function setting>

If the capacity code or the function is set wrongly when the circuit board is replaced, reset the power of both the indoor unit and the outdoor unit.

[SW5]

Function	Operation by switch setting	Switch setting timing
Reset of the integrated operation time	Resetting the integrated operation time according to the setting of SW7-1 and 7-2	During unit stoppage (remote controller OFF) (when switching from OFF to ON)

[SW8]

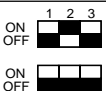
Function	Operation by switch setting	Switch setting timing
Compulsory thermo OFF setting during test run (used in the grouped indoor units connected to different outdoor units)	 Normal control Compulsory thermo OFF	Anytime after power on

(2) Slide switches

Switch	Function	Operation by switch setting	Switch setting timing						
SWC 1~2	Switching between suction/discharge temperature control	Option Standard *  <table border="1" style="display: inline-table; vertical-align: middle;"> <thead> <tr> <th></th> <th>Input setting</th> </tr> </thead> <tbody> <tr> <td>Option</td> <td>Suction temperature control</td> </tr> <tr> <td>Standard</td> <td>Discharge temperature control</td> </tr> </tbody> </table>		Input setting	Option	Suction temperature control	Standard	Discharge temperature control	Anytime after power on
	Input setting								
Option	Suction temperature control								
Standard	Discharge temperature control								

* The settings for the two circuit boards must be equivalent to switch between suction/discharge temperature control under two-refrigerant circuit system.

3. Function of the switch <Remote controller>

MA remote controller (PAR-20MAA)

The SW is located at the bottom of the remote controller under the cover. Operate the switches to perform the remote controller main/sub setting or other function settings. Normally, do not change the settings of switches other than the SW1 (main/sub switching switch). (All the switches are set to "ON" at factory setting.)

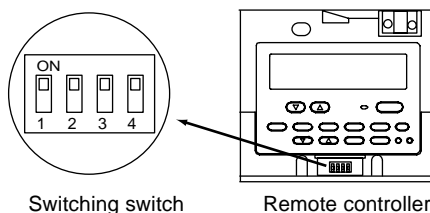

Switch	Function	ON	OFF	Operation by switch settings	Switch setting timing
1	Remote controller main/sub setting	Main	Sub	When two remote controllers are connected to one group, set either of the remote controllers to "Sub".	Before power on
2	At power on of the remote controller	Normal startup	Timer mode startup	To resume the operation with timer mode after the power is restored when the schedule timer is connected, set to "Timer mode startup".	Before power on
3	Cooling/heating display set by automatic setting	Displayed	Not displayed	When the automatic mode is set and the "Cooling"/"Heating" display is not necessary, set to "Not displayed".	Before power on
4	Suction temperature display (discharge temperature display)	Displayed	Not displayed	When the suction temperature (discharge temperature) display is not necessary, set to "Not displayed".	Before power on

[2] Controlling the Outdoor Unit

-1- Initial Control

- When the power is turned on, the initial processing of the microcomputer is given top priority.
- During the initial processing, control processing of the operation signal is suspended. The control processing is resumed after the initial processing is completed. (Initial processing involves data processing in the microcomputer and initial setting of each of the LEV opening. This process will take up to 1 minute.)
- During the initial processing, the LED monitor on the outdoor unit's main board displays S/W version -> refrigerant type -> model and capacity -> and communication address in turn every second.

-2- Control at Start-up

- The upper limit of frequency during the first 3 minutes of the operation is 50 Hz.
- When the power is turned on, normal operation will start after the initial start-up mode (to be described later) has been completed (with a restriction on the frequency).

-3- Bypass Control

Bypass solenoid valves (P250,SV1; P500,SV1,SV3), which bypass the high- and low- pressure sides, perform the following functions.

(1) Bypass solenoid valve (SV1) (ON = Open)

Operation	SV1	
	ON	OFF
At No. 1 compressor start-up or at No. 2 compressor start-up (P500 model only)	ON for 4 minutes.	
After the restoration of thermo or 3 minutes after restart	ON for 2 minutes.	
During cooling or heating operation with the compressor stopped	Always ON. Exception: OFF when HPS-LPS is 0.2 MPa or less	
After the operation has stopped	ON for 3 minutes. Exception: OFF when HPS-LPS is 0.2 MPa or less	
During defrost operation (See *1 in the figure below.)	Always ON	
During oil-recovery operation	Always OFF during cooling operation and always ON during heating operation when running an oil-recovery operation after running a continuous operation at low frequency.	
During an operation with the compressor running at 30 Hz (After 3 minutes have passed since start-up)	When low pressure (LPS) drops below 0.23 MPa.	When low pressure (LPS) exceeds 0.38 MPa.
When high pressure (Pd) rises	When Pd exceeds 3.77 MPa	When Pd is or below 3.43 MPa and 30 seconds have passed

[Example of an SV1 operation]

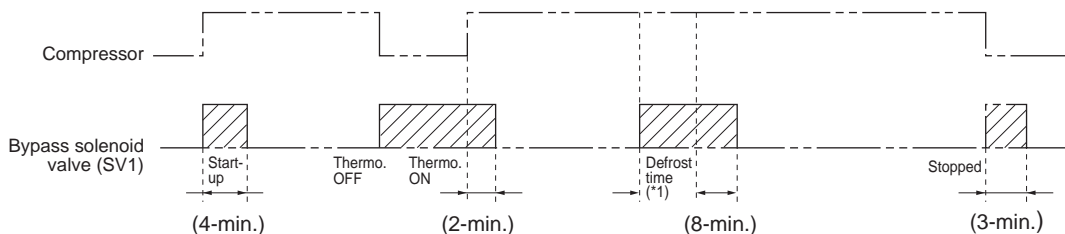

(2) Bypass valve (SV3, P500 model only) (ON = Open)

The opening of SV3 is controlled by the operating state of No.1 and No.2 compressors.

No.1 Compressor	No.2 Compressor	SV3
Stopped	Stopped	OFF
In operation	Stopped	ON
In operation	In operation	OFF

-4- Compressor Frequency Control

- Depending on the capacity required, the frequency of the compressor is controlled to bring the evaporation temperature (Te) close to the target evaporation temperature (Tem) during cooling operation, and to keep constant condensing temperature (49°C = 2.88MPa) during heating operation.
- The target evaporation temperature (Tem) varies as follows during cooling operation depending on the capacity required.
 - When lacking in capacity : Tem is lowered
 - When the capacity exceeds the needs : Tem is raised
 - Minimum and maximum Tem Valued : $-10^{\circ}\text{C} \leq \text{Tem} < 25^{\circ}\text{C}$
- For P250 model, the capacity is controlled by only the inverter-driven compressor, and for P500 model, the capacity is controlled by the compressor No.1 (inverter-driven) and No.2 (constant capacity).
- The following table shows the frequency change of the inverter compressor during normal operation.

Model	Frequency/cooling	Frequency/heating	Speed
P250 model	20-60 Hz	20-60Hz	3 Hz/second
P500 model	20-70 Hz	20-70 Hz	3 Hz/second

The maximum frequency during heating operation is affected by the outdoor air temperature to a certain extent.

- (1) No. 2 compressor operation/stop (P500 model only)
 - No.2 compressor changeover from stop to in-operation
 - When No.1 compressor does not meet the capacity requirement, No.2 compressor will start its operation.
 - No.2 compressor changeover from operation to stop
 - When an operation of both No.1 and No.2 compressors exceeds the capacity requirement, No.2 compressor will stop its operation.
- (2) Pressure limit

The maximum limit of high pressure (Pd) is set for each frequency level. If this limit is exceeded, the frequency will be reduced every 30 seconds.
- (3) Discharge temperature limit

The discharge temperature (Td) of the compressor in operation is detected, and if it exceeds the upper limit, the frequency is reduced by 5 Hz.

 - Control is performed 30 seconds after compressor start-up and every 30 seconds thereafter.
 - Operating temperature is 115°C
- (4) Periodic frequency control

Frequency control other than the ones performed at start-up, upon status change, and for protection is called periodic frequency control (convergent control) and is performed in the following manner.

[Periodic control cycle]

 - Periodic control is performed after the following time has passed
 - 60 seconds after the compressor start-up or 30 seconds after the completion of defrost operation
 - 30 seconds after frequency control based on discharge temperature or pressure limit

[The amount of frequency change]

The amount of frequency change is controlled to approximate the target value based on the evaporation temperature (Te) and condensing temperature (Tc).

-5- Defrost Operation Control

(1) Starting the defrost operation

- Defrost operation is started when the pipe temperature (TH5) of -10°C or below (-8°C or below for P500-type) has continuously been detected for 3 minutes after the integrated compressor operation time of 50 minutes have passed (90 minutes when the defrost prohibit timer is set to 90 minutes).
- If 10 minutes have passed since compressor start-up or since the completion of defrost operation, forced defrost operation will start by turning on the forced defrost switch (DIP SW2-7).
- Even if the defrost prohibit timer is set to 90 minutes, the actual defrost prohibit time for the next operation will be 50 minutes if defrosting took 15 minutes.

(2) Defrost operation

Compressor frequency	Model	No.1 Compressor	No.2 Compressor
	P250 model	53	-
	P500 model (50/60 Hz)	70/60	ON (50/60 Hz)
Outdoor unit fan	Stopped		
SV1	ON		
SV3 (P500 model only)	ON		
21S4a	OFF		
21S4b (P500 model only)	OFF		
SV4c (P500 model only)	OFF		
21S5b (P500 model only)	OFF		
21S5c (P500 model only)	OFF		
LEV1	480 pulses		

(3) Stopping the defrost operation

- Defrost operation will stop when 12 minutes have passed since the beginning of defrost operation (15 minutes when the defrost prohibit timer is set to 90 minutes), or when the piping temperature (TH5) of 10°C or above has been continuously detected for 2 minutes (TH5 above 7°C for 2 minutes for P500 model and above).
- Defrost operation will not stop its operation for 2 minutes once started unless the piping temperature exceeds 25°C within 2 minutes, in which case the operation will stop (Above 20°C within 2 minutes for P500 model and above).

(4) Problems during defrost operation

- If a problem is detected during defrost operation, the operation will be stopped, and the defrost prohibition time based on the integrated compressor operation time will be set to 20 minutes.

-6- Refrigerant Recovery Control

Recovery of refrigerant is performed during heating operation to prevent the refrigerant from accumulating inside the unit while it is stopped (unit in fan mode), or inside the indoor unit that is in cooling mode or in heating mode with thermo off. It is also performed during cooling operation to prevent an excessive amount of refrigerant from accumulating in the outdoor heat exchanger.

(1) During heating operation

[Starting refrigerant recovery mode]

The refrigerant recovery mode in heating starts when all of the following three conditions are met:

- 30 minutes have passed since the completion of previous refrigerant recovery.
- $T_d > 105^{\circ}\text{C}$ for 3 minutes
- Frequencies below 50 Hz

[Refrigerant recovery]

- 1) Refrigerant is recovered with the LEV on the applicable indoor unit (unit under stopping mode, fan mode, cooling, heating with thermo off) being opened for 15 seconds.

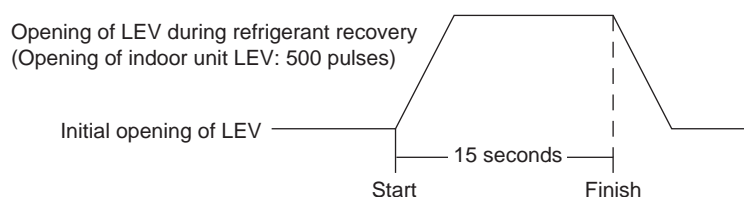

- 2) Periodic capacity control of the outdoor units and periodic LEV control of the indoor units will be suspended during refrigerant recovery operation; they will be performed after the recovery has been completed.
- 3) Defrost operation will be suspended until refrigerant recovery has been completed.

(2) During cooling operation

[Starting refrigerant recovery mode]

The refrigerant recovery mode starts when all the following conditions are met

- 30 minutes have passed since the completion of previous refrigerant recovery.
- When the unit keeps running for 3 minutes in a row or more with high discharge temperature
- $T_d > 105^{\circ}\text{C}$ or
- $P_d > 3.43 \text{ MPa}$ ($35 \text{ kg/cm}^2\text{G}$) and $SC0 > 10 \text{ deg}^{\circ}\text{C}$

[Refrigerant recovery]

Increase the opening of LEV1 (Periodic control begins when 30 seconds have elapsed).

-7- Capacity Control of Outdoor Fan and Heat Exchanger

(1) Control method

- ♦The outdoor fan air flow rate is controlled to keep constant evaporation temperature during cooling operation and to keep constant condensing temperature during heating operation.
- ♦The capacity of the heat exchanger on the P500 model of outdoors is controlled by the 4-way valve (21S4b) or the solenoid valve (SV5b).

(2) Control

- ♦Outdoor unit fan stops while the compressor is stopped (except in the presence of input from snow sensor).
- ♦The fan operates at full speed for 5 seconds after start-up.
- ♦The outdoor unit fan stops during defrost operation.

(3) Capacity control of outdoor heat exchanger

[P500 model]

Operation mode	Heatexchanger capacity	Number of fans	Inverter control	Notes
Cooling	50%	1	5-100%	21S4b ON, 21S4c OFF SV5b ON, SV5c OFF
	100%	2	10-100%	21S4b OFF, 21S4c OFF SV5b OFF, SV5c OFF
Heating	100%	2	10-100%	21S4b ON,21S4 ON SV5b OFF, SV5c OFF
Defrost	100%	0	0%	21S4b OFF, 21S4c OFF SV5b OFF, SV5c OFF

Notes:

- ♦The unit runs a cooling cycle when 21S4b and 21S4c are not powered and runs a heating cycle when it is powered.
- ♦SV5b and SV5c are open when it is not powered and is closed when it is powered.
- ♦While the unit is stopped, 21S4b and 21S4c are not powered cooling cycle, and SV5b and SV5c are open.

-8- Subcool Coil Control (Linear Expansion Valve <LEV1>)

- ♦The amount of super heat is controlled and kept constant based on the bypass outlet temperature (TH8) of subcool coil every 30 seconds.
- ♦The degree of opening is controlled based on the subcool coil outlet/inlet temperature (TH5, TH7), high pressure (Pd), and discharge temperature. The LEV will be closed (0) during heating operation and when the compressor is stopped, and it will be open during cooling operation with Thermo off.
- ♦The LEV stays open at 480 during defrost operation.

-9- Control at Initial Start-up

•When the unit is started for the first time, it will run the following course of operation.

(1) Flow chart of initial operation mode

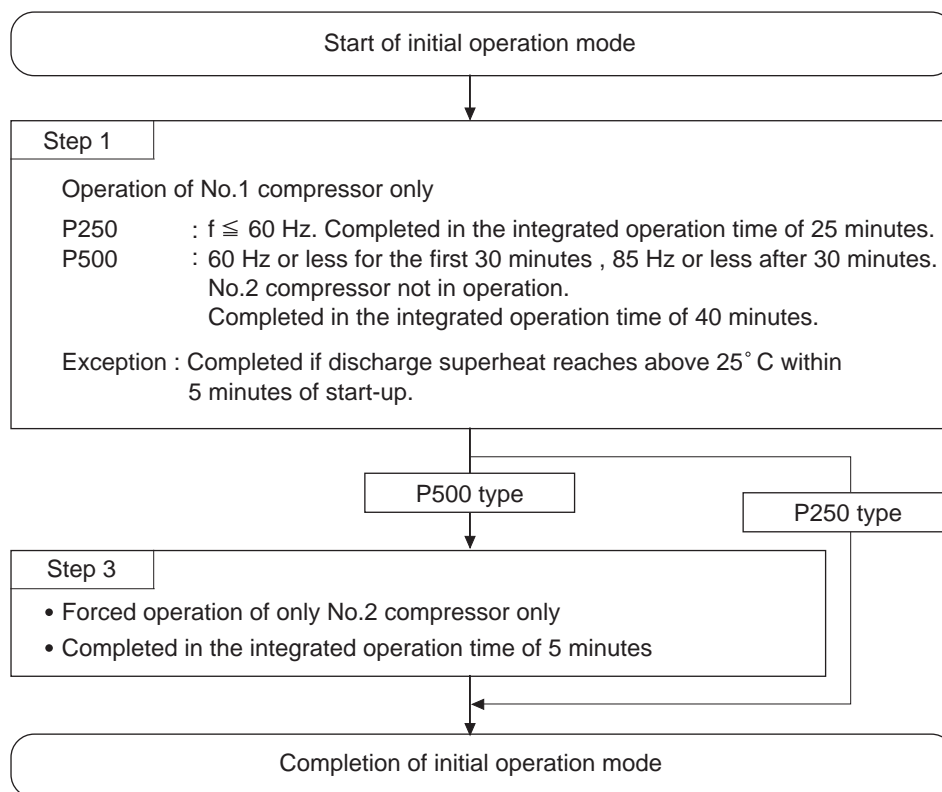

(2) Initial start-up control of P500 model: time chart Example

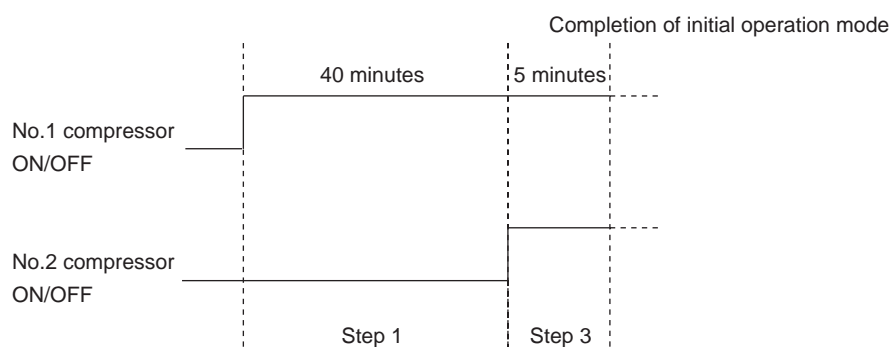

(3) Caution for Test Run

In the first test run after the power-on, a compressor operates for start-up confirmation. It's not a failure even if the compressor alternate between start and stop. This operation will be finished in 70 minutes maximum. The flag 7 of the service LED lights during this operation by setting the self-diagnosis switch (SW1) as below.

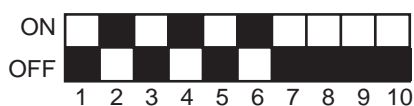

-10- Emergency Operation Mode

When compressors (No.1 or No.2) fails, the unit goes into the emergency operation mode to respond to the problem. The unit can be put into this mode by performing an error reset on the remote controller.

(1) Starting the emergency operation

- 1) When an error occurs, the error source and the error code will be displayed on the display on the remote controller.
- 2) When the error type displayed in 1 above allows the unit to run the emergency operation (as shown in the table below), the retry operation will start automatically.

Pattern of emergency operation mode	Error source	Type of error that allows the unit to go into the emergency operation	Type of error that does not allow the unit to go into the emergency operation	Operation
At malfunction of No.1 (INV)	Outdoor unit	Heatsink thermistor 4230 <Inverter error>	All errors other than the ones listed on the left	Emergency operation with only No.2 compressor
		Overcurrent break 4250		
Overload protection 4240				
Heatsink overheat protection 4230				
Cooling fan abnormality 4260				
Bus voltage drop protection 4220				
IDC sensor/circuit error 5301				
VDC sensor/circuit error 4200				
THHS sensor/circuit error 5110				
IPM communication error 0403				
At malfunction of No.2		Overcurrent protection 4108		Emergency operation with only No.1 compressor
Thermistor error		TH5 5105		
		TH7 5107		
		TH8 5108		

(2) Ending the emergency operation

1) End conditions

When one of the following conditions is met, emergency operation will end.

- ♦When an error is reset
- *When resetting an error with the remote controller or the external input
- ♦When an error is detected that does not allow the unit to run the emergency operation.

(3) Miscellaneous

1) End conditions

- ♦When encountering problems other than the ones listed above, the system makes an error stop without performing emergency operation. (Only the indoor fan operates unless problems are found with the fan.)
- ♦When problems are found in only one of the two units of a 2-refrigerant circuit, only the unit with the problems will run an emergency operation or stop its operation, and the other unit will keep running its operation.
- ♦Emergency operation is intended only as a first aid until the unit is serviced. Have the unit serviced without delay to restore a normal operation.

-11- Capacity Control between Outdoor Units (when two refrigerant circuits are connected)

The following two capacity control methods between indoor units are available.

- Control to make only one of the outdoor units (which has the smaller address) operate and keep running during low-load hours at startup.
- Control to make one of the outdoor units stop, and the other outdoor unit operate when the load becomes low during normal operation. After a certain period of time has passed since only one of the outdoor units started operation, the unit in operation stops, and the other outdoor unit starts operation automatically.

(1) Starting Conditions

- When it is determined that the load is less than 50%, using suction temperature as a reference.
- Operation frequencies of both indoor and outdoor units remain near the minimum level three minutes after start-up.

(2) Stopping Conditions

- When operation frequency of the running unit rises up near the maximum capacity.
- When it is determined that the load is over 50%, using suction temperature as a reference.
- When compressor stops while running only one unit.

-12- Dehumidification priority control

The dehumidification priority control is the control to increase the amount of dehumidification by increasing the frequency of the compressor when the external signal (dehumidification command) is received during cooling operation.

During dehumidification priority control, the room temperature may drop below the preset temperature set during normal operation.

Under this control, the set temperature will be compulsory at the minimum value.

(Under discharge temperature control:14°C Under suction temperature control:19°C)

The temperature nor the humidity can be controlled simultaneously as the reheat function is not available.

-13- Operation Mode

(1) Indoor unit operation mode

The operation mode can be selected from the following 4 modes using the remote controller.

1	Cooling mode
2	Heating mode
3	Fan mode
4	Stopping mode

(2) Outdoor unit operation mode

1	Cooling mode	All indoor units in operation are in cooling mode.
2	Heating mode	All indoor units in operation are in heating mode.
3	Stopping mode	All indoor units are in fan mode or stopping mode.

Note:

The heating mode can be used for standby of the indoor unit when the outdoor temperature is low. Confirm that the devices to be cooled are not influenced by the heat.

The discharge temperature control cannot be used.

The discharge temperature is controlled not to drop less or equal 30°C. It may take time to reach the indoor target temperature.

When the indoor temperature reaches the cooling operation range, switch the operation from heating to cooling.

[3] Controlling the Indoor Unit

<Indoor unit control>

There are two controller circuit boards with two refrigerant circuits inside the indoor unit of 20 HP.

There is one controller circuit board with one refrigerant circuit. Each refrigerant circuit is controlled independently (in case of one refrigerant circuit, one-to-one control of indoor unit and outdoor unit) in the following method.

When only the controller circuit board No. 1 with one refrigerant circuit is equipped inside the indoor unit of 20 HP, the following control is performed.

-1- Thermostat Functions

(1) Thermostat Functions and Function Selection

- Two control methods are available; suction temperature control and discharge temperature control.
 - The suction/discharge temperature control can be switched by the switches (SWC) on the controller circuit board inside the controller of the indoor unit.
 - The discharge temperature control is selected (SWC is set to "Standard") at factory shipment.
 - To switch the control, set SWC on two controller circuit boards inside the controller as follows.
 - To perform suction temperature control: Set SWC to "Option".
 - To perform discharge temperature control: Set SWC to "Standard".
 - The SWC settings made on two controller circuit boards must be equivalent. <20HP only>
- *Only the suction temperature control is performed in the heating mode regardless of the SWC settings.

(2) Thermostat Reading

A. Discharge temperature control (SWC is set to "Standard".)

(a) Thermo ON Condition

- Three minutes have past since thermo OFF AND
- TH24 - Target Temperature >1°C AND
- TH21 is higher than when thermo is OFF.
 - TH24: Discharge thermistor
 - TH21: Suction thermistor

(b) Thermo OFF Condition

- < When Dipsw5-4 on the outdoor unit is ON >
 - 30 minutes have past since thermo ON AND
 - TH24 -Target Temperature < -1°C has been detected for 10 minutes
 - OR TH24 - Target Temperature < -5°C was detected
- < When Dipsw5-4 on the outdoor unit is OFF >
 - Two minutes have past since thermo ON
 - TH24 - Target Temperature < -1°C has been detected for 5 minute. AND F=Fmin

B. Suction Temperature Control (SWC is set to "Option".)

(a) Thermo ON Condition

- Three minutes have past since thermo OFF AND
- TH21 - Target Temperature > 1°C

(b) Thermo OFF Condition

- < When Dipsw5-4 on the outdoor unit is ON >
 - Thirty minutes have past since thermo ON AND
 - TH21 - Target Temperature < -1°C has been detected for 10 minutes
 - OR TH21 - Target Temperature < -5°C was detected.
- < When Dipsw5-4 on the outdoor unit is OFF >
 - Two minutes have past since thermo ON AND
 - TH21 - Target Temperature < -1°C has been detected for 5 minute. AND F=Fmin

-2- Actuator Control

(1) LEV Control

- The degree of LEV opening is set to the initial degree depending on the condensing pressure at start-up.
- After the start-up, the degree of LEV opening is controlled every minute so that the superheat detected by the thermistors TH22 (liquid pipe) and TH23 (gas pipe) of the indoor unit can be within a certain range.
- Depending on the operating condition of the outdoor unit, a control other than the superheat control described above may be performed.
- When suction or discharge temperature nears the target temperature, superheat control value rises and LEV opening narrows.
- The degree of LEV full opening/closing is 41 pulses.

(2) Fan Control

Whether the thermostat is ON or OFF, the fan stays ON except during operation stoppage.

Exception: Fan stops when problem with the fan is detected (Error Code 4109).

* Fan problems may be experienced in the following situations: Surge breaker trip (51F) or malfunctions of sub relays (Z1,Z2, or Z3.)

(3) Float Switch Control

The unit makes an error stop when the contact point (B contact) of the float switch loses its contact (i.e. loosened floated parts, disconnected wire, unfastened connector etc.) for more than 1 minute or longer.

(4) Indicator Lamp

Indicator lamps on the front side of the unit indicate the operation status of the indoor unit.

Power Supply Lamp (White) : Lit upon power ON. Extinguished upon power OFF.

Operation Lamp (Green) : Lit during operation. Extinguished during stoppage.

Error Lamp (Red) : Lit when errors are detected in each refrigerant circuit. Extinguished during normal operation or after error reset.

Inspection lamp (orange) : Lit when the inspection switch of the indoor unit is ON (during inspection). Extinguished when the switch is OFF (during normal operation).

-3- Temperature Setting Range

The temperature range can be set between 19°C (14°C) and 30°C using the remote controller when the suction temperature control (or the discharge temperature control) is performed.

* Depending on the operating conditions, target temperature and actual discharge/suction temperatures may not match. For example, even if the target discharge temperature is set at 14°C, if the load exceeds the capability of the unit, the actual temperature will not reach 14°C.

-4- Emergency Operation Mode

The emergency operation is an operation that operates the unit temporarily depending on the error types described later. The emergency operation is run automatically when the following errors are detected.

(1) Starting an Emergency Operation

- When the following problems are detected, the system runs an emergency operation, displaying error codes.
- During this operation, near normal operation is run, ignoring the following abnormal operation data. (Some of the actuator will run at a fixed state during this time.)

Chart: Types of errors in which emergency operation can be run

	Types of Errors		Error codes
	TH21	Open/Short Detection	
Thermistor Error	TH22		5101
	TH23		5102
	TH24		5103
			5104

(2) Stopping the Emergency Operation

Emergency operation mode is stopped in the following situations:

- When abnormal mode is reset
 - * How to reset an abnormal mode
- When the operation is stopped by the remote controller or by the external input
- A different type of error is detected during emergency operation
 - * i.e. when TH22 error is detected during emergency operation caused by TH21 error
- When emergency operation disabled error is detected

(3) Miscellaneous

- When the errors other than described in the chart, the unit makes an error stop without performing emergency operation. (Only the indoor fan operates, however; it stops when the fan is in trouble.)
- When one of the two refrigerant circuits, the outdoor unit with the refrigerant circuit in error performs emergency operation or makes an error stop, while the other outdoor unit keeps normal operation.
- Emergency operation is intended only as a first aid until the unit is serviced. Have the unit serviced without delay to restore a normal operation.

-5- Twenty-second restart-suspension mode

The unit will be in a twenty-second restart-suspension mode (same operation as Thermo OFF) in any of the following situations.

- When the demand for outdoor unit changes from Thermo ON to Thermo OFF.
- When operation mode changes from normal to emergency mode.
- When anti-freeze mode is completed.
- * The outdoor unit has also a twenty-second restart-suspension mode, and it works separately from the indoor unit.
- * In heating mode, the mode changes to three-minute restart-prevention mode.

-6- Anti-Freeze Control (In cooling mode)

(1) Starting Conditions

This operation will start when all of the following conditions are met:

- Thermo ON status has been detected for 16 minutes.
- TH22 (liquid pipe temp. Thermistor) $< 1^{\circ}\text{C}$ has been detected for 20 minutes.

(2) Control Operation

The unit will be in the same condition as Thermo OFF condition for six minutes. When the following conditions are met, the unit will be in a 20-second restart-suspension mode.

(3) Stopping Conditions

When either of the following conditions is met:

- $\text{TH22} \geq 10^{\circ}\text{C}$
- Six minutes have elapsed since the beginning of this operation.

-7- Switching Between Pulse and Level of MA Remote Controller External Input

The start/stop operation can be performed by either of the MA remote controller or the external input (pulse/level).

DIPSW on the address circuit board (No.1 and No. 2)		Valid operation
SW1-10 = OFF	SW1-9 = OFF	External input (level)
	SW1-9 = ON	External input (pulse)
SW1-10 = ON		MA remote controller

- * The manipulator for centralized control can be operated regardless of the SW1-9 status (ON), and SW1-10 status (OFF).
- * For the MA remote controller and the external input, the operation command sent later has no priority.
- * When the Normal/Inspection switch on the main unit is set to "Inspection", the external input will be disabled. Only the operation performed by the MA remote controller is valid.

Input

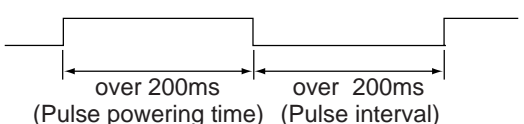
Function	Usage	Signal specifications
Start/Stop	Sending ON/OFF command to the indoor unit	Pulse (With-voltage/No-voltage a-contact) * <In case of with-voltage> Power supply:12~24V DC Electrical current:10mA (12V DC) <Pulse specification> 

- * Use a contact point for small electrical current (12V DC 1mA).

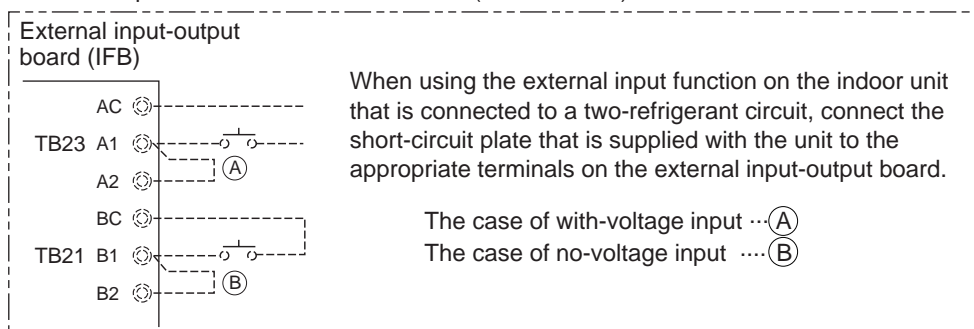

-8- Operation during Electrical Power Failure

After the controller in this air conditioning unit receives signals indicating power failure or an instantaneous drop in voltage, unless the unit receives a command not to restart, it will resume its operation after power supply is restored.

Depending on the duration of power outage, the following operations will be run.

Duration of Power Outage	Unit Operation
Shorter than 6msec	Both indoor and outdoor units will stay on.
Longer than 6msec and Shorter than 50msec (Note1, Note2)	It is recognized by the unit as an instantaneous power outage Indoor Unit: The fan stays on. Outdoor Unit: Compressor stops, then resumes its operation 20 seconds later.
Longer than 50msec (Note1, Note2)	It is recognized by the unit as power outage. Air-conditioning unit will stop (incl. fan and compressor). It will resume operation after the power has been restored. * The unit operation is resumed after 20 seconds plus "half of the indoor unit address" seconds (40 seconds at maximum) have passed since the power has been restored.

Note 1: When indoor unit is in the maintenance mode, it will not resume operation even after the power has been restored.

Note 2: After the unit resumes its operation, MA remote controller will display 'HO' for fifteen seconds, **during which time the MA remote controller will not respond. To turn off the unit during this time, turn off the power with an electric leak breaker.**

[4] Operation Flow Chart

1. Mode determination flowchart
 (1) Indoor unit (cooling, heating, fan mode)
 [Standard]

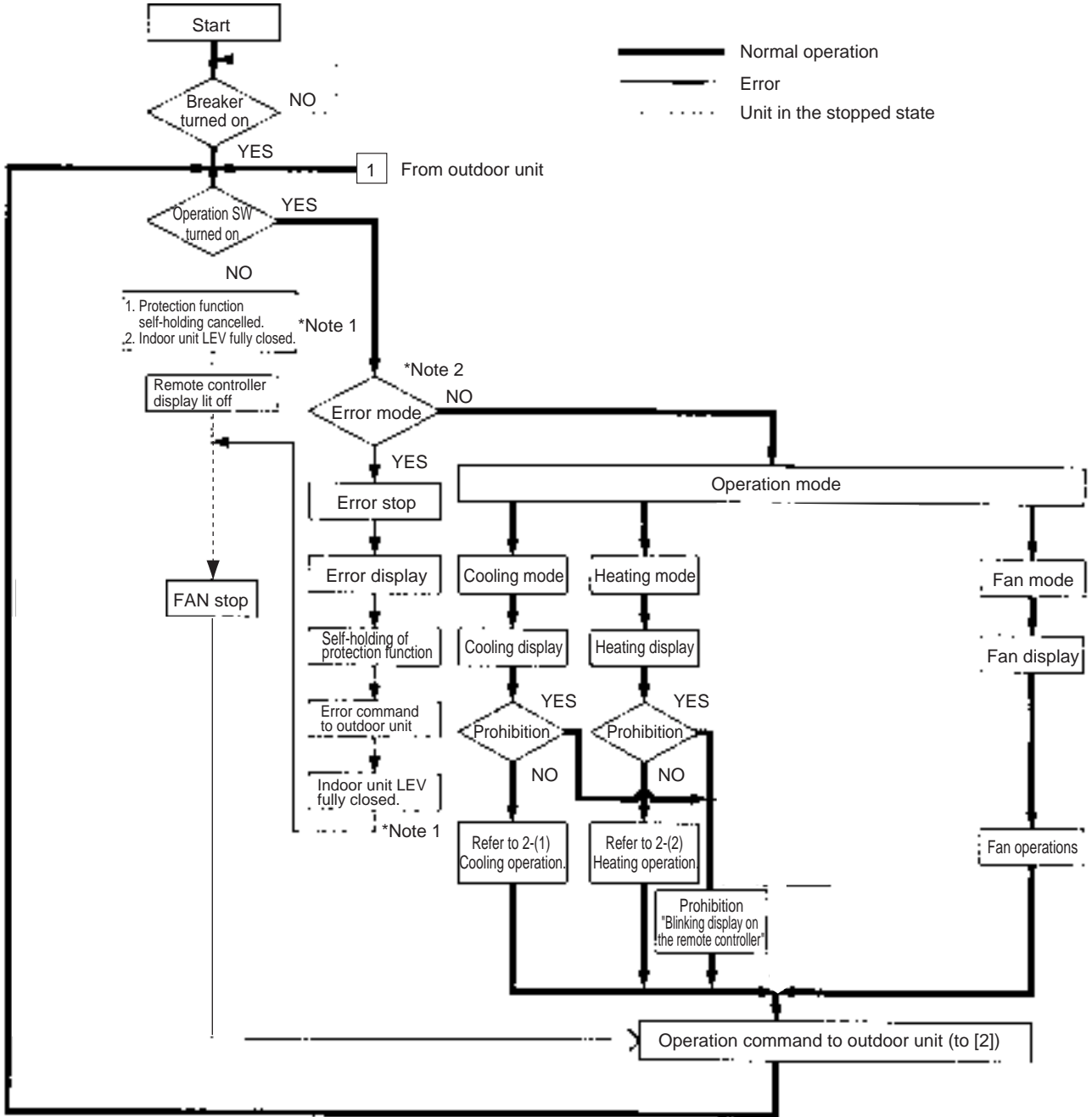

*Note 1. Indoor unit LEV fully closed : Opening 41.

*Note 2. The system may go into the error mode on either the indoor unit or the outdoor unit side. If some of the indoor units are experiencing a problem (except water leakage), only those indoor units that are experiencing the problems will stop. If the outdoor unit is experiencing a problem, all connected indoor units will stop.

(2) Outdoor unit (cooling and heating modes)

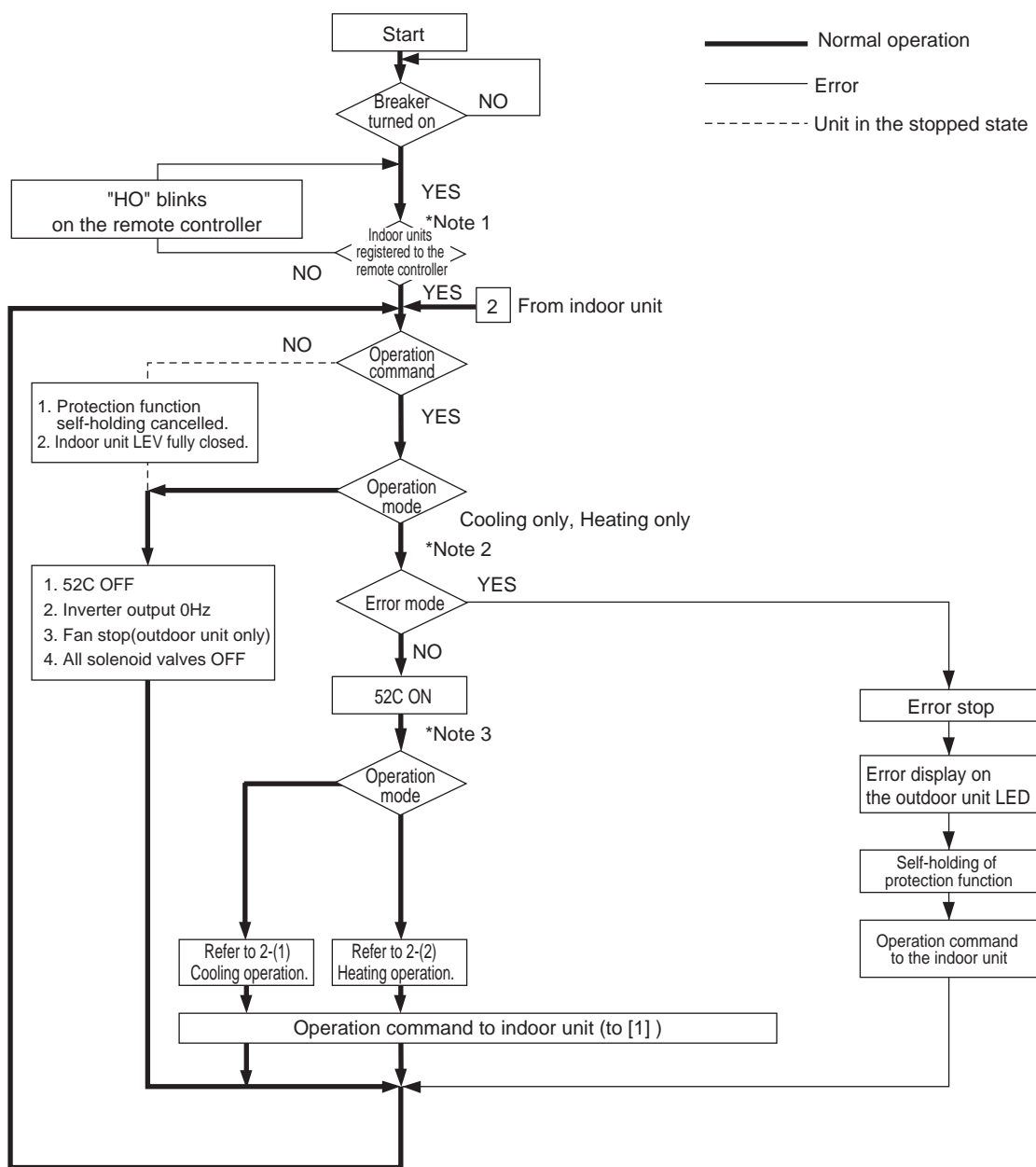

*Note 1. For about 1 minutes after power on, search for the indoor unit address, for the remote controller address, and for the group information will start. During this, "HO" blinks on the display of the remote controller.

*Note 2. The error mode includes that of indoor units and outdoor units. When the unit goes into the error mode, both the indoor and the outdoor units make an error stop. (The units do not stop during the emergency operation.)

*Note 3. The units will follow the operation mode commands from the indoor unit.

2. Operations in each mode
 (1) Cooling operation

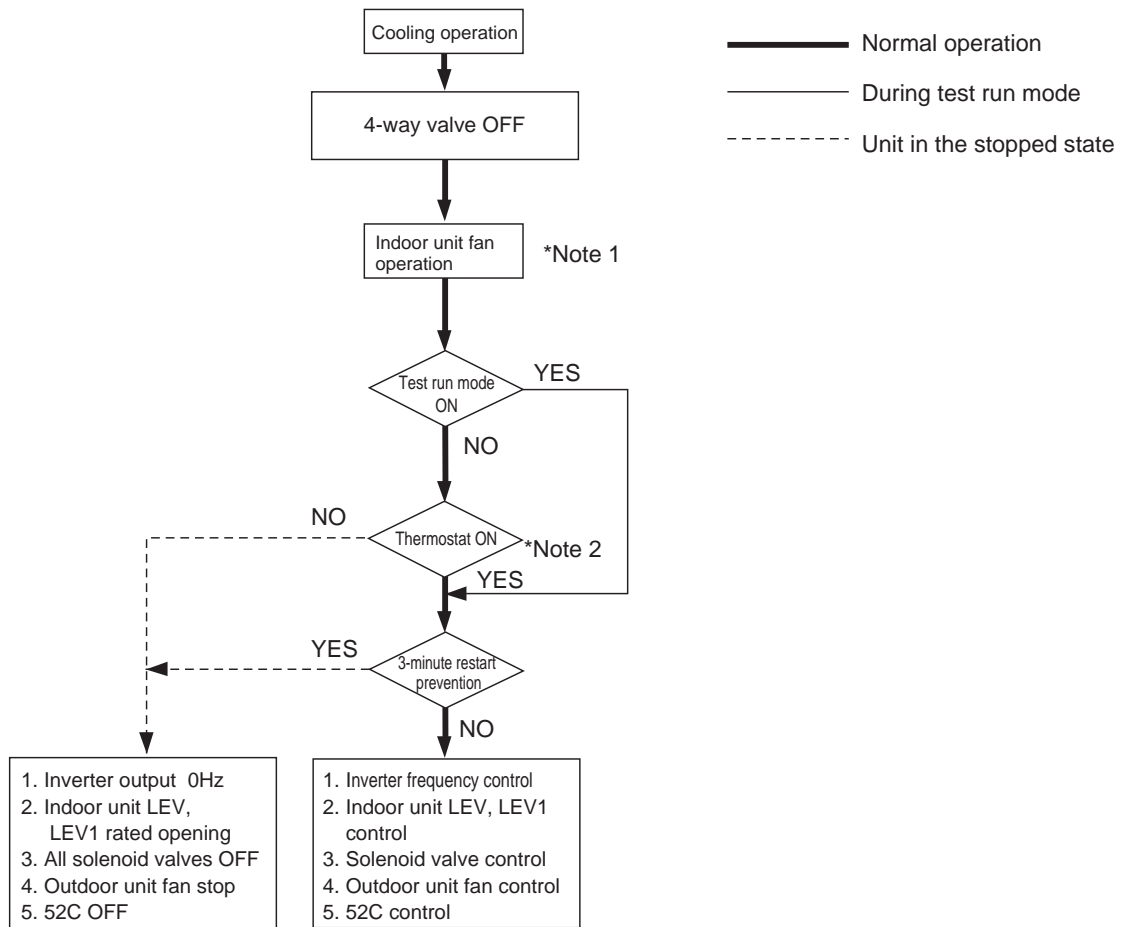

*Note 1. The indoor fan operates in the cooling mode regardless of the ON/OFF state of the thermostat.

*Note 2. The following two methods are available to perform the test run.

- 1) Using DipSW3-1 and 3-2 on the outdoor unit
- 2) Using MA remote controller

(2) Heating operation (For warming up the indoor unit)

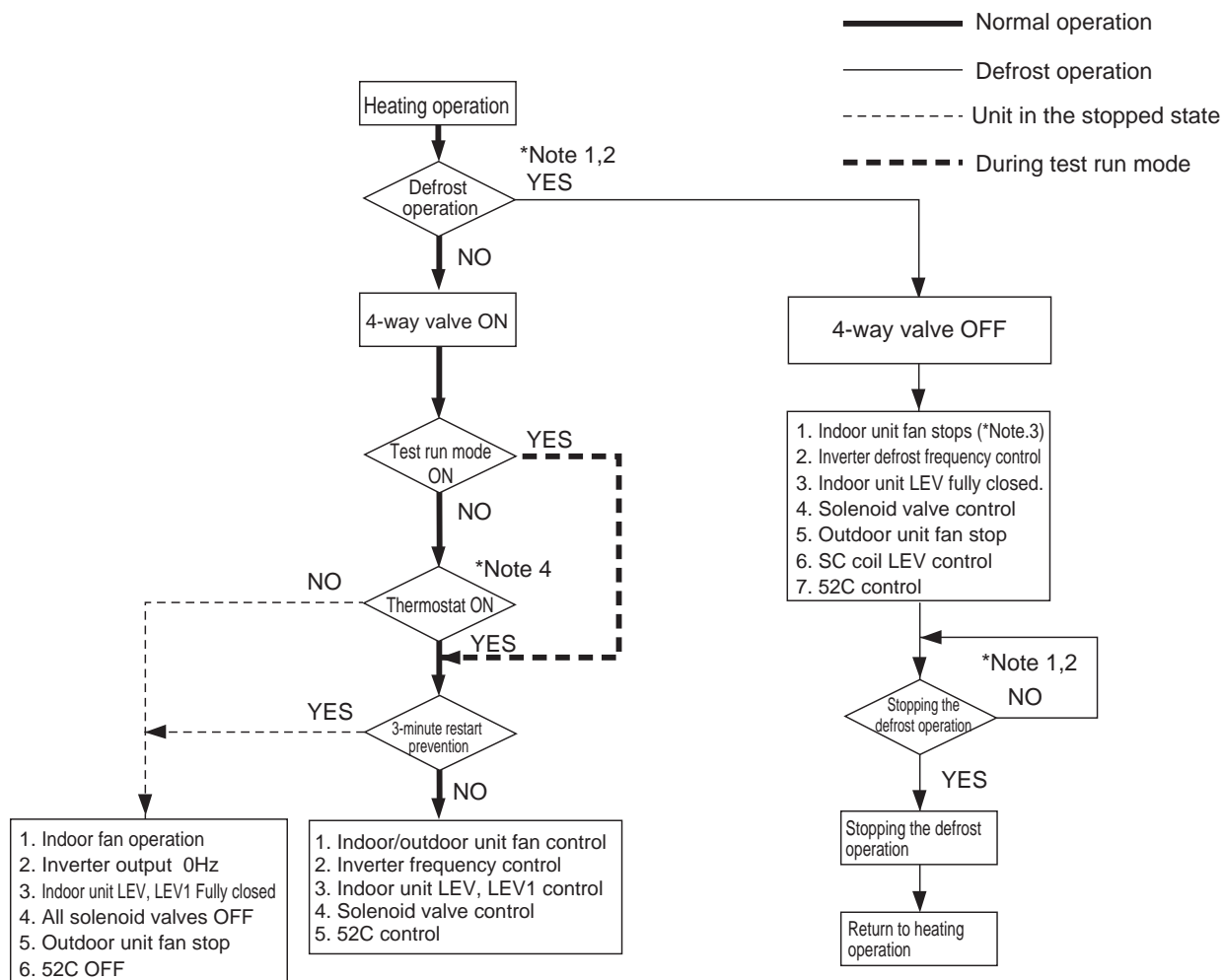

*Note 1. When outdoor unit starts defrosting, it transmits defrost operations command to indoor unit, and the indoor unit starts defrosting operations. Similarly when defrosting operation stops, indoor unit returns to heating operation after receiving defrost end command of outdoor unit.

*Note 2. Defrost end condition: 10 or more minutes must pass after defrost operation.

or

Outdoor unit piping temperature: refer to "-5-. Defrost operation control" of [2] Controlling the Outdoor Unit.

*Note 3. Refer to "-5-. Defrost operation control" of [2] Controlling the Outdoor Unit for indoor fan control.

*Note 4. The discharge temperature is controlled to keep approx. 30°C or below in heating mode.

VIII Test Run Mode

[1] Items to be checked before a Test Run.....	99
[2] Test Run Method	100
[3] Operating Characteristic and Refrigerant Amount.....	101
[4] Adjusting the Refrigerant Amount.....	102
[5] Refrigerant Amount Adjust Mode.....	104
[6] The following symptoms are normal.	106
[7] Standard Operation Data (Reference Data)	107

[1] Items to be checked before a Test Run





1	Check for refrigerant leak and loose cables and connectors.
2	<p>Measure the insulation resistance between the power supply terminal block and the ground with a 500V megger and make sure it reads at least 1.0Mohm.</p> <p>Caution:</p> <p>(1) Do not operate the unit if the insulation resistance is below 1.0Mohm.</p> <p>(2) Do not apply megger voltage to the terminal block for transmission line. Doing so will damage the controller board.</p> <p>(3) The insulation resistance between the power supply terminal block and the ground could go down to close to 1Mohm immediately after installation or when the power is kept off for an extended period of time because of the accumulation of refrigerant in the compressor.</p> <p>(4) If insulation resistance reads at least 1Mohm, by turning on the main power and powering the crankcase heater for at least 12 hours, the refrigerant in the compressor will evaporate and the insulation resistance will go up.</p> <p>(5) Do not measure the insulation resistance of the terminal block for transmission line for the unit remote controller.</p>
3	<p>Make sure that the stop valve on the gas pipe, liquid pipe, and oil balance pipe are fully open.</p> <p>Caution: Securely tighten the cap.</p>
4	<p>Check the phase sequence and the voltage of the 3-phase power supply.</p> <p>Caution: If an open phase or a reverse phase is detected, it will be treated as an abnormal stop during test run (4103 error).</p>
5	<p>[When the power supply extension unit for transmission line is connected]</p> <p>Turn on the power of the power supply extension unit for transmission line before turning on the power of the outdoor unit.</p> <p>Caution:</p> <p>(1) When the power of the outdoor unit is turned on first, the system connection information may not be recognized correctly.</p> <p>(2) When the power of the outdoor unit is turned on first, turn on the power of the power supply extension unit for transmission line first, and reset the power of the outdoor unit.</p>
6	<p>Turn on the main power to the unit at least 12 hours before test run to power the crankcase heater.</p> <p>Caution: Insufficient powering time may result in compressor damage.</p>
7	To connect the power supply unit to the transmission line for centralized control, perform test run with the power supply unit turned on. Leave the male connector on the power supply switch connector (CN41) of the outdoor unit as it is.
8	<p>Be sure to confirm that the software version of the outdoor unit to be connected to the PFD-type indoor unit is "17.XX".</p> <p>Caution: If the version is different, normal operation cannot be performed.</p>

[2] Test Run Method

Procedures	
Turn on the main power. → It will take approximately one minute until the unit is operable. Leave the unit on for 12 hours (to power the outdoor unit compressor crankcase heater).	
Run an individual test on each of the refrigerant circuit to make sure that pipes or wires are not cross-connected.	
1	First, run a test on No.1-side refrigerant circuit.
2	Set the Normal/Maintenance Switch of the indoor unit to Maintenance.
3	While the unit is stopped, set the SW8-2 on the circuit board on No.2 side to "OFF". (See Note 1.)
4	Run a test , using the remote controller for the indoor unit. → Indoor fan will start, and outdoor unit of only No.1 refrigerant circuit will start operating. During this time, the outdoor unit on No.2-side refrigerant circuit will remain at a halt. → Confirm that indoor fan and outdoor unit in the No.1-side refrigerant circuit operate normally. → Confirm that pipes or wires are connected correctly.
5	Stop the operation with the remote controller for the indoor unit. → End of No.1 refrigerant circuit test run.
6	Run a test on No.2-side refrigerant circuit.
7	While the unit is stopped, set the SW8-2 on the circuit board on No.1 side to "OFF", and set the SW8-2 on the circuit board on No.2 side to "ON".
8	Run a test by using the remote controller in the indoor unit. → Indoor fan will start, and only the outdoor unit in No.2-side refrigerant circuit will start. During this time, the outdoor unit in No.1-side refrigerant circuit is stopped. → Confirm that indoor fan and outdoor unit of No.2-side refrigerant circuit are operating normally. → Confirm that pipes and wires are connected correctly.
9	Stop the test, using the remote controller for the indoor unit. → End of No.2 refrigerant circuit test run.
10	While the unit is stopped, set the SW8-2 on the circuit board on No.1 side to "ON".
11	Finally, run simultaneous tests in both No.1- and No.2-side refrigerant circuit.
12	Perform test run with the remote controller for the indoor unit. → Indoor fan will start, and outdoor units in both No.1- and No.2-side refrigerant circuit will start. → Confirm that indoor fan and both outdoor units operate normally.
13	Stop the test, using the remote controller in the indoor unit → End of test
14	Switch the Normal/Maintenance switch inside indoor unit back to Normal. → After the test run is completed, set the Normal/Maintenance switch to "Normal", and confirm that the SW8 on the circuit boards on both No.1 and No.2 sides is set as shown below (factory setting).

Note 1 When two refrigerant circuits are connected, both refrigerant circuits start running when the operation is started with the remote controller without setting the SW8 on the indoor unit as shown on the right.

To enable each refrigerant circuit to operate individually, the setting of the SW8 shown on the right is required.

SW8	Unit operation	Remarks
ON  OFF 	Performs test run when the test run command is received	Factory setting
ON  OFF 	Remains a halt even if the test run command is received	

Unit operation when SW8 on the circuit board inside the indoor unit is operated

Note 2 The error code is displayed on the remote controller when the error lamp is lit on the indoor unit during test run. Refer to the next page or later for details of error codes.

Note 3 Set the Dip SW5-4 to "ON" on the outdoor unit if the test run cannot be kept due to low load. After the test run is completed, set the Dip SW5-4 to "OFF". **(The SW must be switched while the unit is stopped.)**

Note 4 When one refrigerant circuit is connected, the procedures 3 and 6-13 in the chart above are not required.

Note 5 When the test run is performed for the first time after the power is turned on, the standby operation of the compressor is performed. The compressor may run and stop repeatedly. This is not a malfunction. This operation lasts for 70 minutes at maximum.

[3] Operating Characteristic and Refrigerant Amount

It is important to have a clear understanding of the characteristics of refrigerant and the operating characteristics of air conditioners before attempting to adjust the refrigerant amount in a given system.

1. Operating characteristic and refrigerant amount

The following table shows items of particular importance.

1	During cooling operation, the amount of refrigerant in the accumulator is the smallest when all indoor units are in operation.	
2	During heating operation, the amount of refrigerant in the accumulator is the largest when all indoor units are in operation.	
3	General tendency of discharge temperature	Discharge temperature tends to rise when the system is short on refrigerant.
		Changing the amount of refrigerant in the system while there is refrigerant in the accumulator has little effect on the discharge temperature.
		The higher the pressure, the more likely it is for the discharge temperature to rise.
		The lower the pressure, the more likely it is for the discharge temperature to rise.
4	<p>When the amount of refrigerant in the system is adequate, the compressor shell temperature is 10 to 60K higher than the low pressure saturation temperature (T_e).</p> <p>-> If the temperature difference between the compressor shell temperature and low pressure saturation temperature (T_e) is smaller than 5K, an overcharging of refrigerant is suspected.</p>	

[4] Adjusting the Refrigerant Amount

1. Symptoms

Overcharging or undercharging of refrigerant can cause the following symptoms :

Before attempting to adjust the amount of refrigerant in the system, thoroughly check the operating conditions of the system. Then, adjust the refrigerant amount by running the unit in the refrigerant amount adjust mode.

1	The system comes to an abnormal stop, displaying 1500 (overcharged refrigerant) on the controller.	Overcharged refrigerant
2	The operating frequency does not reach the set frequency, and there is a problem with performance.	Insufficient refrigerant amount
3	The system comes to an abnormal stop, displaying 1102 (abnormal discharge temperature) on the controller.	

2. Amount of refrigerant

(1) To be checked during operation

Operate all indoor units in either cooling-only or heating-only mode, and check such items as discharge temperature, sub-cooling, low pressure, suction temperature, and shell bottom temperature to estimate the amount of refrigerant in the system.

Symptoms		Conclusion
1	Discharge temperature is high. (Normal discharge temperature is below 95°C.)	Slightly undercharged refrigerant
2	Low pressure is unusually low.	
3	Suction superheat is large. (Normal suction superheat is less than 20K.)	
4	Compressor shell bottom temperature is high. (The difference between the compressor shell bottom temperature and low pressure saturation temperature (Te) is greater than 60K.)	
5	Discharge superheat is small. (Normal discharge superheat is greater than 10K.)	Slightly overcharged refrigerant
6	Compressor shell bottom temperature is low. (The difference between the compressor shell bottom temperature and low pressure saturation temperature (Te) is less than 5K.)	

3. Amount of refrigerant to be added

The amount of refrigerant that is shown in the table below is factory-charged to the outdoor units. The amount necessary for extended pipe (field piping) is not included and must be added on site.

Outdoor unit model	P250	P500
Amount of pre-charged refrigerant in the outdoor unit (kg)	9.5	22.0

(1) Calculation formula

The amount of refrigerant to be added depends on the size and the length of field piping. (unit in m)

$$\text{Amount of added refrigerant (kg)} = A \times L + \alpha$$

The value of "A" is

L_1 :0.2 when the length of liquid pipe is : ϕ 15.88

L_2 :0.12 when the length of liquid pipe is : ϕ 12.7

L_3 :0.06 when the length of liquid pipe is : ϕ 9.52

L_4 :0.024 when the length of liquid pipe is : ϕ 6.35

L : Length of liquid pipe

α : For indoor units Refer to the table below.

Total capacity of connected indoor units	For indoor units (kg)
P250 model	2.0
P500 model *	4.0

* For P500 model, the value will be 2.0kg x 2 when two refrigerant circuits are connected.

* Round up the calculation result to the nearest 0.01kg. (Example: 18.54kg to 18.6kg)

(2) Sample: Outdoor PUHY-P500YGM-A, Indoor PFD-P500VM-E

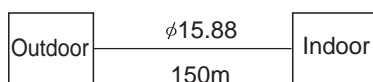

When the liquid pipe size is ϕ 15.88, and the pipe length is 150m,

According to the above formula

$$\text{Amount of refrigerant to be charged (kg)} = 0.2 \times 150 + 4.0 = 34.0\text{kg}$$

The final result will be as follows:

$$\text{Amount of refrigerant to be charged} = 34.0\text{kg}$$

(3) Sample: Outdoor PU(H)Y-P250YGM-A x 2, Indoor PFD-P500VM-E

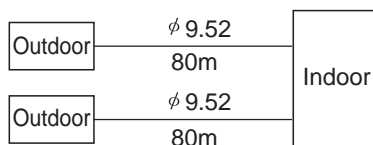

When the liquid pipe size is ϕ 9.52, and the pipe length is 80m,

According to the above formula

$$\text{Amount of refrigerant to be charged (kg)} = 0.06 \times 80 + 2.0 = 6.8\text{kg}$$

The final result will be as follows:

$$\text{Amount of refrigerant to be charged} = 6.8\text{kg} \text{ (for one refrigerant circuit)}$$



CAUTION

Charge liquid refrigerant (as opposed to gaseous refrigerant) into the system.

- If gaseous refrigerant is charged into the system, the composition of the refrigerant in the cylinder will change and may result in performance loss.

[5] Refrigerant Amount Adjust Mode

1. Procedures

Follow the procedures below to add or extract refrigerant in the cooling mode as necessary.

When the function switch switches (SW2-4) on the main board on the outdoor unit are turned to ON, the unit will go into the refrigerant amount adjust mode.

Operation	When the unit is in the refrigerant amount adjust mode, the LEV on the indoor unit does not open as fully as it normally does during cooling operation to secure subcooling.
-----------	--

Notes:

- 1) There may be cases when the refrigerant amount may seem adequate for a short while after starting the unit in the refrigerant amount adjust mode but turn out to be inadequate later on (when the refrigerant system stabilizes).
 [When the amount of refrigerant is truly adequate]
 TH5-TH7 on the indoor unit is 5K or above and SH on the indoor unit is between 5 and 15K.
 [When the amount of refrigerant is inadequate]
 TH5-TH7 on the indoor unit is 5K or less and SH on the indoor unit is 5K or less.
 Wait until the TH5-TH7 reaches 5K or above and the SH of the indoor unit is between 5 and 15K to determine that the refrigerant amount is adequate.
- 2) High pressure must be at least 2.0MPa to enable a proper adjustment of refrigerant amount to be made.
- 3) Adjust the refrigerant amount based on the values of TH1, TH5, TH7, and Tc and by following the flow chart below.
 TH1, TH5, TH7, and Tc can be displayed by setting the self-diagnosis switch (SW1) on the main board on the outdoor unit.
- 4) Refrigerant amount adjust mode automatically ends 90 minutes after beginning. When this happens, by turning off the SW2-4 and turning them back on, the unit will go back into the refrigerant amount adjust mode.

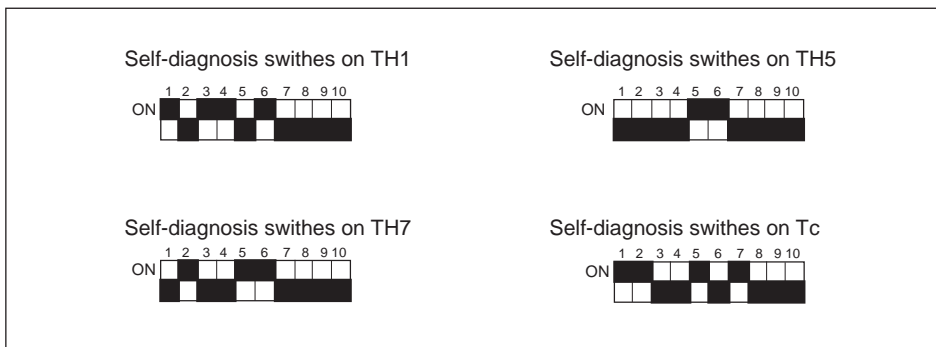

Use these switches to figure out the values of TH1, Tc - TH5, and Tc - TH7.

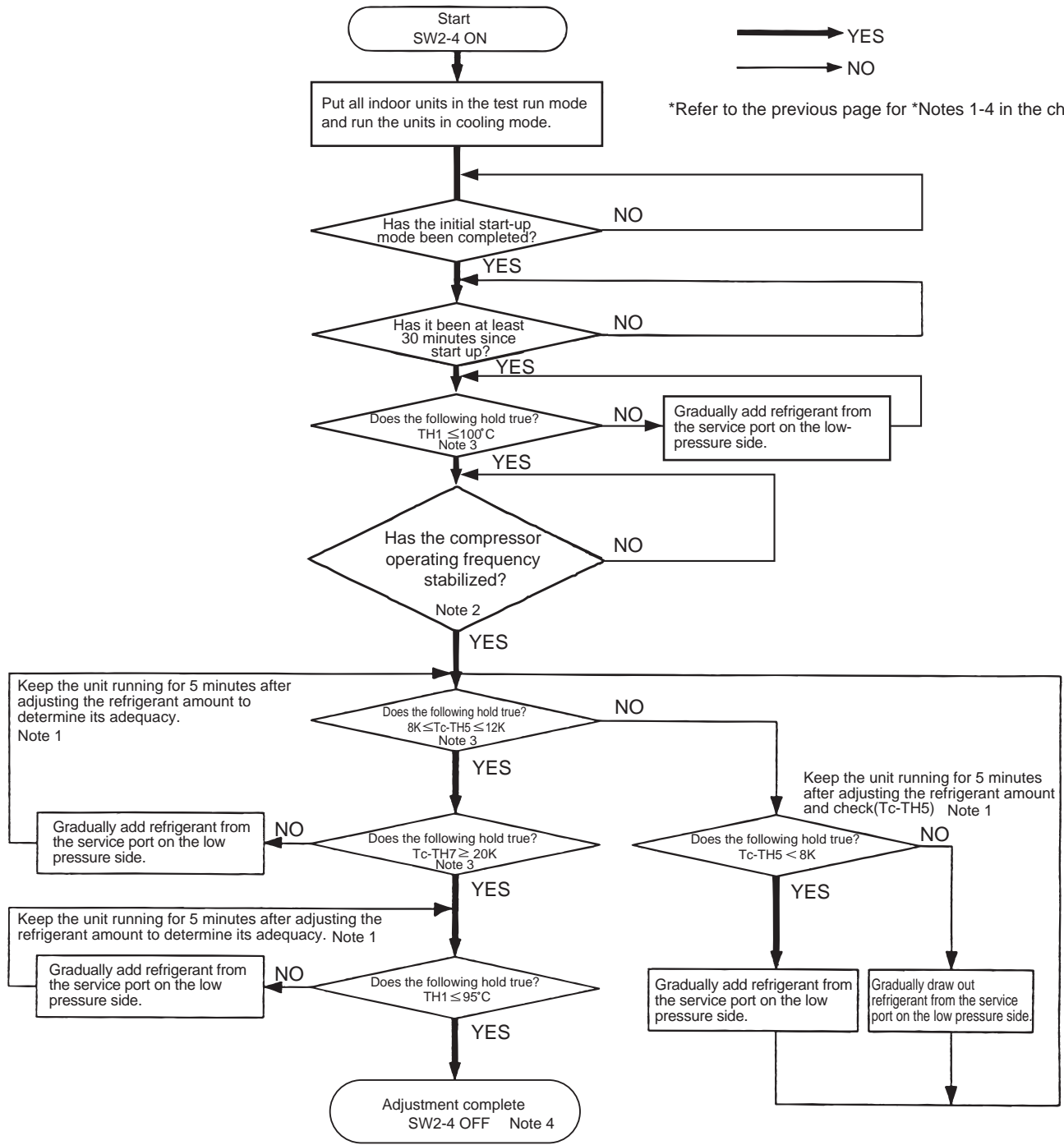

CAUTION
Do not release the extracted refrigerant into the air.

CAUTION
Charge liquid refrigerant (as opposed to gaseous refrigerant) into the system.
• If gaseous refrigerant is charged into the system, the composition of the refrigerant in the cylinder will change and may result in performance loss.

[6] The following symptoms are normal.

Symptoms	Remote controller display	Cause
When the main power is turned on, the display shown on the right appears on the indoor unit remote controller for approx. one minute.	"HO" blinks on the display.	The system is starting up. Wait until the blinking display of "HO" goes off.

The following symptoms are also normal.

Items	Notes	Countermeasures
Noise of the outdoor unit	Note that the noise level specified on the specification sheet is measured in an anechoic room. The noise level varies much depending on the installation condition (e.g. echo condition) on site.	<ul style="list-style-type: none"> •Do not install in a place such as residential area where silence is required. •Consult the dealer when the noise is a concern at the installation site.
Influence of noise	<p>Low noise is generated from the power supply, the transmission line, or the unit body as a microcomputer is used in the air-conditioner. Equipment, such as wireless microphones or medical equipment, that amplifies a minute electric signal may malfunction due to noise if the unit is installed adjacent to such equipment.</p> <p>If the unit is installed adjacent to equipment, such as electric discharge machine, that generates high noise, the unit may malfunction due to noise generated from such equipment. To avoid this, take countermeasures described on the right.</p>	<ul style="list-style-type: none"> •Install the equipment, such as receivers or antennas of wireless microphones, that may malfunction due to noise as far as possible away from the transmission line, the power supply of the unit, or the unit body. •Keep the power supply line of the equipment that emits high noise away from the power source of the air-conditioner, and install the transmission line, the power supply line, and the unit body as far as possible away from such equipment.

[7] Standard Operation Data (Reference Data)

(1) Cooling operation

Operation				Indoor unit model	Outdoor unit model
				PFD-P500VM-E	PUHY-P500YGM-A
Operating conditions	Ambient temperature	Indoor	DB/ WB °C	27/19	
		Outdoor		35/-	
	Piping	Total pipe length	m	7.5	
Outdoor unit	Compressor frequency (No.1/No.2)		Hz	50Hz:70/50 60Hz:62/60	
LEV opening	Indoor unit		Pulse	593	
	SC (LEV1)			193	
Pressure	High pressure (after O/S)/low pressure (before accumulator)		MPa	2.90/0.99	
Temp. of each section	Outdoor unit	Discharge (TH11/TH12)	°C	84/85	
		Heat exchanger outlet (TH5)		43	
		Compressor inlet		22/23	
		Compressor shell bottom		43/45	
		SC heat exchanger outlet (TH7)		26	
		Bypass outlet (TH8)		15	
	Indoor unit	LEV inlet		26	
		Heat exchanger outlet		18	

IX Troubleshooting

[1] Error code Lists.....	111
[2] Responding to Error Display on the Remote Controller.....	114
[3] Investigation of Transmission Wave Shape/Noise	144
[4] Troubleshooting Principal Parts.....	147
[5] Refrigerant Leak	167
[6] Compressor Replacement Instructions (Only P500 type).....	168
[7] Collecting the Cooling Liquid from the Accumulator (Only P500 type)	169
[8] Maintenance/Inspection Schedule.....	170



[1] Error code Lists

Error Code	Preliminary error code	Error (preliminary) detail code	Error code definition	Searched unit			Notes
				Outdoor unit	Indoor unit	Remote controller	
0403	4300 4305	01 05 (Note)	Serial communication error	O			
1102	1202	-	Abnormal discharge air temperature, Abnormal discharge temperature sensor	O			
1301	-	-	Abnormal low pressure	O			
1302	1402	-	Abnormal high pressure	O			
1500	1600	-	Excessive or insufficient refrigerant (Overflow of the accumulator)	O			
-	1605	-	Preliminary suction pressure abnormality	O			
2503	-	-	Drain pump failure Float switch trip		O		
4103	-	-	Reverse phase/open phase	O			
4108	4158	-	Overcurrent protection (51C2) (No.2 Comp)	O			
4109	-	-	Abnormal fan		O		
4115	-	-	Power supply sync signal abnormality Frequency abnormality	O			
4220 4225 (Note)	4320 4325 (Note)	[108]	Bus voltage drop (S/W detection)	O			
		[109]	Bus voltage rise (S/W detection)	O			
		[110]	Bus voltage abnormality (H/W detection)	O			
		[111]	Logic error	O			
4230 4235 (Note)	4330 4325 (Note)	-	Heatsink overheat protection (THHS abnormality)	O			
4240 4245 (Note)	4340 4345 (Note)	-	Overload protection	O			
4250 4255 (Note)	4350 4355 (Note)	[101]	IPM error	O			
		[102]	ACCT overcurrent breaker trip (H/W detection)	O			
		[103]	DCCT overcurrent breaker trip (H/W detection)	O			
		[104]	IPM short/grounding abnormality	O			
		[105]	Overcurrent error due to short-circuited motor	O			
		[106]	Instantaneous overcurrent breaker trip (S/W detection)	O			
		[107]	Effective overcurrent breaker trip (S/W detection)	O			
4260 4265 (Note)	436X (No error history)	-	Cooling fan abnormality	O			

Error Code	Preliminary error code	Error (preliminary) detail code	Error code definition		Searched unit			Notes
					Outdoor unit	Indoor unit	Remote controller	
5101	1202	-	Temperature sensor failure	Suction air temperature (TH21)		O		
				Discharge air temperature (TH11, TH12)	O			
5102	-	-	Temperature sensor failure	Indoor piping (TH22)		O		
5103	-	-	Temperature sensor failure	Gas side pipe (TH23)		O		
5104	-	-	Temperature sensor failure	Outlet temperature (IC) (TH24)		O		
5105	1205	-	Temperature sensor failure	Pipe (TH5)	O			
5106	1221	-	Temperature sensor failure	Outside air temperature (TH6)	O			
5107	1216	-	Temperature sensor failure	SC coil outlet (TH7)	O			
5108	1217	-	Temperature sensor failure	SC coil bypass outlet (TH8)	O			
5110	1214	01 05 (Note)	Temperature sensor failure	Heatsink (THHS)	O			
5201	1402	-	High pressure sensor failure (OC: HPS)		O			
5301	4300	[115]	ACCT sensor failure		O			
		[116]	DCCT sensor failure		O			
		[117]	ACCT sensor circuit failure		O			
		[118]	DCCT sensor circuit failure		O			
		[119]	IPM open/Disconnected ACCT connector		O			
		[120]	ACCT faulty wiring detection		O			
6600	-	-	Address overlaps		O	O	O	
6601	-	-	Polarity setting error		O			
6602	-	-	Transmission processor hardware error		O	O	O	
6603	-	-	Transmission circuit bus-busy		O	O	O	
6606	-	-	Communication error with the transmission processor		O	O	O	
6607	-	-	No ACK		O	O	O	
6608	-	-	No response		O	O	O	
6831	-	-	MA communication transmission error (No receipt)			O	O	
6832	-	-	MA communication receipt error (Synchronization)			O	O	
6833	-	-	MA communication transmission error (Hardware error)			O	O	
6834	-	-	MA communication transmission error (Start bit detection error)			O	O	

Error Code	Preliminary error code	Error (preliminary) detail code	Error code definition	Searched unit			Notes
				Outdoor unit	Indoor unit	Remote controller	
7100	-	-	Total capacity error	O			
7101	-	-	Capacity code error	O	O		
7102	-	-	Error in the number of connected units	O			
7105	-	-	Address setting error	O			
7110	-	-	Unset unit connection information error	O			
7111	-	-	Remote controller sensor failure		O		
7113	-	-	Function setting error	O			
7116	-	-	Replace Multi setting error	O			
7117	-	-	Model setting error	O			
7130	-	-	Incompatible units	O	O		

Note: The last digit in the check error codes in the 4000's and 5000's and two-digit detail codes indicate if the codes apply to compressor inverter on fan inverter.

Example

Code 4225 : Bus voltage drop in the fan inverter system

Code 4250 : IPM / overcurrent breaker trip in the compressor inverter system

The last digit	Inverter address (system)	Inverter system
0 or 1	1	Compressor inverter system
5	5	Fan inverter system

[2] Responding to Error Display on the Remote Controller

1. Mechanical system

Error Code		Error definition and error detection method	Cause	Check method and remedy
0403	Serial communication error	<p>Serial communication error between the main board and the INV board on the compressor, and between the main board and the inverter board on the fan</p> <p>Detail code 01: Between the main board and the compressor INV board</p> <p>Detail code 05: Between the main board and the FAN INV board</p>	(1) Faulty wiring	Check for wiring between the connector (CNRS3B) on the main board and the connector (CNRS1) on the compressor INV board or between the connector (CNRS3A) on the main board and the connector (CNRS2) on the FAN INV board and check contact of the connectors. Check for contact of the connector (CNAC3) on the main board or of the connector (CNTR) on the FAN INV board.
			(2) Inverter address switch setting error	Check the setting for SW2-1 on the inverter board on the compressor. Confirm that the SW2-1 on the fan inverter board is set to ON.
			(3) Transformer failure	Measure voltages between pins 1 and 3 of the male connector (CNTR) on the FAN INV board.
			(4) Compressor INV board failure FAN INV board failure.	Replace the compressor INV board or the FAN INV board when the power turns on automatically, even if the power source is reset.

Error Code		Error definition and error detection method	Cause	Check method and remedy
1102	Abnormal discharge air temperature	<p>1. If the discharge temperature of 120°C or more is detected during the above operation (the first detection), the outdoor unit stops once, turns to anti-restart mode for 20 seconds, and restarts after 20 seconds automatically.</p> <p>2. If the discharge temperature of 120°C or more is detected again (the second detection) within 30 minutes after the second stop of the outdoor unit described above, the mode will be changed to 20-second restart mode, then the outdoor unit will restart in 20 seconds.</p> <p>3. If the discharge temperature of 120°C or more is detected (the third detection) within 30 minutes after the stop of the outdoor unit described above (regardless of the first or the second stop), the outdoor unit will make an error stop, and the error code "1102" will be displayed.</p> <p>4. If the discharge temperature of 120°C or more is detected more than 30 minutes after the previous stop of the outdoor unit, the detection is regarded as the first detection, and the operation described in step 1 above will start.</p> <p>5. For 30 minutes after the stop (the first stop or the second stop) of the outdoor unit, preliminary errors will be displayed on the LED display.</p>	(1) Gas leak, gas shortage	Refer to the page on refrigerant amount evaluation.
			(2) Overload operation	Check operating conditions and operation status of indoor/outdoor units.
			(3) LEV failure on the indoor unit (4) LEV1 failure on the outdoor unit	Perform a cooling or heating operation and check the operation. Cooling : LEV on the indoor unit LEV1 Heating : LEV on the indoor unit Refer to the page on troubleshooting LEV.
			(5) Closed ball valve	Confirm that the ball valve is fully open.
			(6) Outdoor fan (including fan parts) failure, motor failure, or fan controller malfunction Rise in discharge temp. by low pressure drawing for (3) - (6).	Check the fan on the outdoor unit. Refer to the section on troubleshooting the outdoor unit fan.
			(7) Gas leak between low and high pressures (4-way valve failure, Compressor failure, Solenoid valve (SV1) failure)	Perform a cooling or heating operation and check the operation.
			(8) Thermistor failure (TH1, TH11, TH12)	Check the thermistor resistor.
			(9) Input circuit failure on the controller board thermistor	Check the inlet air temperature on the LED monitor.

Error Code		Error definition and error detection method	Cause	Check method and remedy
1301	Abnormal low pressure	When starting the compressor from Stop Mode for the first time if low-pressure reads 0.098MPa immediately before start-up, the operation immediately stops.	<ul style="list-style-type: none"> (1) Inner pressure drop due to a leakage. (2) Low pressure sensor failure (3) Short-circuited pressure sensor cable due to torn outer rubber (4) A pin on the male connector is missing. (5) Disconnected wire (6) Failure of the low pressure input circuit on the controller board 	Refer to the section on troubleshooting the low pressure sensor.

Error Code		Error definition and error detection method	Cause	Check method and remedy		
1302	Abnormal high pressure 1 (outdoor unit)	<p>1. If the pressure of 3.87MPa or higher is detected by the pressure sensor during operation (the first detection), the outdoor stops once, turns to anti-restart mode for 20 seconds, and re-starts after 20 seconds automatically.</p> <p>2. If the pressure of 3.87MPa or higher is detected by the pressure sensor again (the second detection) within 30 minutes after the first stop of the outdoor unit, the outdoor unit stops once, turns to anti-restart mode for 20 seconds, and re-starts after 20 seconds automatically.</p> <p>3. If the pressure of 3.87MPa or higher is detected by the pressure sensor (the third detection) within 30 minutes of the second stop of the outdoor unit, the outdoor unit will make an error stop, and the error code "1302" will be displayed.</p> <p>4. If the pressure of 3.87MPa or higher is detected more than 30 minutes after the stop of the outdoor unit, the detection is regarded as the first detection, and the operation described in step 1 above will start.</p> <p>5. For 30 minutes after the stop of the outdoor unit, preliminary errors will be displayed on the LED display.</p> <p>6. The outdoor unit makes an error stop immediately when not only the pressure sensor but also the pressure switch detects $4.15^{+0,-0.15}$ MPa</p>	(1) LEV failure on the indoor unit -> Heating	Perform a heating operation and check the operation. Heating : LEV on the indoor unit Refer to the page on troubleshooting LEV.		
			(2) Closed ball valve	Confirm that the ball valve is fully open.		
			(3) Short cycle on the indoor unit side (4) Clogged filter on the indoor unit (5) Reduced air flow due to dirty fan on the indoor unit fan (6) Dirty heat exchanger of the indoor unit (7) Indoor fan (including fan parts) failure or motor failure Rise in high pressure caused by lowered condensing capacity in heating operation for (2) - (7).	Check the indoor units for problems and correct them, if any.		
			(8) Short cycle on the outdoor unit (9) Dirty heat exchanger of the outdoor unit	Check the outdoor units for problems and correct them, if any.		
			(10) Outdoor fan (including fan parts) failure, motor failure, or fan controller malfunction (9) and (10) above occur due to condensing capacity drop in cooling mode.	Check the fan on the outdoor unit. Refer to the section on troubleshooting the outdoor unit fan.		
			(11) Solenoid valve (SV1) malfunction (The by-pass valve (SV1) can not control rise in high pressure).	Refer to the section on troubleshooting the solenoid valve.		
			(12) Thermistor failure (TH2, TH5, TH6).	Check the thermistor resistor.		
			(13) Pressure sensor failure	Refer to the page on the troubleshooting of the pressure sensor.		
			(14) Failure of the thermistor input circuit and pressure sensor input circuit on the main board	Check the temperature and the pressure of the sensor with LED monitor.		
			(15) Faulty mounting of thermistor (TH5, TH6) (16) Disconnected male connector on the pressure switch (63H) or disconnected wire	Check the temperature and the pressure of the sensor with LED monitor.		
			(17) Melted fuse (F1 or F2) on the controller board	Check for a melted fuse. Check for short-circuited cooling FAN (MF), 4-way valve, or actuator like solenoid valve.		
			Abnormal high pressure 2 (outdoor unit)	If the pressure of 0.098MPa or lower is registered on the pressure sensor immediately before start-up, it will trigger an abnormal stop, and error code "1302" will be displayed.	(1) Inner pressure drop due to a leakage. (2) Pressure sensor failure (3) Shorted-circuited pressure sensor cable due to torn outer rubber (4) A pin on the male connector on the pressure sensor is missing or contact failure (5) Disconnected pressure sensor cable (6) Failure of the pressure sensor input circuit on the controller board	Refer to the page on the troubleshooting of the high pressure sensor.

Error Code		Error definition and error detection method	Cause	Check method and remedy
1500	Refrigerant overcharge	<p>An error can be detected by the discharge temperature superheat.</p> <p>1. If the discharge SH 10K or less is detected during operation (the first detection), the outdoor unit stops at once, turns to anti-restart mode for 20 seconds, and restarts after 20 seconds automatically.</p> <p>2. If the discharge SH 10K or less is detected again within 30 minutes after first stop of the outdoor unit (the second detection), the outdoor unit will make an error stop, and the error code "1500" is displayed.</p> <p>3. If discharge SH 10K or less is detected more than 30 minutes after the outdoor unit stops, and the operation described in step 1 above will start.</p> <p>4. For 30 minutes after the stop of the outdoor unit, preliminary errors will be displayed on the LED display.</p>	(1) Overcharged refrigerant	Refer to the page on refrigerant amount evaluation.
			(2) Thermistor input circuit failure on the main board (3) Faulty mounting of thermistor (TH11, TH12)	Check the temperature and the pressure of the sensor with LED monitor.
2503	Float switch trip	<p>When the float switch trips during operation, and when an open is detected (cannot be detected during OFF). Open : detectable at -40°C or lower</p>	(1) Drainage failure (2) Connector contact failure (loose connector) (3) Disconnection or partial disconnection of the float switch wiring	Check the drain pan, drain hose, and drainage. Check that the resistance of the float switch is 250 milliohm or less.
			Indoor board (detection circuit) failure	Check the connector contact. If no fault is found, the indoor board is a failure.

Error Code		Error definition and error detection method	Cause	Check method and remedy												
4103	Reverse phase/open phase	1. The operation cannot be started because of the reserve phase of one of the power lines (L1 or L2).	(1) Faulty wiring	<ul style="list-style-type: none"> •Check whether the phase of the power supply terminal block (TB1) is normal. •Check the wiring between the power supply terminal block (TB1) and the main boards (CN20 and CN21). <table border="1" style="margin-left: auto; margin-right: auto;"> <thead> <tr> <th>TB1</th> <th colspan="2">Pin</th> </tr> </thead> <tbody> <tr> <td>L1</td> <td>CN20</td> <td>5Pin</td> </tr> <tr> <td>N</td> <td>CN21</td> <td>3Pin</td> </tr> <tr> <td>L2</td> <td>CN21</td> <td>1Pin</td> </tr> </tbody> </table>	TB1	Pin		L1	CN20	5Pin	N	CN21	3Pin	L2	CN21	1Pin
			TB1	Pin												
		L1	CN20	5Pin												
		N	CN21	3Pin												
		L2	CN21	1Pin												
(2) Main board failure.	If the above faults are not found, the main board is faulty.															
2. When turning on the power, the operation cannot be started because of the open phase of one of the power lines (L1, L2 or L3).	(1) Power supply error <ul style="list-style-type: none"> •Open phase of power supply voltage •Power-supply voltage drop 	Check the input resistance of the power supply terminal block (TB1).														
	(2) Faulty wiring Between the power supply terminal block (TB1) and the main boards (CN20 and 21)	<ul style="list-style-type: none"> •Measure voltages of pin 5 of the male connector (CN20) on the main board and between pins 1 and 3 of the male connector (CN21) on the main board. •If the voltage is not the same as the power supply voltage, the wiring is faulty. 														
	(3) A fuse is blown.	Check whether the fuses of the main board (both F01 and F02) are not blown.														
	(4) Main board failure	If the above faults are not found, the main board is faulty.														
4108	Overcurrent protection	<p>1. First detection If 51C2 is started during the operation of No.2 compressor, the outdoor unit goes into 20-second restart mode, then the outdoor unit will start in 20 seconds. (Set value of the over-current relay: 17.5A)</p> <p>2. Second detection If 51C2 is started again within a minute after restarting in compliance with 1. above, the unit makes an error stop and the error code "4108" will appear.</p> <p>3. There will be a minute grace period of an error stop when No.2 compressor restarts after the outdoor unit stops and LED indicates, which means the grace period, will appear.</p>	(1) Overload operation that exceeds unit use limit	Check the unit working condition.												
			(2) Power supply error <ul style="list-style-type: none"> •Power-supply voltage drop •Open phase of power supply voltage 	Check the voltage of the power supply terminal block (TB1). Check for open phase.												
			(3) Faulty wiring	Check 52C2 connector and the wiring.												
			(4) Compressor failure <ul style="list-style-type: none"> •Compressor open phase or grounding fault •Compressor lock 	<p>Check the wiring and apply a megger to the compressor. Start operation under no-load conditions. Remove the power wire on the compressor-side, insulate the power line and start operation.</p> <p>-> The compressor is faulty if 52C2 normally turns on.</p>												

Error Code		Error definition and error detection method	Cause	Check method and remedy						
4109	Abnormal fan (IC)	<p>If the auxiliary relay X4 (for detecting fan abnormality) is not excited for a certain period of time, the fan makes an error stop, and the fan output turns to OFF. Set value of overcurrent circuit breaker</p> <table border="1"> <thead> <tr> <th>Model, motor output</th> <th>Set value</th> </tr> </thead> <tbody> <tr> <td>PFD P250 model3.7kW</td> <td>7.5A</td> </tr> <tr> <td>P500 model5.5kW</td> <td>12A</td> </tr> </tbody> </table>	Model, motor output	Set value	PFD P250 model3.7kW	7.5A	P500 model5.5kW	12A	(1) Overcurrent circuit breaker (51F) trip	<p>Check that the fan is not stalled, the bearing is not worn out, and the pulley does not come in contact. Check the tension of the V-belt. (Check that the belt is not over-tensioned.) Check that the motor is not stalled. Check whether 51F malfunctions. (Leave the test switch ON.)</p>
			Model, motor output	Set value						
			PFD P250 model3.7kW	7.5A						
			P500 model5.5kW	12A						
			(2) A fuse (F1) is blown.	Check that the fuse is not blown or not disconnected.						
			(3) Auxiliary relay (X4) failure	Check that the lead wire is not disconnected, not broken, or wired wrongly, that the coil is not faulty, and that the contact is not faulty.						
			(4) Broken wire	Check that the wire is not disconnected.						
(5) Disconnected wire	Check the contact of the connector.									
(6) Indoor controller (I.B1, I.B2) failure	If the items described above are all normal, the circuit board is faulty.									
4115	Power supply sync signal abnormality	The frequency cannot be determined when the power is switched on.	(1) Power supply error	Check the voltage of the power supply terminal block (TB1).						
			(2) A fuse is blown	Check the fuses on the main board (F01 and F02).						
			(3) Faulty wiring	<p>Measure voltages of pin 5 of the male connector (CN20) on the main board and between pins 1 and 3 of the male connector (CN21) on the main board. If the voltage (AC380~415V) is not the same as the power supply voltage, the wiring is faulty.</p>						
			(4) Main board failure	If none of the items described above is applicable, and if the trouble reappears even after the power is switched on again, replace the MAIN board.						

Error Code		Error definition and error detection method	Cause	Check method and remedy
4220 4225	Bus voltage drop (Detail code 108)	If Vdc 289V or less is detected during Inverter operation. (S/W detection)	(1) Power supply environment	Check whether the unit makes an instantaneous stop when the detection result is abnormal or a power failure occurs. Check whether the power voltage is 150V or less across all phases.
			(2) Voltage drop detected	In the case of 4220 Measure voltages of the male connector (CNDC2) on the compressor INV board. -> Replace the INV board when there is no voltage drop. -> Check the followings when there is a voltage drop. 1) Check the voltage of CN52C on the main board. Refer to (3). 2) Check whether 52C works normally Refer to (4). Or check 52C connecting piping. 3) Check for the diode stack. Refer to (5). 4) Check for the wiring and the connectors between the CNDC2 on the compressor INV board and the CNDC1 on the G/A board. Replace G/A board when no fault is found for the above (1) - (4). In the case of 4225 Check the following. 1) Check the voltage of CN52C on the main board. Refer to (3). 2) Check whether 52C works normally Refer to (4). Or check 52C wire connection. 3) Check for diode stack failure. Refer to (5). 4) Check the wiring and the connectors of the CNVDC on the FAN INV board. Replace FAN INV board when no fault is found for the above (1) - (4).
			(3) Main board failure	Check whether AC220~240V is applied to the male connector (CN52C) on the main board during inverter operation. ->If not applied, check the main board and the fuse (F01 and F02). Replace the main board when no fault is found.
			(4) 52C failure	Refer to 9 [4]-6-(4) and check the coil resistance check.
			(5) Diode stack failure	Refer to 9 [4]-6-(6) and check the diode stack resistance.
	Bus voltage rise (Detail code 109)	If Vdc 817V or more is detected during inverter operation.	(1) Different voltage connection	Check the power supply voltage on the power supply terminal block (TB1).
			(2) INV board failure	Replace the INV board when no fault is found. In the case of 4220: Compressor INV board In the case of 4225: FAN INV board
	Abnormal VDC (Detail code 110)	Bus voltage abnormality If Vdc 772V or more or Vdc 308V or less is detected. (H/W detection)	Same as detail code No.108 and 109 of 4220 error	Same as detail code No.108 and 109 of 4220 error.

Error Code		Error definition and error detection method	Cause	Check method and remedy
4220 4225	Logic error (Detail code No.111)	If only the H/W error logic circuit operates, and no identifiable error is detected.	In the case of 4220 (1) External noise (2) Compressor INV board failure (3) G/A board failure (4) IPM failure (5) DCCT failure	Refer to 9 [4]-6-(2) [1] and replace the G/A board. Refer to 9 [4]-6-(2) [5] and replace DCCT.
			In the case of 4225 (1) External noise (2) FAN INV board failure	Refer to 9 [4]-6-(2) [7].
4230 4235	Heatsink over-heat protection	In the case of 4230 When the heat sink temperature (THHS1) 95°C or higher is detected. In the case of 4235 When the heat sink temperature (THHS5) 85°C or higher is detected.	(1) Power supply environment	Measure the power supply voltage. Ensure that the power supply voltage is 342V or more between each phase.
			(2) Air passage blockage	Check that the heat sink cooling air passage is not blocked.
			(3) Faulty wiring	Check for cooling fan wiring.
			(4) THHS failure	Check for THHS sensor resistor.
			(5) Compressor INV board failure and cooling fan failure	Check that a voltage of 220~240V is applied to the compressor INV board connector CNFAN while the inverter is in operation.
			(6) Cooling failure	Check the cooling fan operation under the above operating conditions.
			(7) IPM failure	Refer to 9 [4]-6-(2) [2] "Check for compressor ground fault or coil error". Refer to 9 [4]-6-(2) [5] "Check the inverter circuit trouble".

Error Code		Error definition and error detection method	Cause	Check method and remedy						
4240 4245	Overload protection	When the greater output current (Iac) than the I _{max} (Arms), or THHS of more than 90 °C is detected for 10 minutes in a row. <table border="1" data-bbox="485 427 732 562"> <thead> <tr> <th></th> <th>I_{max}</th> </tr> </thead> <tbody> <tr> <td>P250 model</td> <td>27 Arms</td> </tr> <tr> <td>P500 model</td> <td>27 Arms</td> </tr> </tbody> </table>		I _{max}	P250 model	27 Arms	P500 model	27 Arms	(1) Short cycle of the air passage	Check that the waste heat from the outdoor unit fan is not short cycled.
				I _{max}						
			P250 model	27 Arms						
			P500 model	27 Arms						
			(2) Air passage blockage	Check that the heat sink cooling air passage is not blocked.						
			(3) Power supply	Check whether the power supply voltage is 342V or more.						
			(4) Faulty wiring	Check for cooling fan wiring.						
			(5) THHS failure	Check for THHS sensor resistor. In the case of 4240: THHS1 In the case of 4245: THHS5						
			(6) Compressor INV board failure and cooling fan failure	Ensure that the heat sink temperature is 55 °C or more and that 220~240V is applied to the inverter PCB connector CNFAN when the inverter is on.						
			(7) Cooling failure	Check the cooling fan operation under the above operating conditions.						
(8) Current sensor (ACCT) failure	Refer to 9 [4]-6-(4). "Current sensor ACCT"									
(9) Compressor Inverter circuit failure	Refer to 9 [4]-6-(2) [4]. "Check whether the inverter is damaged".									
(10) Compressor failure	Check that the compressor has not overheated during operation. -> Check the refrigerant circuit (oil return section). Replace the compressor when no fault is found.									

Error Code		Error definition and error detection method	Cause	Check method and remedy
4250 4255	IPM error (Detail code 101)	When an error signal of IPM is detected	In the case of 4250 (1) Inverter output related (2) Same as 4230 error	Same as 4230 error
			In the case of 4255 (1) Fan motor abnormality (2) FAN INV board failure	Refer to 9 [4]-6-(2) [6]. Refer to 9 [4]-6-(2) [7].
	ACCT overcurrent breaker trip (Detail code 102) DCCT overcurrent breaker trip (Detail code 103) Overcurrent breaker trip (Detail code 106,107)	When overcurrent break (94 Apeak or 35 Arms) is detected by the current sensor.	(1) Inverter output related	9 [4]-6-(2) Inverter output related troubles Refer to [1] - [5].
	IPM short/ grounding fault (Detail code 104)	When IPM short damage or grounding on the load side is detected just before starting the inverter.	In the case of 4250 (1) Grounding fault of compressor (2) Inverter output related	Refer to 9 [4]-6-(2).
			In the case of 4255 (1) Grounding fault of fan motor (2) FAN INV board failure	Refer to 9 [4]-6-(2) [6]. Refer to 9 [4]-6-(2) [7].
	Overcurrent error due to short-circuited motor (Detail code 105)	When a short is detected on the compressor or the fan motor just before the inverter operation.	In the case of 4250 (1) Short-circuited compressor (2) Output wiring (3) Power supply	Refer to 9 [4]-6-(2) [2].
			In the case of 4255 (1) Short-circuited fan motor (2) Output wiring (3) Power supply	Refer to [4]-6-(2) [6].
4260 4265	Cooling fan abnormality	In the case of 4260 When the heat sink temperature (THHS1) 95°C or more is detected for 10 or more minutes at inverter startup In the case of 4265 When the heat sink temperature (THHS5) 85°C or more is detected for 10 or more minutes at inverter startup	Same as 4230 error	Refer to Same as 4230 error.

Temperature sensor failure (indoor unit)				
Error Code		Error definition and error detection method	Cause	Check method and remedy
5101	Air inlet	If a short or an open is detected during thermostat ON, the outdoor unit turns to anti-restart mode for 3 minutes. When the error is not restored after 3 minutes (if restored, the outdoor unit runs normally), the outdoor unit makes an error stop. Short: detectable at 90°C or higher Open : detectable at -40°C or lower *Sensor error at gas-side cannot be detected under the following conditions. ♦During heating operation ♦During cooling operation for 3 minutes after the compressor turns on.	(1) Thermistor failure (2) Connector contact failure (3) Disconnected wire or partial disconnected thermistor wire (4) Unattached thermistor or contact failure	Check the thermistor resistor. 0°C : 15 kohm 10°C : 9.7 kohm 20°C : 6.4 kohm 30°C : 4.3 kohm 40°C : 3.1 kohm
5102	Liquid pipe			
5103	Gas pipe			
5104	Air outlet		(5) Indoor board (detection circuit) failure	Check the connector contact. When no fault is found, the indoor board is a failure.

Temperature sensor failure (outdoor unit)																									
Error Code		Error definition and error detection method	Cause	Check method and remedy																					
5101	Discharge (TH11,TH12)	<p>1. When a short (high temperature intake) or an open (low temperature intake) of the thermistor is detected (the first detection), the outdoor unit stops, turns to anti-restart mode for 3 minutes, and restarts when the detected temperature of the thermistor.</p> <p>2. When a short or an open is detected again (the second detection) after the first restart of the outdoor unit, the outdoor unit stops, turns to anti-restart mode for 3 minutes, and restarts in 3 minutes when the detected temperature is within the normal range.</p> <p>3. When a short or an open is detected again (the third detection) after the previous restart of the outdoor unit, the outdoor unit makes an error stop.</p> <p>4. When a short or an open of the thermistor is detected just before the restart of the outdoor unit, the outdoor unit makes an error stop, and the error code "5101", "5103", "5104", "5105", "5106", "5107" or "5108" will appear.</p> <p>5. During 3-minute anti-restart mode, preliminary errors will be displayed on the LED display.</p> <p>6. A short or an open described above is not detected for 10 minutes after the compressor start, during defrost mode, or for 3 minutes after defrost mode.</p>	(1) Thermistor failure	Check thermistor resistance.																					
5105	Piping (TH5)		(2) Pinched lead wire	Check for pinched lead wire.																					
5106	Outdoor air temperature (TH6)		(3) Torn wire coating	Check for wire coating.																					
5107	SC coil outlet (TH7)		(4) A pin on the male connector is missing or contact failure	Check connector.																					
5108	SC coil bypass outlet (TH8)		(5) Disconnected wire	Check for wire.																					
			(6) Thermistor input circuit failure on the main board	Check the intake temperature of the sensor with the LED monitor. When the temperature is far different from the actual temperature, replace the control board.																					
		<table border="0"> <thead> <tr> <th></th> <th>Short detection</th> <th>Open detection</th> </tr> </thead> <tbody> <tr> <td>TH11</td> <td>240 °C and above (0.57 kΩ)</td> <td>0 °C and below (643 kΩ)</td> </tr> <tr> <td>TH12</td> <td>240 °C and above (0.57 kΩ)</td> <td>0 °C and below (643 kΩ)</td> </tr> <tr> <td>TH5</td> <td>110 °C and above (0.4 kΩ)</td> <td>-40 °C and below (130 kΩ)</td> </tr> <tr> <td>TH6</td> <td>110 °C and above (0.4 kΩ)</td> <td>-40 °C and below (130 kΩ)</td> </tr> <tr> <td>TH7</td> <td>70 °C and above (1.14 kΩ)</td> <td>-40 °C and below (130 kΩ)</td> </tr> <tr> <td>TH8</td> <td>70 °C and above (0.4 kΩ)</td> <td>-40 °C and below (130 kΩ)</td> </tr> </tbody> </table>			Short detection	Open detection	TH11	240 °C and above (0.57 kΩ)	0 °C and below (643 kΩ)	TH12	240 °C and above (0.57 kΩ)	0 °C and below (643 kΩ)	TH5	110 °C and above (0.4 kΩ)	-40 °C and below (130 kΩ)	TH6	110 °C and above (0.4 kΩ)	-40 °C and below (130 kΩ)	TH7	70 °C and above (1.14 kΩ)	-40 °C and below (130 kΩ)	TH8	70 °C and above (0.4 kΩ)	-40 °C and below (130 kΩ)	
	Short detection	Open detection																							
TH11	240 °C and above (0.57 kΩ)	0 °C and below (643 kΩ)																							
TH12	240 °C and above (0.57 kΩ)	0 °C and below (643 kΩ)																							
TH5	110 °C and above (0.4 kΩ)	-40 °C and below (130 kΩ)																							
TH6	110 °C and above (0.4 kΩ)	-40 °C and below (130 kΩ)																							
TH7	70 °C and above (1.14 kΩ)	-40 °C and below (130 kΩ)																							
TH8	70 °C and above (0.4 kΩ)	-40 °C and below (130 kΩ)																							

Error Code		Error definition and error detection method	Cause	Check method and remedy
5110	Heat sink failure Detail code No. 01: Compressor INV side Detail code No. 05: Fan INV side	When a short or an open of THHS is detected just before or during the inverter operation.	(1) THHS sensor failure	Check for short circuit in THHS sensor.
			(2) Contact failure	Replace THHS sensor.
			(3) Compressor INV board or fan INV board failure	Replace compressor INV board or fan INV board.

Error Code		Error definition and error detection method	Cause	Check method and remedy
5201	High pressure sensor (outdoor unit)	<p>1. If the high pressure sensor detects 0.098MPa or less during the operation, the outdoor unit stops once, turns to anti-restart mode for 20 seconds, and restarts after 20 seconds when the detected high pressure sensor is 0.098MPa or more.</p> <p>2. If the high pressure sensor detects 0.098MPa or less just before the restart, the outdoor unit makes an error stop, and the error code "5201" will appear.</p> <p>3. During 3-minute anti-restart mode, preliminary errors will be displayed on the LED display.</p> <p>4. A error is not detected for 3 minutes after the compressor start, during defrost operation, or 3 minutes after defrost operation.</p>	(1) High pressure sensor failure	Refer to the page on the troubleshooting of the high pressure sensor. (9 [4] -1-)
			(2) Pressure drop due to refrigerant leak	
			(3) Torn wire coating	
			(4) A pin on the male connector is missing or contact failure	
			(5) Disconnected wire	
			(6) High pressure sensor input circuit failure on the main board	

Error Code		Error definition and error detection method	Cause	Check method and remedy
5301	ACCT sensor circuit failure (Detail code 117)	When an error value is detected with the ACCT detection circuit just before the inverter starts	(1) Compressor INV board failure	Refer to 9 [4]-6-(2) [1] "Check the compressor INV board error detection circuit"
			(2) Grounding fault of compressor and IPM failure	Refer to 9 [4]-6-(2) [2] "Check for compressor ground fault or coil error" Refer to 9 [4]-6-(2) [5] "Check the inverter circuit trouble"
	DCCT sensor circuit failure (Detail code 118)	When an error value is detected with the DCCT detection circuit just before the inverter starts	(1) Contact failure	Check the contact of the connector (CNCT) on the INV board, and the contact the connector on DCCT side.
			(2) Compressor INV board failure	Refer to 9 [4]-6-(2) [1] "Check the compressor INV board error "
			(3) DCCT failure	When no fault is found with items 1 and 2, replace the DCCT sensor, and check the polarity of DCCT sensor.
			(4) Grounding fault of the compressor and IPM failure	Refer to 9 [4]-6-(2) [2] "Check for compressor ground fault or coil error" Refer to 9 [4]-6-(2) [5] "Check the inverter circuit trouble"
	ACCT sensor failure (Detail code 115)	When the effective output current between -1.5 Arms and 1.5 Arms is detected during inverter operation	(1) Contact failure	Check the contact of the connector CNCT2 (ACCT) on the compressor INV board.
			(2) ACCT sensor failure	Replace the ACCT sensor.
	DCCT sensor failure (Detail code 116)	When the bus current less than 6.5 Apeak is detected at startup (6Hz)	(1) Contact failure	Check the contact of the connector CNCT (DCCT) on the compressor INV board, and the contact around the connector on DCCT side.
			(2) Misorientation	Check the installation direction of DCCT.
			(3) DCCT sensor failure	Replace the DCCT sensor.
			(4) Compressor INV board failure	Replace the compressor INV board.
	IPM open/Disconnected ACCT connector (Detail code 119)	When IPM open damage or disconnected CNCT2 is not detected just before INV starts (Sufficient current is not detected just before startup)	(1) Disconnected ACCT sensor	Check the connector CNCT2 connection.(Check ACCT installation state)
			(2) Faulty wiring	Check CNDR2 connection on the compressor INV board, or CNDR1 connection on the G/A board.
			(3) ACCT sensor failure	Refer to 9 [4]-6-(4) "Current sensor ACCT", and check the resistance value.
			(4) Disconnected compressor wiring	Refer to 9 [4]-6-(2) [2] "Check for compressor ground fault or coil error"
			(5) Compressor INV circuit failure	Refer to 9 [4]-6-(2) [5] "Check the inverter circuit trouble"
	ACCT faulty wiring detection (Detail code 120)	ACCT sensor is not securely mounted.	(1) Wrongly mounted ACCT sensor	Refer to 9 [4]-6-(4) "Current sensor ACCT"

2. Transmission error

Error Code	Error definition and error detection method	Cause	Check method and remedy
6600	<p>Address overlaps The error is detected when the same address is transmitted from different units.</p> <p>Note: The address/attribute appeared on the display on the main remote controller indicates the controller where an error occurs.</p>	<p>(1) Two or more outdoor units, indoor units, or the main remote controllers have the equivalent addresses.</p> <p>(2) The transmission signal is changed due to noise interference.</p>	<p>If the error "6600" occurs, reset the error (or stop the unit) using the MA remote controller, external input, or the main controller, and start the unit again.</p> <p>(1) If the same error occurs within 5 minutes, find the unit that has the same address as that of the error source unit.</p> <p>When the same address is found, change the addresses, turn off the powers of the outdoor and the indoor units, leave them OFF for 5 minutes or more, and then turn them ON again.</p> <p>(2) If the same error does not occur for 5 minutes or more, check transmission wave shape/noise on transmission line by following <Investigation method of transmission wave shape/noise>.</p>
6601	<p>Unset polarity The error detected when transmission processor cannot distinguish the polarities of the M-NET transmission line.</p>	<p>(1) No voltage is applied to the M-NET transmission line that G-50A is connected to.</p> <p>(2) M-NET transmission line to which G-50A is connected is short-circuited.</p>	<p>Check if power is supplied to the M-NET transmission line of the G-50A, and correct any problem found.</p>

Error Code	Error definition and error detection method	Check method and remedy
6602	<p>Transmission processor hardware error</p> <p>Although "0" was surely transmitted by the transmission processor, "1" is displayed on the transmission line.</p> <p>Note: The address/attribute appeared on the display on the main remote controller indicates the controller where an error occurs.</p>	<p>(1) When the wiring work of or the polarity of either the indoor or outdoor transmission line is performed or is changed while the power is on, the transmitted data will collide, the wave shape will be changed, and an error will be detected.</p> <p>(2) Grounding fault of the transmission line</p> <p>(3) The male connector is connected to the female power supply switch connector (CN40) in the system with the main controller connected.</p> <p>(4) Controller failure of the source of the error</p> <p>(5) When the transmission data is changed due to the noise on the transmission line</p> <p>(6) Voltage is not applied on the transmission line for centralized control</p> <p>Check method and remedy</p> <pre> graph TD Q1{Is the transmission line work performed while the power is on?} -- YES --> A1[Turn off the power source of outdoor/indoor units, and turn them on again.] Q1 -- NO --> B1[Check the power source of the indoor unit.] B1 --> Q2{Power supply voltage?} Q2 -- NO --> A2[Faulty power source work] Q2 -- YES --> B2[Check the transmission line work is performed and the shielded wire is treated properly.] B2 --> Q3{Grounding fault or does the shielded wire contact with the transmission line?} Q3 -- YES --> A3[Improper transmission line work] Q3 -- NO --> Q4{System?} Q4 --> S1[Single-outdoor-unit system] Q4 --> S2[Multiple-outdoor-unit system] Q4 --> S3[System with the main remote controller connected] S3 --> B3[Confirm that the power supply connector on the outdoor unit is not plugged into CN40.] B3 --> Q5{Is the male power supply connector connected to the female power supply switch connector (CN40)?} Q5 -- YES --> A4[Disconnect the male power supply on CN40 and connect it to CN41.] Q5 -- NO --> B4[Investigation into the transmission line noise] B4 --> Q6{Noise exist?} Q6 -- YES --> A5[Investigation into the cause of the noise] Q6 -- NO --> A6[Controller failure of the source of the error] A1 --> A7[Correct the error.] A2 --> A7 A3 --> A7 A4 --> A7 A5 --> A7 A6 --> A7 </pre>

Error Code	Error definition and error detection method	Cause	Check method and remedy
6603	<p>Transmission circuit bus-busy</p> <p>1. Error occurred when the transmission is disabled for 4-10 minutes in a row due to collision of the transmitted data.</p> <p>2. Generated error when the command cannot be transmitted to the transmission line for 4-10 minutes in a row due to noise</p> <p>Note: The address/attribute appeared on the display on the main remote controller indicates the controller where an error occurs.</p>	<p>(1) The transmission processor cannot be transmitted as the short-wavelength voltage like noise exists consecutively on the transmission line.</p> <p>(2) Error source controller failure</p>	<p>No noise indicates that the error source controller is a failure.</p> <p>If noise exists, investigate the noise.</p> <p>-> No noise indicates that the error source controller is a failure.</p> <p>-> If noise exists, investigate the noise.</p>
6606	<p>Communication error with the transmission processor</p> <p>Communication error between the main microcomputer on the indoor unit board and the microcomputer for transmission</p> <p>Note: The address/attribute appeared on the display on the main remote controller indicates the controller where an error occurs.</p>	<p>(1) Data is not properly transmitted due to accidental erroneous operation of the controller of the error source.</p> <p>(2) Error source controller failure</p>	<p>Turn off the power source of the outdoor and the indoor units.(When the power source is turned off separately, the microcomputer will not be reset, and the error will not be corrected.)</p> <p>-> If the same error occurs, the error source controller is a failure.</p>

(1) System with the main remote controller connected

Error Code	Error definition and error detection method	
6607	No ACK abnormality	The error is detected when no acknowledgement (ACK signal) is received after the transmission. (eg. When the data is transmitted six times in a row with 30 seconds interval, the error is detected on the transmission side.) Note: The address/attribute appeared on the display on the main remote controller indicates the controller where an error occurs.

Error source address	Error display	Detection method	Cause	Check method and remedy
Outdoor unit (OC)	Main remote controller (SC) MA remote controller (MA)	No acknowledgement (ACK) at IC transmission to OC	(1) Contact failure of transmission line of OC or IC (2) Decrease of transmission line voltage/signal by exceeding acceptable range of transmission wiring . Farthest: 200 m or less (3) Erroneous sizing of transmission line (Not within the range below). Wire diameter: 1.25mm ² or more (4) Indoor unit main board failure	Turn off the power source of the outdoor unit, and turn it on again. If the error is accidental, it will run normally. If not, check the causes (1) - (4).
Indoor unit (IC)	Main remote controller (SC) MA remote controller (MA)	No acknowledgement (ACK) at SC transmission to IC	1. Error occurrence on all IC in the system with one outdoor unit (1) Total capacity error (7100) (2) Capacity code error (7101) (3) Error in the number of connected units (7102) (4) Address setting error (7105) (5) Disconnection or short circuit of the transmission line for the outdoor unit on the terminal block for centralized control line connection (TB7) (6) Turn off the power source of the outdoor unit (7) Malfunction of electrical system for the outdoor unit	1) Check the LED display for troubleshooting on the outdoor unit. ->If an error is found, check the error code definition, and correct the error. ->If no error is found, check 2). 2) Check (5) - (7) on the left.
			2. Error occurrence on all IC (1) Same causes as (1) - (7) described in 1. (2) The male power supply connector is connected to the female power supply switch connector (CN40) for the transmission line for centralized control (3) Disconnection or shutdown of the power source of the power supply unit for transmission line (4) Main controller malfunction	Check voltage of the transmission line for centralized control. 20V or more : Check (1) and (2) on the left. Less than 20V : Check (3) on the left.

(2) Errors that are not limited to a particular system

Error Code	Error definition and error detection method			
6607 (Continued)	No ACK abnormality	The error is detected when no acknowledgement (ACK signal) is received after the transmission. (eg. When the data is transmitted six times in a row with 30 seconds interval, the error is detected on the transmission side.) Note: The address/attribute appeared on the display on the main remote controller indicates the controller where an error occurs.		
Error source address	Error display	Detection method	Cause	Check method and remedy
Address which should not be existed	-	-	Although the address of the main remote controller has been changed after the system settings are made on the main remote controller, the indoor unit is keeping the memory of the previous address.	Delete unnecessary information of non-existing address which some indoor units have. Use either of the following method for deletion. 1) Deletion of connection information of the outdoor unit by the deleting switch (1) Turn off the power source of the outdoor unit, and wait for 5 minutes. (2) Turn on the dip switch (SW2-2) on the outdoor unit main board. (3) Turn on the power source of the outdoor unit, and wait for 5 minutes. (4) Turn off the power source of the outdoor unit, and wait for 5 minutes. (5) Turn off the dip switch (SW2-2) on the outdoor unit main board. (6) Turn on the power source of the outdoor unit.

Error Code	Error definition and error detection method	Cause	Check method and remedy
6608	No response When no response command is returned although acknowledgement (ACK) is received after transmission, an error is detected. When the data is transmitted 10 times in a row with 3 seconds interval, an error is detected on the transmission side. Note: The address/attribute appeared on the display on the main remote controller indicates the controller where an error occurs.	(1) The transmission line work is performed or the polarity is changed while the power is on, the transmitted data will collide, and the wave shape will be changed. (2) The transmission is sent and received repeatedly due to noise. (3) Decrease of transmission line voltage/signal by exceeding acceptable range of transmission wiring. Farthest :200m or less (4) The transmission line voltage/signal is decreased due to erroneous sizing of transmission line. Wire diameter: 1.25mm ² or more	1) When an error occurs at commissioning Turn off the power source of the outdoor unit and indoor unit for 5 or more minutes, and turn them on again. -> When they return to normal operation, the cause of the error is the transmission line work performed with the power on. -> If an error occurs again, check the cause 2). 2) Check (3) and (4) on the left. -> If the cause is found, correct it. -> If no cause is found, check 3). 3) Check transmission wave shape/noise on transmission line by following <Investigation method of transmission wave shape/noise>. Noise is the most possible cause of the error "6602".

Error Code	Error definition and error detection method	Cause	Check method and remedy
6831	MA communication error or no reception error Communication between the MA remote controller and the indoor unit is not done properly. No proper data has been received for 3 minutes.	(1) Contact failure of the remote controller lines of MA remote controller or the indoor unit. (2) All the remote controllers are set to SUB. (3) Failure to meet wiring regulations •Wire length •Wire size •Number of remote controllers •Number of indoor units	1) Check for disconnected or loose transmission lines for the indoor units or MA remote controllers. 2) Confirm that the power is supplied to the main power source and the remote controller line. 3) Confirm that MA remote controller's capacity limit is not exceeded. 4) Check the sub/main setting of the MA remote controllers. One of them must be set to MAIN.
6834	MA communication error or start bit detection error Communication between the MA remote controller and the indoor unit is not done properly. No proper data has been received for 2 minutes.	(4) The remote controller is removed after the installation without turning the power source off. (5) Noise interference on the remote controller transmission lines (6) Faulty circuit that is on the indoor board and performs transmission/reception of the signal from the remote controller (7) Problems with the circuit on the remote controller that sends or receives the signals from the remote controller	5) Diagnose the remote controller (described in the remote controller installation manual). [OK]: no problems with the remote controller (check the wiring regulations) [NO]: Replace the MA remote controller. [6832, 6833, ERC]: due to noise interference <Go to (5)> 6) Check wave shape/noise on MA remote controller line by following <3. Investigation method of transmission wave shape/noise>.
6832	MA communication error or synchronization recovery error Communication between the MA remote controller and the indoor unit is not done properly. Failure to detect opening in the transmission path and unable to send signals Indoor unit : 3 minutes Remote controller : 6 seconds	(1) Contact failure of the remote controller lines of MA remote controller or the indoor unit. (2) 2 or more remote controllers are set to MAIN. (3) Overlapped indoor unit address (4) Noise interference on the remote controller lines (5) Failure to meet wiring regulations •Wire length •Wire size •Number of remote controllers •Number of indoor units	7) When no problems are found with items 1 through 6, replace the indoor unit board or the MA remote controller. The following status can be confirmed on LED1 and 2 on the indoor unit board. •LED1 is lit. The main power source of the indoor unit is turned on. •LED2 is lit. MA remote controller line is being powered.
6833	MA communication error or transmission/reception H/W error Communication between the MA remote controller and the indoor unit is not done properly. An error occurs when the transmitted data and the received data differ for 30 times in a row.	(6) Problems with the circuit on the remote controller that sends or receives the signals from the remote controller	

3. System error

Error Code	Error source	Error definition and error detection method	Cause	Check method and remedy						
7100	Outdoor unit	<p>Total capacity error</p> <p>The model total of indoor units in the system with one outdoor unit exceeds limitations.</p>	<p>The model total of indoor units in the system with one outdoor unit exceeds the following table.</p> <table border="1"> <thead> <tr> <th>Model</th> <th>Capacity Total</th> </tr> </thead> <tbody> <tr> <td>P250</td> <td>280</td> </tr> <tr> <td>P500</td> <td>560</td> </tr> </tbody> </table>	Model	Capacity Total	P250	280	P500	560	<p>1) Check the model total (capacity code total) of indoor units connected.</p> <p>2) Check the model name (capacity code) of the connected indoor unit set by the switch (SW2 on indoor unit board).</p> <p>When the model name set by the switch is different from that of the unit connected, turn off the power source of the outdoor and the indoor units, and change the setting of the model name (capacity code).</p>
Model	Capacity Total									
P250	280									
P500	560									
7101	Outdoor unit Indoor unit	<p>Capacity code error</p> <p>The model name (capacity code) of the connected indoor unit connected is inappropriate.</p>	<p>(1) The model names (model codes) of the connected indoor units are out of connectable range. Connectable range P250 (P250 model) P500 (P500 model)</p> <p>(2) The model name (capacity code) set by the switch (SW2) is wrong.</p>	<p>1) Check the model names (model codes) of the connected indoor units.</p> <p>2) Check the model name (capacity code) of the indoor unit which has the error source address set by the switch (SW2 on indoor unit board).</p> <p>When the model name set by the switch is different from that of the unit connected, turn off the power source of the outdoor and the indoor units, and change the setting of the capacity code.</p> <p>*The capacity of the indoor unit can be confirmed by the self-diagnosis function (SW1 operation) of the outdoor unit.</p>						
7102	Outdoor unit	<p>Error in the number of connected units</p> <p>The number of connected indoor units exceeds the allowable range.</p>	<p>(1) Number of indoor units connected to the outdoor terminal block (TB3) for indoor/outdoor transmission lines exceeds limitations described below.</p> <table border="1"> <thead> <tr> <th>Number of units</th> <th>Restriction on the number of units</th> </tr> </thead> <tbody> <tr> <td>Total number of indoor units</td> <td>Air-cooled=1</td> </tr> </tbody> </table> <p>(2) Disconnected transmission line of the outdoor unit</p> <p>(3) Short-circuited transmission line</p>	Number of units	Restriction on the number of units	Total number of indoor units	Air-cooled=1	<p>1) Check whether the number of units connected to the outdoor terminal block (TB3) for indoor/outdoor transmission lines does not exceed the limitation. (See (1) and (2) on the left.)</p> <p>2) Check (2) - (3) on the left.</p> <p>3) Check whether the transmission line for the terminal block for centralized control (TB7) is not connected to the terminal block for the indoor/outdoor transmission line (TB3).</p>		
Number of units	Restriction on the number of units									
Total number of indoor units	Air-cooled=1									
7105	Outdoor unit	<p>Address setting error</p> <p>Erroneous setting of OC unit address</p>	<p>Erroneous setting of OC unit address</p> <p>The address of outdoor unit is not being set to 51 - 100.</p>	<p>Check that the address of OC unit is set to 51- 100. Reset the address if it stays out of the range, while shutting the power source off.</p>						

Error Code	Error source	Error definition and error detection method	Cause	Check method and remedy
7110		The indoor unit cannot be operated as the connection between indoor units in the system is not normal.	(1) Shutdown of the power of the power supply extension unit for transmission line (2) Power reset of the power supply extension unit for transmission line and of the outdoor unit	Check that the power supply of the power supply extension unit for transmission line is connected to the switch of the indoor unit, and that the power is not shutdown. (The unit does not operate normally if the power supply of the power supply extension unit for transmission line is not turned on. -> Reset the power of the outdoor unit.)
7111	Indoor unit OA processing unit	Remote controller sensor failure This error occurs when the temperature data is not sent although the remote controller sensor is specified.	The remote controller without the temperature sensor (the wireless remote controller or the M-NET compact remote controller (mounted type)) is used and the remote controller sensor for the indoor unit is specified. (SW1-1 is ON.)	Replace the remote controller with the one with built-in temperature sensor.
7113	Outdoor unit	Model setting error Function setting error due to resistance	(1) Faulty wiring (2) Disconnected connector, short-circuit, or contact failure (3) The type of the INV circuit board is not applicable to the compressor. (Replaced wrongly) (4) Wrong setting of the main circuit board of the system unit	1) Check the connector on the main circuit board and the connectors of CNTYP 1, 4, and 5. 2) Check the type of the replaced INV circuit board. If it is not applicable to the compressor, replace the board. 3) Check that the DipSW5-8 on the main circuit board of the system unit is OFF. If it is ON, turn it OFF.
7116	Outdoor unit	Replace Multi setting error The refrigerant pipe has not been washed.	Wrong settings are made on the function selection switch (SW4-3). "Replace" is set.	Check that the SW4-3 on the main circuit board is OFF.
7117	Outdoor unit	Model setting error	(1) Faulty wiring (2) Disconnected connector, short-circuit, or contact failure	Check for the contact of the connector CNTYP1, 4, 5 on the main board.
7130	Outdoor unit Indoor unit	Incompatible units	(1) The indoor unit that uses R22 or R407C refrigerant is connected (2) The wrong unit model is connected. (3) The ROM on the outdoor unit has not been rewritten. (The ROM on the outdoor unit to be connected to the PFD-type indoor unit must be written.)	1) Check the connected indoor unit model. 2) Check the S/W version.

4. Troubleshooting according to malfunction of the remote controller/main remote controller or the external input error

(1) In the case of MA remote controller

	Phenomena	Cause	Check method and remedy
1	Even if the operation button on the remote controller is pressed, the display remains unlit and the unit does not start running.(Power indicator  does not appear on the screen.)	<ol style="list-style-type: none"> 1. The power is not supplied to the indoor unit. <ol style="list-style-type: none"> (i) The main power of the indoor unit is not on. (ii) The connector (CND, CNT, CN3T) on the indoor unit board has come off. (iii) The fuse on the indoor unit board has melted. (iv) Transformer failure and disconnected wire of the indoor unit. 2. Incorrect wiring for the MA remote controller <ol style="list-style-type: none"> (i) Disconnected wire for the MA remote controller or disconnected line to the terminal block. (ii) Short-circuited MA remote controller wiring (iii) Reversed wiring between wiring numbers of the MA remote controller wiring (iv) Incorrect wiring for the MA remote controller to the terminal block for transmission line connection (TB5) on the indoor unit (v) Reversed connection of the wire for the MA remote controller and the AC220~240V power wire (vi) Reversed connection of the wire for the MA remote controller and the M-NET transmission line on the indoor unit 3. The number of the MA remote controllers that are connected to an indoor unit exceeds the allowable range (2 units). 4. The length or the diameter of the wire for the MA remote controller are out of specification. 5. Short circuit of the wire for the remote display output of the outdoor unit or reversed polarity connection of the relay. 6. The indoor unit board failure 7. MA remote controller failure 	<ol style="list-style-type: none"> (1) Measure voltages of the MA remote controller terminal (among A to B). <ul style="list-style-type: none"> •If the voltage is between DC 8.5 and 12V, the remote controller is a failure. •If no voltage is applied Check 1. 3. described on the left. If the cause is found, correct it. If no cause is found, refer to 2). (2) Remove the wire for the remote controller from the terminal block (TB13) on the MA remote controller for the indoor unit, and check voltage among A to B. <ul style="list-style-type: none"> •If the voltage is between DC 8.5 and 12V Check the 2. 4. described on the left. <ul style="list-style-type: none"> •If no voltage is applied Check 1. described on the left. If the cause is found, correct it. If no cause is found, check the wire for the remote display output (the relay polarity). If no further cause is found, replace the indoor unit board.

	Phenomena	Cause	Check method and remedy
2	When the remote controller operation SW is turned on, the operation status briefly appears on the display, then it goes off, and the display lights out immediately, and the unit stops.	<ol style="list-style-type: none"> 1. The power for the M-NET transmission line is not supplied from the outdoor unit. <ol style="list-style-type: none"> (i) The main power of the outdoor unit is not turned on. (ii) The connector on the circuit board of the outdoor unit is disconnected. <ul style="list-style-type: none"> ♦Main circuit board: CNS1, CNVCC3 ♦INV circuit board: CNDC2, CNVCC2, CNL2 ♦Gate-amp board:CNDC1 (iii) The power supply circuit of the outdoor unit is faulty. <ul style="list-style-type: none"> ♦Blown fuse (F01) on the G/A board ♦Damaged diode stack ♦Faulty INV circuit board ♦Damaged rush current protection resistor (R11, R12) 2. Short circuit of the transmission line. 3. Incorrect wiring of the M-NET transmission line on the outdoor unit. <ul style="list-style-type: none"> ♦Disconnected wire for the MA remote controller or disconnected line to the terminal block. ♦The indoor transmission line is connected incorrectly to the transmission terminal block for centralized controller (TB7). 4. Disconnected M-NET transmission line on the indoor unit side. 5. Disconnected wire between the terminal block for M-NET line (TB5) of the indoor unit and the indoor unit board (CN2M) or disconnected connector. 	<ol style="list-style-type: none"> (1) If the causes 1-5 apply, LED5 (M-NET transmission voltage display) on the indoor controller circuit board will be turned off. (2) When 2. and 3. apply, error code 7102 will be displayed on the self-diagnosis LED.

Check method and remedy

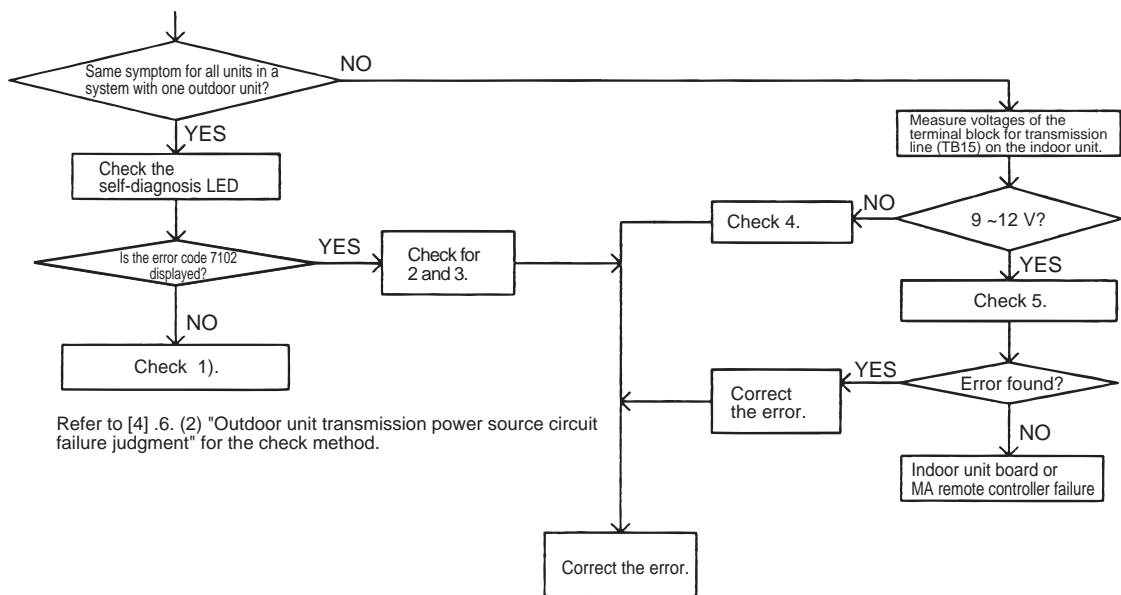

	Phenomena	Cause
3	<p>"HO" display on the remote controller does not disappear, and no operation is performed even if the button is pressed.</p>	<ol style="list-style-type: none"> 1. The power for the M-NET transmission line is not supplied from the outdoor unit. <ol style="list-style-type: none"> (i) The main power of the outdoor unit is not turned on. (ii) The connector on the circuit board of the outdoor unit is disconnected. <ul style="list-style-type: none"> •Main circuit board:CNS1, CNVCC3 •INV circuit board:CNDC2, CNVCC2, CNL2 •Gate-amp board:CNDC1 (iii) The power supply circuit of the outdoor unit is faulty. <ul style="list-style-type: none"> •Blown fuse (F01) on the G/A board •Damaged diode stack •Faulty INV circuit board •Damaged rush current protection resistor (R11, R12) 2. Short circuit of the transmission line. 3. Incorrect wiring of the M-NET transmission line on the outdoor unit. <ul style="list-style-type: none"> •Disconnected wire or disconnected line to the terminal block. •The indoor transmission line is connected incorrectly to the transmission terminal block for centralized controller (TB7). 4. Disconnected M-NET transmission line on the indoor unit side. 5. Disconnected wire between the terminal block for M-NET line (TB5) of the indoor unit and the indoor unit board (CN2M) or disconnected connector. 6. Incorrect wiring for the MA remote controller <ul style="list-style-type: none"> •Short-circuited wire for the MA remote controller •Disconnected wire for the MA remote controller (No.2) and disconnected line to the terminal block. •Reversed daisy-chain connection between groups •Incorrect wiring for the MA remote controller to the terminal block for transmission line connection (TB5) on the indoor unit •The M-NET transmission line is connected incorrectly to the terminal block (TB15) for the MA remote controller. 7. The address of the outdoor unit is "the address of the indoor unit + 50 or more". 8. The address of the indoor unit is 51 or more. 9. The sub/main setting of the MA remote controller is set to sub. 10. Indoor unit board failure (MA remote controller communication circuit) 11. Remote controller failure <p>(1) If the causes 1-4 apply, LED5 (M-NET transmission voltage display) on the indoor controller circuit board will be turned off. (2) When 2, 3, and 5. apply, error code 7102 will be displayed on the self-diagnosis LED.</p>

Check method and remedy

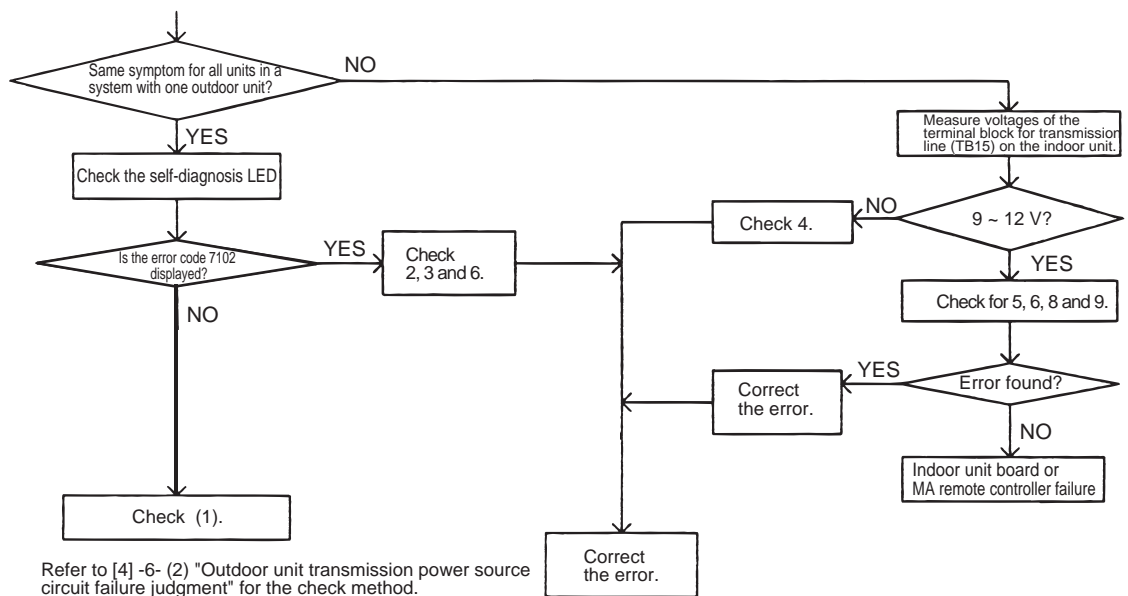

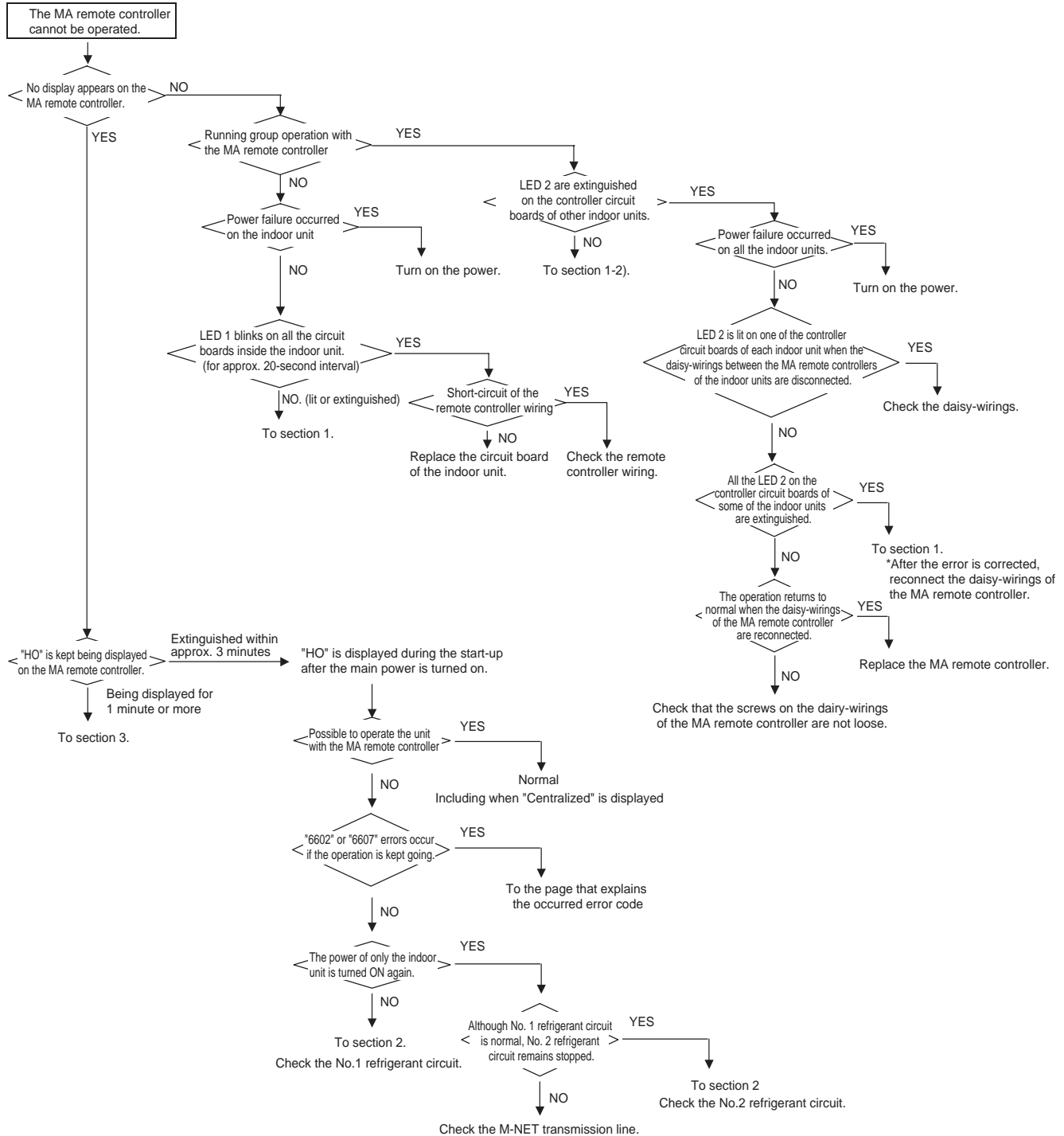

Flow chart

Flowchart when the MA remote controller cannot be operated



(2) In case of main remote controller

	Phenomena	Cause	Check method and remedy
1	Although cooling operation starts with the normal remote controller display, the capacity is not enough	<p>1. Compressor frequency does not rise sufficiently.</p> <ul style="list-style-type: none"> ♦Wrong detection of the temperature of TH22 (Te) ♦Compressor frequency is limited due to high discharge temperature ♦Compressor frequency is limited due to high pressure ♦Pressure drops excessively. 	<p>(1) Check the pressure difference between the inlet temperature (TH22) and the actual temperature by monitoring with LED.</p> <p>->If the accurate inlet temperature is not detected, check the thermistor (Refer to the page on error code 5102.).</p> <p>Note: Lower inlet temperature (TH22) than the actual temperature causes insufficient capacity</p> <p>(2) Check temperature difference between the evaporating temperature (Te) and the target evaporating temperature (Tem) with self-diagnosis LED.</p> <p>Note: Higher Te than Tem causes insufficient capacity.</p> <p>SW1 setting</p> <p>Evaporating temperature Te</p>  <p>Target evaporating temperature Tem</p>  <p>Note: Protection works and compressor frequency does not rise even at higher Te than Tem due to high discharge temperature and high pressure.</p> <p>At high discharge temperature: Refer to 1102.</p> <p>At high pressure: Refer to 1302.</p>
		<p>2. Indoor unit LEV malfunction</p> <ul style="list-style-type: none"> ♦Insufficient refrigerant flows due to LEV malfunction (not enough opening) or protection works and compressor frequency does not rise due to pressure drop. 	<p>Refer to the page of LEV troubleshooting (9. [4] -5-).</p>
		<p>3. RPM error of the outdoor unit FAN (Only for air-cooled outdoor units)</p> <ul style="list-style-type: none"> ♦Motor failure or board failure, or airflow rate decrease due to clogging of the heat exchanger ♦The fan is not properly controlled as the outdoor temperature cannot be precisely detected by the temperature sensor. ♦The fan is not properly controlled as the pressure cannot be precisely detected by the pressure sensor. 	<p>Refer to the page on troubleshooting of the outdoor unit fan.</p> <p>Refer to 5106.</p> <p>Refer to 1302.</p>

	Phenomena	Cause	Check method and remedy
1	Although cooling operation starts with the normal remote controller display, the capacity is not enough.	4. Long piping length The cooling capacity varies greatly depending on the pressure loss.	Confirm that the characteristic of capacity drop due to piping length. The piping pressure loss can be assumed by temperature difference between the heat exchanger inlet temperature and low pressure saturation temperature. -> Change the pipe.
		5. Piping size is not proper (thin)	
		6. Insufficient refrigerant amount Protection works and compressor frequency does not rise due to high discharge temperature.	Refer to 1-1. (Compressor frequency does not rise sufficiently.) Refer to the page on refrigerant amount adjustment
		7. Clogging by foreign object	Check the temperature difference between in front of and behind the place where a foreign object is clogged (e.g. strainer, distributor). If the temperature drop is large, a foreign object is clogged. -> Remove the foreign object inside the pipe.
		8. The indoor unit inlet temperature is excessively. (Less than 11°C WB)	Check the inlet air temperature and for short cycling. Change the environment where the indoor unit is used.
		9. Compressor failure The amount of circulating refrigerant decreases due to refrigerant leak in the compressor.	Check the discharge temperature to determine if the refrigerant leaks, as it rises if there is a leak.
		10. High/low pressure bypass due to solenoid valve failure	Refer to the page on troubleshooting of the solenoid valve.
		11. LEV1 malfunction Sufficient liquid refrigerant is not be supplied to the indoor unit as sufficient sub cool cannot be secured due to LEV1 malfunction.	Refer to the page of LEV troubleshooting (9. [4] -5-). It most likely happens when there is little difference or no difference between TH5 and TH7.
		12. TH5, TH7, TH2, TH8 and 63HS sensor failure or faulty wiring LEV1 is not controlled normally.	<ul style="list-style-type: none"> •Check the thermistor. •Check wiring.
13. Dirt on the heat exchanger and short cycle			
2	Outdoor unit stops at times during operation.	<p>The first stop is not considered as an error, as the unit turns to anti-restart mode for 20 seconds as a preliminary error.</p> <p>Error mode</p> <ul style="list-style-type: none"> (i) Abnormal high pressure (ii) Abnormal discharge air temperature (iii) Heatsink thermistor failure (iv) Thermistor failure (v) Pressure sensor failure (vi) Over-current break (vii) Refrigerant overcharge <p>Note: Frost prevention tripping may be considered in addition to the above.</p> <p>Note: Even the second stop is not considered as an error when some specified errors occur. (eg. The third stop is considered as an error when the thermistor error occurs.)</p>	<p>(1) Check the mode operated in the past by displaying preliminary error history on LED display with SW1.</p> <p>(2) Reoperate the unit to find the mode that stops the unit by displaying preliminary error history on LED display with SW1. Refer to the reference page for each error mode.</p> <p>*Display the indoor piping temperature table with SW1 to check whether the freeze proof operation runs properly, and check the temperature.</p>

(3) In case of external input (including operation mode)

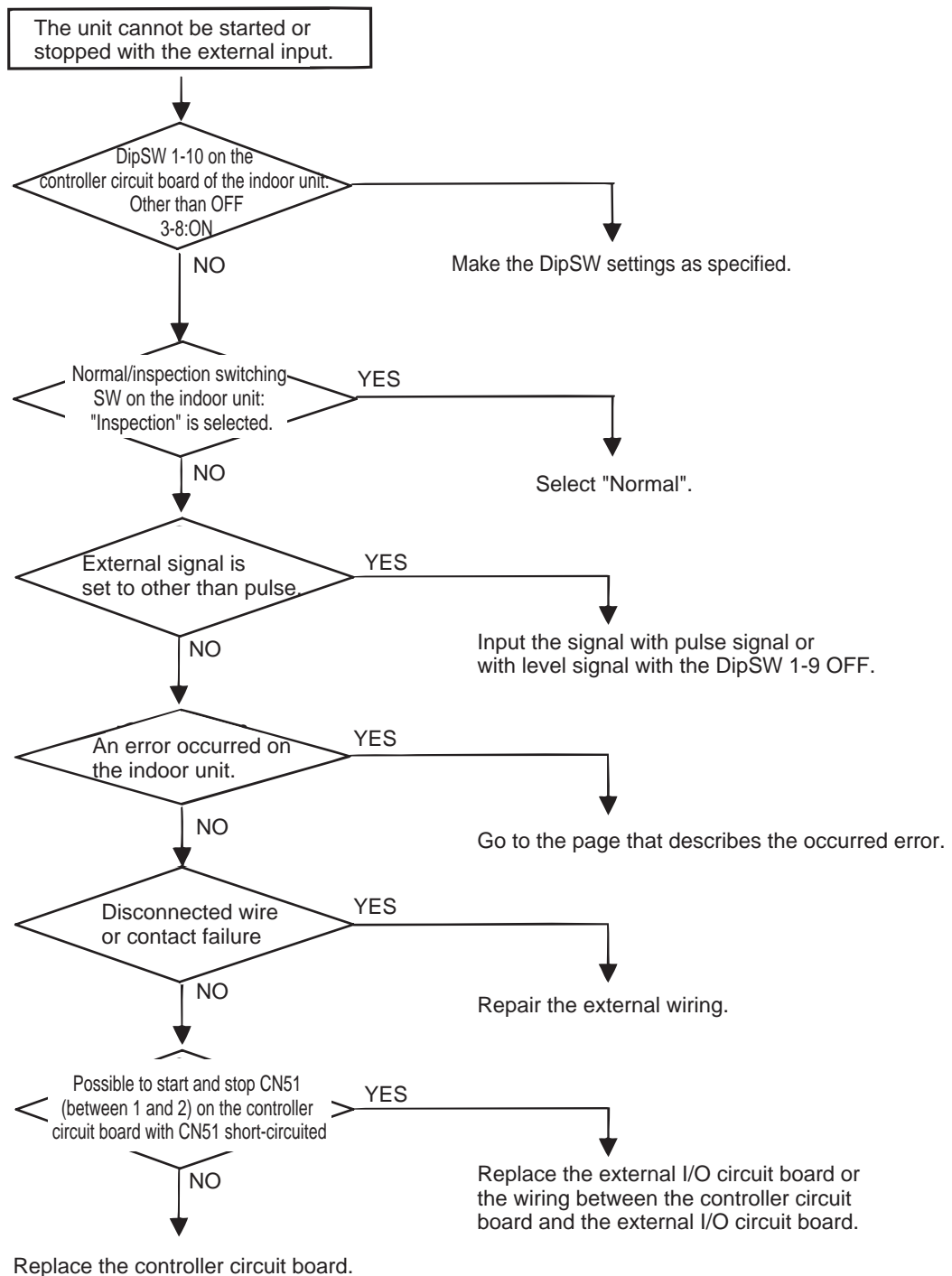

[3] Investigation of Transmission Wave Shape/Noise

1. M-NET transmission

Control is performed by exchanging signals between the outdoor unit and the indoor unit (M-NET remote controller) through M-NET transmission. Noise interference on the transmission line will interrupt the normal transmission, leading to erroneous operation.

(1) Symptoms caused by noise interference on the transmission line

Cause	Erroneous operation	Error code	Error code definition
Noise interference on the transmission line	Signal is transformed and will be misjudged as the signal of another address.	6600	Address overlaps
	Transmission wave pattern is transformed due to the noise creating a new signal	6602	Transmission processor hardware error
	Transmission wave pattern is transformed due to the noise, and will not be received normally leading to no acknowledgement (ACK).	6607	No ACK
	Transmission cannot be performed due to the fine noise.	6603	Transmission circuit bus-busy
	Transmission is successful; however, the acknowledgement (ACK) or the response cannot be received normally due to the noise.	6607 6608	No ACK No response

(2) Wave shape check

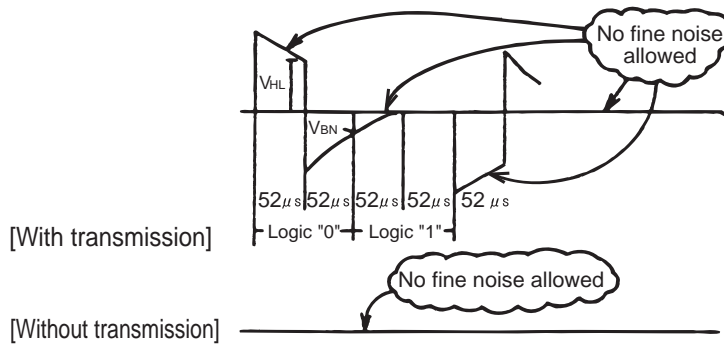

Check the wave pattern of the transmission line with an oscilloscope. The following conditions must be met.

- 1) Small wave pattern (noise) must not exist on the transmission signal. Minute noise (approximately 1V) can be generated by DC-DC converter or the inverter operation; however, such noise is not a problem when the shield of the transmission line is grounded.
- 2) The sectional voltage level of transmission signal should be as follows.

Logic	Voltage level of the transmission line
0	$V_{HL} = 2.0V$ or higher
1	$V_{BN} = 1.3V$ or below

(3) Check method and remedy

1) Measures against noise

Check the followings when noise exists on the wave or the errors described in (1) occur.

	Error code definition	Remedy
Check that the wiring work is performed according to wiring specifications.	1. The transmission line and the power 220~240 V line are not wired too closely.	Isolate the transmission line from the power line (5cm or more). Do not insert them in the same Do not insert them in the same conduit.
	2. The transmission line is not bundled with that for another systems.	The transmission line must be isolated from another transmission line. When they are bundled, erroneous operation may be caused.
	3. The specified wire is used for the transmission line.	Use the specified transmission line. Type: Shielded wire CVVS/CPEVS/MVVS (For M-NET remote controller) Diameter: 1.25mm ² or more (Remote controller wire: 0.5 - 1.25mm ²)
	4. When the transmission line is daisy-chained on the indoor unit terminals, are the shields daisy-chained on the terminals, too?	The transmission is two-wire daisy-chained. The shielded wire must be also daisy-chained. When the shielded cable is not daisy-chained, the noise cannot be reduced enough.
Check that the grounding work is performed according to grounding specifications.	5. Is the grounding of the shield of the transmission line (for indoor unit control) provided on the indoor unit?	One point grounding must be provided on the outdoor unit. If no grounding is provided, the noise on the transmission line cannot escape leading to change of the transmission signal.
	6. Check the treatment method of the shield of the transmission line (for centralized control).	When group operation of indoor units connected to different outdoor units is performed, provide grounding of the shield of the transmission line for centralized control at the point of outdoor unit, and when the system controller is used, provide grounding at the point of the system controller, so that the effect of noise can be minimized. The environment against noise varies depending on the distance of the transmission lines, the number of the connected units, the type of the controllers to be connected, or the environment of the installation site. Therefore, the transmission line work for centralized control must be performed as follows. (1) When no grounding is provided •Group operation of indoor units connected to different outdoor units: One point grounding on one outdoor unit (power supply unit) •Use of MELANS: Grounding on the main controller (power supply device) (2) When an error occurs even though one point grounding is provided: Ground the shield on all outdoor units.

2) Check the followings when the error "6607" occurs, or "HO" appears on the display on the remote controller.

Error code definition	Remedy
7. The farthest distance of transmission line is 200m or longer.	Check that the farthest distance from the outdoor unit to the indoor unit and to the remote controller is within 200m.
8. The types of transmission lines are different.	Use the specified transmission line. Type: Shielded wire CVVS/CPEVS/MVVS (For M-NET remote controller) Diameter: 1.25mm ² or more (Remote controller wire: 0.5 - 1.25mm ²)
9. Check the state of the choke coil on the transmission power supply circuit.	When resistance of the choke coil (L2) is between 0.5 and 2.6 ohm, the choke coil is normal. When resistance (R3) on the outdoor unit MAIN board is 1kohm \pm 5%, it is normal. Connectors CNS1 and CNS2 must be removed when resistance is measured.
10. Indoor unit or remote controller failure	Replace the indoor unit controller board or the remote controller.

2. MA remote controller transmission

The communication between the MA remote controller and the indoor unit is performed with current tone burst.

(1) Symptoms caused by noise interference on the transmission line

If noise is generated on the transmission line, and the communication between the MA remote controller and the indoor unit is interrupted for 3 minutes in a row, MA transmission error (6831) will occur.

(2) Confirmation of transmission specifications and wave pattern

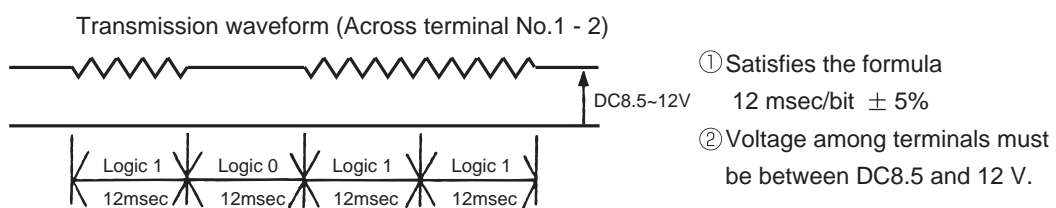
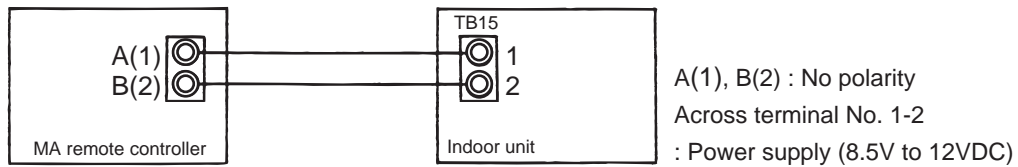

[4] Troubleshooting Principal Parts

-1- High-Pressure Sensor (63HS)

1. Compare the pressure that is detected by the high pressure sensor, and the high-pressure gauge pressure to check for failure.

Set the digital display switch (SW1) as shown below to display the pressure that is detected by the high pressure sensor on the light emitting diode.

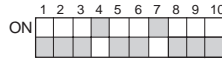

- (1) While the sensor is stopped, compare the gauge pressure and the pressure displayed on self-diagnosis LED1.
 - 1) When the gauge pressure is between 0 and 0.098MPa, internal pressure is caused due to gas leak.
 - 2) When the pressure displayed on self-diagnosis LED1 is between 0 and 0.098MPa, the connector may be defective or be disconnected. Check the connector and go to (4).
 - 3) When the pressure displayed on self-diagnosis LED1 exceeds 4.15MPa, go to (3).
 - 4) If other than 1), 2) or 3), compare the pressures while the sensor is running. Go to (2).
- (2) Compare the gauge pressure and the pressure displayed on self-diagnosis LED1 while the sensor is running. (Compare them by MPa unit.)
 - 1) When the difference between both pressures is within 0.098MPa, both the high pressure sensor and the main board are normal.
 - 2) When the difference between both pressures exceeds 0.098MPa, the high pressure sensor has a problem. (performance deterioration)
 - 3) When the pressure displayed on self-diagnosis LED1 does not change, the high pressure sensor has a problem.
- (3) Remove the high pressure sensor from the main board to check the pressure on the self-diagnosis LED1.
 - 1) When the pressure displayed on self-diagnosis LED1 is between 0 and 0.098MPa, the high pressure sensor has a problem.
 - 2) When the pressure displayed on self-diagnosis LED1 is approximately 4.15MPa, the main board has a problem.
- (4) Remove the high pressure sensor from the main board, and short-circuit between the No.2 and 3 connectors (63HS) to check the pressure with self-diagnosis LED1.
 - 1) When the pressure displayed on the self-diagnosis LED1 exceeds 4.15MPa, the low pressure sensor has a problem.
 - 2) If other than 1), the main board has a problem.

2. Pressure sensor configuration

The high pressure sensor consists of the circuit shown in the figure below. If DC 5V is applied between the red and the black wires, voltage corresponding to the pressure between the white and the black wires will be output, and the value of this voltage will be converted by the microcomputer. The output voltage is 0.071V per 0.098MPa.

*The pressure sensor on the body side is designed to connect to the connector.

The connector pin number on the body side is different from that on the main board side.

	Body side	Main board side
Vcc	Pin 1	Pin 3
Vout	Pin 2	Pin 2
GND	Pin 3	Pin 1

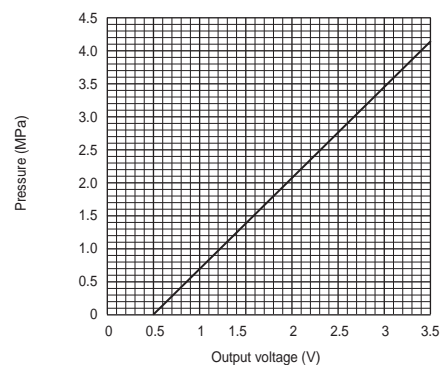
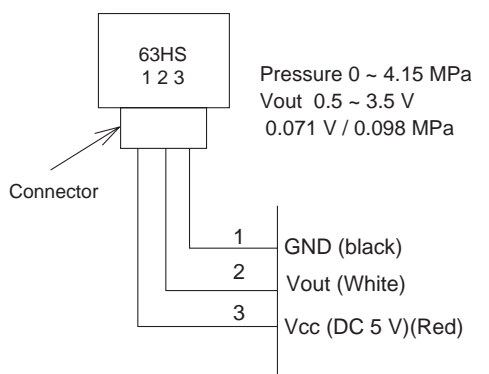

-2- Low-Pressure Sensor (63LS)

1. Compare the pressure that is detected by the low pressure sensor, and the low pressure gauge pressure to check for failure.

Set the digital display switch (SW1) as shown below to display the pressure that is detected by the low pressure sensor on the self-diagnosis LED.

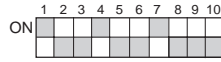

- (1) While the sensor is stopped, compare the gauge pressure and the pressure displayed on self-diagnosis LED1.
 - 1) When the gauge pressure is between 0 and 0.098MPa, internal pressure is caused due to gas leak.
 - 2) When the pressure displayed on self-diagnosis LED1 is between 0 and 0.098MPa, the connector may be defective or be disconnected. Check the connector and go to (4).
 - 3) When the pressure displayed on self-diagnosis LED1 exceeds 1.7MPa, go to (3).
 - 4) If other than 1), 2) or 3), compare the pressures while the sensor is running. Go to (2).
- (2) Compare the gauge pressure and the pressure displayed on self-diagnosis LED1 while the sensor is running.(Compare them by MPa unit.)
 - 1) When the difference between both pressures is within 0.03MPa, both the low pressure sensor and the main board are normal.
 - 2) When the difference between both pressures exceeds 0.03MPa, the low pressure sensor has a problem. (performance deterioration)
 - 3) When the pressure displayed on the self-diagnosis LED1 does not change, the low pressure sensor has a problem.
- (3) Remove the low pressure sensor from the main board to check the pressure with the self-diagnosis LED1 display.
 - 1) When the pressure displayed on the self-diagnosis LED1 is between 0 and 0.098MPa, the low pressure sensor has a problem.
 - 2) When the pressure displayed on self-diagnosis LED1 is approximately 1.7MPa, the main board has a problem.
 - When the outdoor temperature is 30°C or less, the main board has a problem.
 - When the outdoor temperature exceeds 30°C, go to (5).
- (4) Remove the low pressure sensor from the main board, and short-circuit between the No.2 and 3 connectors (63LS) to check the pressure with the self-diagnosis LED1.
 - 1) When the pressure displayed on the self-diagnosis LED1 exceeds 1.7MPa, the low pressure sensor has a problem.
 - 2) If other than 1), the main board has a problem.
- (5) Remove the high pressure sensor (63HS) from the main board, and insert it into the connector for the low pressure sensor (63LS) to check the pressure with the self-diagnosis LED1.
 - 1) When the pressure displayed on the self-diagnosis LED1 exceeds 1.7MPa, the main board has a problem.
 - 2) If other than 1), the main board has a problem.

2. Pressure sensor configuration

The low pressure sensor consists of the circuit shown in the figure below. If DC5V is applied between the red and the black wires, voltage corresponding to the pressure between the white and the black wires will be output, and the value of this voltage will be converted by the microcomputer. The output voltage is 0.173V per 0.098MPa.

*The pressure sensor on the body side is designed to connect to the connector.

The connector pin number on the body side is different from that on the main board side.

	Body side	Main board side
Vcc	Pin 1	Pin 3
Vout	Pin 2	Pin 2
GND	Pin 3	Pin 1

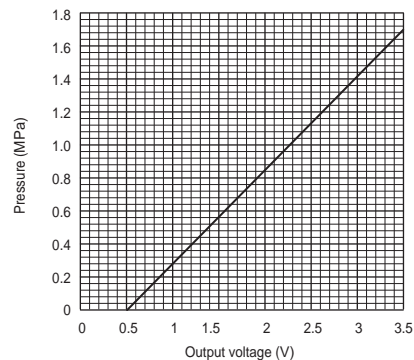
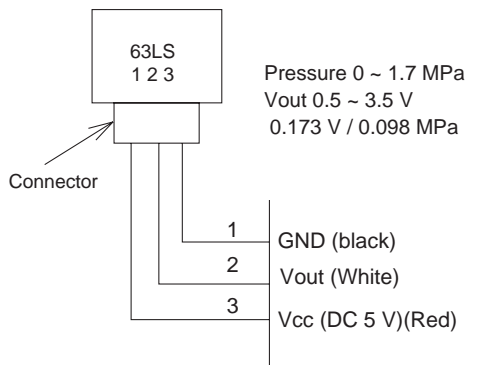

-3- Solenoid Valve

Check whether the output signal from the control board and the operation of the solenoid valve match.

Setting the self-diagnosis switch (SW1) as shown in the figure below causes the ON signal of each relay to be output to the LED's.

Each LED shows whether the relays for the following parts are ON or OFF.

*The circuits on some parts are closed when the relays are ON. Refer to the following instructions.

SW1										Display								
1 2 3 4 5 6 7 8 9 10										LD1	LD2	LD3	LD4	LD5	LD6	LD7	LD8	
ON	1	2	3	4	5	6	7	8	9	10	21S4a	21S4b	21S4c	CH11	CH12			
ON	1	2	3	4	5	6	7	8	9	10	SV1		SV3					
ON	1	2	3	4	5	6	7	8	9	10		SV5b	SV5c					52F

When a valve malfunctions, check if the wrong solenoid valve coil is not attached the lead wire of the coil is not disconnected, the connector on the board is not inserted wrongly, or the wire for the connector is not disconnected.

(1) In case of 21S4a (4-way switching valve)

About this 4-way valve

When not powered:

The electricity runs between the oil separator exit and the heat exchanger (in case of P500 model), between HEX1a and 2a (heat exchanger on the right (as you face the front of the unit)), and between the gas ball valve (BV1) and the accumulator. This circulation is for cooling.

When powered:

The electricity runs between the oil separator and the gas ball valve, and between the heat exchanger and the accumulator. This circulation is for heating.

Check the LED display and the intake and the discharge temperature for the 4-way valve to check whether the valve has no faults and the electricity runs between where and where. Do not touch the pipe when checking the temperature, as the pipe on the oil separator side will be hot.

*Do not give an impact from outside, as the outer hull will be deformed leading to the malfunction of the inner valve.

(2) In case of 21S4b (4-way switching valve)

About this 4-way valve

When not powered:

The electricity runs between the oil separator exit and the heat exchanger (in the case of P500 model), and between HEX1b and 2b (heat exchanger on the left (as you face the front of the unit)).

When powered:

The electricity runs between the heat exchanger and the accumulator, and the valve opens or closes the heat exchanger circuit when cooling or heating.

Check the LED display and the switching sound to check whether the valve has no faults, however, it may be occasionally difficult to check by the sound, as the switching coincides with 21S4a and 21S4b. In this case, check the intake and the discharge temperature for the 4-way valve to check that the electricity runs between where and where.

*Do not touch the valve when checking the temperature, as it will be hot.

*Do not give an impact from outside, as the outer hull will be deformed leading to the malfunction of the inner valve.

(3) In case of 21S4c (4-way switching valve) (Only P500 model)

About this 4-way valve

When not powered:

The electricity runs between the oil separator exit and the heat exchanger (in the case of P500 model), and between HEX1b and 2b (heat exchanger on the left (as you face the front of the unit)).

When powered:

The electricity runs between the heat exchanger and the accumulator, and the valve opens or closes the heat exchanger circuit when cooling or heating.

Check the LED display and the switching sound to check whether the valve has no faults, however, it may be occasionally difficult to check by the sound, as the switching coincides with 21S4a and 21S4c. In this case, check the intake and the discharge temperature for the 4-way valve to check that the electricity runs between where and where.

*Do not touch the valve when checking the temperature, as it will be hot.

*Do not give an impact from outside, as the outer hull will be deformed leading to the malfunction of the inner valve.

(4) In case of SV1 (Bypass valve)

This solenoid valve opens when powered (Relay ON).

- 1) At compressor start-up, the SV1 turns on for 4 minutes, and the operation can be checked by the self-diagnosis LED display and the closing sound.
- 2) To check whether the valve is open or closed, check the change of the SV1 downstream piping temperature while the valve is being powered. Even when the valve is closed, high-temperature refrigerant flows inside the capillary next to the valve.
(Therefore, temperature of the downstream piping will not be low with the valve closed.)

(5) In case of SV3 (Bypass valve) (Only P500 model)

This solenoid valve opens when powered (Relay ON).

The valve is normally powered while No.2 Comp is being stopped. (When the discharge temperature of No.1 Comp exceeds 110°C, the valve may be turned off.)

To check whether the valve is open or closed, check the change of the SV3 downstream piping temperature while the valve is being powered. When the valve is open, high-temperature gas will run. Do not touch the pipe when checking the temperature.

(6) In case of SV5b (2-way switching valve)

This 2-way valve is closed when powered. Check the LED display and the switching sound to check whether the valve has no faults. When cooling, the switching coincides with 21S4b. When it is difficult to check by the sound, check the temperature at the front and the back of the pipe to check whether the refrigerant is flowing.

*Do not give an impact from the outside, as the outer hull will be deformed, leading to the malfunction of the inner valve.

(7) In case of SV5c (2-way switching valve) (Only P500 model)

This 2-way valve is closed when powered. Check the LED display and the switching sound to check whether the valve has no faults. When cooling, the switching coincides with 21S4b. When it is difficult to check by the sound, check the temperature at the front and the back of the pipe to check whether the refrigerant is flowing.

*Do not give an impact from the outside, as the outer hull will be deformed, leading to the malfunction of the inner valve.

-4- Outdoor Unit Fan

- To check the revolution of the fan, check the inverter output state on the self-diagnosis LED, as the inverter on the outdoor fan controls the revolutions of the fan.The revolution of the fan is approximately 600rpm at full speed.
- When starting the fan, the fan runs at full speed for 5 seconds.
- For the 2 fans for P500 model, the fan on the right (as you face the fan) runs at all times and the fan on the left runs when required.(When heating except for defrost, both fans run.)
- When setting the DIP SW1 as shown in the figure below, the inverter output [%] will appear. 100% indicates the full speed and 0% indicates the stopping.

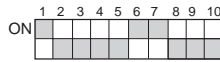

- As the revolution of the fan changes under control, at the interphase or when the indoor unit operation capacity is low, the revolution of the fan may change.
- When the fan does not work or an abnormal vibration occurs, the FAN board has a problem, or the fan motor runs under open phase or opposite phase. (The microcomputer detects the open phase or the opposite phase of the main power source; however, these malfunctions)
- When the only one of the fans is running and the other fan is stopped, check the 52F output state on the self-diagnosis LED first and check the fan connector and 52F connector misconnection, 52F failure, or the lead wire disconnection.

-5- LEV

LEV operation

The LEV (indoor: linear expansion valve), SLEV1, and LEV1 receive pulse signal from the indoor and outdoor main circuit boards, and drive the valve by stepping motor.

(1) Indoor unit LEV

The valve opening changes according to the number of pulses.

<Connections between the indoor/outdoor control board and LEV (indoor expansion valve)>

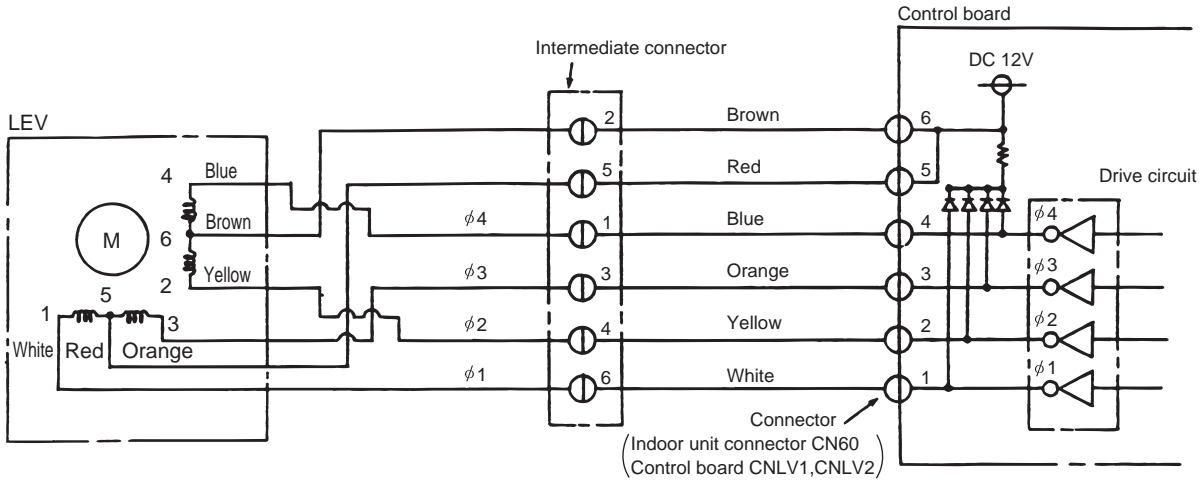

Note. The connector numbers on the intermediate connector and the connector on the control board differ. Check the color of the lead wire to judge the number.

Pulse signal output and valve operation

Output (phase) number	Output state			
	1	2	3	4
φ 1	ON	OFF	OFF	ON
φ 2	ON	ON	OFF	OFF
φ 3	OFF	ON	ON	OFF
φ 4	OFF	OFF	ON	ON

Output pulses change in the following orders when the Valve is closed; 1 → 2 → 3 → 4 → 1
Valve is open; 4 → 3 → 2 → 1 → 4

- *1. When the LEV opening angle does not change, all the output phases will be off.
- *2. When the output is open phase or remains ON, the motor cannot run smoothly, and rattles and vibrates.

LEV valve closing and opening operation

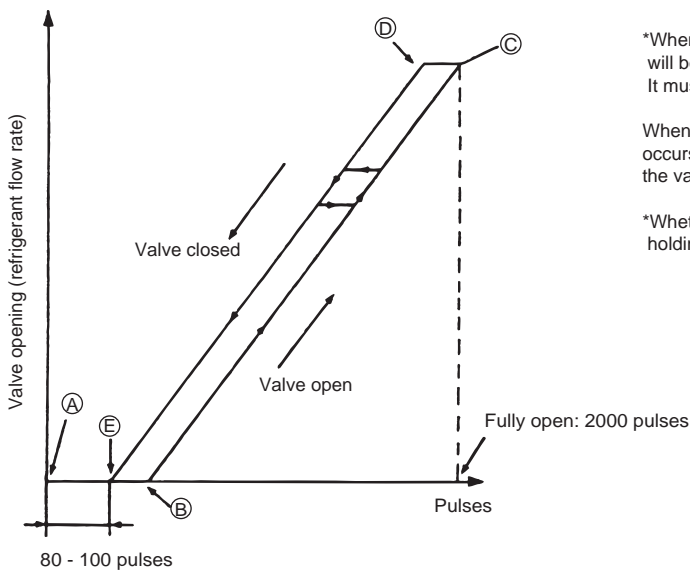

*When the power is turned on, the valve closing signal of 2200 pulses will be output from the indoor board to LEV to fix the valve position. It must be fixed at point (A)

When the valve operates smoothly, no sound from LEV or no vibration occurs, however, when the pulses change from (E) to (A) in the chart or the valve is locked, a big sound occurs.

*Whether a sound is generated or not can be determined by holding a screwdriver against it, then placing your ear against the handle.

(2) Outdoor unit LEV

The valve opening changes according to the number of pulses.

<Connections between the outdoor unit MAIN board and LEV1 (outdoor unit expansion valve)>

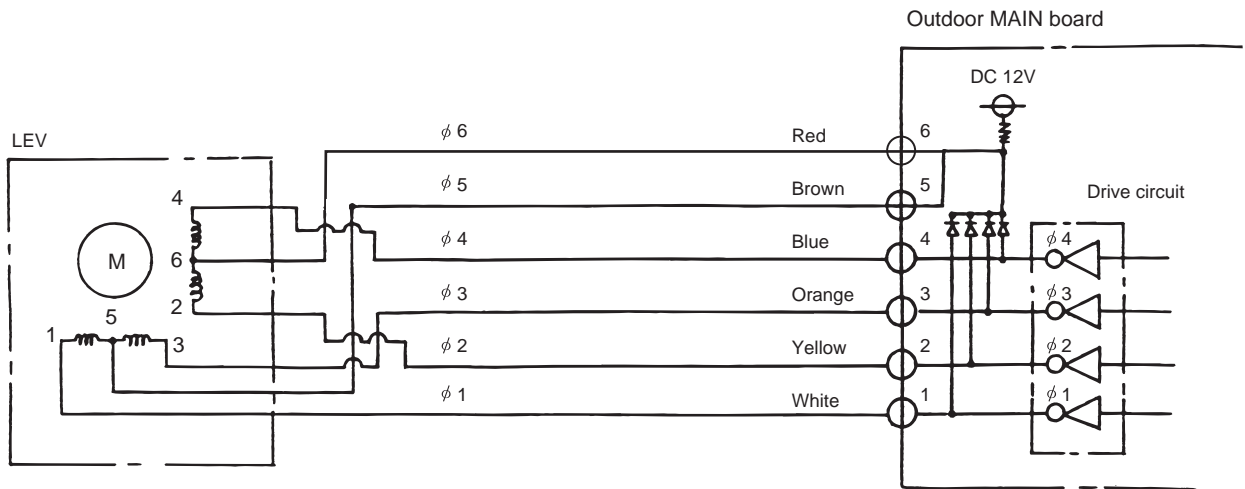

Pulse signal output and valve operation

Output (phase) number	Output state							
	1	2	3	4	5	6	7	8
φ 1	ON	OFF	OFF	OFF	OFF	OFF	ON	ON
φ 2	ON	ON	ON	OFF	OFF	OFF	OFF	OFF
φ 3	OFF	OFF	ON	ON	ON	OFF	OFF	OFF
φ 4	OFF	OFF	OFF	OFF	ON	ON	ON	OFF

Output pulses change in the following orders when the

Valve is closed; 1 → 2 → 3 → 4 → 5 → 6 → 7 → 8 → 1

Valve is open; 8 → 7 → 6 → 5 → 4 → 3 → 2 → 1 → 8

*1. When the LEV opening angle does not change, all the output phases will be off.

*2. When the output is open phase or remains ON, the motor cannot run smoothly, and rattles and vibrates.

LEV valve closing and opening operation

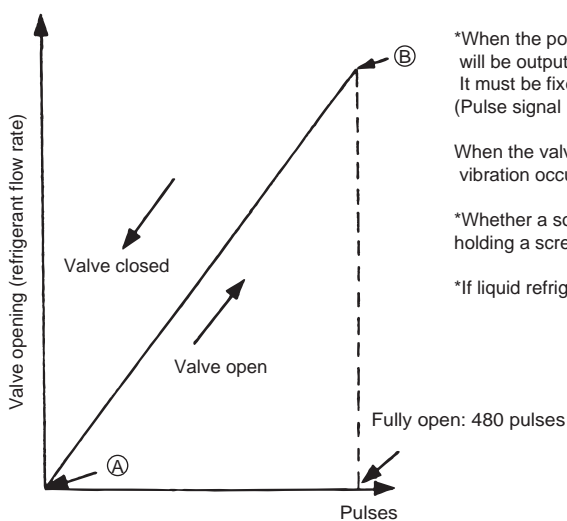

*When the power is turned on, the valve closing signal of 520 pulses will be output from the indoor board to LEV to fix the valve position. It must be fixed at point (A) (Pulse signal is output for approximately 17 seconds.)

When the valve operates smoothly, there is no sound from the LEV and no vibration occurs, but when the valve is locked, noise is generated.

*Whether a sound is generated or not can be determined by holding a screwdriver against it, then placing your ear against the handle.

*If liquid refrigerant flows inside the LEV, the sound may become smaller.

(3) Judgment methods and possible failure mode

Note:

The specifications of the outdoor unit (outdoor unit LEV) and the indoor unit (Indoor unit LEV) differ. Therefore, remedies for each failure may vary. Check the remedy specified for the appropriate LEV as indicated in the right column.

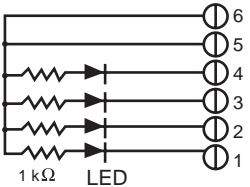
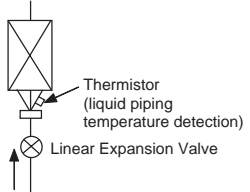
Malfunction mode	Judgment method	Remedy	Target LEV
Microcomputer driver circuit failure	<p>Disconnect the control board connector and connect the check LED as shown in the figure below.</p>  <p>When the main power is turned on, the Indoor unit board or the outdoor unit MAIN board outputs pulse signals to the Indoor unit LEV for 10 seconds, and to the outdoor unit LEV for 17 seconds. If the self-diagnosis LED is not lit, or remains lit, the driver circuit has a problem.</p>	When the drive circuit has a problem, replace the control board.	Indoor unit outdoor unit
LEV mechanism is locked	If the LEV is locked, the drive motor runs idle, and makes a small clicking sound. When the valve makes a closing and opening sound, the valve has a problem.	Replace the LEV.	Indoor unit outdoor unit
Disconnected or short-circuited LEV motor coil	Measure resistance between the coils (red - white, red -orange, brown - yellow, brown - blue) using a tester. They are normal if resistance is 150 ohm \pm 10%.	Replace the LEV coils.	Indoor unit
	Measure resistance between the coils (red - white, red -orange, brown - yellow, brown - blue) using a tester. They are normal if resistance is 46 ohm \pm 3%.	Replace the LEV coils.	outdoor unit
Incomplete sealing (leak from the valve)	<p>When checking the refrigerant leak from the Indoor unit LEV, run the target indoor unit in the fan mode, and the other indoor units in the cooling mode. Then, check the liquid temperature (TH22) with the self-diagnosis LED. When the unit is running in the fan mode, the LEV is fully closed, and the temperature detected by the thermistor is not low. If there is a leak, however, the temperature will be low. If the temperature is extremely low compared with the inlet temperature displayed on the remote controller, the LEV is not properly sealed, however, if there is a little leak, it is not necessary to replace the LEV when there are no effects to other parts.</p> 	If there is a large amount of leakage, replace the LEV.	Indoor unit
Faulty wire connections in the connector or faulty contact.	<ol style="list-style-type: none"> 1. Check for loose pins on the connector and check the colors of the lead wires visually 2. Disconnect the control board's connector and conduct a continuity check using a tester. 	Check the continuity at the points where an error occurs.	Indoor unit outdoor unit

(4) Outdoor unit LEV1 coil removal procedure
 LEV component

As shown in the figure, the outdoor unit LEV is made in such a way that the coils and the body can be separated.

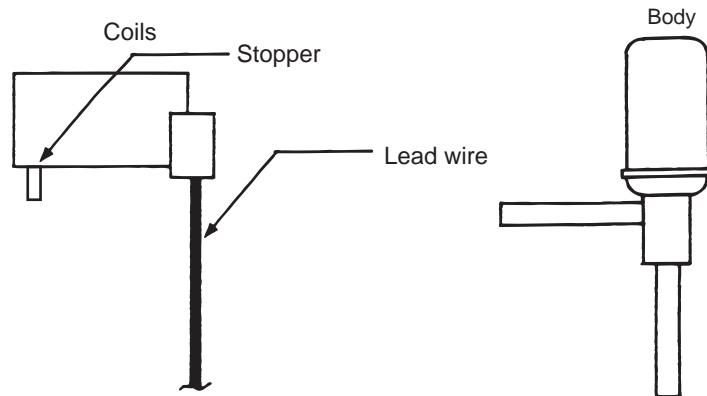

Removing the coils:

Fasten the body tightly at the bottom (Part A in the figure) so that the body will not move, then pull out the coils toward the top. If the coils are pulled out without the body gripped, undue force will be applied and the pipe will be bent.

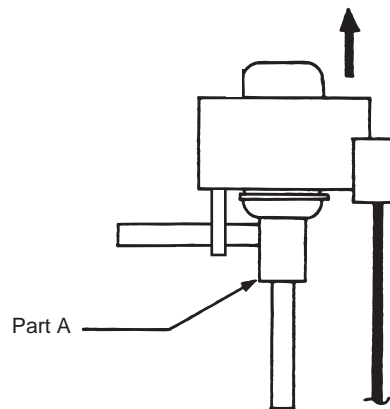

Installing the coils

Fix the body tightly at the bottom (Part A in the figure) so that the body will not move, then insert the coils from the top, and insert the coil stopper securely in the pipe on the body. Hold the body when pulling out the coils to prevent so that the pipe will not be bent.

If the coils are pushed without the body gripped, undue force will be applied and the pipe will be bent. Hold the body when pulling out the coils to prevent so that the pipe will not be bent.

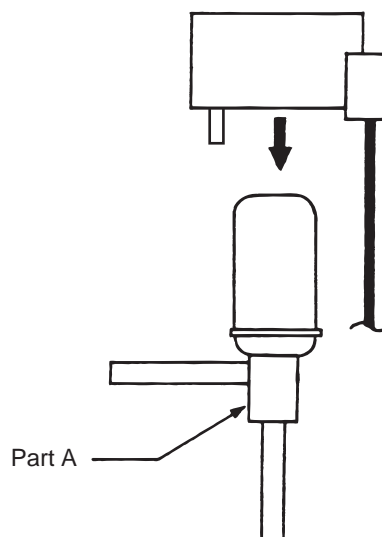

-6- Inverter

- Replace only the compressor if only the compressor is found to be defective. (Overcurrent will flow through the inverter if the compressor is damaged, however, the power supply is automatically cut when overcurrent is detected, protecting the inverter from damage.)
- Replace only the fan motor if only the fan motor is found to be defective. (Overcurrent will flow through the inverter if the fan motor is damaged, protecting the inverter from damage.)
- Replace the defective components if the inverter is found to be defective.
- If both the compressor and the inverter are found to be defective, replace the defective component(s) of both devices.

(1) Inverter related problems and countermeasures

	Error display/failure condition	Measure/inspection item
[1]	Inverter related errors 4250, 4255, 4220, 4225, 4230, 4235, 4240, 4245, 4260, 4265, 5301, 0403, 5110	Check the details of the inverter error in the error log at 10.[1] Table of LED codes. Take appropriate measures to the error code and the error details in accordance with 9. [3] Self-diagnosis on the basis of Error Display on Remote Controller and Remedy for Error.
[2]	Main power breaker trip	<1> Check the breaker capacity. <2> Check whether the electrical system is short-circuited or ground-faulted. <3> If items cause is not <1> or <2> are not the causes of the problem, see (3)-[1].
[3]	Main power earth leakage breaker trip	<1> Check the earth leakage breaker capacity and the sensitivity current. <2> Meg failure for electrical system other than the inverter <3> If the cause is not <1> or <2>, see (3)-[1]
[4]	Only the compressor does not operate.	Check the inverter frequency on the LED monitor and proceed to (2) - [3] if the compressor is in operation.
[5]	The compressor vibrates violently at all times or makes an abnormal sound.	See (2)-[3].
[6]	Only the fan motor does not operate.	Check the inverter frequency on the LED monitor and proceed to (2) - [6],[7] if the fan motor is in operation.
[7]	The fan motor vibrates violently at all times or makes an abnormal sound.	Check the inverter frequency on the LED monitor and proceed to (2) - [6],[7] if the fan motor is in operation.
[8]	Noise is picked up by the peripheral device	<1> Check that power supply wiring of the peripheral device does not run close to the power supply wiring of the outdoor unit. <2> Check that the inverter output wiring is not in close contact with the power supply wiring and the transmission lines. <3> Check that the shielded wire is used as the transmission line when it is required, and check that the grounding work is performed properly on the shielded wire. <4> Meg failure for electrical system other than the inverter <5> Attach a ferrite core to the inverter output wiring. (Contact the factory for details of the service part settings.) <6> Provide separate power supply to the air conditioner and other electric appliances. <7> *If the error occurred suddenly, a ground fault of the inverter output can be considered. See (2)-[3]. *Contact the factory for cases other than those listed above.
[9]	Sudden malfunction (as a result of external noise.)	<1> Check that the grounding work is performed properly. <2> Check that the shielded wire is used as the transmission line when it is required, and check that the grounding work is performed properly on the shielded wire. <3> Check that neither the transmission line nor the external connection wiring does not run close to another power supply system or does not run through the same conduit pipe. * Contact the factory for cases other than those listed above.

Note:

1. Due to a large capacity electrolytic capacitor used in the inverter, voltage still flows through even after the unit is turned off, which may cause electric shock. As a result, wait for a sufficient length of time (5~10 minutes) after the main power is turned off, and check the voltage drop at both terminals of the electrolytic condensers.
2. The components of the inverter such as IPM will be damaged if the screws for inverter wiring are not tightened tightly or the connectors are not properly inserted. When an error occurs after the components are replaced, the wrong wiring is the cause in most cases. Check that the wiring is correct, the screws are not loosely tightened, and the connectors and Faston are not loosely inserted.
3. Do not remove or insert inverter connectors with the main power supply on, as this will result in damage to the PCB.
4. The electric current sensor will be damaged if current flows without the control board being connected. Always insert connectors into the corresponding PCB when running the inverter.

(2) Inverter output related troubles

	Items to be checked	Phenomena	Remedy
[1] Check the compressor INV board error detection circuit.	Perform the following: Remove the connector (CND2) on the compressor INV board. Operate the outdoor unit after above steps. Check the error status. (The compressor does not run because CND2, which outputs the IPM drive signal, has been disconnected.)	1) IPM/overcurrent breaker trip (4250 Detail code No. 101, 102, 103, 104, 105, 106, and 107)	Replace the compressor INV board.
		2) Logic error (4250 Detail code No. 111)	Replace the compressor INV board.
		3) ACCT sensor circuit failure (5301 Detail code No.115)	Check the resistance of the current sensor ACCT referring to 9.[4].-6-.(4) "Current Sensor ACCT", and replace the sensor when abnormal. Replace the compressor INV board if the ACCT is normal.
		4) DCCT sensor circuit failure (5301 Detail code No.116)	Replace the DCCT sensor. After replacing the DCCT, operate the outdoor unit again. In the case when the error occurs again, replace the compressor INV board. (The DCCT may be normal.)
		5) IPM open (5301 Detail code No.119)	Normal
[2] Check for compressor ground fault or coil error.	Disconnect the compressor wiring, and check the compressor Meg, and coil resistance.	1) Compressor Meg failure Error if less than 1 Mohm. When no liquid refrigerant in the compressor 2) Compressor coil resistance failure Coil resistance value of 0.16 ohm (20°C)	Replace the compressor Check that no liquid refrigerant in the compressor.

	Items to be checked	Phenomena	Remedy
<p>[3] Check whether the inverter is damaged. *Perform this check if an error occurs immediately before or after turning on the compressor.</p>	<p>Perform the following: (1) Reconnect the connector that was removed in section [1]. (2) Disconnect the compressor wiring. (3) Turn on SW1-1 on the compressor INV board. Operate the outdoor unit after above steps. Check the inverter output voltage. *It is recommended to use the tester used in the 9.[4] -6- (5) IPM troubleshooting when checking the inverter output voltage. Measure voltage when the compressor inverter output frequency is stable.</p>	<p>1) IPM/overcurrent breaker trip (4250 Detail code No. 101, 102, 103, 104, 105, 106, and 107)</p>	<p>Refer to item [5] for inverter circuit trouble.</p>
		<p>2) The voltage imbalance across all wiring There is a high possibility of an inverter circuit error if the voltage imbalance across all wiring is greater than the larger of the values represented by 5% or 5V.</p>	
		<p>3) No voltage imbalance across all wiring</p>	<p>See item [2]. Proceed to item [5], however if there is no problem in section [2]. Replace the compressor if there is no problem in section [5].</p>
<p>[4] Check whether the inverter is damaged. Perform this check if an error occurs during operation.</p>	<p>Turn on the outdoor unit. Check the inverter output voltage. *It is recommended to use the tester used in the 9.[4] -6- (5) IPM troubleshooting when checking the inverter output voltage. *Measure voltage when the compressor inverter output frequency is stable.</p>	<p>1) The voltage imbalance across all wiring There is a high possibility of an inverter circuit error if the voltage imbalance across all wiring is greater than the larger of the values represented by 5% or 5V.</p>	<p>Refer to item [5] for inverter circuit trouble.</p>
		<p>2) No voltage imbalance across all wiring</p>	

	Items to be checked	Phenomena	Remedy
[5] Check the inverter circuit trouble.	Check whether the IPM screw terminal is not loose.	1) Terminal screws are loose.	Check for loose IPM terminal screws and tighten them.
	Check the exterior of the IPM.	2) IPM is cracked due to swelling.	Replace the IPM. Check the operation in [3] or [4] after replacing the IPM. In the case of an output voltage imbalance or error reoccurrence: Replace the G/A board. In the case of an output voltage imbalance or error reoccurrence after replacement: Replace the INV board.
	Check the resistances between each terminal of IPM. Refer to 9.[4] -6- (5) for details on IPM troubleshooting.	3) Check the resistances between each terminal of IPM.	Replace the IPM. Check the operation in [3] or [4] after replacing the IPM. In the case of an output voltage imbalance or error reoccurrence: Replace the G/A board. In the case of an output voltage imbalance or error reoccurrence after replacement: Replace the INV board.
		4) All normal for items 1) - 3) above.	Replace the IPM. In the case of an output voltage imbalance or error reoccurrence: Replace the G/A board. In the case of an output voltage imbalance or error reoccurrence after replacement: Replace the INV board.
[6] Check the fan motor ground fault or the winding.	Remove the wire for the outdoor fan motor, and check the fan motor megger and the winding resistance.	1) Fan motor megger failure Failure when the megger is 1Mohm or less.	Replace the fan motor.
		2) Fan motor disconnection Standard: The winding resistance is approximately several ohm. (It varies depending on the temperature, or while the inner thermo is operating, it will be ∞ ohm)	
[7] Check the FAN INV board failure.	(1) Check the fan output wiring.	Connector contact failure •Board side (CNINV) •Fan motor side	Connect the connector.
	(2) Check the connector CN-VDC connection.	Connector contact failure	Connect the connector.
	(3) Check the FAN INV board failure.	1) The voltage imbalance among each motor wiring during operation (The voltage imbalance is greater than the larger of the values represented by 5% or 5 V.)	Replace the FAN INV board.
		2) The same error occurs even after the operation is restarted.	
(4) Check the transformer on the FAN INV board.	The same error occurs even if the board is replaced as described in (3)	Replace the power-supply transformer on the FAN INV board.	

(3) Trouble treatment when the main power breaker is tripped.

	Items to be checked	Phenomena	Remedy
[1]	Perform Meg check between the terminals on the power terminal block TB1.	Zero to several ohm, or Meg failure	Check each part in the main inverter circuit. *Refer to "Simple checking Procedures for individual components of main inverter circuit".
[2]	Turn on the power again and check again.	1) Main power breaker trip	<ul style="list-style-type: none"> •Diode stack •IPM •Rush current protection resistor •DC reactor
		2) No remote control display	
[3]	Turn on the outdoor unit and check that it operates normally.	1) Operates normally without tripping the main breaker.	<ul style="list-style-type: none"> i) The wiring may have been short-circuited. Search for the wire that short-circuited, and repair it. ii) If item i) above is not the cause of the problem, the compressor may have a problem.
		2) Main power breaker trip	A compressor ground fault can be considered. Go to (2)-[2].

- (4) Simple checking procedure for individual components of main inverter circuit
 * Before checking, turn the power off and remove the parts to be checked from the control box.

Part name	Judgment method																												
Diode stack	Refer to "Diode stack" (9.[4] -6- (6))																												
IPM (Intelligent power module)	Refer to "Intelligent power module (IPM)" (9.[4] -6- (5))																												
Rush current protection resistor R11, R12	Measure the resistance between terminals: 47 ohm \pm 10%																												
Electromagnetic contactor 52C(1), 52C2, 52F	<div style="display: flex; justify-content: space-around; align-items: flex-start;"> <div style="text-align: center;"> <p>[In the case of 52C1, 52C2]</p> </div> <div style="text-align: center;"> <p>[In the case of 52F]</p> </div> <div style="border: 1px solid black; padding: 5px;"> <table border="1"> <thead> <tr> <th colspan="2">Check point</th> <th>Judgment value</th> </tr> </thead> <tbody> <tr> <td colspan="2" style="text-align: center;">A1-A2</td> <td style="text-align: center;">0.1 k ~ 2.0 kΩ</td> </tr> <tr> <td rowspan="5" style="text-align: center;">Button on (hold down)</td> <td>L1 - T1</td> <td>1Ω or less (almost 0Ω)</td> </tr> <tr> <td>L2 - T2</td> <td>1Ω or less (almost 0Ω)</td> </tr> <tr> <td>L3 - T3</td> <td>1Ω or less (almost 0Ω)</td> </tr> <tr> <td>13 - 14</td> <td>1Ω or less (almost 0Ω)</td> </tr> <tr> <td>31 - 32</td> <td>∞</td> </tr> <tr> <td rowspan="5" style="text-align: center;">Button OFF</td> <td>L1 - T1</td> <td>∞</td> </tr> <tr> <td>L2 - T2</td> <td>∞</td> </tr> <tr> <td>L3 - T3</td> <td>∞</td> </tr> <tr> <td>13 - 14</td> <td>∞</td> </tr> <tr> <td>31 - 32</td> <td>1Ω or less (almost 0Ω)</td> </tr> </tbody> </table> </div> </div>	Check point		Judgment value	A1-A2		0.1 k ~ 2.0 k Ω	Button on (hold down)	L1 - T1	1 Ω or less (almost 0 Ω)	L2 - T2	1 Ω or less (almost 0 Ω)	L3 - T3	1 Ω or less (almost 0 Ω)	13 - 14	1 Ω or less (almost 0 Ω)	31 - 32	∞	Button OFF	L1 - T1	∞	L2 - T2	∞	L3 - T3	∞	13 - 14	∞	31 - 32	1 Ω or less (almost 0 Ω)
Check point		Judgment value																											
A1-A2		0.1 k ~ 2.0 k Ω																											
Button on (hold down)	L1 - T1	1 Ω or less (almost 0 Ω)																											
	L2 - T2	1 Ω or less (almost 0 Ω)																											
	L3 - T3	1 Ω or less (almost 0 Ω)																											
	13 - 14	1 Ω or less (almost 0 Ω)																											
	31 - 32	∞																											
Button OFF	L1 - T1	∞																											
	L2 - T2	∞																											
	L3 - T3	∞																											
	13 - 14	∞																											
	31 - 32	1 Ω or less (almost 0 Ω)																											
DC reactor DCL	Measure the resistance between terminals: 1 ohm or lower (almost 0 ohm) Measure the resistance between terminals and the chassis: ∞																												
Current sensor ACCT	<p>Disconnect the CNCT2 connector and measure the resistance between terminals: 280 ohm \pm 30 ohm 1 - 2 PIN (U-phase), 3 - 4 PIN (W-phase)</p> <div style="text-align: center;"> </div> <p>* Check the ACCT connection phase and the direction of the connection.</p>																												

(5) Intelligent power module (IPM)

Measure resistances between each pair of terminals on the IPM with a tester, and use the results for troubleshooting.

Notes on measurement

- Check the polarity before measuring. (On the tester, black normally indicates plus.)
- Check that the resistance is not open (∞ ohm) or not shorted (to 0 ohm).
- The values are for reference, and the margin of errors is allowed.
- The result that is more than double or half of the result that is measured at the same measurement point is not allowed.

Tester restriction

- Use the tester whose internal electrical power source is 1.5V or greater
- Use the dry-battery-powered tester.
- (*The accurate diode-specific resistance cannot be measured with the button-battery-powered card tester, as the applied voltage is low.)
- Use a low-range tester if possible. A more accurate resistance can be measured.

Judgment value (reference)

		Black (+)				
		P	N	U	V	W
Red (-)	P	-	-	5 - 200 ohm	5 - 200 ohm	5 - 200 ohm
	N	-	-	∞	∞	∞
	U	∞	5 - 200 ohm	-	-	-
	V	∞	5 - 200 ohm	-	-	-
	W	∞	5 - 200 ohm	-	-	-

External view

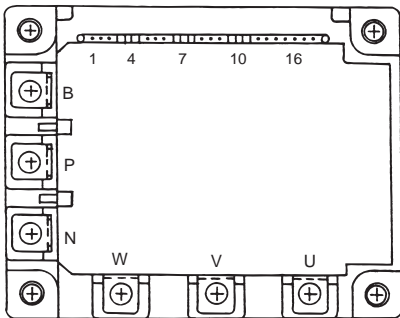

Internal circuit diagram

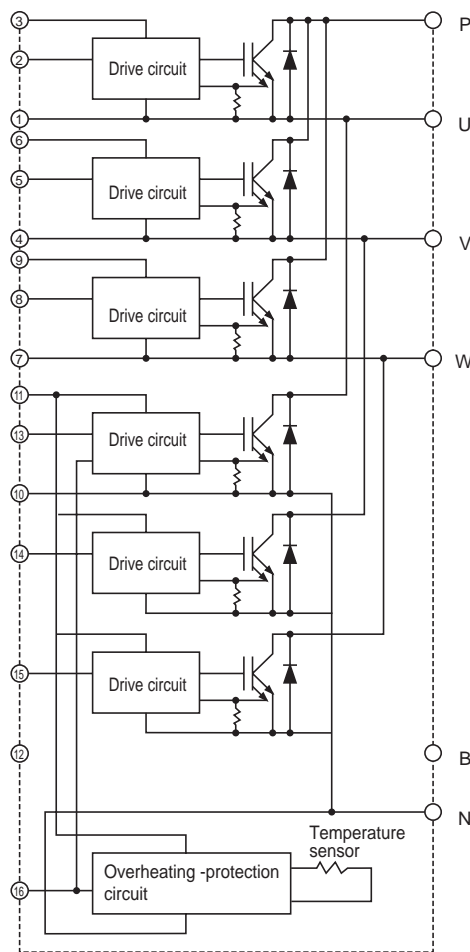

(6) Diode stack

Measure resistances between each pair of terminals on the diode stack with a tester, and use the results for troubleshooting. Refer to (5) " Intelligent power module (IPM) " for notes on measurement and tester selection.

Judgment value (reference)

		Black (+)				
		+ (P)	- (N)	to (L1)	to (L2)	to (L3)
Red (-)	+ (P)	-	-	5 - 200 ohm	5 - 200 ohm	5 - 200 ohm
	- (N)	-	-	∞	∞	∞
	to (L1)	∞	5 - 200 ohm	-	-	-
	to (L2)	∞	5 - 200 ohm	-	-	-
	to (L3)	∞	5 - 200 ohm	-	-	-

External view

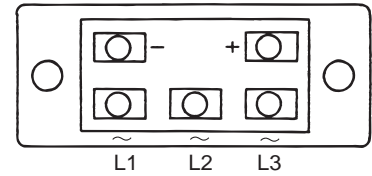

Internal circuit diagram

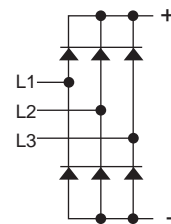

(7) Caution at replacement of inverter parts

1) Check for miswiring and loose connections.

Incorrect or loose wiring of such circuit components as IPM and diode stack may cause the IPM damage. Thoroughly check the wiring. Retighten all screws upon completion of all other work.

Connect the IPM control terminal carefully to the G/A board, as the terminal is very small. If the output wire from the IPM to the compressor is connected incorrectly, the compressor will be damaged. Perform wiring carefully in order of color shown in the wiring diagram below.

2) Coat the radiation surface of the IPM and diode stack evenly with the grease that is provided with the service parts.

Apply a thin layer of grease to the entire surface of the back of the IPM and diode stack, and screw the module securely into place.

Wipe off any grease that may get on the wiring terminal to avoid terminal contact failure.

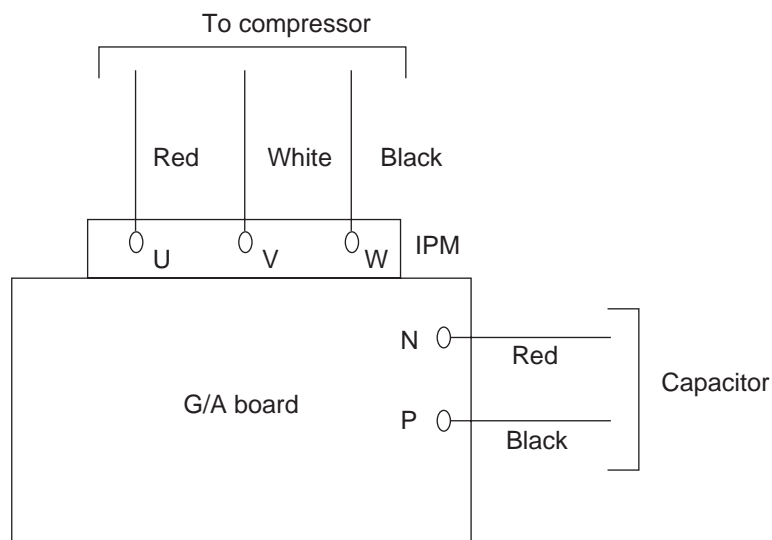

-7- Control Circuit

(1) Control power source function block P250 model

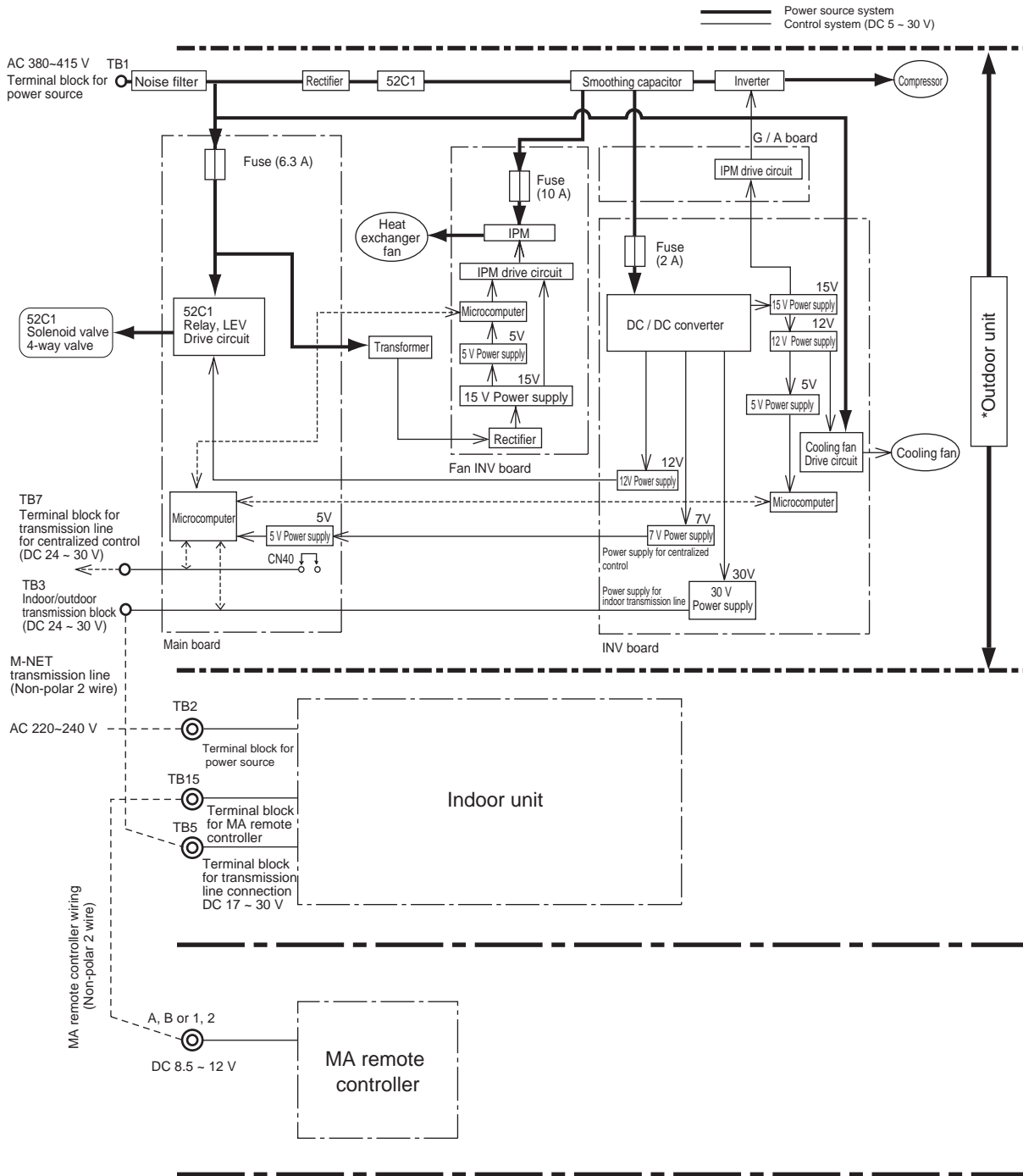

(2) Troubleshooting transmission power circuit of outdoor unit

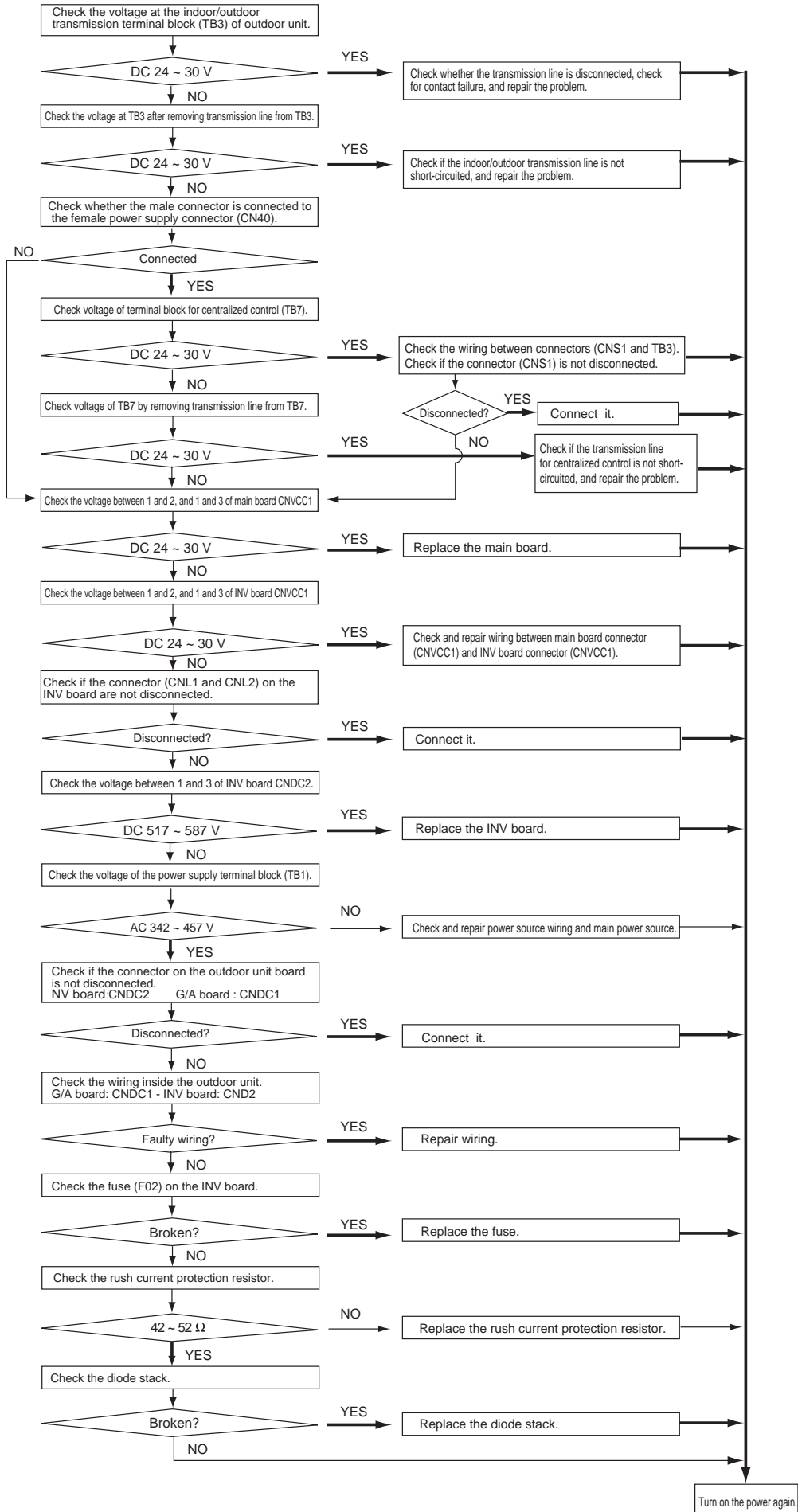

[5] Refrigerant Leak

1. Leak spot: In the case of extension pipe for indoor unit
 - 1) Mount a pressure gauge on the service check joint (CJ2) on the low-pressure side.
 - 2) Stop all the indoor units, and close the liquid ball valve (BV2) inside the outdoor unit while the compressor is being stopped.
 - 3) Stop all the indoor units; turn on SW3-6 on the outdoor unit main board while the compressor is being stopped.(Pump down mode will start, and all the indoor units will run in cooling test run mode.)
 - 4) In the pump down mode (SW3-6 is ON), all the indoor units will automatically stop when the low pressure (LPS) reaches 0.382MPa or less or 15 minutes have passed after the pump mode started. Stop all the indoor units and compressors when the pressure indicated by the pressure gauge, which is on the check joint (CJ2) for low-pressure service, reaches 0.284MPa or 20 minutes pass after the pump down operation is started.
 - 5) Close the gas ball valve (BV1) inside the outdoor unit.
 - 6) Collect the refrigerant that remains in the extended pipe for the indoor unit. Do not discharge refrigerant into the atmosphere when it is collected.
 - 7) Repair the leak.
 - 8) After repairing the leak, vacuum the extension pipe and the indoor unit.
 - 9) To adjust refrigerant amount and to check the composition of refrigerant, open the ball valves (BV1 and BV2) inside the outdoor unit and turn off SW3-6.

2. Leak spot: In the case of outdoor unit
 - 1) Run all the indoor units in the cooling test run mode.
 - (i) To run the indoor unit in test run mode, turn SW3-2 from OFF to ON when SW3-1 on the outdoor MAIN board is ON.
 - (ii) Change the setting of the remote controller for all the indoor units to the cooling mode.
 - (iii) Check that all the indoor units are performing a cooling operation.
 - 2) Check the values of Tc and TH7.

(To display the values on the LED screen, use the self-diagnosis switch (SW1) on the outdoor unit main board.)

 - (i) When Tc-TH7 is 10K or more : See the next item 3).
 - (ii) When Tc-TH7 is less than 10K : After the compressor stops, collect the refrigerant inside the system, repair the leak, perform evacuation, and recharge new refrigerant. (Leak spot: In the case of outdoor unit, handle in the same way as heating season.)

Tc self-diagnosis switch



TH7 self-diagnosis switch

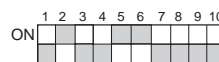

- 3) Stop all the indoor units, and stop the compressor.
 - (i) To stop all the indoor units and the compressors, turn SW3-2 from ON to OFF when SW3-1 on the outdoor MAIN board is ON.
 - (ii) Check that all the indoor units are being stopped.
- 4) Close the ball valves (BV1 and BV2).
- 5) To prevent the liquid seal, extract small amount of refrigerant from the check joint of the liquid ball valve (BV2), as the liquid seal may cause a malfunction of the unit.
- 6) Collect the refrigerant that remains inside the outdoor unit. Do not discharge refrigerant into air into the atmosphere when it is collected.
- 7) Repair the leak.
- 8) After repairing the leak, replace the dryer with the new one, and perform evacuation inside the outdoor unit.
- 9) To adjust refrigerant amount, open the ball valves (BV1 and BV2) inside the outdoor unit.

Note : When the power to the outdoor/indoor unit must be turned off to repair the leak after closing the ball valves specified in the item 4, turn the power off in approximately one hour after the outdoor/indoor units stop.

 - (i) When 30 minutes have passed after the item 4 above, the indoor unit lev turns from fully closed to slightly open to prevent the refrigerant seal.
 - (ii) Therefore, if the power source is turned off within 30 minutes, the lev remains fully closed and the refrigerant remains sealed.

When only the power for the indoor unit is turned off, the indoor unit LEV turns from faintly open to fully closed.

[6] Compressor Replacement Instructions (Only P500 type)

Follow the instructions below when replacing the compressor.

When replacing the compressor No.1 (inverter drive), determine if the compressor is malfunctioning or the inverter is malfunctioning.

When only one compressor is malfunctioning, operate the compressor for approximately an hour in emergency operation mode before the replacement, check the items below, and replace the compressor after examining whether the return oil circuit is working properly or not.

Refer to the diagram on the right for the temperature of each section.

<When normal>

- 1) Temperature of A = Temperature of C,
and Temperature of A > Outdoor temperature + 10deg°C
- 2) Temperature of B = Temperature of C,
and Temperature of B > Outdoor temperature + 10deg°C

<When abnormal>

When 1) is abnormal (out of range)

Return oil failure due to SV1 circuit failure

-> Replace SV1 circuit.

When 2) is abnormal (out of range)

Return oil failure due to capillary blockage

-> Replace the capillary

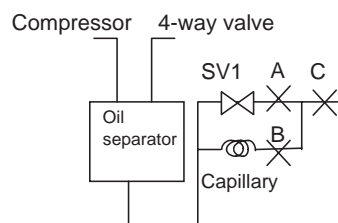

- 1) Check that the main power is OFF.

When replacing the compressor due to megger failure and when the megger is 1M ohm or more, megger drop is likely due to the liquified refrigerant entering and accumulating in the compressor. Turn the power off after powering the crankcase heater at least 12 hours, and apply megger again.

- 2) Remove the fin guard, the front panel and the front partition plate on the right (as you face the front).
- 3) Collect the refrigerant from the service check joints on both high and low-pressure sides.
When collecting refrigerant from the accumulator, perform proper work with the reference of refrigerant collecting method from the accumulator.
- 4) The oil must not be leaked from the drain oil pipe that is located on the oil balance pipe.
Note:
 - Do not splash oil.Do not leave the refrigerant circuit open for a long time, as the oil rapidly absorbs moisture.
 - The collected oil cannot be reused.
- 5) After draining oil from the refrigerant and the drain oil plug, remove the metal fitting-1 or the flare nuts (2 places) that connect the compressor and the oil balance pipe, and bend the oil balance pipe so as not to apply an excess force.
- 6) Close the oil balance pipe attachment point with a cap to prevent the oil from leaking.
- 7) Remove the compressor terminal cover, and remove the power supply wiring.
- 8) Remove the discharge temperature thermistor and the sound-proof material that is wrapped around the compressor.

- 9) Remove the crankcase heater. After replacing the dryer, do not leave the refrigerant circuit for long time.

- 10) Heat the brazed part of the discharge pipe and the suction pipe, and remove the pipes.

- 11) Remove the compressor fixing nuts and the metal fitting-2 (3 places on HN71).

- 12) Replace the compressor with the service compressor.

- 13) Braze the discharge pipe and the suction pipe.

- 14) Attach the oil balance pipe to both compressors. Replace the dryer with a new one. After replacing the dryer, do not leave the refrigerant circuit for long time.

Note:

When replacing the compressor and when the equal oil pipe is damaged or irreparably deformed, after replacing the compressor, heat the junction of the equal oil pipe, remove the equal oil pipe, and braze the service equal oil pipe.

- 15) Close the ball valves in the outdoor unit (both on the liquid and the gas side), and pressurize up to 4.15MPa with nitrogen from the check joints for high and low-pressure service.

- 16) After confirming the airtightness, release the nitrogen gas.

- 17) Open the ball valves in the outdoor unit (both on the liquid and the gas side), and perform vacuuming.

- 18) While vacuuming, add the same amount of oil that is collected from the drain oil plug on the oil balance pipe in the procedure 4) as necessary.

Note:

•The oil to be added must be MEL32 made by Nisseki Mitsubishi.When adding oil, the oil must not absorb moisture, and do not use the oil that is over a year old.

•Do not draw out the oil in the compressor when returning the compressor to find the cause of compressor malfunction.

- 19) Attach the crankcase heater.

Note: Attach the appropriate crankcase heater to the appropriate compressor.

- 20) Attach the soundproof material to the compressor.
- 21) Attach the discharge temperature thermistor, and attach the insulation.
- 22) Attach the power source wire to the terminal on the compressor.
- 23) After vacuuming, calculate the amount of added refrigerant at factory shipment and the amount of added refrigerant on site, and charge the system.
- 24) After reconfirming the power source-wiring phase, apply a megger, attach the terminal cover, turn on the main power, and check whether the crankcase heater is powered.
- 25) Check that the ball valves (both on the liquid and the gas side) are open.
- 26) Operate all the indoor units, and check whether they run properly.
- 27) If there is something that needs to be improved in the installation or the usage, explain that to the customers.

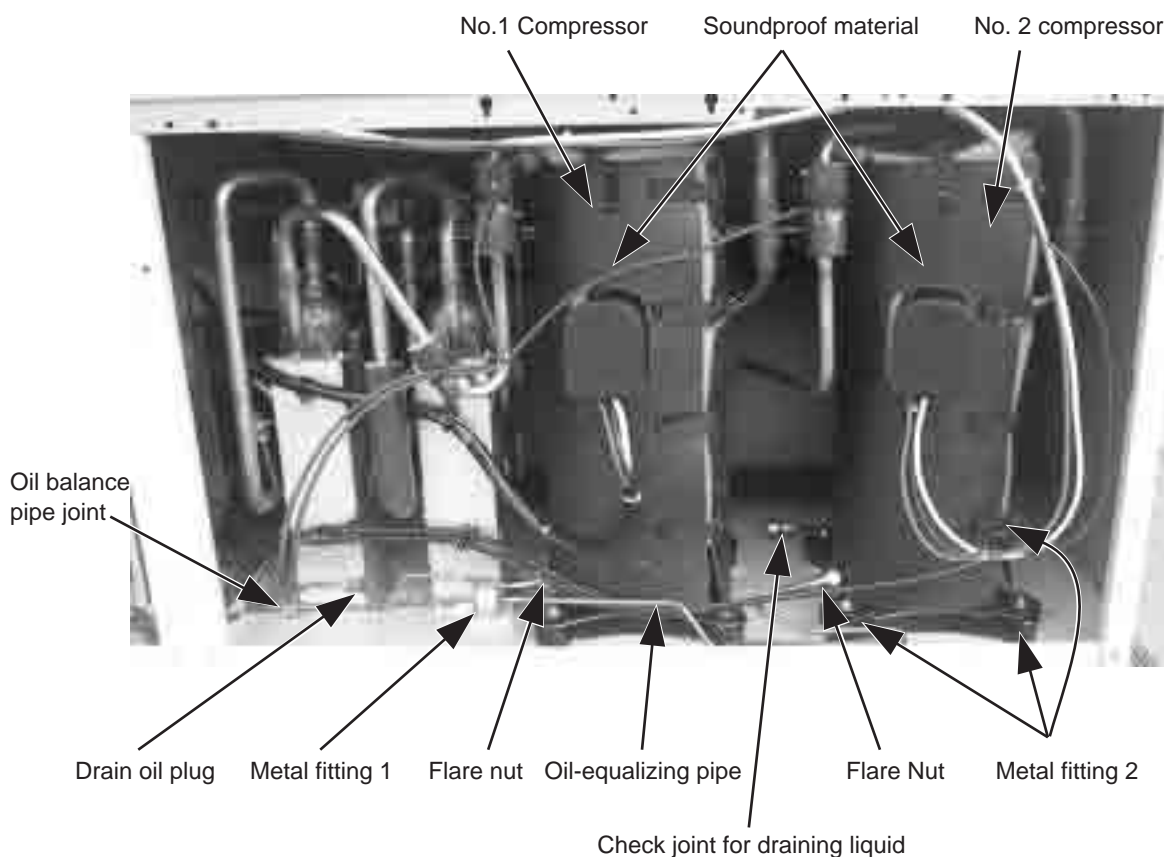

[7] Collecting the Cooling Liquid from the Accumulator (Only P500 type)

- 1) Perform evacuation inside the recovery cylinder.
- 2) Connect the check joint for collecting liquid that is derived from the accumulator and the recovery cylinder with a connection pipe (or hose that has predetermined withstand pressure).
 Note: When the check joint and the connecting pipe (hose) are connected, extremely low-temperature oil may flow out. Use some protective clothing, such as leather gloves.
- 3) Open the valves of the recovery cylinder while the recovery cylinder is being weighed, and collect the liquid inside the accumulator into the cylinder.
 Note: Allow some capacity when collecting the refrigerant so that the recovery cylinder will not overflow. Use several cylinders when collecting large amount of refrigerant.
- 4) After collecting the refrigerant, close the valve of the recovery cylinder, and remove the connecting pipe (hose).
 Note: When the check joint and the connecting pipe (hose) are connected, extremely low-temperature oil may flow out. Use some protective equipment, such as leather gloves.
- 5) Charge 3-liter oil from the check joint on the accumulator during evacuation.

[8] Maintenance/Inspection Schedule

Having the units inspected by a specialist on a regular basis, in addition to regular maintenance such as changing the filters, will allow the users to use them safely and in good condition for an extended period of time.

The chart below indicates standard maintenance schedule.

(1) Approximate Longevity of Various Parts

The chart shows an approximate longevity of parts. It is an estimation of the time when old parts may need to be replaced or repairs need to be made.

It does not mean that the parts must absolutely be replaced (except for the fan belt).

Please note that the figures in the chart do not mean warranty periods.

Unit	Parts	Check every	Replace after	Daily check	Periodically check	Remarks
Indoor	Fan Motor	6 months	40000 hours		Yes	
	Bearing	6 months	40000 hours		Yes	Add lubricant once a year
	Fan Belt	6 months	8000 hours		Yes	Disposable parts
	Air Filter	3 months	5 years	Yes		Maintenance schedule changes depending on the local conditions
	Drain Pan	6 months	8 years		Yes	
	Drain Hose	6 months	8 years		Yes	
	Linear Expansion Valve	1 year	25000 hours		Yes	
	Heat Exchanger	1 year	5 years		Yes	
	Float Switch	6 months	25000 hours		Yes	
	Display Lamp (LED)	1year	25000 hours		Yes	
Outdoor	Compressor	6 months	40000 hours		Yes	
	Fan motor	6 months	40000 hours		Yes	
	Linear Expansion Valve	1 year	25000 hours		Yes	
	4-way valve	1 year	25000 hours		Yes	
	Heat Exchanger	1 year	5 years		Yes	
	Pressure Switch	1 year	25000 hours		Yes	
	Inverter Cooling Fan	1 year	40000 hours		Yes	

(2) Notes

- The above chart shows a maintenance schedule for a unit that is used under the following conditions:
 - A. Less than 6 times per hour of compressor stoppage
 - B. The unit stays on 24 hours a day.
- Shortening the inspection cycle may need to be considered when the following conditions apply:
 - ① When used in high temperature/high humidity area or when used in a place where the temperature and/or humidity fluctuate greatly
 - ② When plugged into an unstable power source (sudden change in voltage, frequency, wave distortions) (Do not exceed the maximum capacity.)
 - ③ When the unit is installed in a place where it receives vibrations or major impacts.
 - ④ When used in a place with poor air quality (containing dust particles, salt, poisonous gas such as sulfuric acid gas and sulfuric hydrogen gas, oil mist).
- Even when the above maintenance schedule is followed, there could be unexpected problems that cannot be predicted.
- Holding of Parts

We will hold parts for the units for at least 9 years after the termination of the production of the unit, following the standards set by the ministry of economics and industries.

(3) Details of Maintenance/Inspection

Unit	Parts	Inspection Cycle	Check points	Assessment	What to do
Indoor	Fan motor	6 months	<ul style="list-style-type: none"> · Check for unusual noise · Measure the insulation resistance 	<ul style="list-style-type: none"> · Free of unusual noise · Insulation resistance over 1MΩ 	Replace when insulation resistance is under 1MΩ
	Bearing		<ul style="list-style-type: none"> · Check for unusual noise 	<ul style="list-style-type: none"> · Free of unusual noise 	If the noise doesn't stop after lubrication, change the oil. Add lubricant once a year.
	Fan belt		<ul style="list-style-type: none"> · Check for excessive slack · Check for wear and tear · Check for unusual noise 	<ul style="list-style-type: none"> · Resistance (30~40N/belt) · Adequate amount of slack=5mm · Belt length=no longer than 102% of the original length · Free of wear and tear · Free of unusual noise 	Adjust the belt Replace if the belt length exceeds 2% of the original length, worn, or used over 8000 hours
	Air filter	3 months	<ul style="list-style-type: none"> · Check for clogging and tear · Clean the filter 	<ul style="list-style-type: none"> · Clean, free of damage 	Clean the filter Replace if extremely dirty or damaged
	Drain pan	6 months	<ul style="list-style-type: none"> · Check for clogging of the drainage system · Check for loosened bolts · Check for corrosion 	<ul style="list-style-type: none"> · Clean, free of clogging · Free of loose screws · No major disintegration 	Clean if dirty or clogged Tighten bolts Replace if extremely worn
	Drain hose		<ul style="list-style-type: none"> · Check for clogging of the drainage system · Check for corrosion · Check the drainage of the drain trap 	<ul style="list-style-type: none"> · Clean, free of clogging · Free of wear and tear 	Clean if dirty or clogged Replace if extremely worn Pour water into the drain trap
	Linear expansion valve	1 year	<ul style="list-style-type: none"> · Perform an operation check using the operation data 	<ul style="list-style-type: none"> · Adequately controls the air temperature 	Replace if malfunctioning
	Heat exchanger		<ul style="list-style-type: none"> · Check for clogging, dirt, and damage 	<ul style="list-style-type: none"> · Clean, free of clogging or damage 	Clean
	Float switch	6 months	<ul style="list-style-type: none"> · Check the outer appearance · Make sure its free of foreign objects 	<ul style="list-style-type: none"> · Free of frayed or cut wires · Free of foreign objects 	Replace if damaged or extremely worn Remove foreign objects
	Display lamp (LED)	1 year	<ul style="list-style-type: none"> · Make sure the lamp comes on 	<ul style="list-style-type: none"> · Comes on when the output is on · Rapid drop in brightness 	Replace if the light does not come on when the power is on
Outdoor	Compressor	6 months	<ul style="list-style-type: none"> · Check for unusual noise · Check insulation resistance · Check for loosened terminals 	<ul style="list-style-type: none"> · Free of unusual sound · Insulation resistance over 1MΩ · Free of loosened terminals 	Replace if insulation resistance goes below 1MΩ (under the condition that the refrigerant is not liquefied) Tighten loosened bolts
	Fan motor		<ul style="list-style-type: none"> · Check for unusual noise · Measure insulation resistance 	<ul style="list-style-type: none"> · Free of unusual sound · Insulation resistance over 1MΩ 	Replace if insulation resistance goes below 1MΩ
	Linear expansion valve	1 year	<ul style="list-style-type: none"> · Perform an operation check using the operation data 	<ul style="list-style-type: none"> · Adequately controls the air temperature 	Replace if malfunctioning
	4-way valve		<ul style="list-style-type: none"> · Perform an operation check using the operation data 	<ul style="list-style-type: none"> · Adequately controls the refrigerant temperature when the valve is switched (Check temperature change when cooling/heating is switched.) 	Replace if malfunctioning
	Heat exchanger		<ul style="list-style-type: none"> · Check for clogging, dirt, and damage 	<ul style="list-style-type: none"> · Clean, free of clogging or damage 	Clean
	Pressure switch		<ul style="list-style-type: none"> · Check for torn wire, fraying, and unplugged connectors · Check insulation resistance 	<ul style="list-style-type: none"> · No frayed or cut wires or unplugged connectors · Insulation resistance over 1MΩ 	Replace when cut or shorted, when the insulation resistance goes below 1MΩ, or if there is a history of abnormal operation
Inverter cooling fan	<ul style="list-style-type: none"> · Check for unusual sound · Measure insulation resistance · Look for abnormal history 	<ul style="list-style-type: none"> · Free of unusual sound · Insulation resistance over 1MΩ · No heatsink overheat protection (4230,4330) on the report 	Replace when producing unusual sounds, when insulation resistance goes under 1MΩ, or if there is a history of abnormal operation.		

(4) Check method

- ① Select the "Inspection" mode using the "Normal/Inspection" switching switch on the indoor unit.
 - In "Inspection" mode, the local operation is enabled, and the remote ON/OFF operation (external input or central manipulator) is disabled. If no external input is available, the local operation is enabled in both "Normal" and "Inspection" modes.
The occurred error is not reported to the upper system, such as building management system including central manipulator. (If an error occurs during inspection, the occurred error is reported only to the units, and the error history remains on the units.)

- ② Select the "OFF" mode using the MA remote controller of the indoor unit to stop the unit.
 - Turn OFF the power source of the indoor unit as necessary based on the inspection item.
(If the power source of the outdoor unit is turned OFF, the transmission error will be detected on the central manipulator, and this is not abnormal.)

 - * To check the LEV operation, the inspection must be performed unit operation.
The LEV opening and the piping temperature behind the LEV can be monitored on the outdoor unit LED.
Check that the piping temperature changes normally depending on the LEV opening.

- ③ Check whether an error history remains on the nonvolatile memory on the indoor and outdoor units.
 - If an error history remains, take out the data before an error occurs, and correct the error after analyzing the causes.

- ④ Check each component based on the maintenance/inspection items described on the previous page.
 - If problems are found, repair the component.

- ⑤ Delete the error code history recorded on the nonvolatile memory on the unit after the inspection.
 - (To delete the error history on the indoor and the outdoor units, turn the DipSW 2-3 on the outdoor unit that is being powered from OFF to ON.) If the power source of the outdoor unit is turned OFF during inspection, the transmission error detected by the central manipulator after the power recovery will be deleted.
(Do not turn OFF the power source of the outdoor unit until the inspection of all the units is completed, as all the error history remained on the central manipulator will be deleted.
If no central manipulator is available, this operation is not necessary.)

 - *The transmission error detected by the central manipulator during power failure of the outdoor unit will be reset automatically after the power recovers and after the transmission recovers normally.

- ⑥ Select the "ON" mode using the MA remote controller of the indoor unit to operate the unit.

- ⑦ Select the "Normal" mode using the using the "Normal/Inspection" switching switch on the indoor unit.

- ⑧ Completed

X LED Monitor Display on the Outdoor Unit Board

[1] How to Read the LED on the Service Monitor	175
--	-----

[1] How to Read the LED on the Service Monitor

1. How to read the LED

By setting the DIP SW 1-1 through 1-10 (Switch number 10 is represented by 0), the operating condition of the unit can be monitored on the service monitor. (Refer to the table on the following pages for DIP SW settings.) The service monitor uses 4-digit 7-segment LED to display numerical values and other types of information.

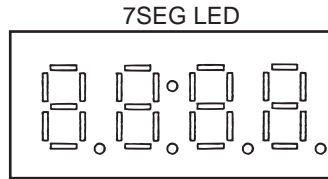

Pressure and temperature are examples of numerical values, and operating conditions and the on-off status of solenoid valve are examples of flag display.

1) Display of numerical values

Example: When the pressure data sensor reads 18.8kg/cm² (Item No. 72)

- ♦The unit of pressure is in kg/cm²
- ♦ Use the following conversion formula to convert the displayed value into a value in SI unit.
Value in SI unit (MPa) = Displayed value (kg/cm²) x 0.098

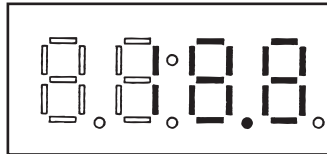

2) Flag display (Each set of 2 lines in vertical alignment indicates a flag.) Example: 3-minutes restart mode (Item No. 14)

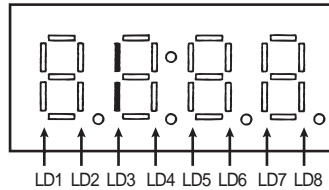

2. LED display at initial setting

From power on until the completion of initial settings, the following information will be displayed on the monitor screen. (Displays No. 1 through No. 4 in order repeatedly.)

No	SW1	Item	Display	Remarks
1	N/A	Software version	8888	[0103] : Version 1.03
2		Refrigerant type	[888	[410] : R410A
3		Model and capacity	8 [888	[H-20] : cooling and heating 20HP
4		M-NET address	[888	[51] : Address 51

After the initial settings have been completed, the information on these items can be checked by making the switch setting that corresponds to No. 517 in the LED display table.

3. Time data storage function

The outdoor unit has a simple clock function that enables the unit to calculate the current time with an internal timer by receiving the time set by the system controller, such as G50.

If an error (including a preliminary error) occurs, the error history data and the error detection time are stored into the service memory.

The error detection time stored in the service memory and the current time can be seen on the service LEDs.

Notes:

- 1) Use the time displayed on the service LED as a reference.
- 2) The date and the time are set to "00" by default. If a system controller that sets the time, such as G50 is not connected, the elapsed time and days since the first power on will be displayed. If the time set on a system controller is received, the count will start from the set date and the time.
- 3) The time is not updated while the power of the indoor unit is turned off. When the power is turned off and then on again, the count will resume from the time before the power was turned off. Thus, the time that differs the actual time will be displayed. (This also applies when a power failure occurs.)
The system controller, such as G50, adjusts the time once a day. When the system controller is connected, the time will be automatically updated to the correct current time after the time set by the system controller is received. (The data stored into the memory before the set time is received will not be updated.)

(1) Reading the time data:

- 1) Time display
Example: 12 past 9

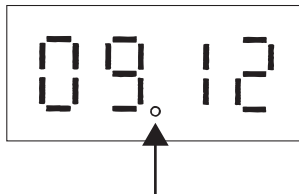

* Disappears if the time data is deviated due to a power failure, or if a system controller that sets the time is not connected.

- 2) Date display
•When the main controller that can set the time is connected
Example: May 10, 2003

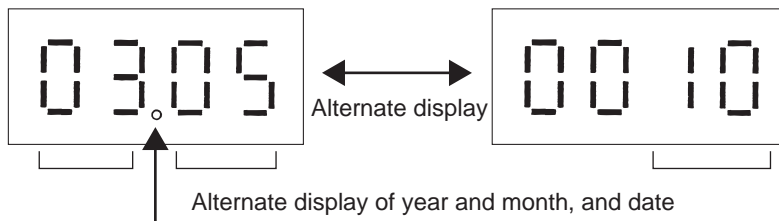

* Appears between the year and the month, and nothing appears when the date is displayed.

- When the main controller that can set the time is not connected
Example: 52 days after power was turned on

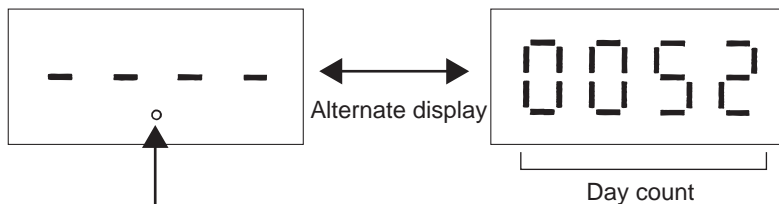

* Appears between the year and the month, and nothing appears when the date is displayed.

4. Table of LED Codes
LED monitor display

No	SW	Item	Display								Remarks	
	1234567890		LD1	LD2	LD3	LD4	LD5	LD6	LD7	LD8		
Current data	0	0000000000	Relay out-put display 1 Lighting	Comp in operation	Comp 1 in operation	Comp 2 in operation		52C1	52C2		Always lit	LD8 stays lit at all times while the power to the microcomputer is on.
			Check (error) display 1 OC/OS error	0000 to 9999 (Address and error codes highlighted)								
	1	1000000000	Check (error) display 2 OC/OS error	0000 to 9999 (Address and error codes highlighted)								Display of the latest preliminary error If no preliminary errors are detected, "----" appears on the display.
	2	0100000000	Check (error) display 3 (Including IC and BC)	0000 to 9999 (Address and error codes highlighted)								If no errors are detected, "----" appears on the display.
	3	1100000000	Relay out-put display 2	21S4a	21S4b	21S4c	CH11	CH12				
	4	0010000000	Relay out-put display 3	SV1		SV3						
	5	1010000000	Relay out-put display 4		SV5b	SV5c				52F		
	6	0110000000										
	7	1110000000	Special control	Retry operation								
	8	0001000000										
	9	1001000000	Communication demand capacity	0000 to 9999								
	10	0101000000	Contact point demand capacity	0000 to 9999								If not demanded controlled, "----" [%] appears on the display.
	11	1101000000	External signal (Open input contact point)		Night mode	Snow sensor	Cooling-heating change over (Cooling)	Cooling-heating change over (Heating)				
	12	0011000000										
	13	1011000000										
14	0111000000	Outdoor unit operation status		Warm up mode	20-seconds restart mode	Compressor in operation	Preliminary error	Error	20-seconds restart after instantaneous power failure	Preliminary vacuum operation protection		
15	1111000000											

[X LED Monitor Display on the Outdoor Unit Board]

	No	SW	Item	Display								Remarks												
		1234567890		LD1	LD2	LD3	LD4	LD5	LD6	LD7	LD8													
Current data	16	0000100000	Indoor unit check	Unit No. 1																				
	17	1000100000																						
	18	0100100000																						
	19	1100100000																						
	20	0010100000																						
	21	1010100000																						
	22	0110100000																						
	23	1110100000	Indoor unit Operation mode	Unit No. 1																			Lit during cooling Lit during heating Unlit while the unit is stopped or in the fan	
	24	0001100000																						
	25	1001100000																						
26	0101100000																							
27	1101100000																							
28	0011100000																							
29	1011100000																							
30	0111100000	Indoor unit thermostat	Unit No. 1																			Lit when thermostat is on Unlit when thermostat is off		
31	1111100000																							
32	0000010000																							
33	1000010000																							
34	0100010000																							
35	1100010000																							
36	0010010000																							
37	1010010000																							
38	0110010000																							
39	1110010000	Outdoor unit Operation mode	Permissible stop	Standby	Cooling			Heating																
40	0001010000																							
41	1001010000																							
42	0101010000	Outdoor unit control mode	Stop	Thermo OFF	Abnormal stop	Scheduled control	Initial start up	Defrost	Oil balance	Low frequency oil recovery														
43	1101010000		Warm up mode	Refrigerant recovery																				

	No	SW	Item	Display								Remarks	
		1234567890		LD1	LD2	LD3	LD4	LD5	LD6	LD7	LD8		
Current data	44	0011010000											
	45	1011010000	TH11					-99.9 to 999.9					The unit is [°C]
	46	0111010000	TH12					-99.9 to 999.9					
	47	1111010000											
	48	0000110000	TH5					-99.9 to 999.9					
	49	1000110000	TH6					-99.9 to 999.9					
	50	0100110000	TH7					-99.9 to 999.9					
	51	1100110000	TH8					-99.9 to 999.9					
	52	0010110000											
	53	1010110000											
	54	0110110000											
	55	1110110000											
	56	0001110000											
	57	1001110000											
	58	0101110000											
	59	1101110000											
	60	0011110000	THHS1					-99.9 to 999.9					The unit is [°C]
	61	1011110000											
	62	0111110000											
	63	1111110000	THHS5					-99.9 to 999.9					The unit is [°C]
	64	0000001000											
	65	1000001000											
	66	0100001000											
	67	1100001000											
	68	0010001000											
	69	1010001000											
	70	0110001000											
71	1110001000												
72	0001001000	High-pres- sure sensor data					-99.9 to 999.9					The unit is [kgf/cm ²]	
73	1001001000	Low-pres- sure sensor data					-99.9 to 999.9						
74	0101001000												
75	1101001000												
76	0011001000												
77	1011001000												

[X LED Monitor Display on the Outdoor Unit Board]

	No	SW	Item	Display								Remarks
		1234567890		LD1	LD2	LD3	LD4	LD5	LD6	LD7	LD8	
Current data	78	0111001000	$\sum \times Qj$	0000 to 9999								
	79	1111001000	$\sum \times Qjc$	0000 to 9999								
	80	0000101000	$\sum \times Qjh$	0000 to 9999								
	81	1000101000	Target Tc	-99.9 to 999.9								The unit is [°C]
	82	0100101000	Target Te	-99.9 to 999.9								
	83	1100101000	Tc	-99.9 to 999.9								
	84	0010101000	Te	-99.9 to 999.9								
	85	1010101000										
	86	0110101000										Control data [Hz]
	87	1110101000	All temporary frequencies	0000 to 9999								
	88	0001101000	Control frequency of COMP 1	0000 to 9999								
	89	0001101000	Control frequency of COMP 2	0000 to 9999								
	90	0101101000										Operation frequency of compressor [Hz] ^{*1}
	91	1101101000	Operation frequency of COMP 1	0000 to 9999								
	92	0011101000										
	93	1011101000										
	94	0111101000	AK1	0000 to 9999								Control data
	95	1111101000										Fan inverter output [%]
	96	0000111000										
	97	1000111000	FAN1	0000 to 9999								
98	0100111000											
99	1100111000										Outdoor LEV opening (Fully open: 480)	
100	0010011000	Number of fans in operation	0000 to 9999									
101	1010011000											
102	0110011000											
103	1110011000										0 to 480	
104	0001011000	LEV1										
105	1001011000											
106	0101011000											
107	1101011000											

*1. Output frequency of the inverter depends on the type of compressor and equals the integer multiples (X1, X2 etc.) of the operating frequency of the compressor.

	No	SW	Item	Display								Remarks
		1234567890		LD1	LD2	LD3	LD4	LD5	LD6	LD7	LD8	
Current data	108	0011011000	COMP 1 operation current (DC)	-99.9 to 999.9								Peak value [A]
	109	1011011000										
	110	0111011000										
	111	1111011000	COMP 1 bus voltage	0000 to 9999								The unit is [V]
	112	0000111000										
	113	1000111000										
	114	0100111000										
	115	1100111000										
	116	0010111000										
	117	1010111000	COMP1 Operation time Upper 4 digits	0000 to 9999								The unit is [h]
	118	0110111000	COMP1 Operation time Lower 4 digits	0000 to 9999								
	119	1110111000	COMP2 Operation time Upper 4 digits	0000 to 9999								
	120	0001111000	COMP2 Operation time Lower 4 digits	0000 to 9999								
	121	1001111000										
	122	0101111000										
	123	1101111000	COMP 1 number of start-stop events Upper 4 digits	0000 to 9999								Count-up at start-up The unit is [Time]
	124	0011111000	COMP 1 number of start-stop events Lower 4 digits	0000 to 9999								
	125	1011111000	COMP 2 number of start-stop events Upper 4 digits	0000 to 9999								
126	0111111000	COMP 2 number of start-stop events Lower 4 digits	0000 to 9999									
127	1111111000											
128	0000000100											

[X LED Monitor Display on the Outdoor Unit Board]

	No	SW	Item	Display								Remarks	
		1234567890		LD1	LD2	LD3	LD4	LD5	LD6	LD7	LD8		
Current data	129	1000000100											
	130	0100000100											
	131	1100000100											
	132	0010000100											
	133	1010000100											
	134	0110000100											
	135	1110000100											
	136	0001000100											
	137	1001000100											
	138	0101000100											
	139	1101000100											
	140	0011000100											
	141	1011000100											
	142	0111000100											
	143	1111000100											
	144	0000100100											
	145	1000100100											
	146	0100100100											
	147	1100100100											
	148	0010100100											
	149	1010100100											
	150	0110100100											
	151	1110100100											
	152	0001100100											
	153	1001100100											
	154	0101100100											
	155	1101100100											
	156	0011100100											
	157	1011100100											
	158	0111100100											
	159	1111100100											
	160	000010100											
	161	100010100											
	162	010010100											
	163	110010100											

No	SW	Item	Display								Remarks	
	1234567890		LD1	LD2	LD3	LD4	LD5	LD6	LD7	LD8		
Current data	164	0010010100										
	165	1010010100										
	166	0110010100										
	167	1110010100										
	168	0001010100										
	169	1001010100										
	170	0101010100										
	171	1101010100										
	172	0011010100										
	173	1011010100										
	174	0111010100										
	175	1111010100										
	176	0000110100										
	177	1000110100										
	178	0100110100	Error history 1	0000 to 9999								Address and error codes highlighted If no errors are detected, "----" appears on the display.
	179	1100110100	Error details of inverter	Error details of inverter (0001-0120)								
	180	0010110100	Error history 2	0000 to 9999								
	181	1010110100	Error details of inverter	Error details of inverter (0001-0120)								
	182	0110110100	Error history 3	0000 to 9999								
	183	1110110100	Error details of inverter	Error details of inverter (0001-0120)								
184	0001110100	Error history 4	0000 to 9999									
185	1001110100	Error details of inverter	Error details of inverter (0001-0120)									
186	0101110100	Error history 5	0000 to 9999									
187	1101110100	Error details of inverter	Error details of inverter (0001-0120)									
188	0011110100	Error history 6	0000 to 9999									
189	1011110100	Error details of inverter	Error details of inverter (0001-0120)									

[X LED Monitor Display on the Outdoor Unit Board]

	No	SW	Item	Display								Remarks
		1234567890		LD1	LD2	LD3	LD4	LD5	LD6	LD7	LD8	
Current data	190	011110100	Error history 7	0000 to 9999								Address and error codes highlighted If no errors are detected, "----" appears on the display.
	191	111110100	Error details of inverter	Error details of inverter (0001-0120)								
	192	0000001100	Error history 8	0000 to 9999								
	193	1000001100	Error details of inverter	Error details of inverter (0001-0120)								
	194	0100001100	Error history 9	0000 to 9999								
	195	1100001100	Error details of inverter	Error details of inverter (0001-0120)								
	196	0010001100	Error history 10	0000 to 9999								
	197	1010001100	Error details of inverter	Error details of inverter (0001-0120)								
	198	0110001100	Error history of inverter (At the time of last data backup before error)	0000 to 9999								
	199	1110001100	Error details of inverter	Error details of inverter (0001-0120)								
	200	0001001100										
Data before error	201	1001001100	Outdoor unit operation status		Warm up mode	20-seconds re-start mode	Compressor in operation	Preliminary error	Error	20-seconds re-start after instantaneous power failure	Preliminary vacuum operation protection	
	202	0101001100										
	203	1101001100										
	204	0011001100										
	205	1011001100	Outdoor unit Operation mode	Permissible stop	Standby	Cooling		Heating				
	206	0111001100										
	207	1111001100										
	208	0000101100	Outdoor unit control mode	Stop	Thermo OFF	Abnormal stop	Scheduled control	Initial start up	Defrost	Oil balance	Low frequency oil recovery	
	209	1000101100		Warm up mode	Refrigerant recovery							

No	SW	Item	Display								Remarks			
	1234567890		LD1	LD2	LD3	LD4	LD5	LD6	LD7	LD8				
Data before error	210	0100101100												
	211	1100101100	Relay out-put display 1 Lighting	Comp in operation	Comp 1 in operation	Comp 2 in operation		52C1	52C2		Always lit			
	212	0010101100	Relay out-put display 2 Lighting	21S4a	21S4b	21S4c	CH11	CH12						
	213	1010101100	Relay out-put display 3 Lighting	SV1		SV3								
	214	0110101100	Relay out-put display 4 Lighting		SV5b	SV5c				52F				
	215	1110101100												
	216	0001101100	TH11									-99.9 to 999.9	The unit is [°C]	
	217	1001101100	TH12									-99.9 to 999.9		
	218	0101101100												
	219	1101101100	TH5									-99.9 to 999.9		
	220	0011101100	TH6									-99.9 to 999.9		
	221	1011101100	TH7									-99.9 to 999.9		
	222	0111101100	TH8									-99.9 to 999.9		
	223	1111101100												
	224	0000011100												
	225	1000011100												
	226	0100011100												
	227	1100011100												
	228	0010011100												
	229	1010011100												
	230	0110011100												
	231	1110011100	THHS1										-99.9 to 999.9	The unit is [°C]
	232	0001011100												
	233	1001011100												
234	0101011100	THHS5										-99.9 to 999.9	The unit is [°C]	
235	1101011100													
236	0011011100													
237	1011011100													
238	0111011100													
239	1111011100													
240	0000111100													
241	1000111100													
242	0100111100													

*The data before an error occurs is not displayed for maximum of one minute after the power is turned on. It may not be displayed even on the models that are equipped with display function of such data.

[X LED Monitor Display on the Outdoor Unit Board]

No	SW	Item	Display								Remarks	
	1234567890		LD1	LD2	LD3	LD4	LD5	LD6	LD7	LD8		
Data before error	243	1100111100	High-pres- sure sensor data	-99.9 to 999.9								The unit is [kgf/cm ²]
	244	0010111100	Low-pres- sure sensor data	-99.9 to 999.9								
	245	1010111100										
	246	0110111100										
	247	1110111100										
	248	0001111100										
	249	1001111100	∑ × Qj	0000 to 9999								
	250	0101111100	∑ × Qjc	0000 to 9999								
	251	1101111100	∑ × Qjh	0000 to 9999								The unit is [°C]
	252	0011111100	Target Tc	-99.9 to 999.9								
	253	1011111100	Target Te	-99.9 to 999.9								
	254	0111111100	Tc	-99.9 to 999.9								
	255	1111111100	Te	-99.9 to 999.9								
	256	0000000010										
	257	1000000010										Control data [Hz]
	258	0100000010	All tempo- rary frequen- cies	0000 to 9999								
	259	1100000010	Control fre- quency of COMP 1	0000 to 9999								
	260	0010000010	Control fre- quency of COMP 2	0000 to 9999								
	261	1010000010										Operation fre- quency of com- pressor [Hz] ^{*1}
	262	0110000010	Operation frequency of COMP 1	0000 to 9999								
263	1110000010											
264	0001000010											
265	1001000010	AK1	0000 to 9999								Control data	
266	0101000010											
267	1101000010										Fan inverter out- put [%]	
268	0011000010	FAN1	0000 to 9999									
269	1011000010											
270	0111000010											

*1. Output frequency of the inverter depends on the type of compressor and equals the integer multiples (X1, X2 etc.) of the operating frequency of the compressor.

No	SW	Item	Display								Remarks	
	1234567890		LD1	LD2	LD3	LD4	LD5	LD6	LD7	LD8		
Data before error	271	1111000010	Number of fans in operation	0000 to 9999								
	272	0000100010										
	273	1000100010										
	274	0100100010										
	275	1100100010	LEV1	0 to 480								Outdoor LEV opening (Fully open: 480)
	276	0010100010										
	277	1010100010										
	278	0110100010										
	279	1110100010	COMP 1 operation current (DC)	-99.9 to 999.9								Peak value [A]
	280	0001100010										
	281	1001100010										
	282	0101100010	COMP 1 bus voltage	-99.9 to 999.9								The unit is [V]
	283	1101100010										
	284	0011100010										
	285	1011100010										
	286	0111100010										
	287	1111100010										
	288	0000010010	COMP 1 Operation time Upper 4 digits	0000 to 9999								The unit is [h]
	289	1000010010	COMP 1 Operation time Lower 4 digits	0000 to 9999								
	290	0100010010	COMP 2 Operation time Upper 4 digits	0000 to 9999								
	291	1100010010	COMP 2 Operation time Lower 4 digits	0000 to 9999								
	292	0010010010										
	293	1010010010										
	294	0110010010	COMP 1 number of start-stop events Upper 4 digits	0000 to 9999								Count-up at start-up The unit is [Time]

[X LED Monitor Display on the Outdoor Unit Board]

	No	SW	Item	Display								Remarks
		1234567890		LD1	LD2	LD3	LD4	LD5	LD6	LD7	LD8	
Data before error	295	1110010010	COMP 1 number of start-stop events Lower 4 dig- its	0000 to 9999								Count-up at start-up The unit is [Time]
	296	0001010010	COMP 2 number of start-stop events Upper 4 dig- its	0000 to 9999								
	297	1001010010	COMP 2 number of start-stop events Lower 4 dig- its	0000 to 9999								
	298	0101010010										
	299	1101010010										
Current data	300	0011010010										
	301	1011010010										
	302	0111010010										
	303	1111010010										
	304	0000110010										
	305	1000110010										
	306	0100110010										
	307	1100110010										
	308	0010110010										
	309	1010110010										
	310	0110110010										
	311	1110110010										
	312	0001110010										
	313	1001110010										
	314	0101110010										
	315	1101110010										
	316	0011110010										
	317	1011110010										
	318	0111110010										
	319	1111110010										
	320	000001010										
	321	100001010										

No	SW	Item	Display								Remarks	
	1234567890		LD1	LD2	LD3	LD4	LD5	LD6	LD7	LD8		
Current data	322	0100001010										
	323	1100001010										
	324	0010001010										
	325	1010001010										
	326	0110001010										
	327	1110001010										
	328	0001001010										
	329	1001001010										
	330	0101001010										
	331	1101001010										
	332	0011001010										
	333	1011001010										
	334	0111001010										
	335	1111001010										
	336	0000101010										
	337	1000101010										
	338	0100101010										
	339	1100101010										
	340	0010101010										
	341	1010101010										
	342	0110101010										
	343	1110101010										
	344	0001101010										
	345	1001101010										
	346	0101101010										
	347	1101101010										
	348	0011101010										
	349	1011101010										
350	0111101010											

[X LED Monitor Display on the Outdoor Unit Board]

No	SW	Item	Display								Remarks
	1234567890		LD1	LD2	LD3	LD4	LD5	LD6	LD7	LD8	
351	1111101010	IC1 Address/ca- pacity code	0000 to 9999				0000 to 9999				Displayed alter- nately every 5 seconds
352	0000011010										
353	1000011010										
354	0100011010										
355	1100011010										
356	0010011010										
357	1010011010										
358	0110011010										
359	1110011010										
360	0001011010										
361	1001011010										
362	0101011010										
363	1101011010										
364	0011011010										
365	1011011010										
366	0111011010										
367	1111011010										
368	0000111010										
369	1000111010										
370	0100111010										
371	1100111010										
372	0010111010										
373	1010111010										
374	0110111010										
375	1110111010										
376	0001111010										
377	1001111010										
378	0101111010										
379	1101111010										
380	0011111010										
381	1011111010										
382	0111111010										
383	1111111010										
384	0000001110										

No	SW	Item	Display								Remarks	
	1234567890		LD1	LD2	LD3	LD4	LD5	LD6	LD7	LD8		
Data on indoor unit system	385	1000000110										
	386	0100000110										
	387	1100000110										
	388	0010000110										
	389	1010000110										
	390	0110000110										
	391	1110000110										
	392	0001000110										
	393	1001000110										
	394	0101000110										
	395	1101000110										
	396	0011000110										
	397	1011000110										
	398	0111000110										
	399	1111000110										
	400	0000100110										
	401	1000100110										
	402	0100100110										
	403	1100100110										
	404	0010100110										
405	1010100110											
406	0110100110											
407	1110100110	IC Preset temperature										The unit is [°C]
408	0001100110	IC1 Suction temperature										
409	1001100110											
410	0101100110											
411	1101100110											
412	0011100110											
413	1011100110											
414	0111100110											
415	1111100110											
416	0000010110											

[X LED Monitor Display on the Outdoor Unit Board]

No	SW	Item	Display								Remarks
	1234567890		LD1	LD2	LD3	LD4	LD5	LD6	LD7	LD8	
417	1000010110										
418	0100010110										
419	1100010110										
420	0010010110										
421	1010010110										
422	0110010110										
423	1110010110										
424	0001010110										
425	1001010110										
426	0101010110										
427	1101010110										
428	0011010110										
429	1011010110										
430	0111010110										
431	1111010110										
432	0000110110										
433	1000110110										
434	0100110110										
435	1100110110										
436	0010110110										
437	1010110110										
438	0110110110										
439	1110110110										
440	0001110110										
441	1001110110										
442	0101110110										
443	1101110110										
444	0011110110										
445	1011110110										

No	SW	Item	Display								Remarks
	1234567890		LD1	LD2	LD3	LD4	LD5	LD6	LD7	LD8	
446	0111110110										
447	1111110110										
448	0000001110										
449	1000001110										
450	0100001110										
451	1100001110										
452	0010001110										
453	1010001110										
454	0110001110										
455	1110001110										
456	0001001110										
457	1001001110										
458	0101001110	IC1 Liquid pipe temperature	-99.9 to 999.9								The unit is [°C]
459	1101001110										
460	0011001110										
461	1011001110										
462	0111001110										
463	1111001110										
464	0000101110										
465	1000101110										
466	0100101110										
467	1100101110										
468	0010101110										
469	1010101110										
470	0110101110										
471	1110101110										
472	0001101110										
473	1001101110										
474	0101101110										
475	1101101110										
476	0011101110										
477	1011101110										
478	0111101110										
479	1111101110										
480	0000011110										
481	1000011110										
482	0100011110										
483	1100011110										
484	0010011110										
485	1010011110										
486	0110011110										
487	1110011110										
488	0001011110										
489	1001011110										

[X LED Monitor Display on the Outdoor Unit Board]

No	SW	Item	Display								Remarks
	1234567890		LD1	LD2	LD3	LD4	LD5	LD6	LD7	LD8	
490	0101011110										
491	1101011110										
492	0011011110										
493	1011011110										
494	0111011110										
495	1111011110										
496	0000111110										
497	1000111110										
498	0100111110										
499	1100111110										
500	0010111110										
501	1010111110										
502	0110111110										
503	1110111110										
504	0001111110										
505	1001111110										
506	0101111110										
507	1101111110										
508	0011111110										
509	1011111110										
510	0111111110										
511	1111111110										
512	0000000001	Self-address	Alternate display of self address and unit model								
513	1000000001	IC address	Count-up display of number of connected units								
514	0100000001										
515	1100000001										
516	0010000001										
517	1010000001	Main board S/W version etc.	S/W version -> Refrigerant type -> Model and capacity -> Communication address								Refer to 2. "LED display at initial setting".
518	0110000001										
519	1110000001										
520	0001000001										
521	1001000001										
522	0101000001										
523	1101000001	IC1 Gas pipe temperature	-99.9 to 999.9								The unit is [°C]
524	0011000001										
525	1011000001										
526	0111000001										
527	1111000001										
528	0000100001										
529	1000100001										
530	0100100001										

No	SW	Item	Display								Remarks	
	1234567890		LD1	LD2	LD3	LD4	LD5	LD6	LD7	LD8		
Data on indoor unit system	531	1100100001										
	532	0010100001										
	533	1010100001										
	534	0110100001										
	535	1110100001										
	536	0001100001										
	537	1001100001										
	538	0101100001										
	539	1101100001										
	540	0011100001										
	541	1011100001										
	542	0111100001										
	543	1111100001										
	544	0000010001										
	545	1000010001										
	546	0100010001										
	547	1100010001										
	548	0010010001										
	549	1010010001										
	550	0110010001										
	551	1110010001										
	552	0001010001										
	553	1001010001										
	554	0101010001										
	555	1101010001										
	556	0011010001										
	557	1011010001										
	558	0111010001										
	559	1111010001										
	560	0000110001										
	561	1000110001										
	562	0100110001										
	563	1100110001										
	564	0010110001										
	565	1010110001										
	566	0110110001										
	567	1110110001										
	568	0001110001										
	569	1001110001										
	570	0101110001										

[X LED Monitor Display on the Outdoor Unit Board]

No	SW	Item	Display								Remarks
	1234567890		LD1	LD2	LD3	LD4	LD5	LD6	LD7	LD8	
571	1101110001										
572	0011110001										
573	1011110001	IC1SH	-99.9 to 999.9								The unit is [deg°C]
574	0111110001										
575	1111110001										
576	0000001001										
577	1000001001										
578	0100001001										
579	1100001001										
580	0010001001										
581	1010001001										
582	0110001001										
583	1110001001										
584	0001001001										
585	1001001001										
586	0101001001										
587	1101001001										
588	0011001001										
589	1011001001										
590	0111001001										
591	1111001001										
592	0000101001										
593	1000101001										
594	0100101001										
595	1100101001										
596	0010101001										
597	1010101001										
598	0110101001										
599	1110101001										
600	0001101001										
601	1001101001										
602	0101101001										
603	1101101001										
604	0011101001										
605	1011101001										
606	0111101001										
607	1111101001										
608	0000011001										
609	1000011001										

No	SW	Item	Display								Remarks
	1234567890		LD1	LD2	LD3	LD4	LD5	LD6	LD7	LD8	
610	0100011001										
611	1100011001										
612	0010011001										
613	1010011001										
614	0110011001										
615	1110011001										
616	0001011001										
617	1001011001										
618	0101011001										
619	1101011001										
620	0011011001										
621	1011011001										
622	0111011001										
623	1111011001	IC1SC									The unit is [deg°C]
624	0000111001										
625	1000111001										
626	0100111001										
627	1100111001										
628	0010111001										
629	1010111001										
630	0110111001										
631	1110111001										
632	0001111001										
633	1001111001										
634	0101111001										
635	1101111001										
636	0011111001										
637	1011111001										
638	0111111001										
639	1111111001										
640	000000101										
641	100000101										
642	010000101										
643	110000101										
644	001000101										
645	101000101										
646	011000101										
647	111000101										
648	0001000101										

[X LED Monitor Display on the Outdoor Unit Board]

	No	SW	Item	Display								Remarks	
		1234567890		LD1	LD2	LD3	LD4	LD5	LD6	LD7	LD8		
Data on indoor unit system	649	1001000101											
	650	0101000101											
	651	1101000101											
	652	0011000101											
	653	1011000101											
	654	0111000101											
	655	1111000101											
	656	0000100101											
	657	1000100101											
	658	0100100101											
	659	1100100101											
	660	0010100101											
	661	1010100101											
	662	0110100101											
	663	1110100101											
	664	0001100101											
	665	1001100101											
	666	0101100101											
	667	1101100101											
	668	0011100101											
	669	1011100101											
	670	0111100101											
	671	1111100101											
	672	0000010101											
	673	1000010101											
	674	0100010101											
	675	1100010101											
Setting data	676	0010010101	Compressor INV board S/W version	0.00 to 99.99									
	677	1010010101											
	678	0110010101											
	679	1110010101	Fan INV board S/W version	0.00 to 99.99									
	680	0001010101											
	681	1001010101											
	682	0101010101											
	683	1101010101											
	684	0011010101											
	685	1011010101											

No	SW	Item	Display								Remarks	
	1234567890		LD1	LD2	LD3	LD4	LD5	LD6	LD7	LD8		
Setting data	686	0111010101										
	687	1111010101										
	688	0000110101	Current time	00:00 to 23:59								Hour: minute
	689	1000110101	Current time -2	00.00 to 99.12 / 1 to 31								Year and month, and date alter- nate display
	690	0100110101	Time of error detection 1	00:00 to 23:59								Hour: minute
	691	1100110101	Time of error detection 1- 2	00.00 to 99.12 / 1 to 31								Year and month, and date alter- nate display
	692	0010110101	Time of error detection 2	00:00 to 23:59								Hour: minute
	693	1010110101	Time of error detection 2- 2	00.00 to 99.12 / 1 to 31								Year and month, and date alter- nate display
	694	0110110101	Time of error detection 3	00:00 to 23:59								Hour: minute
	695	1110110101	Time of error detection 3- 2	00.00 to 99.12 / 1 to 31								Year and month, and date alter- nate display
	696	0001110101	Time of error detection 4	00:00 to 23:59								Hour: minute
	697	1001110101	Time of error detection 4- 2	00.00 to 99.12 / 1 to 31								Year and month, and date alter- nate display
	698	0101110101	Time of error detection 5	00:00 to 23:59								Hour: minute
	699	1101110101	Time of error detection 5- 2	00.00 to 99.12 / 1 to 31								Year and month, and date alter- nate display
	700	0011110101	Time of error detection 6	00:00 to 23:59								Hour: minute
	701	1011110101	Time of error detection 6- 2	00.00 to 99.12 / 1 to 31								Year and month, and date alter- nate display
	702	0111110101	Time of error detection 7	00:00 to 23:59								Hour: minute
	703	1111110101	Time of error detection 7- 2	00.00 to 99.12 / 1 to 31								Year and month, and date alter- nate display
	704	0000001101	Time of error detection 8	00:00 to 23:59								Hour: minute
	705	1000001101	Time of error detection 8- 2	00.00 to 99.12 / 1 to 31								Year and month, and date alter- nate display
706	0100001101	Time of error detection 9	00:00 to 23:59								Hour: minute	
707	1100001101	Time of error detection 9- 2	00.00 to 99.12 / 1 to 31								Year and month, and date alter- nate display	
708	0010001101	Time of error detection 10	00:00 to 23:59								Hour: minute	
709	1010001101	Time of error detection 10-2	00.00 to 99.12 / 1 to 31								Year and month, and date alter- nate display	

[X LED Monitor Display on the Outdoor Unit Board]

	No	SW	Item	Display								Remarks
		1234567890		LD1	LD2	LD3	LD4	LD5	LD6	LD7	LD8	
Setting data	710	0110001101	Time of last data backup before error	00:00 to 23:59								Hour: minute
	711	1110001101	Time of last data backup before error -2	00.00 to 99.12 / 1 to 31								Year and month, and date alternate display
	712	0001001101										
	713	1001001101										
Data on indoor unit system	714	0101001101	IC1 LEV opening	0000 to 2000								Fully open: 2000
	715	1101001101										
	716	0011001101										
	717	1011001101										
	718	0111001101										
	719	1111001101										
	720	0000101101										
	721	1000101101										
	722	0100101101										
	723	1100101101										
	724	0010101101										
	725	1010101101										
	726	0110101101										
	727	1110101101										
	728	0001101101										
	729	1001101101										
	730	0101101101										
	731	1101101101										
	732	0011101101										
	733	1011101101										
734	0111101101											
735	1111101101											
736	0000011101											
737	1000011101											

No	SW	Item	Display								Remarks	
	1234567890		LD1	LD2	LD3	LD4	LD5	LD6	LD7	LD8		
Data on indoor unit system	738	0100011101										
	739	1100011101										
	740	0010011101										
	741	1010011101										
	742	0110011101										
	743	1110011101										
	744	0001011101										
	745	1001011101										
	746	0101011101										
	747	1101011101										
	748	0011011101										
	749	1011011101										
	750	0111011101										
	751	1111011101										
	752	0000111101										
	753	1000111101										
	754	0100111101										
	755	1100111101										
	756	0010111101										
	757	1010111101										
758	0110111101											
759	1110111101											
760	0001111101											
761	1001111101											
762	0101111101											
763	1101111101											
764	0011111101	IC1 Operation mode	0000 : Stop 0001 : Ventilation 0002 : Cooling 0003 : Heating 0004 : Dry									
765	1011111101											
766	0111111101											
767	1111111101											
768	0000000011											
769	1000000011											
770	0100000011											

[X LED Monitor Display on the Outdoor Unit Board]

No	SW	Item	Display								Remarks
	1234567890		LD1	LD2	LD3	LD4	LD5	LD6	LD7	LD8	
Data on indoor unit system	771	1100000011									
	772	0010000011									
	773	1010000011									
	774	0110000011									
	775	1110000011									
	776	0001000011									
	777	1001000011									
	778	0101000011									
	779	1101000011									
	780	0011000011									
	781	1011000011									
	782	0111000011									
	783	1111000011									
	784	0000100011									
	785	1000100011									
	786	0100100011									
	787	1100100011									
	788	0010100011									
	789	1010100011									
	790	0110100011									
791	1110100011										
792	0001100011										
793	1001100011										
794	0101100011										
795	1101100011										
796	0011100011										
797	1011100011										
798	0111100011										
799	1111100011										

0000 : Stop
0001 : Ventilation
0002 : Cooling
0003 : Heating
0004 : Dry

No	SW	Item	Display								Remarks
	1234567890		LD1	LD2	LD3	LD4	LD5	LD6	LD7	LD8	
800	0000010011										
801	1000010011										
802	0100010011										
803	1100010011										
804	0010010011										
805	1010010011										
806	0110010011										
807	1110010011										
808	0001010011										
809	1001010011										
810	0101010011										
811	1101010011										
812	0011010011										
813	1011010011										
814	0111010011	IC1 filter	0000 to 9999								Hours since last maintenance [h]
815	1111001001										
816	0000101011										
817	1000101011										
818	0100101011										
819	1100101011										
820	0010101011										
821	1010101011										
822	0110101011										
823	1110101011										
824	0001101011										
825	1001101011										
826	0101101011										
827	1101101011										
828	0011101011										
829	1011101011										
830	0111101011										
831	1111101011										
832	0000011011										
833	1000011011										
834	0100011011										
835	1100011011										
836	0010011011										
837	1010011011										
838	0110011011										
839	1110011011										

[X LED Monitor Display on the Outdoor Unit Board]

	No	SW	Item	Display								Remarks	
		1234567890		LD1	LD2	LD3	LD4	LD5	LD6	LD7	LD8		
Data on indoor unit system	840	0001011011											
	841	1001011011											
	842	0101011011											
	843	1101011011											
	844	0011011011											
	845	1011011011											
	846	0111001001											
	847	1111001011											
	848	0000101011											
	849	1000101011											
	850	0100101011											
	851	1100101011											
	852	0010101011											
	853	1010101011											
	854	0110101011											
	855	1110101011											
	856	0001101011											
	857	1001101011											
	858	0101101011											
	859	1101101011											
860	0011101011												
861	1011101011												
862	0111101011												
863	1111101011												
Other types of data	864	0000011011											
	865	1000011011											
	866	0100011011											
	867	1100011011											
	868	0010011011											
	869	1010011011											
	870	0110011011											
	871	1110011011	U-phase current effective value 1					-99.9 to 999.9					The unit is [A]
	872	0001011011	W-phase current effective value 1					-99.9 to 999.9					
	873	1001011011	Power factor phase angle 1					-99.9 to 999.9					The unit is [deg°C]
	874	0101011011											

No	SW	Item	Display								Remarks		
	1234567890		LD1	LD2	LD3	LD4	LD5	LD6	LD7	LD8			
Other types of data	875	1101011011											
	876	0011011011											
	877	1011011011											
	878	0111011011											
	879	1111011011											
	880	0000111011	Main board Reset counter					0 to 254					The unit is [time]
	881	1000111011	Compressor INV board Reset counter					0 to 254					
	882	0100111011											
	883	1100111011											
	884	0010111011	Fan INV board Reset counter					0 to 254					The unit is [time]
	885	1010111011											
	886	0110111011											
	887	1110111011											
	888	0001111011											
	889	1001111011											
	890	0101111011											
	891	1101111011											
	892	0011111011											
	893	1011111011											
	894	0111111011											
	895	1111111011											
	896	0000000111											
	897	1000000111											
	898	0100000111											
	899	1100000111											
	900	0010000111											
	901	1010000111											
	902	0110000111											
	903	1110000111											
	904	0001000111											
905	1001000111												
906	0101000111												
907	1101000111												
1020	0011111111												
1021	1011111111												
1022	0111111111												
1023	1111111111												

**Service Handbook PU(H)Y-P250YGM-A
PUHY-P500YGM-A
PFD-P250VM-E
PFD-P500VM-E**

