



PEFY-P32VMS1-E

Indoor Unit

Ultra Thin Ceiling Concealed Ducted



The ultra thin ceiling concealed ducted indoor unit offers increased flexibility and is particularly suitable for places where low noise operation is desired from a slimline body.

- **Ultra thin body - height of only 200mm**
- **Extremely quiet operation - as low as 22dBA**
- **Cooling operation set temperature can be set down to 14°C db when used with R410A**
- **Static Pressures of 5-50Pa**



Pictures not to scale

Product Details

PEFY-P32VMS1-E	
Capacity (kW):	
Heating (Nominal)	4.0
Cooling (Nominal)	3.6
Heating (UK)	4.0
Cooling (UK)	3.4
R410A High Sensible Cooling (UK)	2.6
SHF R410A (UK)	0.76
SHF High Sensible R410A (UK)	0.85
Power Input (kW) Heating (Nominal)	0.05
Power Input (kW) Cooling (Nominal)	0.07
Airflow(m ³ /min) - Lo-Mi1-Mi2	6-8-10
External Static Pressure Pa - Lo-Mi-Hi	5-15-50
Noise (dBA) - Lo-Mi1-Mi2	24-27-32
Width - mm	700
Depth - mm	790
Height - mm	200
Weight - kg	20
Electrical Supply	220-240v, 50Hz
Phase	Single
Mains Cable No. Cores	3
Running Current (A) - Heating	0.39
Running Current (A) - Cooling	0.5
Fuse Rating (BS88) - HRC (A)	6

Dimensions

PEFY-P32VMS1-E

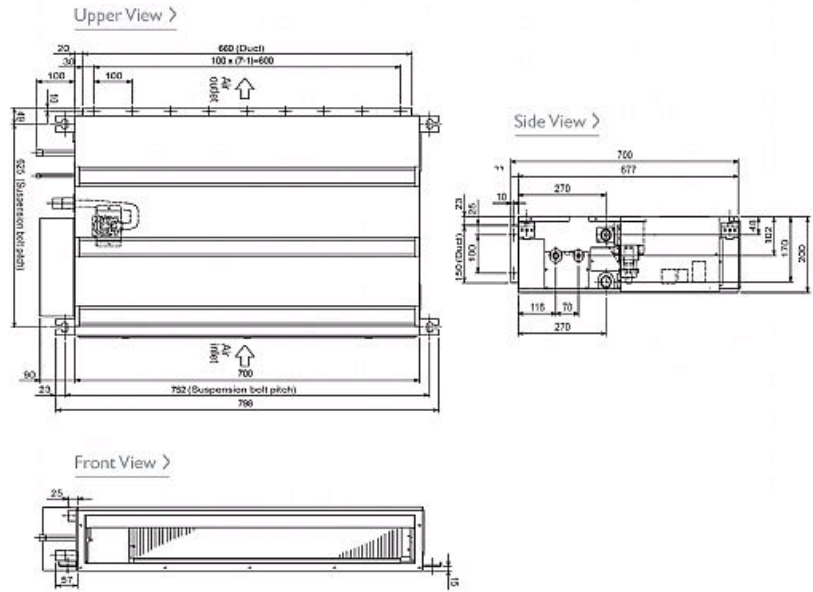

Telephone: 01707 282880

Email: air.conditioning@meuk.mee.com Website: <http://www.mitsubishielectric.co.uk/aircon>

Mitsubishi Electric reserves the right to make any variation in technical specification to the equipment described, or to withdraw or replace products without prior notification or public announcement.

Tel:
Fax:

