

Fresh Master

Models:

**GUF-50RDH4, GUF-50RD4
GUF-100RDH4, GUF-100RD4**

Operating Instructions

(For the user)

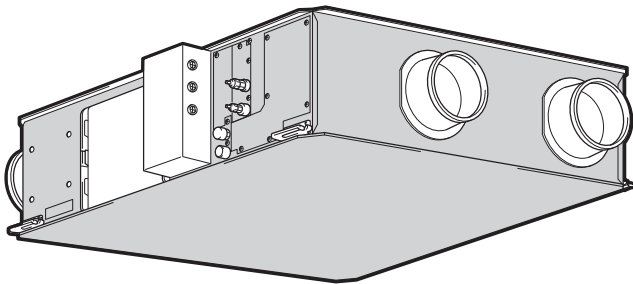

GUF-50RDH4 shown above.

Humidifier function not available on GUF-50RD4 and GUF-100RD4.

English is original. The other languages versions are translation of the original.

Contents

1. Safety precautions.....	2-3
1.1. Installation	2
1.2. During operation.....	3
1.3. Disposing of the unit.....	3
2. Names and functions of various parts	4-6
3. How to operate	7-9
3.1. When interlocked with an indoor unit	7
3.2. When not interlocked with an indoor unit	7
3.2.1. Before starting operation.....	7
3.2.2. ON/OFF.....	7
3.2.3. Selecting operation	7
3.2.4. Temperature adjustment	8
3.2.5. Fan speed adjustment.....	8
3.2.6. Time setting.....	8
3.2.7. Timer setting	9
4. Cleaning the machine.....	10-11
5. Inspection and maintenance (GUF-50-100RDH4 only).....	11-13
6. Troubleshooting.....	13
7. Installation and transferring works, and checking ...	14
8. Specifications	14







Please read through these instructions in order to familiarize yourself with the proper and safe procedures for operating the Fresh Master.



After reading this manual, keep it in an easily accessible and safe place for future reference.

The warranty will not apply to damage resulting from failure to follow the warnings and precautions included in the Operating Instructions.

For use with the R410A & R407C

1. Safety precautions

 WARNING	
 Prohibited	<ul style="list-style-type: none"> - Do not turn the remote controller on or off when flammable gas has leaked. <ul style="list-style-type: none"> - It could catch fire or cause explosion with sparks released from electric contractor. - Open windows to ventilate.
 Do not disassemble	<ul style="list-style-type: none"> - Do not modify or disassemble. <ul style="list-style-type: none"> - It could cause fire, electric shock or injury.
 Do not wet	<ul style="list-style-type: none"> - Do not apply water to the unit and remote controller. <ul style="list-style-type: none"> - Electrical shock can result.
 Do not touch	<ul style="list-style-type: none"> - Do not poke your fingers or sticks into the air intake and outlet while the product is operating. <ul style="list-style-type: none"> - Failure to heed this warning may result in injury.
	 Wet hands prohibited
	 The instructions given must be followed.
	<ul style="list-style-type: none"> - Don't operate with wet hands. <ul style="list-style-type: none"> - Electrical shock can result. - Use the specified power supply and voltage. <ul style="list-style-type: none"> - Use of incorrect power supply could cause fire or electric shock. - Make sure the power supply isolator is turned off on the power distribution panel before starting maintenance. <ul style="list-style-type: none"> - It could cause electric shock or injury if it is turned on. - When any abnormal conditions (burning smell, or others) are observed, stop operation, turn off the power supply isolator on the power distribution panel and consult your dealer. <ul style="list-style-type: none"> - Continuing operation under such conditions could cause, electric shock, fire, or damage.

 CAUTION	
 Prohibited	<ul style="list-style-type: none"> - Do not place a burning appliance in a place where it is exposed directly to the wind from Fresh Master. <ul style="list-style-type: none"> - It could cause an accident as a result of incomplete combustion. - Don't operate with the "BY-PASS" when heating the room in winter. <ul style="list-style-type: none"> - Condensed water may drip from the unit and wet the surface of ceiling.) - Do not use at a place where exposed to high temperatures (40°C or higher), naked flames, or in environment with heavy fumes. <ul style="list-style-type: none"> - It could cause fire. - Do not use in an environment such as a chemical factory, where hazardous gases such as acidic gases, alkaline gases, organic solvent fumes, paint fumes, or gases containing corrosive components are generated. <ul style="list-style-type: none"> - It could malfunction.
	 The instructions given must be followed.
	<ul style="list-style-type: none"> - Securely install parts after maintenance. <ul style="list-style-type: none"> - It could cause injury if parts fall. - Put on gloves during maintenance. <ul style="list-style-type: none"> - It could cause injury. - Make sure the power supply isolator is turned off on the power distribution panel when Fresh Master is not used for a long period of time. <ul style="list-style-type: none"> - It could cause electric shock, power leakage, or fire as a result of deteriorated insulation. - The appliance is not be used by children or persons with reduced physical, sensory or mental capabilities, or lack of experience and knowledge, unless they have been given supervision or instruction. <ul style="list-style-type: none"> - Children should be supervised to ensure that they do not play with the appliance.

- ▶ Before operating the unit, make sure you read all the "Safety precautions".
- ▶ "Safety precautions" lists important points about safety. Please be sure to follow them.

Symbols used in the text

Warning:

Describes precautions that should be observed to avoid the risk of injury or death to the user.

Caution:

Describes precautions that should be observed to prevent damage to the unit.

Symbols used in the illustrations



: Indicates that important instructions must be followed.



: Indicates a part which must be grounded.



: Beware of electric shock. (This symbol is displayed on the main unit label.) <Colour: Yellow>

Warning:

Carefully read the labels affixed to the main unit.

1.1. Installation

- ▶ After you have read this manual, keep it and the Installation Manual in a safe place for easy reference whenever a question arises. If the unit is going to be operated by another person, make sure that this manual is given to him or her.

Warning:

- Never charge any types of refrigerant other than those specified by Mitsubishi Electric. Failure to follow this warning may result in violation of law, or blowout, explosion or fire when the product is used, serviced, or disposed of. The types of refrigerant that can be used are specified in the manual supplied with the product or on the product nameplate. Mitsubishi Electric shall assume no liability for any damage, breakdown, malfunction, or accident resulting from the charging of a refrigerant not specified by Mitsubishi Electric.
- The unit should not be installed by the user. Ask the dealer or an authorized company to install the unit. If the unit is installed improperly, water leakage, electric shock or fire may result.
- Use only accessories authorized by Mitsubishi Electric and ask your dealer or an authorized company to install them. If accessories are installed improperly, water leakage, electric shock or fire may result.
- The Installation Manual details the suggested installation method. Any structural alteration necessary for installation must comply with local building code requirements.
- Never repair the unit or transfer it to another site by yourself. If repair is performed improperly, water leakage, electric shock or fire may result. If you need to have the unit repaired or moved, consult your dealer.
- The appliance is not to be used by children or persons with reduced physical, sensory or mental capabilities, or lack of experience and knowledge, unless they have been given supervision or instruction.

- Children should be supervised to ensure that they do not play with the appliance.

1) Outdoor unit

⚠ Warning:

- The outdoor unit must be installed on a stable, level surface, in a place where there is no accumulation of snow, leaves or rubbish.
- Do not stand on, or place any items on the unit. You may fall down or the item may fall, causing injury.

⚠ Caution:

- The outdoor unit should be installed in a location where air and noise emitted by the unit will not disturb the neighbours.

2) Fresh Master

⚠ Warning:

- The Fresh Master should be securely installed. If the unit is loosely mounted, it may fall, causing injury.

3) Remote controller

⚠ Warning:

- The Remote controller should be installed in such a way that children cannot play with it.

4) Drain hose

⚠ Caution:

- Make sure that the drain hose is installed so that drainage can go ahead smoothly. Incorrect installation may result in water leakage, causing damage to furniture.

5) Power Supply, fuse or circuit isolator

⚠ Warning:

- Make sure that the unit is powered by a dedicated power supply. Other appliances connected to the same power supply could cause an overload.
- Make sure that there is a mains power switch.
- Be sure to adhere to the unit's voltage and fuse or circuit isolator ratings. Never use a cable or a fuse with a higher rating than the one specified.

6) Grounding

⚠ Caution:

- The unit must be properly grounded. Never connect the grounding wire to a gas pipe, water pipe, lightning conductor or telephone grounding wire. If the unit is not grounded properly, electric shock may result.
- Check frequently that the ground wire from the outdoor unit is properly connected to both the unit's ground terminal and the grounding electrode.

1.2. During operation

⚠ Warning:

- Do not splash water over the unit and do not touch the unit with wet hands. An electric shock may result.
- Do not spray combustible gas close to the unit. Fire may result.
- Do not place a gas heater or any other open-flame appliance where it will be exposed to the air discharged from the unit. Incomplete combustion may result.
- Do not remove the front panel or the fan guard from the outdoor unit when it is running. You could be injured if you touch rotating, hot or high-voltage parts.

- Never insert fingers, sticks etc. into the intakes or outlets, otherwise injury may result, since the fan inside the unit rotates at high speed. Exercise particular care when children are present.
- If you detect odd smells, stop using the unit, turn off the power switch and consult your dealer. Otherwise, a breakdown, electric shock or fire may result.
- When you notice exceptionally abnormal noise or vibration, stop operation, turn off the power switch, and contact your dealer.
- Do not leave handicapped people or infants sitting or standing in the path of the airflow from the Fresh Master. This could cause health problems.

⚠ Caution:

- Do not use any sharp object to push the buttons, as this may damage the Remote controller.
- Do not twist or tug on the Remote controller cord as this may damage the Remote controller and cause malfunction.
- Never remove the upper case of the Remote controller. It is dangerous to remove the upper case of the Remote controller and touch the printed circuit boards inside. Doing so can result in fire and failure.
- Never wipe the Remote controller with benzene, thinner, chemical rags, etc. Doing so can result in discoloration and failure. To remove heavy stains, soak a cloth in neutral detergent mixed with water, wring it out thoroughly, wipe the stains off, and wipe again with a dry cloth.
- Never block or cover the Fresh Master or outdoor unit intakes or outlets. Tall items of furniture underneath the Fresh Master, or bulky items such as large boxes placed close to the outdoor unit will reduce the unit's efficiency.
- Do not direct the airflow at plants or caged pets.

In case of failure

⚠ Warning:

- Never remodel the Fresh Master. Consult your dealer for any repair service. Improper repair work can result in water leakage, electric shock, fire, etc.
- If the Remote controller displays an error indication, the Fresh Master does not run, or there is an abnormality, stop operation and contact your dealer. Leaving the unit as it is under such conditions can result in fire or failure.
- If the power isolator is frequently activated, get in touch with your dealer. Leaving it as it is can result in fire or failure.
- If the refrigeration gas blows out or leaks, stop the operation of the Fresh Master, thoroughly ventilate the room, and contact your dealer. Leaving the unit as it is can result in accidents due to oxygen deficiency.

When the Fresh Master is not to be used for a long time

- If the Fresh Master is not to be used for a long time due to a seasonal change, etc., run it for 4 - 5 hours with the air blowing until the inside is completely dry. Failing to do so can result in the growth of unhygienic, unhealthy mold in scattered areas throughout the room.
- When it is not to be used for an extended time, keep the power supply turned OFF.
- If the power supply is kept on, several watts or several tens of watts will be wasted. Also, the accumulation of dust, etc., can result in fire.
- Keep the power switched ON for more than 12 hours before starting operation. Do not turn the power supply OFF during seasons of heavy use. Doing so can result in failure.

1.3. Disposing of the unit

⚠ Warning:

- When you need to dispose of the unit, consult your dealer. If pipes are removed incorrectly, refrigerant (fluorocarbon gas) may blow out and come into contact with your skin, causing injury. Releasing refrigerant into the atmosphere also damages the environment.

2. Names and functions of various parts

Fresh Master

The Fresh Master supplies clean air that is close to the indoor temperature and humidity by using the Lossnay ventilation function and the direct expansion-coil air conditioning function. The Fresh Master uses the high efficiency filter for dust removal and permeable-film humidifier to create a pleasant indoor environment.

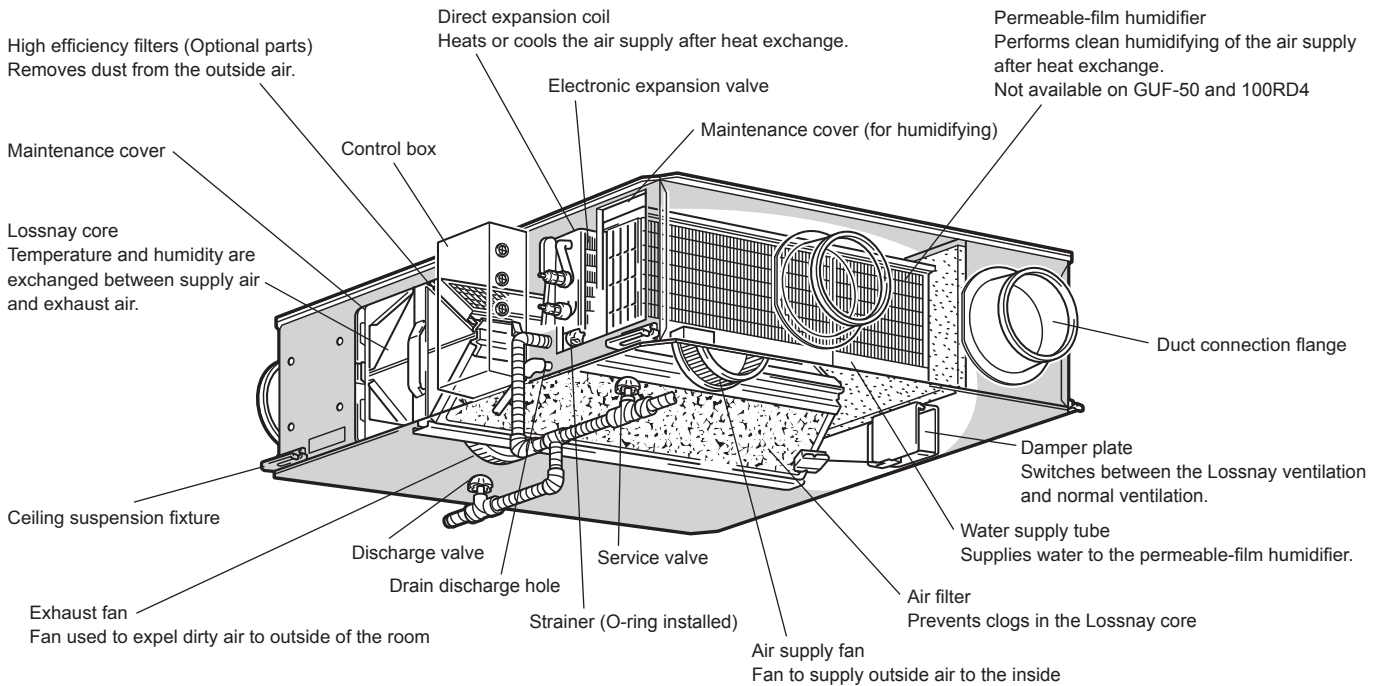

*GUF-50RDH4 shown above.

Outdoor unit

Outdoor units differ according to systems and can sometimes be in configuration other than those described in this manual.

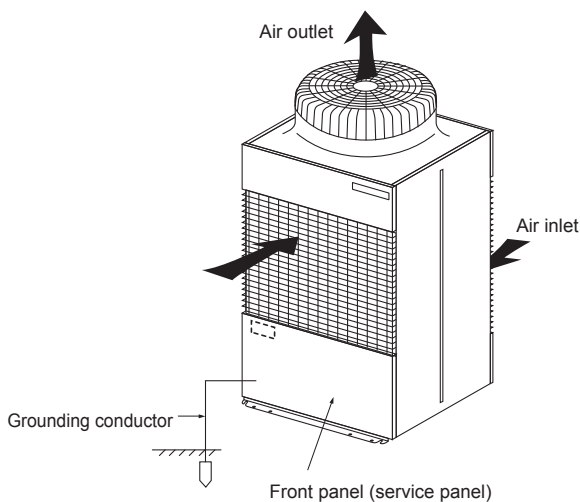

Remote controller

- Check out your remote controller. Different controllers are used for different systems.

* If you open the door, the name of the Remote controller is shown at the lower left.

Remote controller
[PAR-21MAA]
[PAR-F27MEA]

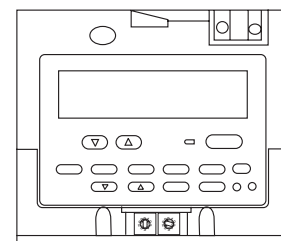

(Diagram of a controller with the door open.)

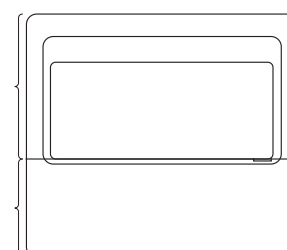

(Diagram of a controller with the door closed)

⚠ Caution:

- Carry out grounding work. Never connect the grounding wire to a gas pipe, water pipe, arrester, or telephone grounding wire. Improper grounding work can result in electric shock.

Wiring diagrams

When interlocked with an indoor unit.

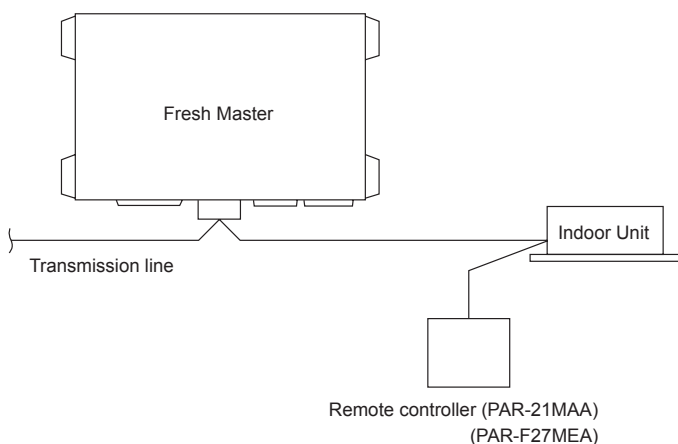

When not interlocked with an indoor unit.

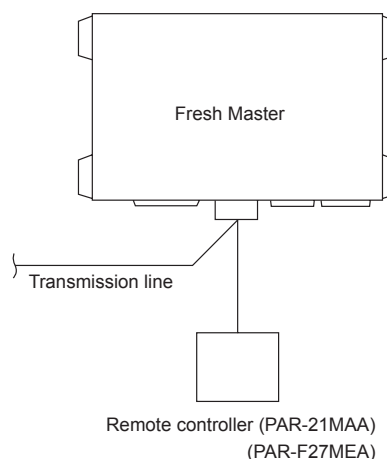

Operation section

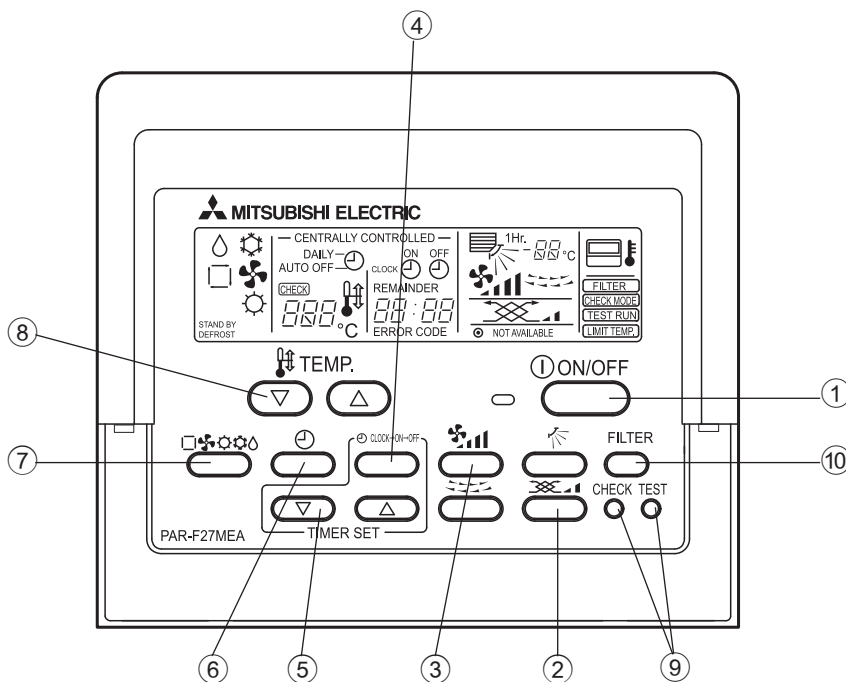
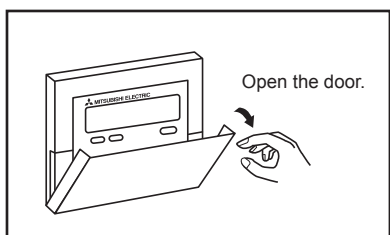

- ① [ON/OFF] Button
After natives between run and stop every time it is pressed. The lamp on the button stays lit during operation.
- ② [Ventilation] Button *
Used when switching the ventilation of the Fresh Master between Stop, Low and High.
- ③ [Fan speed adjustment] Button
Used to switch the fan speed between high and low.
- ④ [Time selection] Button
Used to switch between the current time, starting time, and ending time.
- ⑤ [Time-setting] Button
Used to set the current time, starting time, and ending time.
- ⑥ [Timer] Button
Used to switch between continuous operation and timer operation.
- ⑦ [Selecting operation] Button
Used to switch between cooling, fan, and heating.
- ⑧ [Temperature adjustment] Button
Used to set the temperature.
Setting is made in units of 1°C.
Every time Δ is pressed, the temperature goes up by 1°C.
Every time ∇ is pressed, the temperature goes down by 1°C.
- ⑨ [Checking/test run] Button
Used only during checking test run. Never use this button during normal operation.
- ⑩ [Filter] Button
Pressed to reset the filter sign.

* When interlocked only.

Display section

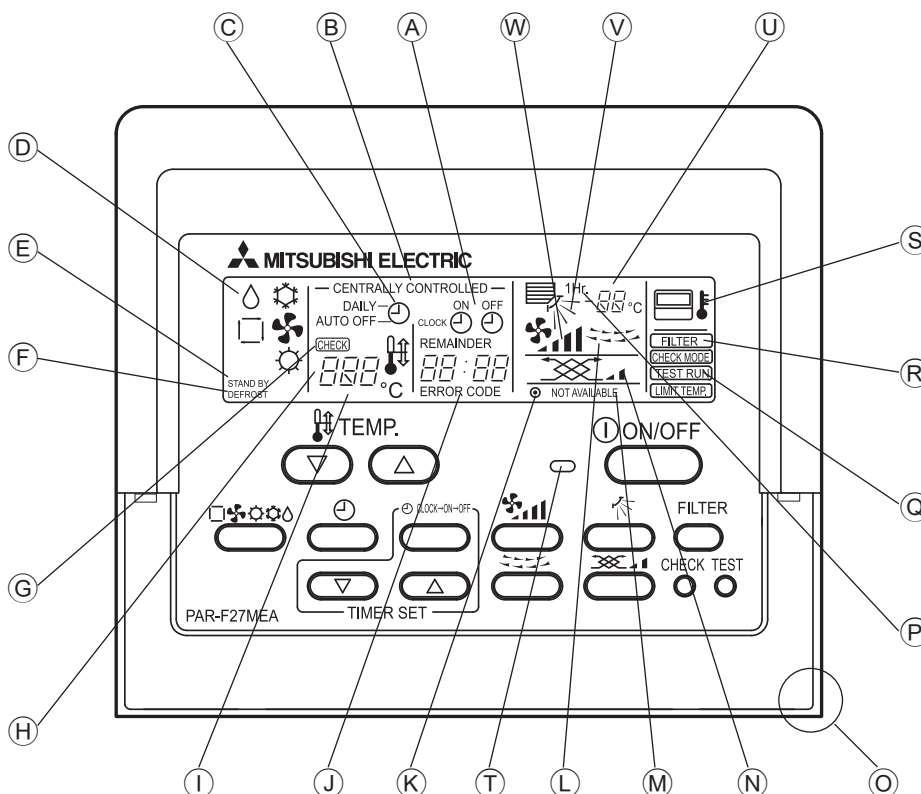

For purposes of explanation, all the displays on this page are shown in their lit condition. This configuration does not occur in the actual unit.

- A [Current/starting/ending time] Display
When the time switch button is pressed, the current time, starting time and ending time are displayed for 10 seconds. During timer operation, the next starting time or ending time is always displayed.
- B [Centralized control] Display
Displayed when control is executed by a separately sold centralized control unit, etc.
- C [Timer] Display
This displays the modes of continuous operation/timer operation. Time is simultaneously displayed at the time of timer operation.
- D Operation mode
Displays the status of operation.
- E [Preparing for Heating] Display
Displayed from the start of heating operation until the moment warm air blows out.
- F [Defrosting] Display
Displayed during defrosting operation.
- G [Checking] Display
This displays indication when an abnormality occurs in the unit.
- H [Set temperature] Display
Displays the set temperature.
- I [Address numbers of indoor unit/unit in linked motion] Display
Displayed when some abnormality occurs in the unit.
- J [Error number] Display
Displays the (4-digit) checking code when an abnormality occurs in the unit.
- K Display "●"
Displayed while the air conditioner is powered.

- L [Louver operation] Display
This displays the operation of a swing louver. This does not display in case of stop.
- M [Not available] Display
When a button is pressed for any function that the indoor unit cannot perform, this display flashes concurrently with the display of that function.
- N [Ventilation] Display *
Displayed during the Fresh Master's operation.
- O [Position of built-in room temperature sensor]
- P [Set effective for one hour] Display
Displays when the low air blow, downward blow, or horizontal blow (differs according to model) are set in the air-cooling and electronics dry operation. This display disappears after the elapse of one hour.
- Q [Now checking/test run] Display
- R [Filter] Display
Displayed when it is time to clean the filter.
- S [Sensor] Display
Shows a position of the sensor that measures the room temperature.
- T [Operation] Lamp
Lights up during operation, goes off during stop, and flashes in case of abnormality.
- U [Room temperature] Display
Displays the temperature of the air sucked in during operation. The range of display is 8°C to 39°C. For temperatures outside this range, the display flashes at 8°C and 39°C.
- V [Up/down airflow direction] Display
Displays the air blowout direction with a ► mark.
- W [Fan speed] Display
Displays the selected fan speed.

* When interlocked only.

3. How to operate

3.1. When interlocked with an indoor unit

- Operation will be synchronized with an indoor unit.
- The humidifier will be operated by the heating signal received from the indoor unit. (For GUF-50, 100RDH4)
- In the case of GUF-50, 100RDH4, there is no temperature control since the temperature is adjusted according to the outside air temperature.

Starting and stopping operation

- Using the Remote controller to start or stop the indoor unit will automatically start or stop the Fresh Master.

Operation modes

- The Fresh Master will operate in the same mode as the synchronized indoor unit (heat, cool and fan).
- The Fresh Master will be cool when the indoor unit is operated in dry mode.

When using with multiple indoor units

- When using with multiple indoor units that are set differently, the Fresh Master will operate in the mode with priority of: heat, cool and fan.

When operating only the Fresh Master

- The Fresh Master can be operated independently by pressing the Ventilation button on the Remote controller (in this case, the operation mode will be fan).
- Pressing the Ventilation button each time will switch the display between Stop, Low and High.

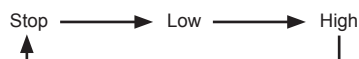

3.2. When not interlocked with an indoor unit

- GUF-50, 100RD4 will adjust the temperature according to the indoor temperature set using the Remote controller.
- In the case of GUF-50, 100RDH4, there is no temperature control since the temperature is adjusted according to the outside air temperature.

3.2.1. Before starting operation

- Make sure that the power supply is turned ON before use. (Keep the power supply turned ON at all times when the Fresh Master is in use. Use of the unit without power can result in compressor failure.)
- Start running after the "HO" display has disappeared. The "HO" display briefly appears on the room temperature display (max. 10 minutes) when the power is turned on and after a power failure. This does not indicate any failure of the Fresh Master.
- The operation modes of the Fresh Master air-cooling operation and heating operation are different from those of the outdoor units. When the operation is started with cooling/heating and other indoor units or the Fresh Master connected to the counterpart outdoor units are already running in the same operation mode, the Remote controller displays air-cooling/heating mode. However, the operation comes to stop, and you cannot get a desired mode. When this occurs, you will be notified by the "cool" or "heating" display that flashes in the liquid crystal display of the Remote controller. Set to the operation mode of other indoor unit or the Fresh Master by the operation switch button. The above does not apply to the models that simultaneously run both the cooling operation and heating operation.
- The outdoor units stop when all the indoor units and the Fresh Master connected to the counterpart outdoor units stop.
- During heating operation, even if the indoor unit or the Fresh Master is set to operation while the outdoor unit is in defrosting operation, operation starts after the defrosting operation of the outdoor unit has ended.

Warning:

- Check and confirm the power circuit before use. For contents, refer to the previously described chapter [Crucial points to be observed for safety].

3.2.2 ON/OFF

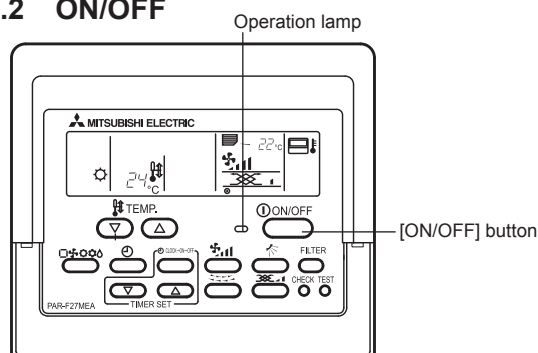

Start an operation

Press [ON/OFF] button

Operation lamp lights up and operation starts.

Stop an operation

Press the [ON/OFF] button again

Operation lamp goes off and operation stops.

- Once the buttons have been set, pressing of the [ON/OFF] button only can repeat the same operation thereafter.
- During operation, the operation lamp above the [ON/OFF] button lights up.

Caution:

- Even if the operation button is pressed immediately after the operation has stopped, operation will not restart for about 3 minutes. This function protects the machine. It automatically starts operation after approximately 3 minutes.

3.2.3. Selecting operation

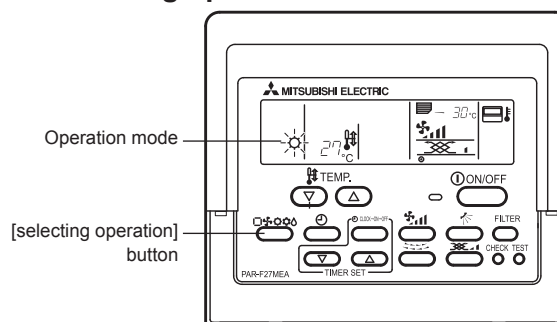

When selecting operation

Press the [selecting operation] button

- Consecutive press of the selecting operation button switches the operation over to "cooling," "fan," "(automatic)," and "heating." For the contents of operation, check the display.

For cooling

Press the [selecting operation] button and bring up the "cooling" display

⚠ Caution:

- Never expose your body directly to cool air for a long time. Excessive exposure to cool air is bad for your health, and should therefore be avoided.

For fan

Press the [selecting operation] button and bring up the “fan” display.

- The fan operation functions to ventilate.
- The temperature of the room cannot be set by fan operation.

For heating

Press the [selecting operation] button to bring up the “heating” display.

Regarding displays during heating operation “Under defrosting”
Displayed only during the defrosting operation.

“Under preparation for heating”

Displayed from the start of heating operation until the moment warm air blows out.

- When in the “heating” mode, the humidifier will also operate. (For GUF-50, 100RDH4)

⚠ Caution:

- When the Fresh Master is used together with burners.
- Never place a burner at a place where it is exposed to the airflow from the Fresh Master. Doing so can result in imperfect combustion of the burner.
- The microcomputer functions in the following cases:
The intake fan is not moving at the set speed. Intake fan stops to prevent any cool air from escaping during the defrosting operation.

3.2.4. Temperature adjustment

GUF-50, 100RDH4 are OA processing unit and cannot adjust the indoor temperature, even if the procedures given below are followed. In the case of GUF-50, 100RD4, the indoor temperature can be adjusted.

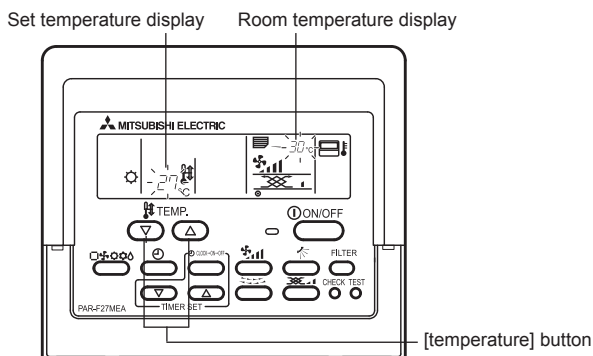

To change temperature

Press the temperature button and set the temperature of your choice

Pressing Δ or ∇ once changes the setting by 1°C. If the pressing is continued, the setting continues to change by 1°C.

- Indoor temperature can be set within the following range.

Cooling/dry	19 to 30°C	In the case of GUF-50, 100RDH4, set the temperature the same as the indoor unit.
Heating	17 to 28°C	

- It is impossible to set the temperature in fan operation.
- * The range of temperature display is 8°C to 39°C. Outside this range, the display flashes either 8°C to 39°C to inform you if the temperature is lower or higher than the displayed temperature.

3.2.5. Fan speed adjustment

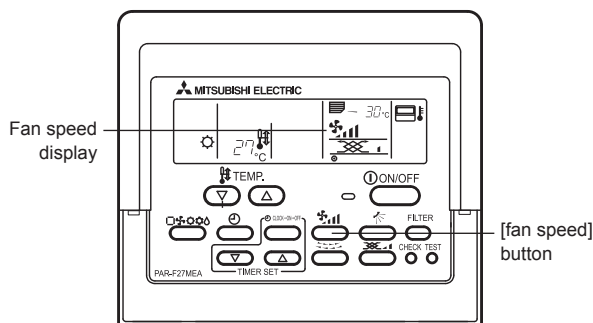

To change fan speed

Set the desired fan speed

Every time you press the [fan speed] button once, it switches from the low-speed or high-speed settings alternatively.

Display of the Remote controller	
Low	High

- * Every time the fan speed adjustment button is once pressed, the fan speed is changed.

3.2.6. Time setting

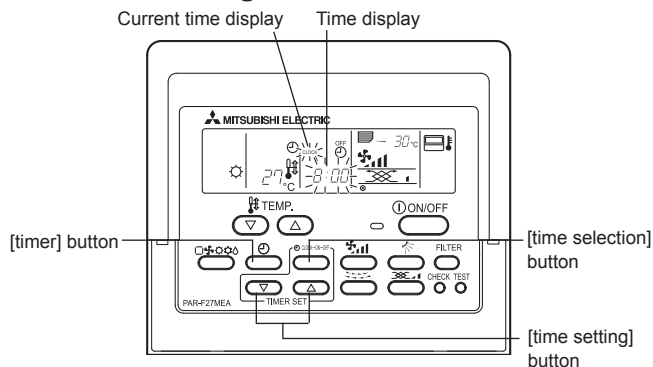

- Set the current time after turning ON the power of the Fresh Master or after restoration from a power failure.
- It can be set regardless of the operation of the Fresh Master.
- During the time operation, the time-setting button becomes void, disabling time setting.

Press the [time selection] button and bring up the “current time” display

- Every time it is pressed, the display changes.

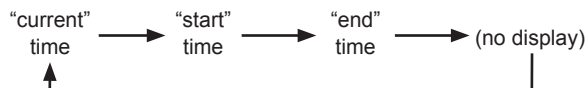

⚠ Caution:

- When the current time is not yet set, the “current” time display flashes, disabling the setting of timer operation.

Set the current time by pressing the time setting Δ or ∇ button

- The time cannot be set while the “[timer]” is displayed.
- While the “CLOCK” time is displayed, press the time setting Δ or ∇ buttons and set the time.

- The setting advances one minute every time the (▲) button is pressed, and goes back one minute every time the (▼) button is pressed.
When respective (▲)/(▼) buttons are pressed continuously, the time display goes fast forward. It advances in the order of 1 minute digit - 10 minute digit - one hour digit.
- About 10 seconds after the button operation has been completed, the "current time" and "time" displays disappear.

⚠ Caution:

- **The Remote controller is equipped with a simplified clock with a precision of about + or - one minute per month.**
- **The time must be readjusted (reset) every time the Fresh Master is subjected to a power stop or a power failure.**

3.2.7. Timer setting

- If the timer is set, the unit starts (stops) at the set time, and the time mode is terminated.
- When you wish to confirm the starting and ending time, press the [time selection] button while [timer] is displayed.

Function of timer

On-timer

Set the on-timer for the time the working day begins in your company.

When the set start time arrives, the Fresh Master starts operation.

Off-timer

Use the off-timer as a reminder to turn off the Fresh Master. When the set end-work time arrives, the Fresh Master stops operation.

There are three methods for using the timer.

1. ON/OFF Timer When setting both starting and ending time
2. On-timer When only setting the starting time
(Ending time is set to " __ : __ ")
3. Off-timer When only setting the ending time
(Starting time is set to " __ : __ ")

Display example of timer setting

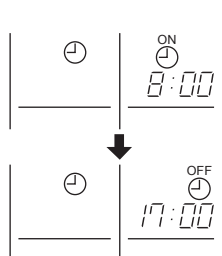

The example shows a timer set for operation start at 8:00 and end at 17:00.

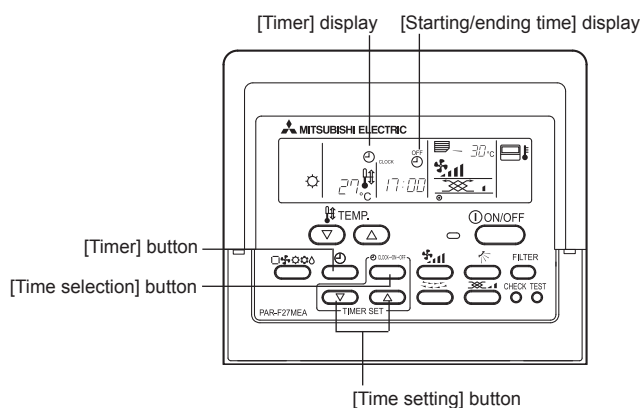

- 1 Press the [timer] button and erase the "timer" display
- 2 Press the [time selection] button and bring up the "starting time" display
- 3 Press the (▲) (▼) button of the [time setting] and set the starting time
When using it as an off-timer, set the starting time to " __ : __ ".
The " __ : __ " is displayed next to the time i.e. 23:50.
- 4 Press the [time selection] button and bring up the "ending time" display
- 5 Press the (▲) (▼) button of the [time setting] and set the ending time
When using it as an on-timer, set the ending time to " __ : __ ".
The " __ : __ " is displayed next to the time i.e. 23:50.
- 6 Press the [timer] button and bring up the "timer" display
Bringing up the [timer] display completes the setting.

Every time the (▲) (▼) button of the [timer setting] is pressed once, it advances (or goes back) by 10 minutes.

If the button is pressed continuously, it advances (or goes back) continuously.

First set the hour digit and then set the minute digit.

When the ON/OFF timer mode is set, you can run (on-timer) or stop (off-timer) operation by pressing the [ON/OFF] button even when there is remaining time.

Release

Press the [timer] button and erase the "timer" display.

4. Cleaning the machine

To prevent decline in the Lossnay performance, clean the air filter and Lossnay core, as well as replace the high efficiency filters.
 (Air filter: clean at least once a year)
 (Lossnay core: clean at least once every 2 years)
 (High efficiency filters: replace every 3,000 hours (approx.))

⚠ Caution:

- Before you start cleaning, stop operation and turn OFF the power supply. Remember that the fan is rotating inside at high speed, posing a serious risk of injury.
- Always wear gloves when cleaning the unit.
- Maintenance work should only be performed by someone who has received the necessary training.

How to remove each part

1. Maintenance cover

- (1) Remove the screw (one piece) left side of the Maintenance cover.
- (2) Pull back the hinges, open the Maintenance cover and disengage the cover from the catches.

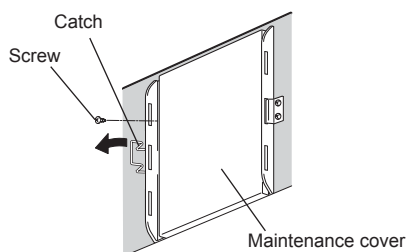

⚠ Caution

- The Maintenance cover must be removed.

2. High efficiency filters

Remove the high efficiency filters (Optional parts) from the upper right side of the Lossnay cores (2 units).

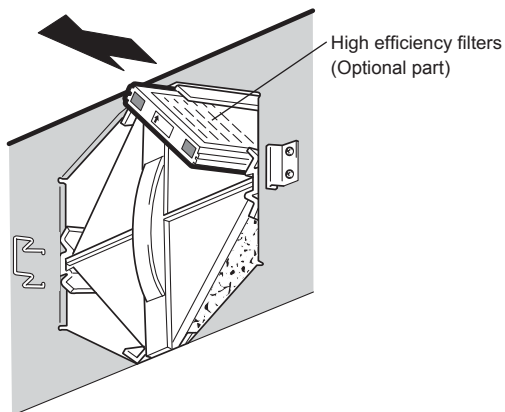

3. Lossnay cores

Take hold of the handle and draw the Lossnay cores out from the main unit (2 Lossnay cores)

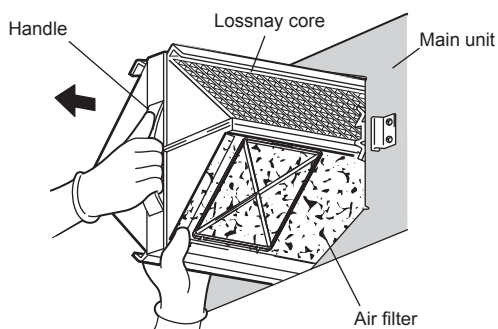

4. Air filters

After pulling out the Lossnay cores, undo filter guides, then remove the air filters, located at the bottom left and right of the Lossnay cores, as below. (4 filters)

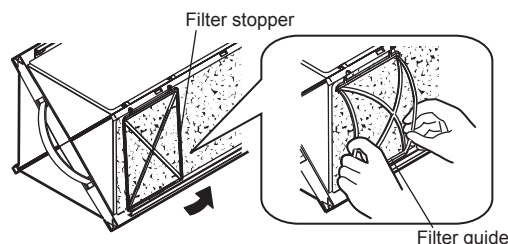

⚠ Caution:

- Bow filter stoppers a little to remove them from filter guide.
- Take filter stoppers careful not to break them.

How to clean

1. Air filters

Use a vacuum cleaner to remove light dust. To remove stubborn dirt wash in a mild solution of detergent and lukewarm water. (under 40°C)

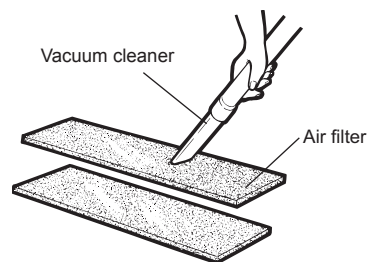

⚠ Caution:

- Never wash the filters in very hot water of 40°C or hotter and never wash them by rubbing them.
- Do not dry the filters by exposing them to a flame.

2. Lossnay cores

Use a vacuum cleaner to suck up the dust and dirt on the exposed surfaces of the Lossnay cores.
 Use a soft brush only to clean exposed surface areas.

Do NOT wash in water.

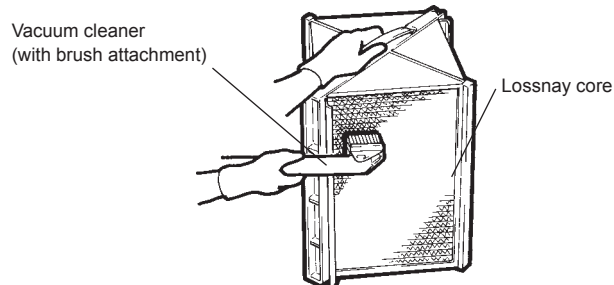

⚠ Caution:

- Do not use the hard nozzle of the vacuum cleaner. If may damage the exposed surfaces of the Lossnay cores.
- Under no circumstances should the Lossnay cores be washed in water.

3. High efficiency filters (Optional parts)

The high efficiency filters cannot be reused. Always replace with new filters. For details, consult your dealer.

Assembly after maintenance

Bearing in mind the following points, assemble the parts following the sequence for their removal in reverse.

- Arrange the Lossnay core with the air filter side as shown in the name plate on the Fresh Master.

5. Inspection and Maintenance

If the unit is to be used for prolonged periods of time, please have the following items inspected by an authorized service office at intervals of about once a year.

Be sure to turn off the isolator of the distribution board before conducting maintenance or inspection.

Part to be inspected	Description of maintenance and inspection		Possible consequence if maintenance is not conducted
	Inspection item	Action to take	
Strainer	Inspect for dust clogging.	Remove and clean the dust if clogged.	Unable to humidify
	Inspect for cracks in O-rings.	Replace the O-rings if cracked. *Note 1	Water leakage
Humidifying elements	Inspect for water leakage from the surface of each of humidifying element.	Replace the humidifying element if water spurts from its surface. *Note 2	Water leakage
	Inspect for dust and particles on the surface of each humidifying element.	If the air pathway is covered by dust or particles, carefully clean it using a vacuum cleaner, or wash it with water by referring to the cleaning procedure on page 12.	Reduced airflow Reduced humidifying power

* Note 1: Replacement O-rings: Commercially available O-rings P22A and P20

* Note 2: A small amount of water may form through dew condensation, but it is not abnormal.

Preparation before cleaning

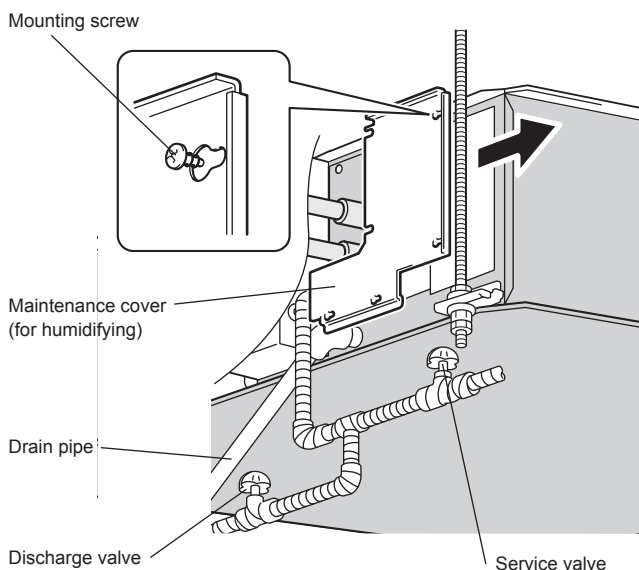

- 1. Close the service valve to prevent residual water from spattering.**
- 2. Take a countermeasure against water leakage.**
 - Water inside the humidifying elements will leak. Place a vinyl sheet in the ceiling or take another countermeasure to prevent water leakage.
- 3. Drain the residual water from the pipe.**
 - Place a bucket or other container under the discharge valve and open the valve to collect the residual water in the pipe.
- 4. Remove the maintenance cover (for humidifying).**
 - Remove the seven mounting screws, slide the maintenance cover to the right, and remove it from the potbelly-shaped holes (six locations for the GUF-50RDH4).

How to clean the strainer (filter)

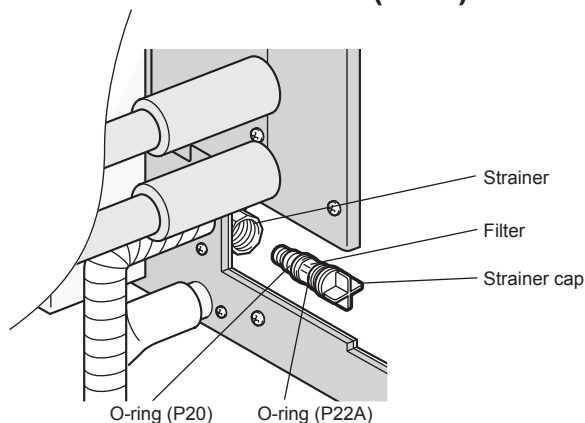

1. Rotate the strainer cap counterclockwise and remove it.
2. Use water to wash off any dirt adhering to the filter.
3. Replace the strainer cap.

How to remove the humidifying elements

The heat exchanger is located on the left side, and the hanging bolt is located on the right side. Swing the rear side of each of the humidifying elements to the right, and take out the humidifying element while making sure not to touch the heat exchanger or the hanging bolt.

1. Remove the inner lid.

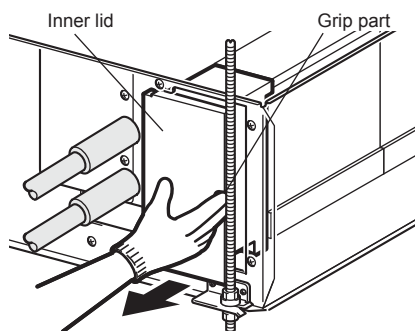

1. Place your fingers on the grip part and pull the inner lid forward.
2. Holding both ends with your hands, pull the inner lid forward.

2. Remove the water supply tube from the humidifying element.

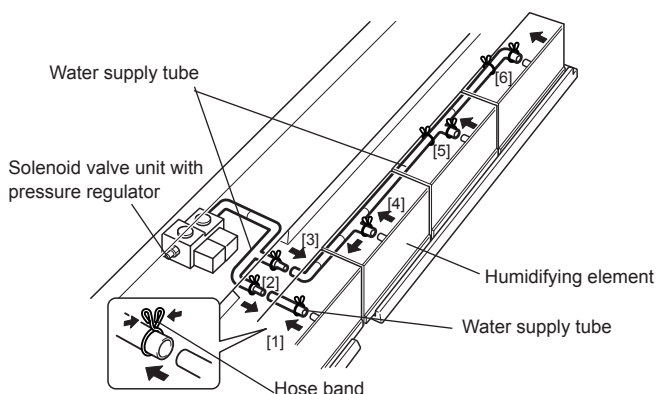

Holding the hose bands indicated by [1] to [6] with your fingers, remove the water supply tubes. Referring to the procedure entitled "removing the humidifying elements" below, remove the water supply tube at the rear while taking out the front humidifying element.

⚠ Caution:

- To remove the water supply tube, hold and slide the hose bands and remove the water supply tube.
- Do not remove the water supply tube from the solenoid valve unit with a pressure regulator.
- When removing the water supply tube, be sure that water is collected on the drain tray inside the main unit.

3. Removing the humidifying elements

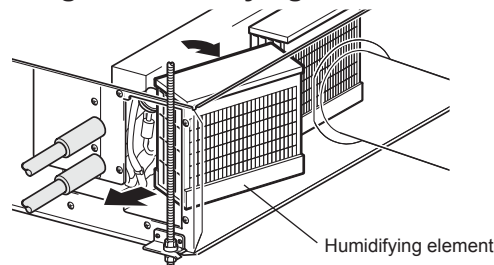

1. Pull the first humidifying element forward, swing the rear side of the humidifying element to the right, lift it upward, and then pull it out diagonally.

Model name	Quantity
GUF-50RDH4	2
GUF-100RDH4	4

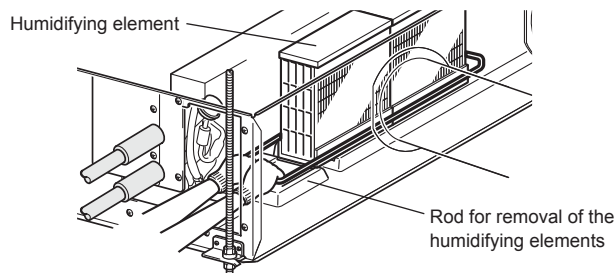

2. For the third and subsequent humidifying elements, pull the rod for removal of the humidifying elements forward until you can reach an element with your hands, and then pull it out (GUF-100RDH4).

⚠ Caution:

- Do not separate the rod for removal of the humidifying elements from the product.
- Take out the water supply tube together with the humidifying element. (Collect the residual water in the humidifying element using the drain tray.)
- Do not bend or stretch the water supply tubes.

How to wash the humidifying elements with water

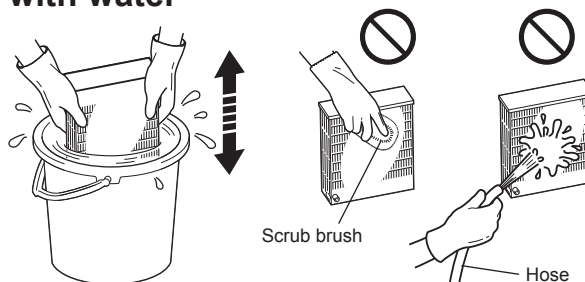

Fill a bucket or other container with water, then shake each humidifying element four to five times up and down in the water to wash out any dust and particles.

⚠ Caution:

- Do not use a scrub brush to clean the humidifying elements.
- Do not hose off the humidifying elements. Doing so will damage them.
- Do not use hot water of 40°C or hotter, nor use detergents, to clean the humidifying elements.

How to install the humidifying elements

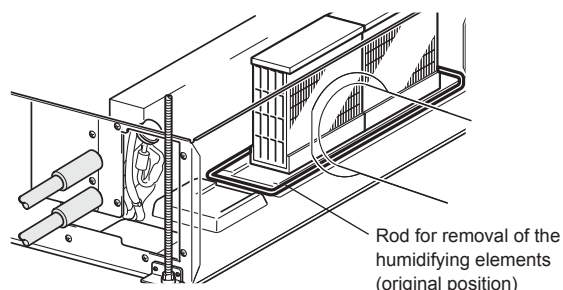

Install the humidifying elements in the reverse order of their removal.

- For the GUF-100RDH4, return the rod for removal of the humidifying elements to its original position, and then insert the humidifying elements.
- Securely connect the water supply tubes and make sure there is no water leakage.

Check after inspection

1. **Open the service valve as necessary.**
 - Since humidification is not needed during the summer, it is recommended that the service valve be closed.
2. **During the winter, the season requiring humidification, make sure that the power to the heater for prevention of freezing is on.**
3. **Conduct a test and confirm that there is no water leakage.**

6. Troubleshooting

Before you ask for repair service, check the following points:

State of Machine	Remote Controller	Cause	Troubleshooting
It does not run.	"●" display is not lit up No display appears even when the [ON/OFF] button is pressed.	Power failure	Press the [ON/OFF] button after power restoration.
		The power supply is turned OFF.	Turn the power supply ON.
		The fuse in the power supply is gone.	Replace fuse.
		The earth leakage isolator is gone.	Put in the earth leakage isolator.
Cool air or warm air does not come out.	The liquid crystal display shows that it is in operation.	The restart-preventing circuit is in operation for 3 minutes.	Wait for a while. (To protect the compressor, a 3-minute restart-preventing circuit is built into the Fresh Master. Therefore, there are occasions sometimes when the compressor does not start running immediately. There are cases when it does not run for as long as 3 minutes.)
		Fresh Master operation is started during the heating and defrosting operation.	Wait for a while. (Heating operation starts after ending defrosting operation.)
It runs briefly, but soon stops	The "check" and check code flashes on the liquid crystal display.	There are some obstacles at the air inlet and outlet of the Fresh Master and outdoor unit.	Rerun after removal
		The filters are filled with dust and dirt.	Rerun after cleaning the filters. (Refer to page 10 [Cleaning the machine].)
Do not humidify (GUF-50, 100RDH4 only)		The Fresh Master is not set to the "heating" mode.	Set to the "heating" mode.
		Water is not supplied.	Open the service valve.

- If operation stops due to a power failure, the [restart-preventing circuit at power failure] functions and disables operation, even after power restoration. In this case, press the [ON/OFF] button again and start operation.

If malfunctions persist after you have checked the above, turn the power supply OFF and contact your dealer with information about the product name, the nature of the malfunction, etc. If the display of "[check]" and (4 digit) check code flashes, tell the dealer contents of the display (check code). Never attempt to repair by yourself.

The following symptoms are not the Fresh Master failures:

- The air blown out from the Fresh Master can sometimes give off odours. This is due to cigarette smoke contained in the air of the room, the smell of cosmetics, the walls, furniture, etc., absorbed in the Fresh Master.
- A hissing noise can be heard immediately after the Fresh Master is started or stopped. This is the sound of the refrigeration flowing inside the Fresh Master. The problem is insignificant.
- The Fresh Master sometimes snaps or clicks at the beginning or end of cooling/heating operation. This is the sound of friction on the metal sections due to inflation and contraction caused by temperature change. The problem is insignificant.
- It is recommended that the air blown out from the Fresh Master be directed to the air conditioner first and then directed into the room. However, the air may be directed from the Fresh Master to the room without going through the air conditioner. In this air-blowing method, cold air blows out during heating operation in the cases listed below. In that case, please change the air-blowing method.
 - At the start of an operation
 - When an operation is restarted immediately after an operation has been stopped (within 3 minutes)
 - During a defrosting operation of the outdoor unit

7. Installation and transferring works, and checking

Regarding place for installation

Consult with your dealer for details on installation and transferring the installation.

⚠ Caution:

- **Never install the Fresh Master where there is a risk of leakage of flammable gas.**
If gas leaks and accumulates around the unit, fire can result.

Never install the Fresh Master at the following place:

- where there is much machine oil
 - near ocean and beach areas where there is much salt
 - where humidity is high
 - where there are hot springs nearby
 - where there is much sulfureted gas
 - where there is a high-frequency processing machinery (a high-frequency welder, etc.)
 - where acid solution is frequently used
 - where special sprays are frequently used
 - Install the Fresh Master horizontally. Otherwise, water leakage can result.
 - Take sufficient measures against noise when installing the Fresh Master at hospitals or communication-related businesses.
- If the Fresh Master is used in any of the above-mentioned environments, frequent operational failure can be expected. It is advisable to avoid these types of installation sites.
For further details, consult with your dealer.

Regarding electrical work

⚠ Caution:

- **The electrical work must be undertaken by a person who is qualified as an electric engineer according to the [technical standard respecting electrical installation], [internal wiring rules], and the installation instruction manual with the absolute use of exclusive circuits. The use of other products with the power source can result in burnt-out breakers and fuses.**
- **Never connect the grounding wire to a gas pipe, water pipe, arrester, or telephone grounding wire. For details, consult with your dealer.**
- **In some types of installation sites, the installation of an earth leakage isolator is mandatory. For details, consult with your dealer.**

Regarding transfer of installation

- When removing and reinstalling the Fresh Master when you enlarge your home, remodel, or move, consult with your dealer in advance to ascertain the cost of the professional engineering work required for transferring the installation.

⚠ Caution:

- **When moving or reinstalling the Fresh Master, consult with your dealer. Defective installation can result in electric shock, fire, etc.**

Regarding noise

- In installing work, choose a place that can fully bear the weight of the Fresh Master and outdoor unit, and where noise and vibration can be reduced.
- Choose a place where cool or warm air and noise from the outdoor unit's air outlet do not inconvenience the neighbors.
- If any alien object is placed near the outdoor unit's air outlet, decreased performance and increased noise can result. Avoid placing any obstacles adjacent to the air outlet.
- If the Fresh Master or outdoor unit produces any abnormal sound, consult with your dealer.

Maintenance and inspection

- If the Fresh Master and outdoor unit is used throughout several seasons, the insides can get dirty, reducing the performance. Depending upon the conditions of usage, foul odours can be generated and drainage can deteriorate due to dust and dirt, etc.

Time to change the humidifying element (GUF-50, 100RDH4 only)

Because impurities and contamination in tap water accumulate on the humidifying element, the humidifying power of the humidifying element decreases gradually.

- If the humidifying power decreases in the course of use, please consider changing the humidifying element (chargeable to the customer).
- Although the time to change the humidifying element varies depending on the conditions such as the operating time and water quality, it should generally be changed at every five years.

8. Specifications

Model name	Power supply (V)	Frequency (Hz)	Current (A)	Power consumption (W)	Air volume		External air load heat processing capability (kw)		Humidifying volume	Noise (dB)	Weight (kg)	Equivalent indoor unit capability
					m ³ /h	L/S	Cooling capability	Heating capability				
GUF-50RDH4	Single-phase 220-240	50	1.15	235-265	500	139	5.57 (1.94)	6.21 (2.04)	2.70	33.5-34.5	57	P32
GUF-100RDH4			2.20	480-505	1,000	278	11.44 (4.12)	12.56 (4.26)	5.40	38-39	98	P63
GUF-50RD4			1.15	235-265	500	139	5.57 (1.94)	6.21 (2.04)	-	33.5-34.5	54	P32
GUF-100RD4			2.20	480-505	1,000	278	11.44 (4.12)	12.56 (4.26)	-	38-39	92	P63

- The values given in the table for the noise level reflect the levels measured at a position 1.5 meters immediately below the unit in an anechoic chamber.
- The noise at the air outlets (at a 45° angle, 1.5 meters in front) is about 5-6 dB (A) higher than the values given in the table.
- The above values apply during Lossnay ventilation when the fan speed is set to high speed.

* Capacity in () is heat recovery capacity by Lossnay core.

Cooling/Heating capacity indicates the maximum value at operation under the following condition.

Cooling: Indoor: 27°C DB/19°C WB Outdoor: 35°C DB/24°C WB

Heating: Indoor: 20°C DB/13.8°C WB Outdoor: 7°C DB/6°C WB

- Noise measurement is carried out in accordance with JIS B8628.

* Mitsubishi Electric measures products according to Japan Industrial Standard (JIS B 8628), therefore Q-H curves are measured by chamber method.

* In the United Kingdom, on-site measurements by pitot tube method could be as much 20% difference from JIS test room conditions. If the measuring point is close to sources of turbulence like bends, contractions and dampers etc, it is difficult to measure air volume correctly. A straight duct length more than 10D (D=duct diameter) from the source of turbulence is recommended for correct measurement. On-site measurement should therefore be measured in accordance with BSRIA guideline (Commissioning Air System. Application procedures for buildings AG3/89.3(2001))

MITSUBISHI ELECTRIC CORPORATION