

Technical Documentation

Outdoor-Air Processing unit

GUF-50/100RD3

GUF-50/100RDH3

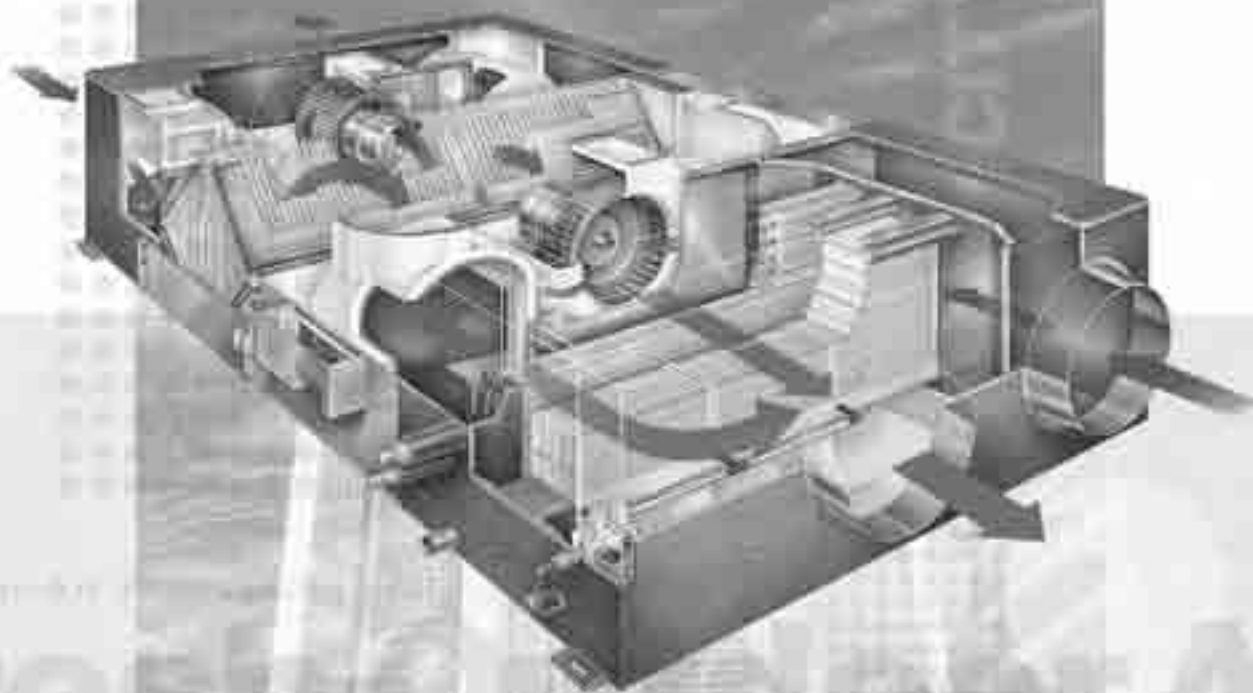

CITY MULTI

CONTENTS

CHAPTER 1 Product Section

1. Summary	2
2. Main Functions of OA Processing Unit.....	3
3. Model Line-Up	4
4. Summary of Types	4
5. Specifications	5
6. Outline Drawings	7
7. Electric Wiring Diagrams	8
8. Characteristic Curves	10
9. Construction and Principle of Heat Recovery Unit (Lossnay Core)	11
10. Total Heat Recovery Characteristics	13
11. Principle and Features of Permeable Film Humidifier	14
12. Cooling and Heating Characteristics	18
13. Filter Characteristics.....	33
14. Noise Characteristics	35
15. Reference Documents	36

CHAPTER 2 Air Conditioning System Design Section

1. Guide to a Comfortable Air Conditioning System.....	48
2. Features of the OA Processing Unit.....	49
3. Air Conditioning and Ventilation	50
4. Characteristics	61
5. Lossnay Core Effect	64
6. Humidifying.....	70
7. Humidifying Effect of the OA Processing Unit	72
8. Water Quality and Service Life of Humidifier	75
9. Dust Removal.....	77
10. Sound	82
11. Precautions when Using.....	87

CHAPTER 3 Control System Design Section

1. System Selection	92
2. Precautions when Designing Systems	99
3. Cable Installation	100
4. System Designs	104
5. Control of OA Processing Unit	106
6. Automatic Ventilation Switching	107
7. Operation with Cooling/Heating	110
8. Feature Settings	115
9. How to Operate	120
10. System Component	126
11. Troubleshooting	129
12. Remote Controller Check Code List.....	130
13. Circuit Test Point.....	131

CHAPTER 1
Product Section

1. Summary

Introducing state-of-the-art comprehensive air conditioning that provides precise control for individual rooms.

RDH3 series : Lossnay Ventilation and efficient humidifying.

RD3 series : Lossnay Ventilation and the Air conditioner.

(1)When the load is light. → Main Air conditioner.

(2)When the load is heavy. → Supplemental Air conditioner.

Introducing the latest advancement for total air conditioning comfort – the Outdoor Air processing unit (hereafter OA processing unit). It uses the latest technology to provide comprehensive air conditioning control including ventilation, heat recovery, humidifying, heat processing and dust removal*. Control can be performed for each room, giving the flexibility to create the best comfort for each type of living space.

Note: (Dust removal)This function is enabled by using the optional high-efficiency filter.

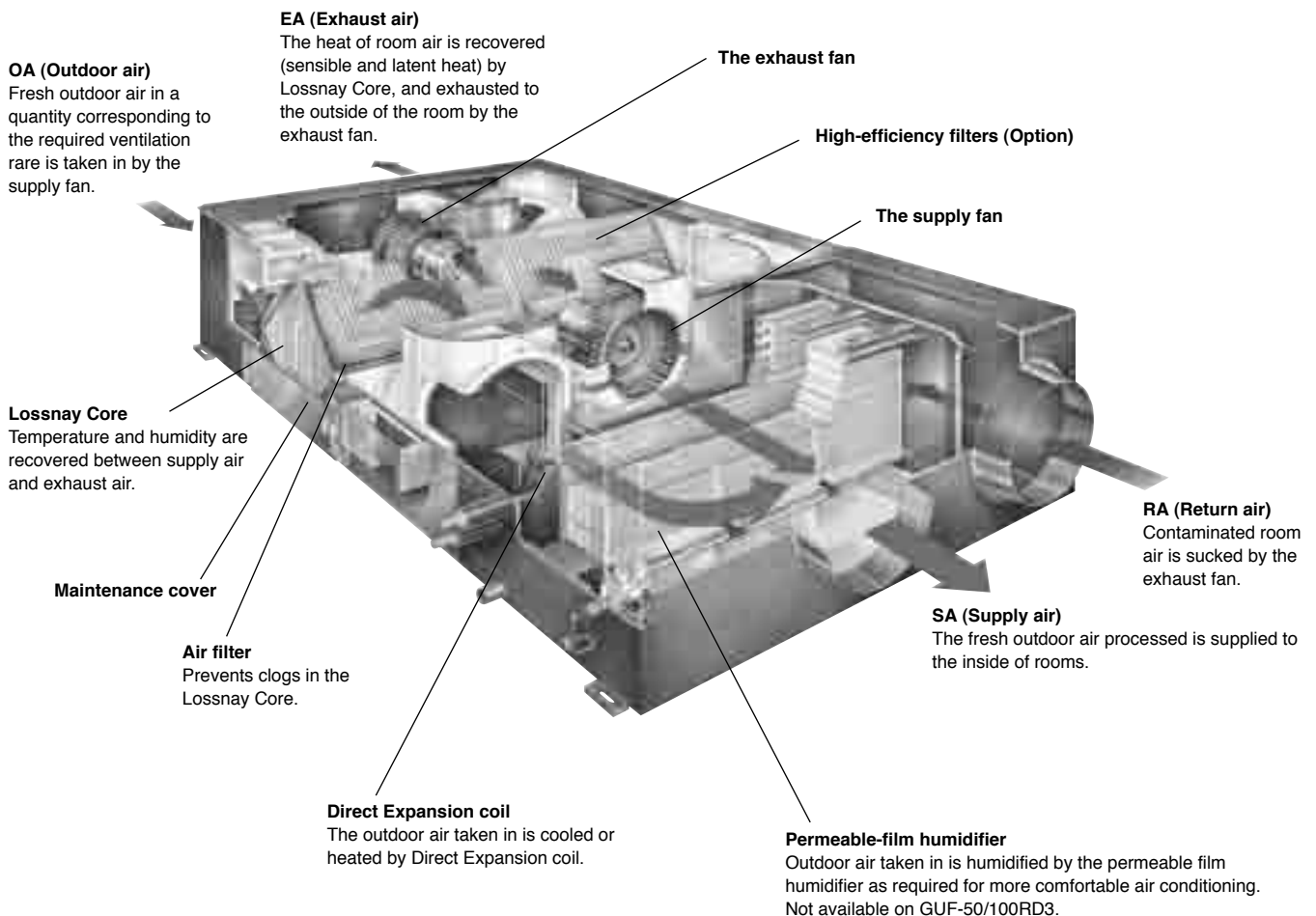

2. Main Functions of OA Processing Unit

2.1 Common Functions of Humidifying/Non-Humidifying Type (GUF-RDH3/RD3)

● Ventilation

Ensures proper ventilation by simultaneous forced air induction and exhaust.

Dual intake fans are used to simultaneously force both supply air diffuser and exhaust. This means that even sealed buildings will be ensured of proper ventilation.

● Heat recovery

Heat recovery system that provides energy-saving operation.

The unit has a built-in static type total heat recovery unit Lossnay Core. There is no mixing of the intake and exhaust air as they pass through the Lossnay Core. Recover of both temperature (sensible heat) and humidity (latent heat) – in other words total heat recovery – is performed with minimal loss to the heating or cooling effect, ensuring energy-saving operation.

● Dust removal*

High-efficiency filter provides 65% filtration using colorimetric method (Optional parts)

The high-efficiency filter provides up to 3,000 hours of maintenance free operation and is capable of 65% filtration (colorimetric method). It can be installed inside of the OA processing unit itself, so no additional installation space is required. In addition, the high-efficiency filter can be installed after the OA processing unit has been installed.

Note: This function is enabled by using the optional high-efficiency filter.

● Free Cooling

When the air conditioning system is operating in its cooling mode and the temperature of the air outdoors drops below the temperature indoors (e.g.a summer night), the OA processing unit detects this and automatically switches to a mode of operation which bypasses the heat-exchange element. Bringing in cool air from outside serves to help reduce the air conditioner's cooling load.

2.2 Functions of Humidifying Type (GUF-RDH3)

● Humidifier

Total introduction of permeable-film humidifier that functions using natural evaporation.

The humidifier installed in the OA processing unit was designed exclusively by Mitsubishi Electric. It is the permeable-film humidifier that functions using natural evaporation. This design total eliminates the spreading of impurities such as breaching powder and silicon dioxide. This means that this system can provide a clean supply air diffuser free of white exhaust.

● Heat processing

Efficient heat processing and compact design allows for design freedom.

By including the direct expansion coil, approximately 25% of the air conditioning load can be heat processed by the OA processing unit. This means that the air conditioning unit itself can be more compact. And since it totally processes the outdoor air loads, it is possible to separate outdoor air loads and indoor air loads, allowing the freedom for easier installation designs. In addition, air passes through the permeable film humidifier that increases its heat and ensures proper humidity content.

2.3 Functions of Non-Humidifying Type (GUF-RD3)



● Air conditioning

The high-performance direct-expansion coil and the air conditioning and Lossnay Core allow a single OA processing unit to provide low-energy heating and cooling ventilation.

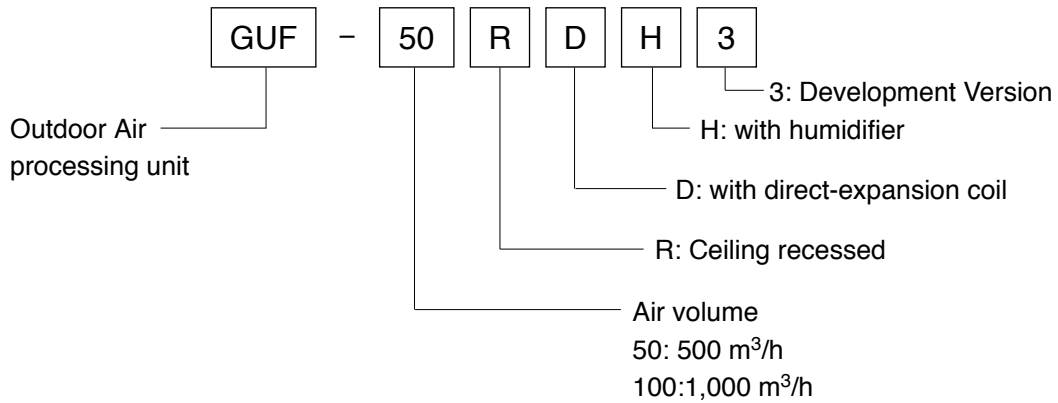
3. Model Line-Up

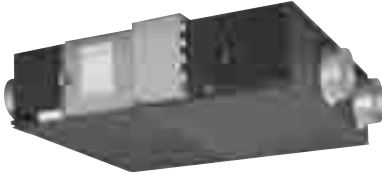

4. Summary of Types

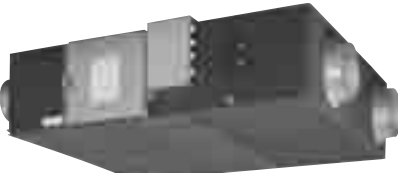
	Humidifying type Direct-expansion coil and permeable-film humidifier	Non-humidifying type Direct-expansion coil
<p>Model 50</p> <p>Rated air flow volume 500 m³/h</p>	<p>Ventilation, Heat recovery, Humidifying, Heat processing and (Dust removal)</p>  <p>GUF-50RDH3</p>	<p>Ventilation, Heat recovery, Air conditioning and (Dust removal)</p>  <p>GUF-50RD3</p>
<p>Model 100</p> <p>Rated air flow volume 1,000 m³/h</p>	<p>Ventilation, Heat recovery, Humidifying, Heat processing and (Dust removal)</p>  <p>GUF-100RDH3</p>	<p>Ventilation, Heat recovery and (Dust removal)</p>  <p>GUF-100RD3</p>

Note: (Dust removal)This function is enabled by using the optional high-efficiency filter.

5. Specifications

5.1 Humidifying Type

Ventilation	Heat recovery	Humidifying	Heat processing	(Dust removal)*
-------------	---------------	-------------	-----------------	-----------------

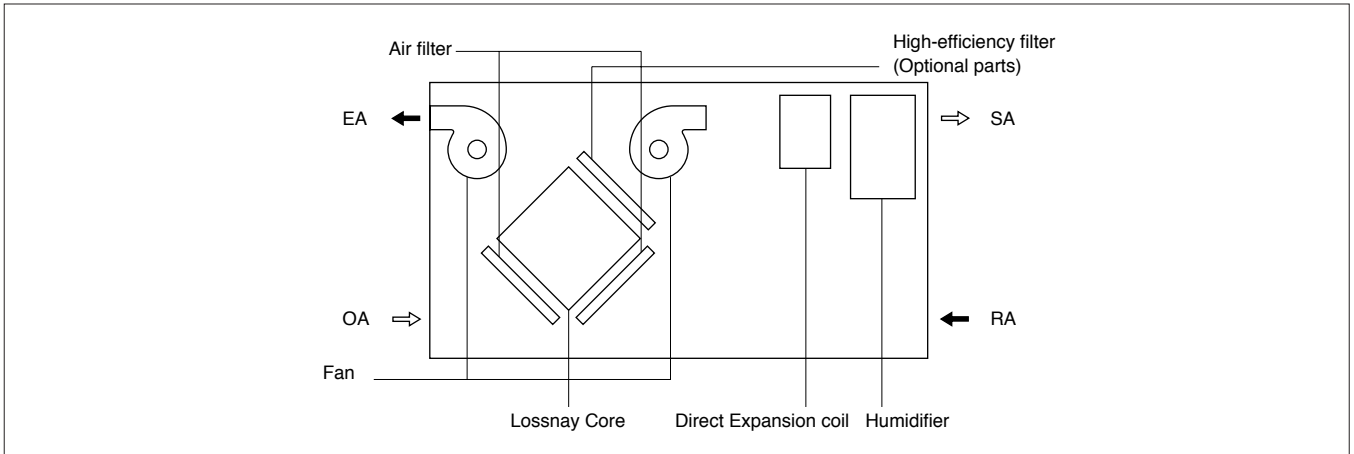

Model			GUF-50RDH3				GUF-100RDH3			
			Lossnay ventilation		By-pass ventilation		Lossnay ventilation		By-pass ventilation	
Items			High	Low	High	Low	High	Low	High	Low
Power source			Single phase 220 V - 240 V 50 Hz				Single phase 220 V - 240 V 50 Hz			
Current	A		1.15	0.70	1.15	0.70	2.20	1.76	2.25	1.77
Input	W		235-265	150-165	235-265	150-165	480-505	385-400	490-515	385-410
Capacity equivalent to the indoor unit			(P)32				(P)63			
Cooling capacity	kW		5.29 (DX coil:3.63, Lossnay:1.66)				10.81 (DX coil:7.32, Lossnay:3.49)			
Heating capacity	kW		6.42 (DX coil:4.17, Lossnay:2.25)				13.00 (DX coil:8.30, Lossnay:4.70)			
Humidifying capacity	kg/h		2.7 (heating)				5.4 (heating)			
Fan	Type × No. of fans		Supply air: Centrifugal fan [Sirocco fan] × 1				Exhaust air: Centrifugal fan [Sirocco fan] × 1			
	Air volume	m ³ /h	500	400	500	400	1,000	800	1,000	800
	External static pressure	Pa	125	80	125	80	135	86	135	86
Fan motor			Totally enclosed capacitor permanent split-phase induction motor, 4 poles, 2 units							
Noise level	dB (A)		33.5-34.5	29.5-30.5	35-36	29.5-30.5	38-39	34-35	38-39	35-36
Maximum dimensions	Width	mm	317				398			
	Height	mm	1,016				1,231			
	Depth	mm	1,288				1,580			
Weight	kg		57 (filled with water 61)				98 (filled with water 106)			
Refrigerant control			LEV control							
Refrigerant pipe dimensions	Gas	ø mm	12.7				15.88			
	Liquid	ø mm	6.35				9.52			
Drain pipe dimension			VP25							
Type of humidifier			Permeable film humidifier							
Water supply pressure			Minimum pressure: 2.0 × 10 ⁴ Pa Maximum pressure: 49.0 × 10 ⁴ Pa							
Water supply pipe dimension			R1/2 of External thread							
Filter	Supply air		Non-woven fabrics filter: Gravitational method 82% + High-efficiency filter: Colorimetric method 65% (optional parts)							
	Exhaust air		Non-woven fabrics filter: Gravitational method 82%							

Note: (Dust removal)This function is enabled by using the optional high-efficiency filter.

5.2 Non-Humidifying Type

Ventilation	Heat recovery	Air conditioning	(Dust removal)*
-------------	---------------	------------------	-----------------

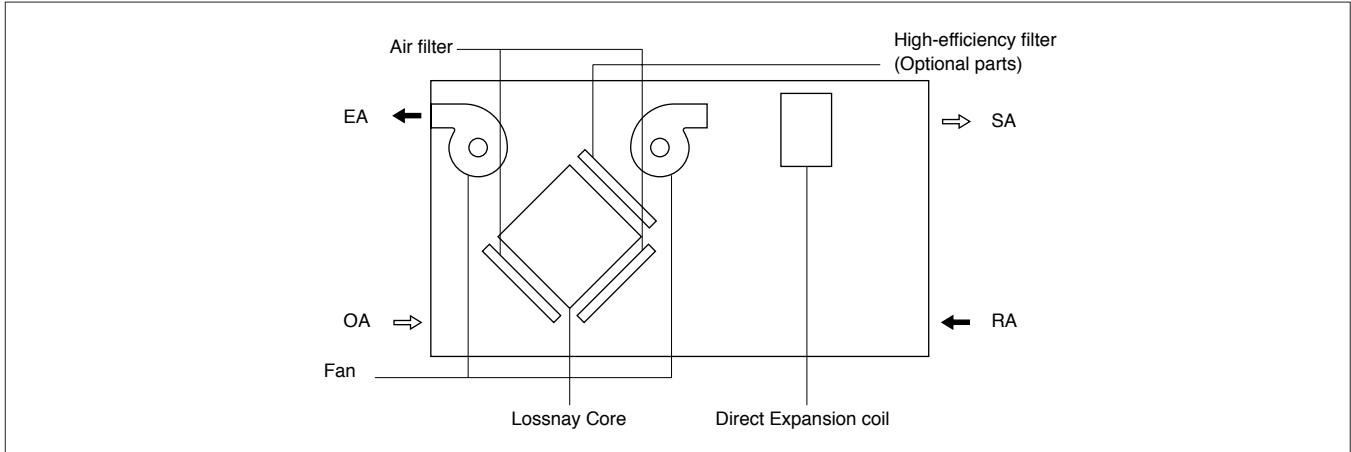

Model			GUF-50RD3				GUF-100RD3			
			Lossnay ventilation		By-pass ventilation		Lossnay ventilation		By-pass ventilation	
			High	Low	High	Low	High	Low	High	Low
Power source			Single phase 220 V - 240 V 50 Hz				Single phase 220 V - 240 V 50 Hz			
Current	A		1.15	0.70	1.15	0.70	2.20	1.73	2.25	1.77
Input	W		235-265	150-165	235-265	150-165	480-505	370-395	490-515	385-410
Capacity equivalent to the indoor unit			(P)32				(P)63			
Cooling capacity	kW		5.29 (DX coil:3.63, Lossnay:1.66)				10.81 (DX coil:7.32, Lossnay:3.49)			
Heating capacity	kW		6.42 (DX coil:4.17, Lossnay:2.25)				13.00 (DX coil:8.30, Lossnay:4.70)			
Fan	Type × No. of fans		Supply air diffuser: Centrifugal fan [Sirocco fan] × 1 Exhaust air: Centrifugal fan [Sirocco fan] × 1							
	Air volume	m ³ /h	500	400	500	400	1,000	800	1,000	800
	External static pressure	Pa	140	90	140	90	140	90	140	90
Fan motor			Totally enclosed capacitor permanent split-phase induction motor, 4 poles, 2 units							
Noise level		dB(A)	33.5-34.5	29.5-30.5	35-36	29.5-30.5	38-39	34-35	38-39	35-36
Maximum dimensions	Width	mm	317				398			
	Height	mm	1,016				1,231			
	Depth	mm	1,288				1,580			
Weight		kg	54				92			
Refrigerant control			LEV control							
Refrigerant pipe dimensions	Gas	ø mm	12.7				15.88			
	Liquid	ø mm	6.35				9.52			
Drain pipe dimension			VP25							
Filter	Supply air		Non-woven fabrics filter: Gravitational method 82% + High-efficiency filter: Colorimetric method 65% (optional parts)							
	Exhaust air		Non-woven fabrics filter: Gravitational method 82%							

Note: (Dust removal)This function is enabled by using the optional high-efficiency filter.

6. Outline Drawings

6.1 Humidifying Type GUF-50/100RDH3

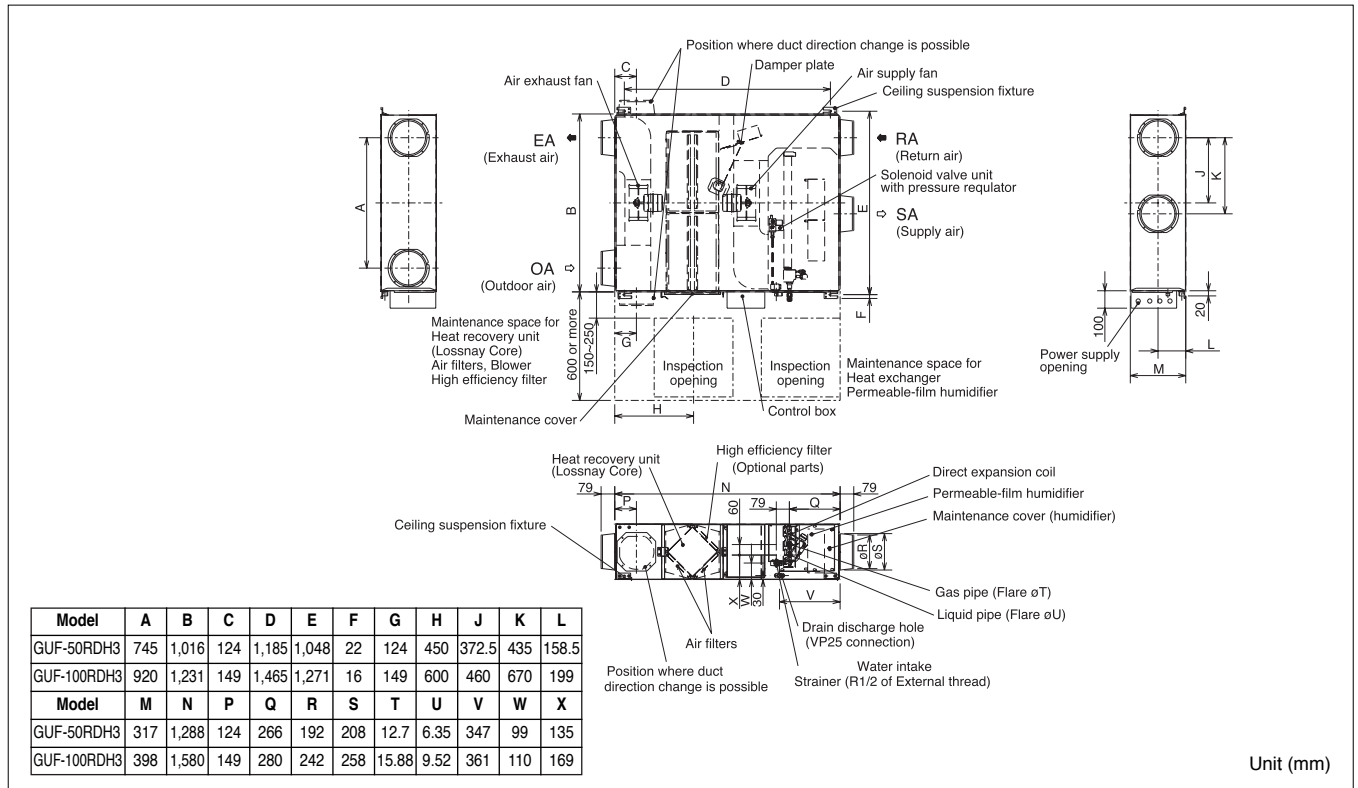

6.2 Non-Humidifying Type GUF-50/100RD3

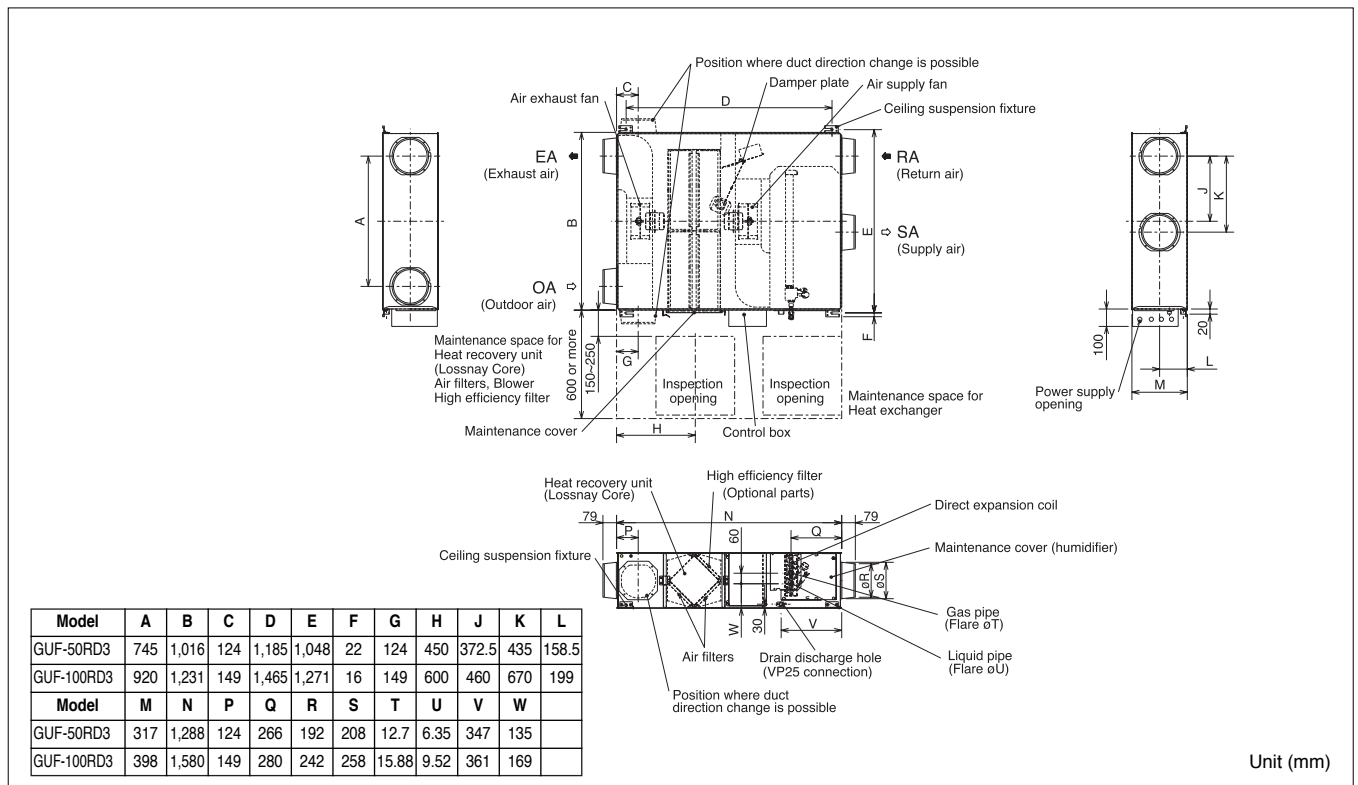

7. Electric Wiring Diagrams

7.1 Humidifying Type GUF-50/100RDH3

- TM1, TM2, TM3 shown in dotted lines are field work.
- Be sure to connect the grounding wire.
- Breakers and controller switches should be provided by the customer.

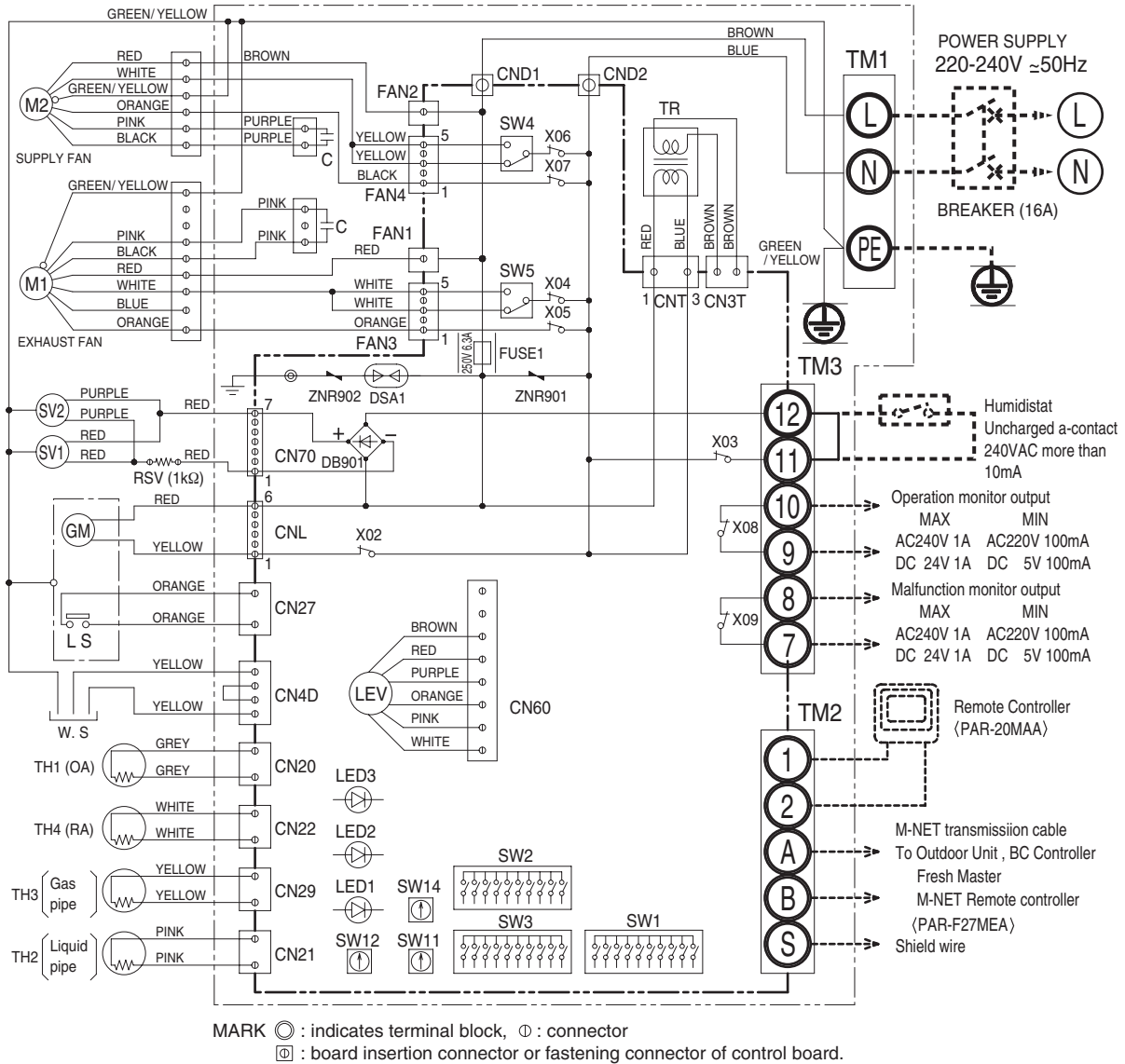

Symbol Explanation

Symbol	Name	Symbol	Name	Symbol	Name
M1	Fan motor (exhaust)	TM1	Terminal block (power supply)	1, 2	Remote controller terminal
M2	Fan motor (supply)	TM2	Terminal block (transmission)	A, B	M-NET transmission terminal
C	Capacitor	TM3	Terminal block (humidistat, monitor)	S	Shield
W. S	Water sensor	SW1	Switch (function selection)	CND1, CND2	Connector (power supply)
SV1	Solenoid valve (pressure regulator)	SW2	Switch (capacity code setting)	X02-X09	Relay
SV2	Solenoid valve (exhaust)	SW3	Switch (function selection)	TR	Transformer
TH1	Thermistor (outdoor air temp. detection)	SW4	Switch	GM	Damper motor
TH2	Thermistor (pipe temp. detection/liquid)	SW5	Switch	LS	Limit switch
TH3	Thermistor (pipe temp. detection/gas)	SW11	Switch (1st digit address set)	LED1	Power supply monitor
TH4	Thermistor (room air temp. detection)	SW12	Switch (2nd digit address set)	LED2	MA remote controller
LEV	Electronic linear expansion valve	SW14	Switch (branch NO. set)	LED3	Power supply monitor
RSV	Resistance (solenoid valve)				M-NET Power supply monitor

7.2 Non-Humidifying Type GUF-50/100RD3

- TM1, TM2 shown in dotted lines are field work.
- Be sure to connect the grounding wire.
- Breakers and controller switches should be provided by the customer.

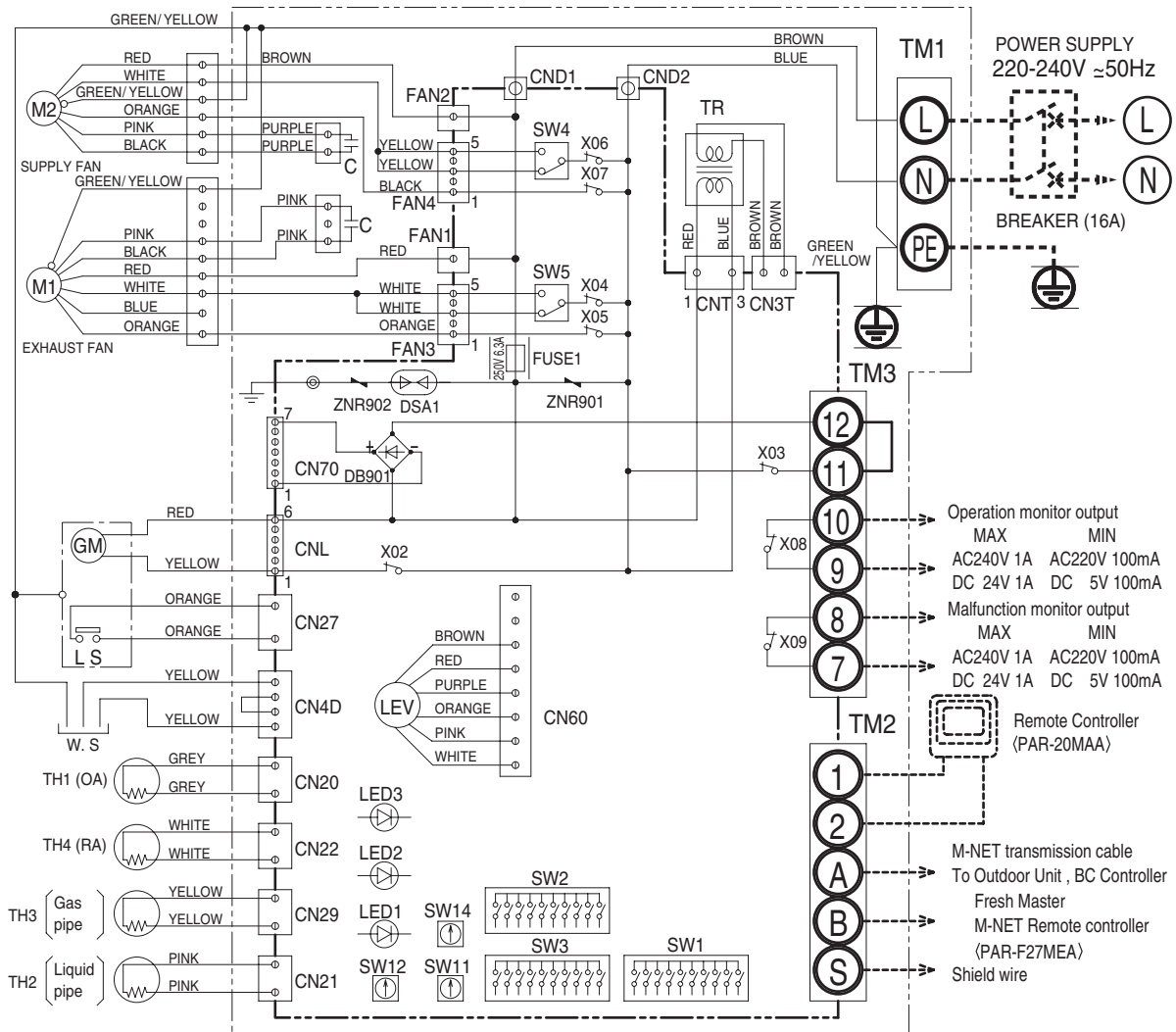

MARK : indicates terminal block, : connector
 : board insertion connector or fastening connector of control board.

Symbol Explanation

Symbol	Name	Symbol	Name	Symbol	Name
M1	Fan motor (exhaust)	TM1	Terminal block (power supply)	1, 2	Remote controller terminal
M2	Fan motor (supply)	TM2	Terminal block (transmission)	A, B	M-NET transmission terminal
C	Capacitor	TM3	Terminal block (humidistat, monitor)	S	Shield
W.S	Water sensor	SW1	Switch (function selection)	CND1, CND2	Connector (power supply)
TH1	Thermistor (outdoor air temp. detection)	SW2	Switch (capacity code setting)	X02-X09	Relay
TH2	Thermistor (pipe temp. detection/liquid)	SW3	Switch (function selection)	TR	Transformer
TH3	Thermistor (pipe temp. detection/gas)	SW4	Switch	GM	Damper motor
TH4	Thermistor (room air temp. detection)	SW5	Switch	LS	Limit switch
LEV	Electronic linear expansion valve	SW11	Switch (1st digit address set)	LED1	Power supply monitor
		SW12	Switch (2nd digit address set)	LED2	MA remote controller
		SW14	Switch (branch NO. set)	LED3	M-NET Power supply monitor

8. Characteristic Curves

8.1 Humidifying Type

GUF-50RDH3

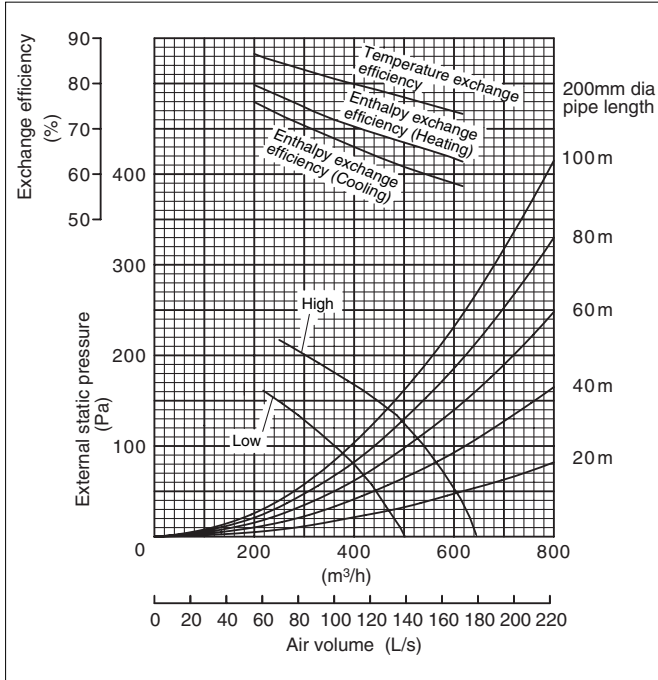

GUF-100RDH3

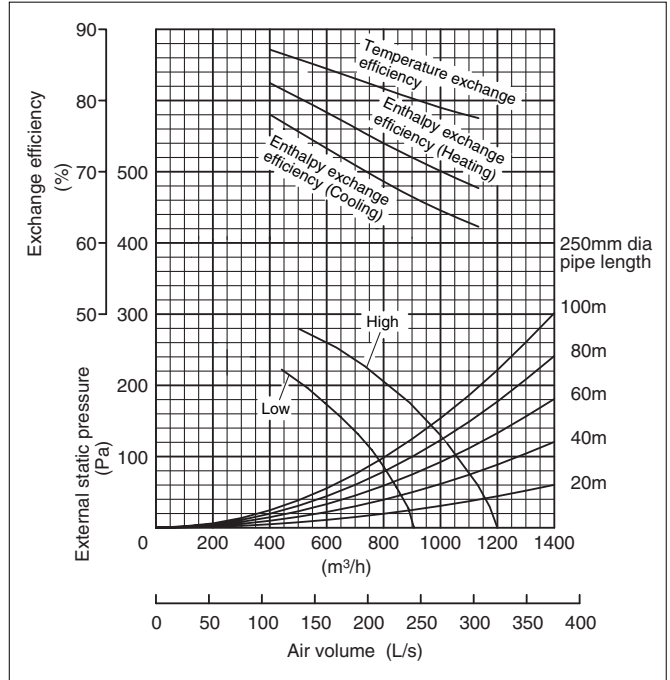

8.2 Non-Humidifying Type

GUF-50RD3

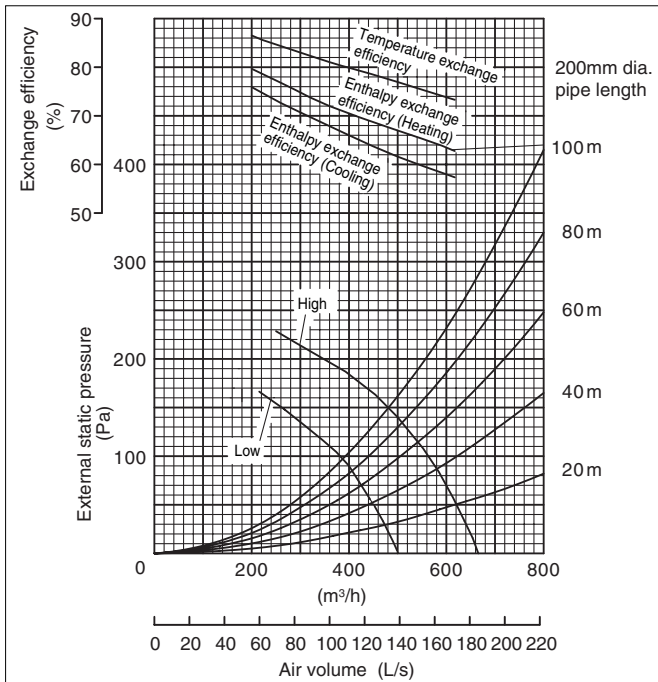

GUF-100RD3

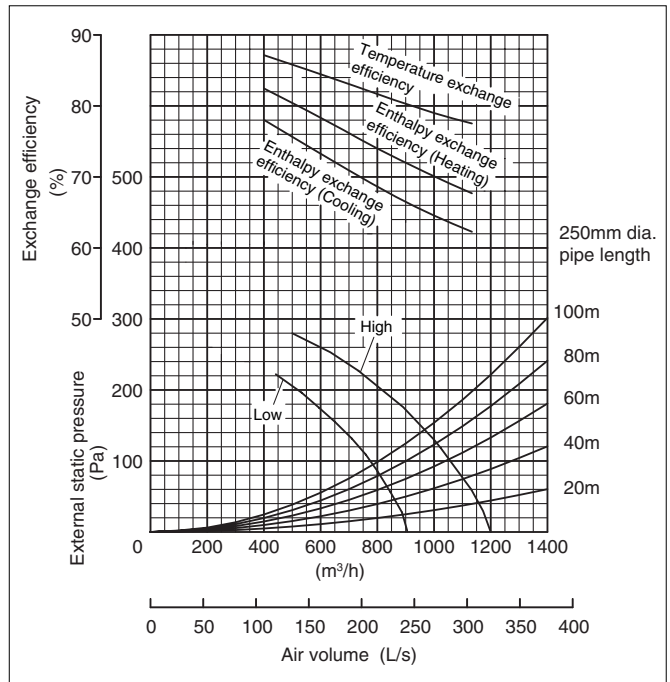

9. Construction and Principle of Heat Recovery Unit (Lossnay Core)

● Simple construction

The Lossnay Core is a cross-flow total heat recovery unit constructed of plates and fins made of treated paper. The fresh air and exhaust air passages are completely separated allowing the fresh air to be introduced without mixing with the exhaust air.

● Principle

The Lossnay Core uses the heat transfer properties and moisture permeability of the treated paper. Total heat (sensible heat plus latent heat) is transferred from the stale exhaust air to the fresh air being introduced into the system when they pass through the Lossnay Core.

Try this simple experiment. Roll a piece of paper into a tube and blow through it. Your hand holding the paper will immediately feel warm. If cold air is blown through the tube, your hand will immediately feel cool. This means heat is transferred through paper. Lossnay Core is a total heat recovery unit that utilizes these special properties of paper.

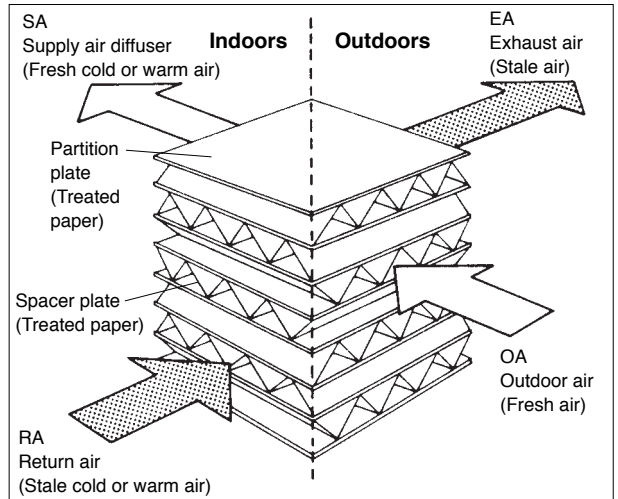

● Treated paper

The paper partition plates are specially treated so that the Lossnay Core is an appropriate heat recovery unit for the ventilator. This paper differs from ordinary paper, and has the following unique properties.

- (1) The paper is incombustible and is strong.
- (2) The paper has selective hygroscopicity and moisture permeability that permits the passage of water vapor only (including some water-soluble gases).
- (3) The paper has gas barrier properties that does not pass gases such as CO₂.

A comparison of the ordinary paper and the Lossnay Core plates is as shown in the table.

Ordinary paper	
<p>Water vapor is transferred, but gas elements that are easily dissolved in water such as CO₂, NO₂ are also transferred.</p> <div style="text-align: center;"> </div> <p>The contaminated air passes through the plates during ventilation and returns to the room.</p>	
Treated paper	
<p>Water vapor is transferred, but gas elements such as CO₂, NO₂ are not transferred.</p> <div style="text-align: center;"> </div> <p>The contaminated air does not return to the room when ventilated.</p>	

● Total heat recovery mechanism

Sensible heat and latent heat

The heat that enters and leaves in accordance with changing temperature (rise or drop) is called sensible heat. The heat that enters and leaves due to the changes in the physical properties of the matter (evaporation, condensation) is called latent heat.

(1) Heat (sensible heat) exchange

- 1) Heat conduction and heat passage is performed through a partition plate from the high temperature to low temperature side.
- 2) As shown on the right, the heat exchange efficiency is affected by the resistance of the boundary layer, and for the Lossnay Core there is little difference when compared to materials such as copper or aluminium which also have high thermal conductivity.

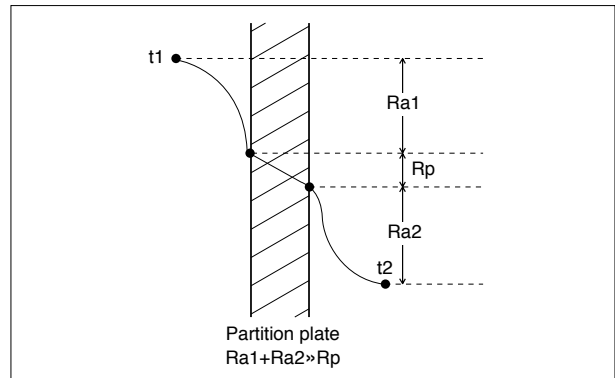

Heat resistance coefficients

	Treated paper	Cu	Al
R_{a1}	10	10	10
R_p	1	0.00036	0.0006
R_{a2}	10	10	10
Total	21	20.00036	20.0006

(2) Humidity (latent heat) exchange

- Water vapor is moved through the partition plate from the high humidity to the low humidity side by means of the differential pressure in the vapor.

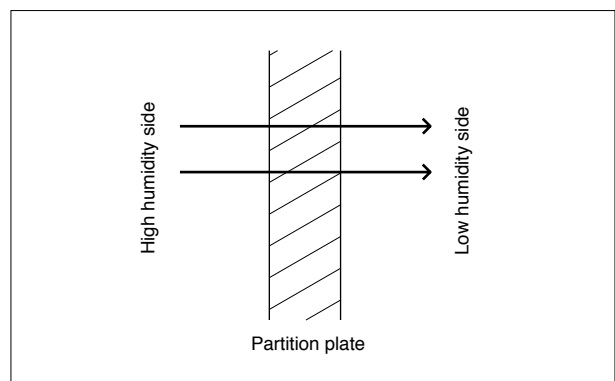

10. Total Heat Recovery Characteristics

10.1 Lossnay Core Heat Recovery Characteristic

GUf-50RDH3/50RD3

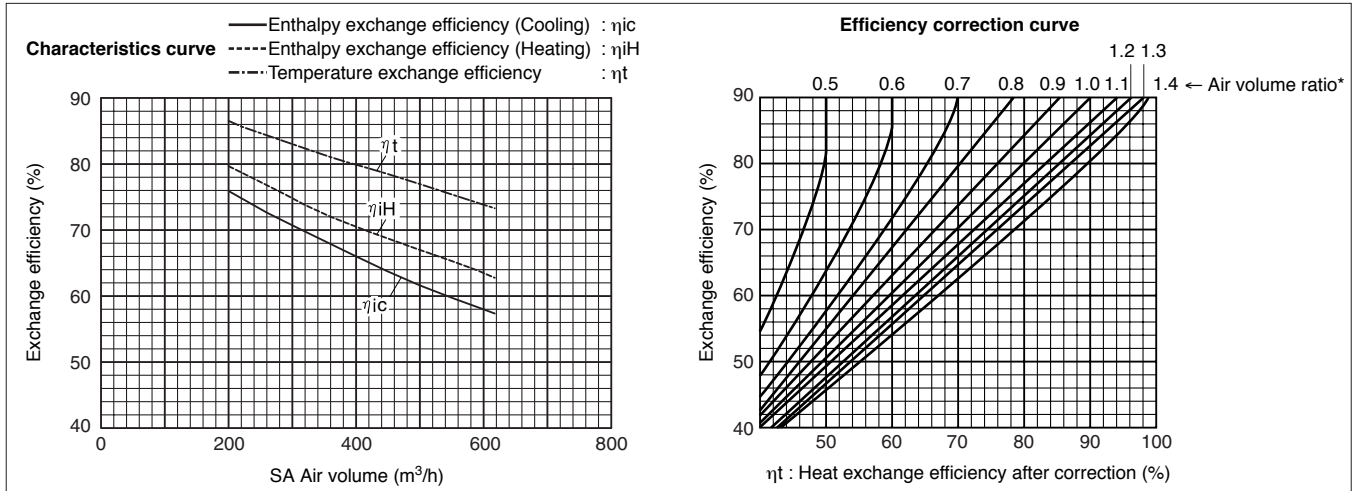

GUf-100RDH3/100RD3

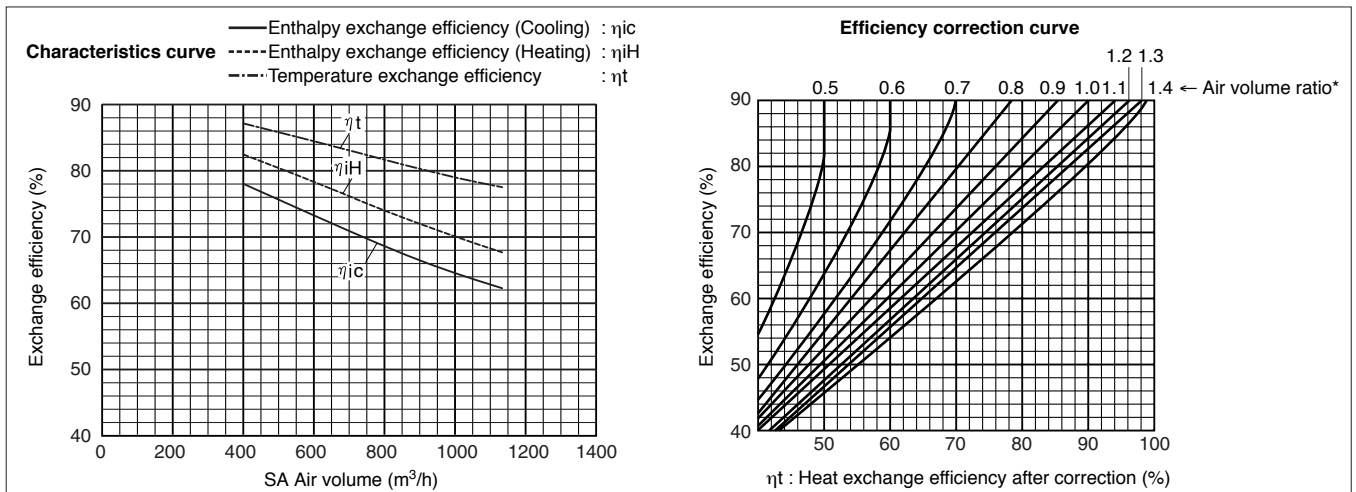

$$* \text{Air volume ratio} = \frac{\text{Exhaust air flow volume}}{\text{Supply air flow volume}}$$

● Obtaining the efficiency when supply air and exhaust air volumes differ

The efficiency obtained from the intake side air volume in each characteristic curve can be corrected with the air volume ratio in the chart on the right.

If the intake side and exhaust side duct lengths differ greatly or if a differential air volume is required, obtain the intake side efficiency from the chart on the right.

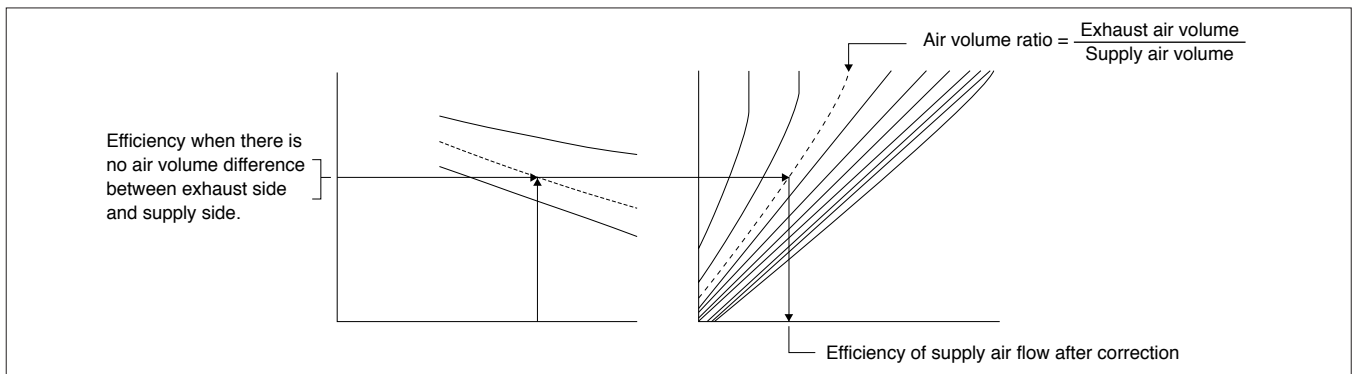

11. Principle and Features of Permeable Film Humidifier

11.1 Principles and Construction of Permeable Film Humidifier

Basic

A permeable film type humidifier uses the basic characteristics of natural evaporation. In this model, those characteristics have been dramatically improved. The main points of the improvement are that the water is wrapped in an ultra-water-repellant porous film (the permeable film) that forms a surface for releasing the water vapor and that the surface area of this evaporating surface has been dramatically increased.

Principle

As shown in Fig. 1, there are tubes filled with water. Space is provided between these tubes for air to pass through, forming a “layered strip” design that ensures rectangular-shaped flow passages. Since the permeable film of the tube (ultra-water repellent porous film) allows water moisture to pass through in an evaporated state, the water in the tube is released from the surface of the tube in an evaporated state and is included with the passing air as shown in Fig. 1 (b). As can be seen by looking Fig. 2, spacers have been placed between the tubes of permeable film to form layered openings for air to pass through. This provides an extremely large humidifying surface area – 8.5 times larger than natural evaporation type humidifiers of the same size and offering an increase of humidifying performance that is 6 times greater.

Fig. 1 Principles behind permeable film humidifier

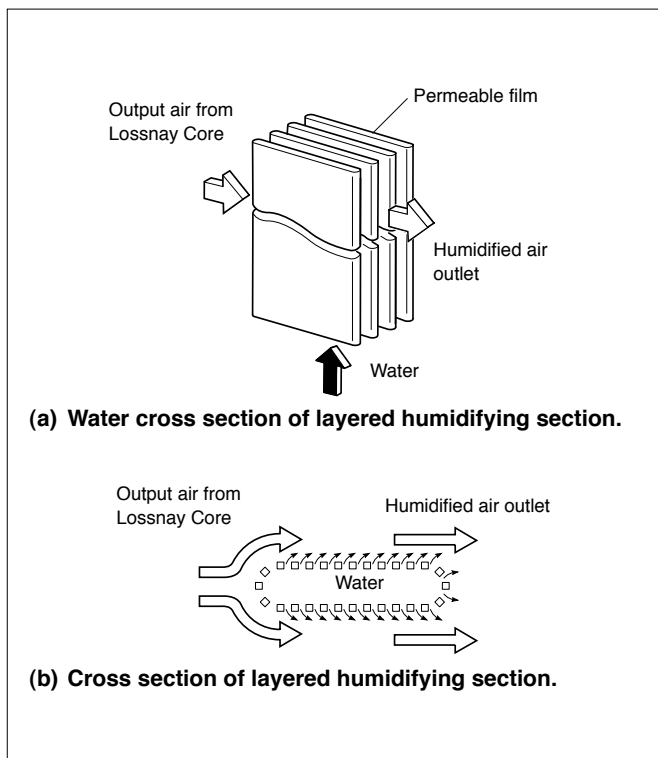
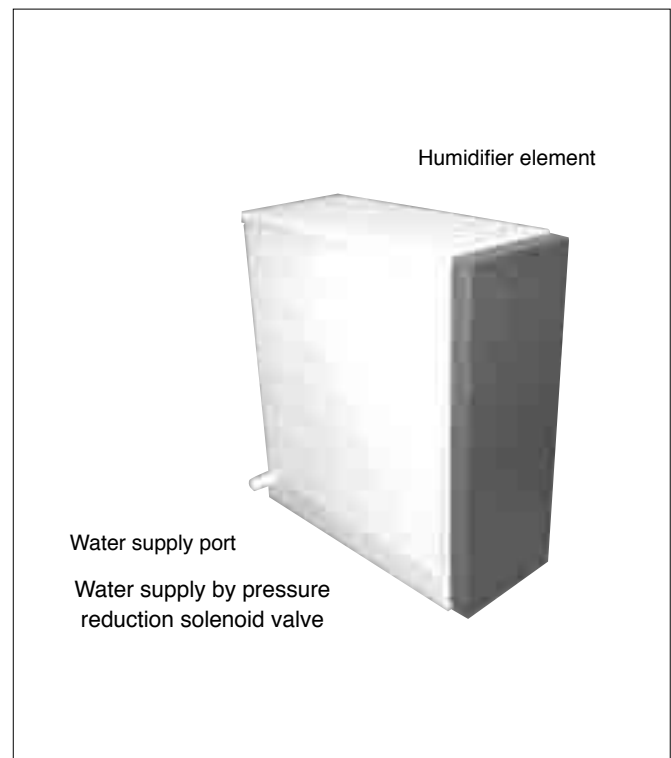

Fig. 2 Humidifying module



Construction

- 1) The water supply unit is comprised of strainer, pressure reduction solenoid valve and supply pipe. This design ensures stable water pressure and water volume are supplied to the humidifier unit.
The strainer removes foreign material as water passes through the water supply piping. The solenoid valve opens to allow the water to be supplied while the pressure reduction valve ensures that water pressure is maintained at 7 kPa or less as water is supplied to the humidifier unit.
(If the water pressure exceeds 7 kPa, the safety valve opens and the water is discharged to a drain.)
- 2) As explained in the operating principles for the humidifying unit, the tube-shaped permeable film is arranged in a layered construction and spacers have been provided to create opening for the air to pass through. Water is supplied to these tubes and then evaporates from their surfaces into the air.
Note that any impurities in the water settle to the bottom of the tube and, due to the extremely large surface area of the permeable film, have almost no affect on the creation of humidity.

Basic design of a permeable film humidifier

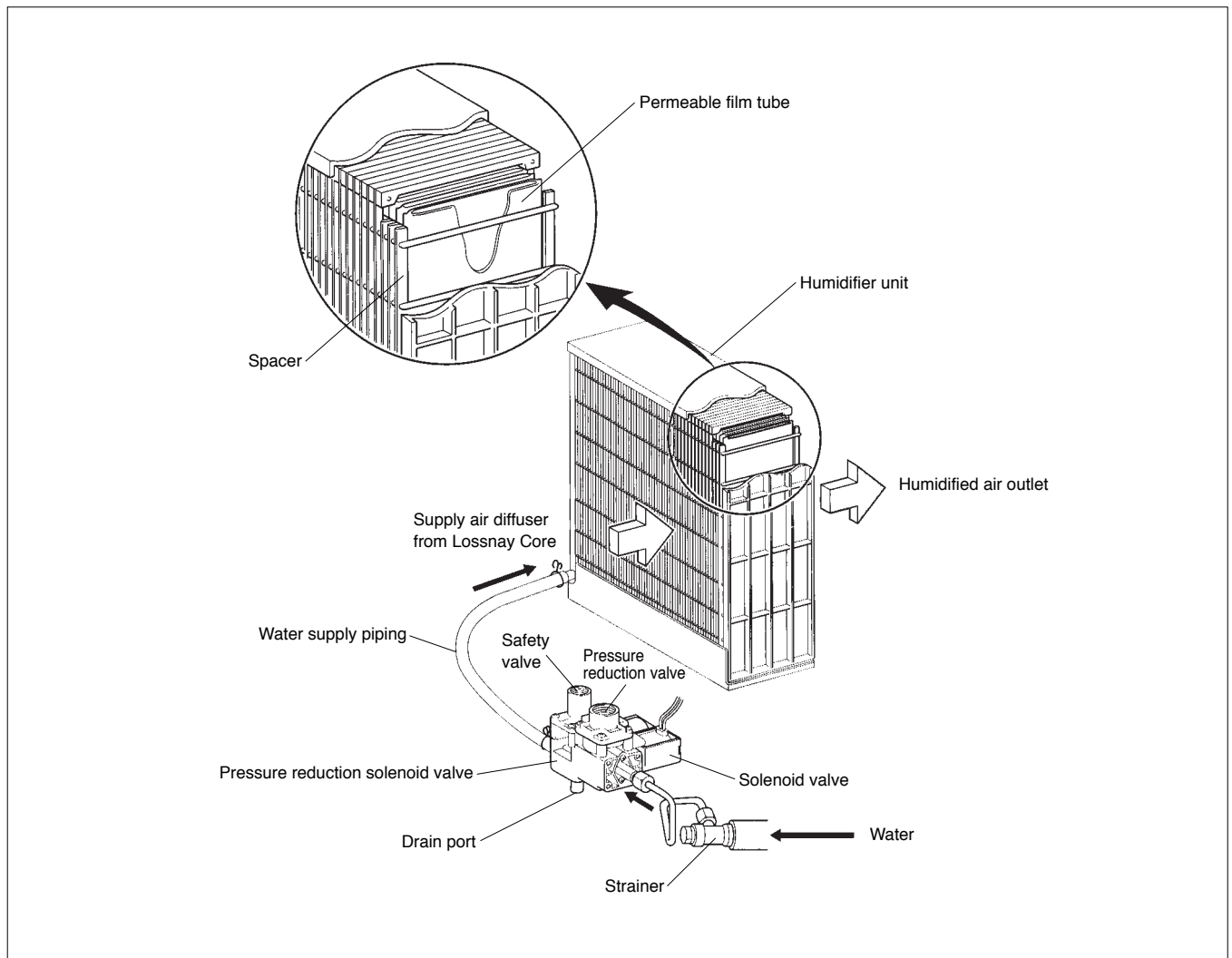

11.2 Features of Permeable Film Humidifier

Design of the new type permeable film type humidifier

The previous type of permeable film had a selective-type permeable layer that only allowed water vapor to pass through surfaces in contact with water and base cloth with a layer of porous PTFE with extremely fine pores with 1/20,000 water droplets and 1,000 times water vapor (0.1 to 1 μm) that allowed evaporation without air or water passing through. The new type permeable film does not have the base cloth used in the previous permeable membrane. Instead, it has an ultra water-resistant porous permeable film that reduces the resistance to permeation by 1/2 when compared with the previous type and a 3-dimensional fabric that ensures water passages inside the permeable film tube, dramatically improving the ability for water vapor only to permeate.

● Previous permeable film

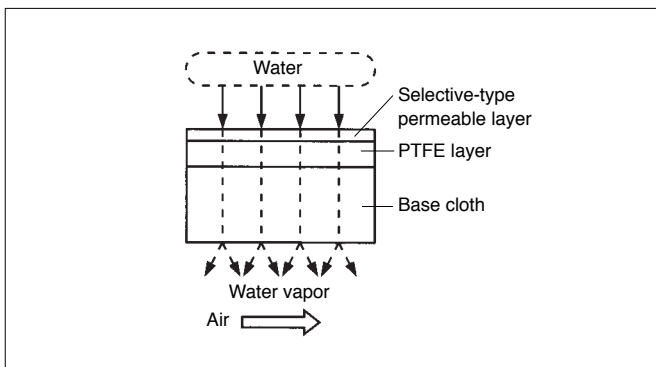

● New type permeable film type

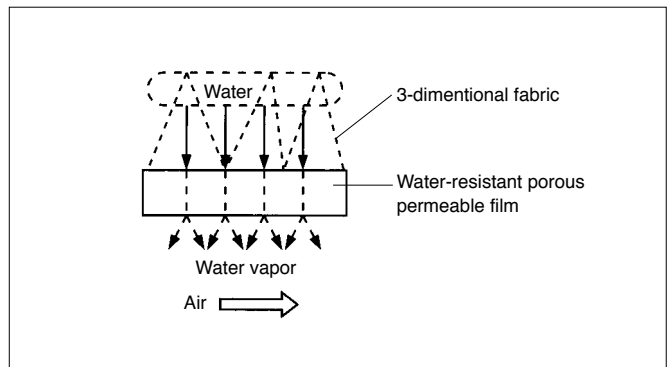

● New unit

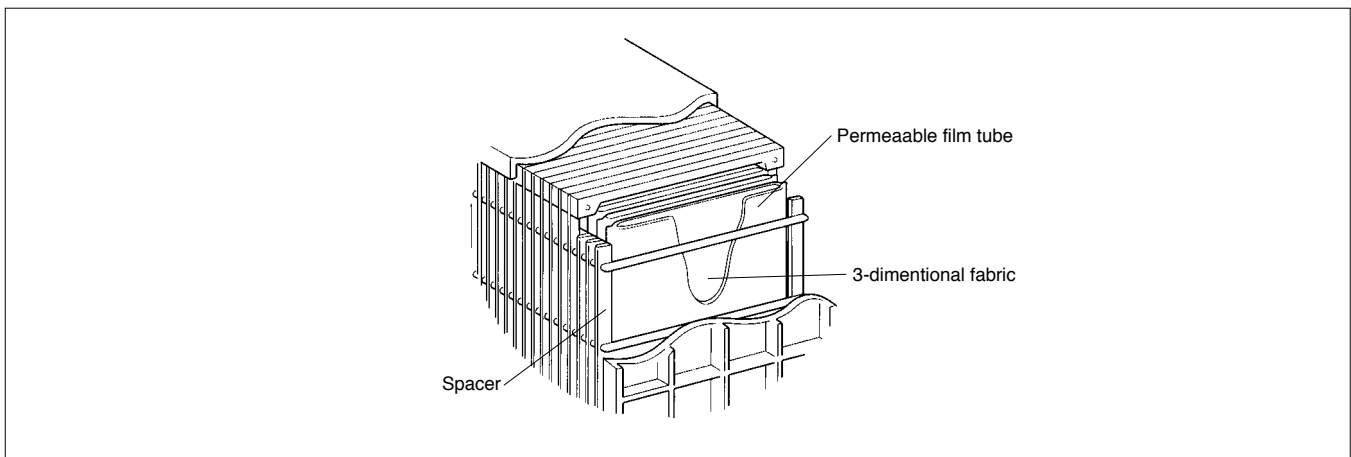

● 3-dimensional fabric

The 3-dimensional fabric inside the new type of permeable film tube is comprised of spiral-like threads that are attached upright in the tube. These act as a type of reinforcing material for ensuring the passage of water inside the permeable film tubes.

This 3-dimensional fabric used in the new type permeable film type humidifier keep the permeable film tubes from collapsing and ensure that the water supplied at a constant pressure from the water supply port at the base of the humidifier seeps to the ends of the humidifying surface.

Reference

Quick reference graph for amount of humidifying

Conditions:

- The air flow is the rated air flow (GUF-50RDH3: 500 m³/h GUF-100RDH3: 1,000 m³/h)
- The connections to the outdoor unit are an OA processing unit and indoor unit for a total capacity of 100%.
- The relative humidity of the outdoor air is 50%.

GUF-50RDH3

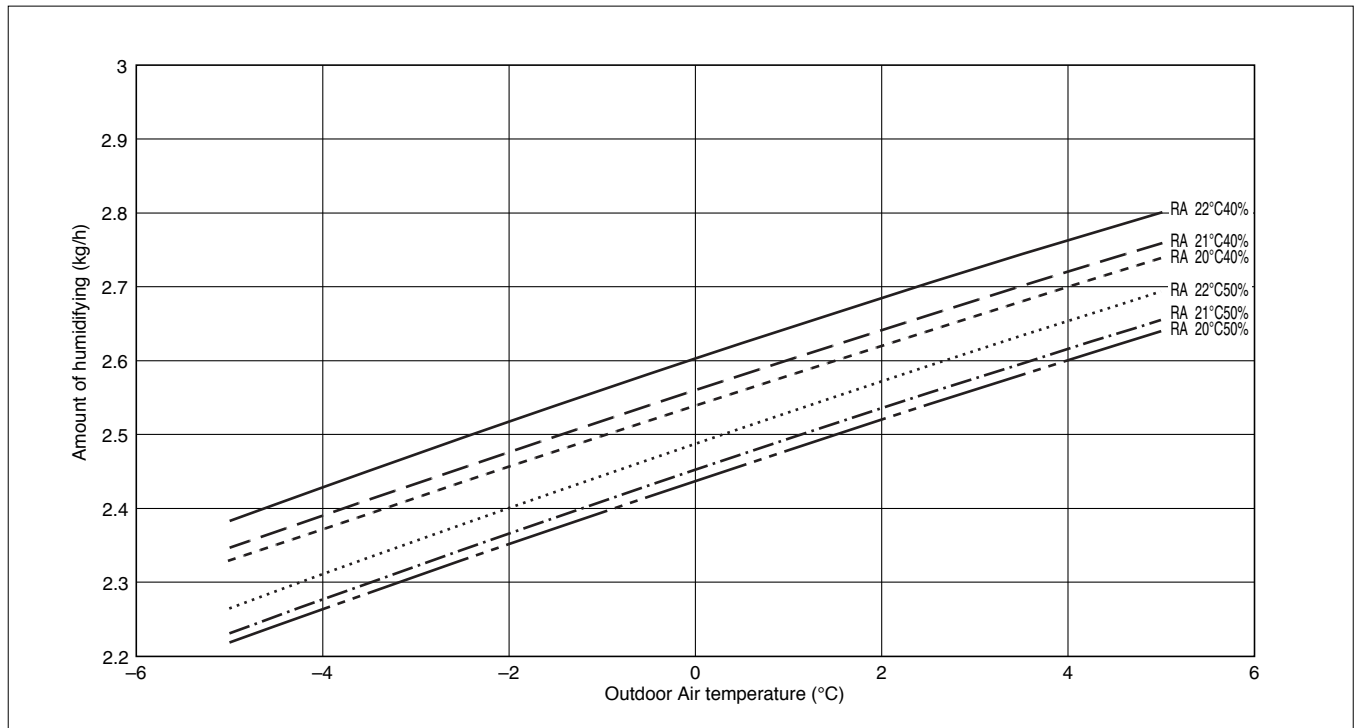

GUF-100RDH3

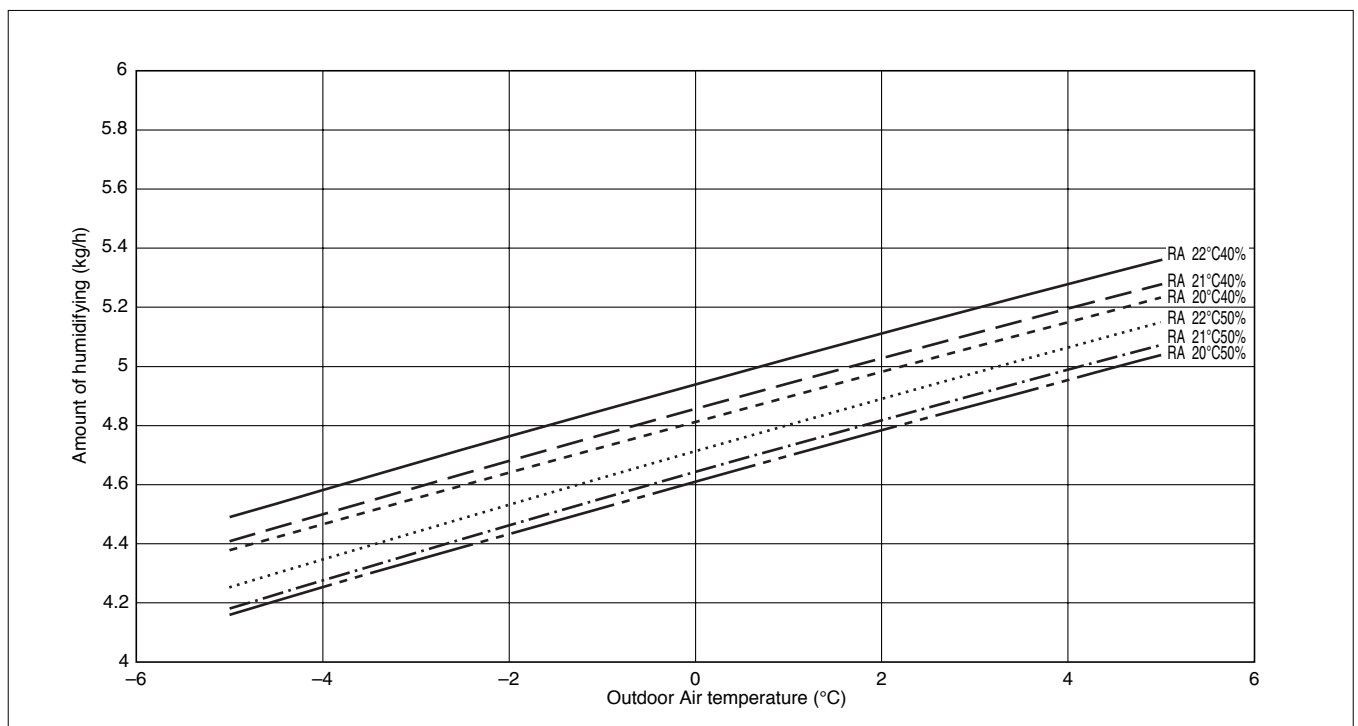

12. Cooling and Heating Characteristics

12.1 Direct Expansion Coil Characteristics

12.1.1 Rated operating conditions <At rated air flow>

			Dry bulb temperature	Wet bulb temperature	Relative humidity	Enthalpy
Cooling	Outdoor air		35°CDB	24°CWB	40%	71.6kJ/kg
	Indoor air		27°CDB	19.5°CWB	50%	55.7kJ/kg
	Heat exchange inlet air (Lossnay Core outlet temperature)	50	28.8°CDB	21.3°CWB	51.7%	61.7kJ/kg
		100	28.7°CDB	21.2°CWB	51.4%	61.2kJ/kg
Heating	Outdoor air		7°CDB	6°CWB	85%	20.5kJ/kg
	Indoor air		21°CDB	14.6°CWB	50%	40.6kJ/kg
	Heat exchange inlet air (Lossnay Core outlet temperature)	50	17.8°CDB	12.0°CWB	49.9%	33.9kJ/kg
		100	18.1°CDB	12.3°CWB	50.5%	34.7kJ/kg

12.1.2 Standard cooling and heating performance

Model number	Model 50	Model 100
City Multi indoor unit equivalent	32	63
Cooling capacity	3.63kW	7.32kW
Heating capacity	4.17kW	8.30kW

Note: When using a combination of City Multi and Air Multi units, there is a need to calculate the total value of performance capacity of the indoor units connected to each outdoor unit as a parameter. This information can be found in the technical documentation for the units. Refer to the City Multi Data Book for details.

12.1.3 Cooling Capacity (In combination with PUHY, PURY)

GUF-50RD3

CA:Capacity (kW)
SHC:Sensible heat capacity (kW)

RA		21.5°CDB 15°CWB		23°CDB 16°CWB		25°CDB 18°CWB		27°CDB 19.5°CWB		28°CDB 20°CWB		30°CDB 22°CWB		32°CDB 24°CWB	
DB	WB	CA	SHC	CA	SHC	CA	SHC	CA	SHC	CA	SHC	CA	SHC	CA	SHC
20.0	12.0	3.3	2.0	3.4	2.1	3.4	2.1	3.5	2.1	3.6	2.2	3.7	2.3	3.8	2.3
22.5	14.0	3.3	2.0	3.4	2.1	3.5	2.1	3.6	2.2	3.6	2.2	3.7	2.3	3.8	2.3
25.0	16.0	3.3	2.0	3.4	2.1	3.5	2.1	3.5	2.1	3.6	2.2	3.8	2.3	3.8	2.3
27.5	18.0	3.3	2.0	3.4	2.1	3.5	2.1	3.5	2.1	3.6	2.3	3.7	2.2	3.8	2.2
30.0	20.0	3.4	2.1	3.4	2.1	3.5	2.1	3.5	2.1	3.6	2.2	3.7	2.2	3.8	2.2
32.5	22.0	3.4	2.0	3.4	2.0	3.4	2.1	3.5	2.1	3.7	2.2	3.7	2.2	3.8	2.2
35.0	24.0	3.3	1.9	3.4	2.0	3.4	2.1	3.6	2.2	3.6	2.2	3.7	2.1	3.8	2.2
37.5	26.0	3.3	1.9	3.4	2.0	3.4	2.1	3.6	2.1	3.6	2.1	3.7	2.1	3.7	2.1
40.0	28.0	3.3	1.9	3.3	1.9	3.5	2.0	3.6	2.1	3.5	2.0	3.7	2.1	3.7	2.1
43.0	30.0	3.3	1.9	3.3	1.9	3.5	2.0	3.6	2.0	3.5	1.9	3.6	2.0	3.6	2.0

GUF-100RD3

CA:Capacity (kW)
SHC:Sensible heat capacity (kW)

OA \ RA		21.5°CDB 15°CWB		23°CDB 16°CWB		25°CDB 18°CWB		27°CDB 19.5°CWB		28°CDB 20°CWB		30°CDB 22°CWB		32°CDB 24°CWB	
		CA	SHC	CA	SHC	CA	SHC	CA	SHC	CA	SHC	CA	SHC	CA	SHC
20.0	12.0	6.9	4.3	7.0	4.5	7.0	4.5	7.3	4.6	7.4	4.6	7.6	4.9	7.9	4.9
22.5	14.0	6.9	4.3	7.0	4.4	7.2	4.4	7.4	4.5	7.4	4.5	7.6	4.9	7.8	4.8
25.0	16.0	6.9	4.3	7.1	4.4	7.2	4.4	7.3	4.5	7.3	4.5	7.7	4.7	7.8	4.8
27.5	18.0	6.9	4.3	7.1	4.4	7.2	4.4	7.2	4.4	7.3	4.6	7.6	4.7	7.9	4.7
30.0	20.0	6.9	4.2	7.0	4.2	7.1	4.3	7.2	4.5	7.3	4.5	7.6	4.7	7.9	4.7
32.5	22.0	6.9	4.2	7.0	4.2	7.1	4.3	7.2	4.4	7.4	4.5	7.6	4.6	7.8	4.6
35.0	24.0	6.9	4.2	7.0	4.2	7.0	4.2	7.3	4.4	7.4	4.5	7.7	4.5	7.7	4.4
37.5	26.0	6.8	4.0	6.9	4.2	7.1	4.3	7.4	4.5	7.4	4.5	7.6	4.4	7.6	4.4
40.0	28.0	6.8	4.0	6.9	4.1	7.2	4.3	7.3	4.4	7.3	4.4	7.6	4.4	7.6	4.4
43.0	30.0	6.8	4.0	6.9	4.1	7.2	4.2	7.2	4.2	7.3	4.2	7.5	4.3	7.5	4.3

*The above data shows an assumed value obtained by calculation.

12.1.4 Heating Capacity (In combination with PUHY, PURY)

GUF-50RD3

OA \ RA		15	20	21	25	27
DB	WB	SHC	SHC	SHC	SHC	SHC
-14.6	-15.0	2.8	2.8	2.8	2.8	2.8
-11.5	-12.0	3.0	3.0	3.0	3.0	3.0
-9.5	-10.0	3.2	3.2	3.2	3.1	3.1
-6.9	-7.5	3.4	3.4	3.4	3.3	3.3
-4.3	-5.0	3.6	3.6	3.6	3.5	3.5
-1.8	-2.5	3.8	3.8	3.8	3.7	3.7
1.0	0	4.0	4.0	4.0	3.9	3.9
3.5	2.5	4.2	4.2	4.2	4.1	4.0
6.0	5.0	4.2	4.2	4.2	4.2	4.0
7.0	6.0	4.2	4.2	4.2	4.0	4.0
8.8	7.5	4.4	4.4	4.4	4.0	4.0
11.5	10.0	4.7	4.2	4.2	4.0	4.0
14.0	12.5	5.0	4.2	4.2	4.0	3.3
16.5	15.0	5.0	4.2	4.2	3.3	3.3
17.0	15.5	5.0	4.2	4.2	3.3	3.3

GUF-100RD3

OA \ RA		15	20	21	25	27
DB	WB	SHC	SHC	SHC	SHC	SHC
-14.6	-15.0	5.6	5.6	5.6	5.6	5.6
-11.5	-12.0	6.0	6.0	6.0	6.0	5.9
-9.5	-10.0	6.3	6.3	6.3	6.3	6.3
-6.9	-7.5	6.7	6.7	6.7	6.7	6.7
-4.3	-5.0	7.1	7.1	7.1	7.1	7.1
-1.8	-2.5	7.5	7.5	7.5	7.5	7.5
1.0	0	7.9	7.9	7.9	7.8	7.8
3.5	2.5	8.3	8.3	8.3	8.2	8.0
6.0	5.0	8.3	8.3	8.3	8.3	8.0
7.0	6.0	8.3	8.3	8.3	8.0	8.0
8.8	7.5	8.7	8.7	8.7	8.0	8.0
11.5	10.0	9.3	8.3	8.3	8.0	8.0
14.0	12.5	9.9	8.3	8.3	8.0	6.5
16.5	15.0	10.0	8.3	8.3	6.5	6.5
17.0	15.5	10.0	8.3	8.3	6.5	6.5

*The above data shows an assumed value obtained by calculation.

12.2 Correction at frosting and defrosting

When a decrease in heating capacity due to frosted and defrosting operations is considered, the value multiplied by the correction factor in the table below represents the heating capacity. Refer to the City Multi Data Book for details.

12.2.1 R410A refrigerant unit

Correction factor table

Outdoor inlet air temp (°C)		6	4	2	1	0	-2	-4	-6	-8	-10
Correction factor	PUHY-P200/P250YGM-A PURY-P200/P250YGM-A	1.0	0.95	0.84	0.83	0.83	0.87	0.90	0.95	0.95	0.95
	PUHY-P300YGM-A PURY-P300YGM-A	1.0	0.93	0.82	0.80	0.82	0.86	0.90	0.90	0.95	0.95
	PUHY-P350YGM-A PURY-P350YGM-A	1.0	0.93	0.85	0.83	0.84	0.86	0.90	0.90	0.95	0.95
	PUHY-P400YGM-A PURY-P400YGM-A	1.0	0.95	0.90	0.87	0.88	0.89	0.90	0.95	0.95	0.95
	PUHY-P450/P500YGM-A PURY-P450/P500YGM-A	1.0	0.98	0.89	0.86	0.89	0.90	0.92	0.95	0.95	0.95

12.2.2 R22 refrigerant unit

Corection factor table

Outdoor inlet air temp (°C)		6	4	2	0	-2	-4	-6	-8	-10
Correction factor	PUHY-200/250YEM-A PUHY-200/250YEMC-A PURY-200/250YEMC-A	1.0	0.95	0.84	0.83	0.87	0.90	0.95	0.95	0.95
	PUHY-315YEM-A PUHY-315YEMC-A	1.0	0.93	0.82	0.82	0.86	0.90	0.90	0.95	0.95
	PUHY-400/500YEM-A PUHY-400/500YEMC-A	1.0	0.98	0.89	0.89	0.86	0.90	0.92	0.95	0.95

12.3 Correction by temperature

12.3.1 R410A refrigerant unit

(1) Cooling

Standard specifications

		PUHY-P200YGM-A	PUHY-P250YGM-A	PUHY-P300YGM-A	PUHY-P350YGM-A	PUHY-P400YGM-A	PUHY-P450YGM-A	PUHY-P500YGM-A
Capacity	kW	22.4	28.0	33.5	40.0	45.0	50.0	56.0
Input	kW	6.14	7.72	9.57	11.39	13.42	13.61	15.59
Source	V	380/400/415						
Current	A	10.3/9.8/9.4	13.0/12.3/11.9	16.1/15.3/14.7	19.2/18.2/17.6	22.6/21.5/20.7	22.9/21.8/21.0	26.3/25.0/24.0

● Calculation

$$\text{Capacity}' = \text{Capacity} \times \text{Ratio}$$

$$\text{Input}' = \text{Input} \times \text{Ratio}$$

$$\text{Current}' = \frac{\text{Input}' \times 1,000}{\sqrt{3} \times \text{Source} \times 0.91}$$

$$\left. \begin{array}{l} * \text{Capacity}' \\ \text{Input}' \\ \text{Current}' \end{array} \right\} \text{After correction}$$

PUHY-P200/P250YGM-A

The ratio of cooling capacity

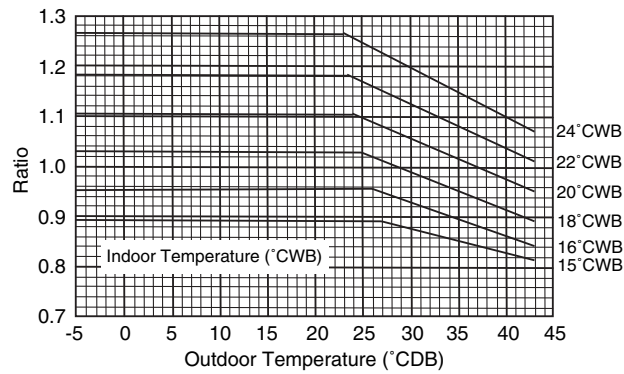

The ratio of cooling power input

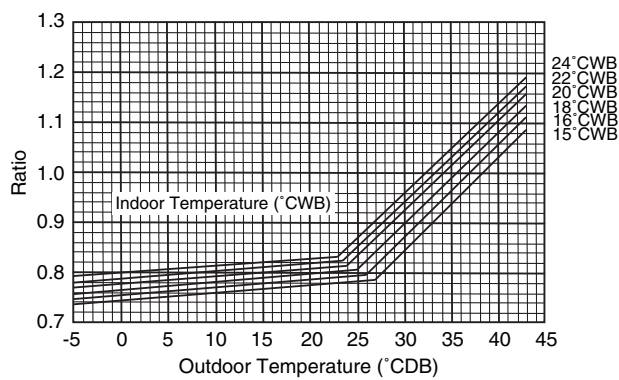

PUHY-P300/P350/P400YGM-A

The ratio of cooling capacity

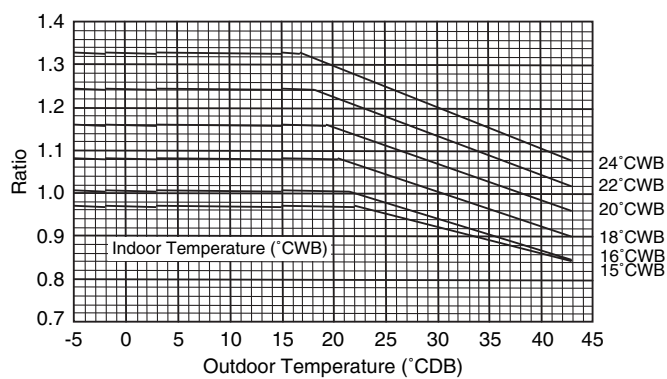

The ratio of cooling power input

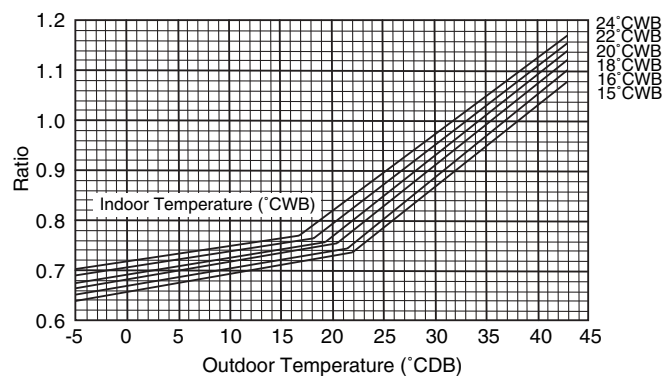

PUHY-P450/P500YGM-A

The ratio of cooling capacity

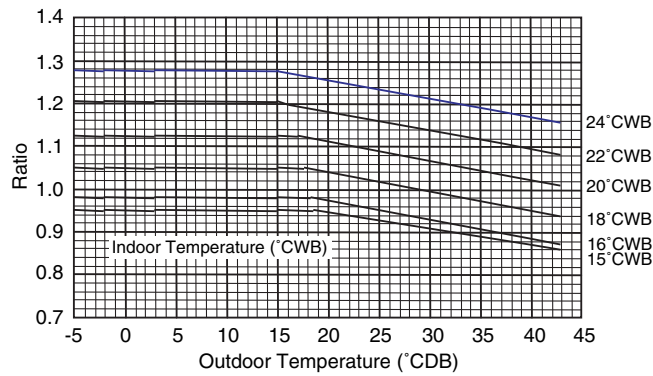

The ratio of cooling power input

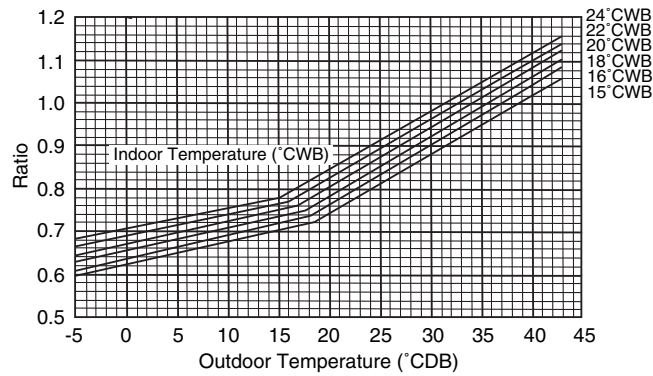

(2) Heating

Standard specifications

		PUHY-P200YGM-A	PUHY-P250YGM-A	PUHY-P300YGM-A	PUHY-P350YGM-A	PUHY-P400YGM-A	PUHY-P450YGM-A	PUHY-P500YGM-A
Capacity	kW	25.0	31.5	37.5	45.0	50.0	56.0	63.0
Input	kW	5.98	7.62	9.10	11.02	12.43	13.86	15.89
Source	V	380/400/415						
Current	A	10.0/9.5/9.2	12.8/12.2/11.7	15.3/14.5/14.0	18.6/17.6/17.0	20.9/19.9/19.2	23.3/22.2/21.4	26.8/25.4/24.5

● Calculation

Capacity' = Capacity × Ratio

Input' = Input × Ratio

$$\text{Current}' = \frac{\text{Input}' \times 1,000}{\sqrt{3} \times \text{Source} \times 0.91}$$

* Capacity' }
 Input' } After correction
 Current' }

PUHY-P200/P250YGM-A

The ratio of heating capacity

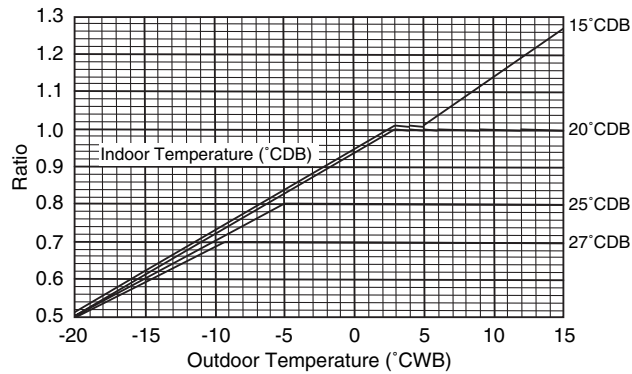

The ratio of heating power input

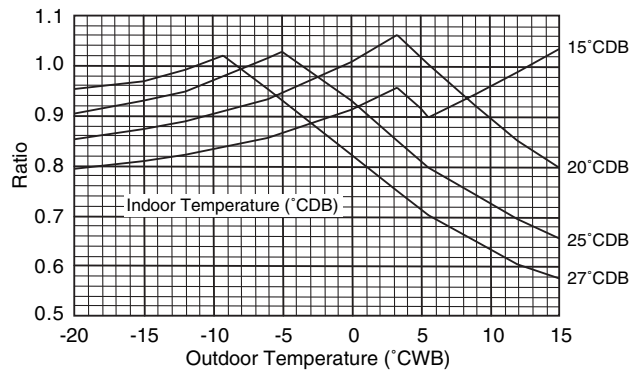

PUHY-P300/P350/P400YGM-A

The ratio of heating capacity

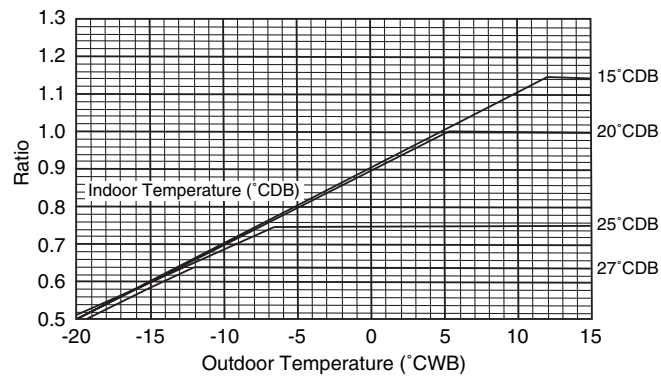

The ratio of heating power input

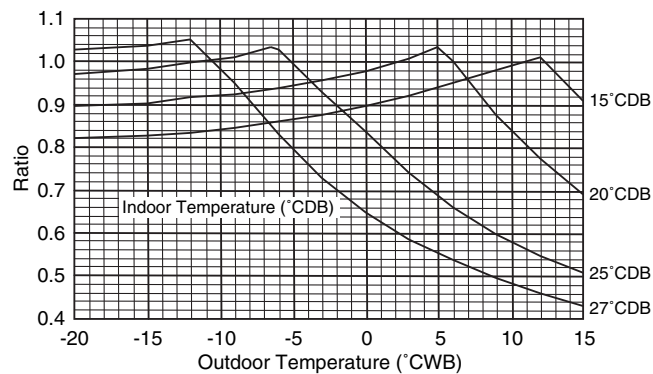

PUHY-P450/P500YGM-A

The ratio of heating capacity

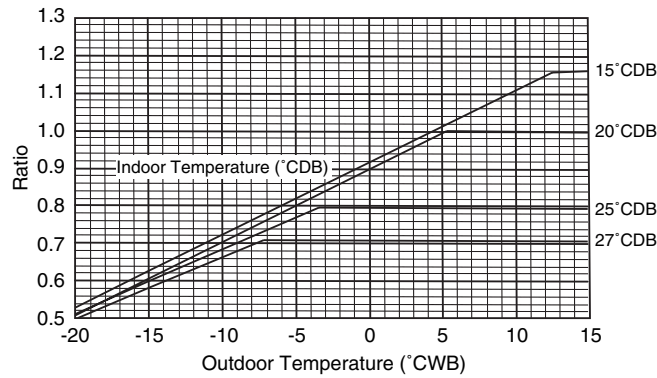

The ratio of heating power input

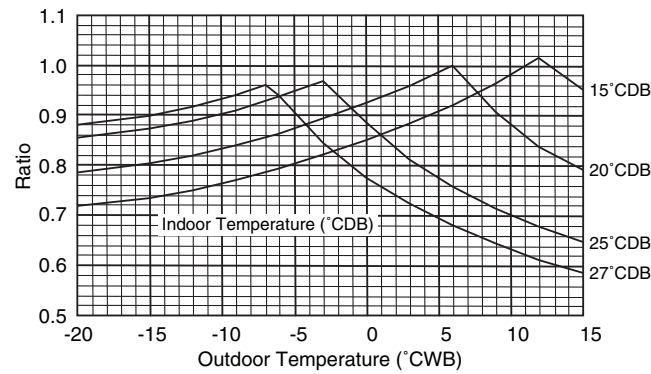

12.3.2 R22 refrigerant unit

(1) Cooling

Standard specifications

		PUHY-200YEMC-A	PUHY-250YEMC-A	PUHY-315YEMC-A	PUHY-400YEMC-A	PUHY-500YEMC-A	PURY-200YEMC-A	PURY-250YEMC-A
Capacity	kW	24.6	28.0	35.5	45.0	56.0	24.6	28.0
Input	kW	7.13	8.37	12.05	15.87	18.98	9.65	10.56
Source	V	380/400/415						
Current	A	12.0/11.4/11.0	14.1/13.4/12.9	19.9/18.9/18.2	26.7/25.4/24.5	32.0/30.4/29.3	16.2/15.4/14.9	17.8/16.9/16.3

● Calculation

Capacity' = Capacity × Ratio

Input' = Input × Ratio

Current' = $\frac{\text{Input}' \times 1,000}{\sqrt{3} \times \text{Source} \times 0.91}$

* Capacity' }
 Input' } After correction
 Current' }

PUHY-200/250/315YEMC-A

The ratio of cooling capacity

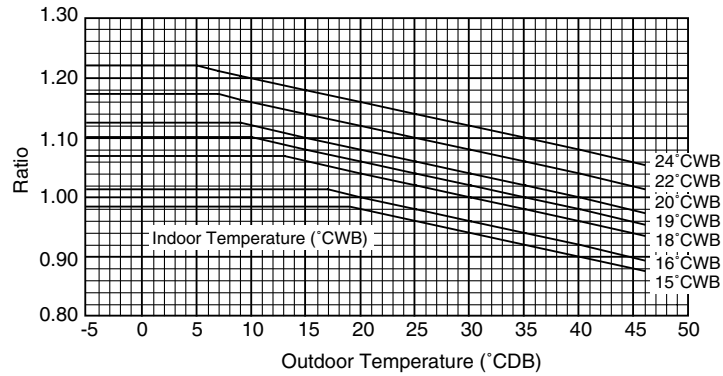

The ratio of cooling power input

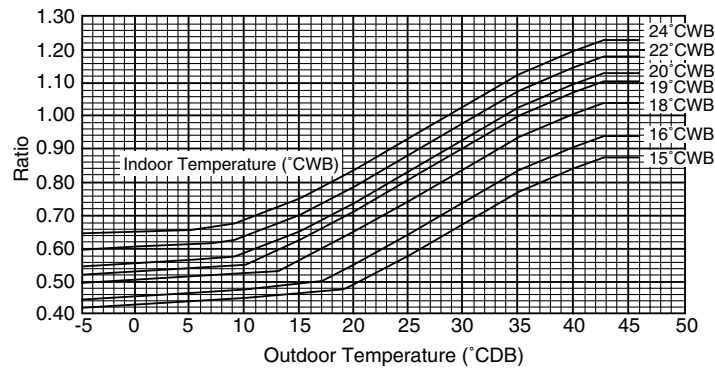

PUHY-400/500YEMC-A

The ratio of cooling capacity

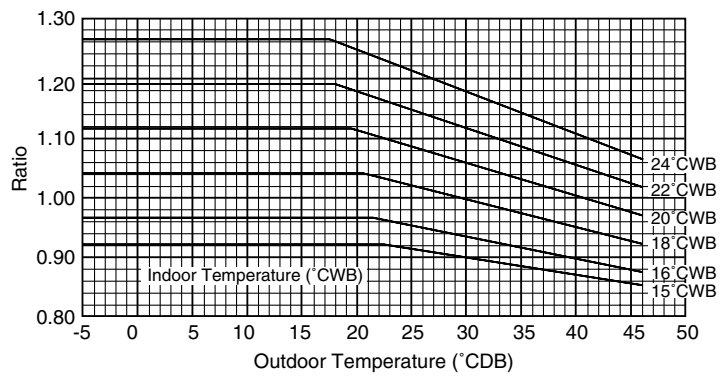

The ratio of cooling power input

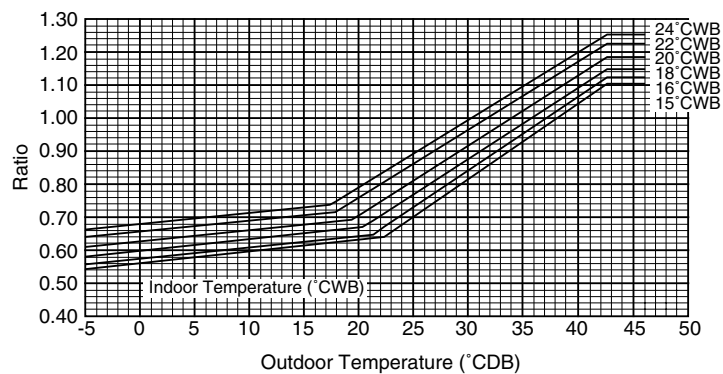

PURY-200/250YEMC-A

The ratio of cooling capacity

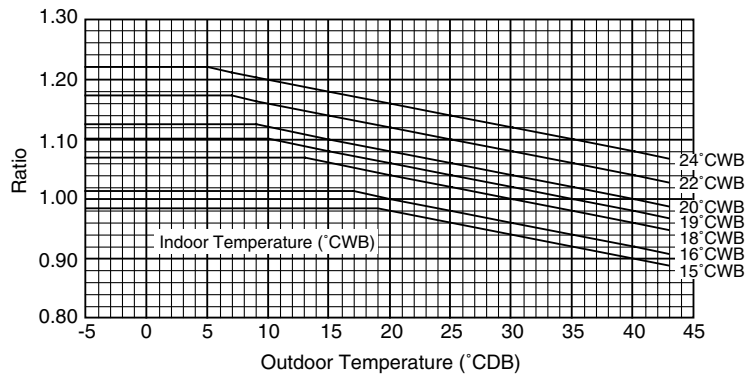

The ratio of cooling power input

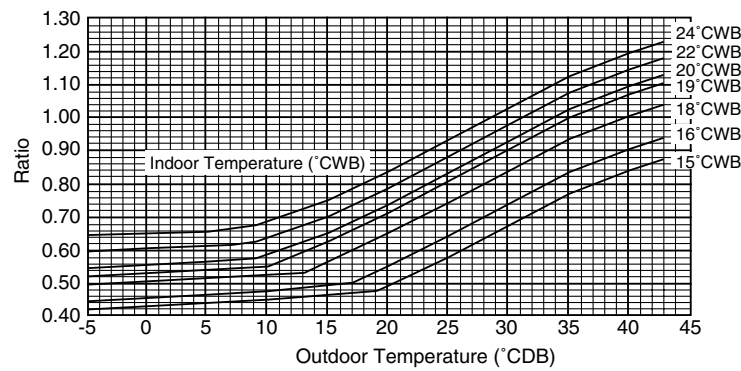

(2) Heating

Standard specifications

		PUHY-200YEMC-A	PUHY-250YEMC-A	PUHY-315YEMC-A	PUHY-400YEMC-A	PUHY-500YEMC-A	PURY-200YEMC-A	PURY-250YEMC-A
Capacity	kW	25.0	31.5	39.1	50.0	63.0	25.0	31.5
Input	kW	6.66	8.77	10.91	14.31	17.92	7.66	9.74
Source	V	380/400/415						
Current	A	11.2/10.6/10.2	14.8/14.0/13.5	18.2/17.3/16.6	24.1/22.9/22.1	30.2/28.7/27.7	12.9/12.2/11.8	16.4/15.6/15.0

● Calculation

Capacity' = Capacity × Ratio

Input' = Input × Ratio

$$\text{Current}' = \frac{\text{Input}' \times 1,000}{\sqrt{3} \times \text{Source} \times 0.91}$$

* Capacity' }
 Input' } After correction
 Current' }

PUHY-200/250/315YEMC-A

The ratio of heating capacity

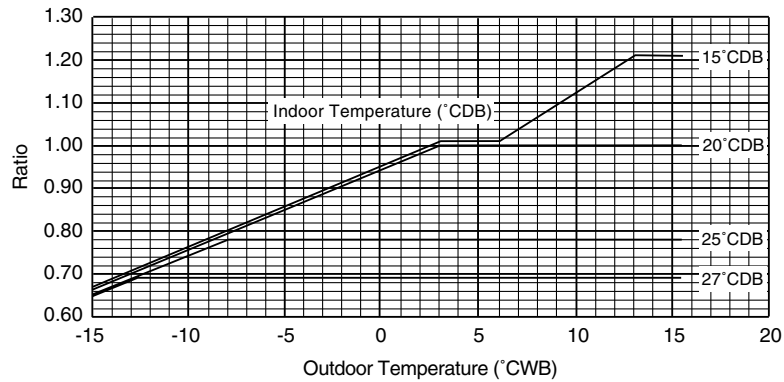

The ratio of heating power input

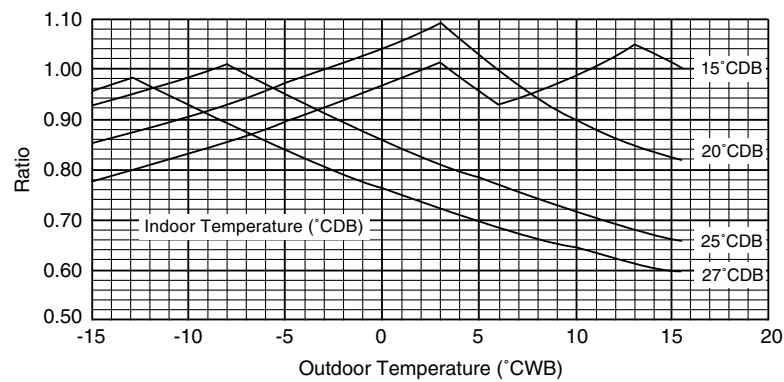

PUHY-400/500YEMC-A

The ratio of heating capacity

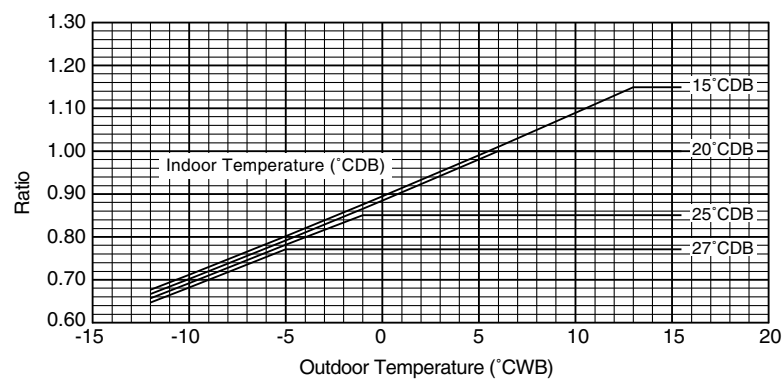

The ratio of heating power input

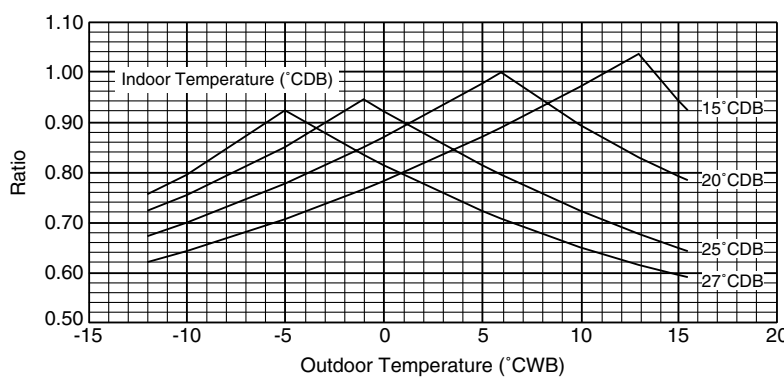

PURY-200/250YEMC-A

The ratio of heating capacity

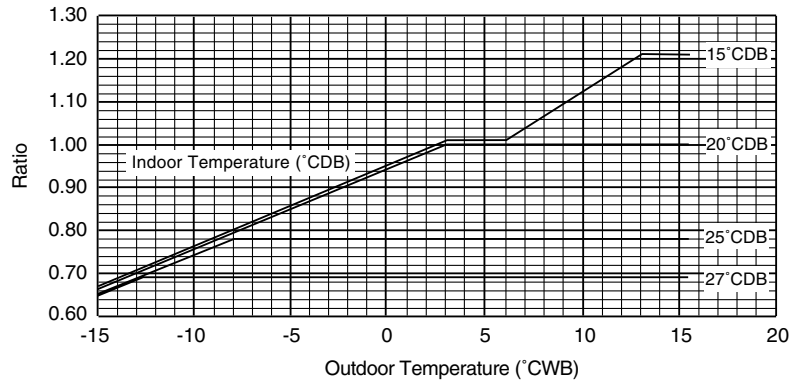

The ratio of heating power input

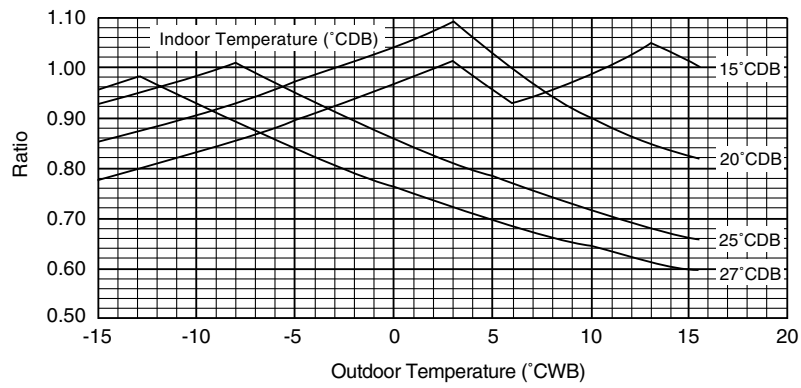

12.4 Correction by Refrigerant Piping Length

12.4.1 R410A refrigerant unit

To obtain a decrease in cooling/heating capacity due to refrigerant piping extension, multiply by the capacity correction factor based on the refrigerant piping equivalent length in the table below.

(1) Cooling capacity correction

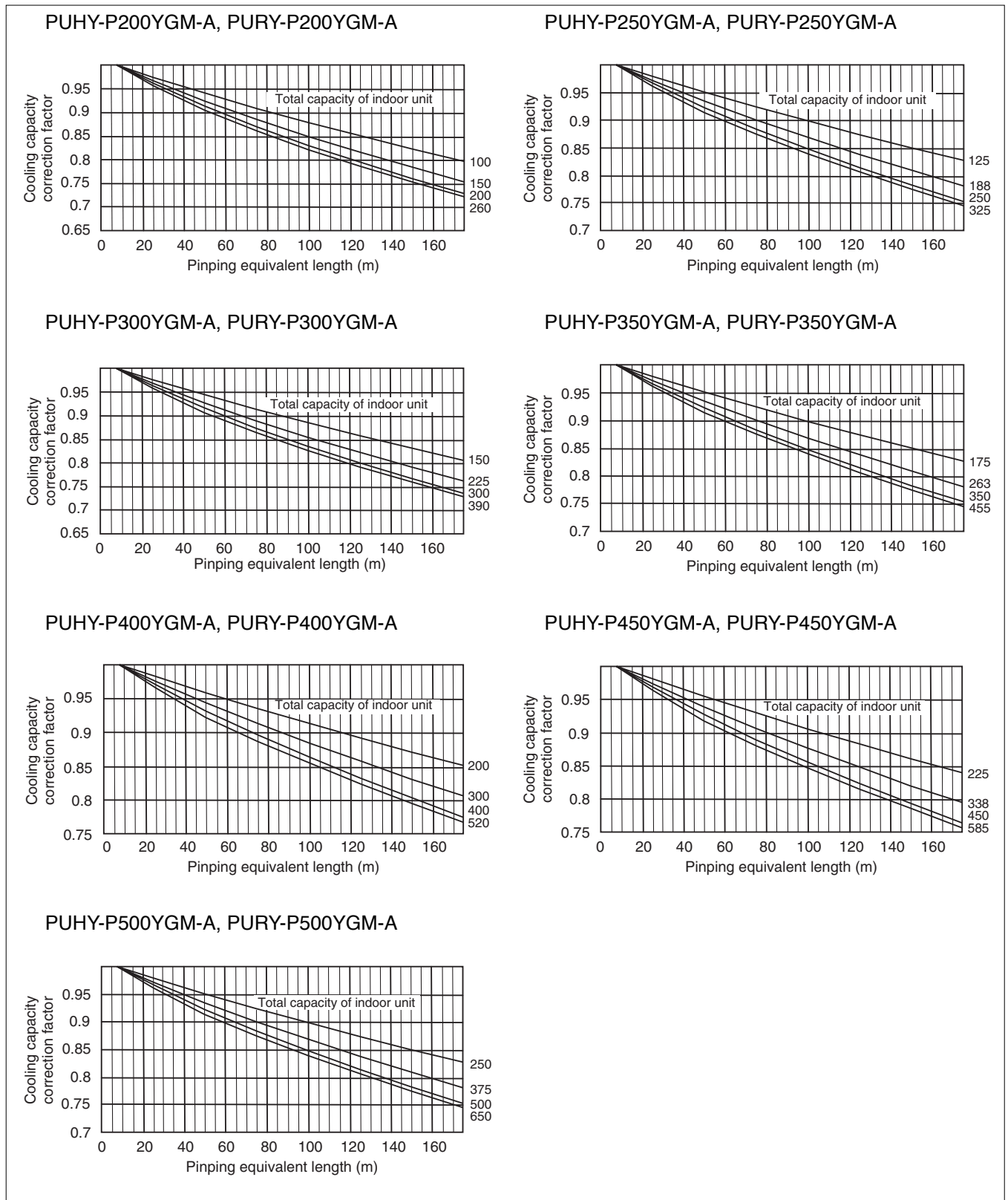

(2) Heating capacity correction

PUHY-P200YGM-A, PUHY-P250YGM-A

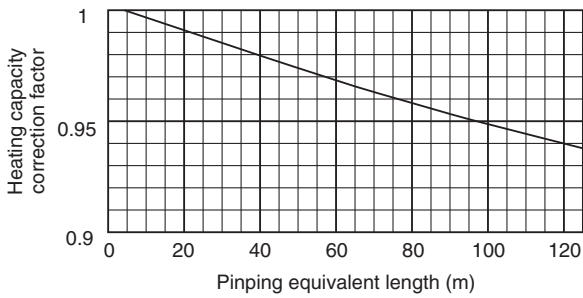

PUHY-P300YGM-A, PUHY-P350YGM-A
PUHY-P400YGM-A, PUHY-P450YGM-A
PUHY-P500YGM-A

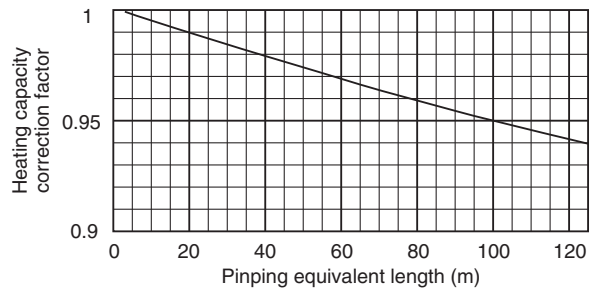

PURY-P200YGM-A, PURY-P250YGM-A
PURY-P300YGM-A

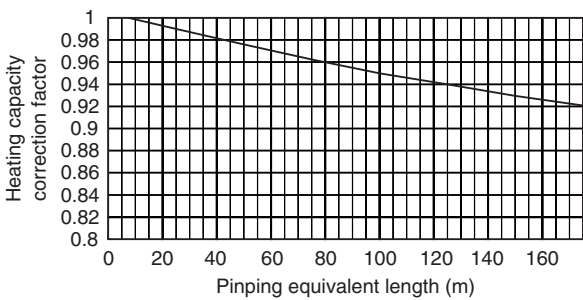

PURY-P350YGM-A, PURY-P400YGM-A

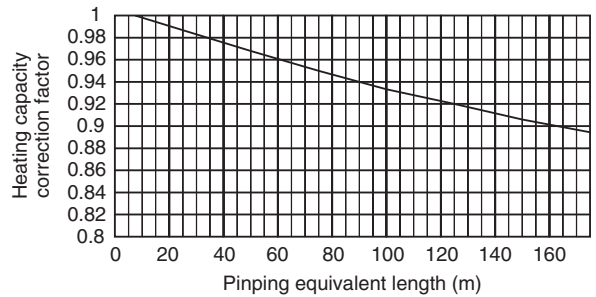

PURY-P450YGM-A, PURY-P500YGM-A

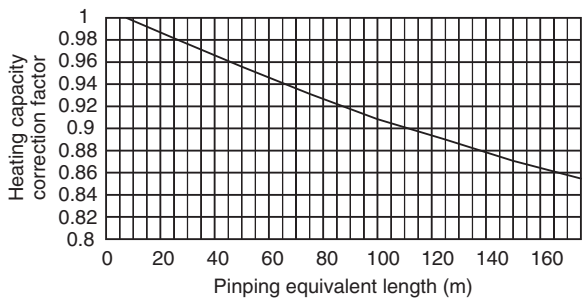

● **How to obtain piping equivalent length**

- 1) PUHY-P200YGM-A, PURY-P200YGM-A

Equivalent length = (Actual piping length to the farthest indoor unit) + (0.35 × number of bent on the piping) m

- 2) PUHY-P250/P300YGM-A, PURY-P250/P300YGM-A

Equivalent length = (Actual piping length to the farthest indoor unit) + (0.42 × number of bent on the piping) m

- 3) PUHY-P350YGM-A, PURY-P350YGM-A

Equivalent length = (Actual piping length to the farthest indoor unit) + (0.47 × number of bent on the piping) m

- 4) PUHY-P400/P450/P500YGM-A, PURY-P400/P450/P500YGM-A

Equivalent length = (Actual piping length to the farthest indoor unit) + (0.50 × number of bent on the piping) m

12.4.2 R22 refrigerant unit

(1) Cooling capacity correction

PUHY-200YEM-A/200YEMC-A

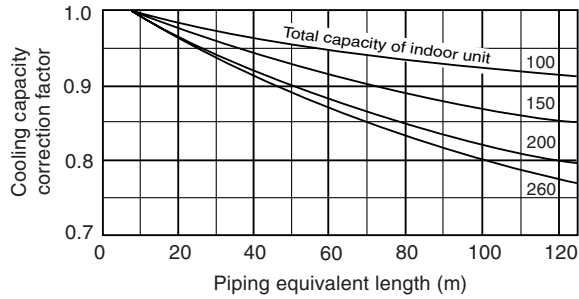

PUHY-250YEM-A/250YEMC-A

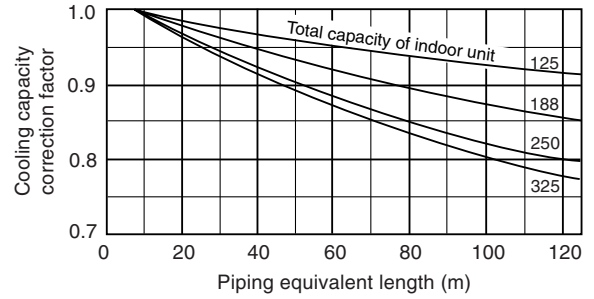

PUHY-315YEM-A/315YEMC-A

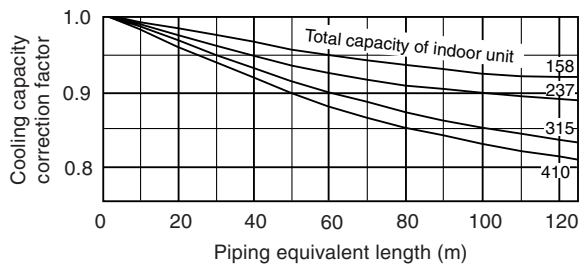

PUHY-400YEM-A/400YEMC-A

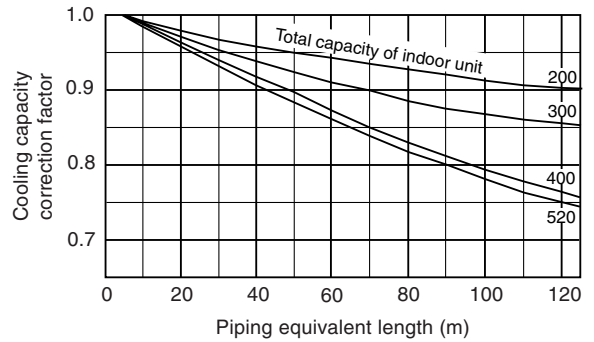

PUHY-500YEM-A/500YEMC-A

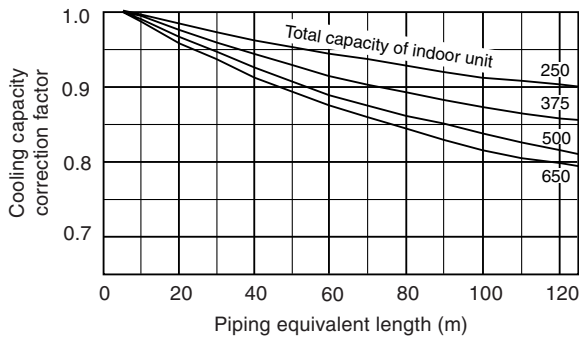

PURY-200YEMC-A

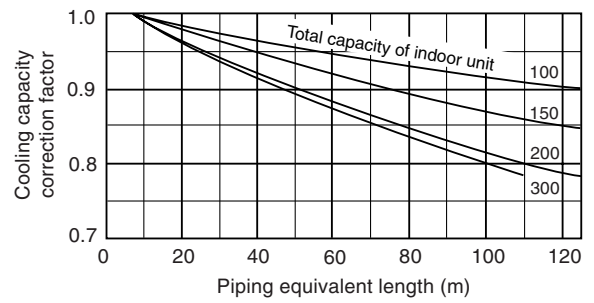

PURY-250YEMC-A

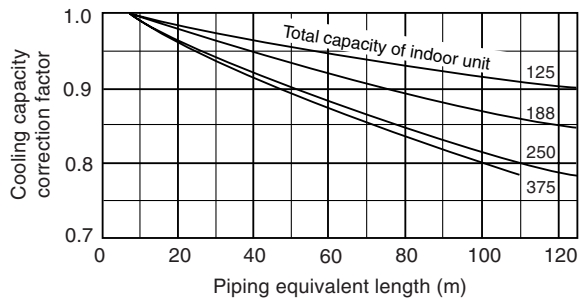

(2) Heating capacity correction

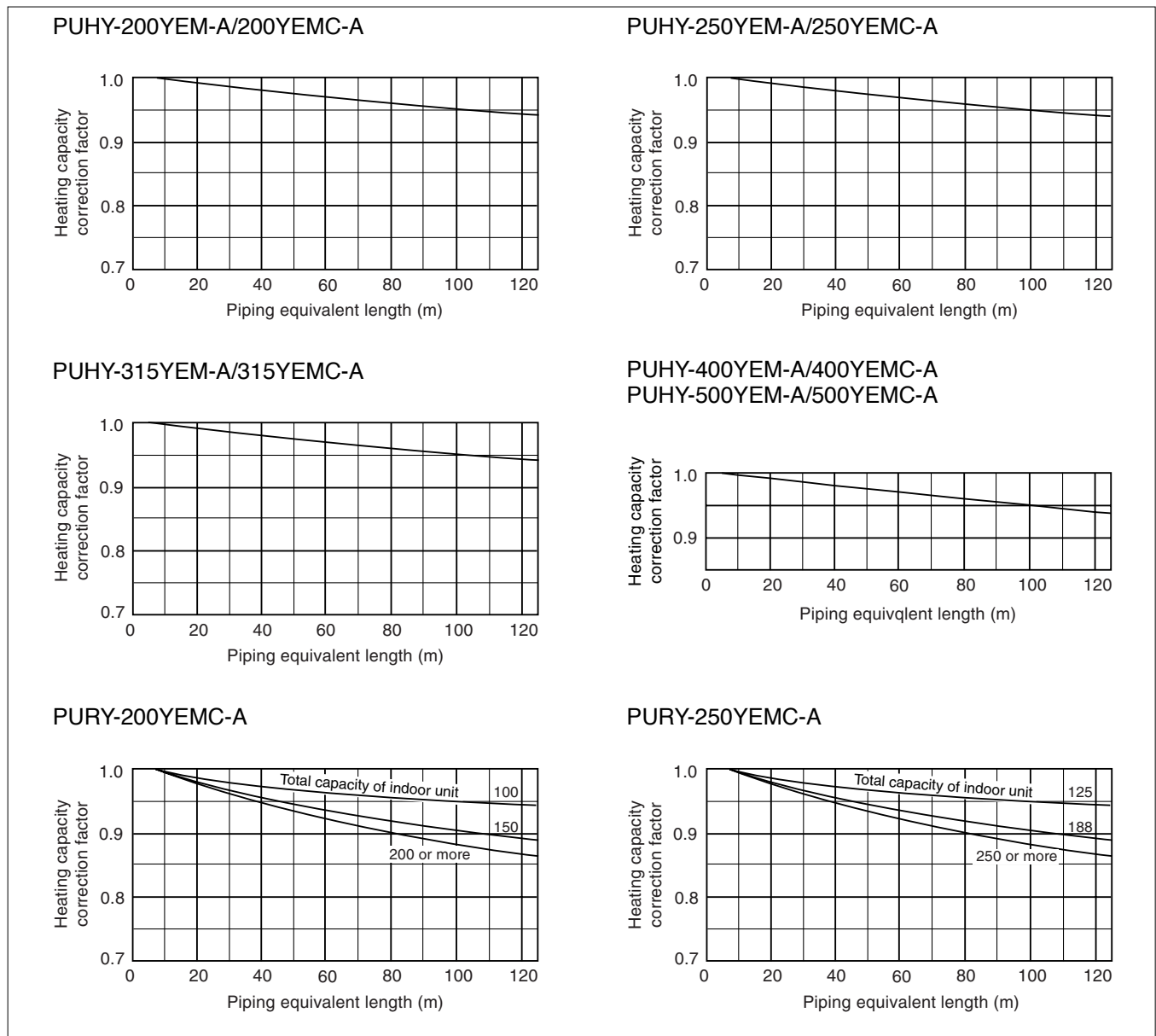

● **How to obtain piping equivalent length**

1) PUHY-200YEM-A/200YEMC-A

Equivalent length = (Actual piping length to the farthest indoor unit) + (0.47 × number of bent on the piping) m

2) PUHY-250YEM-A/250YEMC-A

Equivalent length = (Actual piping length to the farthest indoor unit) + (0.50 × number of bent on the piping) m

3) PUHY-315YEM-A/315YEMC-A/400YEM-A/400YEMC-A

Equivalent length = (Actual piping length to the farthest indoor unit) + (0.70 × number of bent on the piping) m

4) PUHY-500YEM-A/500YEMC-A

Equivalent length = (Actual piping length to the farthest indoor unit) + (0.80 × number of bent on the piping) m

13. Filter Characteristics

13.1 Filter Types

Measurement method Tested dust		Applicable model	AFI Gravitational method	ASHRAE Colorimetric method	Counting method (DOP method)		Application
			Compound dust	Atmospheric dust	JIS 14 types DOP 0.8 μm	DOP 0.3 μm	
Filter type							
Pre-filter	NP/400 (EU3)	GUF-50RDH3 GUF-100RDH3 GUF-50RD3 GUF-100RD3	82%	8% - 12%	5% - 9%	2% - 5%	Protection of heat exchange element
High efficiency filter	Model PZ-50RFM PZ-100RFM (EU7)(Optional parts)		99%	65%	60%	25%	Assurance of sanitary environment

13.2 High-Efficiency Filter (Optional Parts)

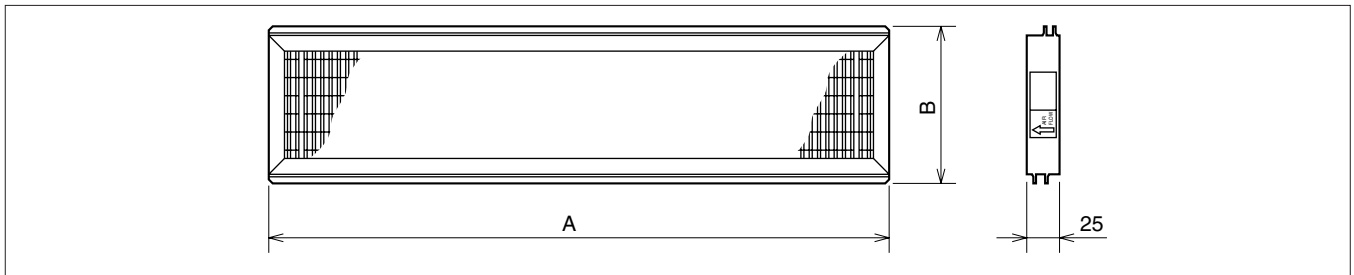

Model	Dimension (mm)		Number of filters per set	Applicable model *
	A	B		
PZ-50RFM	466	174	2	GUF-50RDH3/50RD3
PZ-100RFM	561	236	2	GUF-100RDH3/100RD3

Note: This is one set per main body.

13.3 Pressure Loss

Pressure loss characteristics

PZ-50RFM

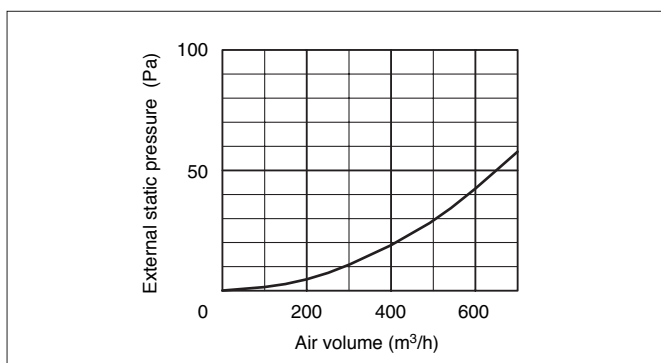

PZ-100RFM

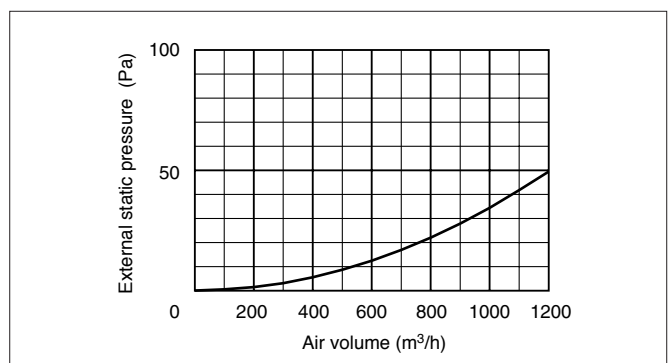

CHAPTER 1 ● Product Section

The ability of the filters used within the OA processing units are shown below, expressed in terms of collection ratio (%).

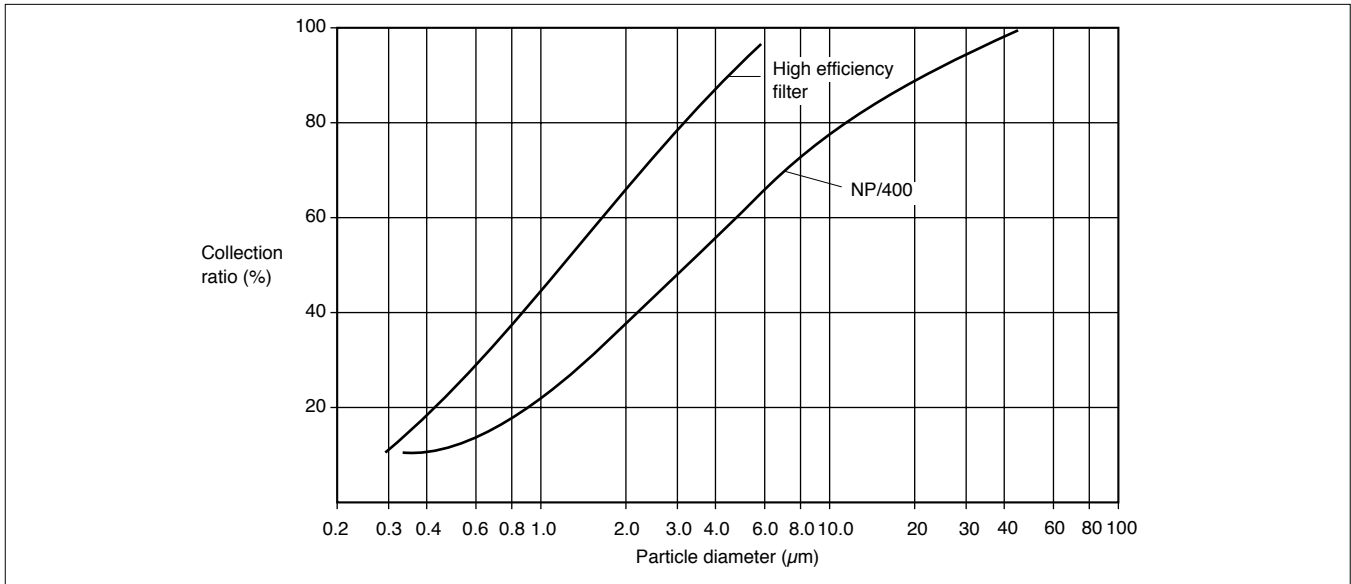

Dust removal retention characteristics (NP/400 + High efficiency filter)

GUF-50RDH3/50RD3

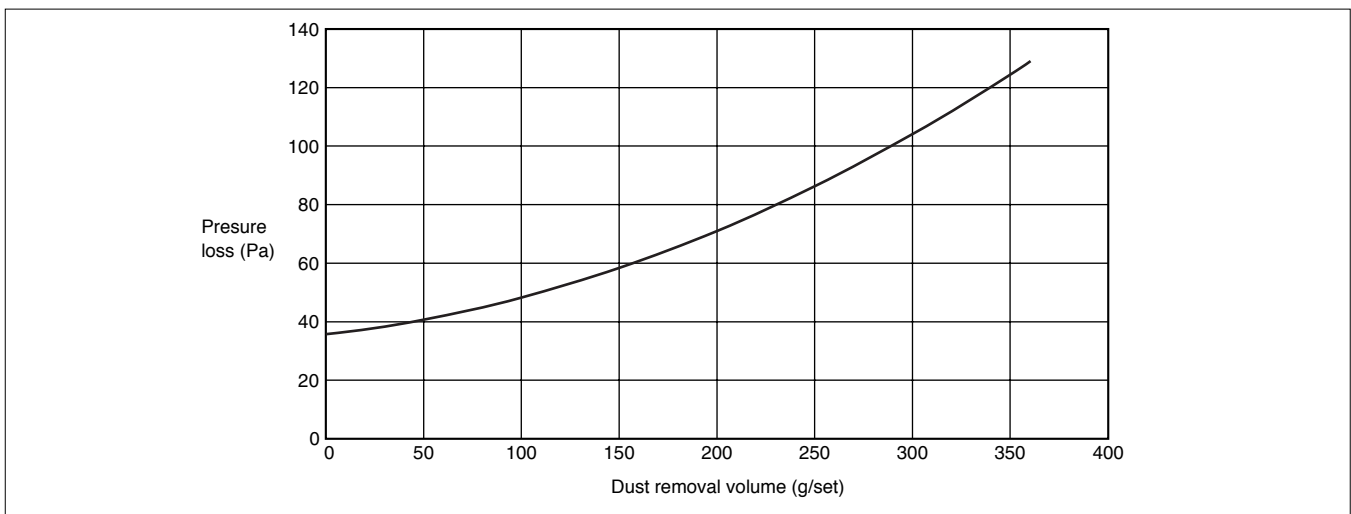

GUF-100RDH3/100RD3

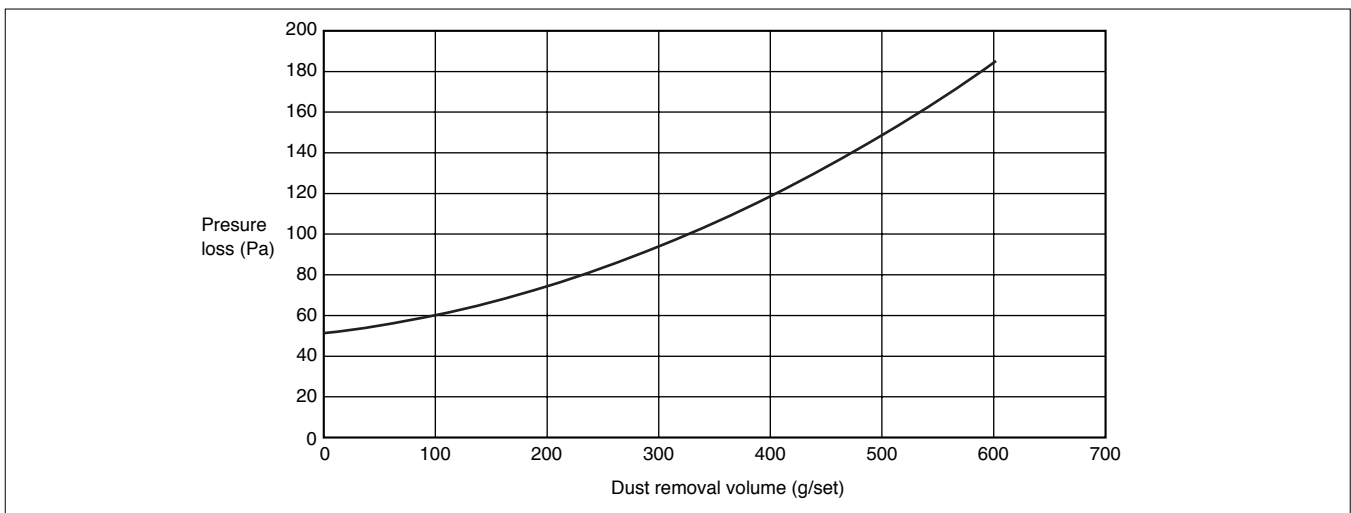

14. Noise Characteristics

14.1 GUF-50RDH3/50RD3

Directly below (Measurement point A)

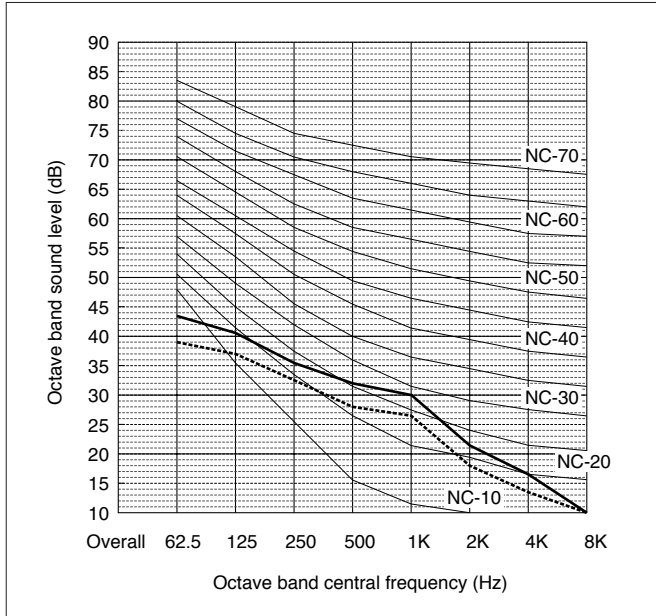

Outlet (Measurement point B)

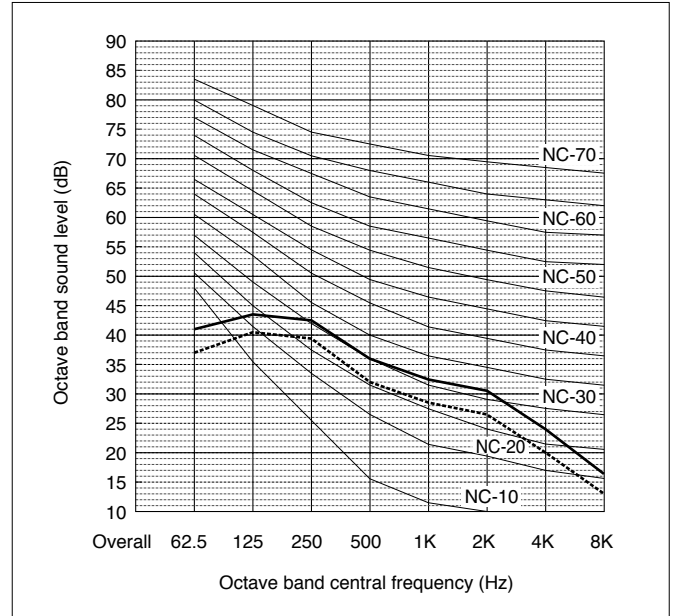

14.2 GUF-100RDH3/100RD3

Directly below (Measurement point A)

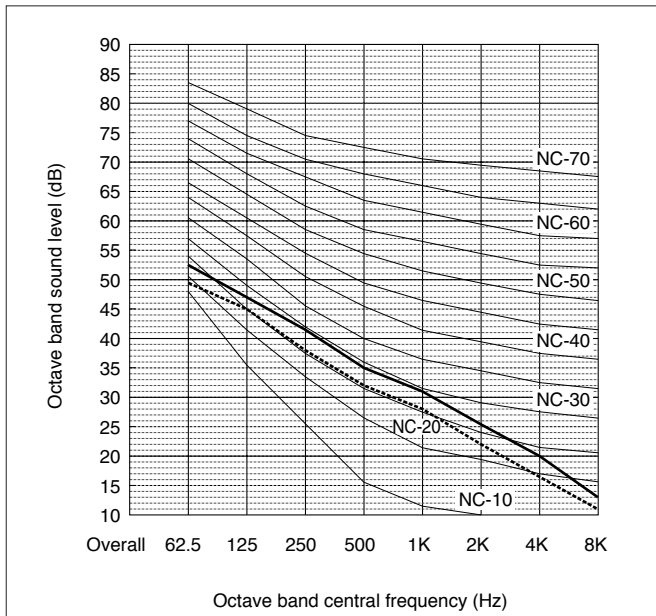

Outlet (Measurement point B)

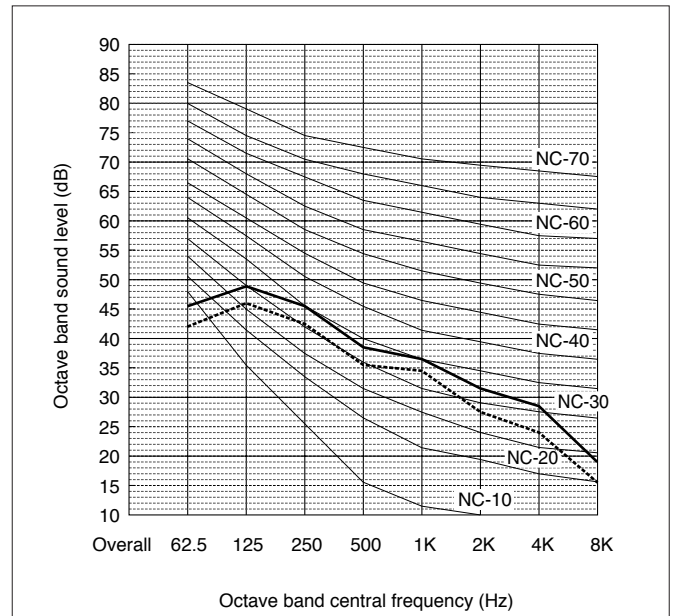

● Measurement Condition

Measurement site:

Mitsubishi Electric Co.,
Nakatsugawa Works
Anechoic chamber

<Ceiling recessed type>

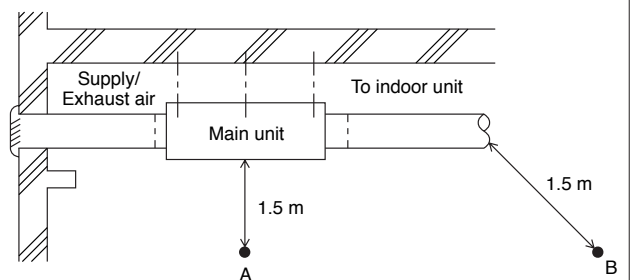

15. Reference Documents

15.1 The Result of No Bacterial Cross Contamination for the Lossnay Core and Determining Resistance of the Lossnay Core to Molds

Test report

This document reports the result that there is no bacterial cross contamination for the Lossnay Core.

(1) Object

The object of this test is to verify that there is no bacterial cross contamination from the outlet air to the inlet air of the Lossnay Core in the heat exchange process.

(2) Client

mitsubishi electric co. nakatsugawa works.

(3) Test period

April 26, 1999 - May 28, 1999

(4) Test method

The configuration of the test equipment is shown below. The test bacteria suspension is sprayed in the outlet duct at a pressure of 1.5 kg/cm² with a sprayer whose dominant particle size is 0.3 - 0.5 μm. The air sampling tubes are installed at the each center of the locations of A, B, C, D, in the Lossnay Core inlet/outlet ducts so that their openings are directly against the air flow, and then connected to the impinger outside the duct. The impinger is filled with 100 mL physiological salt solution. The airborne bacteria in the duct air are sampled at the rate of 10L air/minute for three minutes.

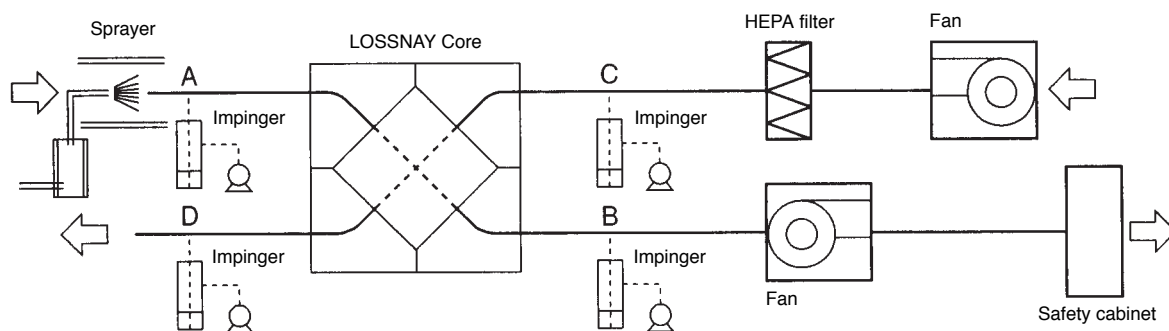

(5) Test bacteria

The bacteria used in this test are as followed;

Bacillus subtilis IFO 3134

Pseudomonas diminuta IFO14213 (JIS K 3835 Method of testing bacteria trapping capability of precision filtration film elements and modules; applicable to precision filtration film, etc. applied to air or liquid)

(6) Test result

The result of the test with *Bacillus subtilis* is shown in Table 1.

The result of the test with *Pseudomonas diminuta* is shown in Table 2.

Table 1 Test result with bacillus subtilis (CFU/30L air)

No.	A	B	C	D
1	5.4×10^4	5.6×10^4	$<10^3$	$<10^3$
2	8.5×10^3	7.5×10^3	$<10^3$	$<10^3$
3	7.5×10^3	$<10^3$	$<10^3$	$<10^3$
4	1.2×10^4	1.2×10^4	$<10^3$	$<10^3$
5	1.8×10^4	1.5×10^3	$<10^3$	$<10^3$
Average	2.0×10^4	1.5×10^4	$<10^3$	$<10^3$

Table 2 Test result with pseudomonas diminuta (CFU/30L air)

No.	A	B	C	D
1	3.6×10^5	2.9×10^5	$<10^3$	$<10^3$
2	2.5×10^5	1.2×10^5	$<10^3$	$<10^3$
3	2.4×10^5	7.2×10^5	$<10^3$	$<10^3$
4	3.4×10^5	8.4×10^5	$<10^3$	$<10^3$
5	1.7×10^5	3.8×10^5	$<10^3$	$<10^3$
Average	2.7×10^5	4.7×10^5	$<10^3$	$<10^3$

(7) Considerations

Bacillus subtilis is commonly detected in the air and resistant to dry. Pseudomonas diminuta is susceptible to dry and only a few exists in the air. However, it is used in the performance verification of the bacteria trapping filter since the particle size is small (Cell diameter; $0.5 \mu\text{m}$: Cell length 1.0 to $4.0 \mu\text{m}$).

Both Bacillus subtilis and Pseudomonas diminuta are detected at the location A and B in the outlet side duct where they are sprayed, but neither them are detected at location C (in the air filtered by the HEPA filter) and the location D (in the air crossed in the Lossnay Core) on the inlet side.

Since the number of bacteria in the location A is substantially equal to one in the location B, it is estimated that only a few bacteria are attached to the Lossnay Core on the outlet side. Also, no test bacteria is detected at the location D where the air is crossed in the Lossnay Core. Therefore, it can be concluded that the bacteria attached to the outlet side will not pass through the inlet side even after the heat is exchanged.

Shunji Okada
 Manager, Biological Section
 Kitasato Research Center of Environmental Sciences

Test report

This document reports the result of determining resistance of the Lossnay Core to molds.

(1) Object

The object of this test is to determining resistance of the Lossnay Core to molds.

(2) Client

Mitsubishi Electric Co. Nakatugawa Works

(3) Test sample

Lossnay Core (paper separator)

(4) Test period

April 26, 1999 - May 28, 1999

(5) Test method

The testing method is in accordance with "5. General Industrial Products," "Test Method of Resistance to Mold," JIS Z 2911.

The Lossnay Core is cut into 5 × 5 cm square. pole. The test mold spore solution is sprayed on one side of the core and, after covering one side of the crossing core with sponge sheet, the core is left in the chamber with 27°C, (relative humidity 95%) for four weeks.

(6) Test mold

The molds used in this test are as follows;

Aspergillus niger ATCC 6275

Penicillium citrinum ATCC 9849

Rhizopus oryzae IFO 31005

Cladosporium cladosporioides IFO 6348

Chaetomium globosum ATCC 6205

(7) Determination criterion

Observed growth on specimens	Degree
None growth	3
Light growth (less than 1/3 area)	2
Heavy growth (more than 1/3 area)	1

(8) Test result

No hypha was grown in the place where the test mold spore solution was applied. So the degree of resistance to mold was judged to be 3.

Shunji Okada
Manager, Biological Section
Kitasato research Center of Enviromental Seiences

15.2 Flame-proofing Properties of Lossnay Core

The Lossnay Core satisfied all requirements of Paragraph 4-3 of the Fire Prevention Law Enforcement Rules. Details of the tests carried out are as seen below.

Notation format 2 - (3)

Notification of flame-proofing property test (For flame-proof materials and related items)

Flame-proofing committee test No., B-80028
April 17, 1980

Messrs.: Mitsubishi Electrical Corporation

Japan Flame-proofing committee

The results of the test, requested on April 8, 1980, are as follows.

Whereas

Part name	Air filter Total heat exchanger	Material, Mixture ratio, Organization, Fan number, Density, Weight (g/m²)	Specially treated paper: (Partition (white): Thickness 0.2 mm) (Filler block (blue): Thickness 0.2 mm) Adhesive agent: Vinyl acetate (Specific gravity ratio 2.6 %) 600 g/m ²
Product name (Brand)	Lossnay (ventilation fan) B		

Test No.	Test item	Residual flame (sec.)	Residual dust (sec.)	Carbonized area (cm ²)	Test item	Carbonization length (cm)	No. of flame contact times (times)
					Test No.		
2-min. heating	1 (Vertical)	0.	4.1	35.4	1		
	2 (Vertical)	0.	7.7	38.2	2		
	3 (Horizontal)	0.	1.4	35.9	3		
6-sec. heating after igniting	1 (Vertical)	0.	0.	26.3	4		
	2 (Horizontal)	0.	0.	20.3	5		

Evaluation	Passing
-------------------	---------

Remarks

Test method

Application of Paragraph 4-3 Standards of Fire Prevention Laws Enforcement Rules (Ministry of Home Affairs Ordinance No. 6, 1961)
(Thick cloth test)

Passing standards

Residual flame : 5 sec. or less
Residual dust : 20 sec. or less
Carburized area : 40 cm² or less
Washing test

CHAPTER 1 ● Product Section

The Lossnay Core was also tested at the Japan Construction General Laboratories according to the fire retardancy test methods of thin materials for construction as set forth by JIS A 1322. The material was evaluated as Class 2 flame retardant. Details of the tests carried out are shown below.

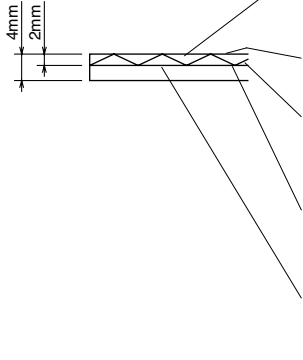
Flame-proofing property test report												
Messrs. Mitsubishi Electric Corp., Nakatsugawa Works				<table border="1"> <tr> <td>Acceptance No.</td> <td>VF-93-11-(2)</td> </tr> <tr> <td>Data of acceptance</td> <td>September 7, 1993</td> </tr> <tr> <td>Data of report</td> <td>October 12, 1993</td> </tr> </table> <p>Japan Construction General Laboratories 5-8-1 Fujishirodai, Suita City 565 Tel: 06-872-0391 Hiorshi Wakabayashi Dr. of Engineering, Director</p>			Acceptance No.	VF-93-11-(2)	Data of acceptance	September 7, 1993	Data of report	October 12, 1993
Acceptance No.	VF-93-11-(2)											
Data of acceptance	September 7, 1993											
Data of report	October 12, 1993											
Applicant	Company name		Mitsubishi Electric Corp., Nakatsugawa Works									
	Address		1-3 Komanba-cho, Nakatsugawa, Gifu									
Specimen and test body	Specimen type		Single-face laminated corrugated board	Product name	Lossnay Core (Total heat recovery unit)							
	Material structure and cross-sectional diagram, etc.		 <p>Single-face laminated corrugated board ... Thickness: 4 mm (Single-face corrugated board with 2 mm cell size laminated alternately at right angle) Partition (Liner paper) Flame-proof treated paper ... Thickness: 0.085 mm, Weight: 70 g/m² Adhesive agent ... Vinyl acetate resin ... Weight: 30 g/m² (Solid) Filler (Flute paper) ... Colored wood free paper ... Thickness: 0.093 mm, Weight: 79 g/m² Adhesive agent ... Vinyl acetate resin ... Weight: 30 g/m² (Solid) Partition (Liner paper) Flame-proof treated paper ... Thickness: 0.085 mm, Weight: 70 g/m²</p>									
	Test body size and thickness (mm)		300 (Long side) × 200 (Short side) × 4 (Thickness)									
	Test body direction		The longer side is the vertical side.									
Testing method	Testing standards		Pre-treatment of test body	Heating time	Heating surface class and direction							
	JIS A 1322 (45° Meckelian burner method)		Method A (drying method)	3 min.	The direction of which the corrugated board fold was vertical was set as the front of the heating surface.							
Test results	Test date		October 5, 1993									
	Test position			Residual frame (sec.)	Residual dust (sec.)	Carbonized length (Vertical x Horizontal) (cm)	Discoloration length (Vertical x Horizontal) (cm)					
	Class	Direction	No.									
	Front	Vertical	1	0	0	8.2 × 4.7	18.7 × 7.3					
2			0	0	8.4 × 4.9	24.3 × 7.8						
3			0	0	7.4 × 5.0	22.0 × 8.4						
Remarks *1												
Evaluation	The specimen conforms to Class 2 flame-proofing (heating time: 3 min.) according to the "Fire retardancy test methods of thin materials for construction" as set forth by JIS A 1322.											
Persons in charge of testing			Material Testing Laboratory Laboratory chief: Hiroshi Tamura, Technicians: Shigeru Fujikawa, Nobuaki Oohiro, Tetsuya Ogawa									

Note: Immediately after starting heating, the flame was ignited simultaneously with the generation of smoke. Penetration was observed approx. 2 min. 30 sec., after heating was started. There were no further changes.

15.3 Lossnay Core's Soundproofing Properties Test

As the Lossnay Core is made of paper and the permeable holes are extremely small, the Element has outstanding soundproofing properties and is appropriate for ventilation in soundproof rooms.

For example, the exposed ceiling-type LGH-50E has soundproofing characteristics of 33.9 dB with a center frequency of 400 Hz. This means that a sound source of 96.9 dB can be shielded to 63 dB.

Soundproofing effect test results		No. 122-1							
For Mitsubishi Electric Corporation Nakatsugawa Works		Test number	IVA-78-122						
The results of the tests are as noted below. General Building Research Corporation General Manager, S. Okushima		Acceptance data	: February 22, 1979						
		Report	: May 24, 1979						
		General Building Research Corporation Fujishirodai 5-125, Suita-shi, Osaka-Fu, Japan Person in charge of testing: Takeshi Tokura							
Certificate number	IVA-78-122	Testing facility	General Building Research Corporation						
Specimen	Product name	LGH-50E	Client						
	Item name	Heat exchange-type ventilator							
	Application	Ventilation							
	Date of manufacture	October 1978							
	Place of assembly	General Building Research Corporation							
	Dimensions	W 1250 × H 310 × D 1589							
	Area concentration	---							
	Remarks	An existing hole (4000 mm × 3000 mm) was covered with a hollow concrete block with double-faced mortar (thickness 20 mm each), with a wood frame with inner dimension of 580 mm × 190 mm × 230 mm being installed. The supply/exhaust box and duct was mounted in this, and the main unit and weather cover was mounted.							
	Peripheral sections	Oil clay was filled around the sound source							
	Specimen configuration (dimensions mm) Refer to appendix 1, 2 for details. S: 1/20			Sound transmission loss test					
<p>Steel plate thickness: 0.8 Internal flange hole with fixing screw Weather cover Steel plate thickness: 0.6 Flange steel plate thickness: 1.6 Duct steel plate thickness: 1.6 Urethane foam thickness: 15 0.072 m² Feed/exhaust box Steel plate thickness: 1.0 Wood frame thickness: 20 Mortar</p>		Centre frequency	125 Hz			500 Hz	2,000 Hz		
		Sound source side	Measurement point			1	101.5	96.5	98.5
						2	99.0	—	—
						3	100.0	97.5	98.5
						4	102.0	—	—
						5	101.5	96.5	98.5
		Average level					100.9	96.9	98.5
		Reception side	Measurement point			1	81.5	63.5	53.0
						2	79.5	—	—
				3	79.5	63.0	43.0		
4	82.5			—	—				
5	81.5			62.5	43.5				
Average level			81.1	63.0	43.2				
Average sound pressure level difference (dB)			19.8	33.9	55.3				
Sound absorbed by reverberation chamber on reception side (m²)			2.79	3.90	7.22				
Sound transmission loss (dB)			5.8	18.4	37.1				
		Refer to page 39 for details of test results							
Remarks Urethane foam (15 mm thick) was stuck onto the inside of the duct and feed/exhaust box.		Remarks The soundproofed area of the specimen is small in this test, and as the transmission of sound through the surrounding concrete block wall cannot be ignored, the concrete block wall was measured after the main test, and the main test measurement results were corrected.							
		Persons in charge of testing: Mitsuo Morimoto, Toshifumi Murakami							

15.4 Result of Microbial Test of Permeable Film Element

Microbial Test Report of Permeable Film Element

Kitasato Research Center of Environmental Science: Report No. 7858

March 3rd 1998

Kitasato Reseach Center of Environmental Science

The chairman: Ichiro Yamamoto

Microbial Test Report of Permeable Film Element

(1) Purpose of test

This test was conducted for the purpose of confirming whether or not microorganisms (*Legionella*) present in humidified water are released into humidified air after passing through an original permeable film humidifier element manufactured by Mitsubishi Electric Corporation.

(2) Party requesting test

Lossnay Manufacturing Department, Nakatsugawa Works,
Mitsubishi Electric Corporation.
Address: 1-3 Komanba-cho, Nakatsugawa City, Gifu Prefecture

(3) Test apparatus

Blower: Straight centrifugal fan, Model BFS-40S

Humidifier-mounted ducts: Air sampling pipes (copper pipes) are attached to sites located approximately 20 cm in front of and behind the humidifier. The opening of the air intake pipe is positioned in the center of the ducts facing the flow of air, and connected to a sampler outside the ducts while gently bending along an L-shaped curve.

Apparatus operation: Dry air blown in with the sirocco fan passes through the humidifier element and circulates to the air inflow port of the sirocco fan with a bellows duct having a diameter of 200 mm.

Air samplers: Impingers are filled in advance with 100 ml aliquots of sterile physiological salt solution, after which one is connected upstream from the humidifier while another is connected downstream from the humidifier. Sampled air is then sprayed into the physiological saline to clean. The amount of air sampled into the impingers is set at 10 liters per minute. An under-sensor sampler consists of media placed on each level below the six levels of porous nozzles gradually decreasing in size, and blows air collected at the rate of 28.3 liters per minute onto the surface of agar media.

(4) Test organism

Legionella pneumophilla ATCC 33154

(5) Test method

1) Detection of test organism in humidified air

A suspension of test organisms at 1.4×10^7 CFU/ml is injected into the humidifier tank, after which the suspension is allowed to fill the element by natural inflow.

The blower is operated after which air is collected into the sampler placed in the humidifier ten minutes later. The amount of sampled air and the air conditions at that time are shown in Table 1.

Measurement of microbial count using the impinger method is performed by using physiological salt solution immediately after air sampling as the undiluted liquid, preparing a 10-fold serial dilution, inoculating 0.1 ml of that diluted liquid onto the surface of pour media B-CYEa agar media (Eiken Chemical) and incubating at 37°C for 4 days followed by counting the number of colonies formed. Only those colonies that form on B-CYEa agar media after re-inoculating onto B-CYEa agar media and blood agar media are counted as *Legionella*. With respect to the under-sensor sampler method, colonies that are formed using pour media WYOa agar media (Eiken Chemical) are re-inoculated onto B-CYEa agar media and blood agar media, and those colonies that formed only on the B-CYEa agar media are counted as *Legionella*.

Table 1 Air sampling conditions

Measurement	Impinger method		Slit sample method	
	Sampled air volume	Humidity of circulated air	Sampled air volume	Humidity of circulated air
1st	20 lit.	26.5%	28.3 lit.	35.6%
2nd	40 lit.	29.4%	141.5 lit.	****
3rd	100 lit.	52.8%	141.5 lit.	****
4th	100 lit.	****	141.5 lit.	****
5th	100 lit.	36.1%	141.5 lit.	93.4%

2) Detection of test organisms on the surface of the permeable film

20 ml of a suspension of test organisms (5.8×10^5 CFU/ml) are injected into one bag of the permeable film humidifier element after which organisms are sampled and detected from the surface of the element bag one hour later.

The sampling methods consist of: (1) sampling water droplets that formed on the surface of the front side of the element (side where the spacer frame is not attached) with a sterile syringe, (2) stamping the front surface and back surface (surface where the spacer frame is attached) of the element onto the surface of a medium, and (3) wiping both surfaces of the element (measuring 5×5 cm² each) with sterile solid gauze (Booth: Sawada Menko) and inoculating directly onto the surface of a medium.

Using pour media WYOa agar media (Eiken Chemical) for the medium, the formed colonies are re-inoculated onto B-CYEa agar media and blood agar media followed by only counting those colonies that formed on B-CYEa agar media as Legionella.

(6) Test period

January 12, 1998 - January 28, 1998

(7) Test results

1) Detection of airborne test organisms in humidified air

The detection status of test organisms in the impinger method and slit sampler method is shown in Table 2.

Although two types of sampling methods were used, test organisms were unable to be detected in circulating air in either of the methods.

Table 2 Detection of airborne test organisms in humidified air

Measurement	Impinger method (CFU/Sampled air volume)	Slit sampler method (CFU/Sampled air volume)
1st	<10 ² CFU / 20 lit.>	<10 ² CFU / 28.3 lit.>
2nd	<10 ² CFU / 40 lit.>	<10 ² CFU / 141.5 lit.>
3rd	<10 ² CFU / 100 lit.>	<10 ² CFU / 141.5 lit.>
4th	<10 ² CFU / 100 lit.>	<10 ² CFU / 141.5 lit.>
5th	<10 ² CFU / 100 lit.>	<10 ² CFU / 141.5 lit.>

2) Detection of test organisms on the surface of the permeable film element

The detection status of test organisms from the surface of the permeable film humidifier element is shown in Table 3.

(A) Test organisms were unable to be detected from water droplets that formed on the surface of the front side (side on which the spacer frame is not attached). Since water droplets did not form on the surface of the back side (surface in contact with the spacer frame), the test was unable to be performed.

(B) In the case of pressing the test surface of the element onto the surface of the medium, test organisms were not detected for either surface.

- (C) In the case of wiping both surfaces of the element with sterile solid gauze, test organisms were not detected on the surface of the front side (side in which the spacer frame is not attached). Seven colonies were detected from one of two locations on the surface of the back side (surface in contact with the spacer frame). Test organisms were unable to be detected at the other location.

Table 3

Sampled Method	Surface for sampling test organisms from permeable film element			
	Front surface (Where spacer frame is not attached)		Back surface (in contact with spacer frame)	
	Sampling site No.1	Sampling site No.2	Sampling site No.3	Sampling site No.4
Culturing of water droplets	Not detected	Not detected	No droplets	No droplets
Stamping method	Not detected	Not detected	Not detected	Not detected
Wiping method	Not detected	Not detected	Detected	Not detected

(8) Discussion

The test organism of *Legionella pneumophilla* was unable to be detected in humidified air of a humidifier using a permeable film humidifier element. Thus, a study was conducted by more directly injecting a suspension of the test organism inside the permeable film humidifier element to assess whether or not the test organisms permeate to the front side of the film element. As a result, although test organisms were unable to be detected in water droplet culturing and stamping methods, test organisms were detected from one sampling site on the back side in the wiping method. The number of detected test organisms were 7 CFU per unit area of 5 × 5 cm. Since about 5.8×10^2 CFU ought to be detected even if the amount of liquid that seeped from the element is assumed to be 1 μ l (organism suspension injected into the element: 5.8×10^5 CFU/ml), it was assumed that only an extremely small amount of liquid actually seeped out. When considering that this seepage only occurred at one location of the 4 sites that were wiped, and that the amount of test organisms that seeped from the element is extremely small, it is believed that the organisms were detected as a result of damaging the film surface during wiping.

Thus, it was concluded that *Legionella pneumophilla* does not seep through the permeable film humidifier element provided the surface of the element is not damaged by wiping or other form of abrasion.

Shunji Okuda, Test Director

CHAPTER 2
Air Conditioning System
Design Section

1. Guide to a Comfortable Air Conditioning System

Air conditioning is more than simply adjusting the temperature of the air. It is used for properly maintaining the conditions for the air in a given space including the temperature, CO and CO₂ levels, the density of contaminant properties (removing odors created by humans and other things), air flow and its distribution. Recently, more attention has been placed on what an air conditioning system can do in addition to controlling temperature to improve the environment in a given space. This has given rise to demands for improved comfort, operating control for individual rooms, low-energy consumption, low maintenance and more compactness. Ceiling installation of units for cooling a floor or a particular zone, and functions such as the introduction of outdoor air, exhaust air removal, dust removal, heat recovery from ventilated air, heat processing and humidifying have been developed in response to these demands. In addition, by combining the OA processing unit with fin coil units or packaged air conditioners, comprehensive air conditioning can be provided.

1.1 Elements of Air Conditioning to be Considered

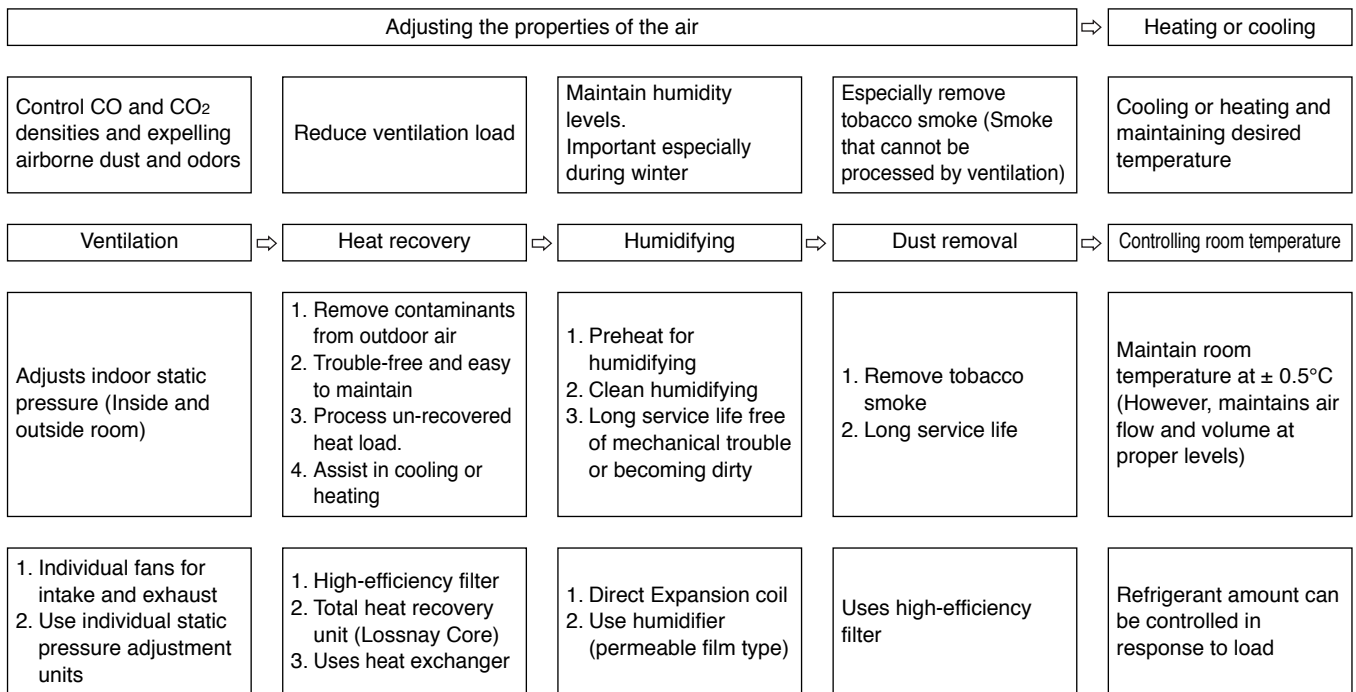

1.2 Example of a Comfortable Air Conditioning System

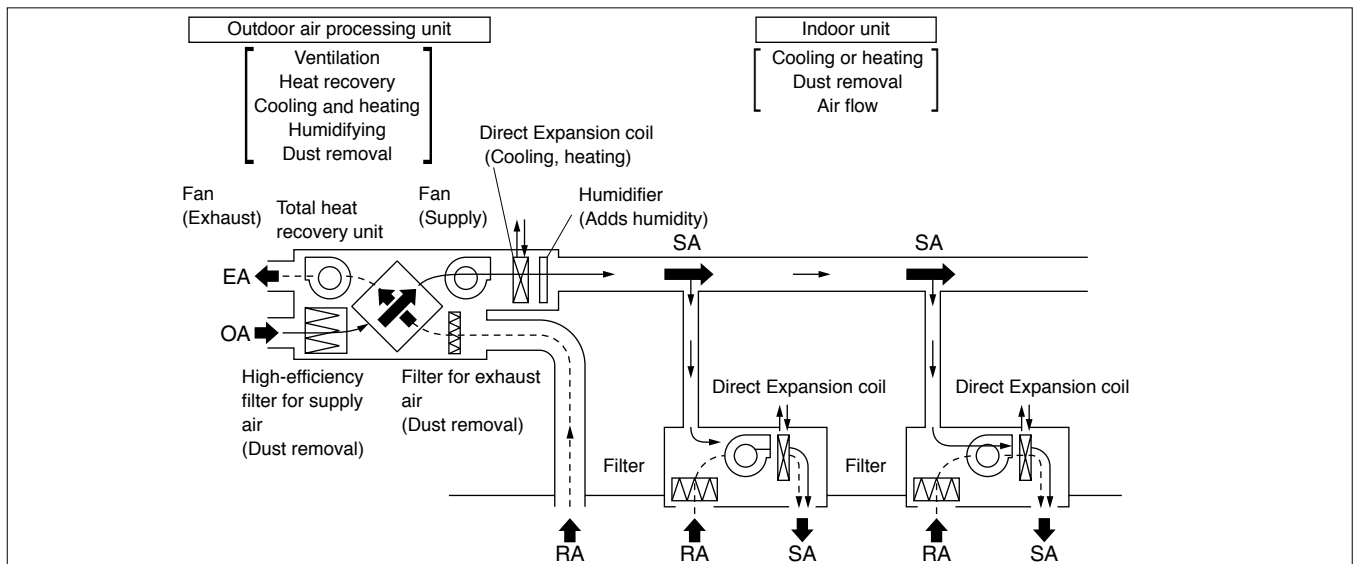

2. Features of the OA Processing Unit

(1) Provides individual control for comprehensive air conditioning

By combining the OA processing units in each air conditioning zone with heating and cooling units, comprehensive air conditioning can be provided with control each individual zone. This individual air conditioning can include the operation and stopping of cooling and heating, ventilation, humidifying, heat processing, dust removal and heat recovery.

(2) Provides more design freedom and effective utilization of space

The OA processing unit is recessed into the ceiling so there is no need for a separate equipment room and elaborate duct work. In addition, if a ceiling mounted cooling and heating unit is selected, absolutely no floor space is required for the system. This eases design constraints and helps to eliminate problems related to the installation of the equipment room and noise and vibration from the main duct work.

(3) High static pressure outside the unit allows for extended duct length

Since a high static pressure outside the unit can be attained, extending ducts, adding branches or positioning of outlets can be done with relative freedom. This is a system that allows for a wide range of flexibility during installation.

(4) Long-life high-efficiency filter can be added

The high-efficiency filter offers up to 65% filtration (colorimetric method) and can be used for up to 3,000 hours without maintenance. There is space provided inside the OA processing unit for installing this optional filter.

(5) Low-energy consumption

This system does not need the large conveyance power required by previous systems. In addition, individual control and heat recovery by the internal Lossnay Core help to reduce energy consumption needs. In addition, the cooling and heating unit is compact in size.

(6) Can calculate electrical costs for each zone

When used in conjunction with packaged air conditioning, electricity consumption for each zone can be calculated, making this system perfect for use in buildings with tenants.

(7) Low noise

The noise level is low enough for the system to be used in virtually any application, including offices.

(8) Permeable film humidifier used

This is a clean type of humidifier that is compatible with the electronic components found in today's "intelligent buildings".

Examples of air conditioning systems

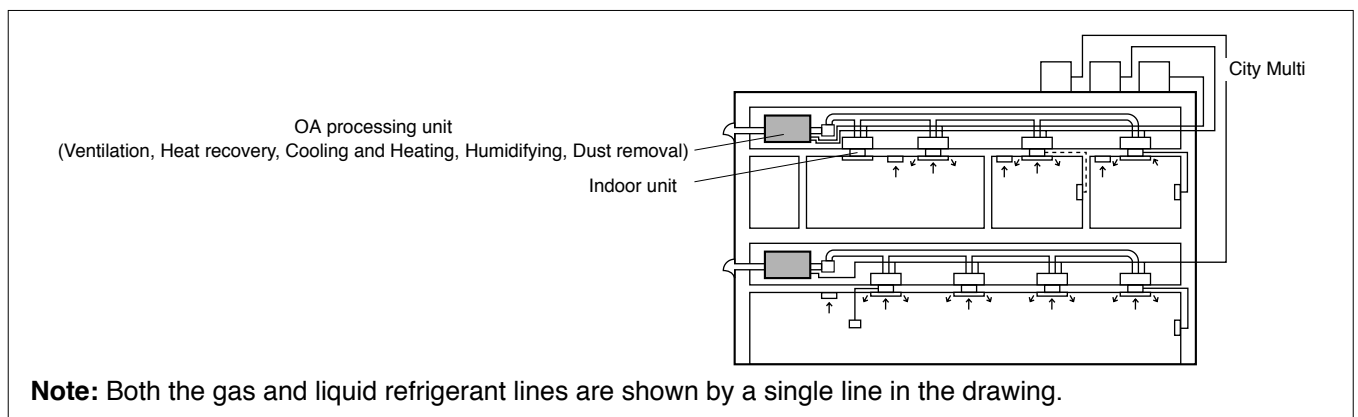

3. Air Conditioning and Ventilation

Fresh outdoor air must be introduced constantly at a set ratio in an air conditioning system. This fresh air is introduced to be mixed with the return air from the room, to adjust the temperature and humidity, supply oxygen, reduce body and other odors, remove tobacco smoke and to increase the cleanness of the air.

The standard ventilation (outdoor air intake) volume is determined according to the type of application, estimated number of persons in the room, room area, and relevant regulations. Systems which accurately facilitate these requirements are increasingly being required to be installed in buildings.

3.1 Necessity of Ventilation

The purpose of ventilation is basically to supply oxygen, clean the air and control the temperature and humidity. Cleaning the air includes the elimination of odors, gases, dust and bacteria. Ventilation fills fundamental needs such as providing personal comfort and ensuring the necessary environment for the animals, plants and equipment in the area.

3.1.1 Effect of air contamination on human bodies

Effect of oxygen (O₂) concentration

Concentration (%)	Standards and effect of concentration changes
Approx. 21	Standard atmosphere.
20.5	Ventilation air volume standard will be a guideline where concentration does not decrease more than 0.5% from normal value. (From Japanese building code)
20 - 19	An oxygen deficiency of this amount does not directly endanger life in a normal air pressure, but if there is a combustion device in the area, the generation of CO will increase rapidly due to incomplete combustion.
18	Japanese Labor Safety and Sanitation Law standards. (Hypoxia prevention regulations.)
16	Normal concentration in exhaled air.
16 - 12	Increase in pulse and breathing resulting in dizziness and headaches.
15	Flame in combustion devices will extinguish.
12	Threat to life in short term.
7	Fatal

Effect of carbon monoxide (CO)

10,000 ppm = 1%

Concentration (ppm)	Effect of concentration changes	
0.01 - 0.2	Standard atmosphere.	
5	Considered to be the long-term tolerable value.	Apprpx. 5 ppm is an annual average value in city areas. This value may exceed 100 ppm near roads, in tunnels and parking areas.
10	From Japanese building code, Building Management Law standards. Environmental standard 24-hour average.	
20	Considered to be the short-term tolerable value. Environmental standard 8-hour average.	
50	Tolerable concentration for labor environment. (Japan Industrial Sanitation Association)	
100	No effect for 3 hours. Effect noticed after 6 hours. Headache, illness after 9 hours; harmful for long-term but not fatal.	
200	Light headache in the forehead in 2 to 3 hours.	
400	Headache in the forehead, nausea in 1 to 2 hours; headache in the back of head in 2.5 to 3 hours.	
800	Headache, dizziness, nausea, convulsions in 45 minutes. Comatose in 2 hours.	
1,600	Headache, dizziness in 20 minutes. Death in 2 hours.	
3,200	Headache, dizziness in 5 to 10 minutes. Death in 30 minutes.	
6,400	Death in 10 to 15 minutes.	
12,800	Death in 1 to 3 minutes.	
Several 10,000 ppm (Several %)	This level may be found in automobile exhaust.	

Effect of carbon dioxide (CO₂)

Concentration (%)	Effect of concentration changes	
0.03 (0.04)	Standard atmosphere.	
0.04 - 0.06	City air.	There is no toxic level in CO ₂ alone. However, these tolerable concentrations are a guideline of the contamination estimated when the physical and chemical properties of the air deteriorate in proportion to the increase of CO ₂ .
0.07	Tolerable concentration when many people stay for long time.	
0.10	General tolerable concentration. From Japanese building code, Building Management Law standards	
0.15	Tolerable concentration used for ventilation calculations.	
0.2 - 0.5	Considered as relatively poor.	
0.5 or more	Considered as the poorest.	
0.5	Long-term safety limits (U.S. Labor Sanitation) ACGIH, regulation of laborer offices.	
2	Depth of breathing and inhalation volume increases 30%.	
3	Work and physical functions deteriorate, breathing doubles.	
4	Normal exhalation concentration.	
4 - 5	The respiratory center is stimulated; depth and times of breathing increases. Dangerous if breathed in for a long period. If an O ₂ deficiency also occurs, trouble will occur sooner and be more dangerous.	
8	When breathed in for 10 minutes, breathing difficulties, redness in the face and headaches will occur. The trouble will worsen when there is also a deficiency of O ₂ .	
18 or more	Fatal	

Note: According to Facility Check List published by Kagekuni-sha.

3.1.2 Effect of air contamination in buildings

Dirtiness of interior

New ceilings, walls and ornaments will turn yellow in one to two years. This is caused by dust and the tar in tobacco smoke.

3.2 Ventilation Method

3.2.1 Ventilation class and selection points

An appropriate ventilation method must be selected according to the purpose.

Ventilation is composed of “Supply air” and “Exhaust air” functions. These functions are classified according to natural flow or mechanical ventilation using a fan (forced ventilation).

Classification of ventilation (according to Building Standards Law)

	Supply	Exhaust	Ventilation volume	Room pressure
Class 1	Mechanical	Mechanical	Random (constant)	Random
Class 2	Mechanical	Natural	Random (constant)	Positive pressure
Class 3	Natural	Mechanical	Random (constant)	Negative pressure
Class 4	Natural	Mechanical & natural	Limited (inconstant)	Negative pressure

Classification of mechanical ventilation

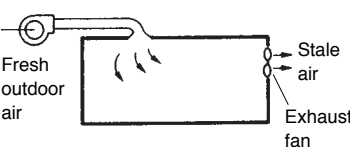
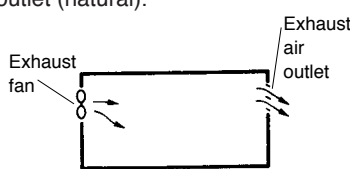
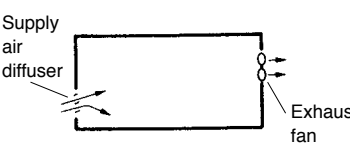
	Ex. of application	System effect	Design and construction properties	Selection points
<p>1. Class 1 ventilation Fresh outdoor air is mechanically brought in and simultaneously the stale air in the room is mechanically discharged.</p> 	<ul style="list-style-type: none"> • Ventilation of air conditioned rooms. (buildings, hospitals, etc.) • Ventilation of room not facing an outer wall. (basement, etc.) • Ventilation of large room. (office, large conference room, hall, etc.) 	By changing the balance of the supply fan and exhaust fan's air volumes, the pressure in the room can be balanced freely, and the interrelation with neighboring spaces can be set freely.	<ul style="list-style-type: none"> • An ideal design in which the supply air diffuser and exhaust air outlet position relation and air volume, etc., can be set freely is possible. • A system which adjusts the temperature and humidity of the supply air diffuser flow to the room environment can be incorporated. • The supply and exhaust volume can be set freely according to the changes in conditions. 	<ul style="list-style-type: none"> • Accurate supply air diffuser can be maintained. • The room pressure balance can be maintained. • The supply air diffuser temperature and humidity can be adjusted and dust treatment is possible.
<p>2. Class 2 ventilation Fresh outdoor air is mechanically brought in and the exhaust air is discharged from the exhaust air outlet (natural).</p> 	<ul style="list-style-type: none"> • Operating room. • Clean rooms. • Foodstuff processing factories. 	As the room is pressurized, the flow of odors and dust, etc., from neighboring areas can be prevented.	<ul style="list-style-type: none"> • The position and shape of the supply air diffuser can be set. • The temperature and humidity of the supply air diffuser flow can be set accordingly, and dust can be removed as required. 	<ul style="list-style-type: none"> • The pressure is positive. • The supply air diffuser temperature and humidity can be adjusted, and dust treatment is possible. • The positional relation of the exhaust air outlet to the supply air diffuser is important.
<p>3. Class 3 ventilation The stale air in the room is mechanical-ly discharged and simultaneously fresh outdoor air is mechanically introduced from the supply air diffuser (natural).</p> 	<ul style="list-style-type: none"> • Local ventilation in kitchens. • Ventilation of hot exhaust air from equipment rooms, etc. • Ventilation of humid exhaust air from indoor pools, bath-rooms, etc. • General simple ventilation. 	The exhaust air is removed from a local position in the room, and applying an even negative pressure can prevent dispersion of the stale air.	<ul style="list-style-type: none"> • Effective exhausting of dispersed stale air generation sites is possible from a local exhaust air outlet. • Ventilation in which the air flow is not felt is possible with the supply air diffuser setting method. 	<ul style="list-style-type: none"> • The room pressure is negative. • Local exhaust is possible. • Ventilation without dispersing stale air is possible. • Ventilation with reduced air flow is possible. • The positional relation of the exhaust air outlet to the supply air diffuser is important.

3.2.2 Comparison of ventilation methods

There are two main types of ventilation methods.

Centralized ventilation method

This is mainly used in large buildings, with the fresh outdoor air intake being provided within a single equipment room. For this method, primary treatment of the fresh outdoor air, such as heat exchange to the intake air and dust removal is performed before distribution to the building by ducts.

Independent zoned ventilation method

This is mainly used in small to medium sized buildings, where the areas being ventilated use independent devices for fresh outdoor air intake. The rate of use of this method has recently increased as independent control is becoming ever more feasible.

Centralized ventilation method

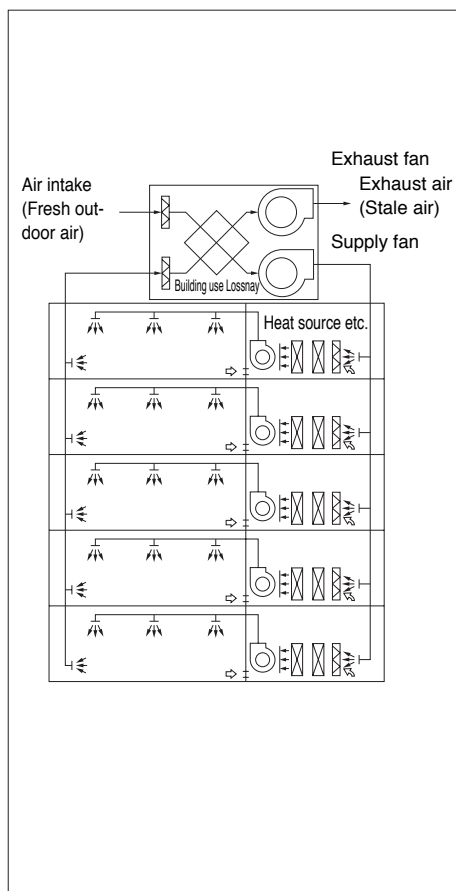

Independent zoned ventilation method

(1) System using Lossnay and cassette-type air conditioner

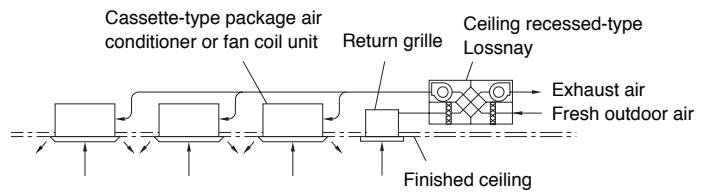

(2) System using Lossnay and ceiling recessed-type air conditioner

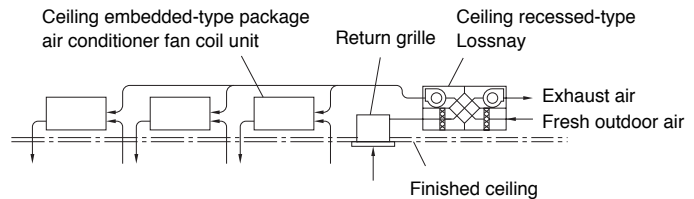

(3) System using OA processing unit

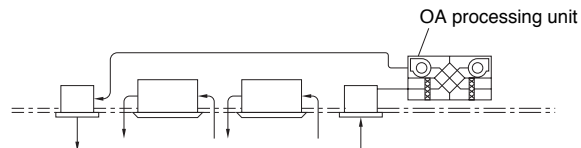

3.2.3 Comparison of types of air conditioning systems

Comparison of centralised ventilation method and independent zoned ventilation method

	Centralized ventilation method	Independent zoned ventilation method
Fan power	The air transfer distance is long thus requiring much fan power.	As the air transfer distance is short, the fan power is small.
Installation space	<ul style="list-style-type: none"> • Independent equipment room is required. • Duct space is required. • Penetration of floors with vertical shaft is not desired in terms of fire prevention. 	<ul style="list-style-type: none"> • Independent equipment room is not required. • Piping space is required only above the ceiling.
Zoning	Generalized per system.	Can be utilised for any one area.
Designability	<ul style="list-style-type: none"> • Design of outer wall is not lost. • The indoor supply air diffuser and return grille can be selected freely for an appropriate design. 	<ul style="list-style-type: none"> • The number of intakes and exhaust air outlets on the outer wall will increase; design must be considered. • The design will be fixed due to the installation fittings, so the design of the intakes and exhaust air outlets must be considered.
Independent invoicing of electricity	As there are many common-use areas, if the building is a tenant building, an accurate assessment of operating cost is difficult.	Invoicing for each zone separately is possible, even in a tenant building.
Controllability	<ul style="list-style-type: none"> • As the usage time setting and ventilation volume control, etc., is performed in a central monitoring room, the user's needs may not be met appropriately. • A large amount of ventilation is required even for a few persons. 	<ul style="list-style-type: none"> • The user in each zone can operate the ventilator freely. • The ventilator can be operated even during off-peak hours.
Comfort	<ul style="list-style-type: none"> • An ideal supply air diffuser and return grille position can be selected as the supply air diffuser and return grilles can be laid out freely. • The only noise in the room is the aerodynamic sound. • Anti-vibration measures must be taken as the fan in the equipment room is large. 	<ul style="list-style-type: none"> • Consideration must be made of the noise from the main unit. • Anti-vibration measures are often not required as the unit is compact and the vibration generated can be dispersed.
Maintenance and management	<ul style="list-style-type: none"> • Centralized management is easy as it can be performed in the equipment room. • The equipment can be inspected at any time. 	<ul style="list-style-type: none"> • Work efficiency is poor as the equipment is not centrally located. • An individual unit can be inspected only when the room it serves is vacant.
Affect of breakdown	<ul style="list-style-type: none"> • Large as the entire system is affected. • Immediate inspection can be performed in the equipment room. 	<ul style="list-style-type: none"> • Limited as only independent units are affected. • Consultation with the tenant is required prior to inspection of an individual unit.

3.3 Outdoor Air (Ventilation) Load

3.3.1 How to calculate each approximate load

The outdoor air load can be calculated with the following formula if the required outside air intake volume Q m³/h to be introduced is known:

$$(\text{Outdoor air load}) = \gamma \cdot QF \cdot (iO \text{ to } iR)$$

$$= \gamma \text{ [kg/m}^3\text{]} \times S \text{ [m}^2\text{]} \times k \times n \text{ [person/m}^2\text{]} \times V_f \text{ [m}^3\text{/h-person]} \times (iO \text{ to } iR) : \Delta i \text{ [kJ/kg]}$$

γ : Specific gravity of air – 1.2 kg/m³

S : Building's airconditioned area

k : Thermal coefficient; generally 0.7 to 0.8.

n : The average population concentration is the inverse of the occupancy area per person. If the number of persons in the room is unclear, refer to the Floor space per person table below.

V_f : Outdoor air intake volume per person

Refer to the "Required outdoor air intake volume per person" table shown below.

iO : Outdoor air enthalpy – kJ/kg

iR : Indoor enthalpy – kJ/kg

Floor space per person table (m²)

(According to the Japan Federation of Architects and Building Engineers Associations)

	Office building	Department store, shop			Restaurant	Theatre or cinema hall
		Average	Crowded	Empty		
General design value	4 - 7 5	0.5 - 2 3.0	0.5 - 2 1.0	5 - 8 6.0	1 - 2 1.5	0.4 - 0.6 0.5

Required outdoor air intake volume per person table (m³/h-person)

Degree of smoking	Application example	Required ventilation volume	
		Recommended value	Minimum value
Extremely heavy	Broker's office Newspaper editing room Conference room	85	51
Quite heavy	Bar Cabaret	51	42.5
Heavy	Office	25.5	17
	Restaurant	25.5	20
Light	Shop	25.5	17
	Department store		
None	Theatre	25.5	17
	Hospital room	34	25.5

Caution

The application of this table to each type of room should be carefully considered in relation to the degree of smoking in the room.

CHAPTER 2 ● Air Conditioning System Design Section

Example calculations of determining ventilation load during both cooling and heating are given as follows:

3.3.2 Ventilation load during cooling (in general office building)

● Classification of cooling load

	Class	
(a)	Indoor infiltration heat	Heat from walls (q_{ws}) Heat from glass { from direct sunlight (q_{GS}) from conduction & convection (q_{GS}) Accumulated heat load in walls (q_{SS})
(b)	Indoor generated heat	Generated heat from people { Sensible heat (q_{HS}) Latent heat (q_{HL}) Generated heat from electrical equipment { Sensible heat (q_{ES}) Latent heat (q_{EL})
(c)	Reheating load	(q_{RL})
(d)	Outdoor air load	{ Sensible heat (q_{FS}) Latent heat (q_{FL})

(a) is the heat infiltrating the room, and often is 30 to 40% of the entire cooling load.

(b) is the heat generated in the room.

(c) is applies only when reheating is necessary.

(d) is the heat generated when outdoor air is mixed into part of the supply air diffuser volume and introduced into the room.

The outdoor air is introduced to provide ventilation for the people in the room, and is referred to as the ventilating load.

Typical load values (during cooling)

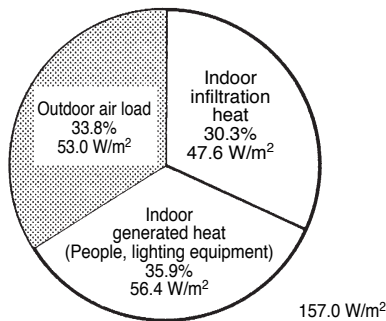

Type of load		Load
Outdoor air load		53.0 W/m^2
Indoor generated heat	People	26.4 W/m^2
	Lighting equipment	30.0 W/m^2
Indoor infiltration heat		47.6 W/m^2
Total		157.0 W/m^2

Conditions: Middle floor of a general office building facing south.

● Determining internal heat gain

When classifying loads, the internal heat gain (indoor generated heat + indoor infiltration heat) will be the value of the outdoor air load subtracted from the approximate cooling load when it is assumed that there is no reheating load.

(Internal heat gain)

$$= 157.0 \text{ W/m}^2 - 53.0 \text{ W/m}^2 = 104.0 \text{ W/m}^2$$

This value of internal heat gain is based on assumptions for typical loads. To determine individual levels of internal heat gain, the following is suggested:

● **Indoor generated heat**

(1) Heat generated from people

Heat generation design value per person in office

Sensible heat (SH) = 63.0 W/person

Latent heat (LH) = 69.0 W/person

Total heat (TH) = 132.0 W/person

The heat generated per 1 m² of floor space is

(Heat generated from people)

$$= 132.0 \text{ W/person} \times 0.2 \text{ person/m}^2 = 26.4 \text{ W/m}^2$$

(2) Heat generated from electrical equipment (lighting)

The approximate value of the room illuminant and power for lighting for a general office with illumination of 300 to 350 Lux, is 20 to 30 W/m².

Note that the heat generated for each watt of electrical power consumption is 1.2 W for fluorescent lights, including the heat generated by the ballast. The following should be considered as the generated heat volume in terms of average of electrical power used for illumination.

(Heat generated by lighting fixtures)

$$= 25 \text{ W/m}^3 \times 1.2 \text{ W}$$

$$= 30 \text{ W/m}^3$$

● **Indoor infiltration heat**

This is the heat that infiltrates into the building from outside. This can be determined by subtracting the amount of heat generated by people and lighting from the internal heat gain.

(Indoor infiltration heat)

$$= 104.0 - (26.4 + 30.0) = 47.6 \text{ W/m}^2$$

Cooling load per unit area

When the volume of outdoor air per person is 25 m³/h, and the number of persons per 1 m² is 0.2, the cooling load will be approximately 157.0 W/m².

How these values are determined can be seen as follows:

● **Outdoor air load**

Air conditions <Standard design air conditions in Tokyo>

		Dry bulb temp.	Relative humidity	Wet bulb temp.	Enthalpy	Enthalpy difference
Cooling	Outdoor air	33°C	63%	27°C	85 kJ/kg	31.8 kJ/kg
	Indoors	26°C	50%	18.7°C	53.2 kJ/kg	

When the load per floor area of 1 m² with a ventilation volume of 25 m³/h-person is calculated with the above air conditions, the following is obtained:

$$\begin{aligned} \text{Outdoor air (ventilation) load} &= 1.2 \text{ kg/m}^3 \text{ (Specific gravity of air)} \times 0.2 \text{ persons/m}^2 \text{ (no. of persons per 1 m}^2\text{)} \\ &\times 25 \text{ m}^3\text{/h-person (outdoor air volume)} \times 31.8 \text{ kJ/kg (air enthalpy difference indoors/outdoors)} \\ &\times 0.2777 \text{ (1,000 W/3,600 sec.)} = 53.0 \text{ W/m}^2 \end{aligned}$$

Lossnay recovers approximately 70% of the exhaust air load and saves on approximately 20% of the total load.

3.3.3 Ventilation load during heating

● Classification of heating load

	Class	
(a)	Indoor heat loss	Heat lost from walls (q_{ws}) Heat lost from glass (q_{gs}) Heat loss from conduction & convection (q_{cs}) Accumulated heat load in walls (q_{ss})
(b)	Outdoor air load	Sensible heat (q_{Fs}) Latent heat (q_{FL})

During heating, the heat generated by people and electrical equipment in the room can be subtracted from the heating load.

However, as the warming up time at the start of heating is short, this generated heat may be ignored in some cases.

Percentage of load

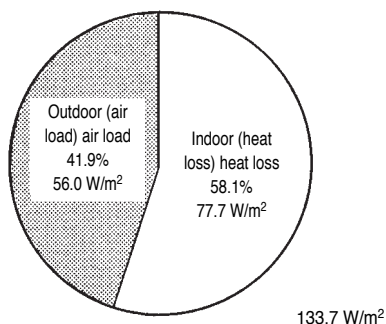

Type of load	Load
Outdoor air load	56.0 W/m ²
Internal heat loss	77.7 W/m ²
Total	133.7 W/m ²

Conditions: Middle floor of a general office building facing south.

Internal heat loss

In terms of load classification, the internal heat loss is the value of the outdoor air load subtracted from the approximate heating load.

(Internal heat loss)
 $= 133.7 \text{ W/m}^2 - 56.0 \text{ W/m}^2 = 77.7 \text{ W/m}^2$

Heating load per unit area

When the outdoor air volume per person is 25 m³/h, and the number of persons per 1 m² is 0.2 persons, the approximate heating load will be approximately 133.7 W/m².

● Outdoor air load

Air conditions <Standard design air conditions in Tokyo>

		Dry bulb temp.	Relative humidity	Wet bulb temp.	Enthalpy	Enthalpy difference
Heating	Outdoor air	0°C	50%	-3°C	5 kJ/kg	33.5 kJ/kg
	Indoors	20°C	50%	13.7°C	38.5 kJ/kg	

When the load per 1 m² of floor area with a ventilation volume of 25 m³/h·person is calculated with the above air conditions, the following is obtained:

Outdoor air (ventilation) load = 1.2 kg/m³ × 0.2 persons/m² × 25 m³/h·person × 33.5 kJ/kg
 × 0.2777 (1,000 W/3,600 sec.) = 56.0 W/m²

Lossnay recovers approximately 70% of the exhaust air load and saves on approximately 30% of the total load.

3.4 Ventilation Performance

The ventilation performance is largely affected by the installation conditions. Ample performance may not be achieved unless the model and usage methods are selected according to the conditions.

Generally, the ventilation performance is expressed by “Air volume” and “Air flow pressure (static pressure)”, and these are necessary when considering ventilation.

3.4.1 Air volume

Air volume expresses the volume of air exhausted (or supplied) by the unit in a given period. Generally, this is expressed as m³/hr (hour).

3.4.2 Air flow pressure

When a piece of paper is placed in front of a fan and let go, the piece of paper will be blown away. The force that blows the paper away is called the wind pressure (air flow pressure), and this is normally expressed in units of Pa. The air flow pressure is divided into the following three types:

(1) Static pressure

This is the force that presses the surroundings when the air is not moving such as in an automobile tire or rubber balloon. For example, in a water gun, the hydraulic pressure increases when pressed by a piston – and if there is a small hole, the water sprays out with force. The pressure of this water is equivalent to the static pressure for air. The higher the pressure is, the further the water (air) can be sprayed.

(2) Dynamic pressure

This expresses the speed at which air flows, and can be thought of as the force at which a typhoon presses against a building.

(3) Total pressure

This is the total force that air flow has, and is the sum of the static pressure and dynamic pressure.

3.4.3 Measurement of the air volume and air flow pressure

Mitsubishi measures the unit’s air volume and air flow pressure with a device as shown below according to the Japan Industrial Standards (JIS C 9603).

Measuring device (JIS C 9603 standards)

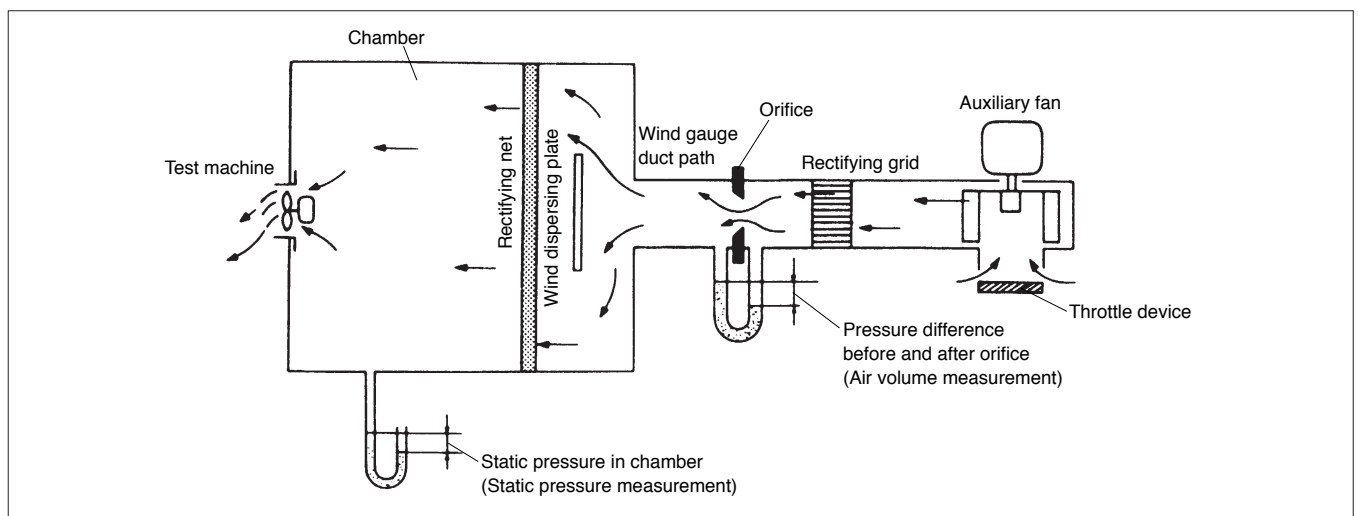

Measurement method

The unit is operated with the throttle device fully closed. There is no air flow at this time, and the air volume is 0. The maximum point of the static pressure (A point, the static pressure at this point is called the totally closed pressure) can be obtained. Next, the throttle device is gradually opened, the auxiliary fan is operated, and the middle points (points B, C and D) are obtained. Finally, the throttle device is completely opened, and the auxiliary fan is operated until the static pressure in the chamber reaches 0. The maximum point of the air volume (point E, the air volume at this point is called the fully opened air volume) is obtained. The points are connected as shown below, and are expressed as air volume, static pressure curves (Q-H curve).

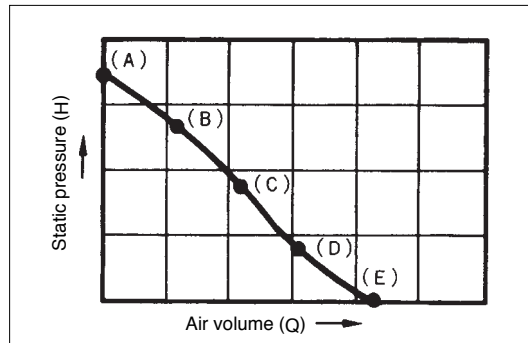

4. Characteristics

4.1 How to Read the GUF Series OA Processing Unit Characteristic Curves

4.1.1 Obtaining characteristics from static pressure loss

- (1) Static pressure loss from straight pipe duct length (at required air volume)
- (2) Static pressure loss at curved section (at required air volume)
- (3) Static pressure loss of related parts (at required air volume)



Total static pressure loss

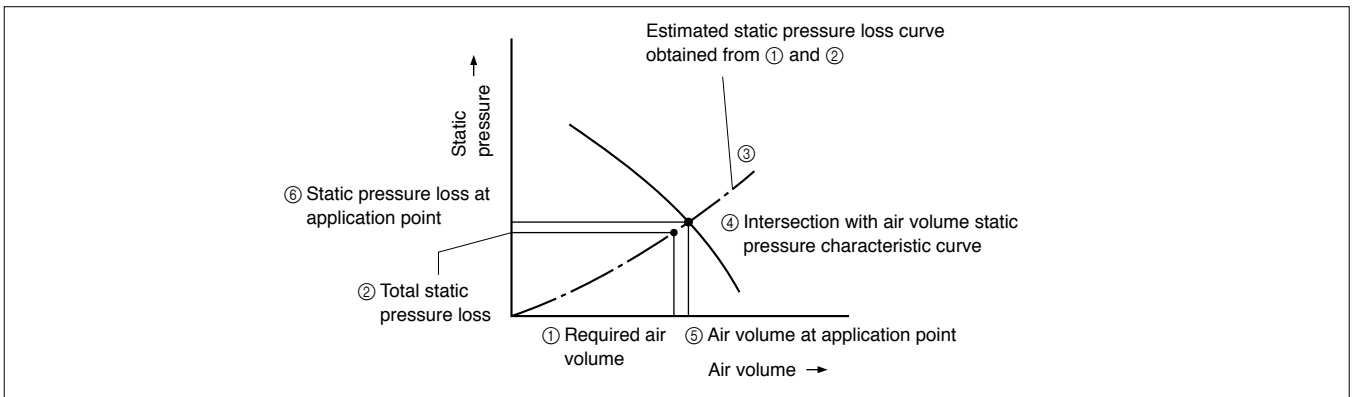

4.1.2 Calculation of duct pressure loss

When selecting a model that is to be used with a duct, calculate the volumes according to Tables 3, 4, 5 and 6, and then select the unit according to the air volume and static pressure curve.

(1) Calculation of a rectangular pipe

Table 3 Conversion table from rectangular pipe to circular pipe

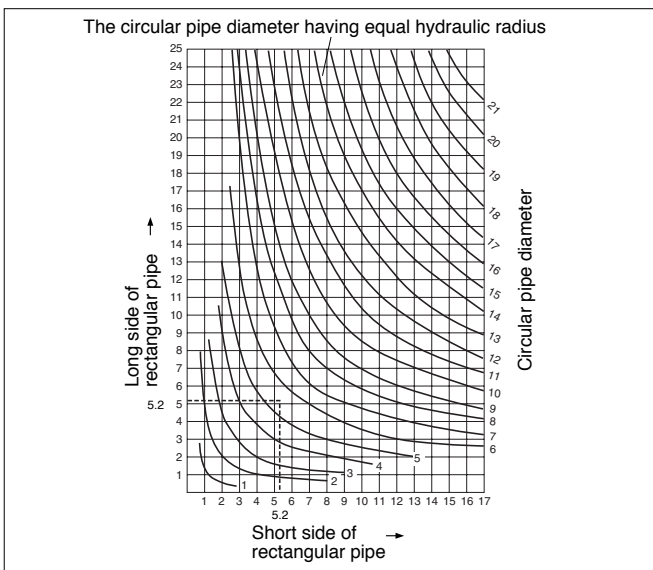

How to read Table 3

Select the unit as per each duct. In the above example, the □520 rectangular pipe only goes as far as 17. Thus, the long side, short side and converted circular pipe values are all multiplied by 100. The point 560 where the two lines cross is hence the value where the rectangular pipe equates to the circular pipe.

(2) How to obtain the duct resistivity

Table 4 Circular duct friction loss (steel plate duct, inner roughness $\epsilon = 0.18$ mm)

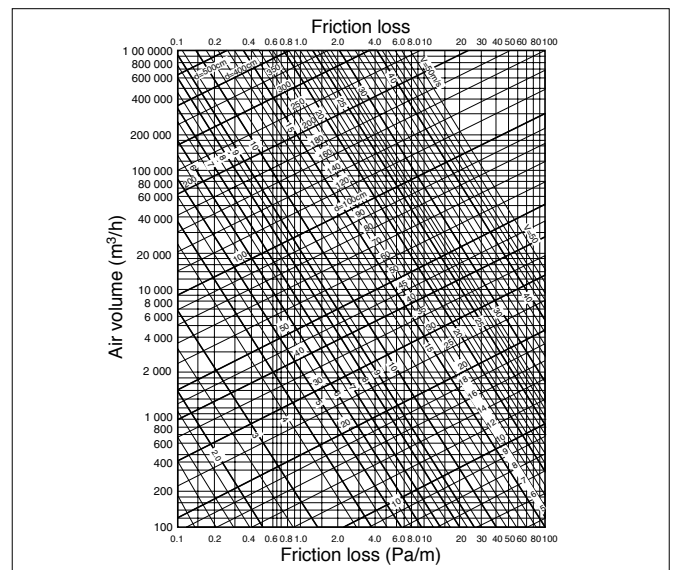

How to read Table 4

The point where the line of the circular duct diameter (leftward slanting line) and of the required air velocity (horizontal line) intersect is the pressure loss per 1 m of duct. The value of the slanted line to the lower right of the intersecting point is the average velocity.

CHAPTER 2 ● Air Conditioning System Design Section

The figure obtained from Table 4 must then be corrected for duct type at various velocities. This can be done using Table 5 below.

Table 5 Friction coefficient compensation table

Duct inner surface	Example	Average velocity (m/sec)			
		5	10	15	20
Very rough surface	Concrete finish	1.7	1.8	1.85	1.9
Rough	Mortar finish	1.3	1.35	1.35	1.37
Very smooth	Drawn steel pipe Vinyl pipe	0.92	0.85	0.82	0.8

An alternative, more detailed method for determining the pressure loss in duct work is as shown using the following formula:

<p>Circular pipe section pressure loss</p> $\Delta p = \lambda \cdot \frac{\ell}{d} \cdot \frac{\rho}{2} \cdot v^2 \text{ (Pa)}$ $\Delta p = C \cdot \frac{\rho}{2} \cdot v^2 \text{ (Pa)}$ $= 0.6 C \cdot v^2$	<p> λ : Friction resistance coefficient (smooth pipe 0.025) C : Local loss coefficient (refer to Table 6) d : Duct diameter (m) ℓ : Duct length (m) ρ : Air weight (1.2 kg/m²) v : Wind velocity (m/s) </p>
--	---

(3) How to calculate curved sections

Table 6 List of pressure losses in each duct section

No.	Duct section	Outline diagram	Conditions	C value	Length of equivalent circular pipe	No.	Duct section	Outline diagram	Conditions	C value	Length of equivalent circular pipe										
1	90° Smooth Elbow		R/D = 0.5	0.73	43D	12	Transformer			0.15	9D										
			= 0.75	0.38	23D																
			= 1.0	0.26	15D																
			= 1.5	0.17	10D																
			= 2.0	0.15	9D																
2	Rectangular Radius Elbow		W/D	R/D		13	Abrupt Entrance			0.50	30D										
			0.5	0.5	1.30				79D												
			0.75	0.47	29D																
			1.0	0.28	17D																
			1.5	0.18	11D																
			1-3	0.5	0.95				57D												
				0.75	0.33				20D												
				1.0	0.20				12D												
				1.5	0.13				8D												
3	Rectangular Vaned Radius Elbow		No. of vanes	R/D		14	Abrupt Exit			1.0	60D										
			1	0.5	0.70				42D												
				0.75	0.16				10D												
				1.0	0.13				8D												
				1.5	0.12				7D												
			2	0.5	0.45				27D												
				0.75	0.12				7D												
				1.0	0.10				6D												
				1.5	0.15				9D												
4	90° Miter Elbow			0.87	53D	15	Bellmouth Entrance			0.03	2D										
5	Rectangular Square Square Elbow			1.25	76D																
6	Rectangular Vaned Square Elbow			0.35	21D																
7	Rectangular Vaned Square Junction		Same loss as circular duct. Velocity is based on inlet.		16				Bellmouth Exit					1.0	60D						
8	Rectangular Vaned Radius Junction		Same loss as circular duct. Velocity is based on inlet.																		
9	45° Smooth Elbow		With or without vanes, rectangular or circular	1/2 times value for similar 90°		17	Re-entrant inlet				0.85		51D								
10	Expansion		a = 5°	0.17						10D						18	Sharp edge round orifice		V1/V2 = 0	2.8	170D
			10°	0.28						17D									0.25	2.4	140D
			20°	0.45	27D				0.50	1.9		110D									
			30°	0.59	36D				0.75	1.5		90D									
			40°	0.73	43D	1	1.0	60D													
			Loss is for hV1 - hV2		19	Pipe inlet (with circular hood)		beta	20°	0.02											
11	Contraction		a = 30°	0.02				1D	40°	0.03											
			45°	0.04				2D	60°	0.05											
			60°	0.07				4D	90°	0.11											
			Loss is for V2					120°	0.20												
20	Pipe inlet (with rectangular hood)		beta	20°	0.03	21	Abrupt contraction		V1/V2 = 0	0.5	30D										
				40°	0.08				0.25	0.45	27D										
				50°	0.12				0.50	0.32	19D										
				90°	0.19				0.75	0.18	11D										
				120°	0.27																
21	Abrupt contraction		Loss is for V2		22	Abrupt expansion		V1/V2 = 0	1.0	60D											
								0.20	0.64	39D											
								0.40	0.36	22D											
								0.60	0.16	9D											
								0.80	0.04	2D											
Loss is for V1																					
22	Abrupt expansion		Loss is for V1		23	Suction inlet (punched narrow plate)		Free are ratio	0.2	35											
								0.4	7.6												
								0.6	3.0												
								0.8	1.2												

5. Lossnay Core Effect

5.1 Calculation of the Total Heat Recover Efficiency

The Lossnay Core’s heat recover efficiency can be evaluated using the following three transfer rates:

- 1) Temperature (sensible heat) recover efficiency
- 2) Humidity (latent heat) recover efficiency
- 3) Enthalpy (total heat) recover efficiency

The heat recovery effect can be calculated if two of the above efficiencies is known. (The temperature and enthalpy efficiencies is indicated in the applicable catalogue.)

- Each recover efficiency can be calculated with the formulas given below.
- When the supply air volume and exhaust air volume are equal, the heat exchange efficiencies on the supply and exhaust sides are the same.
- When the supply air volume and exhaust air volume are not equal, the total heat recover efficiency is low if the exhaust volume is lower, and high if the exhaust volume is higher.

Refer to the efficiency correction graph in the applicable catalogue for more details.

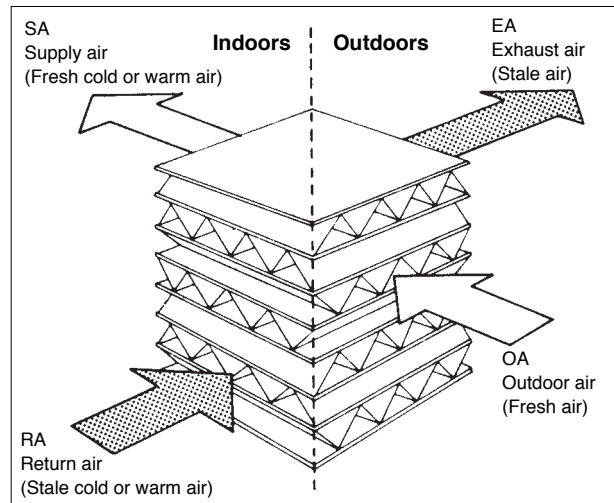

Item	Formula
Temperature heat exchange efficiency (%)	$\eta_t = \frac{t(OA) - t(SA)}{t(OA) - t(RA)} \times 100$
Enthalpy heat exchange efficiency (%)	$\eta_i = \frac{i(OA) - i(SA)}{i(OA) - i(RA)} \times 100$

η : Efficiency (%)
 t : Dry bulb temperature (°C)
 i : Enthalpy (kJ/kg)

Calculation of air conditions after passing through Lossnay Core

If the Lossnay Core heat exchange efficiency and the conditions of the room and outdoor air are known, the conditions of the air entering the room and the air exhausted outdoors can be determined with the following formulas.

	Supply side	Exhaust side
Temperature	$t_{SA} = t_{OA} - (t_{OA} - t_{RA}) \cdot \eta_t$	$t_{EA} = t_{RA} + (t_{OA} - t_{RA}) \cdot \eta_t$
Enthalpy	$i_{SA} = i_{OA} - (i_{OA} - i_{RA}) \cdot \eta_i$	$i_{EA} = i_{RA} + (i_{OA} - i_{RA}) \cdot \eta_i$

When the Lossnay Core efficiency is found using a characteristics graph and if the amount of supply and exhaust air is uneven, the efficiency will be different. In such cases, use the efficiency correction graph.

5.2 What is a Psychrometric Chart?

The chart which shows the properties of humid air is called a psychrometric chart. The psychrometric chart can be used to find the (1) Dry bulb temperature, (2) Wet bulb temperature, (3) Absolute humidity, (4) Relative humidity, (5) Dew point and (6) Enthalpy of a certain air condition. If two of these values are known beforehand, the other values can be found with this chart. The way that the air will change when it is heated, cooled, humidified or dehumidified can also be seen easily on the chart.

(1) Dry bulb temperature t (°C)

Generally referred to as standard temperature this is measured with a dry bulb thermometer (conventional thermometer). The obtained value is the dry bulb temperature.

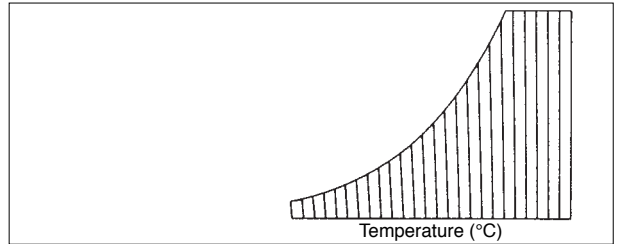

(2) Wet bulb temperature t' (°C)

When a dry bulb thermometer's heat sensing section is wrapped in a piece of wet gauze and an ample air flow (3 m/s or more) is applied, the heat applied to the wet bulb by the air and the heat of the water vapor that evaporates from the wet bulb will balance at an equal state. The temperature indicated at this time is called the wet bulb temperature.

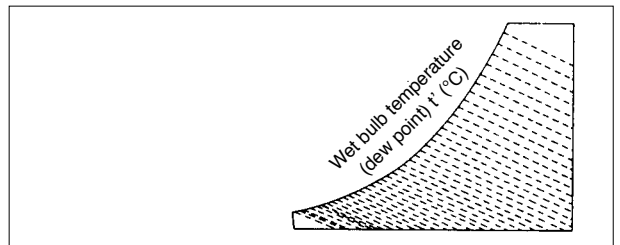

(3) Absolute humidity x (kg/kg')

The weight (kg) of the water vapor that corresponds to the weight (kg') of the dry air in the humid air is called the absolute humidity.

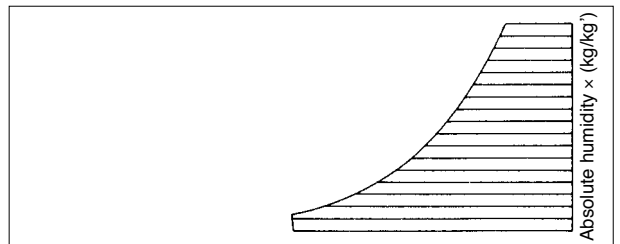

(4) Relative humidity ϕ (%)

The ratio of the water vapor pressure P_w in the humid air and the water vapor pressure P_{ws} in the saturated air at the same temperature is called the relative humidity. This is obtained with the following formula:

$$\phi R = P_w / P_{ws} \times 100$$

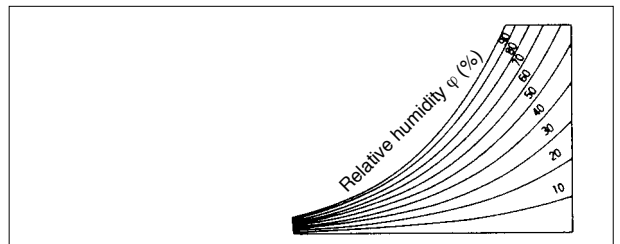

(5) Dew point t'' (°C)

The water content in the air will start to condense when air is cooled.

The dry bulb temperature at this time is called the dew point.

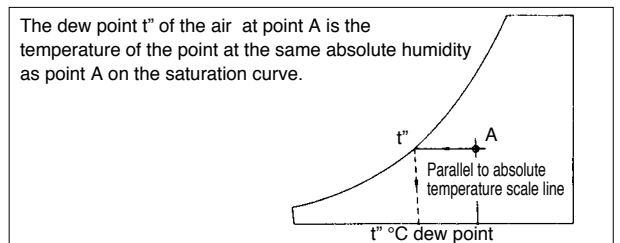

(6) Enthalpy i (kJ/kg)

Physical matter has a set heat when it is at a certain temperature and state. This retained heat is called the enthalpy, with dry air at 0°C being set at 0.

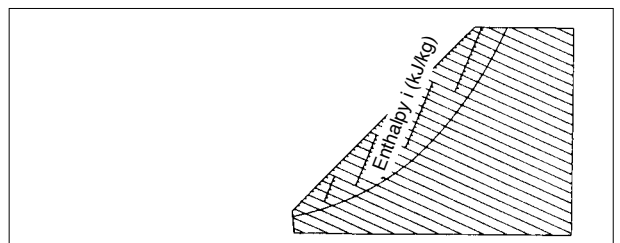

5.3 Calculation of Lossnay Core Heat Recovery

The following figure shows the conditions of various air states when fresh air is introduced through the Lossnay Core. If a sensible heat recovery unit is used alone and is assumed to have the same heat recover efficiency as Lossnay Core, the condition of the air supplied to the room is expressed by point A in the figure. This point shows that the air is very humid in summer and very dry in winter.

The air supplied to the room with Lossnay Core is indicated by point S in the figure. The air is precooled and dehumidified in the summer and preheated and humidified in the winter before it is introduced to the room.

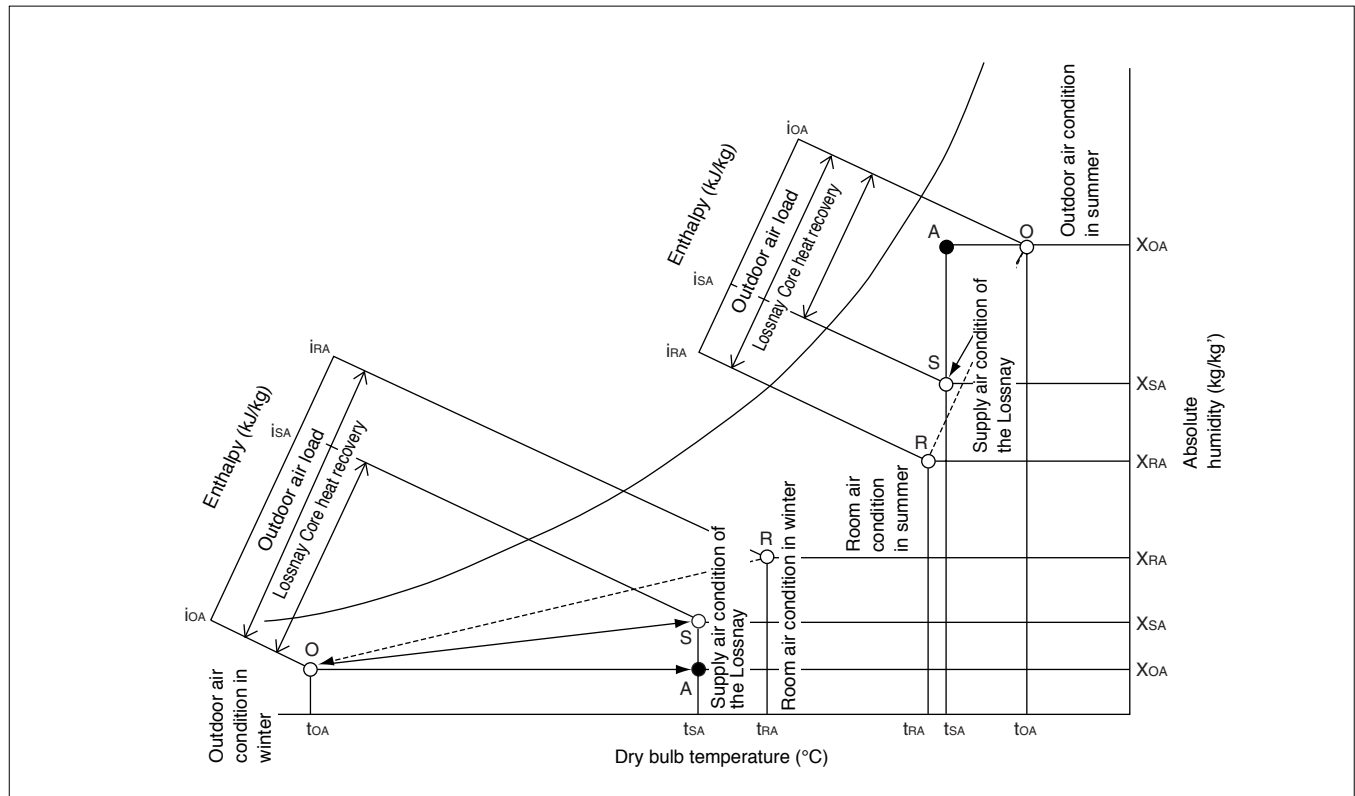

The quantity of heat recovered by using the Lossnay Core can be calculated with the following formula.

$$\begin{aligned} \text{Total heat recovered: } q_T &= \gamma \cdot Q \cdot (i_{OA} - i_{SA}) \text{ [W]} \\ &= \gamma \cdot Q \cdot (i_{OA} - i_{RA}) \times \eta_i \end{aligned}$$

- Where
- γ = Specific weight of air under standard conditions 1.2 (kg/m³)
 - Q = Treated air volume (m³/h)
 - t = Temperature (°C)
 - x = Absolute humidity (kg/kg['])
 - i = Enthalpy (kJ/kg)
 - η = Exchange efficiency (%)

- Suffix meanings
 - OA : Outdoor air
 - RA : Return air
 - SA : Supply air

5.4 Lossnay Core Heat Recovery Effect

Comparison of outdoor air load of various ventilators

Examples of formulas to compare the heat recovered and outdoor air load when ventilating with the Lossnay (total heat recovery ventilator), sensible heat recovery ventilator and conventional ventilators are shown below.

(1) Cooling during summer

Conditions:

- Model GUF-100RDH3
- Heat exchange efficiency table (%) (For summer)
- Ventilation rate: 1,000 m³/h (Specific gravity of air $\gamma = 1.2 \text{ kg/m}^3$)

	Lossnay	Sensible HRV	Conventional ventilator
Temperature (sensible heat)	79	75	0
Enthalpy (total heat)	64.5	—	0

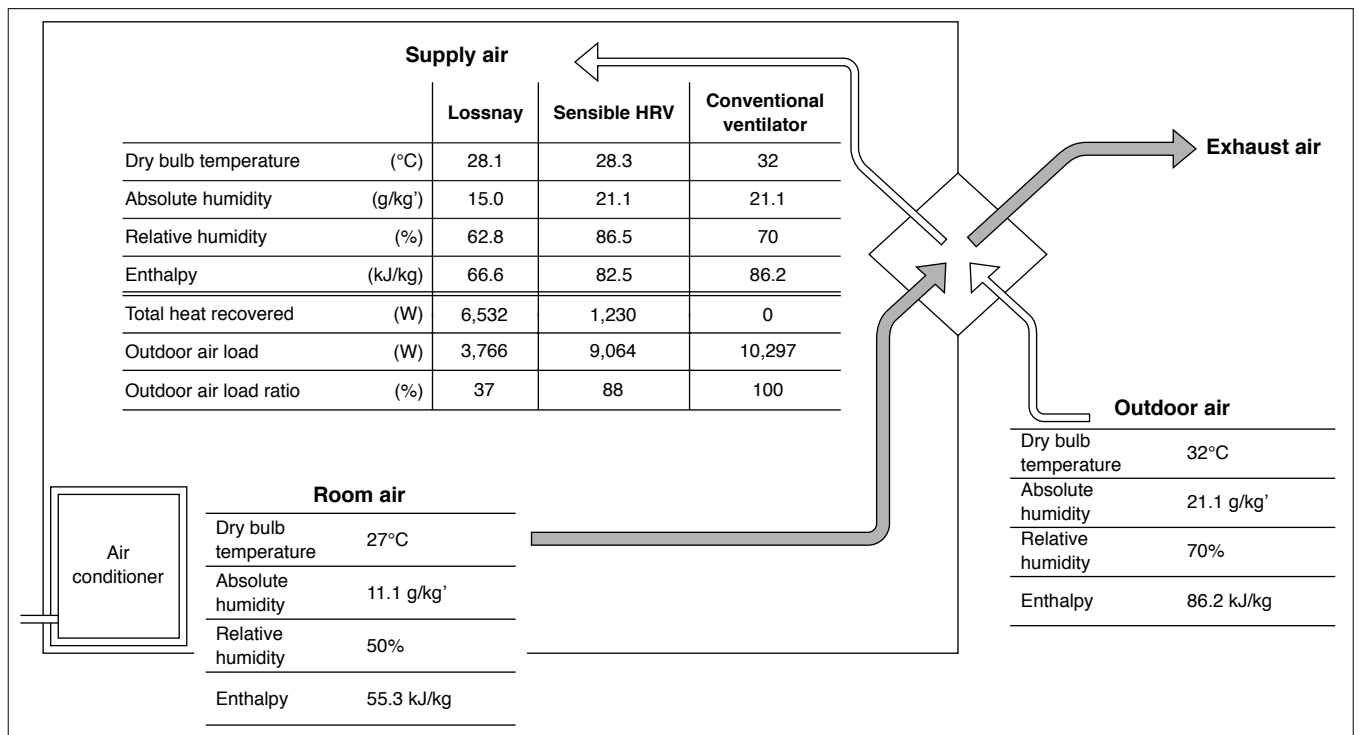

Calculation example

- Lossnay
 (Supply air diffuser temperature) $t_{SA} = 32^\circ\text{C} - (32^\circ\text{C} - 27^\circ\text{C}) \times 0.79 = 28.1^\circ\text{C}$
 (Supply air diffuser enthalpy) $i_{SA} = 86.2 - (86.2 - 55.3) \times 0.645 = 66.6 \text{ kJ/kg}$
 Heat recovered $(86.2 - 66.6) \times 1.2 \times 1,000 \times 0.2777^+ = 6,532 \text{ W}$
 Outdoor air load $(66.6 - 55.3) \times 1.2 \times 1,000 \times 0.2777^+ = 3,766 \text{ W}$
- Sensible HRV
 (Supply air diffuser temperature) $t_{SA} = 32^\circ\text{C} - (32^\circ\text{C} - 27^\circ\text{C}) \times 0.75 = 28.3^\circ\text{C}$
 (Supply air diffuser enthalpy) $i_{SA} = 82.5 \text{ kJ/kg}$ (from psychrometric chart)
 Heat recovered $(86.2 - 82.5) \times 1.2 \times 1,000 \times 0.2777^+ = 1,230 \text{ W}$
 Outdoor air load $(82.5 - 55.3) \times 1.2 \times 1,000 \times 0.2777^+ = 9,064 \text{ W}$
- Conventional ventilator
 If a conventional ventilator is used, the heat recovered will be 0 as the supply air diffuser is equal to the outdoor air.
 The outdoor air load is:
 $(86.2 - 55.3) \times 1.2 \times 1,000 \times 0.2777^+ = 10,297 \text{ W}$
 + Conversion Factor (1,000 W/3,600 sec.)

Summer conditions

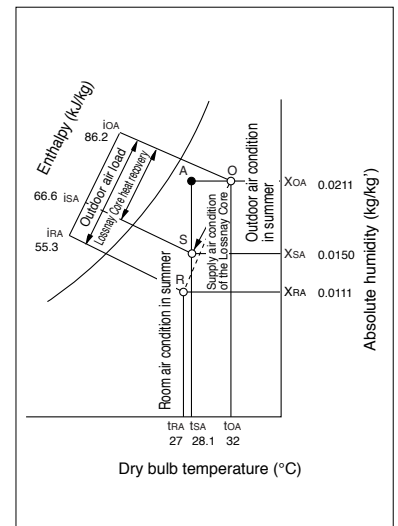

CHAPTER 2 ● Air Conditioning System Design Section

(2) Heating during winter

Conditions:

- Model GUF-100RDH3
- Heat exchange efficiency table (%)
(For winter)
- Ventilation rate: 1,000 m³/h
(Specific gravity of air $\gamma = 1.2 \text{ kg/m}^3$)

	Lossnay	Sensible HRV	Conventional ventilator
Temperature (sensible heat)	79	75	0
Enthalpy (total heat)	70	—	0

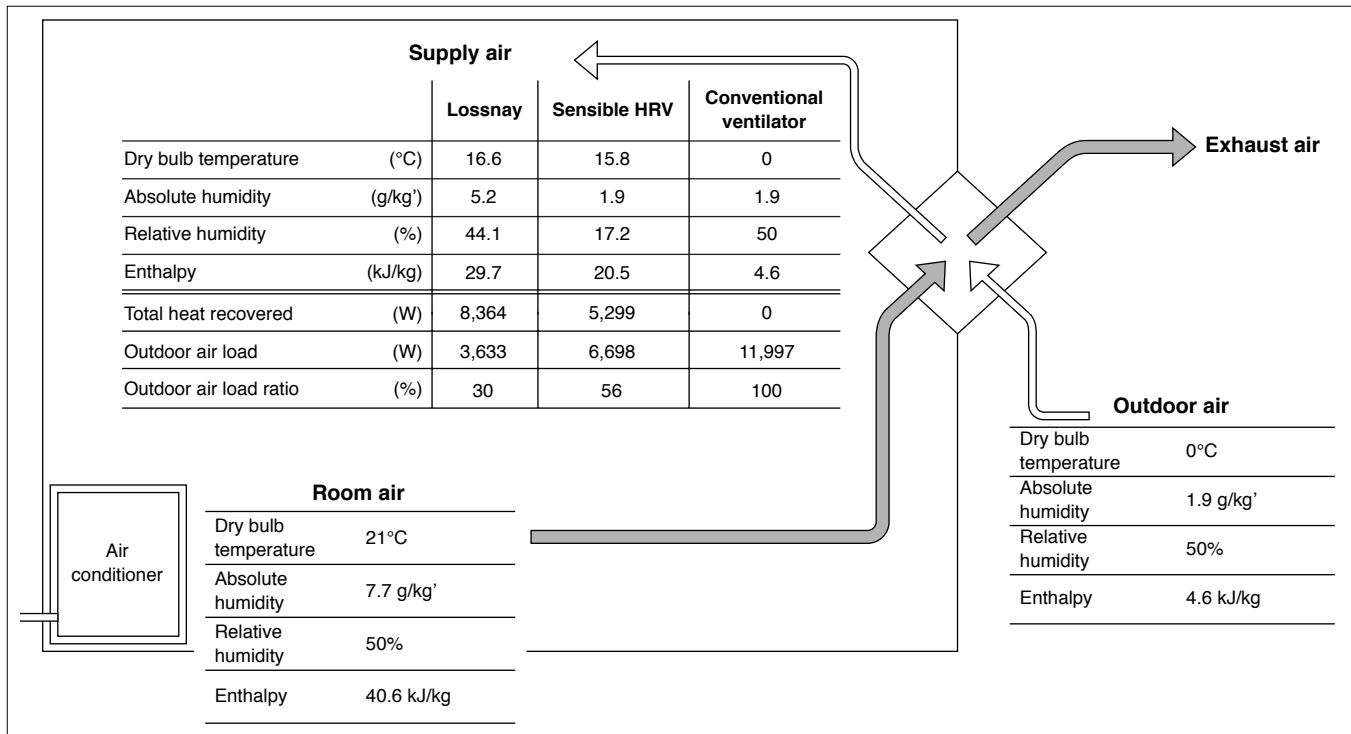

Calculation example

● Lossnay

(Supply air diffuser temperature) $t_{SA} = (21^\circ\text{C} - 0^\circ\text{C}) \times 0.79 + 0^\circ\text{C} = 16.6^\circ\text{C}$

(Supply air diffuser enthalpy) $i_{SA} = (40.6 - 4.6) \times 0.7 + 4.6 = 29.7 \text{ kJ/kg}$

Heat recovered $(29.7 - 4.6) \times 1.2 \times 1,000 \times 0.2777^+ = 8,364 \text{ W}$

Outdoor air load $(40.6 - 29.7) \times 1.2 \times 1,000 \times 0.2777^+ = 3,633 \text{ W}$

● Sensible HRV

(Supply air diffuser temperature) $t_{SA} = (21^\circ\text{C} - 0^\circ\text{C}) \times 0.75 + 0^\circ\text{C} = 15.8^\circ\text{C}$

(Supply air diffuser enthalpy) $i_{SA} = 20.5 \text{ kJ/kg}$
(from psychrometric chart)

Heat recovered $(20.5 - 4.6) \times 1.2 \times 1,000 \times 0.2777^+ = 5,299 \text{ W}$

Outdoor air load $(40.6 - 20.5) \times 1.2 \times 1,000 \times 0.2777^+ = 6,698 \text{ W}$

● Conventional ventilator

If a conventional ventilator is used, the supply air diffuser is the same as the outdoor air and the exhaust is the same as the room air.

Thus the heat recovered is 0 kJ/h and the outdoor air load is

$(40.6 - 4.6) \times 1.2 \times 1,000 \times 0.2777^+ = 11,997 \text{ W}$

⁺ Conversion Factor (1,000 W/3,600 sec.)

Winter conditions

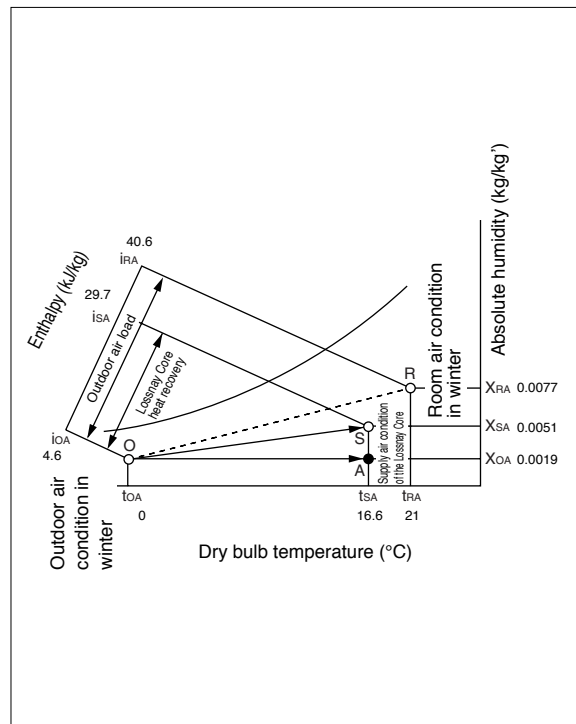

5.5 Psychrometric chart

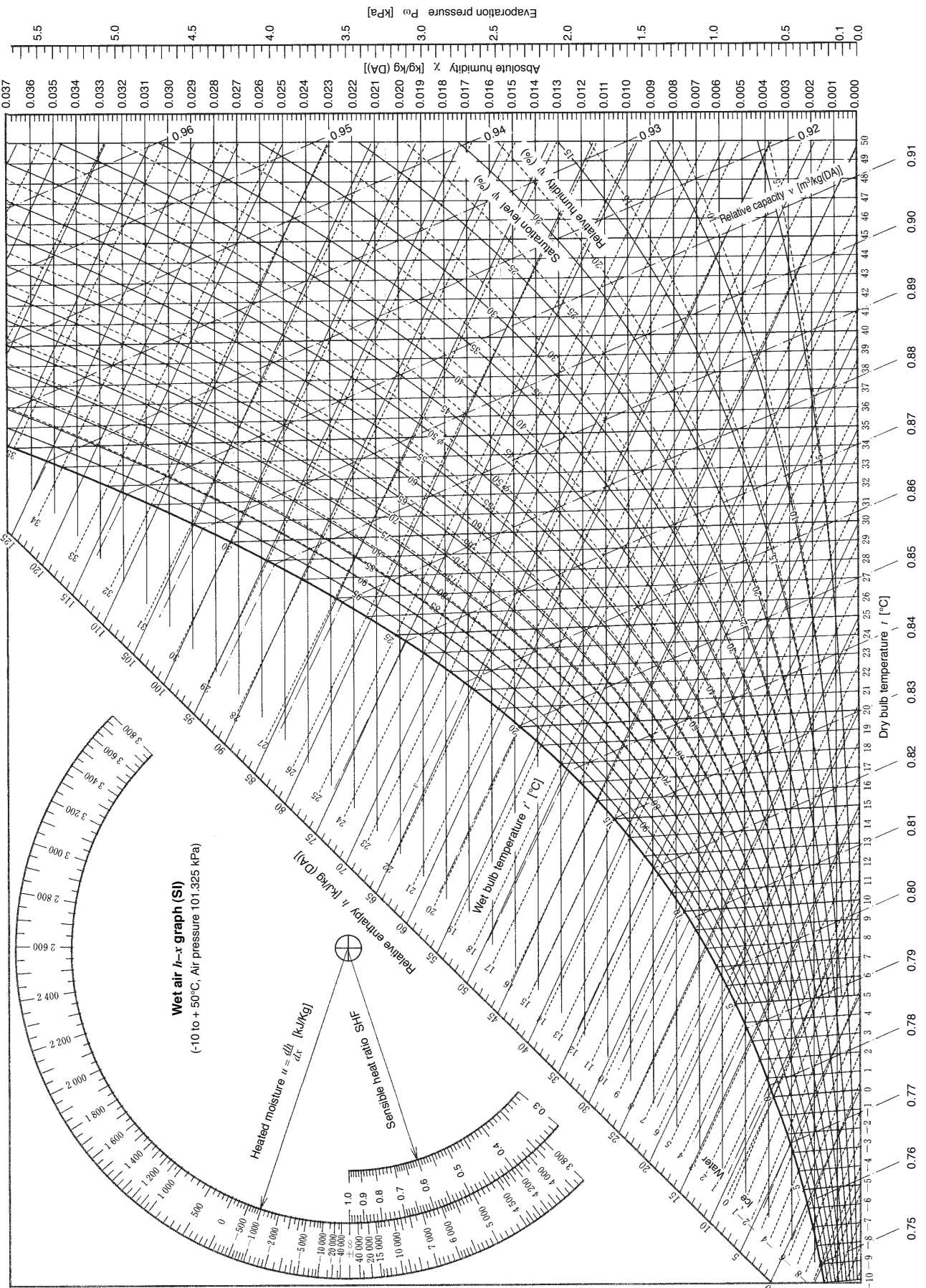

6. Humidifying

6.1 The Need for Humidity

Humidity is an important part of air conditioning, especially when heating. During the winter heating months when outside air is drawn in by the ventilator, the low-temperature, low-humidity (absolute humidity) air is heated by the air conditioning unit and this causes a rapid drop in its relative humidity. (For example, 0°C DB, 50%RH outdoor air is introduced and heated as is to 20°C, causing its relative humidity to drop to 13%RH which causes the number of people complaining of dryness to the eyes and throat to increase.)

There are also problems such as when the temperature of a room with low humidity is raised, but the people in the room still have cold feet. When the relative humidity is 40% or higher. Since this problem can be corrected by not wastefully raising the temperature, humidity can also play a role in saving energy.

(While there are many opinions on what the level of humidity should be for comfort, it is generally believed that 40 to 50%RH relative humidity is suitable for room temperatures of 20 to 24°C. If the humidity is raised higher than this, problems with condensation forming on windows and other areas may occur.)

6.2 Humidity Conditions in Buildings

The humidity conditions in modern buildings is generally quite poor. Even in buildings clearing the building code restrictions with a relative humidity of 40%RH, there are only a few that have good conditions. Buildings with centralized ducts often use spray type humidifiers. With this type of humidifier, the amount of moisture that is dissolved into the air (the amount of effective humidity) is extremely small and as a result the humidity in the room does not rise, making this a serious problem. Moreover, even if humidifiers enabling the air conditioning system to theoretically clear the building codes requirement of 40%RH are incorporated, there are many instances where the following actual causes will change the amount of humidity in a room.

<p>Causes that result in an increase in humidity</p>	<ul style="list-style-type: none"> ● The moisture created by people. In an office at 21°C, the human body generates a latent heat amount of 171.6 kJ/h “ℓ” and the latent heat for water evaporation is 2,499 kJ/kg. Accordingly, a person will create $171.6/2,499 = 0.686$ ℓ/h of water per hour. ● Water heaters and other such equipment create moisture.
<p>Causes that result in a decrease in humidity</p>	<ul style="list-style-type: none"> ● Doors being opened and closed and humidity infiltrating through small openings. ● Absorption of moisture by materials that were abnormally dry at the time of the construction of the building. ● Increased temperature inside the rooms (Lowers relative humidity). ● Large amounts of exhaust air. ● Uneven humidifying by the humidifier in the building or a decline in the amount of humidifying due to deterioration of the efficiency of the humidifier over time. ● If the amount of effective humidity (the amount of moisture dissolved into the air) is low. (For example, there are many types of humidifiers available such as high-pressure spray types, ultrasonic types and evaporation-spray types that could be incorporated into an air conditioning system, but as mentioned earlier, if the moisture they emit condenses on the walls of the duct work or if the droplets are not absorbed into the air, it simply becomes water that goes down the drain and contributes nothing towards humidifying the room.)

6.3 Background of the Permeable Film Type Humidifier

Humidifiers can be classified into two main types: spray types and ultrasonic types. However, all things considered, they are not the best overall.

The humidifier used in the OA processing unit is a permeable film type that uses natural evaporation to provide clean humidifying. Its merits include its low initial cost, low running cost and uncomplicated operating principle. Its demerits of low humidifying performance and short service life have been overcome by dramatically increasing the evaporating surface of the water without changing the size of the humidifier itself. This is an epoch-making humidifier.

6.4 Comparison of Humidifying Methods

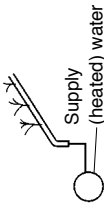
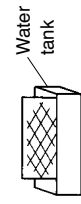
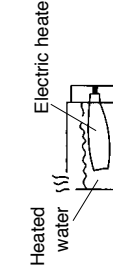
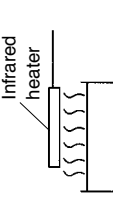
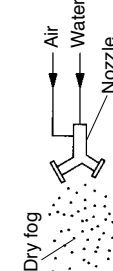
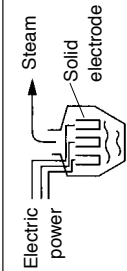
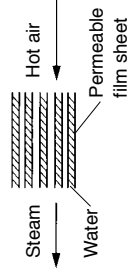
Type	Operating principle	Humidifying performance (ℓ/h)	Humidifying efficiency	Responsiveness (Controllability)	Service life	Cost (5 ℓ/h)	Power consumption (at 5 ℓ/h) kW	Maintenance items	Running costs (Index)	Problem areas
Ultrasonic type		0.4 - 18	Medium to high	Immediate	5,000 h Medium Vibrator	High (130,000)	0.305	Clean oscillator element every season. Replace oscillator element every 5,000 h.	Low to medium	White exhaust countermeasures
High-pressure spray type		2.5 - 300	Low	Immediate	Long	Low (30,000)	0.07	Replace nozzle every season.	Low	Low humidifying efficiency. Countermeasures for leakage.
Natural evaporation		0.2 - 1.0	High	Somewhat slow (Self controlling)	1,250 h Short Evaporator board	Low (70,000)	0.01 or less	Clean water tank every season. Replace evaporator board every season.	Low	Low humidifying efficiency. Short humidifying element service life.
Pan shape		0.4 - 35	High	Somewhat slow	Short	Low (70,000)	4.0	Clean water tank every season. Replace main body every 2 to 3 seasons.	High	Countermeasures against scum.
Infrared type		2.0 - 9.0	High	Immediate	5,000 h Medium Infrared heater	High (300,000)	5.0	Clean water tank every 3 months. Replace heater every 5,000 h.	High	Improving maintainability. High cost.
Dual flow nozzle type		1 - 18	Medium to high	Immediate	Long	High (150,000)	0.75	Replace nozzle every season.	Medium	Improved air pressure and water pressure controllability. Requires air compressor.
Electrode type		0.5 - 78	High	Immediate	3,000 h Short to medium Electrode plates	High (500,000)	5.8	Clean cylinder every 2 years. Replace electrode plates every 3 years.	High	Improve maintainability. High cost.
Permeable film type		0.2 - 4.8	High	Somewhat slow (Self controlling)	12,500 h or more (Hard water) Long	Special	0.01 or less	Replace element every 10 years. (Hard water)	Low	

Note: Service life is defined as performance up to 80% of the initial performance.

7. Humidifying Effect of the OA Processing Unit

The humidity recovered by the Lossnay Element and the humidity added by the permeable type humidifier provide a humidifying effect that is sufficiently more than the humidity lost in exhaust.

- Conditions:
- Model GUF-50RDH3
 - Ventilation 500 m³/h
(Relative air volume $\gamma = 1.2$ kg/m³)
 - Outdoor unit PUHY-P200YGM-A
In addition to OA processing, all indoor units are connected for a total of 100%.

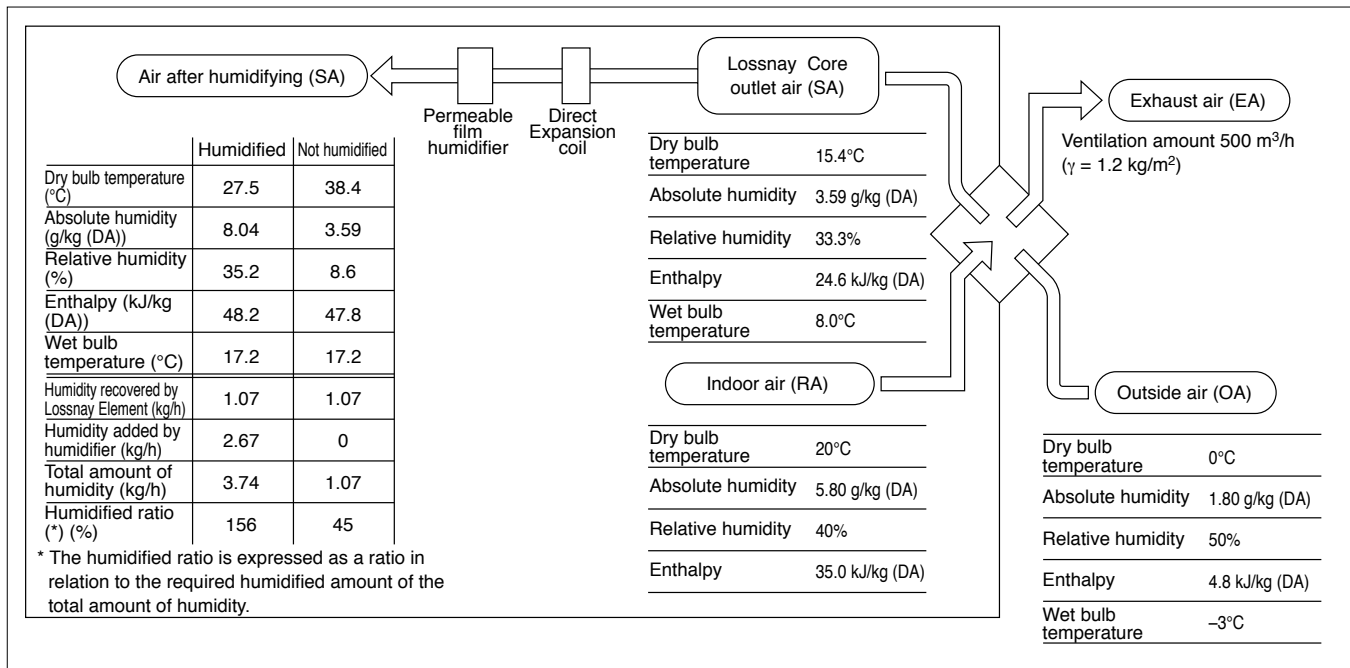

Method of Calculation

(1) Finding the air conditions after heating by direct expansion coil

- Calculate the direct expansion coil performance.
Use the correction graph (Refer to page 73) to find the correction coefficient of 0.92 when the outdoor wet bulb temperature is -3°C and the indoor temperature is 20°C. From this, the performance of the direct expansion coil of the OA processing unit is as follows.

$$(6.42 - 2.25) \times 0.92 = 3.84 \text{ kW}$$

- Calculate the air conditions after leaving the direct expansion coil.
Assuming the fixed pressure ratio of the air is 1.0.
There is a temperature increase of 23.0°C. $(3.84/1.0) / (1.2 \times 500/3,600) = 23.0^\circ\text{C}$
Due to this temperature increase, the temperature of the air leaving the expansion coil is 38.4°C.
 $(15.4 + 23.0 = 38.4^\circ\text{C})$

Since there is no change in absolute humidity from the heating, the absolute humidity leaving the expansion coil is 3.59 g/kg (DA). The rest is taken from the psychrometric chart.

$$38.4^\circ\text{C} \quad 8.6\% \quad \chi = 3.59 \text{ g/kg (DA)} \quad i = 47.8 \text{ kJ/kg (DA)} \quad \text{WB} = 17.2^\circ\text{C}$$

(2) Finding the amount of humidity added by a permeable film humidifier

1) To find the amount of humidity added by the humidifier, there is a need to correct the rated humidification on the characteristics chart using the amount of air flow and the air conditions at the direct expansion coil outlet.

- Air flow volume correction: In this case, since the rated air flow is the same as the processed air volume, the correction coefficient (K1) from Graph 1 will be 1.0.

Graph 1 Air volume change correction

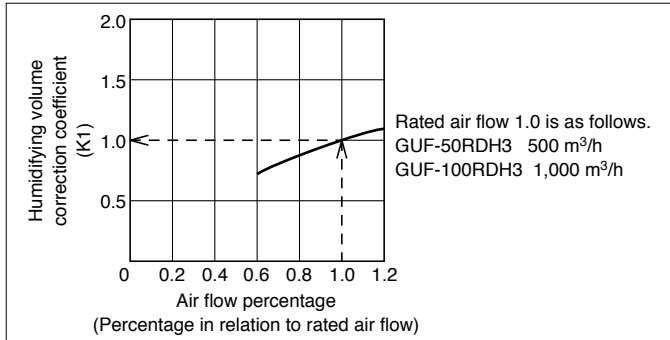

- Percentage in relation to rated air flow = processing air flow / rated air flow
- The rated air flow is the air flow for the highest speed setting on the characteristics chart for a given model.
Example: GUF-50RDH3 500 m³/h

- Air flow volume correction: This is calculated using the difference between dry bulb and wet bulb temperatures of the direct expansion coil outlet air. In this case, the dry bulb temperature minus the wet bulb temperature is $38.4 - 17.2 = 21.2^\circ\text{C}$. From Graph 2 it can be seen that the correction coefficient (K2) is 0.99.

Graph 2 Correction graph for heated and humidified Lossnay Core air conditions

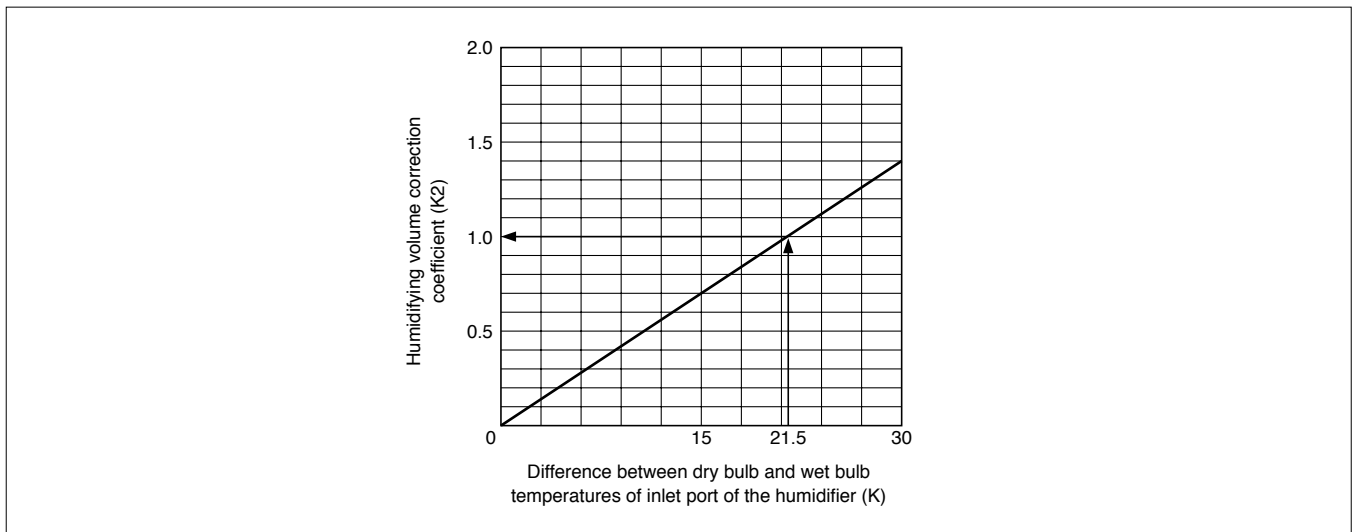

The humidified amount found is a correction of the rated humidified amount using the above graph, so the following formula is used for calculation.

$$\text{Humidified amount} = \text{Rated humidified value} \times K1 \times K2 = 2.7 \times 1 \times 0.99 = 2.67 \text{ kg/h}$$

CHAPTER 2 ● Air Conditioning System Design Section

2) Method for calculating humidified air conditions

The following is the formula for finding the absolute humidity of humidified air from the amount of humidifying in section 1).

- Absolute humidity of humidified air = Absolute humidity at Lossnay Core outlet +
(Amount of humidifying × 1,000) ÷ (Air density (g) × Processed air amount) (g/kg (DA))

$$3.59 + (2.67 \times 1,000)/(1.2 \times 500) = 8.04 \text{ (g/kg (DA))}$$

- If natural evaporation is used, under normal temperatures, a relatively equal wet bulb temperature line can be predicted. Accordingly, the air condition sought will be the intersecting point on the psychrometric chart for the even wet bulb temperature line for the direct expansion coil outlet (17.2°C) and the absolute humidity of humidified air.

$$27.5^\circ\text{C} \quad 35.2\% \quad \chi = 8.04 \text{ g/kg (DA)} \quad i = 48.2 \text{ kJ/kg (DA)} \quad \text{WB} = 17.2^\circ\text{C}$$

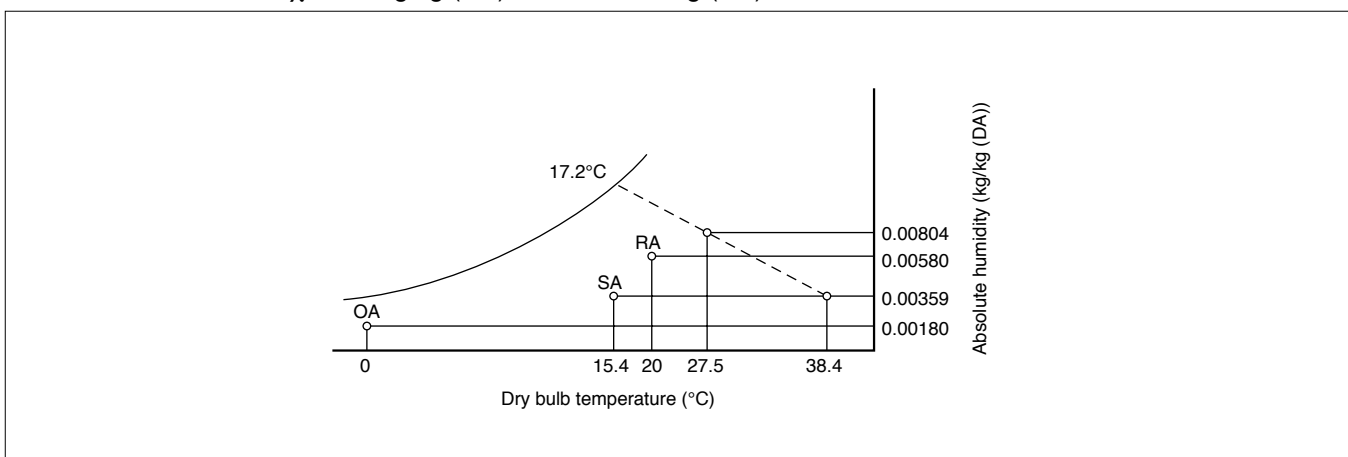

3) Required amount of humidifying and amount of recovered humidity (Recovery ratio)

- The required amount of humidifying is the amount of humidity added to give both the outside air and the inside air the same amount of absolute humidity.

$$\begin{aligned} \text{Required amount humidifying} &= \text{Air density } (\gamma) \times \text{Processed air amount} \times \\ &(\text{Indoor absolute temperature} - \text{Outdoor absolute humidity})/1,000 \text{ } \ell / \text{h (kg/h)} \\ &= 1.2 \times 500 \times (5.8 - 1.8)/1,000 = 2.40 \text{ } \ell / \text{h (kg/h)} \end{aligned}$$

- The amount of humidity recovered is the amount of absolute humidity, in relation to the outside air, contained in the air after humidifying. Accordingly, the following formula is used.

$$\begin{aligned} \text{Amount of humidity recovered} &= \text{Air density } (\gamma) \times \text{Processed air amount} \times \\ &(\text{Absolute humidity after humidifying} - \text{Outdoor absolute humidity})/1,000 \text{ } \ell / \text{h (kg/h)} \\ &= 1.2 \times 500 \times (8.04 - 1.80)/1,000 = 3.74 \text{ kg/h} \end{aligned}$$

- The recovery ratio is the amount of recovered humidity/required amount of humidifying.

$$3.74/2.40 \times 100 = 156\%$$

8. Water Quality and Service Life of Humidifier

8.1 Water Quality Required by Water Supplied to Humidifier

The water supplied to a humidifier should satisfy the following conditions.

- It should be neutral (pH 5.8 to 8.6).
- There should be 100 mg/ℓ or less of residual material after evaporation.
- If the level of residual material after evaporation is high, use a water purifier to adjust the water quality.

8.2 Service Life of Permeable Film Humidifier

The service life of a permeable film humidifier is determined by the amount of accumulation of the residual material in the supply water after evaporation. Results of tests show that the service life of a permeable film humidifier is about five years (6,250 hours) when the water quality has residual material after evaporation of 100 mg/ℓ. The humidifier has reached the end of its service life when the amount of humidification declines to 80% of its initial amount.

The reason the amount of humidification is reduced over time is due to the residual material after evaporation in the supply water that accumulates on the inside of the permeable film and gradually covers its surface.

8.3 Relationship between Water Quality and Service Life

The service life of a permeable film humidifier is dependent upon the density of the residual material after evaporation.

When residual material after evaporation is 200 mg/ℓ, the service life is approximately 2.5 years.

When residual material after evaporation is 400 mg/ℓ, the service life is approximately 1.25 years.

Moreover, if the amount of residual material after evaporation is exceptionally high, the accumulation of it could cause damage the permeable film or cause other such secondary effects. Therefore, water with a high levels of residual material after evaporation cannot offer any positive effect to a permeable film humidifier.

8.4 Water Purifiers

8.4.1 Effect of water purifiers

Even clear, colorless tap water or well water contains components that cannot be seen with the naked eye. The most common of these microscopic components are the “hardness components” of calcium and magnesium. Water that contains a large amount of these hardness components is called hard water and, conversely, water that contains a small amount of these components is called soft water. A water purifier is used to remove calcium and magnesium etc. from the water.

If hard water is used as is, it will cause a build up known as scaling which will reduce flow efficiency and shorten the service life of the equipment. For these reasons, a water purifier should always be used.

8.4.2 Types of water purifiers and their operating principles

The following chart summarizes the representative types of water purifiers.

	Operating principle	Features	Comments
Reverse osmosis permeable film type	Filters the ions from of the supply water.	In principle, provides effective removal of impurities.	Requires water pressure. Low flow volume.
Ion exchange type	Combination of positive and negative ion exchange plastic.	Higher water flow volume than conventional water purifiers.	Must be maintained to ensure effectiveness.

8.4.3 Difference between a water purifier and a water softener

Do not confuse a water purifier and a water softener.

A water softener is a device that softens the water by replacing the calcium, magnesium, and nitrium with sodium, but does not remove impurities from the water.

A water purifier, as its name implies, removes all chemical impurities from the water in order to provide pure water (H₂O).

Piping system incorporating a water purifier (Reference)

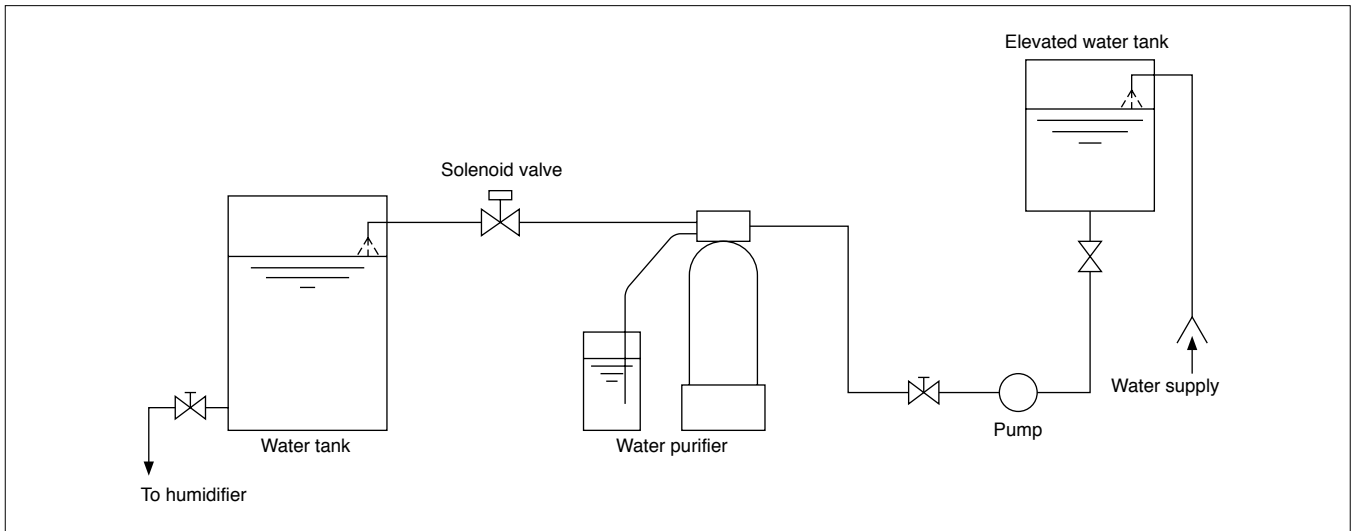

8.4.4 Recommended specifications of water purifiers

Reverse Osmosis water purifier is strongly recommended to keep acceptable water quality.

The following are one of the recommended specifications, “Cillit-Mini Osmosi MO Series” manufactured by Cillichemie.

Specifications

Model	Water treatment flow volume m (ℓ /h)					
	3.6 bar		6 bar		9 bar	
	25°C	15°C	25°C	15°C	25°C	15°C
Cillit-Mini Osmosi MO I	4	2.6	5.5	4.2	8.8	6.4
Cillit-Mini Osmosi MO II	5.8	4.4	9.5	7.1	14	10.5
Cillit-Mini Osmosi MO III	8	6.2	13	10.8	19	14.5
Cillit-Mini Osmosi MO IV	19	14.2	30	25	50	38

GUF-50RDH3 (2.7 ℓ /h)

GUF-100RDH3 (5.4 ℓ /h)

Note: Water treatment cannot be performed when pressure is less that 3.6 bar.

9. Dust Removal

9.1 Necessity of Filters

Clean air is necessary for humans to live a comfortable and healthy life. Besides atmospheric pollution that has been generated with the development of modern industries and the growth in the use of automobiles, air pollution in sealed rooms has progressed to the point where it adversely affects the human body, and is now a major problem.

Hay fever is most common in the spring and demands for preventing pollen from entering rooms are increasing.

9.2 Data Regarding Dust

The particle diameter of dust and applicable range of filters are shown in Table 1, and representative data regarding outdoor air dust concentrations and indoor dust concentrations is shown in Table 2.

Table 1 Aerosol particle diameters and applicable ranges of various filters

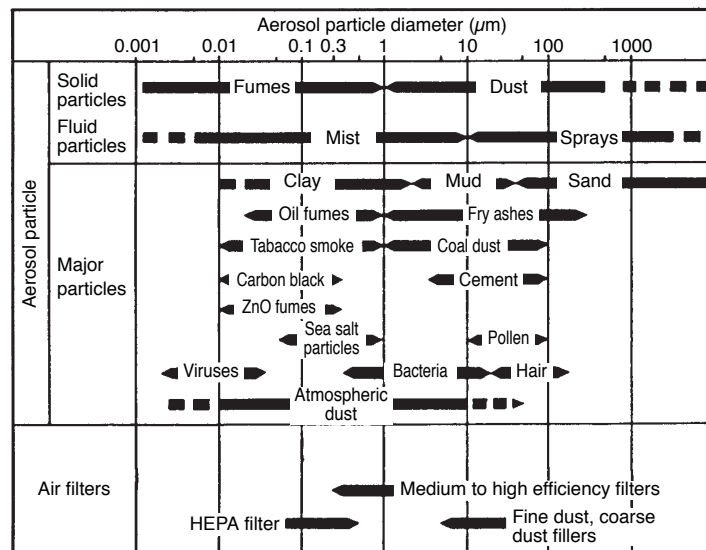

Table 2 Major dust concentrations

Type	Reference data	
Outdoor air floating dust concentration	Large city	0.1 - 0.15 mg/m ³
	Small city	0.1 mg/m ³ or less
	Industrial districts	0.2 mg/m ³ or more
Indoor dust concentration	General office	10 mg/h per person
	Stores (product vending stores)	5 mg/h per person
	Applications with no tobacco smoke	5 mg/h per person

Remarks:

- The core diameter of outdoor air dust is said to be 2.1 μm.
- Dust in office rooms is largely caused by smoking, and the core diameter is 0.72 μm. The 14 types of dust (average 0.8 μm) as set by JIS Z 8901 as performance test particles are employed.
- The core diameter of dust generated in rooms where there is no smoking is approximately the same as outdoor air.
- Smoking in general offices (as per Japan):
 - Percentage of smokers : Approx. 70% (adult men)
 - Average number of cigarettes : Approx. 1/person·h (including non-smokers)
 - Smoking length of cigarette : Approx. 4 cm
 - Amount of dust generated by one cigarette : Approx. 10 mg/cigarette

9.3 Comparison of Dust Collection Efficiency Measurement Methods

The gravitational, colorimetric and counting methods used for measuring dust collection efficiency each have differing features and must be used according to the application of the filter.

Test method	Test dust	Inward flow dust measurement method	Outward flow dust measurement method	Efficiency indication method	Type of applicable filters
AFI Gravitational method	Synthetic: • Dust on standard road in Arizona: 72% • K-1 carbon black: 25% • No.7 cotton lint: 3%	Dust weight measured beforehand	• Filter passage air volume measured • Weigh the dust remaining on the filter and compare	Gravitational ratio	Synthetic dust filters
NBS Colorimetric method	Atmospheric dust	Degree of contamination of white filter paper	Degree of contamination of white filter paper	Comparison of contamination of reduction in degree of contamination	Electrostatic dust percentage of (for air conditioning)
DOP Counting method	Diameter of dioctyl-phthate small drop particles: 0.3 μm	Electrical counting measurement using light aimed at DOP	Same as left	Counting ratio	Absolute filter and same type of high efficiency filter
ASHRAE Gravitational method	Synthetic: • Regulated air cleaner fine particles: 72% • Morocco Black: 23% • Cotton linter: 5%	Dust weight measured beforehand	• Filter passage air volume measured • Weigh the dust remaining on the filter and compare	Gravitational ratio	Pre-filter Filter for air conditioning (for coarse dust)
ASHRAE Colorimetric method	Atmospheric dust	Degree of contamination of white filter paper	Degree of contamination of white filter paper	Comparison of percentage of reduction in degree of contamination	Filter for air conditioning (for fine dust) Electrostatic dust collector
Air filter test for air conditioning set by Japan Air Cleaning Assoc. (Colorimetric test)	JIS 11 types of dust	Degree of contamination of white filter paper	Degree of contamination of white filter paper	Comparison of percentage of reduction in degree of contamination	Filter for air conditioning
Pre-filter test set by Japan Air Cleaning Assoc. (Gravitational test)	JIS 8 types of dust	Dust weight measured beforehand.	• Filter passage air volume measured • Weigh the dust remaining on the filter and compare.	Gravitational ratio	Pre-filter
Electrostatic air cleaning device test set by Japan Air Cleaning Assoc. (Colorimetric test)	JIS 11 types of dust	Degree of contamination of white filter paper	Degree of contamination of white filter paper	Comparison of percentage of reduction in degree of contamination	Electrostatic dust collector

Gravitational method

This method is used for air filters which remove coarse dust (10 μm or more). The measurement method is determined by the gravitational ratio of the dust amount on the in-flow side and out-flow sides.

$$\text{Dust collection ratio} = \frac{\text{In-flow side dust amount} - \text{Out-flow side dust amount}}{\text{In-flow side dust amount}} \times 100 (\%)$$

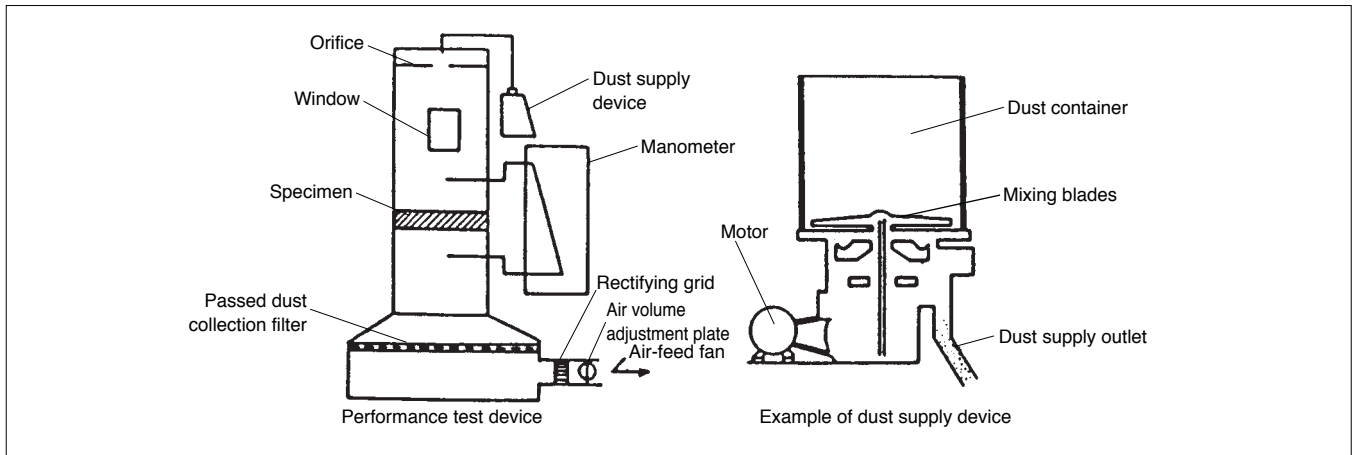

Colorimetric method

The in-flow side air and out-flow side air are sampled with a suction pump and passed through filtering paper. The sampled air is adjusted so that the degree of contamination on both filter papers is the same, and the results are determined by the sampled air volume ratios on both sides.

$$\text{Dust collection ratio} = \frac{\text{Out-flow side sampling amount} - \text{In-flow side sampling amount}}{\text{Out-flow side sampling amount}} \times 100 (\%)$$

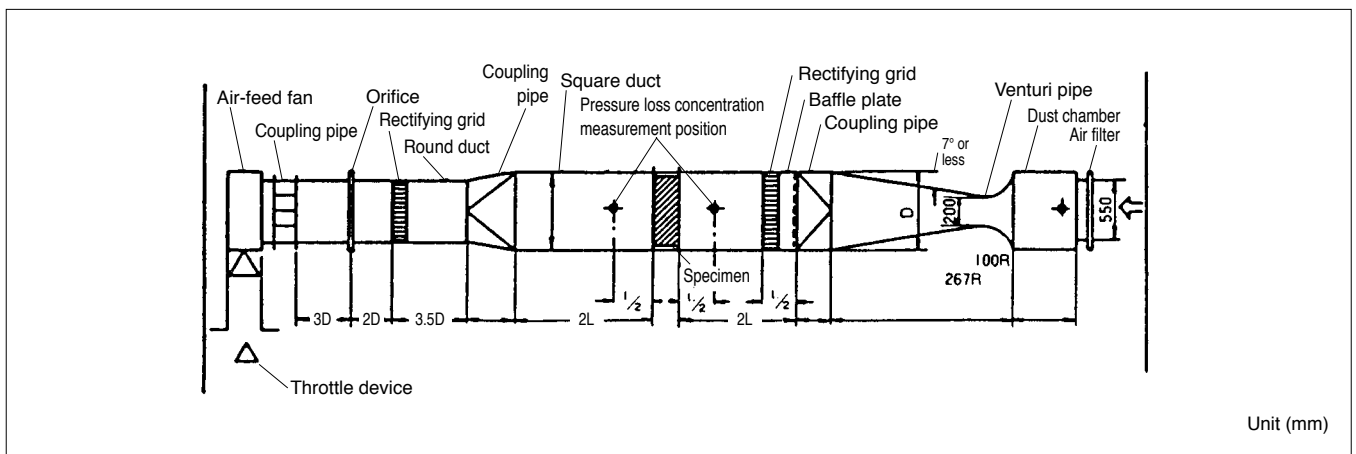

9.4 Calculating Dust Density

The following is an air conditioning system using an OA processing unit.

Dust density detection

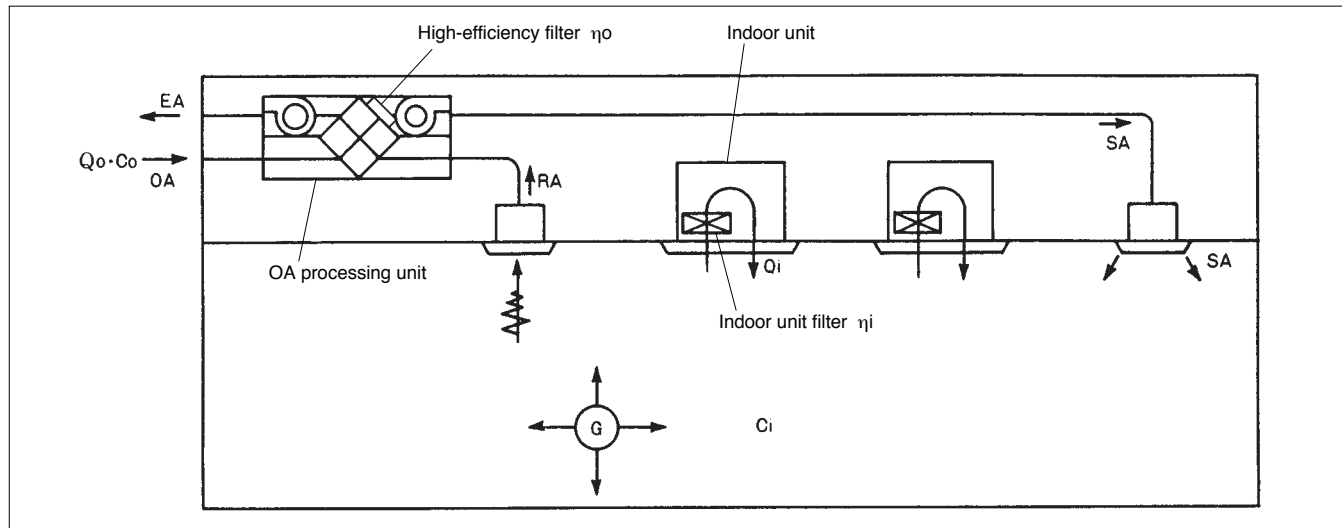

Q_o : Outdoor air intake amount (m^3/h) η_o : High-efficiency filter dust removal ratio (%) (Colorimetric method) C_o : Outside air airborne dust density (mg/m^3)
 Q_i : Indoor unit air flow amount (m^3/h) η_i : Indoor unit filter dust removal ratio (%) (Colorimetric method) C_i : Indoor dust density (mg/m^3)
 (Total air flow amount for indoor unit) G : Amount of dust generated indoors (mg/h)

In a system such as this where the performance of each component is already known and the indoor dust density is being sought, there may be times when the indoor filter performance is calculated for use as the allocated value for indoor dust density. In such cases, the following formula is used.

$$C_i = \frac{G + C_o Q_o (1 - \eta_o)}{Q_o + Q_i \eta_i}$$

$$\eta_i = \frac{G + C_o Q_o (1 - \eta_o) - C_i Q_o}{C_i Q_i} \times 100$$

Example of calculation

In the illustration above, the indoor dust density for the following design conditions is found as follows.

Outline of air conditioning

Air conditioning area	Number of people in room	Amount of outdoor air used	Cooling capacity	Heating capacity
100 m^3 (Office)	20 people	25 m^3/h -people \times 20 people = 500 m^3/h	14.18 W	15.84 W

Unit used

OA processing unit	Model	Cooling capacity	Heating capacity	Outdoor air amount	Filter efficiency
	GUF-50RDH3 + High-efficiency filter PZ-50RFM 1 unit	5.18 kW	5.84 kW	500 m^3/h	65% (Colorimetric method)
Indoor unit	Model	Cooling performance	Heating performance	Air flow volume	Filter efficiency
	PLFY-P40VKM-A + High-efficiency filter PAC-SE13KF-E 2 units	4.5 kW	5.0 kW	15 m^3/min	65% (Colorimetric method)

Calculation	Outdoor air intake amount	$Q_o = 500 \text{ m}^3/\text{h}$
	Indoor unit air flow amount	$Q_i = 15 \times 2 \times 60 = 1,800 \text{ m}^3/\text{h}$
	High-efficiency filter – dust removal ratio	$\eta_o = 65\%$ ($\eta_o' = 67\%$ Particle diameter $2.1 \mu\text{m}^*$)
	Indoor unit filter – dust removal ratio	$\eta_i = 65\%$ ($\eta_i' = 57\%$ Particle diameter $0.72 \mu\text{m}^*$)
	Outside air airborne dust density	$C_o = 0.1 \text{ mg}/\text{m}^3$
	Amount of dust generated indoors	$G = \text{Amount of dust created per person} \times \text{Number of people in room}$ $= 10 \text{ mg}/\text{h}\cdot\text{person} \times 20 \text{ people} = 200 \text{ mg}/\text{h}$

From the above, the following shows the calculation for indoor dust density C_i .

$$C_i = \frac{200 + 0.1 \times 500 (1 - 0.65)}{500 + 1,800 \times 0.65} \cong 0.130 \text{ mg}/\text{m}^3 (\cong 0.142 \text{ mg}/\text{m}^3^*)$$

The result clears the dust density of $0.15 \text{ mg}/\text{m}^3$ set by building codes and other such ordinances. Conversely, the dust removal ratio for the indoor filter for attaining the indoor dust density C_i of $0.15 \text{ mg}/\text{m}^3$ is calculated as follows.

$$\eta_i = \left\{ \frac{200 + 0.1 \times 500 (1 - 0.65) - 0.15 \times 500}{0.15 \times 1,800} \right\} \times 100 \cong 52.7\% (\cong 52.4\%^*)$$

This shows that a filter for the indoor unit with a minimum dust removal ratio of 52.7% (Colorimetric method) is required.

* The result of a calculation using an average outdoor airborne particle diameter of $2.1 \mu\text{m}$ and an average indoor airborne particle diameter of $0.72 \mu\text{m}$ is shown.

10. Sound

Sound is emitted when any object is excited causing it to vibrate. The object that vibrates is called the sound source, and the energy that is generated at the source is transmitted through the air to the human ear. Humans can hear the sound only when the ear drum vibrates.

10.1 Sound level and auditory perception

Sound level is the sound wave energy that passes through a unit area in a unit time, and is expressed in dB (decibel) units.

The sound heard by the human ear differs according to the strength of the sound and the frequency, and the relation to the pure tone sound is as shown on the right. The vertical line shows the strength of the sound and the horizontal line shows the frequency. For frequencies between 20 Hz to 15,000 Hz which can be felt by the human ear, the strength of sound that can be felt that is equivalent to a 1,000 Hz sound is obtained for each frequency. The point where these points cross is the sound level curve, and a sound pressure level numerical value of 1,000 Hz is expressed. These are called units of phons. For example, the point on the 60 curve is perceived as 60 phons.

- On average, the human senses a sound that is less than 1,000 Hz as rather weak, and a sound between 2,000 to 5,000 Hz as strong.

ISO audio perception curve

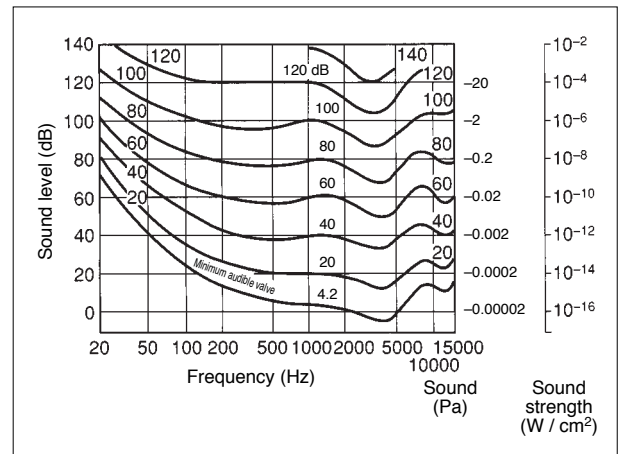

10.2 How to measure sound levels

A sound level meter (JIS C 1502, IEC 651) is used to measure sound levels. This sound level meter has three characteristics (A, B and C characteristics) as shown on the right. These represent various sound wave characteristics. Generally, the A characteristic, which is the most similar to the human ear, is used.

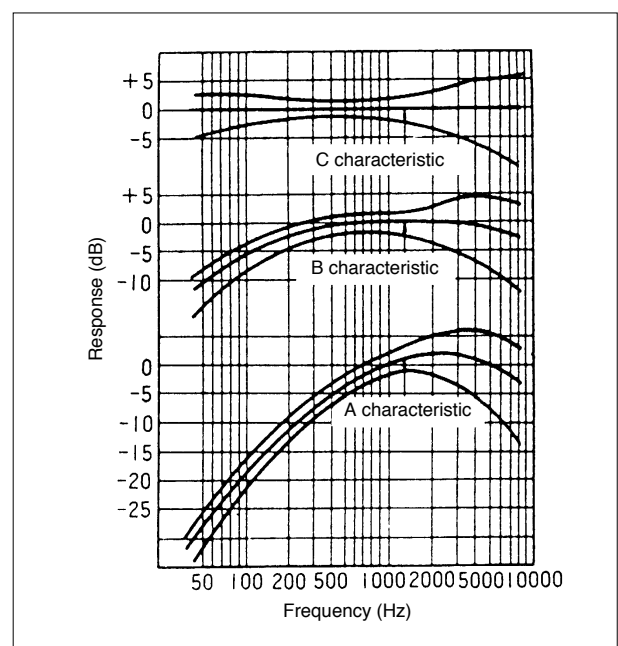

10.3 Frequency analysis of sound

It is said that the human ear senses differently according to the frequency. However, the sound generated from a vibration is not limited to one frequency, but instead, various frequencies are generated at differing levels. This is expressed by the NC curve, which is determined according to the difficulty of hearing a conversation.

- Even if the sound is a very low level, it is annoying if a specific frequency is emitted very loudly. These sounds are suppressed to a minimum during product design stages, but, the sound may become very disturbing with resonance of the ceiling, wall, etc.

Example Continuous frequency analysis

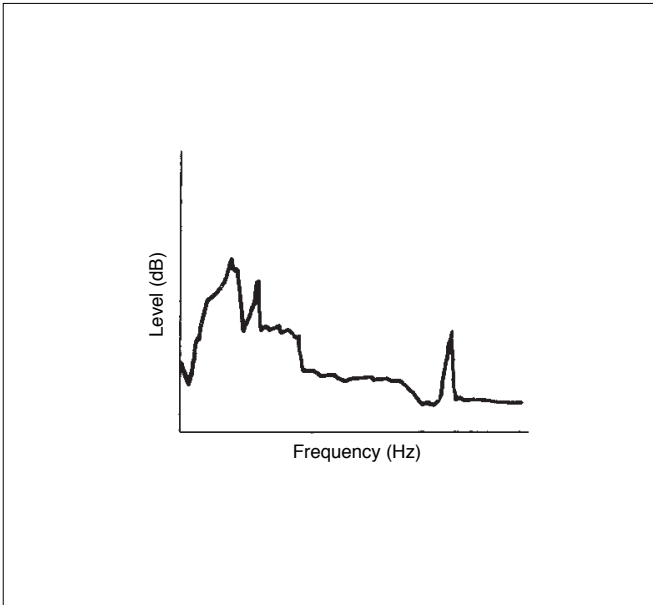

NC curve

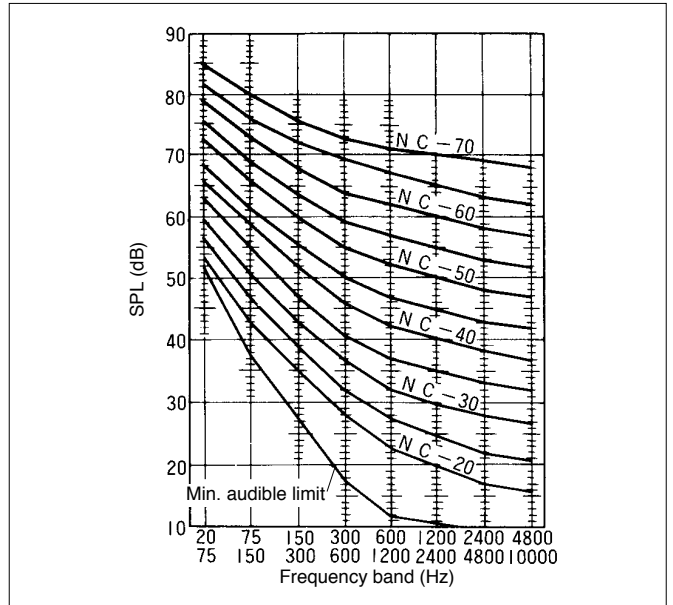

● **Tolerable noise levels and NC values according to room application**

Room application	dB	NC value	Room application	dB	NC value
Broadcasting studio	25	15 - 20	Cinema	40	30
Music hall	30	20	Hospital	35	30
Theatre (approx. 500 seats)	35	20 - 25	Library	40	30
Classroom	40	25	Small office	45	30 - 35
Conference room	40	25	Restaurant	50	45
Apartment	40	25 - 30	Gymnasium	55	50
Hotel	40	25 - 30	Large conference room	50	45
Housing (room)	40	25 - 30	Factory	70	50 or more

10.4 Indoor noise

(1) Principle of indoor noise

1) Power levels

The Power level (PWL) of the sound source must be understood when considering noise effects. The following formula is used to obtain PWL from the measured sound pressure data (values noted in catalog) in an anechoic chamber.

$$PWL = SPL_o + 20 \log r_o + 11 \text{ [dB]} \dots\dots\dots(I)$$

PWL : Sound source power level (dB)
 SPL_o : Measured sound pressure in anechoic chamber (dB)
 r_o : Measurement distance (m)

2) Principal model

Consider the room shown in Figs. 1 and 2.

- Fig. 1 shows an example of the integrated main unit and supply air diffuser (and return grille).
- Fig. 2 shows an example of a separated main unit and supply air diffuser (and return grille).
- (a) is the direct sound from the supply air diffuser (return grille) and (b) is the echo sound. (c) ((c1) to (c3)) is the direct sound that is emitted from the main unit and duct and passes through the finished ceiling and leaks. (d) is the echo sound of (c).

3) Setting of noise

- The following formula is used to obtain the noise value at a position in the room.

$$SPL \text{ [dB]} = PWL + 10 \log \left\{ \underbrace{\frac{Q}{4\pi r^2}}_{(i)} + \underbrace{\frac{4}{R}}_{(ii)} \right\} \dots\dots\dots(II)$$

- SPL : Sound pressure level at reception point [dB]
 PWL : Sound source power level [dB]
 Q : Directivity factor (Refer to Fig. 3)
 r : Distance from sound source [m]
 R : Room constant [$R = \bar{\alpha}S / (1 - \bar{\alpha})$]
 $\bar{\alpha}$: Average sound absorption ratio in room (Normally, 0.1 to 0.2)
 S : Total surface area in room [m²]

Fig. 1

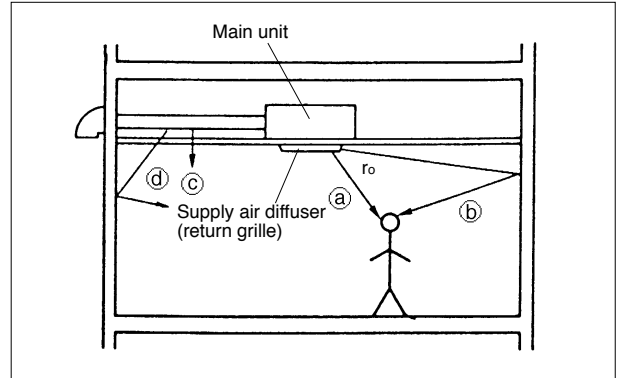

Fig. 2

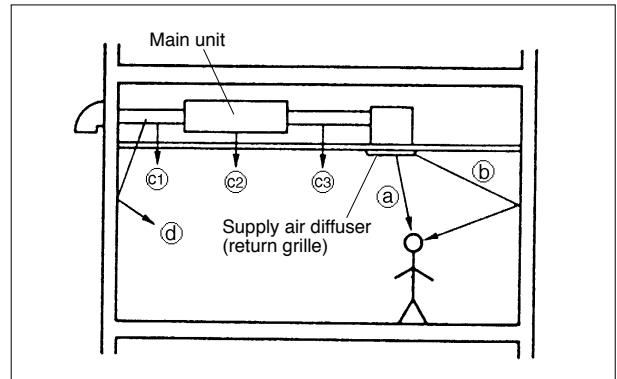
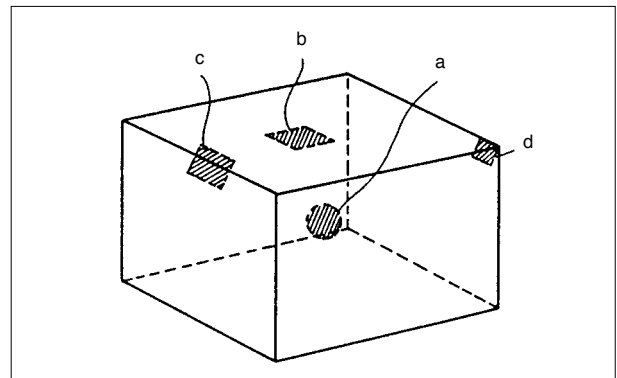

Fig. 3 (Sound source position and directivity factor Q)



	Sound source position	Q
a	Centre of room	1
b	Centre of ceiling	2
c	Edge	4
d	Corner	8

- For the supply air diffuser (and return grille) in Fig. 2, PWL must be corrected for the noise alternation provided by the duct work (TL) such that:

$$PWL' = PWL - TL$$

- Item (i) in formula (II) is the direct sound (Ⓐ, Ⓒ), and (ii) is the echo sound (Ⓑ, Ⓓ).
- The number of sound sources in the room (main unit, supply air diffuser, return grille etc.) is obtained by calculating formula (II), and combining the number with formula (III).

$$SPL = 10 \log (10^{SPL_1/10} + 10^{SPL_2/10}) \dots\dots\dots(III)$$

- The average sound absorption rate in the room and the ceiling transmission loss differ according to the frequency, so formula (II) is calculated for each frequency band, and is combined with formula (III) for an accurate value.

Transmission loss in ceiling material (dB)

Example

Material () indicates thickness (mm)	Plaster board (7)	Plaster board (9)	Lauan plywood (12)
Average	20	22	23
Frequency band (Hz)	125	10	20
	250	11	21
	500	19	21
	1,000	26	28
	2,000	34	35
4,000	42	39	—

(2) Avoiding noise disturbance from OA processing unit

- 1) When unit air passage behind ceiling is sound source (Fig. 1 Ⓒ, Ⓓ, Fig. 2 Ⓒ1 to Ⓒ3, Ⓓ)

(A) Avoid the following types of design when disturbing noise may be emitted from large units. (Refer to Fig. 4)

- a) Sudden contraction of duct diameter (Ex. $\varnothing 250 \rightarrow \varnothing 150$, $\varnothing 200 \rightarrow \varnothing 100$)
- b) Sudden curves in aluminum flexible ducts, etc. (Especially right after unit outlet)
- c) Opening in ceiling plates
- d) Suspension on weak material

(B) The following countermeasures should be taken. (Refer to Fig. 5)

- a) Use ceiling material with high soundproofing properties (high transmission loss). (Care is required for low frequency components as the difference in material is great).
- b) Addition of soundproofing material to areas below sound source. (The entire surface must be covered when using soundproofing sheets. Note, that in some cases, covering of the area around the unit may not be possible due to the heat generated from the unit.)

Fig. 4

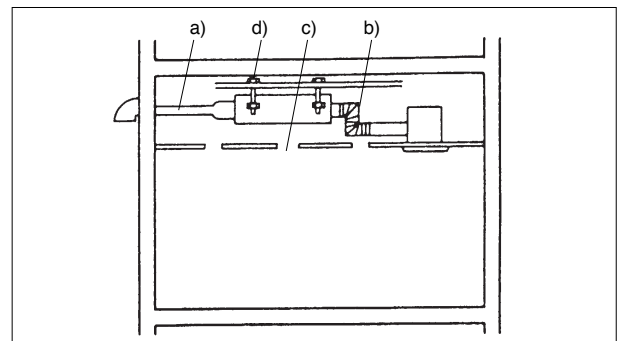
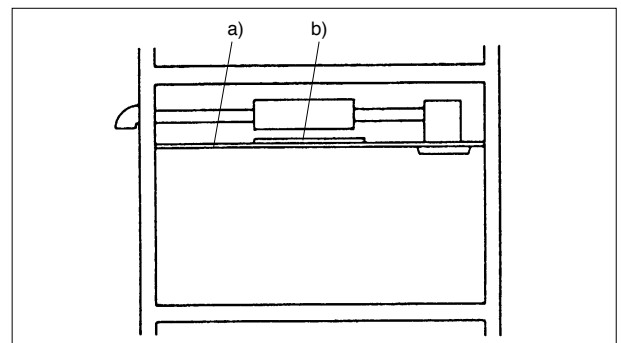

Fig. 5



2) When supply air diffuser (and return grille) is sound source
 part 1

(A) If the main unit is separated from the supply air diffuser (and return grille) as shown in Fig. 6, the use of a silencer box a), silence duct b) or silence grille c) is recommended.

Fig. 6

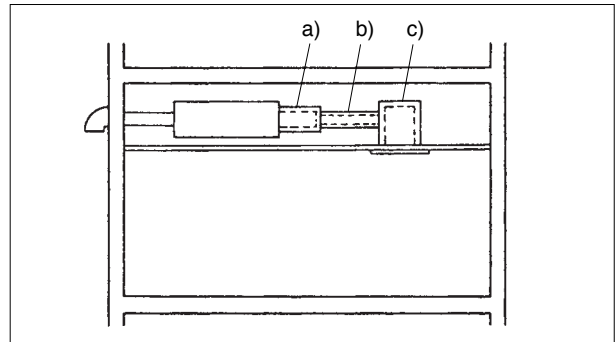

(B) If a draft sound is being emitted from the supply air diffuser (and return grille), branch the flow as shown in Fig. 7 a), lower the flow velocity with a grille, and add a silencer duct to section b).
 (If the length is the same, a silencer duct with the small diameter is more effective.)

Fig. 7

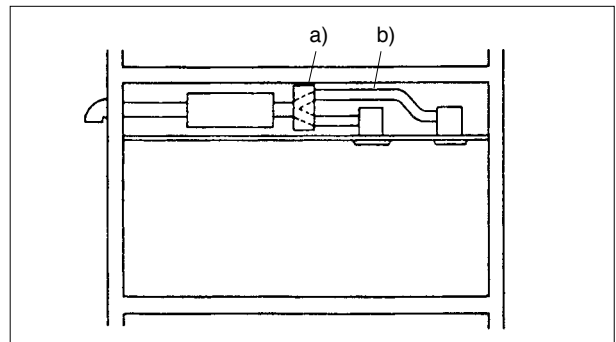

3) When supply air diffuser (and return grille) is sound source
 part 2

(A) If the main unit and supply air diffuser (and return grille) are integrated as shown in Fig. 8, or if the measures taken in 2) a) and b) are inadequate, the interior material in the room can be changed to that having a high sound absorbency as shown in Fig. 8 a).
 This is not, however, very effective towards direct sounds.

Fig. 8

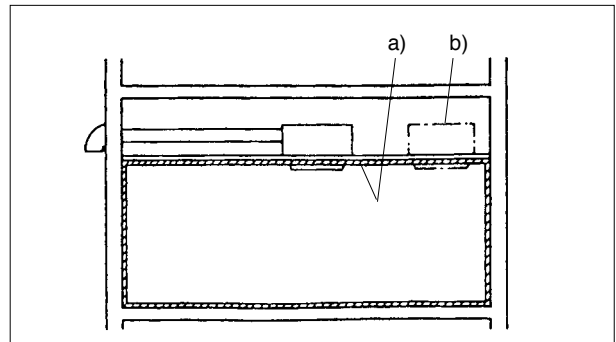

(B) Installing the sound source in the corner of the room as shown in Fig. 8 b) is effective towards the center of the room, but will be inadequate towards people in the corner of the room.

11. Precautions when Using

11.1 OA Processing Unit Usage Conditions

Model	Installation conditions for main unit	Supply air diffuser conditions	Exhaust air conditions
GUF-50RDH3 GUF-100RDH3 *1 *2 GUF-50RD3 GUF-100RD3	0°C to +40°C, relative humidity of 80% or less	-15°C to +40°C, relative humidity of 80% or less	-10°C to +40°C, relative humidity of 80% or less

Note: *1 However, this for a room in a common residential building and with conditions for air conditioning temperature and humidity. Accordingly, if an item with a large temperature difference such as a large refrigerator is used, this model cannot be used even if it falls within the values shown above.

*2 Depending on the usage conditions of the outdoor unit, there may be cases when it may not be capable of using an supply air diffuser to -15°C. Therefore, always check the usage conditions of the outdoor unit.

11.1.1 Use in cold climates (outdoor temperature: -5°C or less)

Plot the OA processing unit intake air conditions A and B on a psychrometric chart as shown on the right. If the high temperature side air B intersects the saturation curve such as at C, moisture condensation or frosting will occur on the Lossnay Core. In this case, the low temperature side air A should be preheated to the temperature indicated by point A' so that point C shifts to the point C'.

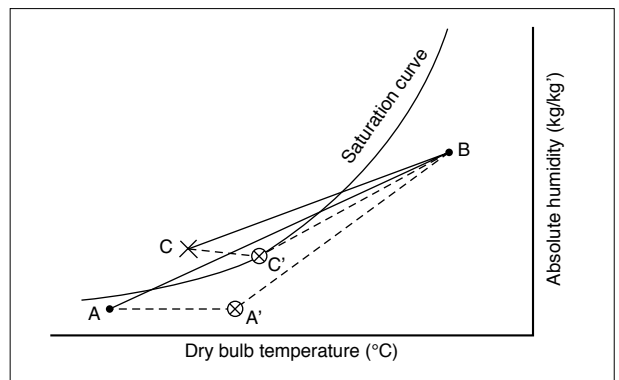

11.1.2 Use in other special conditions

- The OA processing unit cannot be used where toxic gases and corrosive elements such as acids, alkalis, organic solvents, oil mist or paints exist.
- Use where heat is recovered from odor-laden air and supplied to another place (area) is not possible.
- Avoid use where salt or hot water damage may occur.
- Pre-heating is necessary if using the system in a cold climate (locations where winter temperatures are below -15°C).

11.2 Noise Value of OA Processing Unit

The noise level specified for OA processing units is as that measured in an anechoic chamber. The sound level may increase according to the installation construction material, and room contents.

When using the OA processing unit in a quiet room, it is recommended that measures such as installing a muffling duct.

Note: Please consult with nearest OA processing unit supplier about availability of these parts.

11.3 Duct Design

- Always treat the two ducts on the outdoor side (outdoor air intake and exhaust outlet) with insulation to prevent frosting or condensation.
- Always install heat insulation to prevent condensation on the supply air diffuser duct (system section material) as well. (Heating and humidifying units only.)
- The outdoor duct gradient must be 1/30 or more (to wall side) to prevent rain water from infiltrating the system.
- Do not use the standard vent caps or round hoods where they may come into direct contact with rain water.

11.4 OA Processing Unit with Humidifier

- In areas where freezing is anticipated, take steps to prevent the water supply pipes from freezing.
- Always provide a gradient of 1/100 or more for the drain pipe.
- Take steps to prevent condensation on the water supply and drain pipes.
- Makes sure that the water supply to the humidifier is 40°C or less.

11.5 Transmission Rate of Various Gases and Related Maximum Workplace Concentration

Measurement conditions	Gas name	Air volume ratio Q _{SA} /Q _{RA}	Exhaust air concentration C _{RA} (ppm)	Supply air diffuser concentration C _{SA} (ppm)	Transmission rate (%)	Max. workplace concentrations (ppm)
Exhaust air t = 24°C	Hydrogen fluoride	1.0	36	<0.5	-0	0.6
	Hydrogen chloride	1.0	42	<0.5	-0	5
	Nitric acid	1.0	20	<0.5	-0	10
Supply air t = 30°C Measurement method • Gas detection pipe for HF, HCl, HNO ₃ • Chemical analysis with colorimetric method for H ₂ SO ₄ • Gas chromatography for organic solvents, etc. The fans are positioned at the supply air exhaust suction positions of the element	Sulfuric acid	1.0	2.6 mg/m ³	-0 mg/m ³	-0	0.25
	Trichlene	1.0	85.1	3.7	4.3	200
	Acetone	1.0	3.3	0.15	4.5	1,000
		1.5	20.4	0.54	2.6	
	Xylene	0.5	5.9	0.14	2.4	150
		1.0	5.9	0.5	8.5	
	Isopropyl alcohol	1.5	4.9	0.48	9.8	400
		0.5	38.4	0.17	0.4	
	Methanol	1.0	44.7	2.0	4.5	200
		1.5	31.0	2.6	8.4	
	Ethanol	1.0	34.4	1.5	4.4	1,000
		1.0	32.7	1.6	4.9	
		0.5	3.3	0	0	
	Ethyl acetate alcohol	1.0	21.7	0.83	3.8	400
		1.5	26.3	1.39	5.3	
1.0		75.0	21	28		
Ammonia	1.0	75.0	21	28	50	
Hydrogen sulfide	1.0	1.5	0.1	6.7	10	
Carbon monoxide	1.0	50	0.5	1		
Carbon dioxide	1.0	5,000	100	2		
Smoke	1.0			1 - 2		
Formaldehyde	1.0	0.5	0.01	2	0.08	

11.6 Solubility of Odors and Toxic Gases, etc., in Water and Effect on Lossnay Core

Main generation site	Gas name	Molecular formula	Gas vapour mist	Non-toxic/ toxic/ odor	Sulubility in water		Max. workplace concentration	*Useability of Lossnay Core
					ml/ml	g/100g		
Chemical plantor chemical laboratory	Sulfuric acid	H ₂ SO ₄	Mist	Found		2,380	0.25	×
	Nitric acid	HNO ₃	Mist	Found		180	10	×
	Phosphoric acid	H ₃ PO ₄	Mist	Found		41	0.1	×
	Acetic acid	CH ₃ COOH	Mist	Bad odor		2,115	25	×
	Hydrogen chloride	HCl	Gas	Found	427	58	5	×
	Hydrogen fluoride	HF	Gas	Found		90	0.6	×
	Sulfur dioxide	SO ₂	Gas	Found	32.8		0.25	△
	Hydrogen sulfide	H ₂ S	Gas	Found	2.3		10	△
	Ammonia	NH ₃	Gas	Bad odor	635	40	50	×
	Phosphine	PH ₃	Gas	Found	0.26		0.1	○
	Methanol	CH ₃ OH	Vapor	Found	Soluble		200	△
	Ethanol	CH ₃ CH ₂ OH	Vapor	Found	Soluble		1,000	△
	Ketone		Vapor	Found	Soluble		1,000	△
Toilet	Skatole	C ₉ H ₉ N	Gas	Bad odor	Minute			○
	Ammonia	NH ₃	Gas	Bad odor	635	40	50	×
	Indole	C ₉ H ₇ N	Gas	Bad odor	Minute			○
Others	Nitric monoxide	NO			0.0043		50	○
	Ozone	O ₃				0.00139	0.1	○
	Methane	CH ₄			0.0301			○
	Chlorine	Cl ₂			Minute		0.5	○
Air (reference)	Air	Mixed gases	Gas	None	0.0167			○
	Oxygen	O ₂	Gas	None	0.0283			○
	Nitrogen	N ₂	Gas	None	0.0143			○
	Carbon monoxide	CO	Gas	Found	0.0214			○
	Carbon dioxide	CO ₂	Gas	None	0.759			○

Note: ● Water soluble gases and mists cannot be used because the amount that is transmitted with the water is too great.

● Acidic gases and mists cannot be used because these will accumulate in the element and cause damage.

+ ○ : OK

△ : Caution should be used

× : Should not be used

CHAPTER 3
Control System
Design Section

1. System Selection

Interlocked with indoor units

OA processing unit fan operation when indoor unit is stopped	<input type="radio"/>
OA processing unit stopping when indoor unit is operated	<input type="radio"/>
Switching OA processing unit fan speed	<input type="radio"/>
Ventilation mode	Auto
Humidifier (Only GUF-50/100RDH3)	Auto (When heating)
Filter maintenance indicator (Optional setting)	<input type="radio"/>
OA processing unit error indicator	<input type="radio"/>
The sum of indoor units setting for one OA processing unit	16 units max
The sum of interlocked OA processing units setting for one indoor unit	1 unit

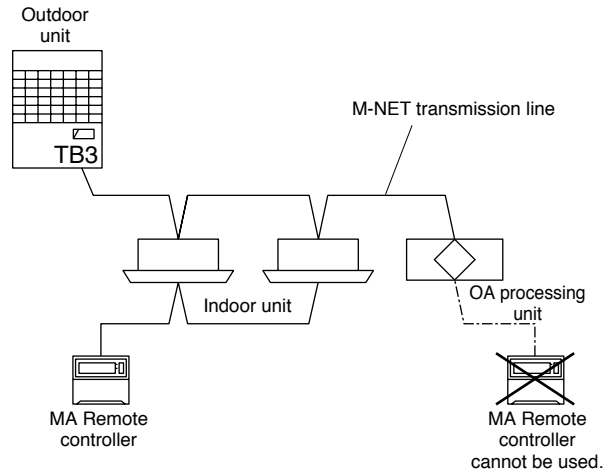

Non-interlocked OA processing units

Start/Stop	<input type="radio"/>
Fan speed switching	<input type="radio"/>
Ventilation mode	Auto
Humidifier (Only GUF-50/100RDH3)	Auto (When heating)
Filter maintenance indicator (Optional setting)	<input type="radio"/>
OA processing unit error indicator	<input type="radio"/>
The sum of OA processing unit registering in one group	16 units max
The sum of remote controllers and centralized controllers registering to one OA processing unit	5 units max (Note) unit

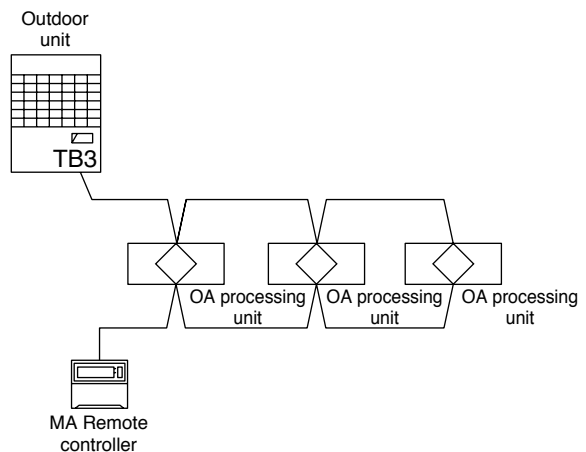

Note: Number of local remote controller is 2 units max.

⚠ Caution

- The addresses of the entire system are set automatically so make sure the address of each unit is initially set at 00 (setting at time of delivery).
- When indoor units are not interlocked with OA processing units switch the setting to IC mode (DIP-SW3-1 to ON).
- When connecting two MA Remote controllers the same group be sure to set one as the sub-remote.
- You cannot use both M-NET remotes and MA Remote controllers with OA processing units in the same group.
- You cannot connect more than three Remote controllers to OA processing units in the same group.

Connecting MA Remote controller and OA Processing Units

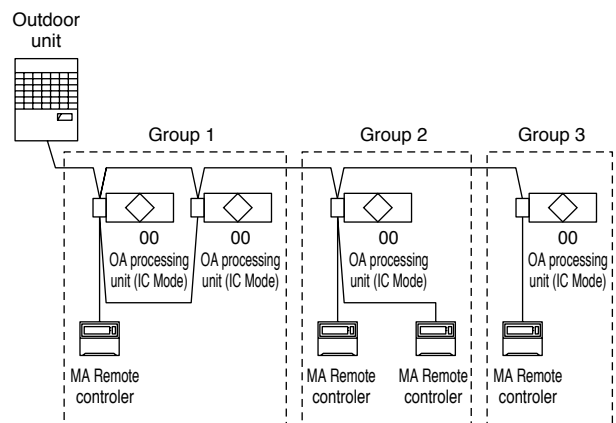

- Group 1 : Multiple OA processing units (IC mode) only.
- Group 2 : One OA processing unit (IC) and two Remote controllers.
- Group 3 : One OA processing unit (IC) only.

Central controller system

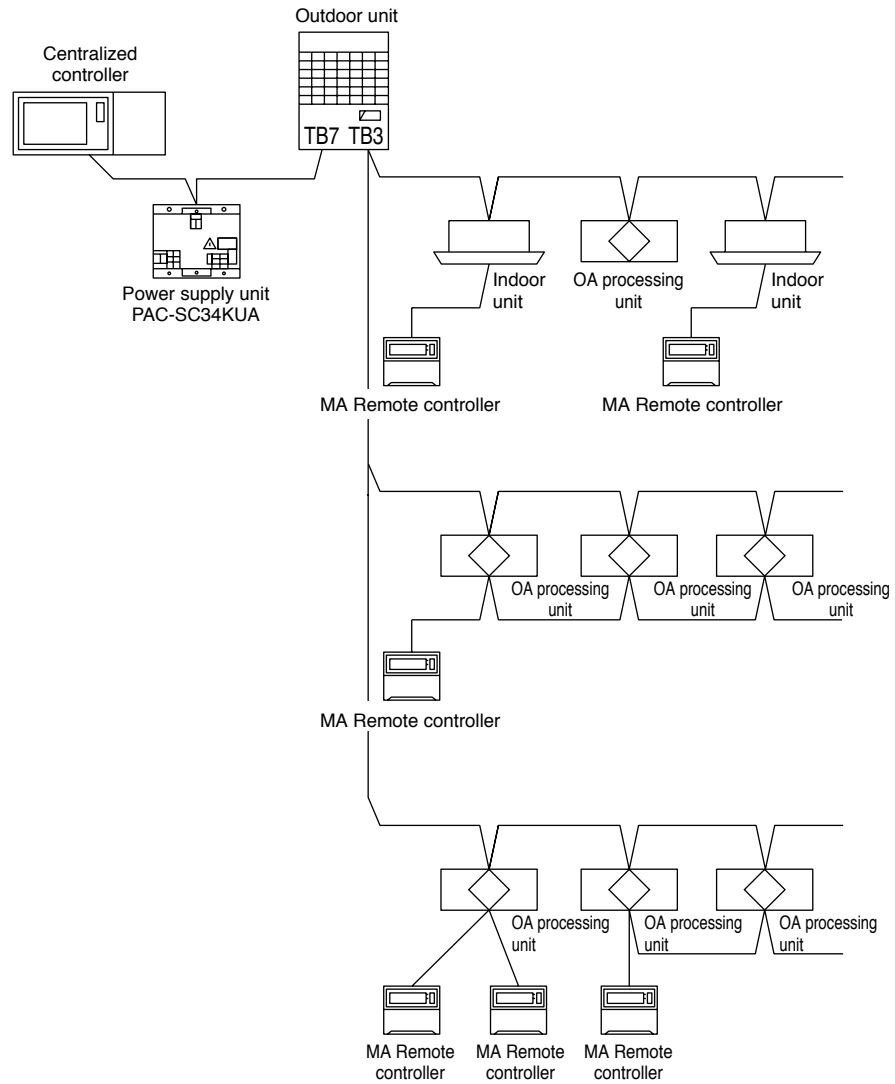

1.1 System Designs. Example 1

Indoor units and OA processing unit interlocked system

Features

- Interlocked operation with indoor units is possible.
- Can also perform independent OA processing unit operations using M/ME Remote controller.

System examples

The following groups can be configured.

Single refrigerant system

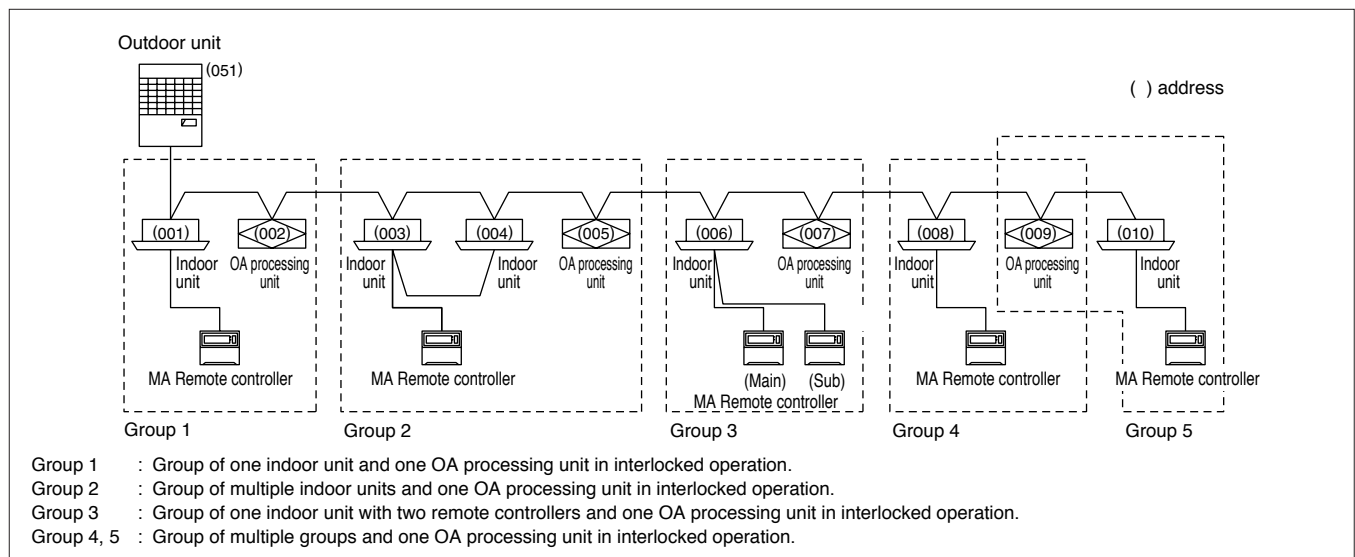

Multiple refrigerant system

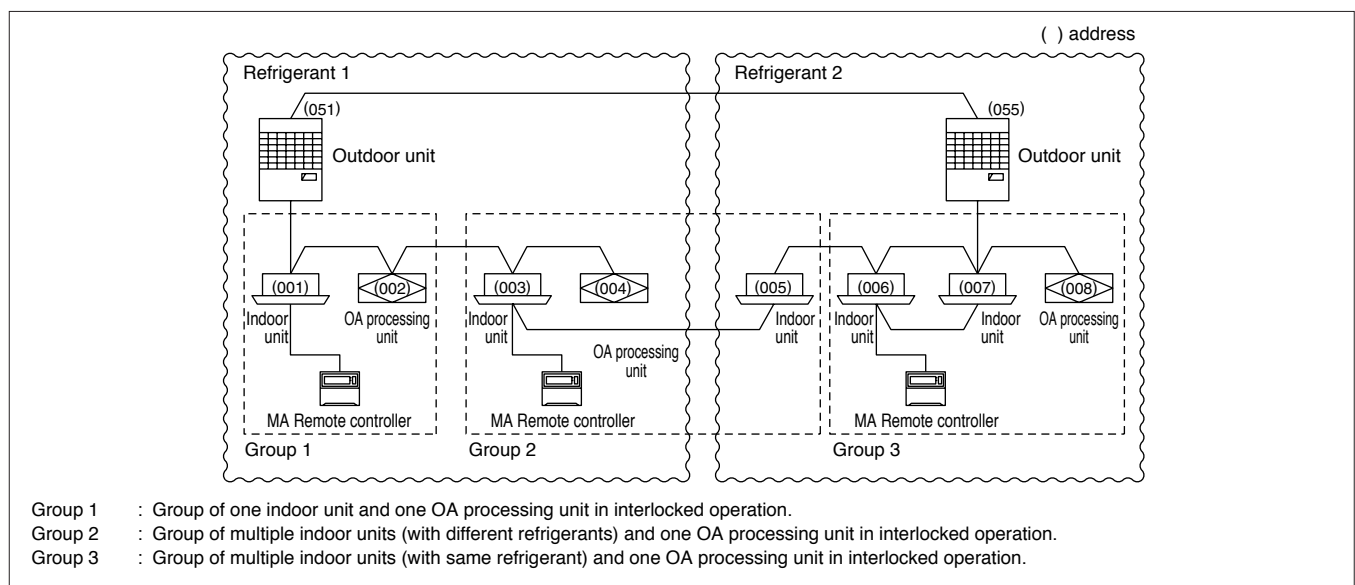

OA Processing unit function table (Interlocked settings)

Item	Details
The sum of indoor units setting for one OA processing unit	16 units max
The sum of interlocked OA processing units setting for one indoor unit	1 unit
Independent Start/Stop of ventilation (OA processing unit)	Possible
Fan speed switching	High/Low
Ventilation mode switching	Auto
Humidifier switching (Only GUF-50/100RDH3)	Possible (When indoor unit is heating)
Operation mode switching	Heat/Cool/Fan (Follows the operation mode of indoor unit)
Filter maintenance indicator (Optional setting)	3,000 h/1,500 h/4,500 h/No display
Error	Display
Restrictions and precautions	<ul style="list-style-type: none"> To operate OA processing units and indoor units by interlocking, it is necessary to perform interlock setting from a remote controller. OA processing unit cannot be interlocked to another one. OA processing units set to group registration (non-interlocked) cannot be interlocked setting. When the OA processing unit is interlocked setting, set the OA processing unit DIP switch 3-1 to off. The OA processing unit will operate in the same mode as the synchronized indoor unit (heat, cool and fan). (The OA processing unit will be cool when the indoor unit is operated in dry mode.) To connect two MA Remote controllers to the same group, set one MA Remote controller as a sub-remote controller. MA Remote controllers and other local remote controllers cannot be used together in the same group.

Controller function table especially regarded to the OA processing unit

Model	Local remote			MELANS Series			
	MA Remote controller	ME Remote controller	Simple remote controller	Group remote controller	System remote controller	Centralized controller	Centralized controller
	PAR-20MAA	PAR-F27MEA	PAC-SE51CRA or PAC-YT51CRA	PAC-SC30GRA	PAC-SF41SCA	MJ-103MTRA or G-50A	MJ-180A
No. of controllable (Groups/Units)	1 Group/16 Units	1 Group/16 Units	1 Group/16 Units	8 Groups/16 Units	32 Groups/50 Units	50 Groups/50 Units	100 Groups/100 Units 200 Groups/200 Units
Operation	Start/Stop	○	○	○	◎	◎	◎
	Fan speed switching	○	○	×	○	×	○
	Ventilation mode switching	×	×	×	×	×	×
	Humidifier switching (Only GUF-50/100RDH3)	○*1	○*1	○*1	◎*1	◎*1	◎*1
	Operation mode switching	○*2	○*2	×	◎*2	◎*2	◎*2
	Temperature setting	○*3	○*3	○*3	◎*3	◎*3	◎*3
	Priority instructions. Local permitted/Prohibited	×	×	×	×	◎	◎
Monitoring	Status (Operation/Stop)	○	○	×	◎	◎	×
	Fan speed switching	○	○	×	○	×	○
	Ventilation mode	×	×	×	×	×	×
	Humidifier (Only GUF-50/100RDH3)	×	×	×	×	×	×
	Operation mode	○	○	○	○	○	○
	Setting temperature	○*3	○*3	○*3	○*3	○*3	○*3
	Error	○	○	○	○	○	○
	Error contents	○	○	○	○	○	○
	Filter sign	○	○	×	○	○	○
Local permitted/Prohibited	○	○	○	○	○	○	
Scheduling/Recording	Weekly	×	×	×	×	○	○
	Stop/Starts per day	2	2	×	×	3	6
	Stop/Starts per week	×	×	×	×	21	42
	Minumum setting (minutes)	10	10	×	×	10	1
	Error record	×	×	×	○	×	○

Switched & display ◎ : Group/Batch ○ : Group only (or function available) × : Not available

- Note:**
- *1 When indoor unit is heating, interlocked OA processing unit is operating humidifier.
 - *2 The OA processing unit will operate in the same mode as the synchronized indoor unit (heat, cool and fan). (The OA processing unit will be cool when the indoor unit is operated in dry mode.)
When using with multiple indoor units that are set differently, the OA processing unit will operate in the mode with priority of: heat, cool and fan.
 - *3 In the case of GUF-50/100RDH3, temperature setting in heat mode is set at the OA processing unit DIP switch.
 - *4 When the "Heating" is displayed on the controller, the humidifier is also operating.

1.2 System Designs. Example 2

Non-interlocked OA processing unit system with remote controller

Features

- Local remote controller can operate and monitor each group of OA processing units.

System example

The following groups can be configured.

Single refrigerant system

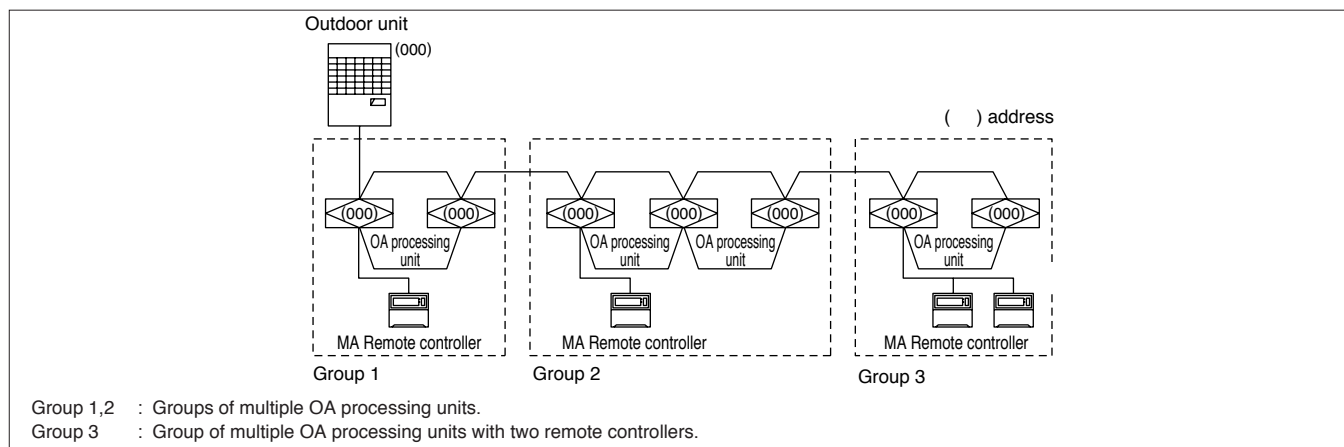

Note: On OA processing unit for a non-interlocked OA processing unit group, set DIP switch 3-1 (synchronous air conditioning switch) to on.

Address setting is not required for a single refrigerant system (only when no M-NET remote controllers and MELANS are used).

(Keep the factory set address (000) for both the outdoor unit and the OA processing units.)

Multiple refrigerant system

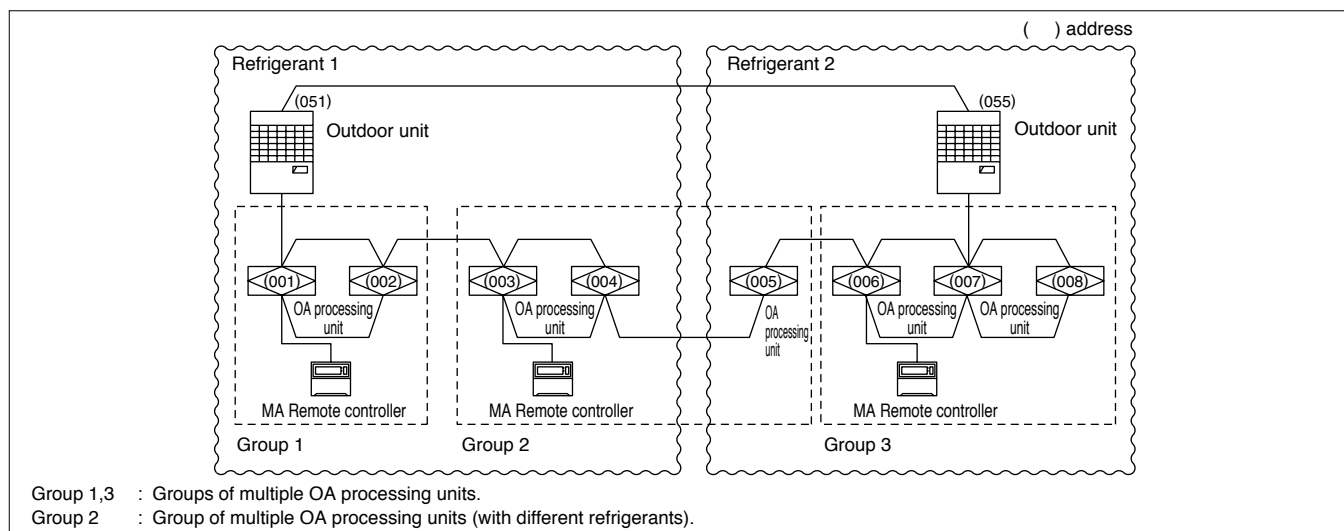

Note: On OA processing unit for a non-interlocked OA processing unit group, set DIP switch 3-1 (synchronous air conditioning switch) to on.

OA Processing unit function table (Group settings)

Item	Details
The sum of remote controllers and/or MELANS units that can be connected to one OA processing unit	5 units max (Number of local remote controller is 2 units max.)
Operation of two remote controllers in one group	Possible
Fan speed switching	High/Low
Ventilation mode	Auto
Humidifier switching (Only GUF-50/100RDH3)	Possible (When heating)
Operation mode switching	Heat/Cool/Fan
Filter maintenance indicator (Optional setting)	3,000 h/1,500 h/4,500 h/No display
Error	Display
Restrictions and precautions	<ul style="list-style-type: none"> • OA processing unit cannot be interlocked to another one. • OA processing units set to group registration (non-interlocked) cannot be interlocked setting. • When the OA processing unit is set to group registration, set the OA processing unit DIP switch 3-1 to on. • To connect two MA Remote controllers to the same group, set one MA Remote controller as a sub-remote controller. • MA Remote controllers and other local remote controllers cannot be used together in the same group.

Controller function table

Model	Local remote			MELANS Series			
	MA Remote controller	ME Remote controller	Simple remote controller	Group remote controller	System remote controller	Centralized controller	Centralized controller
	PAR-20MAA	PAR-F27MEA	PAC-SE51CRA or PAC-YT51CRA	PAC-SC30GRA	PAC-SF41SCA	MJ-103MTRA or G-50A	MJ-180A
No. of controllable (Groups/Units)	1 Group/16 Units	1 Group/16 Units	1 Group/16 Units	8 Groups/16 Units	32 Groups/50 Units	50 Groups/50 Units	100 Groups/100 Units 200 Groups/200 Units
Operation	Start/Stop	○	○	○	◎	◎	◎
	Fan speed switching	○	○	○	◎	×	◎
	Ventilation mode switching	×	×	×	×	×	×
	Humidifier switching (Only GUF-50/100RDH3)	○*1	○*1	○*1	◎*1	◎*1	◎*1
	Operation mode switching	○*3	○*3	×	◎*4	◎*4	◎*4
	Temperature setting	○	○	○	◎	◎	◎
	Priority instructions. Local permitted/Prohibited	×	×	×	×	◎	◎
Monitoring	Status (Operation/Stop)	○	○	○	◎	◎	◎
	Fan speed switching	○	○	○	○	×	○
	Ventilation mode	×	×	×	×	×	×
	Humidifier (Only GUF-50/100RDH3)	×	×	×	×	×	×
	Operation mode	○	○	×	○	○	○
	Setting temperature	○	○	○	○	○	○
	Error	○	○	○	○	○	○
	Error contents	○	○	○	○	○	○
	Filter sign	○	○	×	○	○	○
Local permitted/Prohibited	○	○	○	○	○	○	
Scheduling/Recording	Weekly	×	×	×	×	○	○
	Stop/Starts per day	2	2	×	×	3	6
	Stop/Starts per week	×	×	×	×	21	42
	Minumum setting (minutes)	10	10	×	×	10	1
	Error record	×	×	×	○	×	○

Switched & display ◎ : Group/Batch ○ : Group only (or function available) × : Not available

- Note:** *1 When in the “Heating” mode, the humidifier will also operate.
 *2 When the “Heating” is displayed on the controller, the humidifier is also operating.
 *3 “Dry” mode cannot be selected.
 *4 “Dry” display flashes. It indicates “Dry” mode is prohibited.

1.3 System Design. Example 3

Central controller system with MELANS

Features

- The Mitsubishi Electric air-conditioner network system (MELANS) can operate and monitor each group of OA processing units and air-conditioners.
- Can also perform operations using OA processing unit remote controller.

System example

The following groups can be configured.

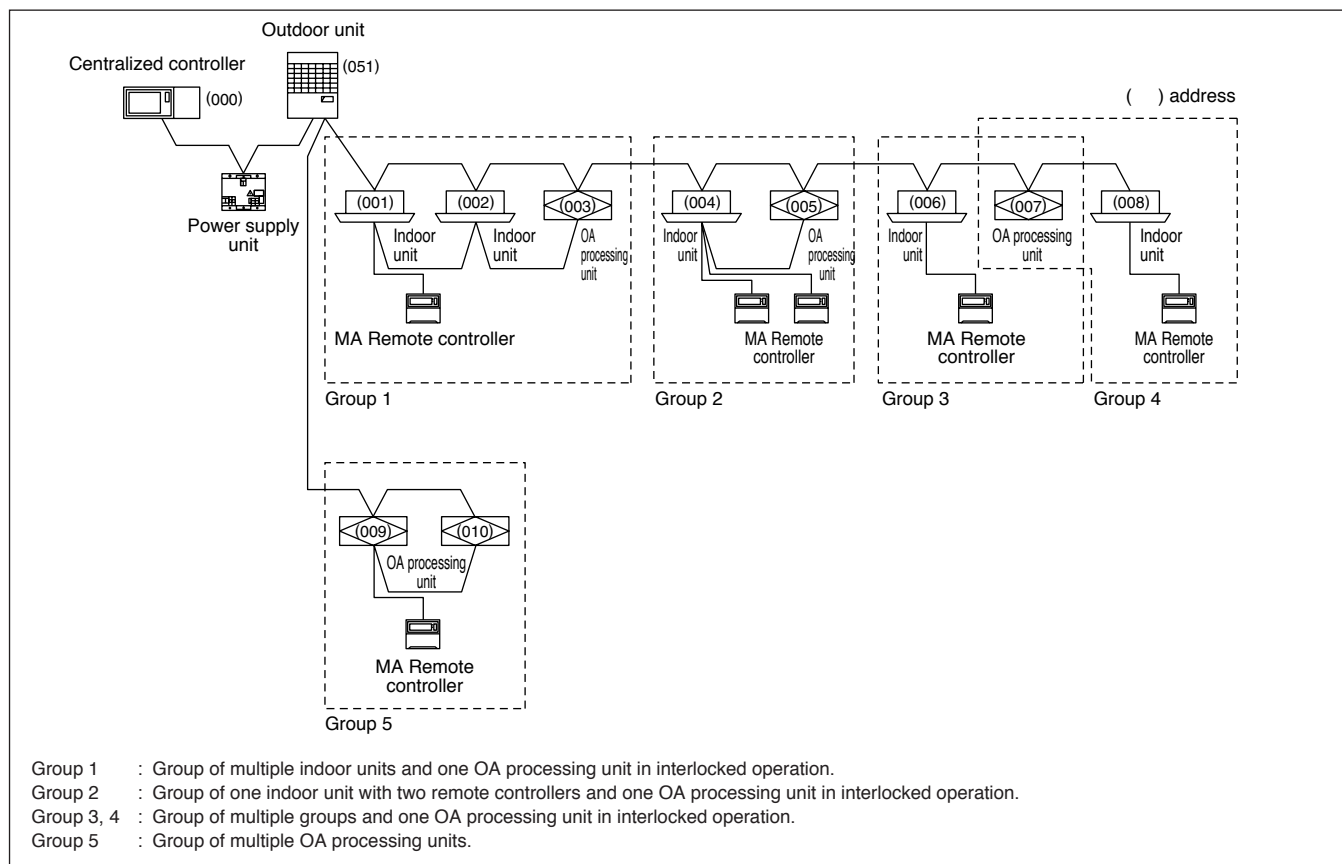

Note: ● On OA processing unit for a non-interlocked OA processing unit group, set DIP switch 3-1 (synchronous air conditioning switch) to on.

(In the system example shown above, Group 5 is non-interlocked OA processing unit.)

- Perform group setting by specifying the same content as the group setting implemented for MA Remote controller wiring from the MELANS (centralized controller).
- To operate OA processing units and indoor units by interlocking, it is necessary to perform interlock setting from the MELANS. (For a system that uses the MELANS, be sure to perform interlock setting from the MELANS, not from a local remote controller.)

2. Precautions when Designing Systems

2.1 Power Supply of Transmission Line

On an M-NET system, the remote controller or central controller operate on power received from the transmission line. Accordingly, there is need to provide power to the transmission line.

There are two systems for supplying power. The central system is supplied by a power supply unit. The indoor unit system is supplied by an outdoor unit. The OA processing unit and the local remote controller can be connected to the indoor unit system.

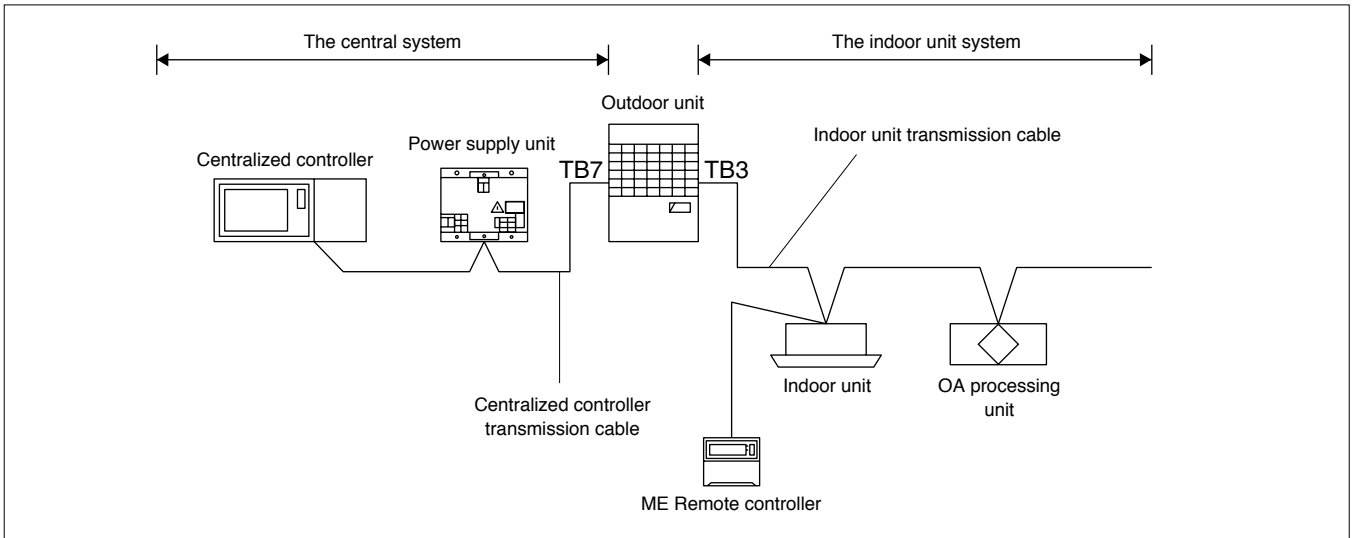

2.2 Power Supply to the Indoor Unit Transmission Cable

In principle, the number of indoor units and/or OA processing units that can be connected to one outdoor unit will depend on the type of outdoor unit. The following are the general guidelines when connecting multiple indoor units and/or OA processing units to an outdoor unit.

Condition		Maximum number of connected units (Note 1.)
When only MA Remote controllers and/or MA Simple remote controllers are used, or no Remote controller is used	When all indoor units are smaller than type 224	32
	When type 224 indoor units are included	26
Other than above	When all indoor units are smaller than type 224	40 (The sum of indoor units and OA processing units should be 20 units maximum.)
	When type 224 indoor units are included	32 (The sum of indoor units and OA processing units should be 16 units maximum.)

Note 1: The number of units counted as connected units.

Indoor units, OA processing units, ME Remote controllers, M-NET Simple remote controllers (MA Remote controllers and MA Simple remote controllers are not included in the count.)

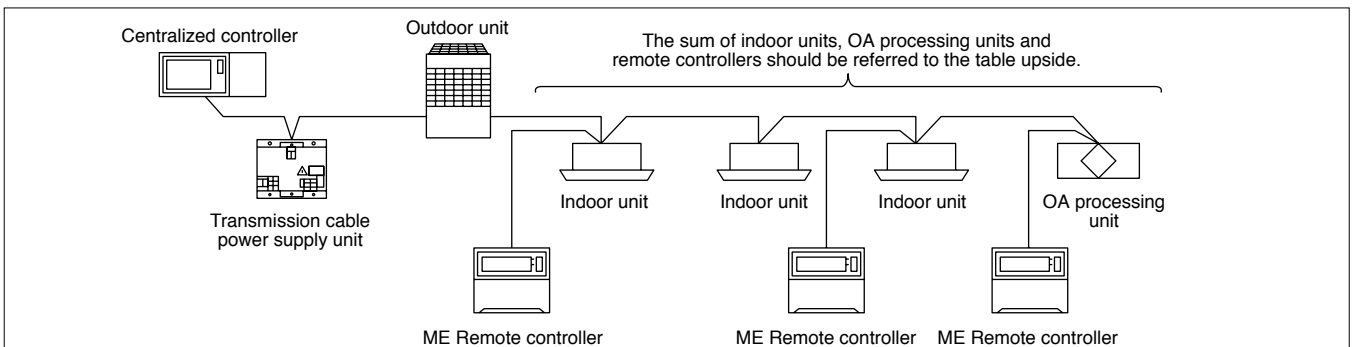

3. Cable Installation

3.1 Precautions when Installing Wiring

- (1) When routing transmission cable outside of the unit, position it 5 cm or more away cable for the power supply so that it will not pick up electrical noise. (Never use multi-core cable or place the transmission cable in the same conduit as the power supply cable.)
- (2) Never connect the power cable to the terminal block for the transmission cable. This erroneous connection will burn out the circuit board.
- (3) Always use two-core cable for the transmission cable. Routing this transmission cable with the transmission cable from another system on the same multi-core cable will result in erroneous sending and receiving of signals which will cause misoperation.

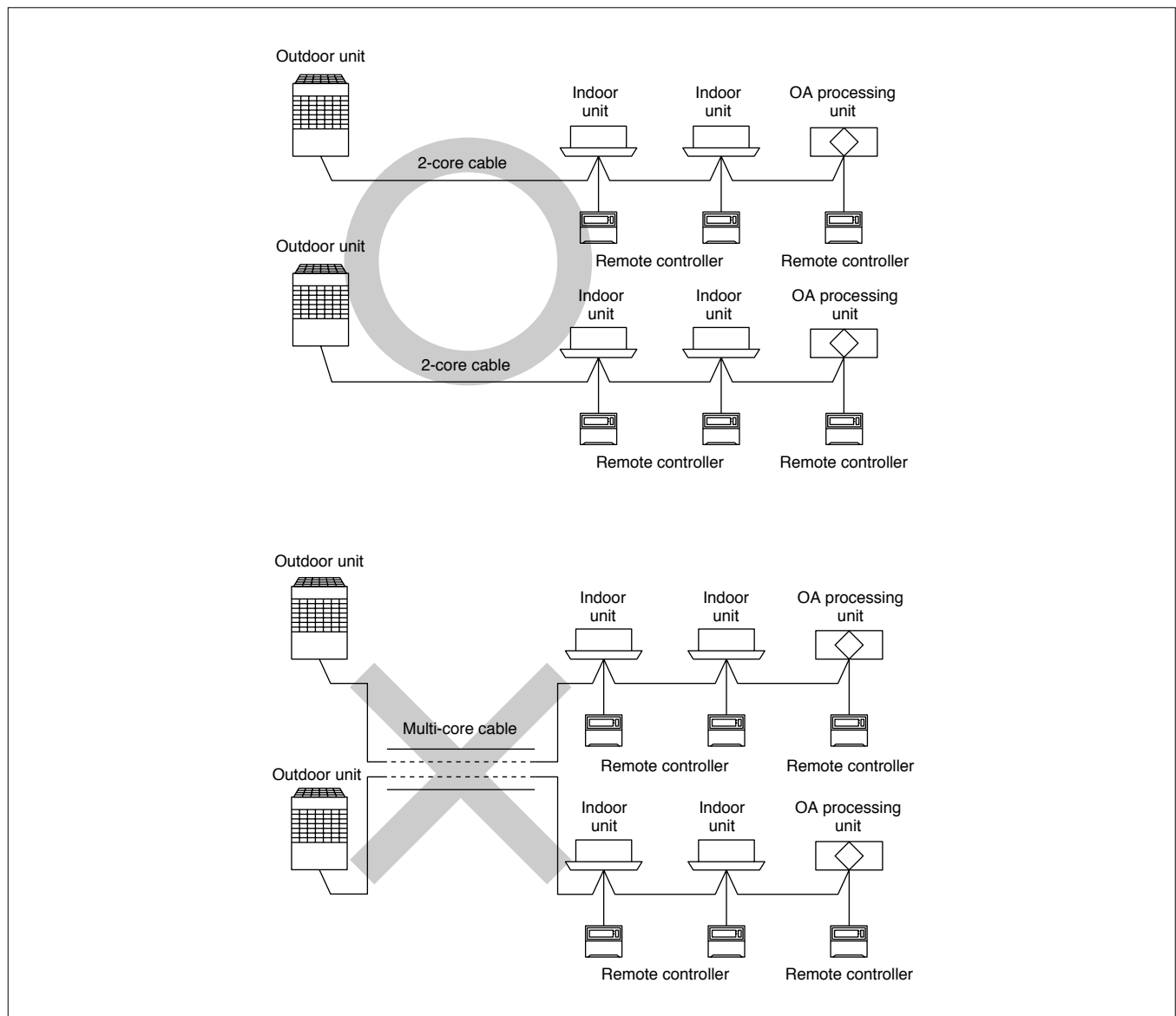

3.2 Electrical Wiring

Types of control cables

(1) Wiring M-NET transmission cables

- Types of transmission cables
Design wiring in accordance with the following Table 1.
- Cable cross-sectional area 1.25 mm² to 2.00 mm²

Table 1

System configuration	For a single-refrigerant system		For a multi-refrigerant system
Transmission cable length	Less than 120 m		More than 120 m
Transmission cable length	Less than 120 m		More than 120 m
Facility example (for signal noise determination)	Residence or independent store without signal noise	Building, clinic, hospital or communications station without signal noise supposedly generated from inverter equipment, private power generator, high-frequency medical equipment, radio-used communications equipment and so on	All facilities
Types of transmission cables	VCTF, VCTFK, CVV, CVS, VVR, VVF, VCT or shielding wire CVVS or CPEVS	Shielding wire CVVS or CPEVS	

(2) Remote controller cables

		MA Remote controller (Note 1)	M-NET remote controller (Note 2)	
Wiring type	Type of wire	VCTF, VCTFK, CVV, CVS, VVR, VVF, VCT	10m or less VCTF, VCTFK, CVV, CVS, VVR, VVF, VCT	When more than 10m (1) Same specifications as M-NET transmission cable.
	Wire quantity	Two-core cable		
	Wire diameter	0.3 to 1.25mm ² (Note 3) (0.75 to 1.25mm ²) (Note 4)	0.3 to 1.25mm ² (Note 3) (0.75 to 1.25mm ²) (Note 4)	
Total length		Maximum 200m	Maximum 10m	Include the part which exceeds 10m in the maximum length and power supply length.

Note 1: “MA Remote controller” refers to the MA Remote controller and MA Simple remote controller.

Note 2: “M-NET remote controller” refers to the ME remote controller and Simple remote controller.

Note 3: A maximum wire diameter of 0.75mm² is recommended to make the work easier.

Note 4: Use the wire diameter in the parentheses when connecting to the Simple remote controller terminal block.

3.3 Length of the M-NET Control Cable

Distance limitation for the M-NET transmission cable

The following limitations are for cable that has a minimum of 1.25 mm².

- (1) The maximum length of the transmission cable between indoor unit (OA processing unit) and outdoor unit from the outdoor unit to the furthest indoor unit (OA processing unit) is 200 m.
- (2) The maximum length of the central controller transmission line from the transmission cable power supply unit to each outdoor device or to a system controller, is 200 m.
- (3) The maximum length of cable from a system controller or 1 indoor unit (OA processing unit), to the furthest indoor unit (OA processing unit) or system controller, is 500 m.
- (4) When the remote controller cable is longer than 10 m, use cable of at least 1.25 mm² for the excessive length. When shielded cable is used, the maximum of cable is 200 m.

The following explains the maximum length and power supply length for CVVS: 1.25 mm² and CPEVS: \varnothing 1.2 mm

3.3.1 Maximum length

The maximum length for the M-NET transmission cable cannot exceed 500 m. When the length exceeds 500 m, communication cannot reach the terminal and thus control is impossible.

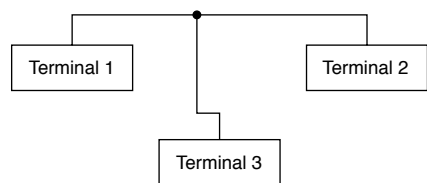

Terminal: Equipment which are part of the M-NET communication pathway

Example – Outside units, indoor units (OA processing units), network remote controllers etc.

In the connection like those in the above figure, the length

- * Terminal 1 to Terminal 2
 - * Terminal 1 to Terminal 3
 - * Terminal 2 to Terminal 3
- } cannot exceed 500 m.

3.3.2 Power supply length

The distance between equipment that use the M-NET for the power supply cannot exceed 200 m between each electrical receiver terminal. When the length exceeds 200 m, the power supply will not reach the terminal and thus control is impossible.

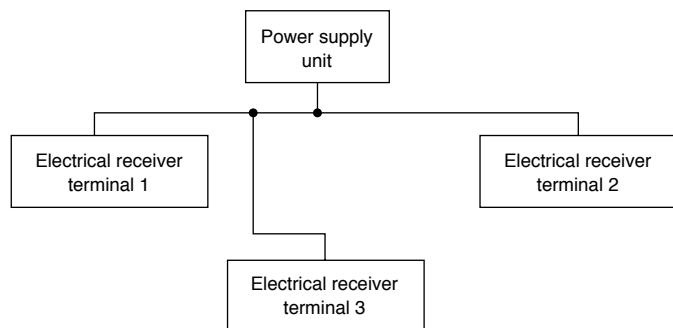

Note: The electrical receiver terminal refers to the units that receive electricity from the transmission cable in order to operate. For example central controllers or remote controllers etc.

In the connection like those in the above figure, the length of

- * Power supply to Electrical receiver terminal 1
 - * Power supply to Electrical receiver terminal 2
 - * Power supply to Electrical receiver terminal 3
- } cannot exceed 200 m.

System example

Wiring restrictions of a system when the central controller is connected.

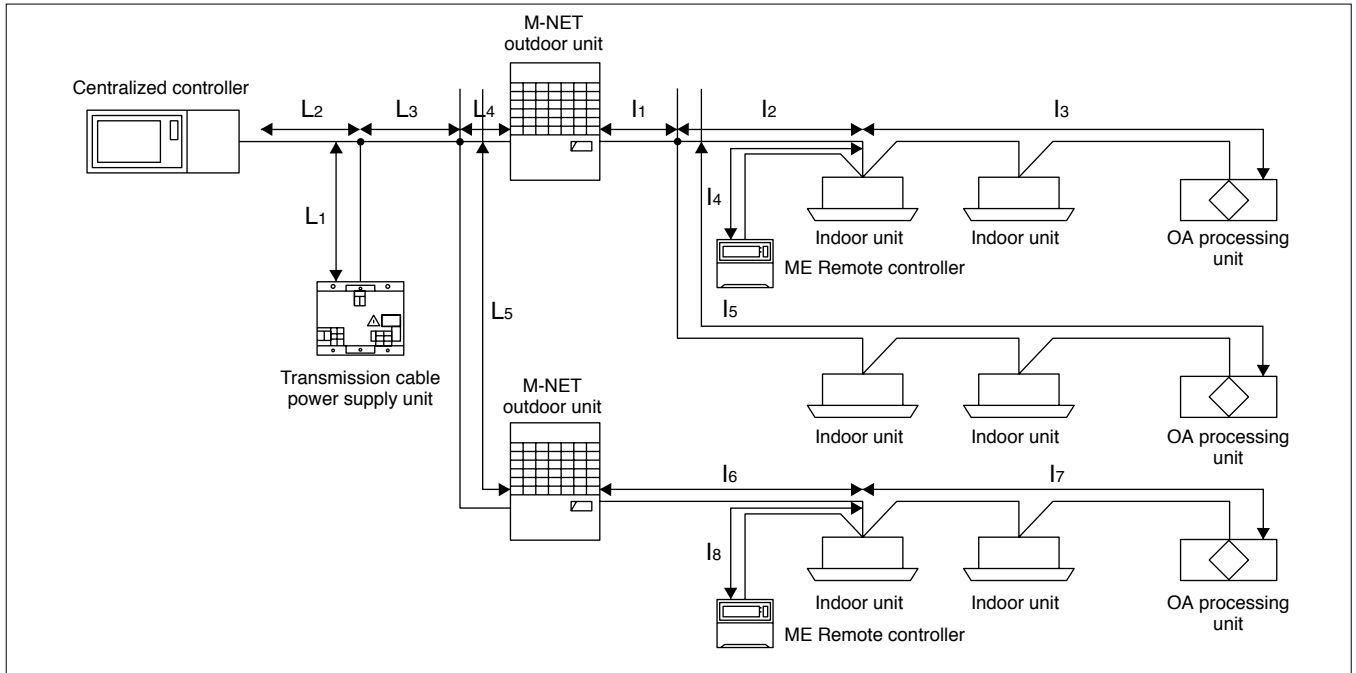

The following provides formulas for the wiring restriction of the above figure.

(1) Entire transmission line (total extended length)

- 1) $L_2 + L_3 + L_4 + I_1 + I_2 + I_3 (I_4) \leq 500 \text{ m}$
- 2) $L_2 + L_3 + L_4 + I_1 + I_5 \leq 500 \text{ m}$
- 3) $L_2 + L_3 + L_5 + I_6 + I_7 (I_8) \leq 500 \text{ m}$
- 4) $I_3 (I_4) + I_2 + I_1 + L_4 + L_5 + I_6 + I_7 (I_8) \leq 500 \text{ m}$
- 5) $I_5 + I_1 + L_4 + L_5 + I_6 + I_7 (I_8) \leq 500 \text{ m}$

(2) Transmission line between indoor unit and outdoor unit (power supply length)

- 1) $I_1 + I_2 + I_3 (I_4) \leq 200 \text{ m}$
- 2) $I_1 + I_5 \leq 200 \text{ m}$
- 3) $I_6 + I_7 (I_8) \leq 200 \text{ m}$

(3) Central controller line (power supply length)

- 1) $L_1 + L_2 \leq 200 \text{ m}$
- 2) $L_1 + L_3 + L_4 (L_5) \leq 200 \text{ m}$

Note: If the remote controller wiring I_4 or I_8 is 10 m or less, then you can ignore I_4 and I_8 in the above formula. Also if the remote controller wiring uses a thickness of 0.75 mm^2 or less then the wiring for I_4 and I_8 must not exceed 10 m.

3.3.3 Wiring Length of the MA Remote Controller

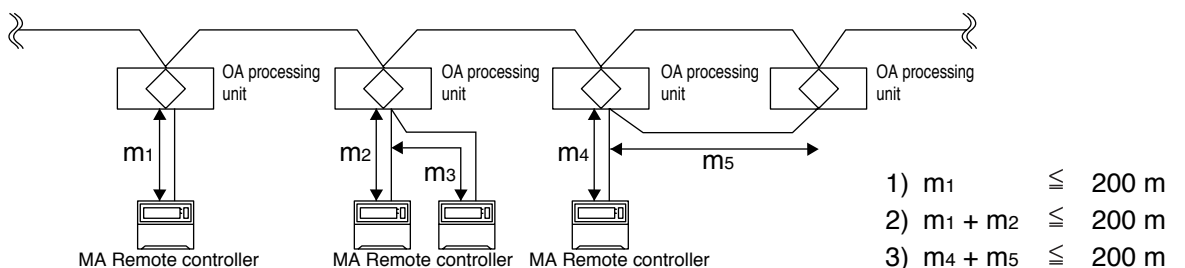

4. System Designs

4.1 Address Definitions

An address is a unique number used to identify each air conditioner and controller.

Address setting is not required for a single refrigerant system comprising of OA processing units for which interlock setting is not performed when only MA Remote controllers are used as controllers (i.e., no other M-NET remote controllers and MELANS are used). Keep the factory set address (000) for both the outdoor unit and the OA processing units.

For others cases, set addresses according to the table below.

Device	Description	Address definition range
OA processing unit	Set specify each refrigerant system.	001 to 050
Indoor unit	Set specify each refrigerant system.	001 to 050
Outdoor unit	Minimum address of the indoor unit (OA processing unit) within the same refrigerant system. (+50)	051 to 100
Branch controller	Minimum address of an outdoor unit. (+1)	052 to 100
Local remote controller (master)	Minimum address of the indoor unit in the same group. (+100)	101 to 150
Local remote controller (secondary)	Minimum address of the indoor unit in the same group. (+150)	151 to 200
Centralized controller	When two or more centralized controllers are used, set the address of one to (000) and assign (201 to 250) to the other.	000, 201 to 250
K-transmission converter	Minimum address of the K-control type indoor unit. (+200) This cannot overlap with other system controllers.	201 to 250
Group remote controller System remote controller	Ranging from 201 to 250, duplicate addresses are not allowed.	201 to 250

4.2 Precautions when Performing Group Settings (when not Interlocked with City Multi Indoor Unit)

Group setting is not required for a single refrigerant system that uses only MA Remote controllers as controllers (i.e., no other M-NET remote controllers and MELANS are used).

For other cases, set group according to the table below.

Precautions	
1	The maximum number of OA processing units in one group is 16.
2	When two ME Remote controllers are used within the same group, set one remote controller as the master (address 101 to 150) and the other as the slave (address 151 to 200). (Refer to page 96.)
3	Group settings: 1) Perform group settings at the centralized controller MJ-103MTRA or G50A when being used. If two or more centralized controllers are being used in combination, perform the group settings at the host one. 2) If central controller system is not being used, use the Remote controller to perform the settings.
4	Do not perform interlock settings for an OA processing unit that has been set to a group.
5	Turn on the power source for the OA processing unit when performing group setting.
6	If the group settings are performed by MELANS, be sure to also set the address for the Remote controllers to the group setting. If the Remote controller address is not registered, "H0" remains displayed and the system does not start up.
7	No more than three Remote controllers can be set to the same group in a system using a centralized controller.
8	An OA processing unit and Lossnay unit cannot be set to the same group. An OA processing unit is set to the same group with indoor unit(s) in case, its adress should be larger than the indoor unit(s).
9	ME Remote controllers and MA Remote controllers cannot be used together in the same group.

4.3 Precautions when Performing Interlock Settings (when Interlocked with City Multi Indoor Unit)

Precautions	
1	The maximum number of indoor units that can be interlocked is 16. (Refer to page 95.)
2	One indoor unit can register only one OA processing unit as for interlocked operation. (Refer to page 95.)
	Interlock settings: 1) When a centralized controller (MJ-103MTRA or G-50A) is being used: if two or more centralized controllers are being used in combination, perform the group settings at the host one. 2) When Remote controllers are being used except above 1): Use the Remote controller for the interlock settings. (Interlock settings cannot be performed with the MJ-180A.) (If 1) or 2) do not apply, interlock settings cannot be made.)
4	Do not register the interlocked OA processing unit in a group.
5	When performing the settings using a Remote controller, always set for interlocked operation to the smallest address indoor unit in a group. If the setting is not made in this manner, the message "This function is not available" will appear when operating the ventilation switch and interlocking with the OA processing unit will not be possible.
6	Turn on the power source for the OA processing unit when performing interlock settings.

5. Control of OA Processing Unit

5.1 Switching attributes

The OA processing unit has two attributes: the attribute FU mode and the attribute IC mode. The attribute FU mode is the mode for interlocking operation with the indoor unit, with operations being performed by instructions from the indoor unit. The attribute IC mode is the mode for not interlocking operation with the indoor unit, with OA processing unit being directly operated by the remote controller.

Switching of attributes is done by SW3-1

- Attribute FU mode (Mode for interlocked operation with indoor unit)
SW3-1 OFF (Factory setting)
- Attribute IC mode (Mode for operation by remote controller)
SW3-1 ON

5.2 Operating Mode

The OA processing unit has three operations: [heating], [cooling] and [ventilation]. The method of determination will vary according to the attributes.

5.2.1 Using attribute FU mode

- (1) The unit operates in the same operating mode as the indoor unit it is interlocked with. Note that when [dry] is being use, OA processing unit will be in [cooling] mode.
- (2) When there are multiple interlocked indoor units, each set to different modes, the operating mode will be determined according to the following level of priority: [heating] > [cooling] > [ventilation].
- (3) When all the interlocked indoor units have been stopped and only OA processing unit is being operated by the ventilation selection button on the Remote controller, it will be in [ventilation] mode.

5.2.2 Using attribute IC mode

The operating mode is determined by operations from the remote controller. Note that when [dry] is being use in the same group of indoor unit(s) and OA processing unit(s), OA processing unit will be in cooling mode. (The remote controller will display [dry].)

5.3 Fan Speed Control

There are two fan speeds: high and low. The method of control will vary according to the attributes

5.3.1 Forced stopping of air supply fan

With OA processing unit, the air supply fan will be stopped under the following conditions.

At this time, if DIP switch SW3-6 is set to on, the exhaust fan will also be stopped.

- (1) When OA processing unit is [heater defrosting] or [fan defrosting].
- (2) When the OA processing unit is [recovering refrigerant] or in [heating stop mode] (R2 only) or [heating start mode] (R2 only).
- (3) The supply fan may temporarily stop when R2 is started up and stopped.

5.3.2 Forced switching from high to low speed of supply air fan

When OA processing unit has detected a humidifier error, the air supply fan is forced to the low speed. (Only during high speed operation)

6. Automatic Ventilation Switching

6.1 Effect of Automatic Ventilation Mode

The automatic damper mode automatically provides the correct ventilation for the conditions in the room. It eliminates the need for troublesome switch operations when setting the OA processing unit to “By-pass” ventilation. The following shows the effect “By-pass” ventilation will have under various conditions.

(1) Reduces cooling load

If the air outside is cooler than the air inside the building during the cooling season (such as early morning or at night), “By-pass” ventilation will draw in the cooler outside air and reduce the cooling load on the system.

(2) Cooling using outdoor air

During cooler seasons (such as between spring and summer or between summer and fall), if the people in a room cause the temperature of the room to rise, “By-pass” ventilation draw in the cool outside air and use it as is to cool the room.

(3) Night purge

“By-pass” ventilation can be used to release hot air from inside the building that has accumulated in buildings at business district during the hot summer season.

(4) Office equipment room cooling

During cold season, outdoor air can be drawn in and used as is to cool rooms where the temperature has risen due to the use of office equipment.

6.2 Switching between Heat Recovery and “By-pass” in the Automatic Ventilation Mode

Control of the automatic ventilation mode is performed according to the table below and automatic algorithm temperature maps. Note that operation is fixed at heat recovery when the fan is stopped or when there is an abnormality with the OA processing unit.

Conditions		Temperature map
When not interlocked with indoor units	Heating mode	According to (a).
	Cooling mode or fan mode	According to (b).
When interlocked with indoor units	Fan mode operation for all interlocked indoor units. (= OA processing unit in fan mode)	Fixed at heat recovery.
	Heating mode for one or more interlocked indoor units. (= OA processing unit in heating mode.)	According to (a).
	Cooling mode for one or more interlocked indoor units and not Heating mode for any interlocked indoor units. (= OA processing unit in cooling mode.)	According to (b).
	When all interlocked indoor units are stopped and only OA processing unit is operated. (= OA processing unit in fan mode.)	Fixed at heat recovery.

Note: There is a maximum delay of 30 seconds during damper switching.

If the outside air temperature becomes 8°C or below , the mode is fixed to Lossnay ventilation regardless of the conditions above (to prevent condensation).

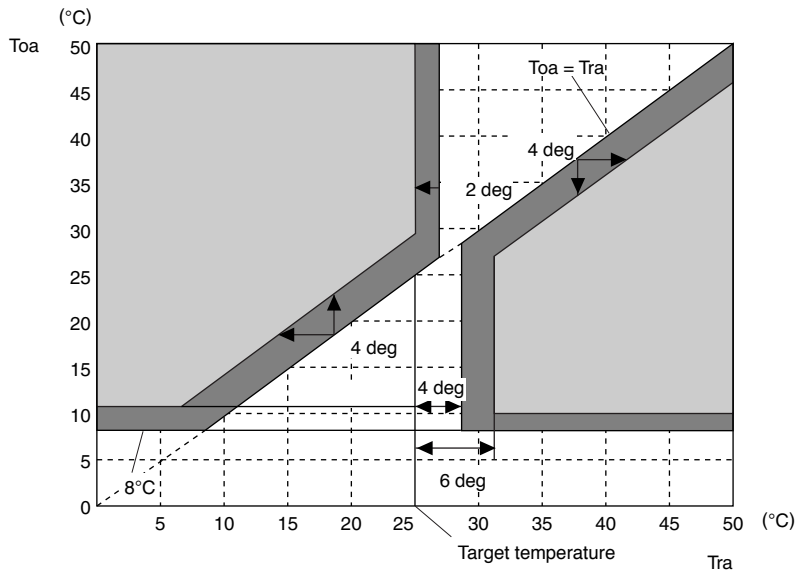

(a) When heating mode

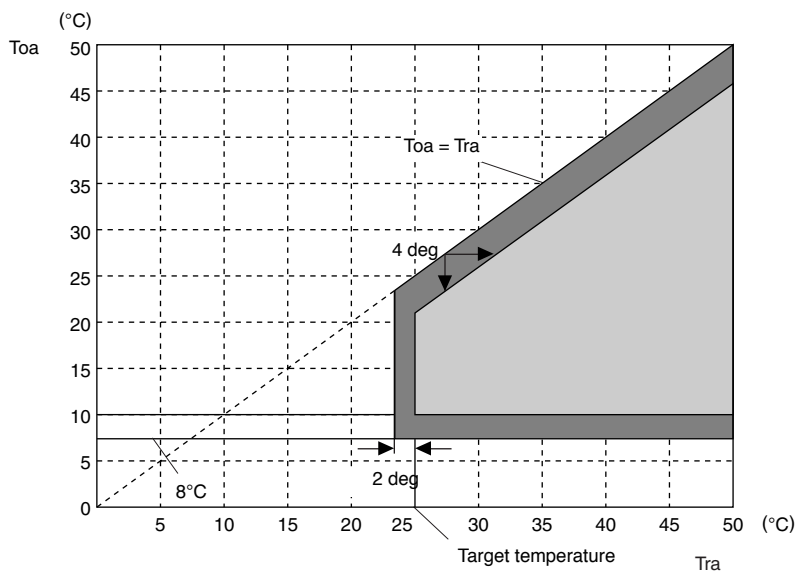

(b) When cooling mode or when non-interlocked OA processing unit is fan mode

- Heat recovery ventilation
- By-pass ventilation
- Comfort zone

Toa: Outdoor air temperature
 Tra: Indoor air temperature

The indoor air and outdoor air temperature are detected by the two temperature sensors (thermistors) built into the main OA processing unit.

6.3 Operation Example

6.3.1 Cooling

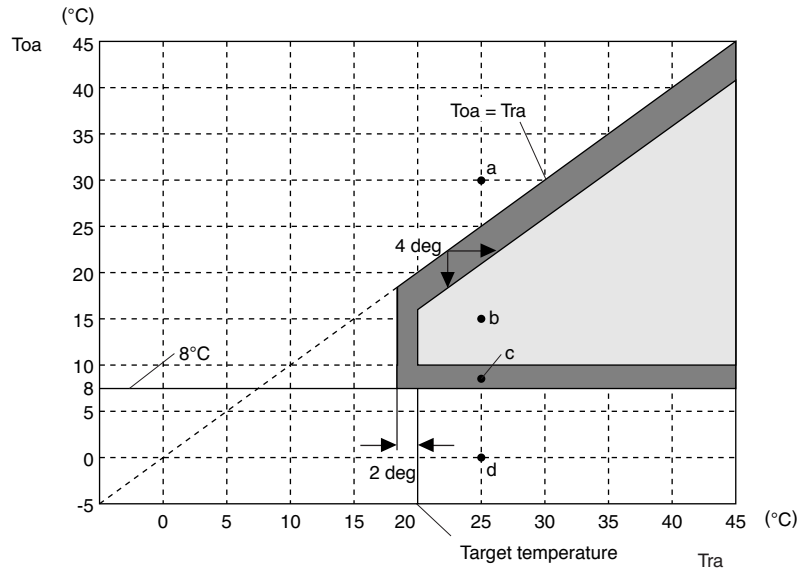

	Target temperature	Tra	Toa	Ventilation mode	On coil temperature*1
a	20	25	30	Lossnay	26.2
b	20	25	15	Bypass	15
c	20	25	9	Lossnay*2(Bypass)	21.3(9)
d	20	25	0	Lossnay	19.3

Note: *1: The calculation is made assuming heat exchange efficiency of 77%.
 *2: If the previous mode was Lossnay ventilation, the Lossnay ventilation mode is continued.
 If the previous mode was Bypass ventilation, the Bypass ventilation mode is continued.

6.3.2 Heating

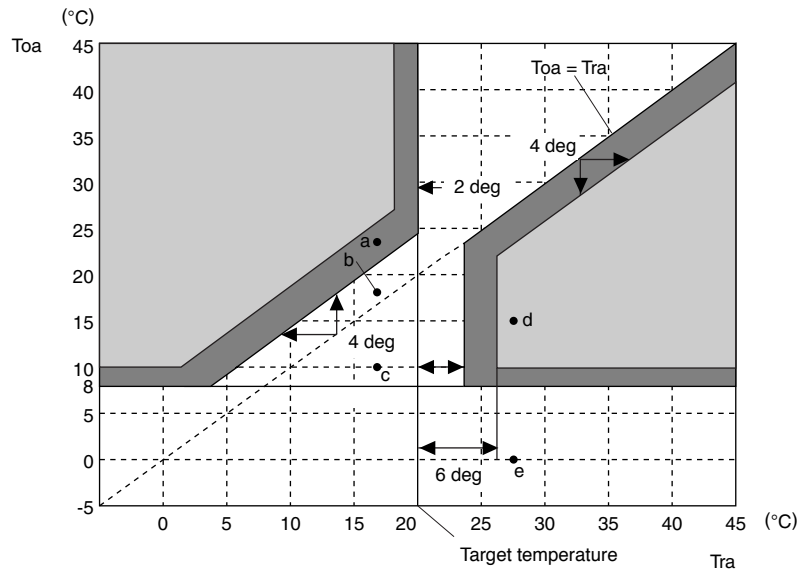

	Target temperature	Tra	Toa	Ventilation mode	On coil temperature*1
a	20	17	22	Bypass	22
b	20	17	19	Lossnay*2(Bypass)	17.5(17)
c	20	17	10	Lossnay	15.4
d	20	27	15	Bypass	10
e	20	27	0	Lossnay	20.8

Note: *1: The calculation is made assuming heat exchange efficiency of 77%.
 *2: If the previous mode was Lossnay ventilation, the Lossnay ventilation mode is continued.
 If the previous mode was Bypass ventilation, the Bypass ventilation mode is continued.

7. Operation with Cooling/Heating

7.1 In the Case of GUF-50/100RDH3 (Type with Humidifier)

The OA processing units adjust the temperature based on the difference between the following target temperatures and the processing temperatures. They make adjustments when the processing temperature is lower than the target temperature during heating and when the processing temperature is higher than the target temperature during cooling.

System	Operation mode	Target temperature (Tt)	Processing temperature (Tp)	Conditions for starting temperature adjustment	Conditions for stopping temperature adjustment	Fig. No.
When not interlocked with indoor units	When heating	Setting value using the Remote controller	Outdoor air temperature + 11°C	Processing temperature < target temperature – 1°C and Indoor air temperature < target temperature + 4°C	Processing temperature ≥ target temperature or Indoor air temperature ≥ target temperature + 5°C	Fig.1
	When cooling	Setting value using the Remote controller	Air temperature before passing through direct expansion coil (Note)	Processing temperature ≥ target temperature + 1°C and Indoor air temperature ≥ target temperature + 1°C	Processing temperature < target temperature or Indoor air temperature < target temperature	Fig.2
When interlocked with indoor units	When heating	DIP switch setting value (SW3-3, 4, 5)	Outdoor air temperature	Processing temperature < target temperature – 1°C and Indoor air temperature < 27°C	Processing temperature ≥ target temperature or Indoor air temperature ≥ 28°C	Fig.3
	When cooling	Average target temperature of operating indoor units	Air temperature before passing through direct expansion coil (Note)	Processing temperature ≥ target temperature + 1°C and Indoor air temperature ≥ 20°C	Processing temperature < target temperature or Indoor air temperature < 19°C	Fig.4

Note: Air temperature before passing through direct expansion coil is the following temperature.

- When heat recovery ventilation:
Outdoor air temperature – (Outdoor air temperature – Indoor air temperature) × 0.75
- When By-pass ventilation:
Outdoor air temperature
- With the GUF-50/100RDH3, this unit cannot be used to control room humidity because basically the humidity control is not related to room humidity.

Operation example

System	Operation mode	Target temperature (Tt)	OA temperature (Toa)	RA temperature (Tra)	Processing temperature (Tp)	Condition
When not interlocked with indoor units	When heating	20	6	17	17	Starting
		20	6	21	21	Stopping
	When Cooling	25	30	28	28	Starting
		25	30	24	24	Stopping
When interlocked with indoor units	When heating	20	6	17	17	Starting
		20	6	21	21	Stopping
	When Cooling	25	30	28	28	Starting
		25	30	24	24	Stopping

Fig. 1

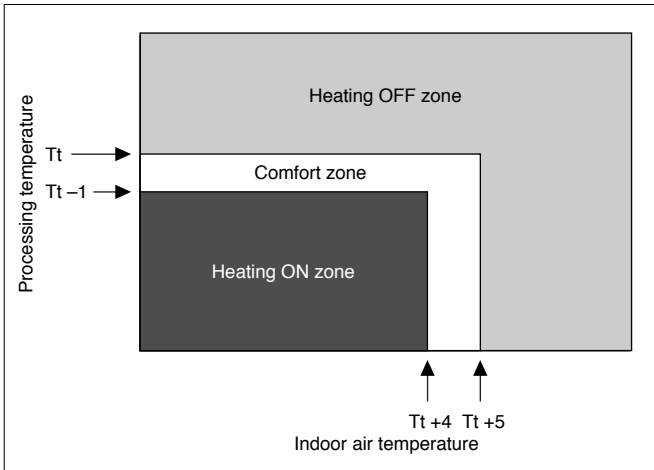

Fig. 2

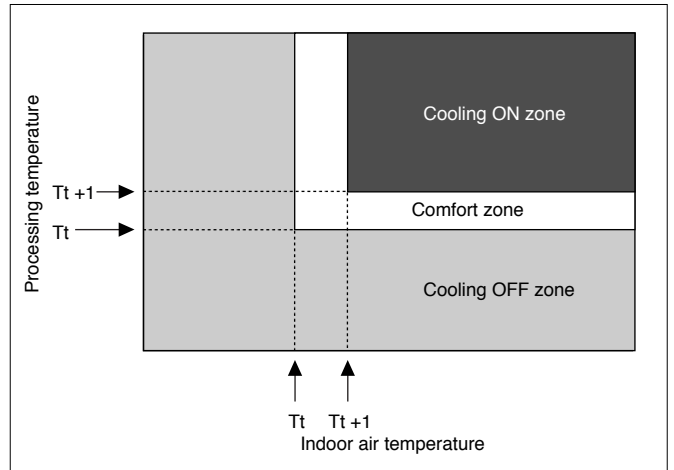

Fig. 3

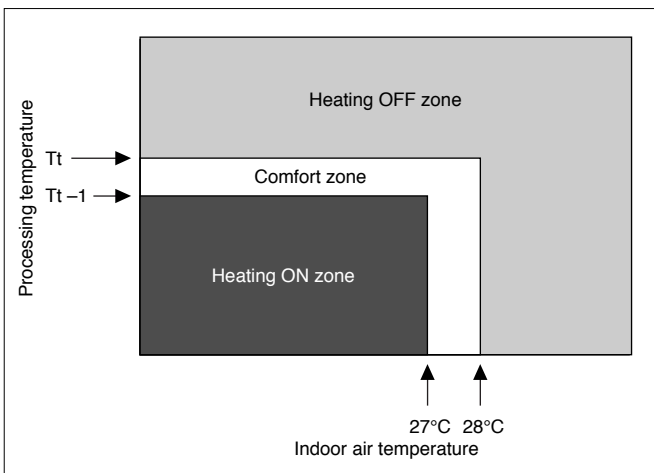
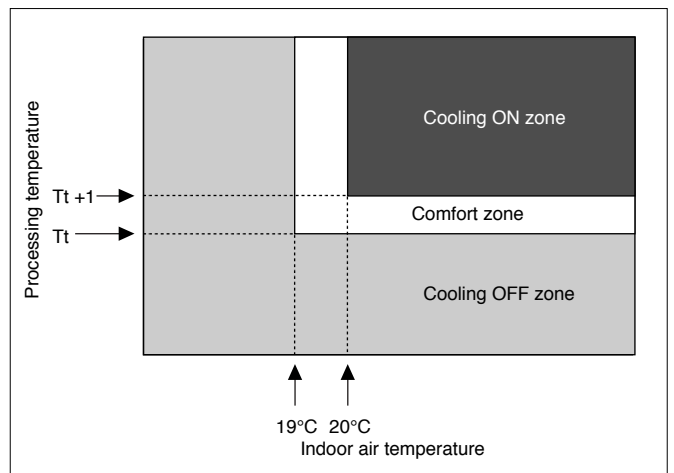

Fig. 4



Operation example

System	Operation mode	Target temperature (Tt)	OA temperature (Toa)	RA temperature (Tra)	Processing temperature (Tp)	Condition
When not interlocked with indoor units	When heating	20	6	19	17	Starting
		20	6	25	17	Stopping
		20	10	19	21	Stopping
	When Cooling	25	30	27	27.8	Starting
		25	30	24	25.5	Stopping
		25	18	27	24	Stopping
When interlocked with indoor units	When heating	10	6	25	6	Starting
		10	11	25	6	Stopping
		10	6	28	6	Stopping
	When Cooling	20	30	20	22.5	Starting
		20	18	20	19.5	Stopping
		20	30	18	21	Stopping

7.2 In the Case of GUF-50/100RD3 (Type without Humidifier)

Adjust the temperature based on the difference between the following target temperatures for the OA processing unit (GUF-50/100RD3) and the processing temperature. Make adjustments when the processing temperature is lower than the target temperature during heating and when the processing temperature is higher than the target temperature during cooling.

System	Operation mode	Target temperature (Tt)	Processing temperature (Tp)	Conditions for starting temperature adjustment	Conditions for stopping temperature adjustment	Fig. No.
When not interlocked with indoor units	When heating	Setting value using the Remote controller	Indoor air temperature	Processing temperature < target temperature - 1°C	Processing temperature ≥ target temperature	Fig.5
	When cooling	Setting value using the Remote controller	Indoor air temperature	Processing temperature ≥ target temperature + 1°C	Processing temperature < target temperature	Fig.6
When interlocked with indoor units	When heating	Average target temperature of operating indoor units	Indoor air temperature	Processing temperature < target temperature - 1°C	Processing temperature ≥ target temperature	Fig.5
	When cooling	Average target temperature of operating indoor units	Indoor air temperature	Processing temperature ≥ target temperature + 1°C	Processing temperature < target temperature	Fig.6

Fig. 5

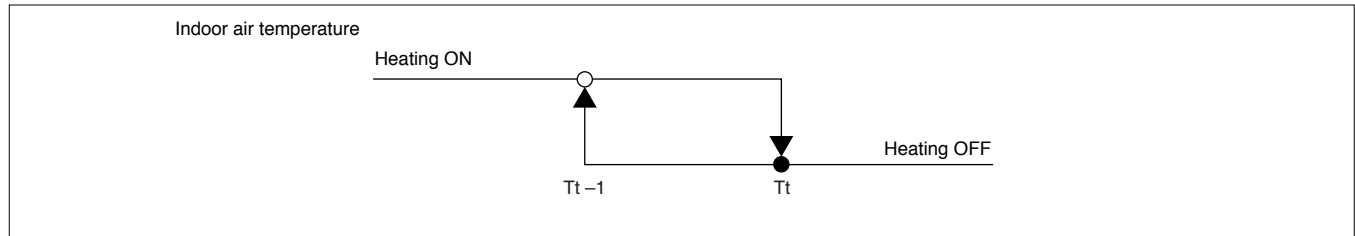
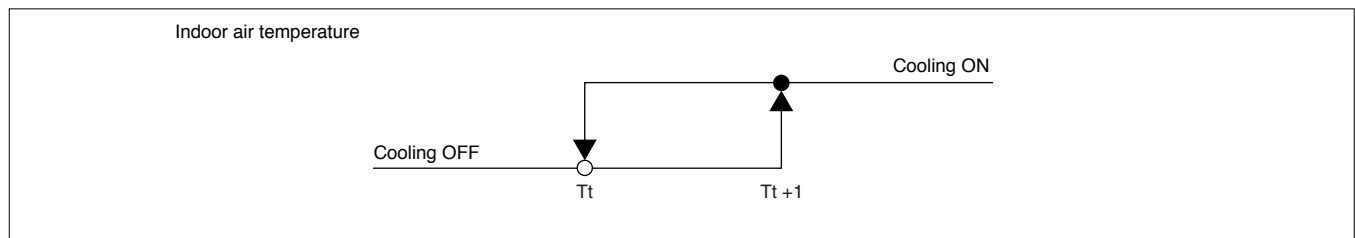

Fig. 6



7.3 Automatic Change Over between Cooling and Heating

7.3.1 In the case of GUF-50/100RDH3 (Type with humidifier)

Change operating mode	Determining conditions
Heat → Cool	When continuous for 3 minutes or more, outdoor air temperature > target temperature + 7°C.
Cool → Heat	When continuous for 3 minutes or more, outdoor air temperature < target temperature – 7°C.

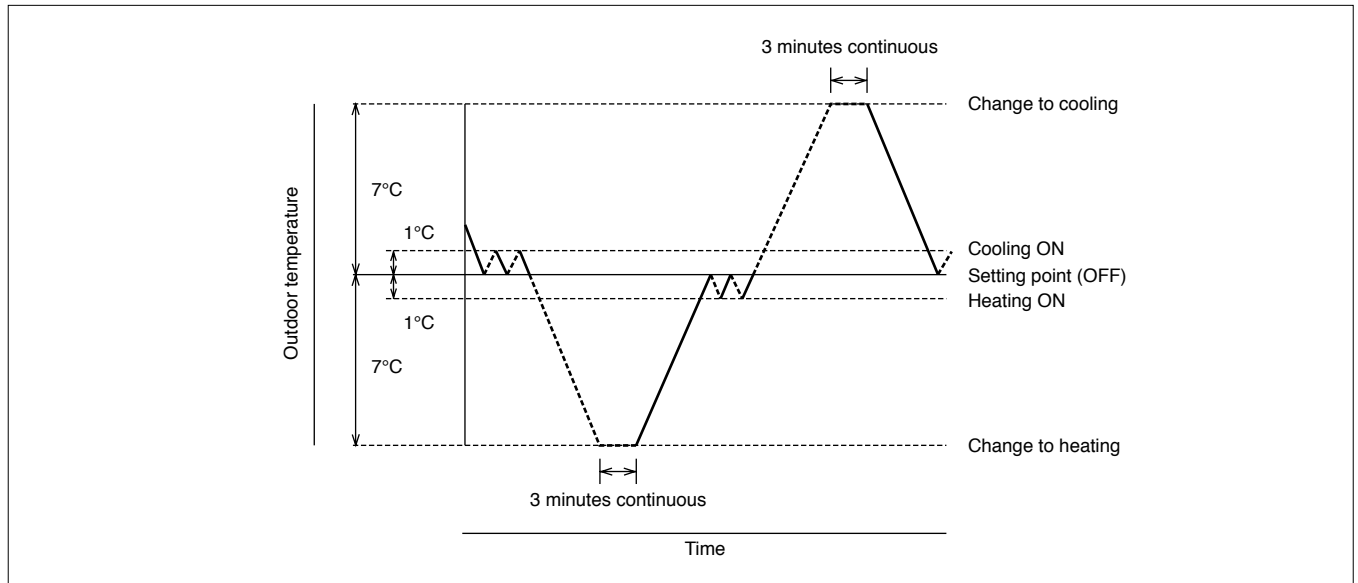

7.3.2 In the case of GUF-50/100RD3 (Type without humidifier)

Change operating mode	Determining conditions
Heat → Cool	When continuous for 3 minutes or more, indoor air temperature > target temperature + 1.5°C.
Cool → Heat	When continuous for 3 minutes or more, indoor air temperature < target temperature – 1.5°C.

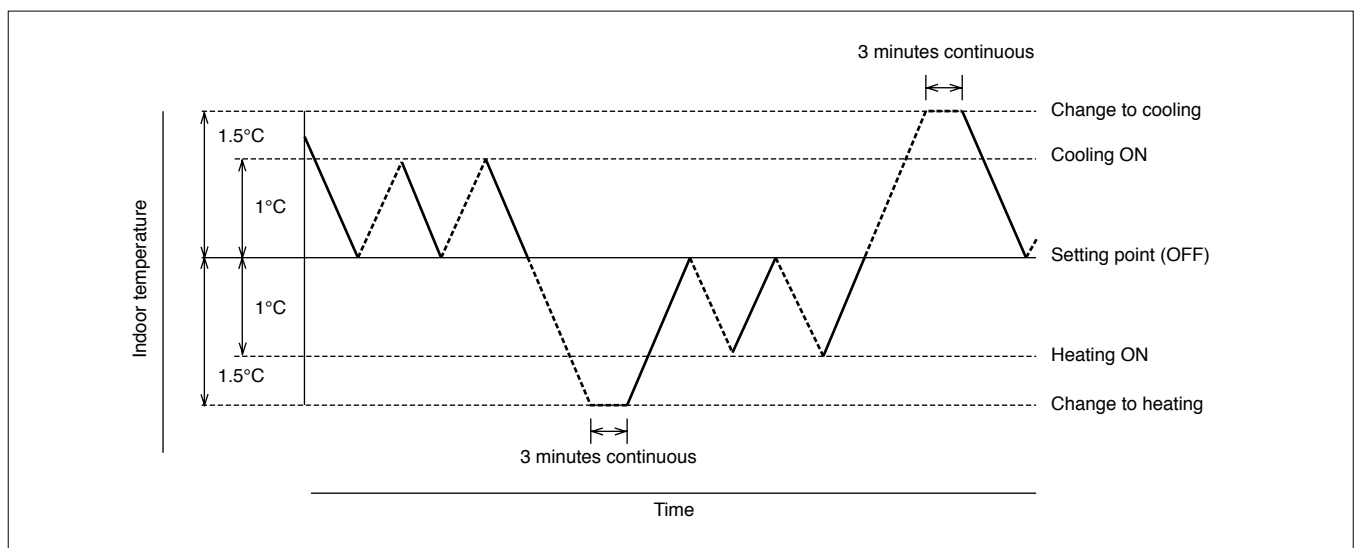

7.4 OA Processing Unit Controller Precautions

	System diagram	Description
1		<p>The outdoor air processing unit can interlock-set up to 16 indoor units. The indoor unit recognizes the interlock of only one OA processing unit. (Refer to the service manual for the City Multi unit for the setting procedure.) The target temperature for the OA processing unit is the average temperature setting for the indoor units linked to it.</p>
2		<p>There may be times when the OA processing unit does not operate due to the combination of the group settings and attributes.</p> <p>(1) Group setting: No, Attribute: FU This type of setting cannot be made.</p> <p>(2) Group setting: Yes, Attribute: IC The OA processing unit will operate as an indoor unit.</p> <p>(3) Interlock setting: Yes, Attribute: FU</p>
3		<p>If the attribute for the OA processing unit is FU, the Remote controller cannot be directly connected to the OA processing unit and it cannot directly control the OA processing unit. (It can be connected, but the group setting cannot be made.)</p> <p>If the attribute for the outdoor air processing unit is IC, it is possible to use a Remote controller to control the OA processing unit by separating the group settings into two groups (Group 1, Group 2) or one group (Group 3) as shown in the illustration on the left.</p> <p>It is not possible to make a setting like Group 3 + Group 2.</p>

8. Feature Settings

Caution

- Always turn off the main power supply.
- Remove the control box cover.

8.1 Address Setting

Remove the control box cover.

Turn the address setting switch on the board using a Phillips screwdriver.

- The left side (SW12) shows the second digit and the right side (SW11) shows the first digit.
- The switch is set to 00 when factory shipped.
- Set the address between 1 and 50.

8.2 When Using an R2 Series External Unit, Setting for the Branch No. is Also Required

Turn the branch controller No. setting switch (SW14) on the board using a Phillips screwdriver.

- Set the refrigerant pipe of the external unit and the connected branch controller to the same number.
- The switch is set to 0 when shipped.

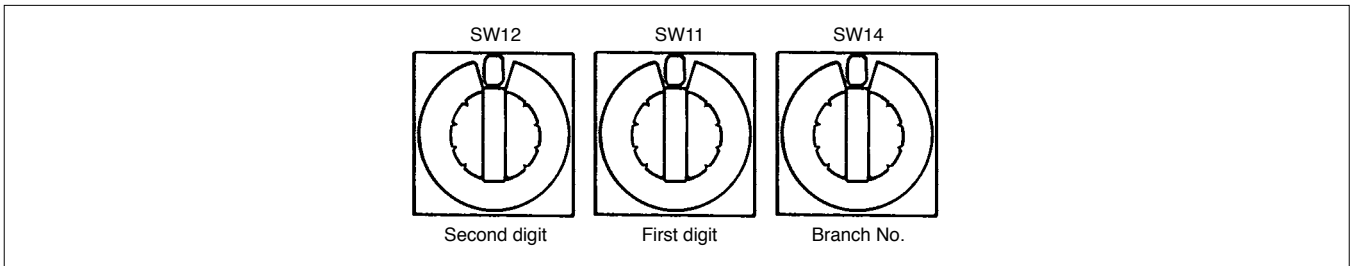

8.3 Feature Select Switches (SW1, SW2, SW3)

- The SW1, SW2 and SW3 figures show the factory settings.
- Items concerning humidifying is for GUF-50/100RDH3 only.

SW1

	OFF	ON	
1	<input checked="" type="checkbox"/>	<input type="checkbox"/>	Fan test operation switch (test operation when ON)
2	<input checked="" type="checkbox"/>	<input type="checkbox"/>	Filter maintenance display (displayed when ON)
3	<input checked="" type="checkbox"/>	<input type="checkbox"/>	Filter maintenance time setting switch
4	<input checked="" type="checkbox"/>	<input type="checkbox"/>	
5	<input checked="" type="checkbox"/>	<input type="checkbox"/>	Output signal mode selection switch
6	<input checked="" type="checkbox"/>	<input type="checkbox"/>	Input signal mode selection switch
7	<input checked="" type="checkbox"/>	<input type="checkbox"/>	Damper motor test operation (test operation when ON)
8	<input checked="" type="checkbox"/>	<input type="checkbox"/>	Solenoid valve test operation for humidifier water supply (test operation when ON) Do not touch GUF-50/100RD3
9	<input checked="" type="checkbox"/>	<input type="checkbox"/>	
10	<input checked="" type="checkbox"/>	<input type="checkbox"/>	Auto-recovery during power failure (active when on)
			Power supply ON/OFF (test operation when on)

CHAPTER 3 ● Control System Design Section

SW2

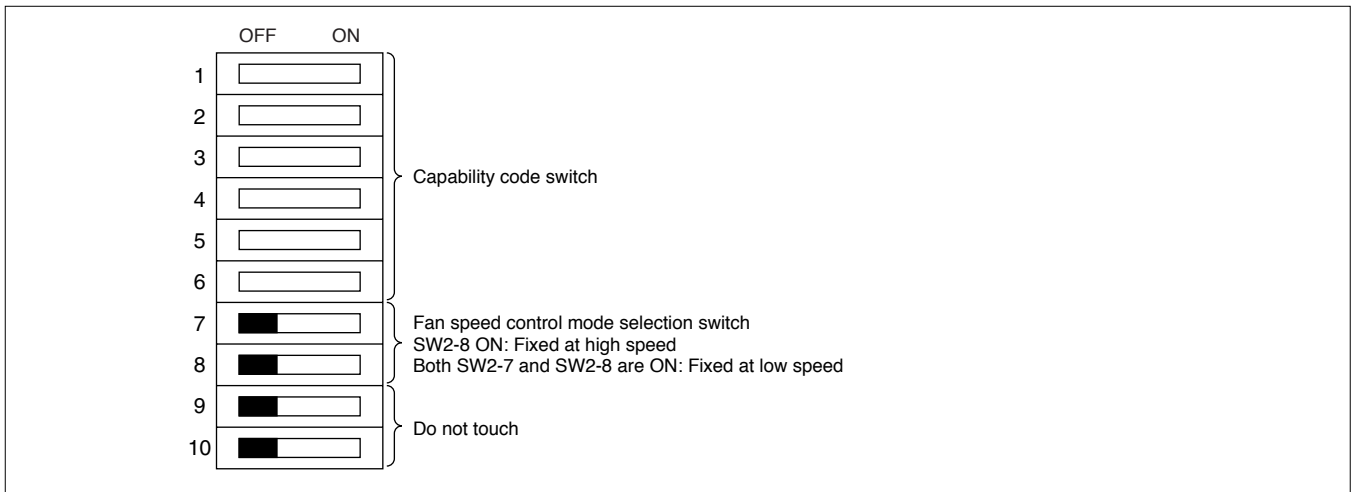

SW3 GUF-50/100RDH3

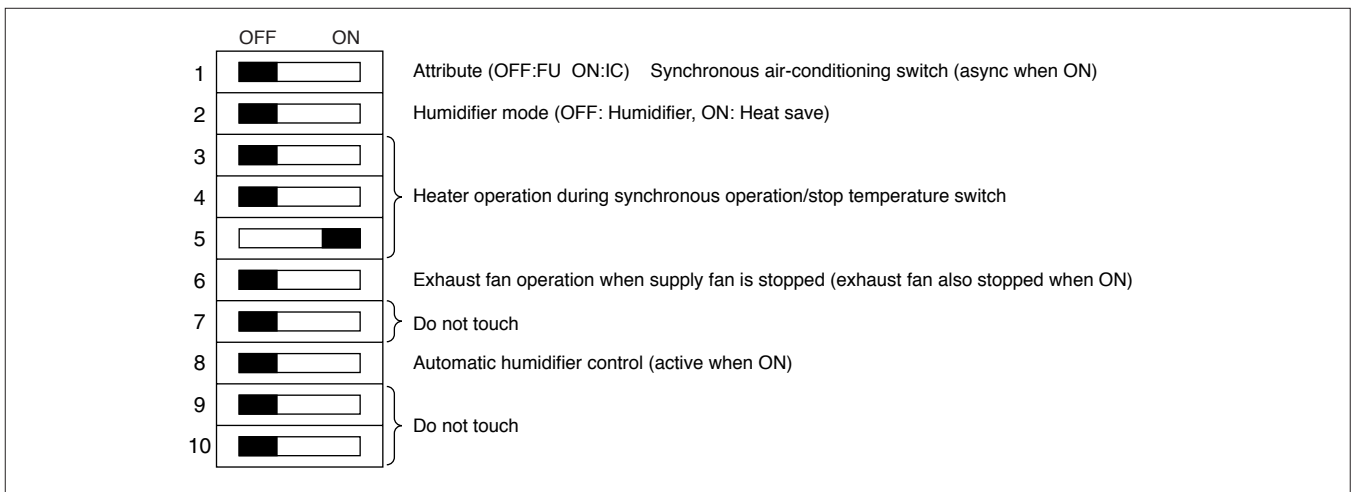

SW3 GUF-50/100RD3

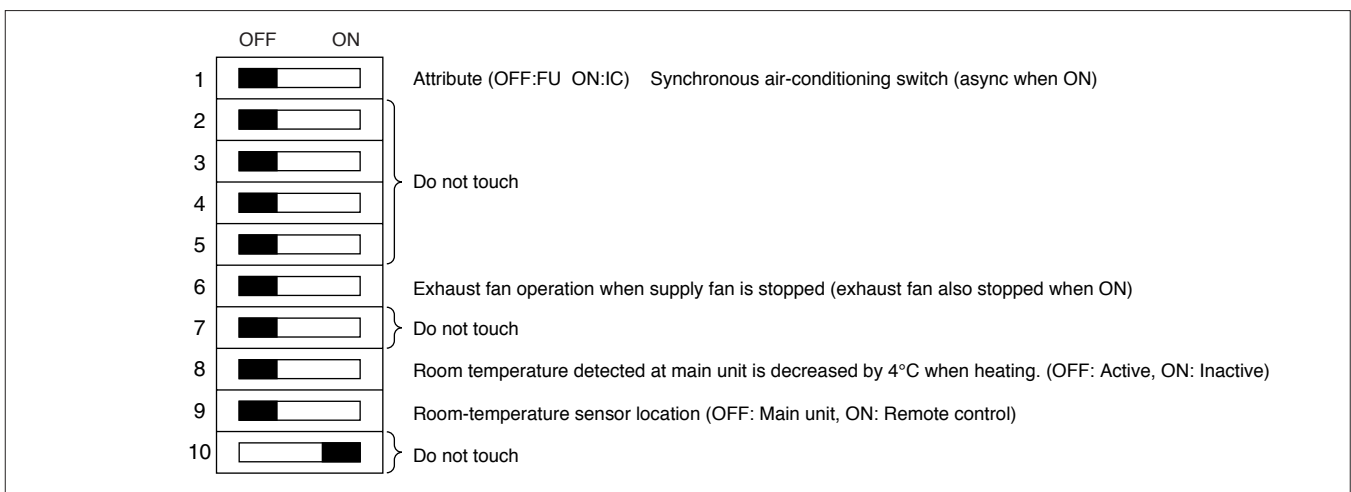

Note: ● The switches are shown as vertical for explanation purposes.

8.3.1 Filter maintenance time setting

Sets whether or not to display the filter maintenance indicator and the time at which the filter maintenance indicator will come on.

Switch	OFF	ON	Maintenance time
SW1	2	<input checked="" type="checkbox"/>	Filter maintenance display ON
	2	<input type="checkbox"/>	Filter maintenance display OFF*
	3 4	<input checked="" type="checkbox"/>	3,000 hours*
	3 4	<input checked="" type="checkbox"/>	1,500 hours
	3 4	<input checked="" type="checkbox"/>	4,500 hours
	3 4	<input checked="" type="checkbox"/>	Unrestricted

When the cumulative operation time reaches the set time, the filter maintenance indicator on the remote controller comes on.

After cleaning the filter, press the filter button twice to reset the cumulative operation time.

8.3.2 Power-failure auto-recovery select (independent OA processing unit)

Sets the type of recovery for the OA processing unit following a power failure.

Switch	OFF	ON	Mode
SW1	9	<input checked="" type="checkbox"/>	OA processing unit stopped when power failure is recovered.*
	9	<input type="checkbox"/>	OA processing unit recovers to the state prior to the power failure.

8.3.3 Power ON feature

Sets whether or not the OA processing unit operates when the main power is turned ON.

Switch	OFF	ON	Mode
SW1	10	<input checked="" type="checkbox"/>	Inactive: Operates according to the SW1-9 setting*
	10	<input type="checkbox"/>	Active: Operation starts with power ON

8.3.4 Indoor unit and synchronous setting

Sets whether or not there is synchronization with the indoor unit.

Switch	OFF	ON	Mode
SW3	1	<input checked="" type="checkbox"/>	Synchronized with the indoor unit.*
	1	<input type="checkbox"/>	Asynchronous with the indoor unit. Only operates by Remote controller.

8.3.5 Humidifier mode selection GUF-50/100RDH3 only

Sets the humidifier mode.

Switch	OFF	ON	Mode
SW3	2	<input checked="" type="checkbox"/>	Standard humidifier mode*
	2	<input type="checkbox"/>	Heat save humidifier mode (see below)

Used when operating only the OA processing unit and the temperature during heating becomes too hot. The heating capability can be saved at a lower temperature than normal.

8.3.6 Heat operation stop temperature setting (GUF-50/100RDH3 only)

Sets for synchronized stopping during heating operation with the indoor unit.

Switch	OFF	ON	Set outside temperature	OFF	ON	Set outside temperature		
SW3	3	4	6°C	3	4	10°C*		
	4	5		5				
	3	4		7°C	3		4	12°C
	5	3		8°C	4		5	14°C
	3	4	9°C	3	4	16°C		
	5			5				

8.3.7 Exhaust fan operation setting

Sets the exhaust fan operation. Note that the supply fan will stop during defrosting or when recovering refrigerant.

Switch	OFF	ON	Mode
SW3	6		Exhaust fan in operation even when the supply fan is stopped.*
		6	Exhaust fan is stopped when the supply fan is stopped.

8.3.8 Automatic humidifier control setting (GUF-50/100RDH3 only)

Normally, the permeable-film humidifier is supplied with water for humidifying when heating. This function can automatically stop the water supply depending on the outside temperature.

Switch	OFF	ON	Mode
SW3	8		Automatic humidifier control prohibited.* Water is supplied to the permeable-film humidifier constantly during heating.
		8	Automatic humidifier control permitted. Water is supplied to the permeable-film humidifier during heating only when the outside temperature is below 12°C.

8.3.9 Fan speed control mode

Sets whether to operate according to the fan speed selected from controllers or at high or low speed.

Switch	OFF	ON	Mode
SW2	7 8		Follows the selected fan speed from controllers.*
	7 8		Follows the selected fan speed from controllers.
	7 8		High fan speed mode (constantly on high)
	7 8		Low fan speed mode (constantly on low)

8.3.10 Room temperature control (GUF-50/100RD3 only)

Sets for room temperature detected at main unit to be decreased by 4°C when heating.

Switch	OFF	ON	Mode
SW3	8		Enabled*
	8		Disabled

8.3.11 Room temperature sensor position (GUF-50/100RD3 only)

Switch	OFF	ON	Mode
SW3	9		OA processing unit's return air*
	9		Built in the Remote controller.

8.3.12 Output signal mode selection switch

The following output signals can be fetched by using an optional remote display adapter.

Switch	OFF	ON	Mode
SW1	5		Run, Error, Heat, Cool, <u>Air Supply Fun ON</u> *
	5		Run, Error, Heat, Cool, <u>Compressor ON</u>

8.3.13 Input signal mode selection switch

The input signals (Run/Stop and Forced Compressor Stop) of connectors CN51 and CN52 can be switched as follows:

Switch	OFF	ON	Mode
SW1	6		CN51 [1] – [2] Run/Stop Pulse Input CN52 [1] – [5] Forced Compressor Stop Input* (Run/Stop switches each time a pulse signal is input.)
	6		CN51 [1] – [2] Run Pulse Input CN52 [1] – [5] Stop Pulse Input

8.3.14 Capability code switch

This switch is used to set the capability code. Since it is preset at the factory, there is normally no need to set this switch.

Switch	OFF	ON	Capability code	Model	OFF	ON	Capability code	Model
SW2	1 2 3 4 5 6		6	GUF-50RDH3 GUF-50RD3	1 2 3 4 5 6		13	GUF-100RDH3 GUF-100RD3

* Factory setting.

9. How to Operate

9.1 When interlocked using with an indoor unit

- Operation will be synchronized with an indoor unit.
- The humidifier will be operated by the heating signal received from the indoor unit. (For GUF-50/100RDH3)
- In the case of GUF-50/100RDH3, there is no temperature control since the temperature is adjusted according to the outside air temperature.

Starting and stopping operation

- Using the Remote controller to start or stop the indoor unit will automatically start or stop the OA processing unit.

Operation modes

- The OA processing unit will operate in the same mode as the synchronized indoor unit (heat, cool and air blow).
- The OA processing unit will be cool when the indoor unit is operated in dry mode.

When using with multiple indoor units

- When using with multiple indoor units that are set differently, the OA processing unit will operate in the mode with priority of: heat, cool and air blow.

When operating only the OA processing unit

- The OA processing unit can be operated independently by pressing the Ventilation button on the Remote controller (in this case, the operation mode will be air blow).
- Pressing the Ventilation button each time will switch the display between Stop, Low and High.

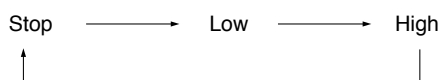

9.2 When not interlocked

- GUF-50/100RD3 will adjust the temperature according to the indoor temperature set using the Remote controller.
- In the case of GUF-50/100RDH3, there is no temperature control since the temperature is adjusted according to the outside air temperature.

9.2.1 Before starting operation

- Make sure that the power supply is turned ON before use.
(Keep the power supply turned ON at all times when the OA processing unit is in use. Use of the unit without power can result in compressor failure.)
- Start running after the “HO” display has disappeared. The “HO” display briefly appears on the room temperature display (max. 10 minutes) when the power is turned on and after a power failure. This does not indicate any failure of the OA processing unit.
- The operation modes of the OA processing unit air-cooling operation and heating operation are different from those of the outdoor units.

When the operation is started with cooling/heating and other indoor units or the OA processing unit connected to the counterpart outdoor units are already running in the same operation mode, the Remote controller displays air-cooling/heating mode. However, the operation comes to stop, and you cannot get a desired mode. When this occurs, you will be notified by the “cool” or “heating” display that flashes in the liquid crystal display of the Remote controller. Set to the operation mode of other indoor unit or the OA processing unit by the operation switch button.

The above does not apply to the models that simultaneously run both the cooling operation and heating operation.

- The outdoor units stop when all the indoor units and the OA processing unit connected to the counterpart outdoor units stop.
- During heating operation, even if the indoor unit or the OA processing unit is set to operation while the outdoor unit is in defrosting operation, operation starts after the defrosting operation of the outdoor unit has ended.

Warning:

Check and confirm the power circuit before use. For contents, refer to the previously described chapter [Crucial points to be observed for safety].

9.2.2 ON/OFF

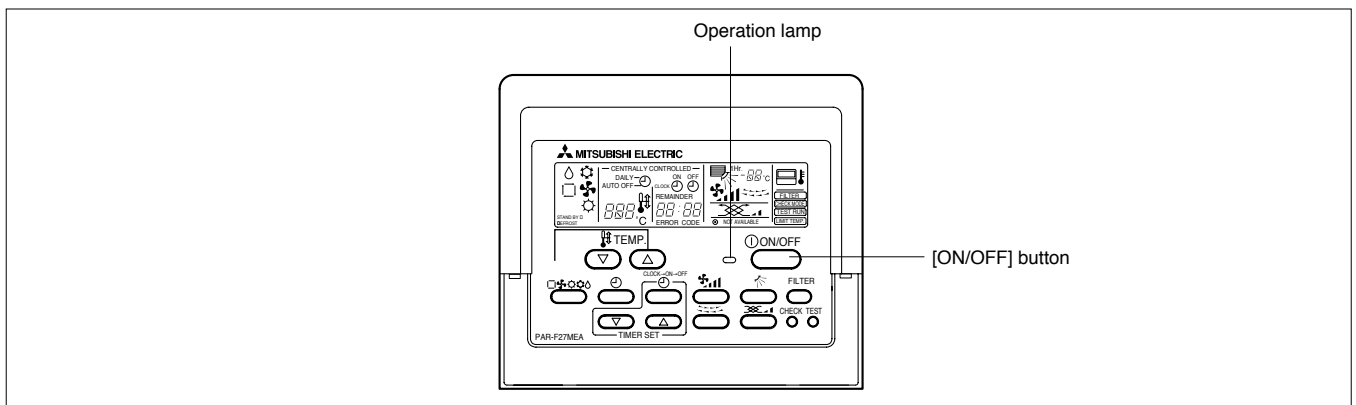

Start an operation

Press [ON/OFF] button

Operation lamp lights up and operation starts.

Stop an operation

Press the [ON/OFF] button again

Operation lamp goes off and operation stops.

- Once the buttons have been set, pressing of the [ON/OFF] button only can repeat the same operation thereafter.
- During operation, the operation lamp above the [ON/OFF] button lights up.

Caution:

Even if the operation button is pressed immediately after the operation is one stopped, operation is not restarted for about 3 minutes. This function protects the machine. It automatically starts operation after the lapse approximately 3 minutes.

9.2.3 Selecting operation

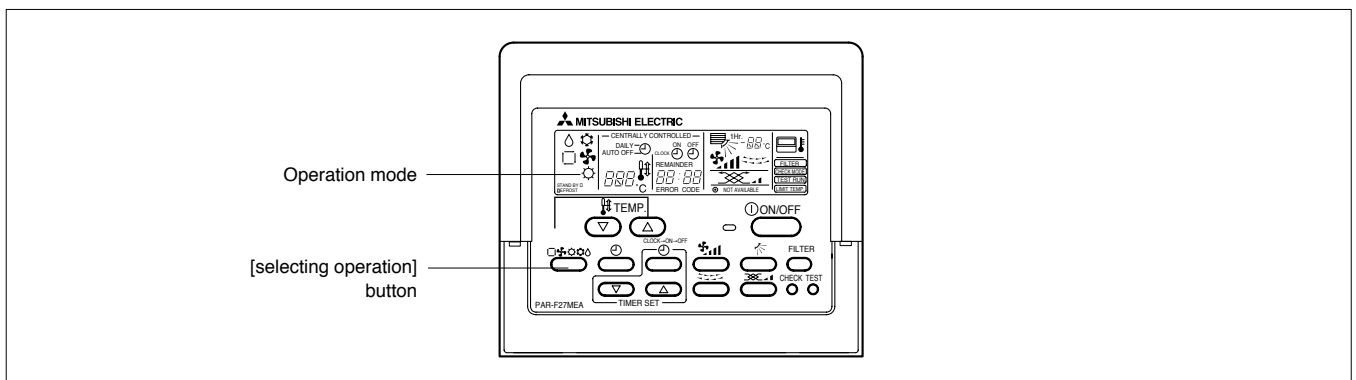

When selecting operation

Press the [selecting operation] button

- Consecutive press of the selecting operation button switches the operation over to “cooling,” “air blow,” “(automatic),” and “heating.” For the contents of operation, check the display.

For cooling

Press the [selecting operation] button and bring up the “cooling” display.

Caution:

Never expose your body directly to cool air for a long time. Excessive exposure to cool air is bad for your health, and should therefore be avoided.

For air blow

Press the [selecting operation] button and bring up the “air blow” display.

- The air blow operation functions to ventilate.
- The temperature of the room cannot be set by air blow operation.

For heating

Press the [selecting operation] button to bring up the “heating” display.

Regarding displays during heating operation “Under defrosting”

Displayed only during the defrosting operation.

“Under preparation for heating”

Displayed from the start of heating operation until the moment warm air blows out.

- When in the “heating” mode, the humidifier will also operate. (For GUF-50/100RDH3)

Caution:

- When the OA processing unit is used together with burners.
- Never place a burner at a place where it is exposed to the airflow from the OA processing unit. Doing so can result in imperfect combustion of the burner.
- The microcomputer functions in the following cases:
 - The intake fan is not moving at the set speed.
 - Intake fan stops to prevent any cool air from escaping during the defrosting operation.

9.2.4 Temperature adjustment

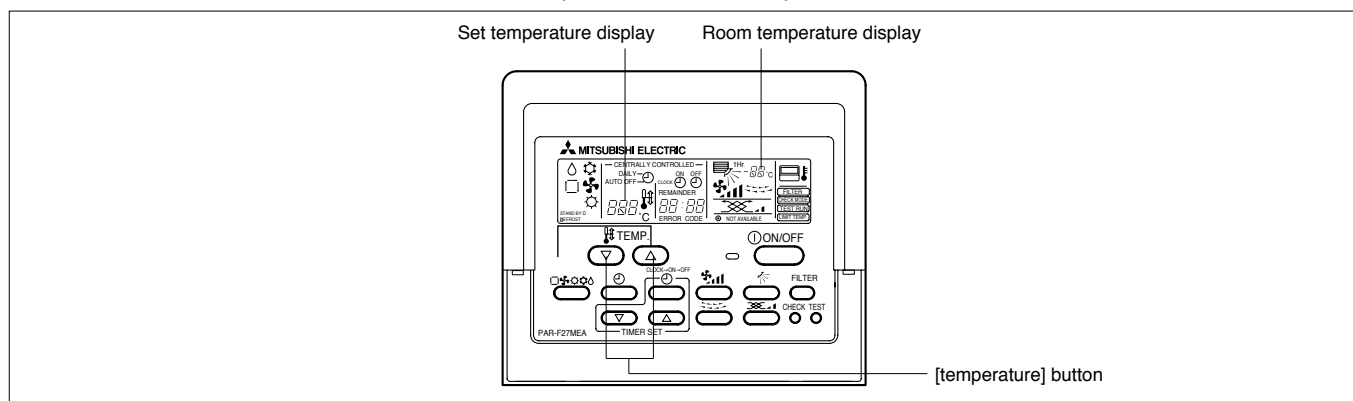

GUF-50/100RDH3 are OA processing unit and cannot adjust the indoor temperature, even if the procedures given below are followed.

In the case of GUF-50/100RD3, the indoor temperature can be adjusted.



To change temperature

Press the temperature button and set the temperature of your choice

Pressing  or  once changes the setting by 1°C.

If the pressing is continued, the setting continues to change by 1°C.

- Indoor temperature can be set within the following range.

Cooling/dry	19°C to 30°C	[In the case of GUF-50/100RDH3, set the temperature the same as the Indoor unit.]
Heating	17°C to 28°C	

- It is impossible to set the temperature by the air-blow operation.

* The range of temperature display is 8°C to 39°C. Outside this range, the display flashes either 8°C to 39°C to inform you if the temperature is lower or higher than the displayed temperature.

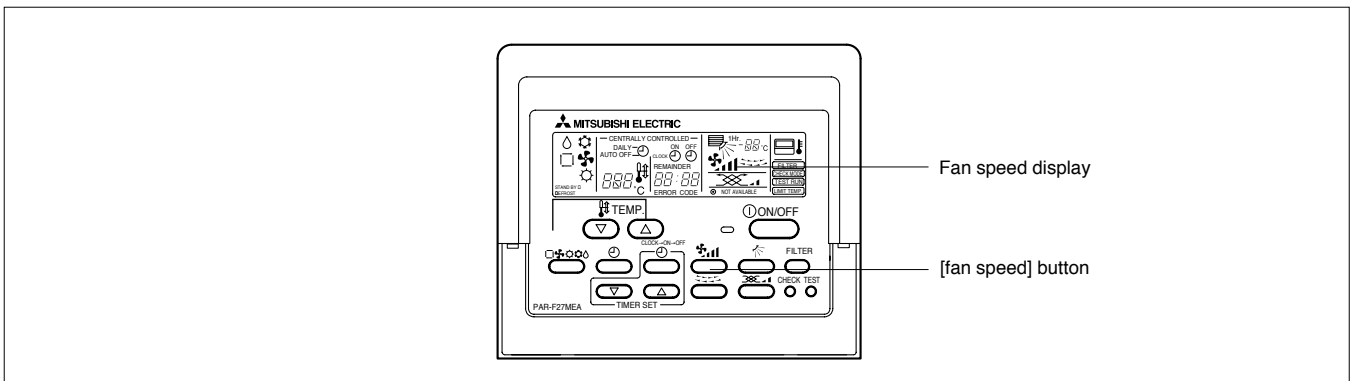

9.2.5 Fan speed adjustment



To change fan speed

Set the desired fan speed

Every time you press the [fan speed] button once, it switches from the low-speed or high-speed settings successively.

Display of the Remote controller	
Low	High
	

- * Every time the fan speed adjustment button is once pressed, the fan speed is changed.

9.2.6 Time setting

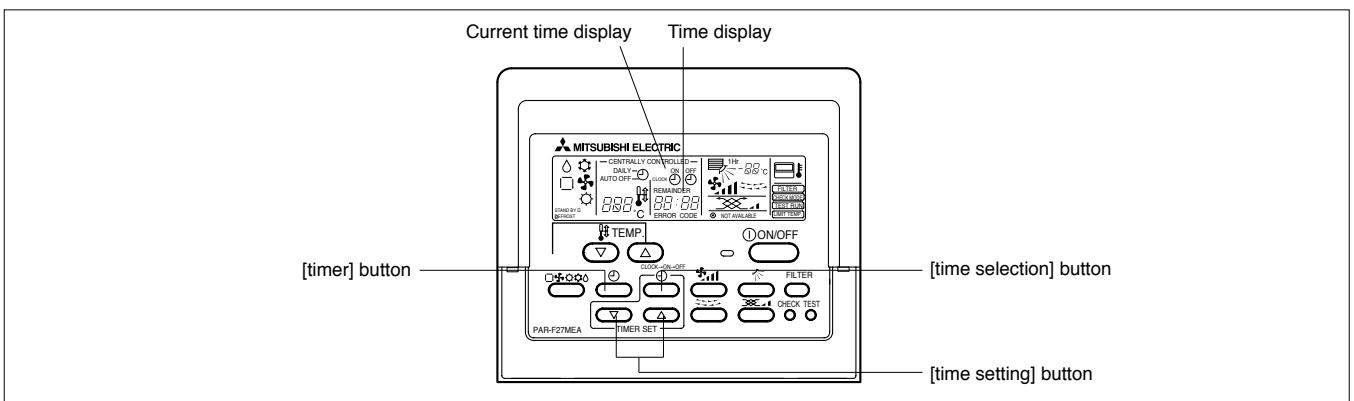

CHAPTER 3 ● Control System Design Section

- Set the current time after turning ON the power of the OA processing unit or after restoration from a power failure.
- It can be set regardless of the operation of the OA processing unit.
- During the time operation, the time-setting button becomes void, disabling time setting.

Press the [time selection] button and bring up the “current time” display



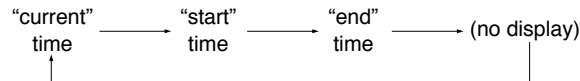



- Every time it is pressed, the display changes.



Caution:

When the current time is not yet set, the “current” time display flashes, disabling the setting of timer operation.

Set the current time by pressing the time setting  or  button

- The time cannot be set while the “[timer]” is displayed.
- While the “CLOCK” time is displayed, press the time setting / buttons and set the time.
- The setting advances one minute every time the  button is pressed once, and retrogresses one minute every time the  button is pressed once.
When respective / buttons are pressed continuously, the time display goes fast forward. It advances in the order of 1 minute digit - 10 minute digit - one hour digit.
- About 10 seconds after the button operation has been completed, the “current time” and “time” displays disappear.

Caution:

- The Remote controller is equipped with a simplified clock with a precision of about + or - one minute per month.
- The time must be readjusted (reset) every time the OA processing unit is subjected to a power stop or a power failure.

9.2.7 Timer setting

- If the timer is set, the unit starts (stops) at the set time, and the time mode is terminated.
- When you wish to confirm the starting and ending time, press the [time selection] button while [timer] is displayed.

Function of timer

On-timer

Set the on-timer for the time the working day begins in your company.

When the set start time arrives, the OA processing unit starts operation.

Off-timer

Use the off-timer as a reminder to turn off the OA processing unit. When the set end-work time arrives, the OA processing unit stops operation.

There are three methods for using the timer.

- 1.ON/OFF Timer When setting both starting and ending time
- 2.On-timer When only setting the starting time (Ending time is set to “__ : __”)
- 3.Off-timer When only setting the ending time (Starting time is set to “__ : __”)

Display example of timer setting

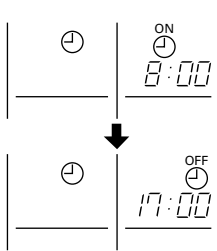

The example shows a timer set for operation start at 8:00 and end at 17:00.

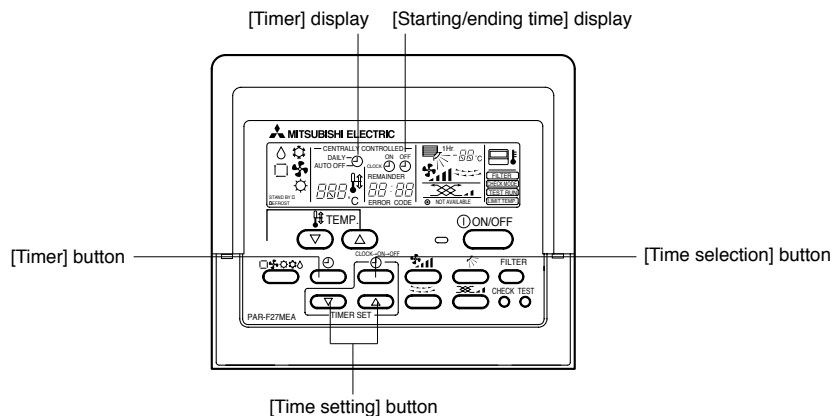

- 1) Press the [timer] button and erase the “timer” display
- 2) Press the [time selection] button and bring up the “starting time” display
- 3) Press the () button of the [time setting] and set the starting time
When using it as an off-timer, set the starting time to “__ : __”.
The “__ : __” is displayed next to 23:50.
- 4) Press the [time selection] button and bring up the “ending time” display
- 5) Press the () button of the [time setting] and set the ending time
When using it as an on-timer, set the ending time to “__ : __”.
The “__ : __” is displayed next to 23:50.
- 6) Press the [timer] button and bring up the “timer” display
Bringing up the [timer] display completes the setting.

Every time the () button of the [timer setting] is pressed once, it advances (or retrogresses) by 10 minutes.

If the button is pressed continuously, it advances (or retrogresses) continuously.

First set the hour digit and then set the minute digit.

When the ON/OFF timer mode is set, you can run (on-timer) or stop (off-timer) operation by pressing the [ON/OFF] button even when there is remaining time.

Release

Press the [timer] button and erase the “timer” display.

10. System Component

In a multi air conditioner system that is a free plan direct-expansion type, a connector for inputting and outputting signals to/from the outside is fitted as standard on the control board of OA processing unit. Use this when you want the unit to input/output signals individually. (Note: When there are many control units it is recommended that you use MELANS. This would enable you to save on labor.) In order to have an input output signal from each connector, you must have a dedicated adapter (sold separately) and a relay circuit (onsite arrangements).

Note: See next page for actual examples of use.

Types of control that uses connectors for OA processing unit input output signal (connection for each type of option)

Category	Application	Function	Connector
Input □ (Note 2,3)	Method of ON/OFF control by turning on and off switches or contacts from an outside to each OA processing unit group. □ Can be used as a Remote ON/OFF adaptor (Note 1) □ Can be used as a "forget to switch off prevention" or "forced stop".	Distant/local □ switching (Note 1)	CN32
		ON/OFF (level)	
	Method of ON/OFF control by inverting start/stop using external pulse (a-contact) for each OA processing unit group.	ON/OFF (pulse)	CN51
Output	Method of sending signals to outside for each OA processing unit group. □ It can be used as a device to display operation states. □ It can be used as an interlocked control with the external equipment.	Operation state	CN51
		Error state	
		Operation mode □ (heat) state	CN52
		Operation mode □ (cool) state	
Thermo ON state or □ Fan state (Note 8)			

Note 1: Connect the signal input only to the principal unit in a group. □

□ (However, the demand input is required to enter into OA processing units individually.) □

Note 2: When using start/stop input at group operation, Local remote controller is necessary. □

□ (MA Remote controller or M-NET remote controller) □

Note 3: When setting to Remote, operation can not be performed from Local remote controller. □

□ The remote controller displays [CENTRALLY CONTROLLED]. □

Note 4: When using start/stop input at group operation, [Automatic address start-up] can not be performed. □

Note 5: When CN51 or CN52 is commonly used as an output signal, be sure to use the remote display adaptor. □

Note 6: The remote display adaptor can be used for the input signal of CN51 and CN52. □

Note 7: Connect to the principal unit only when using [Operating state] or [Operation mode (Heating/Cooling-Dry)] of signal output. Connect to OA processing unit individually when using [Error state] or [Thermo ON (or fan) state] □

Note 8: [Thermo ON state] or [Fan state] is selected according to the setting of SW1-5.

It is possible to have ON/OFF control by turning OA processing unit power on and off. You can select functions by setting the DIPSW1-9 and 1-10 on the OA processing unit.

Types of ON/OFF control (OA processing unit settings)

It is possible to have ON/OFF control for each OA processing unit (or group) by dip switches 9 and 10 (SW1-9, SW1-10) of the OA processing unit.

Function	Operation when OA processing unit	Setting SW2 (Note 1)	
		9	10
All auto restart	All OA processing units will always restart regardless of the state that was before the power was turned off (POWER OFF) (after 5 minutes).	–	ON
Auto recovery	OA processing units which are operated before the power was turned off (POWER OFF) will restart (after 5 minutes).	ON	OFF
All OFF	Operation stays stopped regardless of the state that was before the power was turned off.	OFF	OFF

Note 1: The DIP switch setting for all units in the OA processing unit group is required.

Note 2: Do not cut-off the power to the outdoor unit. If you do, it will disconnect the power to the crank-case heater of the outdoor unit and that could cause damage to the compressor.

Description of when using distant/local switching (CN32)

SW1□ Local switching	SW2 ON/OFF	State	Remote controller display/operation
OFF	OFF	Local / Permit	The operation permit
ON	OFF	Distant / Stop	It displays "CENTRALLY CONTROLLED", while the state is distant. It prohibits ON/OFF operation of remote controller.
ON	ON	Distant / Operate	

System example

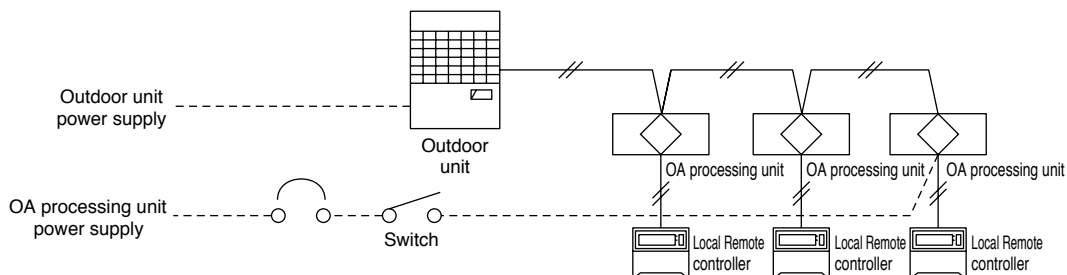

When the power to the outdoor unit is cut-off for a long time, the crankcase heater for the compressor also stops. If the compressor is started soon after the power is restored, there is a chance that a fault will occur in the compressor.

When using the above function, make sure the power to the outdoor units will not be cut-off.

Limitations to combining system controls

	Description	Control combining distant/local	Pulse ON/OFF	Power ON/OFF	Automatic recover
1	Control combining distant/local	CN32	–	× *1	× *1
2	Pulse ON/OFF	CN51	–	○	○
3	Power ON/OFF	–	○	–	×
4	Automatic recover	–	○	–	–

*1: Pulse ON/OFF, Power ON/OFF and automatic recover can only be used when the distant/local setting (CN32) is set to local. Therefore, always avoid this function when combining control.

CHAPTER 3 ● Control System Design Section

OA processing unit input/output connector

- ON/OFF (Pulse) input specification

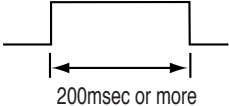
Item	Description
Input signal	Pulse sign (a connect)
Standard of pulse	 <p>200msec or more</p>

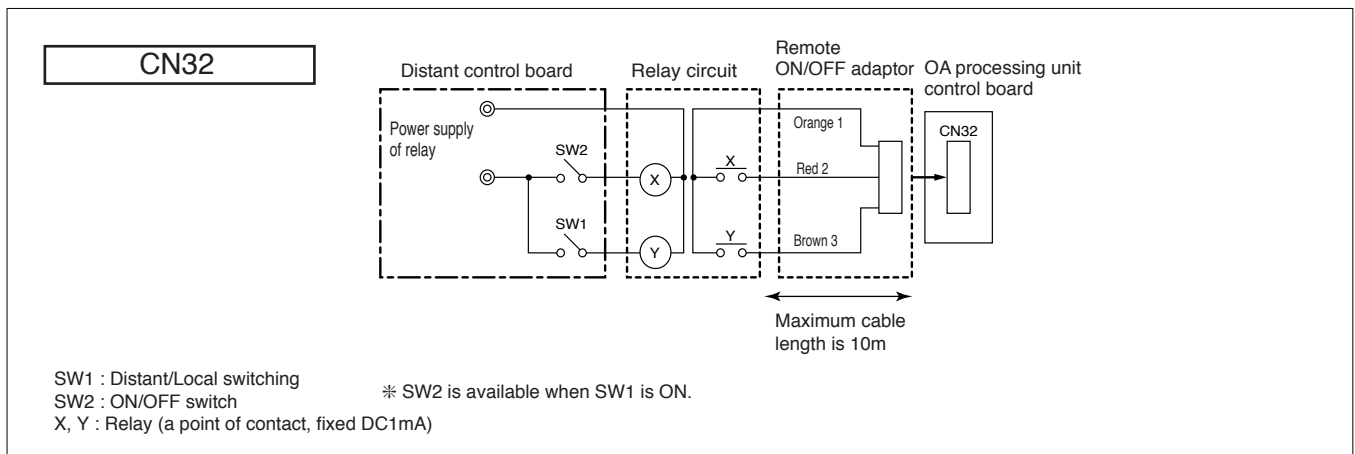
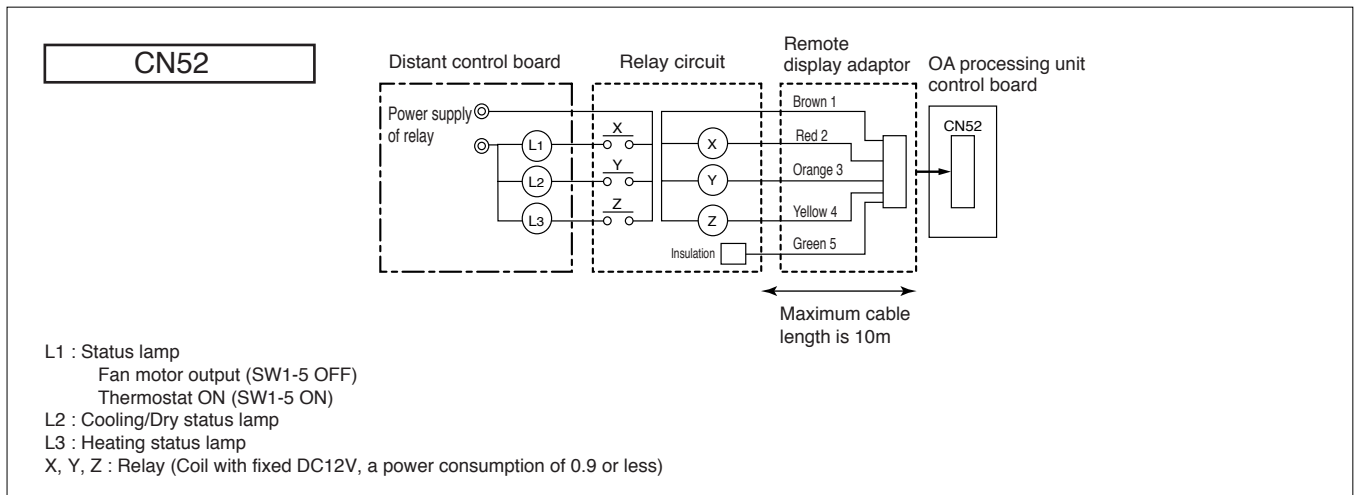
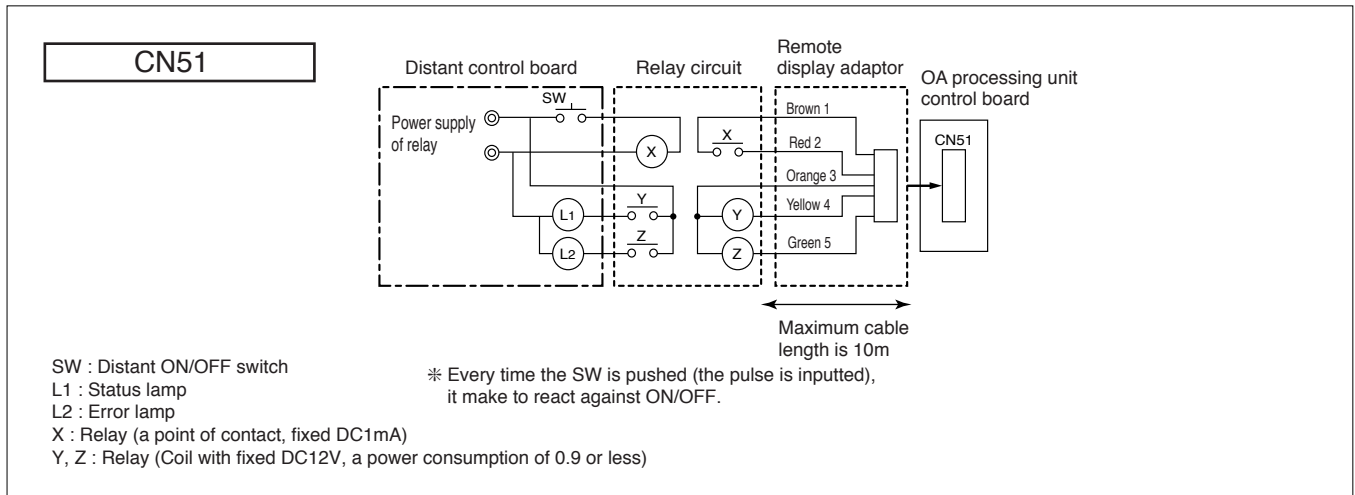

11. Troubleshooting

Before you ask for repair service, check the following points:

State of Machine	Remote Controller	Cause	Troubleshooting
Does not operate.	“●” display is not lit up and no display appears when the [ON/OFF] button is pressed.	Power failure	Press the [ON/OFF] button after power has been restored.
		The power supply is turned OFF.	Turn the power supply ON.
		The fuse in the power supply is burned out.	Replace fuse.
		The ground fault circuit breaker has tripped.	Reset the ground fault circuit breaker.
Cool air or warm air does not come out.	The LCD screen shows that it is in operation.	The restart protection delay circuit is in operation 3 minutes.	Wait for a while. (To protect the compressor, a 3 minutes delay circuit is built into the OA processing unit. Therefore, there are occasions sometimes when the compressor will not start operating immediately. There are cases where this delay may be up to 3 minutes.)
		OA processing unit operation has restarted following the heating and defrosting operation.	Wait for a while. (Heating operation starts after defrosting operation has ended.)
It runs briefly, but soon stops.	The (CHECK) and check code flashes on the LCD screen.	The air inlet or outlet of the OA processing unit and/or outdoor unit is obstructed.	Restart after removal of obstruction.
		The filters are clogged with dust and dirt.	Restart after cleaning the filters.
Does not humidify (GUF-50/100RDH3 only)	--	The OA processing unit is not set to the “☀ heating” mode.	Set to heating mode.
		Water is not supplied.	Open the service valve.
Dry mode cannot be set from Remote controller.	--	There is no dry mode on the OA processing unit. Cannot set to dry mode from Remote controller.	Use a mode other than dry mode.
Dry mode can be set from central controller, but does not operate.	Dry mode display is flashing in LCD.	When the unit is set to dry mode from the central controller, the dry mode display flashes on the LCD and the OA processing unit fan operates.	

- If operation stops due to a power failure, the delay protection functions and disables operation even after power restoration. Press the [ON/OFF] button again and start operation.
- If malfunctions persist after you have checked the above, turn the power supply OFF and contact your dealer with information about the product name, the nature of the malfunction, etc. If the display of (CHECK) and (4 digit) check code flashes, tell the dealer that code. Never attempt to repair by yourself.

The following symptoms are not the OA processing unit failures:

- The air blown out from the OA processing unit can sometimes give off odors. This is due to cigarette smoke contained in the air of the room, or odors from cosmetics, the walls, furniture, etc., that have been absorbed in the OA processing unit.
- A hissing noise can be heard immediately after the OA processing unit is started or stopped. This is the sound of the refrigeration flowing inside the OA processing unit. This is normal.
- The OA processing unit sometimes snaps or clicks at the beginning or end of cooling/heating operation. This is the sound of friction on the metal sections due to expansion and contraction caused by temperature change. This is normal.

12. Remote Controller Check Code List

See below for possible remedies when there is an error during test operation and (CHECK) followed by a 4-digit number is displayed on the network remote controller.

Error code	Error content	Cause	Remedy
0900	Test run	<ul style="list-style-type: none"> Is the test operation SW for the air blow, humidifier solenoid valve or bypass damper turned ON? 	<ul style="list-style-type: none"> Set the test operation SW (SW1-1, 7, 8) to OFF.
2600	Drain error	<ul style="list-style-type: none"> Is there a leak from the permeable-film humidifier pipe? Is there a leak from the permeable-film humidifier? Drain pipe is clogged and water is not draining. When no problem is discovered after checking the above items. 	<ul style="list-style-type: none"> Fix the water leak. Replace the permeable-film humidifier. The body must be levelly installed and the drain pipe must have a gradient of more than 1/100. Replace the PCB (printed circuit board).
2601	Disconnected water sensor connector	<ul style="list-style-type: none"> Is the CN4D connector firmly connected? Is the relay connector between the PCB and water sensor firmly connected? When no problem is discovered after checking the above item. 	<ul style="list-style-type: none"> Firmly connect the connector. Firmly connect the connector. Replace the PCB (printer circuit board).
3602	Damper motor error	<ul style="list-style-type: none"> Is the CNL and/or CN27 connector firmly connected? Is the connector of the damper motor section firmly connected? Does the damper operate when the damper motor is running? When no problem is discovered after checking the above items. 	<ul style="list-style-type: none"> Firmly connect the connector. Firmly connect the connector. Replace the damper motor if not working. Replace the PCB (printed circuit board).
4116	Fan motor error	<ul style="list-style-type: none"> The motor continues to run when the operation is stopped. 	<ul style="list-style-type: none"> Replace the PCB (printed circuit board).
5101	Indoor temperature sensor error	<ul style="list-style-type: none"> Are the connectors of each thermister firmly connected? 	<ul style="list-style-type: none"> Firmly connect each connector.
5102	Liquid pipe temperature sensor error	<ul style="list-style-type: none"> Is each relay connector firmly connected? When no problem is discovered after checking the above item. 	<ul style="list-style-type: none"> Firmly connect each connector. Replace the PCB (printed circuit board).
5103	Gas pipe temperature sensor error		
5104	Outdoor temperature sensor error		
H0	Booting system	<ul style="list-style-type: none"> Has 10 minutes passed since system boot-up? Has group registration been made? Has the OA processing unit address been changed? When no problem is discovered after checking the above items. 	<ul style="list-style-type: none"> After system boot-up, HO may flash for up to 10 minutes. However, this is not a malfunction. Conduct group registration. If there is a master system controller such as the central controller, use the controller to conduct group registration. If the OA processing unit main unit address has been changed, conduct the group registration again. If HO continues to flash for more than 10 minutes after reregistering the group and rebooting, replace the PCB (printed circuit board).
—	Unable to register.	<ul style="list-style-type: none"> The OA processing unit which is interlocked with the indoor unit cannot be group registered other than the interlock setting with remote controller. 	<ul style="list-style-type: none"> Change the setting of the SW3-1 switch and reset the registration or register it as interlocked.
—	Operation display comes up with the network remote controller, however it turns off immediately.	<ul style="list-style-type: none"> Main power hasn't supplied to the OA processing unit. Maintenance power switch of the OA processing unit is turned OFF. 	<ul style="list-style-type: none"> Supply Main Power. Turn ON the Maintenance power switch.

13. Circuit Test Point

