



# INSTALLATION MANUAL FOR A-M CONVERTER

This manual is written only for the models  
 PU(H)-P1 ~ 4VGA(A), PU(H)- P25 ~ 100VGAA  
 PU(H)-P1.6 ~ 6YGA(A), PU(H)-P35 ~ 140YGAA,  
 PUHZ-RP1.6 ~ 6VHA(-A), PUHZ-RP35 ~ 140VHA(-A)  
 PUHZ-RP4 ~ 6YHA, PUHZ-RP100 ~ 140YHA  
 PUHZ-RP8/10YHA(-A), PUHZ-RP200/250YHA(-A)  
 PUH-P8/10YE, PUH-P8/10MYA, PUH-P200/250MYA

## SAFETY PRECAUTIONS

Before starting installation, read the "Safety Precautions" described below.  
 The following precautions must be observed as it describes the serious matters for safety.  
 The safety precautions are described with the degree of danger.

 <b>WARNING</b>	When you handle wrong, it can lead to death or serious injury.
 <b>CAUTION</b>	When you handle wrong, it can lead to injury or damage to building and furniture.

After installation, make test operation and confirm that it works properly, and explain the safety precautions, operation method, and maintenance to your customers.  
 Tell your customers to keep this installation manual together with operation manual with them, and when they give or sell this machine to other person put this installation manual and operation manual with it.

### WARNING

<p><b>The installation must be done by dealer or qualified person.</b>                      If the customers do the installation by themselves and it is not perfectly installed it can cause water leak, electric shock, or fire.</p>	<p><b>The wiring must be securely done by using proper cable. The wires should be connected to the terminals not to have external force of the cable.</b>                      Unperfect connections can cause heat or fire.</p>
<p><b>The installation must be done in accordance with this manual.</b>                      If the installation is not perfectly done, it can cause water leak, electric shock, or fire.</p>	<p><b>The terminal cover (panel) of the unit must be installed securely.</b>                      Unperfect installation can cause fire or electric shock by dust or water.</p>
<p><b>Never try any modification.</b>                      For repair, ask your dealer.                      If the machine is modified or repaired unperfectly, it can cause water leak, electric shock, or fire.</p>	<p><b>The electric installation must be done by qualified person in accordance with this installation manual. Use the separate circuit only for this machine and use rated voltage and circuit breaker.</b>                      If the electric circuit power is not sufficient or the wiring is not properly done, it can cause electric shock or fire.</p>
<p><b>Never move or reinstall the machine by the customers.</b>                      If the installation is not perfectly done, it can cause water leak, electric shock, or fire. Ask your dealer or qualified person.</p>	

### Before electric wiring

### CAUTION

<p><b>Install a circuit breaker depending upon the location.</b>                      Without a circuit breaker, it can cause electric shock.</p>	<p><b>Put ground wire.</b>                      Never ground to gas pipe, water pipe, lightning conductor, or telephone ground wire.                      Unperfect ground can cause short-circuit.</p>
<p><b>Use standard wires which meet current capacity.</b>                      Otherwise, it can cause short-circuit, heat, or fire.</p>	<p><b>Use proper fuses</b>                      If you use larger size fuses or needle wire, it can cause failure or fire.</p>
<p><b>Wires must not have tension.</b>                      It can cause snipping, heat, or fire.</p>	

### Before test operation

### CAUTION

<p><b>Turn the power on 12 hours or more before operation.</b>                      If you start operation as soon as the power on, it can cause failure.                      Never turn the power off during season.</p>	<p><b>Never operate the switches with your hand wet.</b>                      It can cause electric shock.</p>
<p><b>Never operate the machine without panel or guard off.</b>                      It can cause serious injury being caught by rotating part or burn or electric shock by high voltage part.</p>	<p><b>Never touch refrigerant pipes while the machine running.</b>                      The refrigerant pipes becomes high and low temperature while the machine running. If you touch the pipes by hand, it can cause chilblain or burn.</p>
<p><b>Never operate the machine without air filter off.</b>                      It can cause failure by dust.</p>	<p><b>Never turn the power off as soon as the machine stops.</b>                      Wait for 5 minutes or more. It can cause water leak or failure.</p>

# 1. Parts List

Applicable models

A : PUHZ-RP1.6/2VHA( - A), RP35/50VHA( - A)







B : PUHZ-RP2.5 ~ 6VHA( - A), RP60 ~ 140VHA( - A)

C : PU(H)-P1 ~ 4VGA(A), P25 ~ 100VGAA,  
PU(H)-P1.6 ~ 6YGA(A), P35 ~ 140YGAA

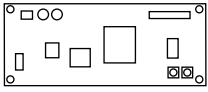
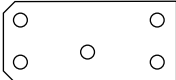
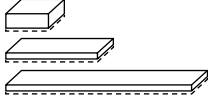
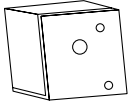
D : PUH-P8/10YE, P8/10MYA, P200/250MYA

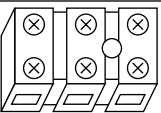
E : PUHZ-RP4 ~ 6YHA, RP100 ~ 140YHA

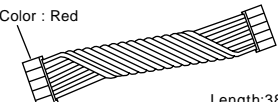
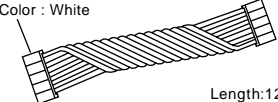
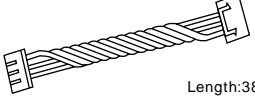
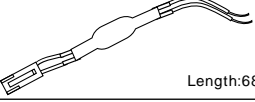
F : PUHZ-RP8/10YHA( - A), RP200/250YHA( - A)

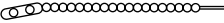
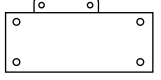
Description	Figure	Q'ty	Applicable models						Note
			A	B	C	D	E	F	
M-NET board (with insulation sheets and supports)		1							
Plate (For mounting circuit board)		1							
Insulation sheets		1							
		1							
		1							
Terminal base		1							
Screw (M4 x 8)		2	(1)		(1)	(1)	(2)		
Terminal block (M-NET)		1							
Terminal screw (M3x20)		1							
Label		1							
Lead wire-A (5 wires)		1						Wire Marking : R410A Always make sure that the markings and the applicable model match. If used incorrectly, parts could be damaged.	
Lead wire-B (5 wires)		1						Wire Marking : R407C Always make sure that the markings and the applicable model match. If used incorrectly, parts could be damaged.	
Lead wire-C (3 wires)		1							
Lead wire-D (2 wires)		1							
Ground wire and screw (M4 x 8)		1each							
Pull tight		2							
Plate 2 (For mounting circuit board)		1							

2. Installation procedure 【PU(H)-P1~4VGA(A), P25~100VGAA, PU(H)-P1.6~6YGA(A), P35~140YGAA】

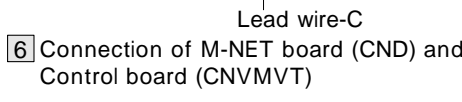
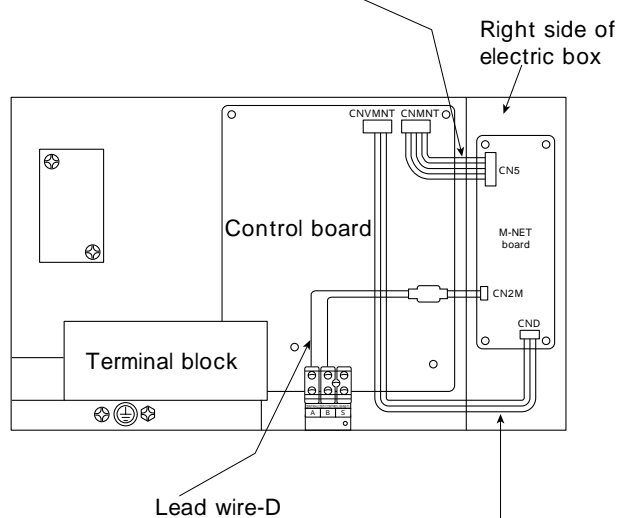
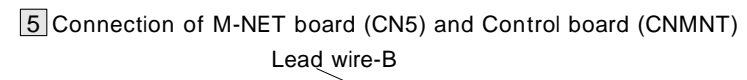
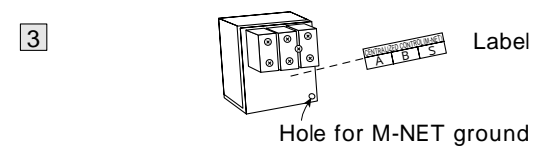
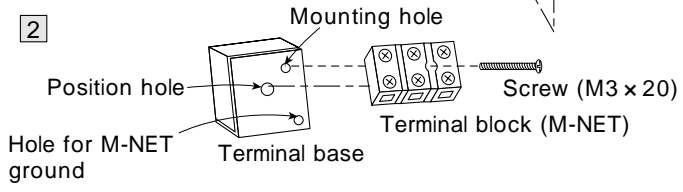
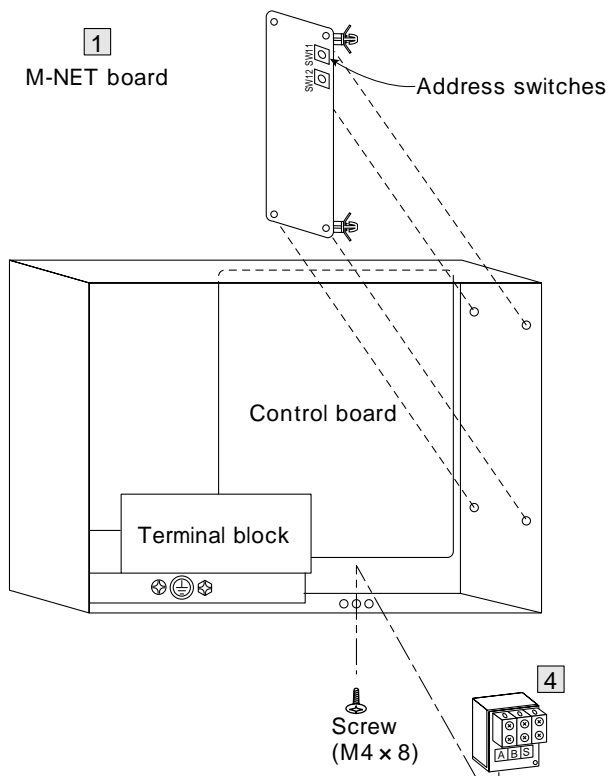

- 1 Install the M-NET board so that the (SW11, SW12) come front. Put it securely until it sounds click.
- 2 Install the Terminal block (M-NET) on the Terminal base. The Terminal base has round boss for positioning. Match the round boss to the holes of the Terminal base.
- 3 Put the Label on the Terminal base. Not to close the Hole for M-NET ground.
- 4 Install the Terminal base on the bottom inside of the electric box.

- 5 Connect the lead wire-B to both the connector CN5 on the M-NET board and the connector CNMNT on the control board.  
Caution  
Wire Marking:R407C, Connector color:White  
Always make sure that the markings and the applicable model match. If used incorrectly, parts could be damaged.
- 6 Connect the lead wire-C to both the connector CND on the M-NET board and the connector CNMNT on the control board.
- 7 Connect the lead wire-D to both the connector CN2M on the M-NET board and the terminals A & B on the terminal block (M-NET).
- 8 The lead wires should be tied together with the other lead wires with the pull tight not to loose. Wiring length is adjusted according to apparatus.

It progresses to the page " 3.Wiring method for M-NET "

Note1:Use ground wire and screw as required to connect the shield of M-NET transmission line to the unit.  
Note2:Take great care that no lead wire is caught on anything when installing panels.

## 2. Installation procedure 【PUH-P8/10YE, P8/10MYA, P200/250MYA】

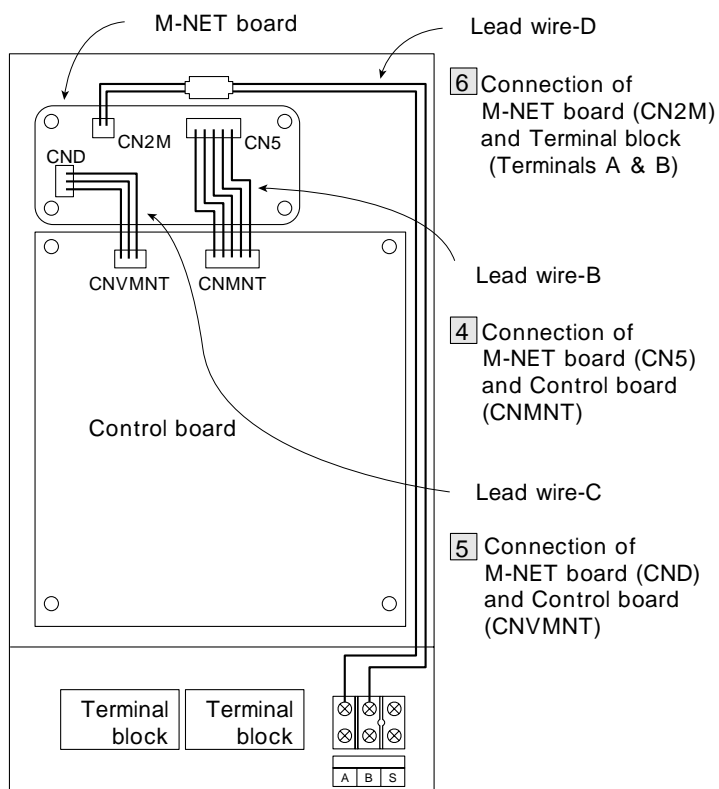
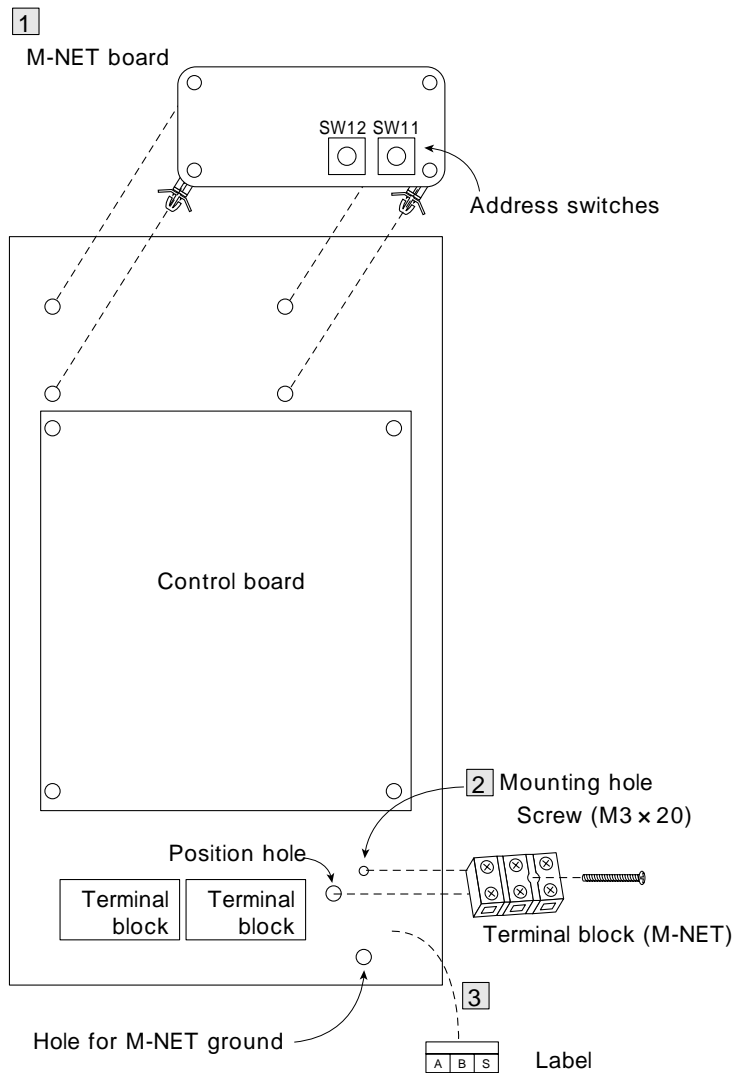

- 1 Install the M-NET board so that the (SW11, SW12) come front.  
Put it securely until it sounds click.
- 2 Install the Terminal block (M-NET) on the base of the electric box.
- 3 Put the Label on the base of the electric box.
- 4 Connect the lead wire-B to both the connector CN5 on the M-NET board and the connector CNMNT on the control board.  
Caution  
Wire Marking:R407C, Connector color:White  
Always make sure that the markings and the applicable model match. If used incorrectly, parts could be damaged.
- 5 Connect the lead wire-C to both the connector CND on the M-NET board and the connector CNVMNT on the control board.
- 6 Connect the lead wire-D to both the connector CN2M on the M-NET board and the terminals A & B on the terminal block (M-NET).
- 7 The lead wires should be tied together with the pull tight not to loose.  
Wiring length is adjusted according to apparatus.

It progresses to the page  
“ 3.Wiring method for M-NET ”

- Note1:Use ground wire and screw as required to connect the shield of M-NET transmission line to the unit.
- Note2:Take great care that no lead wire is caught on anything when installing panels.

## 2. Installation procedure 【PUHZ-RP1.6/2VHA( - A ), RP35/50VHA( - A )】

To protect the wires connected to M-NET board from the edges of sheet-metal component, paste the insulation on the edge surface of panel sheet-metal before proceeding with the following work.

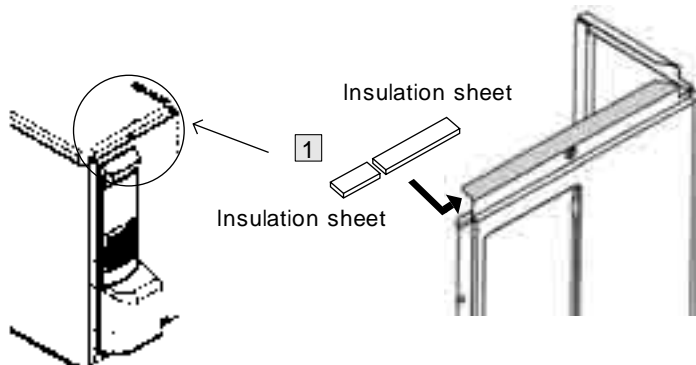

(Top view of Electric box )

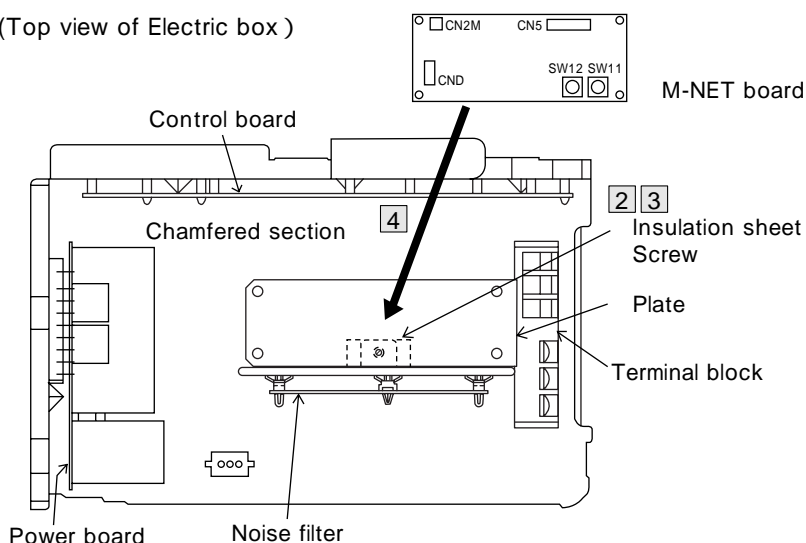

(When viewed from the side of Electric box )

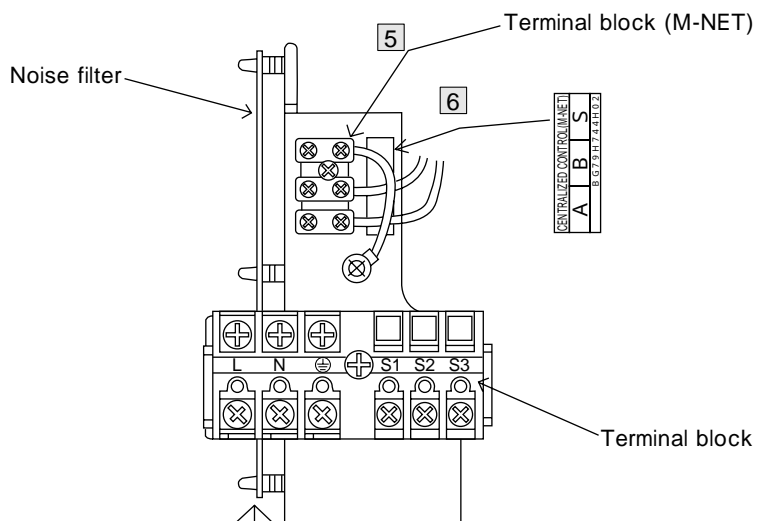

- 1 Affix insulation sheets and to the backside of the flange surface on the top of the side panel.
- 2 Starting from the bottom, mount Insulation Sheet to the " L " bend section on the back of the noise filter mounting panel.
- 3 Position the chamfered section of Plate so that it faces the fan side (the left side of the drawing) and mount it using Screw .
- 4 As shown in the illustration, position M-NET board (insulation sheet, with support) on the four corners of Plate so that the DIP switches (SW11, SW12) are on the terminal block side and then mount.  
Push it firmly until you hear it " click "
- 5 Use terminal screw to secure terminal block  
Terminal block has a round boss for positioning:Fit the round boss into the positioning hole in steel-plate.
- 6 Paste label
- 7 Use lead wire-A to connect CN5 of M-NET board connection and CNMNT of outdoor control board.  
Caution  
Wire Marking:R410A, Connector color:Red  
Always make sure that the markings and the applicable model match. If used incorrectly, parts could be damaged.
- 8 Use lead wire-C to connect CND of M-NET board connection and CNVMNT of outdoor control board.
- 9 Use lead wire-D to connect CN2M of M-NET board connection and terminals A and B of terminal block Polarity is not a concern.  
Connect the wire firmly making sure that the screws on terminal block are not loose.
- 10 The lead wires should be tied together with the other lead wires with the pull tight not to loose.  
Wiring length is adjusted according to apparatus.

It progresses to the page " 3.Wiring method for M-NET "

- Note1:Use ground wire and screw as required to connect the shield of M-NET transmission line to the unit.  
Note2:Take great care that no lead wire is caught on anything when instaling panels.

## 2. Installation procedure 【PUHZ-RP2.5 ~ 6VHA( - A ), RP60 ~ 140VHA( - A )】

To protect the wires connected to M-NET board from the edges of sheet-metal component, paste the insulation on the edge surface of panel sheet-metal before proceeding with the following work.

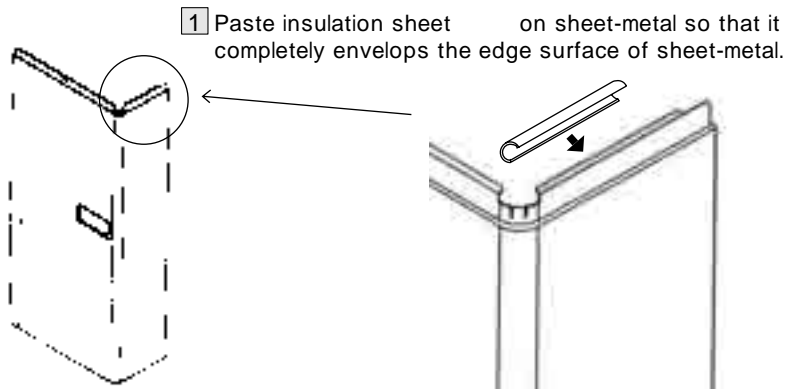

(When viewed from the side of Electric box )

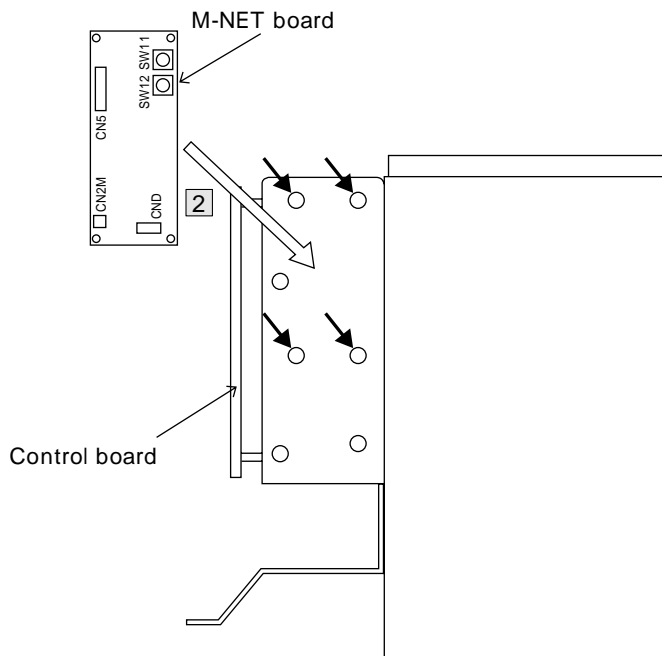

(When viewed from the side of Electric parts box )

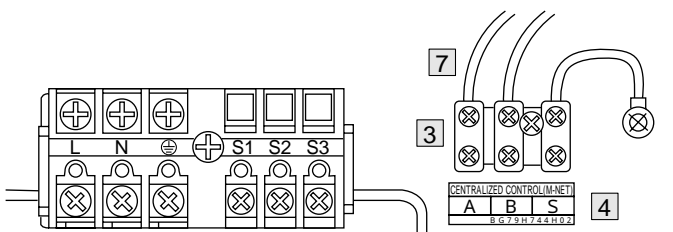

- 1 Paste insulation sheet on sheet-metal so that it completely envelops the edge surface of sheet-metal.

- 2 Install M-NET board (with insulation sheets and supports) on the side of Electric box so that the rotary switch faces up (at the four points indicated by arrows). Push it firmly until you hear it "click".

- 3 Use terminal screw to secure terminal block. Terminal block has a round boss for positioning: Fit the round boss into the positioning hole in steel-plate.

- 4 Paste label under terminal block

- 5 Use lead wire-A to connect CN5 of M-NET board connection and CNMNT of outdoor control board.  
Caution  
Wire Marking: R410A, Connector color: Red  
Always make sure that the markings and the applicable model match. If used incorrectly, parts could be damaged.

- 6 Use lead wire-C to connect CND of M-NET board connection and CNVMNT of outdoor control board.

- 7 Use lead wire-D to connect CN2M of M-NET board connection and terminals A and B of terminal block. Polarity is not a concern.  
Connect the wire firmly making sure that the screws on terminal block are not loose.

- 8 The lead wires should be tied together with the other lead wires with the pull tight not to loose. Wiring length is adjusted according to apparatus.

It progresses to the page  
" 3. Wiring method for M-NET "

Note1: Use ground wire and screw as required to connect the shield of M-NET transmission line to the unit.  
Note2: Take great care that no lead wire is caught on anything when installing panels.

2. Installation procedure 【PUHZ-RP4 ~ 6YHA, PUHZ-RP100 ~ 140YHA】

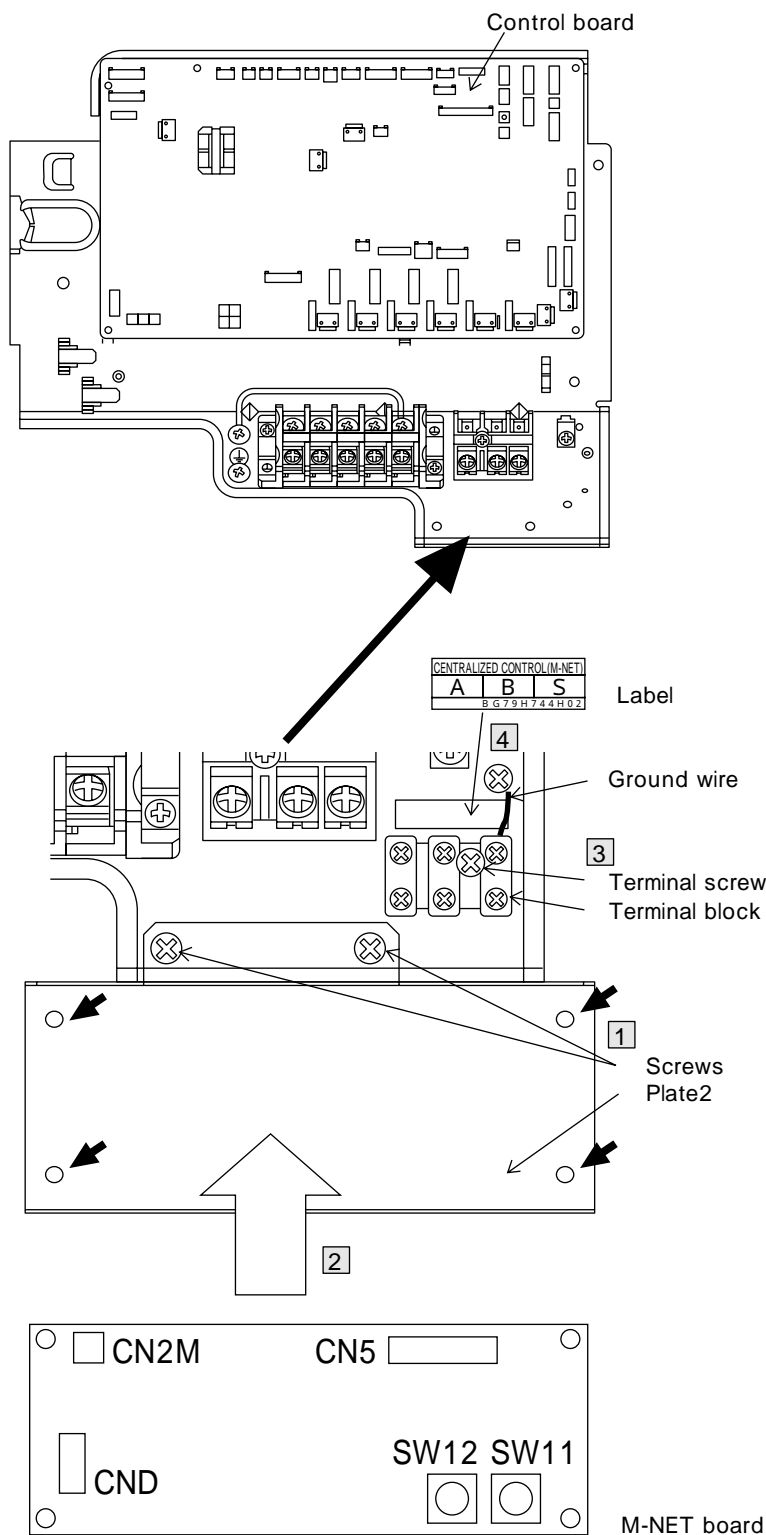

- 1 Attach the Plate 2 , using two screws .
- 2 Install M-NET board (with insulation sheets and supports) on the Plate2 . Push it firmly until you hear it “ click ” .
- 3 Use terminal screw to secure terminal block  
Terminal block has a round boss for positioning:Fit the round boss into the positioning hole in steel-plate.
- 4 Paste label
- 5 Use lead wire-A to connect CN5 of M-NET board connection and CNMNT of outdoor control board.  
Caution  
Wire Marking:R410A, Connector color:Red  
Always make sure that the markings and the applicable model match. If used incorrectly, parts could be damaged.
- 6 Use lead wire-C to connect CND of M-NET board connection and CNVMNT of outdoor control board.
- 7 Use lead wire-D to connect CN2M of M-NET board connection and terminals A and B of terminal block Polarity is not a concern.  
Connect the wire firmly making sure that the screws on terminal block are not loose.
- 8 The lead wires should be tied together with the other lead wires with the pull tight not to loose.  
Wiring length is adjusted according to apparatus.

It progresses to the page  
“ 3.Wiring method for M-NET ”

Note1:Use ground wire and screw as required to connect the shield of M-NET transmission line to the unit.  
Note2:Take great care that no lead wire is caught on anything when installing panels.

## 2. Installation procedure 【PUHZ-RP8/10YHA( - A ), RP200/250YHA】

(When viewed from the side of electrical parts box)

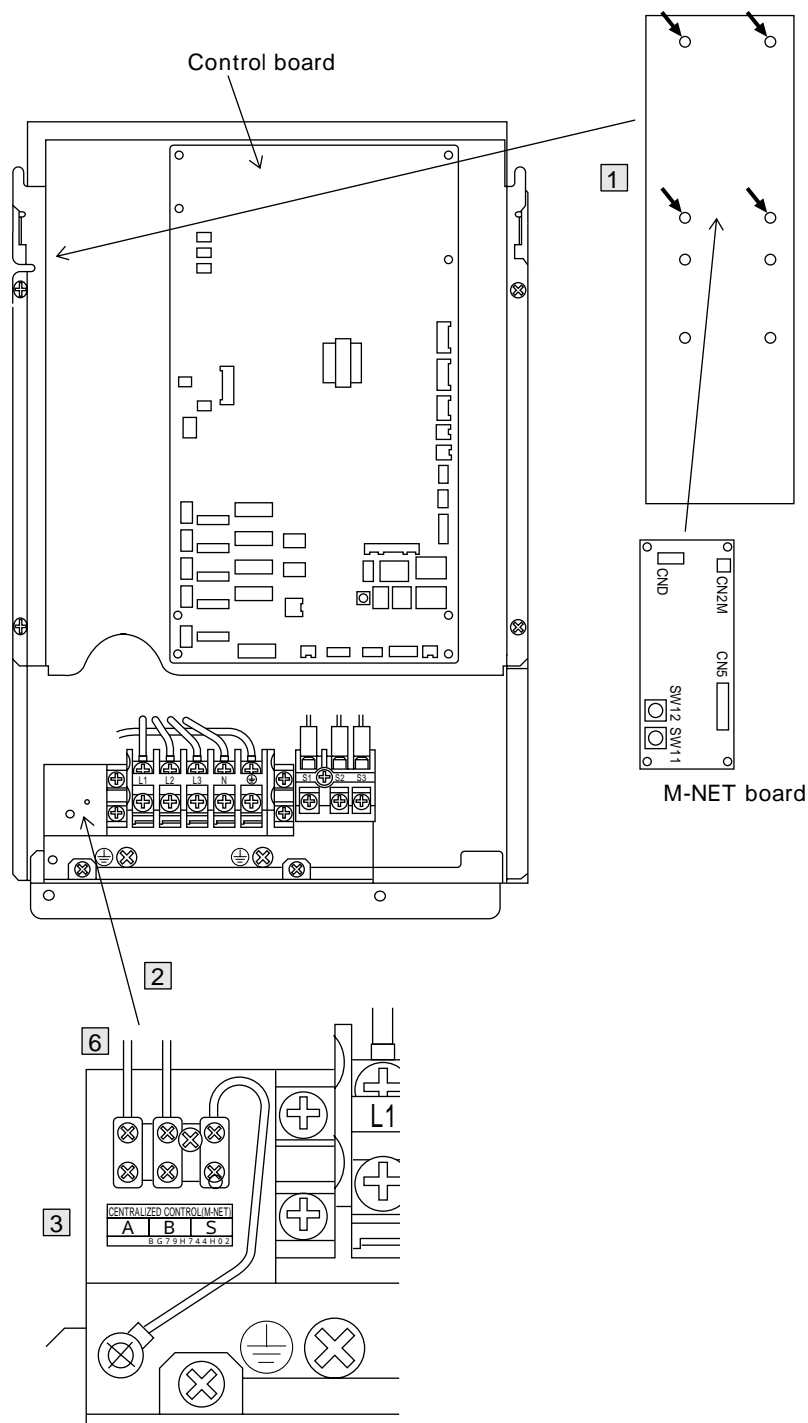

**1** Install M-NET board (with insulation sheets and supports) on the side of electric box .  
At the four point indicated by arrows.  
Push it firmly until you hear it “ click ” .

**2** Use terminal screw to secure terminal block  
Terminal block has a round boss for positioning:Fit the round boss into the positioning hole in steel-plate.

**3** Paste label under terminal block

**4** Use lead wire-A to connect CN5 of M-NET board connection and CNMNT of outdoor control board.  
Caution  
Wire Marking:R410A, Connector color:Red  
Always make sure that the markings and the applicable model match. If used incorrectly, parts could be damaged.

**5** Use lead wire-C to connect CND of M-NET board connection and CNVMNT of outdoor control board.

**6** Use lead wire-D to connect CN2M of M-NET board connection and terminals A and B of terminal block Polarity is not a concern.  
Connect the wire firmly making sure that the screws on terminal block are not loose.

**7** The lead wires should be tied together with the other lead wires with the pull tight not to loose.  
Wiring length is adjusted according to apparatus.

It progresses to the page  
“ 3.Wiring method for M-NET ”

Note1:Use ground wire and screw as required to connect the shield of M-NET transmission line to the unit.

Note2:Take great care that no lead wire is caught on anything when installing panels.



### 3. Wiring method for M-NET

(1) Attention

Outside of the unit, the wires for transmission (called for transmit wires later) should keep away (5 cm or more) from power cable not to receive electric noise. (Never put the transmit wires and power cable in the same cable pipe.) Never supply voltage 220V-240V to the terminals (TB7) for transmission. If the voltage is supplied, it can break the electronic parts on the A-M CONVERTER board.

Use the shielded cable (CVVS, CPEVS) of 1.25mm square thickness with 2 wires for the transmission cable.

Never use transmit wires of different system with a cable which contains multi wires.

The communication of transmit signals will not work properly and it can cause wrong operation.

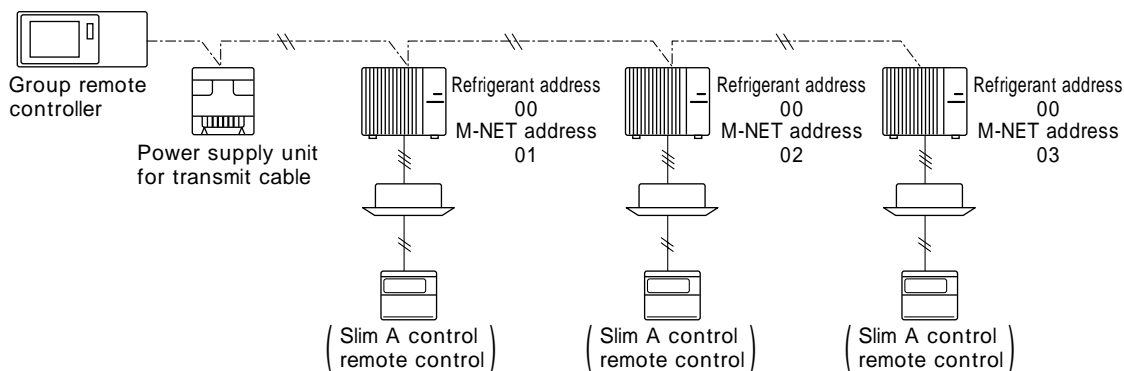

Between the outdoor units, it is OK that only M-NET wiring (2 wires, no polarity) is done.

(2) M-NET address setting

Make M-NET setting and refrigerant address setting on only outdoor unit.

There is no address settings for outdoor unit and remote controller like City Multi system.

The M-NET address setting for taking into centralized control system should be done only to the outdoor unit. The address set number should be 1-50 same as for City Multi indoor unit and make set in order of number for the same group.

	A control slim	City Multi (M-NET)
Indoor unit	—————	1 ~ 50
Outdoor unit	1 ~ 50	51 ~ 100
Remote controller	—————	101 ~ 150
System controller	201 ~ 250	
Group remote controller	201 ~ 250	

The setting should be done by rotary switches SW11 for one figure and SW12 for double figures on A-M CONVERTER of the outdoor unit. (Factory settings are all zero.)

Example

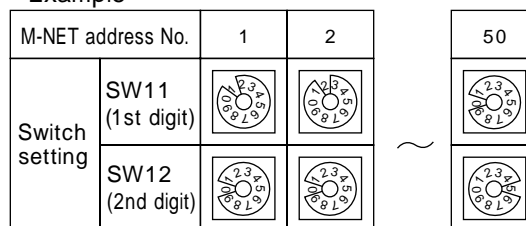

### (3) Refrigerant address setting

In case that the A control Slim is set for group between different refrigerant (when multiple refrigerant system is set in one group), it is necessary to make refrigerant address setting besides the wiring for remote controller (TB5) between the indoor units.

In case that the group setting is not done, be sure to leave the refrigerant address set for 00.

The refrigerant address is set by dip switch SW1 (3-6) on the outdoor controller of the outdoor unit.  
(Factory settings are all OFF .....Refrigerant address 00).

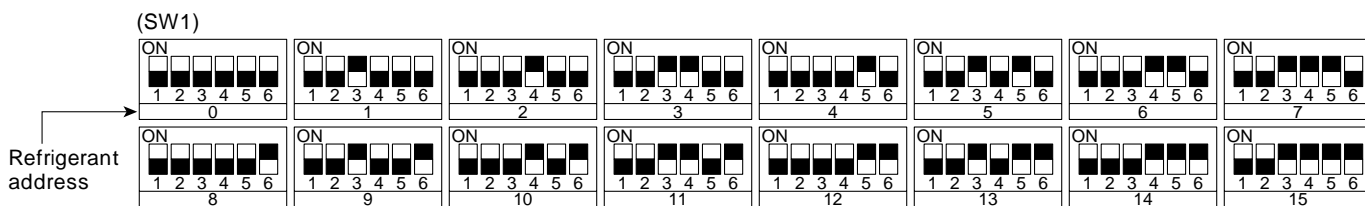

### (4) Limitation for address settings

In case of group operation, the M-NET address settings and the refrigerant address settings should be done with the procedure above.

However, make the minimum M-NET address settings in the group for the outdoor unit which has the refrigerant address 00.

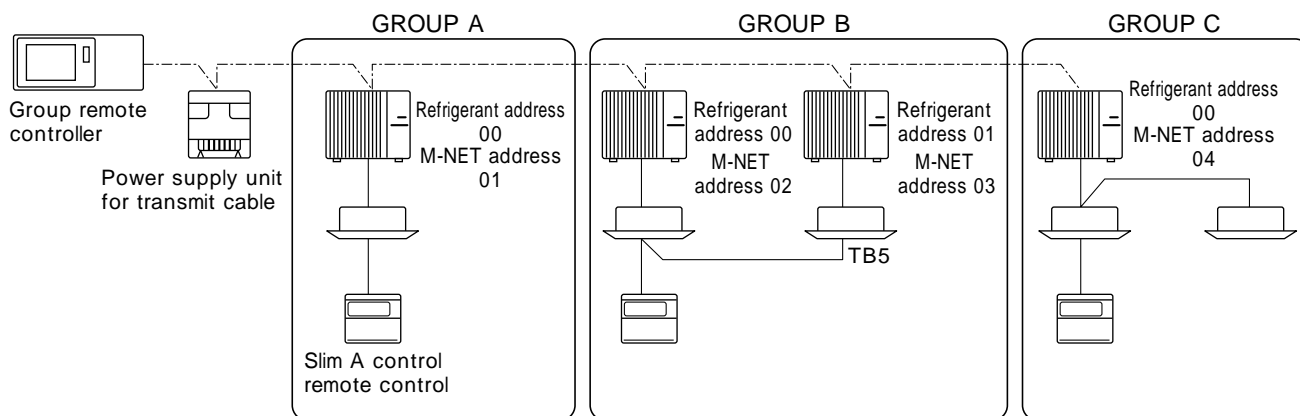

It does not matter if the refrigerant address settings are same with the different group.

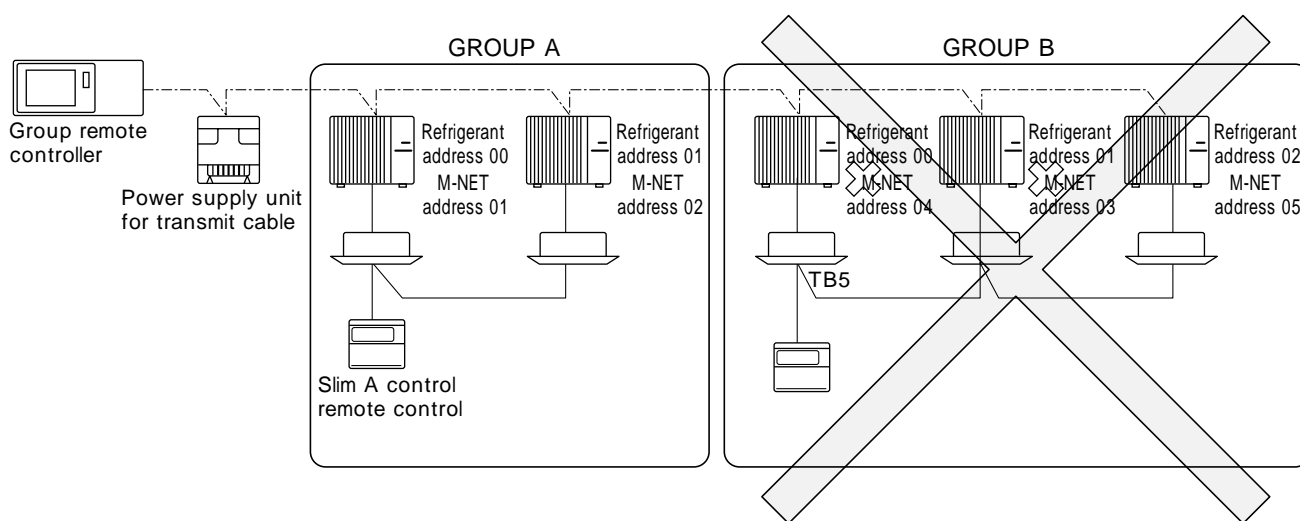

It is not good with the above setting in the group B because the outdoor unit which has the refrigerant address 00 does not have the minimum M-NET address 3 in the group. Make the outdoor unit of the refrigerant address set with the minimum address in the group like the group A.

## Attention for A control Slim M-NET connection

Pay attention to the next points for wiring of shielded wires.

### ⚠ CAUTION

The shielded wires of M-NET transmission should be connected with the ground wire at any only one place of the unit to be connected.

It can cause the transmission error due to noise.

Outdoor unit digital LED display reads "Ed" error.  
Centralized control remote controller reads "0403" error.

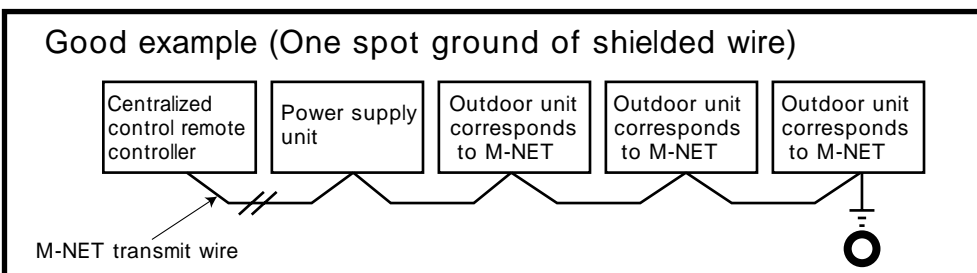
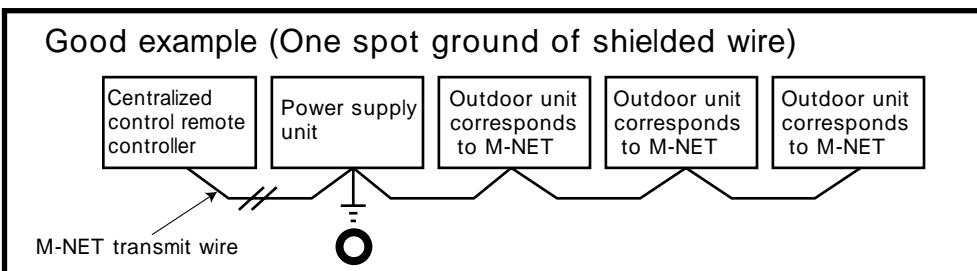
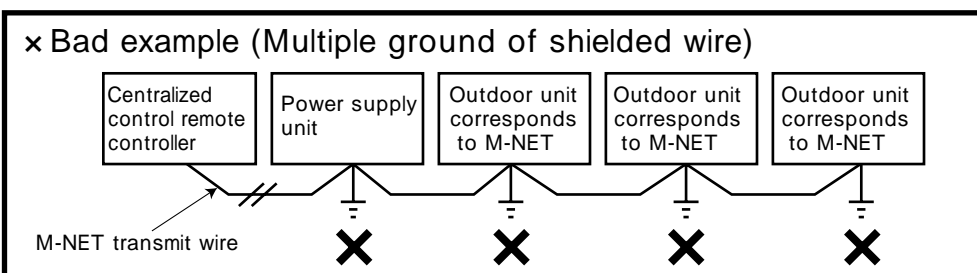

In case that the outdoor unit is grounded, connect the ground wire supplied as accessory to the S terminal (secondary) of M-NET terminal block and M-NET Ground terminal inside of electric box with using screws supplied.

