

Air-Conditioners Indispensable Optional Parts BRANCH BOX

PAC-AK50BC PAC-AK30BC

ONLY FOR R410A OUTDOOR UNIT**ONLY FOR INDOOR USE**

INSTALLATION MANUAL

FOR INSTALLER

For safe and correct use, please read this installation manual thoroughly before installing the air-conditioner unit.

INSTALLATIONSHANDBUCH

FÜR INSTALLATEURE

Zum sicheren und ordnungsgemäßen Gebrauch der Klimaanlage das Installationshandbuch gründlich durchlesen.

MANUEL D'INSTALLATION

POUR L'INSTALLATEUR

Veillez lire le manuel d'installation en entier avant d'installer ce climatiseur pour éviter tout accident et vous assurer d'une utilisation correcte.

INSTALLATIEHANDLEIDING

VOOR DE INSTALLATEUR

Voor een veilig en juist gebruik moet u deze installatiehandleiding grondig doorlezen voordat u de airconditioner installeert.

MANUAL DE INSTALACIÓN

PARA EL INSTALADOR

Para un uso seguro y correcto, lea detalladamente este manual de instalación antes de montar la unidad de aire acondicionado.

MANUALE DI INSTALLAZIONE

PER L'INSTALLATORE

Per un uso sicuro e corretto, leggere attentamente questo manuale di installazione prima di installare il condizionatore d'aria.

ΕΓΧΕΙΡΙΔΙΟ ΟΔΗΓΙΩΝ ΕΓΚΑΤΑΣΤΑΣΗΣ

ΓΙΑ ΑΥΤΟΝ ΠΟΥ ΚΑΝΕΙ ΤΗΝ ΕΓΚΑΤΑΣΤΑΣΗ

Για ασφάλεια και σωστή χρήση, παρακαλείσθε διαβάσετε προσεκτικά αυτό το εγχειρίδιο εγκατάστασης πριν αρχίσετε την εγκατάσταση της μονάδας κλιματισμού.

MANUAL DE INSTALAÇÃO

PARA O INSTALADOR

Para segurança e utilização correctas, leia atentamente este manual de instalação antes de instalar a unidade de ar condicionado.

INSTALLATIONSMANUAL

TIL INSTALLATØREN

Læs venligst denne installationsmanual grundigt, før De installerer airconditionanlægget, af hensyn til sikker og korrekt anvendelse.

INSTALLATIONSMANUAL

FÖR INSTALLATÖREN

Läs denna installationsmanual noga för säkert och korrekt bruk innan luftkonditioneringen installeras.

MONTAJ ELKİTABI

MONTÖR İÇİN

Emniyetli ve doğru biçimde nasıl kullanılacağını öğrenmek için lütfen klima cihazını monte etmeden önce bu elkitabını dikkatle okuyunuz.

РУКОВОДСТВО ПО УСТАНОВКЕ

ДЛЯ УСТАНОВИТЕЛЯ

Для осторожного и правильного использования прибора необходимо тщательно ознакомиться с данным руководством по установке до выполнения установки кондиционера.

安装说明书

安装人员适用

在安装空调机之前，请先通读此安装说明书，以便安全正确地使用。

安裝說明書

安裝人員適用

在安装冷氣機之前，請先詳閱此安裝說明書，以便安全正確地使用。

English

Deutsch

Français

Nederlands

Español

Italiano

Ελληνικά

Português

Dansk

Svenska

Türkçe

Русский

简体中文

繁體中文

Contents

| | | | |
|--|---|--|---|
| 1. Safety precautions | 2 | 6. Mounting the branch box | 5 |
| 2. Selecting a location for installation | 2 | 7. Installing refrigerant piping | 5 |
| 3. Confirming Supplied Accessories | 3 | 8. Installing Drain piping | 6 |
| 4. Dimensions and Required Servicing space of Branch Box | 3 | 9. Electrical work | 7 |
| 5. Refrigerant piping | 4 | 10. Test run | 9 |

This installation manual is only for the branch box installation. In installing the indoor units and outdoor units, refer to the installation manual attached to each unit.

1. Safety precautions

- ▶ Before installing the unit, make sure you read all the "Safety precautions".
- ▶ Please report to your supply authority or obtain their consent before connecting this equipment to the power supply system.

⚠ Warning:

Describes precautions that must be observed to prevent danger of injury or death to the user.

⚠ Caution:

Describes precautions that must be observed to prevent damage to the unit.

⚠ Warning:

- Ask a dealer or an authorized technician to install the unit.
- For installation work, follow the instructions in the Installation Manual and use tools and pipe components specifically made for use with refrigerant specified in the outdoor unit installation manual.
- The unit must be installed according to the instructions in order to minimize the risk of damage from earthquakes, typhoons, or strong winds. An incorrectly installed unit may fall down and cause damage or injuries.
- The unit must be securely installed on a structure that can sustain its weight.
- If the air conditioner is installed in a small room, measures must be taken to prevent the refrigerant concentration in the room from exceeding the safety limit in the event of refrigerant leakage. Should the refrigerant leak and cause the concentration limit to be exceeded, hazards due to lack of oxygen in the room may result.
- Ventilate the room if refrigerant leaks during operation. If refrigerant comes into contact with a flame, poisonous gases will be released.
- All electric work must be performed by a qualified technician according to local regulations and the instructions given in this manual.
- Use only specified cables for wiring.
- The terminal block cover panel of the unit must be firmly attached.
- Use only accessories authorized by Mitsubishi Electric and ask a dealer or an authorized technician to install them.
- The user should never attempt to repair the unit or transfer it to another location.

After installation work has been completed, explain the "Safety Precautions," use, and maintenance of the unit to the customer according to the information in the Operation Manual and perform the test run to ensure normal operation. Both the Installation Manual and Operation Manual must be given to the user for keeping. These manuals must be passed on to subsequent users.

⚡ : Indicates a part which must be grounded.

⚠ Warning:

Carefully read the labels affixed to the main unit.

- After installation has been completed, check for refrigerant leaks. If refrigerant leaks into the room and comes into contact with the flame of a heater or portable cooking range, poisonous gases will be released.
- Be sure to connect the power supply cords and the connecting wires for the indoor units, outdoor units, and branch boxes directly to the units (no intermediate connections). Intermediate connections can lead to communication errors if water enters the cords or wires and causes insufficient insulation to ground or a poor electrical contact at the intermediate connection point. (If an intermediate connection is necessary, be sure to take measures to prevent water from entering the cords and wires.)

⚠ Caution:

- Make sure that the refrigerant pipes are well insulated to prevent condensation. Incomplete insulation may cause condensation on the surface of pipes, wetting of the ceiling, floor and other important properties.
- Make sure that the drainage pipe is carried out correctly following this manual and that it is insulated in order to prevent condensation. Any deficiency caused by piping may result in water leakage, wetting of the ceiling, floor and other personal properties.

2. Selecting a location for installation

* The branch box is only for indoor use.

Please attach the special optional cover (PAC-AK350CVR-E) to install the branch box in the outdoors.

- Ensure that the branch box is installed in a location which facilitates servicing and maintenance. (ensure that the required maintenance hole or service space is available).

• Do not install near bedrooms. The sound of refrigerant flowing through the piping may sometimes be audible.

• Ensure that it is located where noise in operation will not be a problem.

After power is supplied or after an operation stop for a while, a small clicking noise may be heard from the inside of the branch box. The electronic expansion valve is opening and closing. The unit is not faulty.

- Determine the route of refrigerant piping, drain piping, and electrical wiring beforehand.

- Ensure that the location of the installation is such that the length of refrigerant piping is within the specified limits.
- Ensure that the unit is out of reach of children at least 1.8 m above the floor.

• Do not install in location that is hot or humid for long periods of time.

- Ensure that the branch box is installed above the ceiling of corridor, bath room, etc., where persons are not regularly there (Avoid installing at around center of the room.) for maintenance.
- Ensure that the location of the installation is such that the down-gradient of the drain piping is greater than 1/100.

* Ensure that the unit is installed in a location able to support its weight.

⚠ Warning:

Ensure that the unit is installed firmly in a location able to support its weight. If the installation is of insufficient strength the unit may fall, resulting in injury.

3. Confirming Supplied Accessories

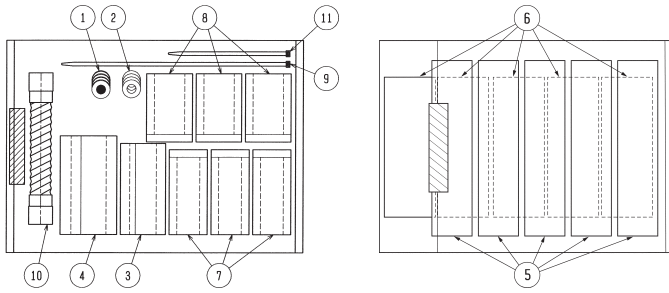

Fig. 3-1

3.1. Check the Branch Box accessories and parts

| | Accessory name | Q'ty | |
|---|--------------------------|------|--|
| ① | Washer (with insulation) | 4 | |
| ② | Washer | 4 | |

For refrigerant piping joint

| | Accessory name | Q'ty | |
|---|----------------------|------|-----------------|
| ③ | Pipe cover (Liquid) | 1 | TO OUTDOOR UNIT |
| ④ | Pipe cover (Gas) | 1 | TO OUTDOOR UNIT |
| ⑤ | Pipe cover (Liquid) | 5 | TO INDOOR UNITS |
| ⑥ | Pipe cover (Gas) | 5 | TO INDOOR UNITS |
| ⑦ | Joint cover (Liquid) | 3 | |
| ⑧ | Joint cover (Gas) | 3 | |
| ⑨ | Band | 24 | |

For drain pipe

| | Accessory name | Q'ty | |
|---|----------------|------|--|
| ⑩ | Drain hose | 1 | |
| ⑪ | Band | 2 | |

4. Dimensions and required servicing space of Branch Box

Optional different (deformed) joints.

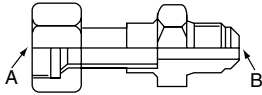

Fig. 4-1

| Model name | Connected pipes diameter | Diameter A | Diameter B |
|--------------|--------------------------|------------|------------|
| | mm | mm | mm |
| MAC-A454JP | ø9.52 → ø12.7 | ø9.52 | ø12.7 |
| MAC-A455JP | ø12.7 → ø9.52 | ø12.7 | ø9.52 |
| MAC-A456JP | ø12.7 → ø15.88 | ø12.7 | ø15.88 |
| PAC-493PI | ø6.35 → ø9.52 | ø6.35 | ø9.52 |
| PAC-SG76RJ-E | ø9.52 → ø15.88 | ø9.52 | ø15.88 |

* Please connect two indoor units or more with one system.

* 1-2 branch boxes may be connected to one outdoor unit.

* Suspension bolt : W3/8(M10)

* Refrigerant pipe flared connection

*** The piping connection size differs according to the type and capacity of indoor units. Match the piping connection size for indoor unit and branch box. If the piping connection size of branch box does not match the piping connection size of indoor unit, use optional different-diameter (deformed) joints to the branch box side. (Connect deformed joint directly to the branch box side.)**

- Ⓐ Suspension bolt pitch
- Ⓑ To indoor unit
- Ⓒ Flexible drain hose (Accessory)
- Ⓓ Drain pipe connection (VP-16)
- Ⓔ To outdoor unit
- Ⓕ Service panel (for LEV, THERMISTOR)
- Ⓖ 3-WIRE BAND
- Ⓗ Electric cover
- Ⓛ 3-electric wire inlet
- Ⓜ Terminal block (to indoor unit)
- Ⓨ Terminal block (to outdoor unit)

* Ensure that the branch box is installed as shown on the below drawing. Leg must be located on top. Otherwise drainage will not be properly performed.

■ PAC-AK50BC (5-branches type)

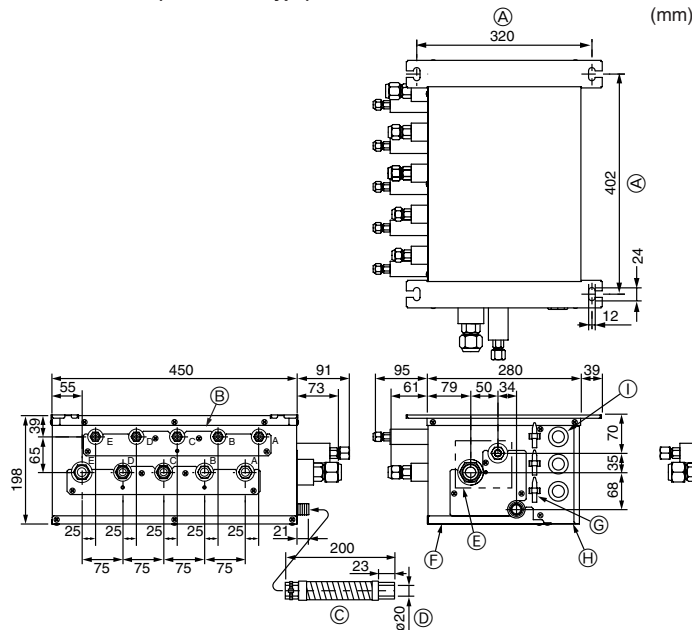

Fig. 4-2

■ PAC-AK50BC (Fig. 4-2)

Suspension bolt: W3/8 (M10)

Refrigerant pipe flared connection

| | A | B | C | D | E | To outdoor unit |
|-------------|-------|-------|-------|-------|-------|-----------------|
| Liquid pipe | ø6.35 | ø6.35 | ø6.35 | ø6.35 | ø6.35 | ø9.52 |
| Gas pipe | ø9.52 | ø9.52 | ø9.52 | ø9.52 | ø12.7 | ø15.88 |

Drain hose size: O.D.20 (VP16)

Conversion formula

| | |
|-------|--------|
| 1/4 F | ø6.35 |
| 3/8 F | ø9.52 |
| 1/2 F | ø12.7 |
| 5/8 F | ø15.88 |
| 3/4 F | ø19.05 |

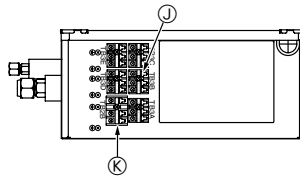

4. Dimensions and Required Servicing Space of Branch Box

■ PAC-AK30BC (3-branches type)

■ PAC-AK30BC (Fig. 4-3)

Suspension bolt: W3/8 (M10)

Refrigerant pipe flared connection

| | A | B | C | | | To outdoor unit |
|-------------|-------|-------|-------|--|--|-----------------|
| Liquid pipe | ø6.35 | ø6.35 | ø6.35 | | | ø9.52 |
| Gas pipe | ø9.52 | ø9.52 | ø9.52 | | | ø15.88 |

Drain hose size: O.D.20 (VP16)

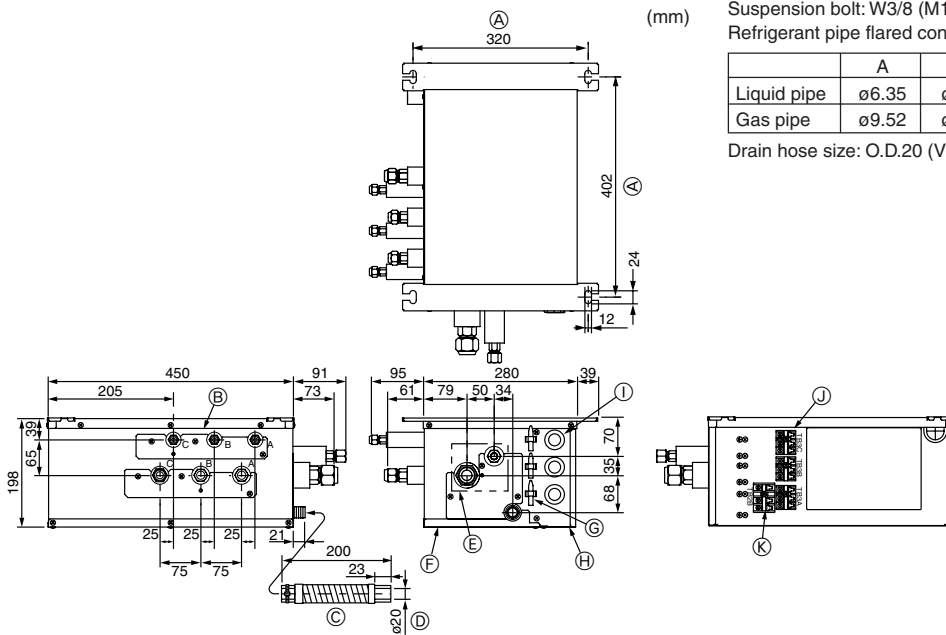

Fig. 4-3

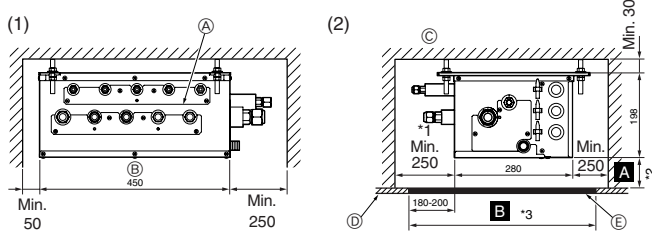

Fig. 4-4

Fig. 4-5

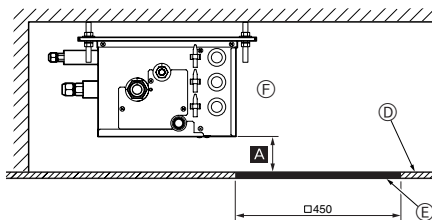

Fig. 4-6

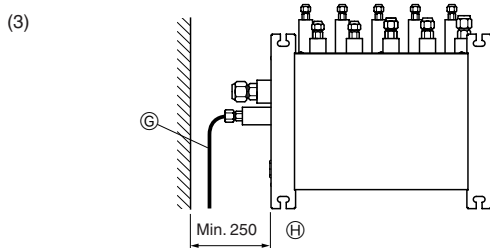

Fig. 4-7

4.1. Space required for Installation and servicing

(1) Front View (Fig. 4-4)

Ⓐ Branch box

Ⓑ On the side of piping

(2) Side View (Fig. 4-5, Fig. 4-6)

Ⓒ For indoor installations

Ⓓ Ceiling board

Ⓔ Maintenance hole

Ⓕ PCB side

*1: A minimum 350 mm is required for 90° bends in refrigerant piping.

*2: Ⓐ is "Min. 200 mm" <recommendation>.

(Premise: The slope of drain piping is securable 1/100 or more. Required 200 mm or more, when not securable.)

In the case of less than 200 mm (for example Ⓐ is 100 mm), the exchange work of Branch box from a maintenance hole becomes difficult (Only exchange work of a PCB, linear expansion valve coils, sensors and drain pan is possible).

*3: Ⓑ is "□ 600" <recommendation>.

In the case of "□ 450", prepare a maintenance hole at a PCB side (as it is shown in Fig. 4-6), and "Min. 300 mm" is needed as distance Ⓐ.

In the case of less than 300 mm (for example Ⓐ is 100 mm), the exchange work of Branch box, linear expansion valve coils, sensors, and drain pan from a maintenance hole becomes difficult (Only exchange work of a PCB is possible).

(3) Top View (Fig. 4-7)

Ⓒ Refrigerant piping

Ⓓ When facing in the opposite direction to the refrigerant piping.

5. Refrigerant piping

* Always follow the specifications written in the installation manual of the outdoor unit. Exceeding these requirements may cause reduced performance of the equipment, and malfunctions.

6. Mounting the Branch Box

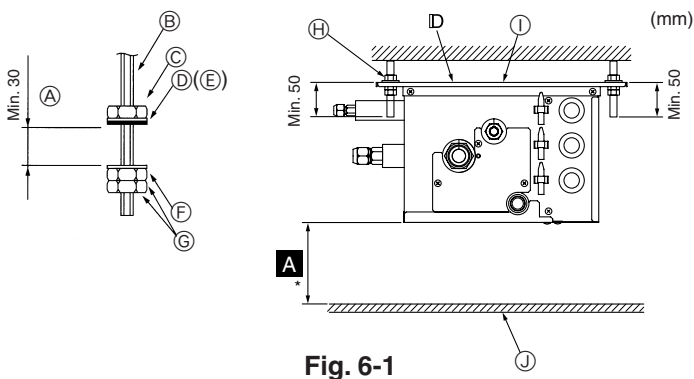

Fig. 6-1

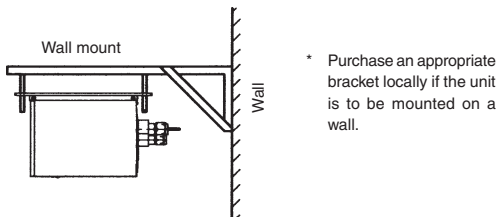

Fig. 6-2

- (1) Install the suspension bolts (procure locally) at the specified pitch (Fig. 4-2, 4-3).
- (2) Fit the washers and nuts (①, ②, procure locally) to the suspension bolts. (Fig. 6-1)
- (3) Hang the unit on the suspension bolts.
- (4) Fully tighten the nuts (check ceiling height).
- (5) Use a level to adjust the branch box to the horizontal.
 - Ⓐ When unit is hung and nuts tightened
 - Ⓑ Suspension bolt
 - Ⓒ Nuts
 - Ⓓ Washer (with cushion) ①
 - Ⓔ Ensure that cushion faces downwards
 - Ⓕ Washer (without cushion) ②
 - Ⓖ Nut (procure locally)
 - Ⓗ Suspension bolt
 - Ⓜ Ensure that this face is always installed upwards.
 - Ⓨ Ceiling board.

Note:

* Refer to "4-1".

⚠ Caution:

- Always install the unit horizontally.
- This unit may be installed suspended from the ceiling.
- **This unit may only be installed vertically, as shown in the diagram below. (Side D is facing up.)**
- Incorrect installation may result in the drain overflowing.

7. Installing refrigerant piping

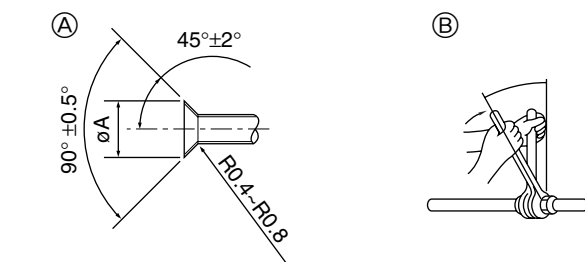

Fig. 7-1

- Ⓐ Flare cutting dimensions
- Ⓑ Flare nut tightening torque

- Ⓐ Flare cutting dimensions

Table 1

| Copper pipe O.D. (mm) | Flare dimensions øA dimensions (mm) |
|-----------------------|--|
| ø6.35 | 8.7 - 9.1 |
| ø9.52 | 12.8 - 13.2 |
| ø12.7 | 16.2 - 16.6 |
| ø15.88 | 19.3 - 19.7 |

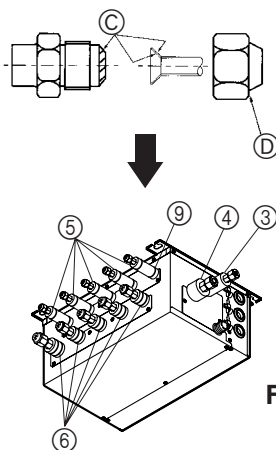

Fig. 7-2

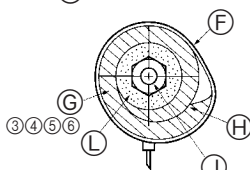

Fig. 7-3

- ▶ Connect the liquid and gas pipes of each indoor unit to the same end connection numbers as indicated on the indoor unit flare connection section of each Branch Box. If connected to wrong end connection numbers, it doesn't work normally. (Fig. 7-1)

- ▶ When connecting indoor units, make sure to connect refrigerant pipes and connection wires to the appropriate connection ports marked with matching alphabets. (Ex. A, B, C, D, E)

Note:

- ▶ Be sure to mark all the local refrigerant piping (liquid pipes, gas pipes, etc.) for each indoor unit designating clearly which room it belongs in. (Ex. A, B, C, D, E)
- ▶ List indoor unit model names in the name plate on the control box of Branch Box (for identification purposes).

- ▶ To prevent water dripping from the refrigerant piping, install sufficient thermal insulation.
- ▶ When using commercially available refrigerant piping, ensure that both liquid and gas piping are wrapped with commercially available thermal insulation materials (insulation materials at least 12 mm thick and able to withstand temperatures in excess of 100 °C).
- ▶ Refer to the installation manual of the outdoor unit when creating a vacuum and opening or closing valves.

- (1) Remove the flared nuts and caps from the branch box.
- (2) Flare the ends of the liquid and gas piping, and apply refrigeration oil (procure locally) to the flared seat.
- (3) Connect the refrigerant piping immediately. Always tighten the flared nuts to the torque specified in the table below using a torque wrench and double spanner.
- (4) Press the pipe covers ③ and ⑤ on the liquid piping against the unit and wrap to hold in place.
- (5) Press the pipe covers ④ and ⑥ on the gas piping against the unit and wrap to hold in place.
- (6) Apply the supplied bands ⑨ at a position 10 - 20 mm from each end of the pipe covers (③ ④ ⑤ ⑥).
- (7) If the indoor unit is not connected, fit the supplied pipe covers (with caps, ⑦ and ⑧) to the branch box refrigerant piping connections to prevent condensation dripping from the pipes.
- (8) Clamp the pipe covers (⑦ ⑧) in place with the supplied bands ⑨.

- Ⓑ Flare nut tightening torque

Table 2

| Copper pipe O.D. (mm) | Flare nut O.D. (mm) | Tightening torque (N·m)* |
|-----------------------|---------------------|--------------------------|
| ø6.35 | 17 | 14 - 18 |
| ø6.35 | 22 | 34 - 42 |
| ø9.52 | 22 | 34 - 42 |
| ø9.52 | 26 | 49 - 61 |
| ø12.7 | 26 | 49 - 61 |
| ø12.7 | 29 | 68 - 82 |
| ø15.88 | 29 | 68 - 82 |
| ø15.88 | 36 | 100 - 120 |

* 1N·m ≙ 10 kgf·cm

7. Installing refrigerant piping

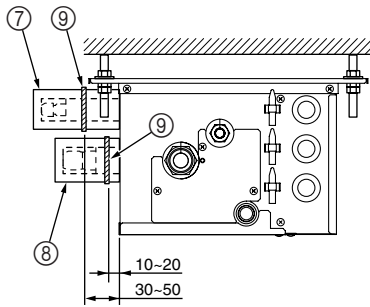

Fig. 7-4

⚠ Caution:

Tighten the flare nut with a torque wrench in the specified method. Overtightening will cause the flare nut to crack and it will cause refrigerant leakage over a period of time.

- Ⓒ Apply refrigeration oil to the entire (Fig. 7-2) surface of the flared seat.
- Ⓓ Basically use flared nuts fitted to the body (commercially available flared nuts may crack).

Note:

A special flare nut (optional or attached to the indoor unit) is needed to some indoor units. Please refer to the installation manual of outdoor unit and indoor unit for details.

- Ⓔ Section of connection (Fig. 7-3)
- Ⓕ Band ⑨
- Ⓖ Pipe covers ③ ④ ⑤ ⑥
- Ⓗ Tighten
- ① Thermal insulation for refrigerant piping
- ② Refrigerant piping

► **Use the following procedures for indoor connection part which indoor unit is not connected. (Fig. 7-4)**

- (1) In order to prevent refrigerant leaks, make sure that the flare nuts are tightened according to the specified torques* in Table 3.
* Refrigerant may also leak if the flare nuts are tightened more than the specified torques.
- (2) In order to prevent condensation, install the pipe covers ⑦ ⑧ and fasten them with the supplied bands ⑨.

Table 3

| Diameters of branch box openings for connecting indoor units (mm) | Tightening torque (N·m) |
|---|-------------------------|
| ø6.35 | 13±2 |
| ø9.52 | 30±2 |
| ø12.7 | 50±2 |

► Refrigerant charge:

Refer to the installation manual of the outdoor unit.

Use only R410A refrigerant (use of other refrigerants may cause troubles).

8. Installing Drain piping

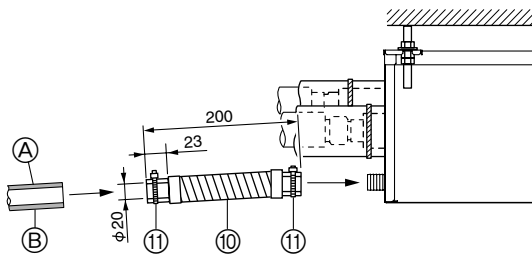

Fig. 8-1

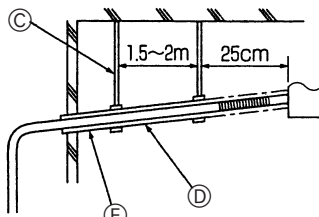

Fig. 8-2

• **To ensure that the drain piping has a down-gradient (greater than 1/100), do not make traps or humps in piping.**

- Install thermal insulation to prevent condensation dripping.
 - Ensure that the horizontal length (not diagonal length) of drain piping does not exceed 20 m. If the drain piping extends over a significant distance, install supports to ensure that the piping does not sag. Do not fit air bleed pipes under any circumstances (water may exit from air bleed pipes).
 - Do not fit odor traps at drain piping outlets.
 - Install drain outlets in locations where odors will not present problems.
 - Do not place drain piping directly in drains which may contain sulfurous gases.
 - Drain piping may be installed in any direction provided the above requirements are followed.
 - Keep bends of attached drain hose to a maximum of 45°.
- (1) Apply PVC adhesive (procure locally) to the drain connection on the branch box and push the attached drain hose ⑩ onto the connection as far as it will go. (Fig. 8-1)
 - (2) Insert a hard PVC pipe (VP-16, procure locally) into the attached drain hose ⑩ and glue it together and fix it. (Fig. 8-1)
 - Ⓐ VP-16 procured locally
 - Ⓔ Thermal insulation
 - (3) Fit a band ⑪ to the attached drain hose ⑩. (Fig. 8-1)
 - (4) Ensure that the drain piping down-gradient is greater than 1/100. (Fig. 8-2)
 - Ⓒ Supports
 - Ⓓ Down-gradient greater than 1/100.
 - Ⓔ Thermal insulation

9. Electrical work

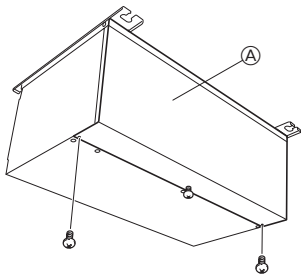

Fig. 9-1

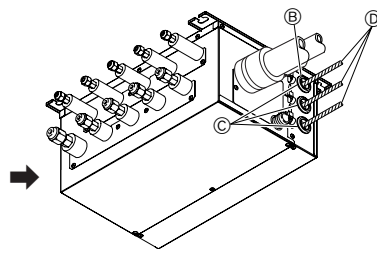

Fig. 9-2

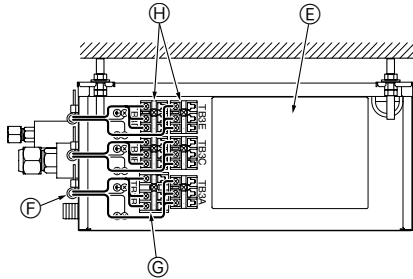

Fig. 9-3

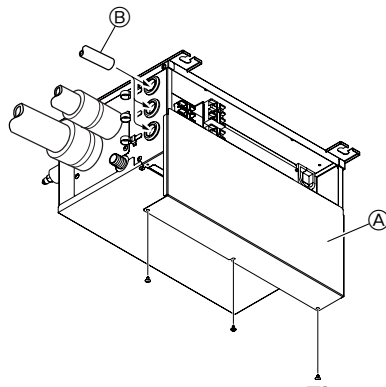
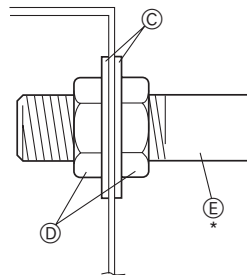

Fig. 9-4



► Cautions for electrical work.

⚠ Warning:

- Always use dedicated circuits with breakers, and at the rated voltage. Power supply circuits with insufficient capacity, and bad workmanship during installation, may result in electric shock or fire.
- Always ensure that electrical wiring inlets are sealed when the branch box is installed outdoors. Rainwater on the terminal blocks may result in fire or malfunction.

⚠ Caution:

- Be sure to establish an earth. Do not earth the unit to a utility pipe, arrester, or telephone earth. Incomplete earth may cause electrical shock. A high surge current from lightning or other sources may cause damage to the air conditioner.
- Use the specified electrical wiring and ensure that it is connected properly, and that it is not under tension. Failure to follow these requirements may result in broken wiring, heating, or fire.
- Wiring connecting branch box and outdoor unit, and branch box and indoor units, functions as both power supply and signal cable. Connect this wiring in accordance with the terminal block numbers to ensure correct polarity.
- Ensure that the appropriate refrigerant piping and electrical wiring are connected to each indoor unit. Incorrect wiring will interfere with the correct operation of the unit.

► Connect refrigerant pipes and connection wires to the appropriate ports marked with matching alphabets (Ex. A, B, C, D, E) on this unit.

► Always fix each ground wire separately with a ground screw.

► To prevent that wiring installed in the ceiling is chewed by rats etc., it should be installed in wiring conduit.

1. Remove the screws in the cover. (Fig. 9-1)
2. Remove the cover.
3. Pass the wiring into the branch box. (Fig. 9-2)
4. Fix each wire in place with a wiring clamp. (Fig. 9-3)
5. Firmly connect each wire to the appropriate terminal block. (Fig. 9-3)
6. Replace the cover.
7. When the branch box is installed outdoors, ensure that the wiring inlets are sealed with putty to prevent entry of rainwater. (Fig. 9-2)

Ⓐ Electric cover

Ⓑ 3-Bush

Ⓒ Seal

Ⓓ Wiring

Ⓔ BC controller

Ⓕ Band

Ⓖ Terminal block: TB2B <To outdoor unit> $\phi 1.6 - \phi 2.0$

Ⓗ Terminal block: TB3A-TB3E <To indoor unit> $\phi 1.6$

9.1. When using wiring conduit (Fig. 9-4)

Replace the horizontal cover when the wiring conduit has been fixed in place.

- Ⓐ Cover
- Ⓑ Wiring conduit
- Ⓒ Washer
- Ⓓ Nut
- Ⓔ Wiring conduit

Wiring conduit of up to 1" OD may be used.

- (1) When using 1" OD wiring conduit, remove the bush and fix to the branch box. Remove the horizontal cover while fixing to the branch box.
- (2) When using wiring conduit of 3/4" OD or smaller, notch the bush and insert the wiring conduit approximately 100 mm into the branch box.

* Replace the horizontal cover when the wiring conduit has been fixed in place.

9. Electrical work

<example>

(in case of 2-branch boxes)

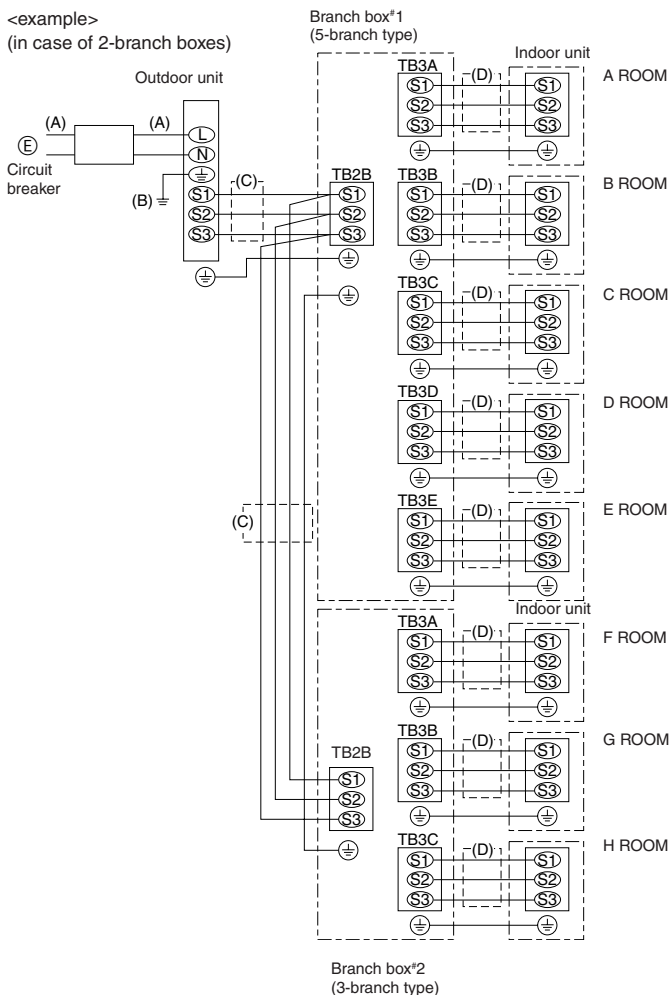
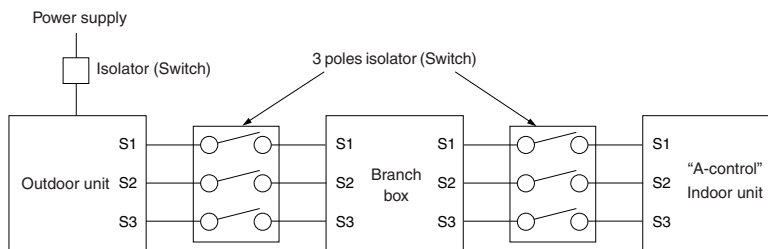

Fig. 9-5

⚠ Warning:

In case of A-control wiring, there is high voltage potential on the S3 terminal caused by electrical circuit design that has no electrical insulation between power line and communication signal line. Therefore, please turn off the main power supply when servicing. And do not touch the S1, S2, S3 terminals when the power is energized. If isolator should be used between outdoor unit and branch box/indoor unit and branch box, please use 3-poles type.



⚠ Caution:

After using the isolator, be sure to turn off and on the main power supply to reset the system. Otherwise, the outdoor unit may not be able to detect the branch box(es) or indoor units.

9.2. External wiring procedure (Fig. 9-5)

Ⓒ Power supply: Single phase 220/230/240 V, 50 Hz 220 V, 60 Hz

Note:

- Power supply input: Outdoor unit only. Connect the lines (C), (D) in accordance with the terminal block names to ensure correct polarity.
- As for lines (C), S1 and S2 are for connecting the power source. And S2 and S3 are for signals. S2 is a common cable for the power source and signal.

| Wire diameter | | | | Breaker | |
|---------------------|---------------------|------------------------|---------------------|----------------------|----------------------------|
| (A) Main power line | (B) Earth line | (C) Signal line | (D) Signal line | Interrupting current | Performance characteristic |
| 6.0 mm ² | 6.0 mm ² | 1.5 mm ² *2 | 1.5 mm ² | *1 | *1 |

When using twisted wire for the wiring, the use of round terminal is required.





*1 Refer to the installation manual of the outdoor unit.

*2 Max 45 m ("Outdoor unit - Branch box #1" plus "Branch box #1 - Branch box #2").
If 2.5 mm² used, Max 55 m.

- Notes:
- Wiring size must comply with the applicable local and national code.
 - Power supply cords and Indoor unit/Branch box/Outdoor unit connecting cords shall not be lighter than polychloroprene sheathed flexible cord. (Design 245 IEC 57)
 - Install an earth line longer than power cables.

9. Electrical work

WIRING SPECIFICATIONS (OUTDOOR-BRANCH BOX CONNECTING CABLE)

| Cross section of cable | Wire size (mm ²) | Number of wires | Polarity | L (m)*6 |
|---|------------------------------|-----------------|---|----------------------|
| Round  | 2.5 | 3 | Clockwise : S1-S2-S3 * Pay attention to stripe of yellow and green | (50) *2 |
| Flat  | 2.5 | 3 | Not applicable (Because center wire has no cover finish) | Not applicable *5 |
| Flat  | 1.5 | 4 | From left to right : S1-Open-S2-S3 | (45) *3 |
| Round  | 2.5 | 4 | Clockwise : S1-S2-S3-Open *Connect S1 and S3 to the opposite angle | (55) *4 |

*1 : Power supply cords of appliances shall not be lighter than design 245 IEC or 227 IEC.

*2 : In case that cable with stripe of yellow and green is available.

*3 : In case of regular polarity connection (S1-S2-S3), wire size is 1.5 mm².

*4 : In case of regular polarity connection (S1-S2-S3).

*5 : In the flat cables are connected as this picture, they can be used up to 55 m.

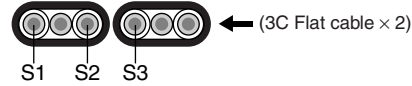

*6 : Mentioned cable length is just a reference value.

It may be different depending on the condition of installation, Humidity or materials, etc.

Be sure to connect the outdoor-branch box/indoor-branch box connecting cables directly to the units (no intermediate connections).

Intermediate connections can lead to communication errors if water enters the cables and causes insufficient insulation to ground or a poor electrical contact at the intermediate connection point.

(If an intermediate connection is necessary, be sure to take measures to prevent water from entering the cables.)

10. Test run

- Refer to the "Test run" section of the installation manual of the indoor units and outdoor unit.
- When installation of the indoor unit, branch box, and outdoor unit is complete, begin test run to check for water leaks in the branch box.

• After power is supplied or after an operation stop for a while, a small clicking noise may be heard from the inside of the branch box. The electronic expansion valve is opening and closing. The unit is not faulty.

- Be sure to perform the test run for each indoor unit. Make sure each indoor unit operates properly following the installation manual attached to the unit.
- If you perform the test run for all indoor units at once, you cannot detect any erroneous connection, if any, of the refrigerant pipes and the indoor/outdoor unit connecting wires.

This product is designed and intended for use in the residential,
commercial and light-industrial environment.

The product at hand is based on the following EU regulations:

- Low Voltage Directive 73/23/ EEC
- Electromagnetic Compatibility Directive 89/336/ EEC

Please be sure to put the contact address/telephone number on
this manual before handing it to the customer.