

SYSTEM CONTROL INTERFACE

Model **MAC-333IF-E**

TECHNICAL MANUAL

Table of Contents

MAC-333IF-E (SYSTEM CONTROL INTERFACE)

- 1 PRODUCT SPECIFICATIONS2
- 2 INSTALLATION OF INTERFACE UNIT4
- 3 CONNECTION4
- 4 SETTING OF DIP SWITCH AND ROTARY SWITCH7
- 5 FUNCTIONS8
 - 5.1 M-NET CONNECTION8
 - 5.2 MA REMOTE CONTROLLER CONNECTION9
 - 5.3 REMOTE CONTROL11
 - 5.4 STATUS SIGNAL OUTPUT20
 - 5.5 ON/OFF CONTROL BY MAIN POWER SOURCE25
- 6 IMPORTANT NOTE26

1 PRODUCT SPECIFICATIONS

(1) Function table

This product enables the following function.

Function name	Description
MA remote controller connection	Connecting M-series to the wired remote controller (MA remote controller).
M-NET connection	Centralized control of M-series and other series * with P-series/City Multi-series. (Including ME remote controller connection)
Remote control	Linking and operating with an open/close switch, such as a card key.
Status signal output	Outputting the ON/OFF operation status and abnormal/normal signals.
ON/OFF control by main power source	Turning M-series on when the main power is turned on.

*• S-series

• Indoor unit(s) connected to SUZ or MXZ series

Function combination table

The following table shows the restrictions on the combination use of the functions.

- "ON/OFF control by main power source" can be used regardless of the following combinations, however, "ON/OFF control by main power source" cannot be used with "AUTO restart function" of the indoor unit at the same time.

Pattern	MA remote controller connection	M-NET connection	Remote control	Status signal output
1	○			
2		○		
3			○	
4				○
5	○※1	○		
6	○		○	
7	○			○
8		○	○	
9		○		○
10			○	○
11	○※1	○	○	
12	○※1	○		○
13	○		○	○
14		○	○	○
15	○※1	○	○	○

※1: When the MA remote controller is used with the M-NET system, only one MA remote controller is allowed be used.

FUNCTIONS AND ELECTRIC WIRING

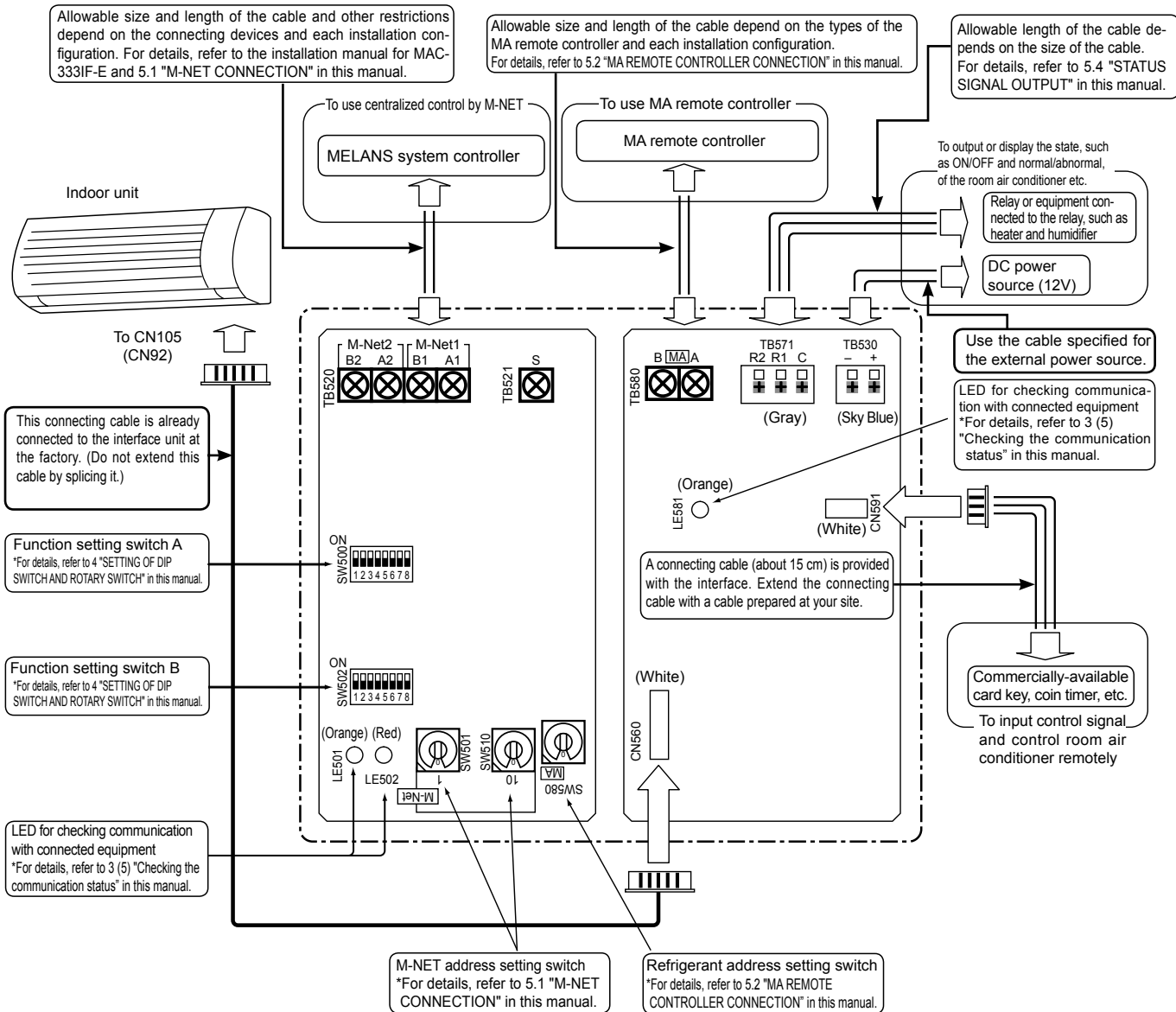

(2) Specifications

Item	Model	MAC-333IF-E
Power supply		12 VDC, Indoor power-receiving system
Dimensions		54(H) × 160(W) × 70(D)mm
Usage conditions		0 to 40 °C (32 to 104 °F), no condensation, indoor use only
Indoor unit connecting cable		Dedicated 5-core cable, 2 m
Weight		360 g

(3) External dimensions

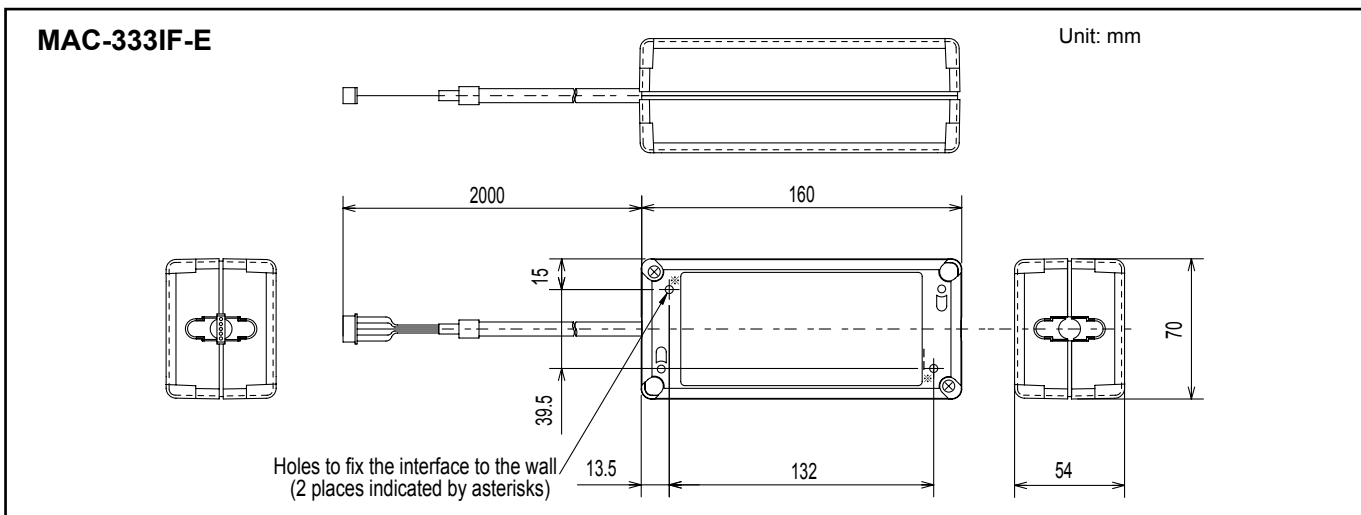

2 INSTALLATION OF INTERFACE UNIT

- The Interface unit should be placed in a location where the connecting cable (5-core) from the interface unit can reach the indoor unit.
- The device will not function properly if the connecting cable (5-core) is extended, so do not extend the connecting cable (5-core).
- Mount the interface unit securely to a pillar or a wall using 2 mounting screws.

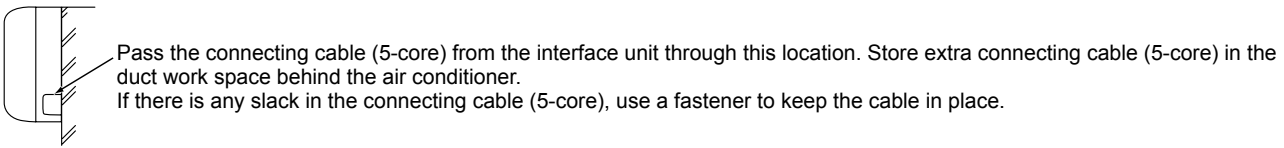

■ Mounting the interface unit directly to a wall

Mount the interface unit case to the wall using the mounting screws.

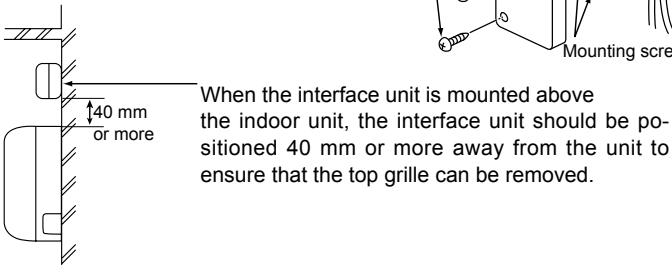
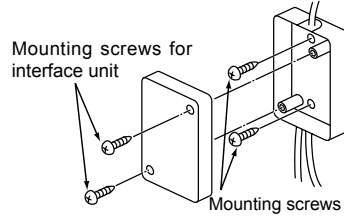

■ Mounting the interface unit inside a ceiling

When mounting the interface unit inside the ceiling or the wall, install an access door to facilitate maintenance.

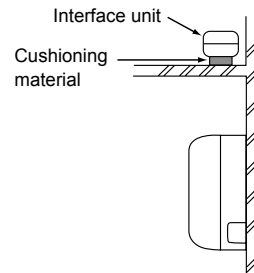

* When mounting the interface unit using a cushioning material, be sure to mount the interface unit in a location where it will not fall.

3 CONNECTION

(1) Connecting to the air conditioner

- Before performing the following procedures, turn off the main power to the air conditioner.
- Connect the connecting cable (5-core) that comes with the interface unit to the connector CN105 (CN92) on the indoor control board in a room air conditioner.
- Extending or severing the connecting cable (5-core) from the interface unit causes malfunction. Also, keep the connecting cable (5-core) as far as possible away from the power supply cord and earth wire. Do not bundle those cables and wires together.
- To prevent the indoor control board from being damaged by static electricity, always remove your static electricity before starting work.

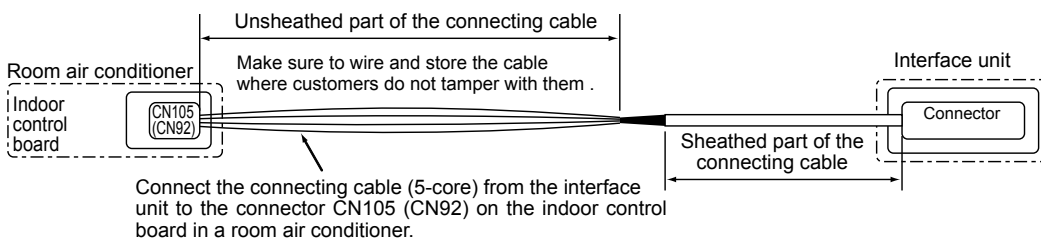

- The connecting cable (5-core) connected to a room air conditioner should be wired according to the room air conditioner installation manual.
- Securely fix the connecting cable at the designated place. Failure to do so may cause an electric shock, fire, or malfunction.
- The connecting cable (5-core) connected to a room air conditioner should be fixed to the room air conditioner or its vicinity.
- If the mounting screw that comes with the room air conditioner does not fit, replace the mounting screw with the one that comes with the interface.

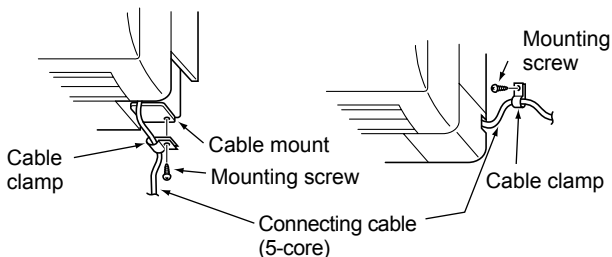

(2) Connecting to the systems

- Before performing the following procedures, turn off the main power to the air conditioner and all systems.
- If the connecting cable is not securely fixed, the connector may come off, and the interface could break or malfunction.
- The unit will not operate normally if the dip switches (SW500, SW502) and the rotary switches (SW501, SW510, SW580) on the interface unit are not set correctly.
- Replace the cable clamp according to the size of the connecting cable used for each system. Fasten the cable tie as shown in the figure to prevent undesirable movement of the connecting cable.

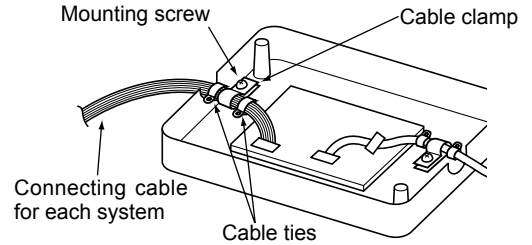

(3) Connecting the M-NET communication cable

- To connect the interface to the system controller and/or ME remote controller, connect the M-NET communication cable to TB520 (non-polarized). Connect the 2-core communication cable to A1&B1 or A2&B2. (It does not matter which pair of connectors is used.)
- Connect the shield wire of the connecting cable to the S terminal only when the daisy chain method is used to wire the communication cable.
- M-NET communication cable should be located as far away from other power supply cords as possible. Placing them closely could cause a malfunction.
- After wiring is complete, fix each cable with the cable clamps, and attach the cable ties as shown in the figure.

The interfaces are daisy chained using the communication cable.

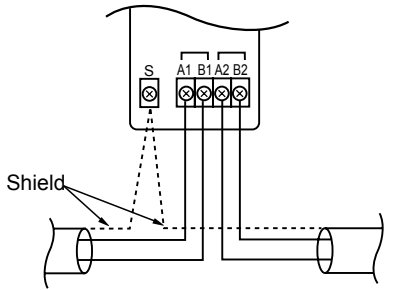

The interfaces are daisy chained using the communication cable, and ME remote controller is used

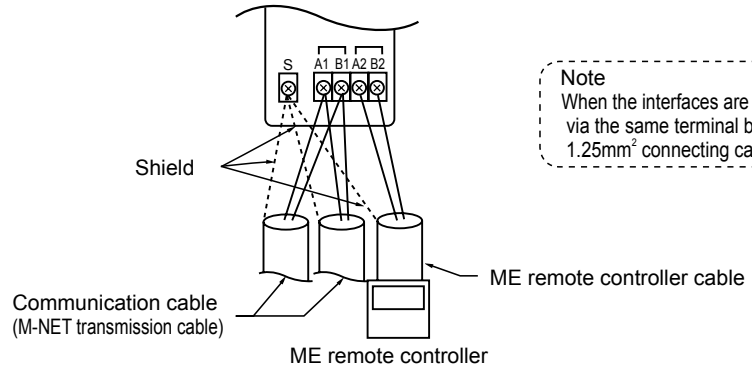

Note
When the interfaces are daisy chained via the same terminal block, use 1.25mm² connecting cables.

Daisy chain method is NOT used to wire the communication cable

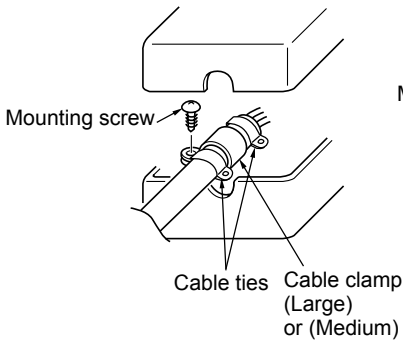

Daisy chain method is used to wire the communication cable

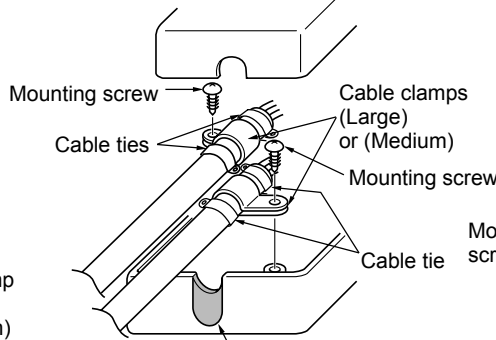

Cut here with nippers along the notches. Make sure the cut surface is free of any burr which could damage the connecting cable and the ME remote control cable.

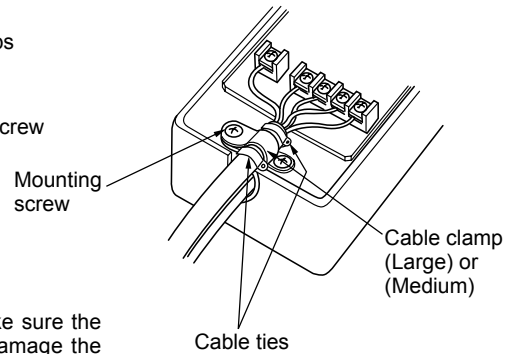

(4) Connecting to the MA remote controller

- For connection of the MA remote controller, connect the MA remote control cable to TB580 (non-polarized).
- When more than one unit of room air conditioner is operated in group control, use the daisy chain wiring method by connecting the MA remote control cable to TB580.

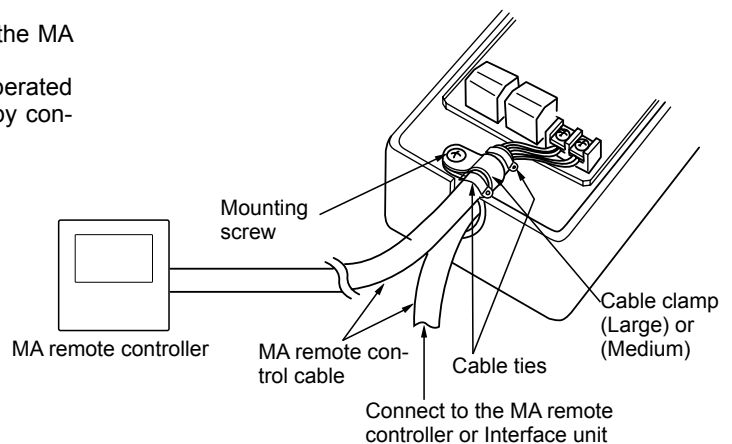

(5) Checking the communication status

LED lamps on the interface unit indicate the status of the interface.

Check item	Setting of SW500-7	LED lamp	Description
Communication with room air conditioner	 ON OFF 1 2 3 4 5 6 7 8 SW500-7	LE501 (Orange)	When the lamp is blinking at an interval of about 1 second, communication with the room air conditioner is normal. When the lamp is off, communication with the room air conditioner is abnormal.
Communication with M-NET system controller	 ON OFF 1 2 3 4 5 6 7 8 SW500-7	LE502 (Red)	When the lamp is blinking at an interval of less than about 1 minute, communication with the M-NET controller is normal. When the lamp is off, communication with the M-NET controller is abnormal.
Communication with MA remote controller	 ON OFF 1 2 3 4 5 6 7 8 SW500-7	LE501 (Orange)	When the lamp is blinking at an interval of about 10 seconds, communication with the MA remote controller is normal. When the lamp is off, communication with the MA remote controller is abnormal.
Power supply to MA remote controller	Not necessary	LE581 (Orange)	When the lamp is illuminated, power is supplied to the MA remote controller from the Interface unit. When the lamp is off, power is not supplied.

- SW500-7 can be switched after the main power is turned on. (Conduct the settings of other dip switches before turning on the power)
- When the communication is not normally performed, check for the disconnection of the communication cable from the connector or the terminal block.

(6) Power supply diagram

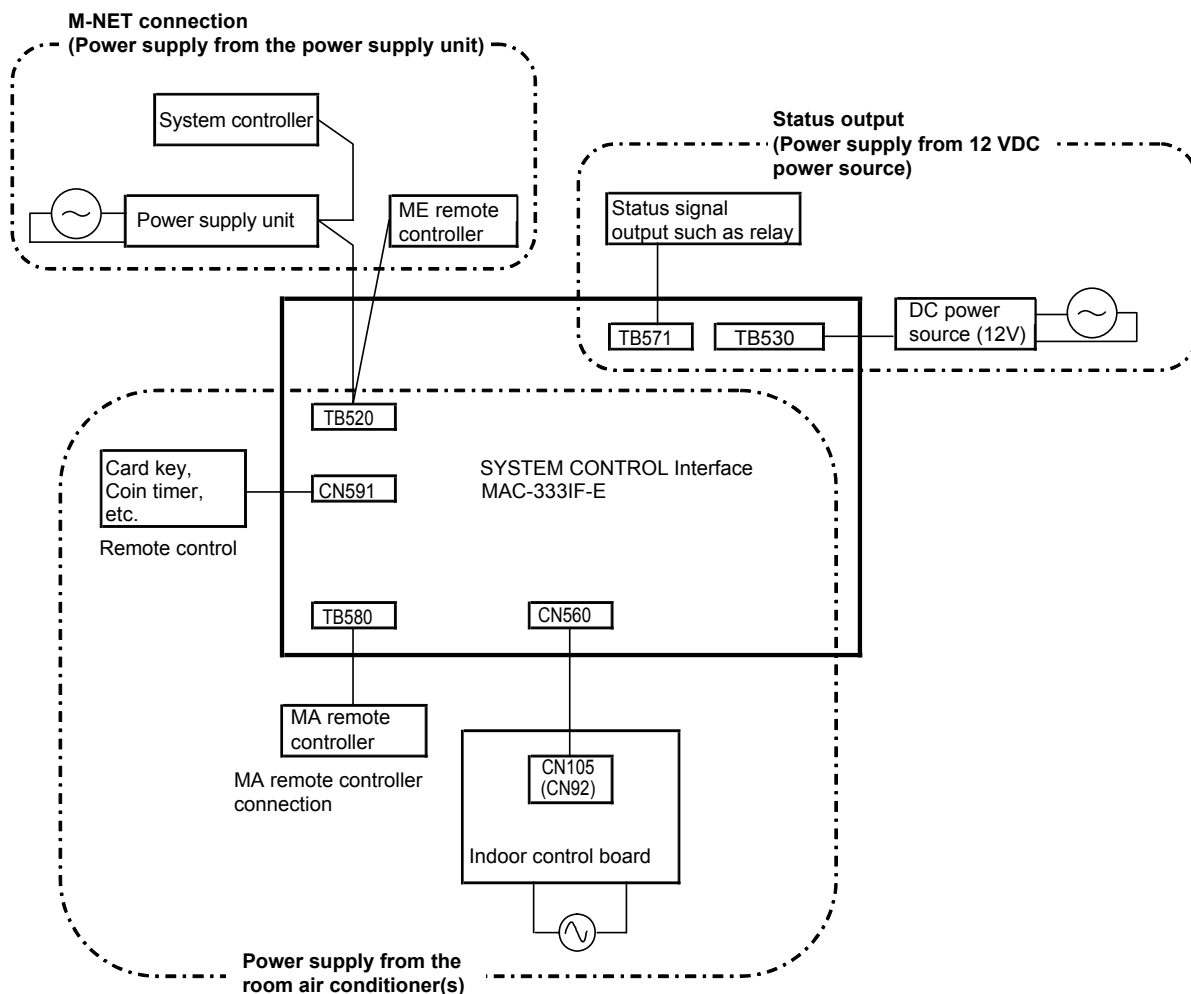

Multiple power sources are required according to the functions to be used.



4 SETTING OF DIP SWITCH AND ROTARY SWITCH

- Set the switches before turning on the power. The interface unit will not work normally if the switches are not set correctly.

① Rotary switches (SW501, SW510) ... M-NET address setting

SW No.	M-NET Address	Description
SW510 SW501	tens place ones place  SW510  SW501 *Both SW510 and SW501 are set to "0" at the factory setting.	<ul style="list-style-type: none"> • Set the address for centralized control. (Address can be set from 01 to 50.) • SW510 sets the tens place of the address and SW501 sets the ones place of the address. For example, to set the address to 25, set SW510 to "2" and SW501 to "5." * The figure to the left indicates that the address is set to "1". • Set different addresses to each unit in the same system.

② Rotary switch (SW580) ... Refrigerant address setting

SW No.	Refrigerant Address	Description
SW580	 SW580 *SW580 is set to "0" at the factory setting.	<ul style="list-style-type: none"> • When the MA remote controller is not used, set the refrigerant address (SW580) to "1." • Set the address to "0" for the interface which supplies power to the MA remote controller. • When more than one unit of room air conditioner is operated in the group setting, set different addresses to each unit. * A to F of the rotary switch corresponds to the refrigerant address of 10 to 15 respectively.

③ Dip Switch (SW500): Function setting switch A

SW No.	Functions	OFF (Factory setting)	ON
SW500-1	Not available	— (Set to OFF)	—
SW500-2	ON/OFF control by main power source	Disabled	Enabled
SW500-3	Detecting position of room temperature sensor	Indoor unit	MA remote controller
SW500-4 SW500-5	Output settings	Outputs for ON/OFF, error/normal, heater ON/OFF, and humidifier ON/OFF	
SW500-6	Input settings	Inputs for ON/OFF and disabling/enabling operation	Inputs for ON/OFF and heating/cooling
SW500-7	Interface status check display	LE501: Communication with indoor unit LE502: Communication with M-NET System LE581: Power supply to MA remote controller	LE501: Communication with MA remote controller LE502: OFF LE581: Power supply to MA remote controller
SW500-8	Not available	— (Set to OFF)	—

④ Dip Switch (SW502): Function setting switch B

SW No.	Functions	OFF (Factory setting)	ON
SW502-1	Output change	12 VDC is output during operation, in abnormal state, etc.	12 VDC is output when the air conditioner stops, in normal state, etc.
SW502-2	Input mode	Continuous contact	Instantaneous contact
SW502-3	Setting for the range of operation prohibited by contact switches	ON/OFF operation with M-NET system controller is enabled.	ON/OFF operation with M-NET system controller is disabled.
SW502-4	Input change	Input mode is set to continuous contact	Certain behavior is performed, for example running or operating the air conditioner is prohibited, by closing the continuous contact switch.
		Input mode is set to instantaneous contact	ON/OFF operation is inverted by switching the instantaneous contact switches.
SW502-5	Behavior setting when the operation is prohibited by the contact switch	The state remains the same as that before the operation is prohibited.	The operation stops.
SW502-6	Behavior setting when the operation prohibition is cancelled by the contact switch	The state remains the same as that before the operation prohibition is cancelled.	The operation starts.
SW502-7	Not available	— (Set to OFF)	—
SW502-8	Setting when P series is included in the same group (only when running group operation using the MA remote controller)	Not included	Included







5 FUNCTIONS

5.1 M-NET CONNECTION

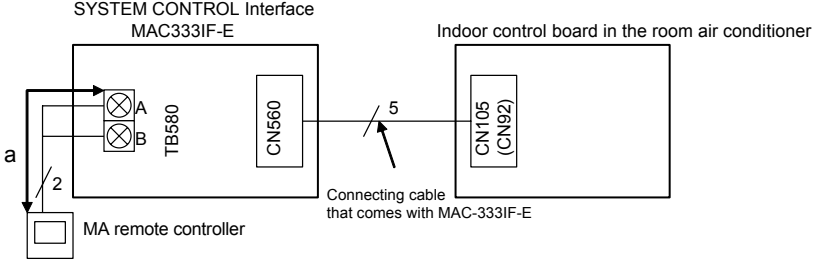

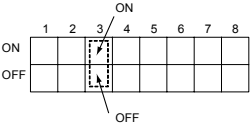

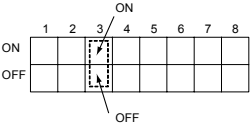

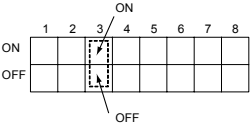
Function summary	<p>MELANS system controller using M-NET communication control enables the centralized/separate control of the room air conditioner with the packaged air conditioner (P-series and City Multi-series).</p>														
System configuration	<p style="text-align: right;">*To connect P-series to M-NET system, the M-NET adapter connection is necessary.</p>														
Switch setting	<p>•M-NET address setting</p> <table border="1" data-bbox="236 792 1422 1032"> <thead> <tr> <th>SW No.</th> <th>M-NET address</th> <th>Description</th> </tr> </thead> <tbody> <tr> <td>SW510</td> <td>tens place</td> <td rowspan="2"> <ul style="list-style-type: none"> Set the address for centralized control. (Address can be set from 01 to 50.) SW510 sets the tens place of the address and SW501 sets the ones place of the address. For example, to set the address to 25, set SW510 to "2" and SW501 to "5." * The figure to the left indicates that the address is set to "1". Set different addresses to each unit in the same system. </td> </tr> <tr> <td>SW501</td> <td>ones place</td> </tr> </tbody> </table> <p>•Refrigerant address setting</p> <table border="1" data-bbox="236 1070 1422 1234"> <thead> <tr> <th>SW No.</th> <th>Refrigerant address</th> <th>Description</th> </tr> </thead> <tbody> <tr> <td>SW580</td> <td></td> <td> <ul style="list-style-type: none"> When the MA remote controller is not used, set the refrigerant address (SW580) to "1." To connect MA remote controller, refer to 5.2 "MA REMOTE CONTROLLER CONNECTION". </td> </tr> </tbody> </table>	SW No.	M-NET address	Description	SW510	tens place	<ul style="list-style-type: none"> Set the address for centralized control. (Address can be set from 01 to 50.) SW510 sets the tens place of the address and SW501 sets the ones place of the address. For example, to set the address to 25, set SW510 to "2" and SW501 to "5." * The figure to the left indicates that the address is set to "1". Set different addresses to each unit in the same system. 	SW501	ones place	SW No.	Refrigerant address	Description	SW580		<ul style="list-style-type: none"> When the MA remote controller is not used, set the refrigerant address (SW580) to "1." To connect MA remote controller, refer to 5.2 "MA REMOTE CONTROLLER CONNECTION".
SW No.	M-NET address	Description													
SW510	tens place	<ul style="list-style-type: none"> Set the address for centralized control. (Address can be set from 01 to 50.) SW510 sets the tens place of the address and SW501 sets the ones place of the address. For example, to set the address to 25, set SW510 to "2" and SW501 to "5." * The figure to the left indicates that the address is set to "1". Set different addresses to each unit in the same system. 													
SW501	ones place														
SW No.	Refrigerant address	Description													
SW580		<ul style="list-style-type: none"> When the MA remote controller is not used, set the refrigerant address (SW580) to "1." To connect MA remote controller, refer to 5.2 "MA REMOTE CONTROLLER CONNECTION". 													
Specifications of communication cable	<p>• Cable type</p> <p>a, b: 2-core shield cable (CVVS, CPEVS, MVVS), size 1.25 mm² or more</p> <ul style="list-style-type: none"> *To use a daisy chain wiring on the same terminal block, use a 1.25 mm² cable. Use the following cable for the ME remote controller. <ul style="list-style-type: none"> The distance between the interface unit and the ME remote controller is less than 10 m : 2-core shield cable (CVVS, CPEVS, MVVS), size 0.3 mm² or more. The distance between the interface unit and the ME remote controller is 10 m or more : 2-core shield cable (CVVS, CPEVS, MVVS), size 1.25 mm² or more. <p>• Cable length</p> <p>a, b: The distance between the power supply unit and the furthest interface unit must be 200 m or less.</p>														
Note	<ul style="list-style-type: none"> The system settings, such as group setting, on the system controller are required. <ul style="list-style-type: none"> * Refer to the instruction manual for the system controller used regarding the system settings such as group setting. The number of indoor units that can be controlled depends on the type of the system controller. Refer to the instruction manual for the system controller used. When more than one system controller, ME remote controller or the like is connected, check the power supply capacity of the power supply unit. <ul style="list-style-type: none"> * Coefficient of performance of the interface unit is "0". Refer to the respective instruction manuals regarding the specifications of the communication cable for ME remote controller, system controller, or the like. Test run cannot be performed using the ME remote controller, the system controller, or the like. To set the timer, use only one controller from the wireless remote controller, the ME remote controller, or the system controller. If timer is set with more than one controller, timer may not work normally. Vertical vanes of the indoor unit cannot be operated with the ME remote controller, the system controller, or the like. To operate more than one air conditioner in the group setting using M-NET system, the following restrictions will be applied. <ul style="list-style-type: none"> The wireless remote controller cannot be used. P-series and City Multi-series cannot be set in the same group with M-series. When more than one room air conditioner is set in the same group using the system controller and the MA remote controller is also used together, the group control setting with the MA remote controller is required. The following functions of the system controller are not available. <ul style="list-style-type: none"> DIDO controller (Interlock with the air conditioner) Fan control of energy saving control or peak cut control function Air conditioning charge [TG-2000A] Set temperature range limiting function Operation mode changeover limit (season changing) [PAC-SF44SRA] 														

5.2 MA REMOTE CONTROLLER CONNECTION

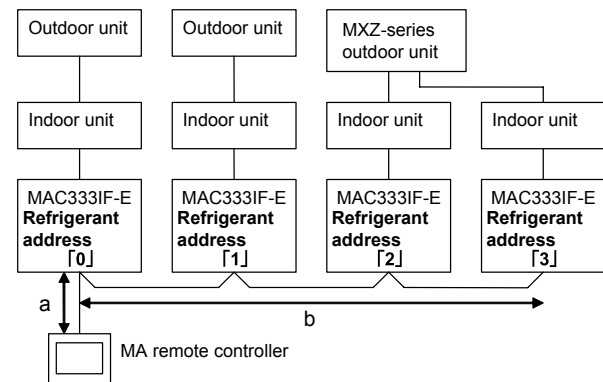
(1) Connecting to the MA remote controller

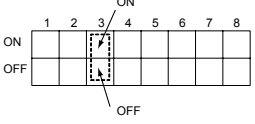
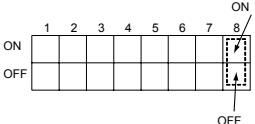
Function summary	The wired remote controller (MA remote controller) can be connected to the room air conditioner.													
System configuration	 <p>SYSTEM CONTROL Interface MAC333IF-E</p> <p>Indoor control board in the room air conditioner</p> <p>MA remote controller</p> <p>Connecting cable that comes with MAC-333IF-E</p>													
Switch setting	<p>To operate one indoor unit with the MA remote controller, the following switch setting is required.</p> <p>* To operate more than one air conditioner using group setting with the MA remote controller, refer to 5.2 “MA REMOTE CONTROLLER CONNECTION” (2) “Group operation using the MA remote controller”.</p> <p>• Setting for refrigerant address</p> <table border="1" data-bbox="312 696 1490 857"> <thead> <tr> <th>SW No.</th> <th>Refrigerant address</th> <th>Description</th> </tr> </thead> <tbody> <tr> <td>SW580</td> <td> SW580</td> <td>• Set the refrigerant address to “0” for the unit that supplies electric power to the MA remote controller.</td> </tr> </tbody> </table> <p>• Setting for position of room temperature sensor</p> <table border="1" data-bbox="312 898 1490 1099"> <thead> <tr> <th>SW No.</th> <th>Dip switch</th> <th>Operating details</th> </tr> </thead> <tbody> <tr> <td>SW500-3</td> <td></td> <td> <p>SW500-3: OFF</p> <ul style="list-style-type: none"> • Temperature detected by the intake temperature sensor of the indoor unit is regarded as room temperature. <p>SW500-3: ON</p> <ul style="list-style-type: none"> • Temperature detected by the temperature sensor of the MA remote controller is regarded as room temperature. </td> </tr> </tbody> </table>		SW No.	Refrigerant address	Description	SW580	 SW580	• Set the refrigerant address to “0” for the unit that supplies electric power to the MA remote controller.	SW No.	Dip switch	Operating details	SW500-3		<p>SW500-3: OFF</p> <ul style="list-style-type: none"> • Temperature detected by the intake temperature sensor of the indoor unit is regarded as room temperature. <p>SW500-3: ON</p> <ul style="list-style-type: none"> • Temperature detected by the temperature sensor of the MA remote controller is regarded as room temperature.
SW No.	Refrigerant address	Description												
SW580	 SW580	• Set the refrigerant address to “0” for the unit that supplies electric power to the MA remote controller.												
SW No.	Dip switch	Operating details												
SW500-3		<p>SW500-3: OFF</p> <ul style="list-style-type: none"> • Temperature detected by the intake temperature sensor of the indoor unit is regarded as room temperature. <p>SW500-3: ON</p> <ul style="list-style-type: none"> • Temperature detected by the temperature sensor of the MA remote controller is regarded as room temperature. 												
Specifications of communication cable	<p>• Cable type</p> <p>MA smooth remote controller or MA smart remote controller is used: 2-core sheathed cable, size 0.3 mm² to 1.25 mm²</p> <p>MA compact remote controller is used: 2-core sheathed cable, size 0.75 mm² to 1.25 mm²</p> <p>• Cable length</p> <p>a: The distance between the interface unit with refrigerant address of “0” and the MA remote controller must be 10 m or less.</p>													
Note	<ul style="list-style-type: none"> • Set the “auto COOL/HEAT display” on the MA remote controller to OFF. <ul style="list-style-type: none"> * Refer to the instruction manual for the MA remote controller regarding the setting method of “auto COOL/HEAT display”. * If “auto COOL/HEAT display” is not OFF, the display on the remote controller and the actual operation of the indoor unit may differ. • Test run cannot be performed using the MA remote controller, the system controller, or the like. Use the switch on the indoor unit for test run. • Vertical vanes of the indoor unit cannot be operated with the MA remote controller, the system controller, or the like. • Timer should be set with either wireless remote controller or MA remote controller. If timer is set with both remote controllers, timer may not work normally. • If the MA remote controller is used without the M-NET system, a maximum of two MA remote controllers can be connected. One of them must be set as a slave remote controller. <ul style="list-style-type: none"> * Refer to the instruction manual for the MA remote controller regarding the setting method of a slave remote controller. • If the MA remote controller will be used with the M-NET system, only one MA remote controller can be connected. 													

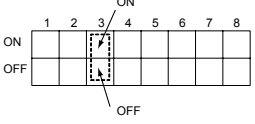
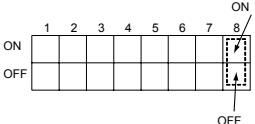
(2) Group operation using the MA remote controller

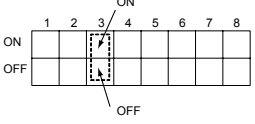
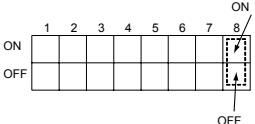
Function summary	A maximum of 16 indoor units can be operated in the group operation using the MA remote controller.																			
System configuration	 <p style="text-align: center;">* The air conditioners cannot be operated separately.</p>																			
Switch setting	<p>• Setting for refrigerant address</p> <table border="1" data-bbox="247 672 1420 840"> <thead> <tr> <th>SW No.</th> <th>Refrigerant Address</th> <th>Description</th> </tr> </thead> <tbody> <tr> <td>SW580</td> <td></td> <td> <ul style="list-style-type: none"> Set different refrigerant addresses for each unit within a group. *A to F of the rotary switch correspond to refrigerant addresses of 10 to 15 respectively. </td> </tr> </tbody> </table> <p>• Setting for position of room temperature sensor</p> <table border="1" data-bbox="247 873 1420 1108"> <thead> <tr> <th>SW No.</th> <th>Dip switch</th> <th>Operating details</th> </tr> </thead> <tbody> <tr> <td>SW500-3</td> <td></td> <td> <p>SW500-3: OFF</p> <ul style="list-style-type: none"> Temperature detected by the intake temperature sensor of the indoor unit is regarded as room temperature. <p>SW500-3: ON</p> <ul style="list-style-type: none"> Temperature detected by the temperature sensor of the MA remote controller is regarded as room temperature. </td> </tr> </tbody> </table> <p>• Setting when P series is included in the same group</p> <table border="1" data-bbox="247 1153 1420 1344"> <thead> <tr> <th>SW No.</th> <th>Dip switch</th> <th>Operating details</th> </tr> </thead> <tbody> <tr> <td>SW502-8</td> <td></td> <td> <p>SW502-8: OFF</p> <ul style="list-style-type: none"> Set to OFF when P-series is not included in the same group. <p>SW502-8: ON</p> <ul style="list-style-type: none"> Set to ON when P-series is included in the same group. </td> </tr> </tbody> </table>		SW No.	Refrigerant Address	Description	SW580		<ul style="list-style-type: none"> Set different refrigerant addresses for each unit within a group. *A to F of the rotary switch correspond to refrigerant addresses of 10 to 15 respectively. 	SW No.	Dip switch	Operating details	SW500-3		<p>SW500-3: OFF</p> <ul style="list-style-type: none"> Temperature detected by the intake temperature sensor of the indoor unit is regarded as room temperature. <p>SW500-3: ON</p> <ul style="list-style-type: none"> Temperature detected by the temperature sensor of the MA remote controller is regarded as room temperature. 	SW No.	Dip switch	Operating details	SW502-8		<p>SW502-8: OFF</p> <ul style="list-style-type: none"> Set to OFF when P-series is not included in the same group. <p>SW502-8: ON</p> <ul style="list-style-type: none"> Set to ON when P-series is included in the same group.
SW No.	Refrigerant Address	Description																		
SW580		<ul style="list-style-type: none"> Set different refrigerant addresses for each unit within a group. *A to F of the rotary switch correspond to refrigerant addresses of 10 to 15 respectively. 																		
SW No.	Dip switch	Operating details																		
SW500-3		<p>SW500-3: OFF</p> <ul style="list-style-type: none"> Temperature detected by the intake temperature sensor of the indoor unit is regarded as room temperature. <p>SW500-3: ON</p> <ul style="list-style-type: none"> Temperature detected by the temperature sensor of the MA remote controller is regarded as room temperature. 																		
SW No.	Dip switch	Operating details																		
SW502-8		<p>SW502-8: OFF</p> <ul style="list-style-type: none"> Set to OFF when P-series is not included in the same group. <p>SW502-8: ON</p> <ul style="list-style-type: none"> Set to ON when P-series is included in the same group. 																		
Specifications of communication cable	<p>• Cable type</p> <p>MA smooth remote controller or MA smart remote controller is used: 2-core sheathed cable, size 0.3 mm² to 1.25 mm²</p> <p>MA compact remote controller is used: 2-core sheathed cable, size 0.75 mm² to 1.25 mm²</p> <p>• Cable length</p> <p>a: The distance between the interface unit with refrigerant address of "0" and the MA remote controller must be 10 m or less.</p> <p>b: Daisy chain wiring should be 50 m or less.</p>																			
Note	<p>Note the followings as well as 5.2 "MA REMOTE CONTROLLER CONNECTION" (1) "Connecting to the MA remote controller".</p> <ul style="list-style-type: none"> A maximum of 16 interface units can be connected to a MA remote controller. In group operation, all the air conditioners operate in the same operation status. Operation status can not be set separately. Connect one interface unit to each indoor unit connected to MXZ-series outdoor unit. Set separate refrigerant addresses to each unit. Group operation cannot be performed with City Multi-series. If the interface is connected to the M-NET system, group setting should be made with the M-NET system controller as well as the MA remote controller. <ul style="list-style-type: none"> * To make a group setting with the M-NET system controller, refer to the instruction manual for the system controller used. * Set the refrigerant address to "0" for the interface with the lowest M-NET address number. If the MA remote controller will be used without the M-NET system, a maximum of two MA remote controllers can be connected to the interface. One of them must be set as a slave remote controller. <ul style="list-style-type: none"> * Refer to the instruction manual for the MA remote controller regarding the setting method of a slave remote controller. If the MA remote controller will be used with the M-NET system, only one MA remote controller can be connected to the interface. The wireless remote controller cannot be used together. 																			

5.3 REMOTE CONTROL

(1) Card key connection (Switch will open by insertion of the card key.)

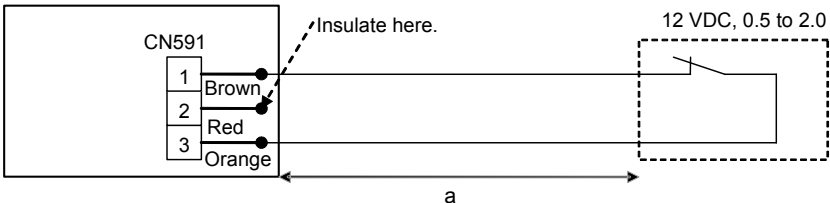
Function summary	Switch will open by insertion of the card key, which stops the room air conditioner.																																																										
System configuration	<p>SYSTEM CONTROL Interface MAC333IF-E</p>  <p>The card key must be the one that</p> <ul style="list-style-type: none"> · opens the switch when inserted. · can be used on the following condition: 12 VDC, 0.5 to 2.0 mA 																																																										
Behavior	<ul style="list-style-type: none"> · When the card is inserted (and the switch opens), the ON/OFF operation from the paired remote controller is enabled. · When the card is removed (and the switch closes), the air conditioner stops and the ON/OFF operation from the paired remote controller is prohibited. <p>* "Paired remote controller" includes the wireless remote controller that comes with the room air conditioner, the MA remote controller, and the ME remote controller.</p>																																																										
Switch setting	<p>· Card key connection (Switch will open by insertion of the card key.)</p> <table border="1" data-bbox="311 705 1508 929"> <thead> <tr> <th>SW No.</th> <th>Dip switch</th> <th>Operating details</th> </tr> </thead> <tbody> <tr> <td>SW500</td> <td> <table border="1" data-bbox="438 750 702 840"> <tr><td>1</td><td>2</td><td>3</td><td>4</td><td>5</td><td>6</td><td>7</td><td>8</td></tr> <tr><td>ON</td><td></td><td></td><td></td><td></td><td></td><td></td><td></td></tr> <tr><td>OFF</td><td></td><td></td><td></td><td></td><td>■</td><td></td><td>■</td></tr> </table> </td> <td>· SW500-6,8: OFF</td> </tr> <tr> <td>SW502</td> <td> <table border="1" data-bbox="438 840 702 918"> <tr><td>1</td><td>2</td><td>3</td><td>4</td><td>5</td><td>6</td><td>7</td><td>8</td></tr> <tr><td>ON</td><td></td><td></td><td></td><td>■</td><td></td><td></td><td></td></tr> <tr><td>OFF</td><td>■</td><td>■</td><td>■</td><td></td><td>■</td><td></td><td></td></tr> </table> </td> <td>· SW502-2,3,4,6: OFF · SW502-5: ON</td> </tr> </tbody> </table>		SW No.	Dip switch	Operating details	SW500	<table border="1" data-bbox="438 750 702 840"> <tr><td>1</td><td>2</td><td>3</td><td>4</td><td>5</td><td>6</td><td>7</td><td>8</td></tr> <tr><td>ON</td><td></td><td></td><td></td><td></td><td></td><td></td><td></td></tr> <tr><td>OFF</td><td></td><td></td><td></td><td></td><td>■</td><td></td><td>■</td></tr> </table>	1	2	3	4	5	6	7	8	ON								OFF					■		■	· SW500-6,8: OFF	SW502	<table border="1" data-bbox="438 840 702 918"> <tr><td>1</td><td>2</td><td>3</td><td>4</td><td>5</td><td>6</td><td>7</td><td>8</td></tr> <tr><td>ON</td><td></td><td></td><td></td><td>■</td><td></td><td></td><td></td></tr> <tr><td>OFF</td><td>■</td><td>■</td><td>■</td><td></td><td>■</td><td></td><td></td></tr> </table>	1	2	3	4	5	6	7	8	ON				■				OFF	■	■	■		■			· SW502-2,3,4,6: OFF · SW502-5: ON
SW No.	Dip switch	Operating details																																																									
SW500	<table border="1" data-bbox="438 750 702 840"> <tr><td>1</td><td>2</td><td>3</td><td>4</td><td>5</td><td>6</td><td>7</td><td>8</td></tr> <tr><td>ON</td><td></td><td></td><td></td><td></td><td></td><td></td><td></td></tr> <tr><td>OFF</td><td></td><td></td><td></td><td></td><td>■</td><td></td><td>■</td></tr> </table>	1	2	3	4	5	6	7	8	ON								OFF					■		■	· SW500-6,8: OFF																																	
1	2	3	4	5	6	7	8																																																				
ON																																																											
OFF					■		■																																																				
SW502	<table border="1" data-bbox="438 840 702 918"> <tr><td>1</td><td>2</td><td>3</td><td>4</td><td>5</td><td>6</td><td>7</td><td>8</td></tr> <tr><td>ON</td><td></td><td></td><td></td><td>■</td><td></td><td></td><td></td></tr> <tr><td>OFF</td><td>■</td><td>■</td><td>■</td><td></td><td>■</td><td></td><td></td></tr> </table>	1	2	3	4	5	6	7	8	ON				■				OFF	■	■	■		■			· SW502-2,3,4,6: OFF · SW502-5: ON																																	
1	2	3	4	5	6	7	8																																																				
ON				■																																																							
OFF	■	■	■		■																																																						
Specifications of communication cable	<ul style="list-style-type: none"> · Cable type a: Sheathed cable, size 0.3 mm² or more · Cable length a: Cable size is 0.3 mm²: 50 m or less / Cable size is 0.5 mm²: 100 m or less 																																																										
Note	<ul style="list-style-type: none"> · The operation of the paired remote controller prohibited by the card key is the ON/OFF operation only. Other operations, such as setting the temperature, are enabled. · When the interface is connected to the M-NET system, even though the card key prohibits the operation with the paired remote controller, the ON/OFF operation with the system controller is enabled. · When the interface is connected to the M-NET system, if the system controller prohibits the manual ON/OFF operation, the ON/OFF operation with the card key is prohibited. To enable the card key, do not disable the manual operation on the system controller. · When the group setting is made with the M-NET system or the MA remote controller, connect the card key to the interface with the lowest M-NET address or refrigerant address. The wireless remote controller cannot be used together. 																																																										

(2) Card key connection (Switch will close by insertion of the card key.)

*** Card key connection can be linked with the open/close switch of the window.**

Function summary	Switch will close by insertion of the card key, which stops the room air conditioner.																																																																
System configuration	<div style="display: flex; justify-content: space-between;"> <div style="width: 60%;"> <p>SYSTEM CONTROL Interface MAC333IF-E</p> </div> <div style="width: 35%;"> <p>The card key must be the one that</p> <ul style="list-style-type: none"> · closes the switch when inserted. · can be used on the following condition: 12 VDC, 0.5 to 2.0 mA </div> </div>																																																																
Behavior	<ul style="list-style-type: none"> · When the card is inserted (and the switch closes), the ON/OFF operation from the paired remote controller is enabled. · When the card is removed (and the switch opens), the air conditioner stops and the ON/OFF operation from the paired remote controller is prohibited. * "Paired remote controller" includes the wireless remote controller that comes with the room air conditioner, the MA remote controller, and the ME remote controller. 																																																																
Switch setting	<p>· Card key connection (Switch will close by insertion of the card key.)</p> <table border="1" style="width: 100%; border-collapse: collapse;"> <thead> <tr> <th style="width: 15%;">SW No.</th> <th style="width: 35%;">Dip switch</th> <th style="width: 50%;">Operating details</th> </tr> </thead> <tbody> <tr> <td style="text-align: center;">SW500</td> <td> <table border="1" style="width: 100%; border-collapse: collapse;"> <tr> <td style="width: 5%;"></td> <td style="width: 5%;">1</td> <td style="width: 5%;">2</td> <td style="width: 5%;">3</td> <td style="width: 5%;">4</td> <td style="width: 5%;">5</td> <td style="width: 5%;">6</td> <td style="width: 5%;">7</td> <td style="width: 5%;">8</td> </tr> <tr> <td style="text-align: right;">ON</td> <td></td> <td></td> <td></td> <td></td> <td></td> <td></td> <td></td> <td></td> </tr> <tr> <td style="text-align: right;">OFF</td> <td></td> <td></td> <td></td> <td style="text-align: center;">■</td> <td style="text-align: center;">■</td> <td></td> <td></td> <td></td> </tr> </table> </td> <td>· SW500-6,8: OFF</td> </tr> <tr> <td style="text-align: center;">SW502</td> <td> <table border="1" style="width: 100%; border-collapse: collapse;"> <tr> <td style="width: 5%;"></td> <td style="width: 5%;">1</td> <td style="width: 5%;">2</td> <td style="width: 5%;">3</td> <td style="width: 5%;">4</td> <td style="width: 5%;">5</td> <td style="width: 5%;">6</td> <td style="width: 5%;">7</td> <td style="width: 5%;">8</td> </tr> <tr> <td style="text-align: right;">ON</td> <td></td> <td></td> <td></td> <td style="text-align: center;">■</td> <td style="text-align: center;">■</td> <td></td> <td></td> <td></td> </tr> <tr> <td style="text-align: right;">OFF</td> <td style="text-align: center;">■</td> <td style="text-align: center;">■</td> <td></td> <td></td> <td></td> <td style="text-align: center;">■</td> <td></td> <td></td> </tr> </table> </td> <td> <ul style="list-style-type: none"> · SW502-2,3,6: OFF · SW502-4,5: ON </td> </tr> </tbody> </table>		SW No.	Dip switch	Operating details	SW500	<table border="1" style="width: 100%; border-collapse: collapse;"> <tr> <td style="width: 5%;"></td> <td style="width: 5%;">1</td> <td style="width: 5%;">2</td> <td style="width: 5%;">3</td> <td style="width: 5%;">4</td> <td style="width: 5%;">5</td> <td style="width: 5%;">6</td> <td style="width: 5%;">7</td> <td style="width: 5%;">8</td> </tr> <tr> <td style="text-align: right;">ON</td> <td></td> <td></td> <td></td> <td></td> <td></td> <td></td> <td></td> <td></td> </tr> <tr> <td style="text-align: right;">OFF</td> <td></td> <td></td> <td></td> <td style="text-align: center;">■</td> <td style="text-align: center;">■</td> <td></td> <td></td> <td></td> </tr> </table>		1	2	3	4	5	6	7	8	ON									OFF				■	■				· SW500-6,8: OFF	SW502	<table border="1" style="width: 100%; border-collapse: collapse;"> <tr> <td style="width: 5%;"></td> <td style="width: 5%;">1</td> <td style="width: 5%;">2</td> <td style="width: 5%;">3</td> <td style="width: 5%;">4</td> <td style="width: 5%;">5</td> <td style="width: 5%;">6</td> <td style="width: 5%;">7</td> <td style="width: 5%;">8</td> </tr> <tr> <td style="text-align: right;">ON</td> <td></td> <td></td> <td></td> <td style="text-align: center;">■</td> <td style="text-align: center;">■</td> <td></td> <td></td> <td></td> </tr> <tr> <td style="text-align: right;">OFF</td> <td style="text-align: center;">■</td> <td style="text-align: center;">■</td> <td></td> <td></td> <td></td> <td style="text-align: center;">■</td> <td></td> <td></td> </tr> </table>		1	2	3	4	5	6	7	8	ON				■	■				OFF	■	■				■			<ul style="list-style-type: none"> · SW502-2,3,6: OFF · SW502-4,5: ON
SW No.	Dip switch	Operating details																																																															
SW500	<table border="1" style="width: 100%; border-collapse: collapse;"> <tr> <td style="width: 5%;"></td> <td style="width: 5%;">1</td> <td style="width: 5%;">2</td> <td style="width: 5%;">3</td> <td style="width: 5%;">4</td> <td style="width: 5%;">5</td> <td style="width: 5%;">6</td> <td style="width: 5%;">7</td> <td style="width: 5%;">8</td> </tr> <tr> <td style="text-align: right;">ON</td> <td></td> <td></td> <td></td> <td></td> <td></td> <td></td> <td></td> <td></td> </tr> <tr> <td style="text-align: right;">OFF</td> <td></td> <td></td> <td></td> <td style="text-align: center;">■</td> <td style="text-align: center;">■</td> <td></td> <td></td> <td></td> </tr> </table>		1	2	3	4	5	6	7	8	ON									OFF				■	■				· SW500-6,8: OFF																																				
	1	2	3	4	5	6	7	8																																																									
ON																																																																	
OFF				■	■																																																												
SW502	<table border="1" style="width: 100%; border-collapse: collapse;"> <tr> <td style="width: 5%;"></td> <td style="width: 5%;">1</td> <td style="width: 5%;">2</td> <td style="width: 5%;">3</td> <td style="width: 5%;">4</td> <td style="width: 5%;">5</td> <td style="width: 5%;">6</td> <td style="width: 5%;">7</td> <td style="width: 5%;">8</td> </tr> <tr> <td style="text-align: right;">ON</td> <td></td> <td></td> <td></td> <td style="text-align: center;">■</td> <td style="text-align: center;">■</td> <td></td> <td></td> <td></td> </tr> <tr> <td style="text-align: right;">OFF</td> <td style="text-align: center;">■</td> <td style="text-align: center;">■</td> <td></td> <td></td> <td></td> <td style="text-align: center;">■</td> <td></td> <td></td> </tr> </table>		1	2	3	4	5	6	7	8	ON				■	■				OFF	■	■				■			<ul style="list-style-type: none"> · SW502-2,3,6: OFF · SW502-4,5: ON 																																				
	1	2	3	4	5	6	7	8																																																									
ON				■	■																																																												
OFF	■	■				■																																																											
Specifications of communication cable	<ul style="list-style-type: none"> · Cable type a: Sheathed cable, size 0.3 mm² or more · Cable length a: Cable size is 0.3 mm²: 50 m or less / Cable size is 0.5 mm²: 100 m or less 																																																																
Note	<ul style="list-style-type: none"> · The operation of the paired remote controller prohibited by the card key is the ON/OFF operation only. Other operations, such as setting the temperature, are enabled. · When the interface is connected to the M-NET system, even though the card key prohibits the manual operation with the paired remote controller, the ON/OFF operation with the system controller is enabled. · When the interface is connected to the M-NET system, if the system controller prohibits the manual ON/OFF operation, the ON/OFF operation with the card key is prohibited. To enable the card key, do not disable the manual operation on the system controller. · When the group setting is made with the M-NET system or the MA remote controller, connect the card key to the interface with the lowest M-NET address or refrigerant address. The wireless remote controller cannot be used together. 																																																																

(3) Coin timer connection (Switch will close after a coin is inserted.)

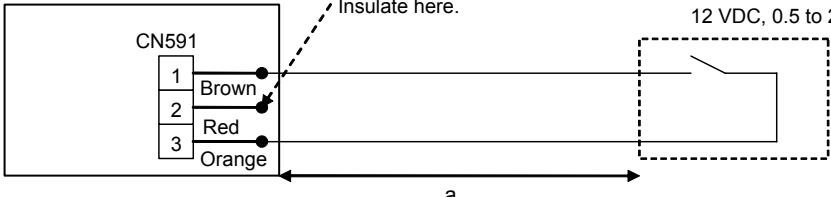
Function summary	Switch will close after insertion of a coin, which starts/stops the room air conditioner.																																													
System configuration	<div style="display: flex; justify-content: space-between;"> <div style="width: 60%;"> <p>SYSTEM CONTROL Interface MAC333IF-E</p>  </div> <div style="width: 35%;"> <p>Coin timer must be the one that</p> <ul style="list-style-type: none"> · closes the switch when inserted. · can be used on the following condition: 12 VDC, 0.5 to 2.0 mA </div> </div>																																													
Behavior	<ul style="list-style-type: none"> · When a coin is inserted (and the switch closes), the air conditioner starts the operation and the ON/OFF operation from the paired remote controller is enabled. · When the timer expires (and the switch opens), the air conditioner stops and the ON/OFF operation from the paired remote controller is prohibited. <p>* "Paired remote controller" includes the wireless remote controller that comes with the room air conditioner, the MA remote controller, and the ME remote controller.</p>																																													
Switch setting	<p>· Coin timer connection (Switch will close after insertion of a coin.)</p> <table border="1" style="width: 100%; border-collapse: collapse;"> <thead> <tr> <th style="width: 15%;">SW No.</th> <th style="width: 45%;">Dip switch</th> <th style="width: 40%;">Operating details</th> </tr> </thead> <tbody> <tr> <td style="text-align: center;">SW500</td> <td> <table border="1" style="width: 100%; border-collapse: collapse;"> <tr> <td style="width: 5%;">ON</td> <td style="width: 5%;">1</td><td style="width: 5%;">2</td><td style="width: 5%;">3</td><td style="width: 5%;">4</td><td style="width: 5%;">5</td><td style="width: 5%;">6</td><td style="width: 5%;">7</td><td style="width: 5%;">8</td> </tr> <tr> <td style="width: 5%;">OFF</td> <td></td><td></td><td></td><td></td><td></td><td style="text-align: center;">■</td><td></td><td style="text-align: center;">■</td> </tr> </table> </td> <td>· SW500-6,8: OFF</td> </tr> <tr> <td style="text-align: center;">SW502</td> <td> <table border="1" style="width: 100%; border-collapse: collapse;"> <tr> <td style="width: 5%;">ON</td> <td style="width: 5%;">1</td><td style="width: 5%;">2</td><td style="width: 5%;">3</td><td style="width: 5%;">4</td><td style="width: 5%;">5</td><td style="width: 5%;">6</td><td style="width: 5%;">7</td><td style="width: 5%;">8</td> </tr> <tr> <td style="width: 5%;">OFF</td> <td style="text-align: center;">■</td><td style="text-align: center;">■</td><td></td><td style="text-align: center;">■</td><td style="text-align: center;">■</td><td style="text-align: center;">■</td><td></td><td></td> </tr> </table> </td> <td>· SW502-2,3: OFF · SW502-4,5,6: ON</td> </tr> </tbody> </table>	SW No.	Dip switch	Operating details	SW500	<table border="1" style="width: 100%; border-collapse: collapse;"> <tr> <td style="width: 5%;">ON</td> <td style="width: 5%;">1</td><td style="width: 5%;">2</td><td style="width: 5%;">3</td><td style="width: 5%;">4</td><td style="width: 5%;">5</td><td style="width: 5%;">6</td><td style="width: 5%;">7</td><td style="width: 5%;">8</td> </tr> <tr> <td style="width: 5%;">OFF</td> <td></td><td></td><td></td><td></td><td></td><td style="text-align: center;">■</td><td></td><td style="text-align: center;">■</td> </tr> </table>	ON	1	2	3	4	5	6	7	8	OFF						■		■	· SW500-6,8: OFF	SW502	<table border="1" style="width: 100%; border-collapse: collapse;"> <tr> <td style="width: 5%;">ON</td> <td style="width: 5%;">1</td><td style="width: 5%;">2</td><td style="width: 5%;">3</td><td style="width: 5%;">4</td><td style="width: 5%;">5</td><td style="width: 5%;">6</td><td style="width: 5%;">7</td><td style="width: 5%;">8</td> </tr> <tr> <td style="width: 5%;">OFF</td> <td style="text-align: center;">■</td><td style="text-align: center;">■</td><td></td><td style="text-align: center;">■</td><td style="text-align: center;">■</td><td style="text-align: center;">■</td><td></td><td></td> </tr> </table>	ON	1	2	3	4	5	6	7	8	OFF	■	■		■	■	■			· SW502-2,3: OFF · SW502-4,5,6: ON
SW No.	Dip switch	Operating details																																												
SW500	<table border="1" style="width: 100%; border-collapse: collapse;"> <tr> <td style="width: 5%;">ON</td> <td style="width: 5%;">1</td><td style="width: 5%;">2</td><td style="width: 5%;">3</td><td style="width: 5%;">4</td><td style="width: 5%;">5</td><td style="width: 5%;">6</td><td style="width: 5%;">7</td><td style="width: 5%;">8</td> </tr> <tr> <td style="width: 5%;">OFF</td> <td></td><td></td><td></td><td></td><td></td><td style="text-align: center;">■</td><td></td><td style="text-align: center;">■</td> </tr> </table>	ON	1	2	3	4	5	6	7	8	OFF						■		■	· SW500-6,8: OFF																										
ON	1	2	3	4	5	6	7	8																																						
OFF						■		■																																						
SW502	<table border="1" style="width: 100%; border-collapse: collapse;"> <tr> <td style="width: 5%;">ON</td> <td style="width: 5%;">1</td><td style="width: 5%;">2</td><td style="width: 5%;">3</td><td style="width: 5%;">4</td><td style="width: 5%;">5</td><td style="width: 5%;">6</td><td style="width: 5%;">7</td><td style="width: 5%;">8</td> </tr> <tr> <td style="width: 5%;">OFF</td> <td style="text-align: center;">■</td><td style="text-align: center;">■</td><td></td><td style="text-align: center;">■</td><td style="text-align: center;">■</td><td style="text-align: center;">■</td><td></td><td></td> </tr> </table>	ON	1	2	3	4	5	6	7	8	OFF	■	■		■	■	■			· SW502-2,3: OFF · SW502-4,5,6: ON																										
ON	1	2	3	4	5	6	7	8																																						
OFF	■	■		■	■	■																																								
Specifications of communication cable	<ul style="list-style-type: none"> · Cable type a: Sheathed cable, size 0.3 mm² or more · Cable length a: Cable size is 0.3 mm²: 50 m or less / Cable size is 0.5 mm²: 100 m or less. 																																													
Note	<ul style="list-style-type: none"> · The operation of the paired remote controller prohibited by the coin timer is the ON/OFF operation only. Other operations, such as setting the temperature, are enabled. · When the interface is connected to the M-NET system, even though the coin timer prohibits the manual operation with the paired remote controller, the ON/OFF operation with the system controller is enabled. · When the interface is connected to the M-NET system, if the system controller prohibits the manual ON/OFF operation, the ON/OFF operation with the coin timer is prohibited. To enable the coin timer, do not disable the manual operation on the system controller. · When the group setting is made with the M-NET system or the MA remote controller, connect the coin timer to the interface with the lowest M-NET address or refrigerant address. The wireless remote controller cannot be used together. 																																													

(4) Coin timer connection (Switch will open after a coin is inserted.)

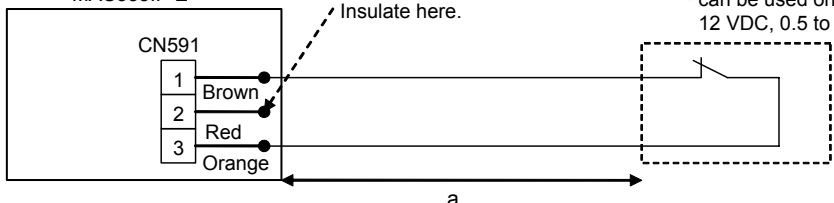
Function summary	Switch will open after insertion of a coin, which starts/stops the room air conditioner.																																																										
System configuration	<p>SYSTEM CONTROL Interface MAC333IF-E</p> 																																																										
Behavior	<ul style="list-style-type: none"> · When a coin is inserted (and the switch opens), the air conditioner starts and the ON/OFF operation from the paired remote controller is enabled. · When the timer expires (and the switch closes), the air conditioner stops and the ON/OFF operation from the paired remote controller is prohibited. <p>* "Paired remote controller" includes the wireless remote controller that comes with the room air conditioner, the MA remote controller, and the ME remote controller.</p>																																																										
Switch setting	<p>· Coin timer connection (Switch will open after insertion of a coin.)</p> <table border="1" data-bbox="236 689 1433 952"> <thead> <tr> <th>SW No.</th> <th>Dip switch</th> <th>Operating details</th> </tr> </thead> <tbody> <tr> <td>SW500</td> <td> <table border="1" data-bbox="363 757 622 840"> <tr><td>1</td><td>2</td><td>3</td><td>4</td><td>5</td><td>6</td><td>7</td><td>8</td></tr> <tr><td>ON</td><td></td><td></td><td></td><td></td><td></td><td></td><td></td></tr> <tr><td>OFF</td><td></td><td></td><td></td><td></td><td>■</td><td></td><td>■</td></tr> </table> </td> <td>· SW500-6,8: OFF</td> </tr> <tr> <td>SW502</td> <td> <table border="1" data-bbox="363 862 622 945"> <tr><td>1</td><td>2</td><td>3</td><td>4</td><td>5</td><td>6</td><td>7</td><td>8</td></tr> <tr><td>ON</td><td></td><td></td><td></td><td>■</td><td>■</td><td></td><td></td></tr> <tr><td>OFF</td><td>■</td><td>■</td><td>■</td><td></td><td></td><td></td><td></td></tr> </table> </td> <td> <ul style="list-style-type: none"> · SW502-2,3,4: OFF · SW502-5,6: ON </td> </tr> </tbody> </table>		SW No.	Dip switch	Operating details	SW500	<table border="1" data-bbox="363 757 622 840"> <tr><td>1</td><td>2</td><td>3</td><td>4</td><td>5</td><td>6</td><td>7</td><td>8</td></tr> <tr><td>ON</td><td></td><td></td><td></td><td></td><td></td><td></td><td></td></tr> <tr><td>OFF</td><td></td><td></td><td></td><td></td><td>■</td><td></td><td>■</td></tr> </table>	1	2	3	4	5	6	7	8	ON								OFF					■		■	· SW500-6,8: OFF	SW502	<table border="1" data-bbox="363 862 622 945"> <tr><td>1</td><td>2</td><td>3</td><td>4</td><td>5</td><td>6</td><td>7</td><td>8</td></tr> <tr><td>ON</td><td></td><td></td><td></td><td>■</td><td>■</td><td></td><td></td></tr> <tr><td>OFF</td><td>■</td><td>■</td><td>■</td><td></td><td></td><td></td><td></td></tr> </table>	1	2	3	4	5	6	7	8	ON				■	■			OFF	■	■	■					<ul style="list-style-type: none"> · SW502-2,3,4: OFF · SW502-5,6: ON
SW No.	Dip switch	Operating details																																																									
SW500	<table border="1" data-bbox="363 757 622 840"> <tr><td>1</td><td>2</td><td>3</td><td>4</td><td>5</td><td>6</td><td>7</td><td>8</td></tr> <tr><td>ON</td><td></td><td></td><td></td><td></td><td></td><td></td><td></td></tr> <tr><td>OFF</td><td></td><td></td><td></td><td></td><td>■</td><td></td><td>■</td></tr> </table>	1	2	3	4	5	6	7	8	ON								OFF					■		■	· SW500-6,8: OFF																																	
1	2	3	4	5	6	7	8																																																				
ON																																																											
OFF					■		■																																																				
SW502	<table border="1" data-bbox="363 862 622 945"> <tr><td>1</td><td>2</td><td>3</td><td>4</td><td>5</td><td>6</td><td>7</td><td>8</td></tr> <tr><td>ON</td><td></td><td></td><td></td><td>■</td><td>■</td><td></td><td></td></tr> <tr><td>OFF</td><td>■</td><td>■</td><td>■</td><td></td><td></td><td></td><td></td></tr> </table>	1	2	3	4	5	6	7	8	ON				■	■			OFF	■	■	■					<ul style="list-style-type: none"> · SW502-2,3,4: OFF · SW502-5,6: ON 																																	
1	2	3	4	5	6	7	8																																																				
ON				■	■																																																						
OFF	■	■	■																																																								
Specifications of communication cable	<ul style="list-style-type: none"> · Cable type a: Sheathed cable, size 0.3 mm² or more · Cable length a: Cable size is 0.3 mm²: 50 m or less / Cable size is 0.5 mm²: 100 m or less 																																																										
Note	<ul style="list-style-type: none"> · The operation of the paired remote controller prohibited by the coin timer is the ON/OFF operation only. Other operations, such as setting the temperature, are enabled. · When the interface is connected to the M-NET system, even though the coin timer prohibits the operation with the paired remote controller, the ON/OFF operation with the system controller is enabled. · When the interface is connected to the M-NET system, if the system controller prohibits the manual ON/OFF operation, the ON/OFF operation with the coin timer is prohibited. To enable the coin timer, do not disable the manual operation on the system controller. · When the group setting is made with the M-NET system or the MA remote controller, connect the coin timer to the interface with the lowest M-NET address or refrigerant address. The wireless remote controller cannot be used together. 																																																										

(5) Details of remote control (for giving priority to last operation performed by continuous contact switch)

Function summary	The operation can be started/stopped or enabled/disabled according to the last operation performed by continuous contact switches.																												
System configuration	<p>SYSTEM CONTROL Interface MAC-333IF-E</p>																												
Behavior	<ul style="list-style-type: none"> • Switch 1 <ul style="list-style-type: none"> · When it opens, the air conditioner stops. · When it closes, the air conditioner operates. • Switch 2 <ul style="list-style-type: none"> · When it opens, the ON/OFF operation with the paired remote controller is enabled. · When it closes, the ON/OFF operation with the paired remote controller is disabled. <p>* The system control interface will process the last command among those sent by switch 1, the paired remote controller, and the M-NET system controller. * "Paired remote controller" includes the wireless remote controller that comes with the room air conditioner, the MA remote controller, and the ME remote controller.</p>																												
Switch setting	<p>• Input mode (continuous contact) Make settings for the continuous contact switches.</p> <table border="1"> <thead> <tr> <th>SW No.</th> <th>Dip switch</th> <th>Operating details</th> </tr> </thead> <tbody> <tr> <td>SW500</td> <td> </td> <td>· SW500-6,8: OFF</td> </tr> <tr> <td>SW502</td> <td> </td> <td>· SW502-2,3: OFF</td> </tr> </tbody> </table> <p>• Input change Change the input logic.</p> <table border="1"> <thead> <tr> <th>SW No.</th> <th>Dip switch</th> <th>Operating details</th> </tr> </thead> <tbody> <tr> <td>SW502-4</td> <td> </td> <td> <ul style="list-style-type: none"> • OFF: It behaves as described in the "Behavior" section in this chart. • ON : <ul style="list-style-type: none"> • Switch 1 <ul style="list-style-type: none"> · When it opens, the air conditioner operates. · When it closes, the air conditioner stops. • Switch 2 <ul style="list-style-type: none"> · When it opens, the ON/OFF operation with the paired remote controller is disabled. · When it closes, the ON/OFF operation with the paired remote controller is enabled. </td> </tr> </tbody> </table> <p>• Behavior setting when the operation is prohibited by the contact switch The air conditioner can be stopped when the operation is prohibited by the contact switch.</p> <table border="1"> <thead> <tr> <th>SW No.</th> <th>Dip switch</th> <th>Operating details</th> </tr> </thead> <tbody> <tr> <td>SW502-5</td> <td> </td> <td> <ul style="list-style-type: none"> • OFF: <ul style="list-style-type: none"> • Switch 1* <ul style="list-style-type: none"> · It behaves as described in the "Behavior" section in this chart. • Switch 2* <ul style="list-style-type: none"> · When it opens, the ON/OFF operation with the paired remote controller is enabled. · When it closes, the ON/OFF operation with the paired remote controller is disabled, and the state of the air conditioner will not change. • ON: <ul style="list-style-type: none"> • Switch 1* <ul style="list-style-type: none"> · It behaves as described in the "Behavior" section in this chart. • Switch 2* <ul style="list-style-type: none"> · When it opens, the ON/OFF operation with the paired remote controller is enabled. · When it closes, the ON/OFF operation with the paired remote controller is disabled. The air conditioner stops. </td> </tr> </tbody> </table> <p>• Behavior setting when the operation prohibition is cancelled by the contact switch The air conditioner can be started to work when the operation prohibition is cancelled by the contact switch.</p> <table border="1"> <thead> <tr> <th>SW No.</th> <th>Dip switch</th> <th>Operating details</th> </tr> </thead> <tbody> <tr> <td>SW502-6</td> <td> </td> <td> <ul style="list-style-type: none"> • OFF: <ul style="list-style-type: none"> • Switch 1* <ul style="list-style-type: none"> · It behaves as described in the "Behavior" section in this chart. • Switch 2* <ul style="list-style-type: none"> · When it opens, the ON/OFF operation with the paired remote controller is enabled, and the state of the air conditioner will not change. · When it closes, the ON/OFF operation with the paired remote controller is prohibited. • ON: <ul style="list-style-type: none"> • Switch 1* <ul style="list-style-type: none"> · It behaves as described in the "Behavior" section in this chart. • Switch 2* <ul style="list-style-type: none"> · When it opens, the ON/OFF operation with the paired remote controller is enabled, and the air conditioner operates. · When it closes, the ON/OFF operation with the paired remote controller is prohibited. </td> </tr> </tbody> </table> <p>* The behavior described here occurs when the SW502-4 is OFF. When SW502-4 is ON, the behaviors when the switches open and close will come out the opposite.</p>		SW No.	Dip switch	Operating details	SW500		· SW500-6,8: OFF	SW502		· SW502-2,3: OFF	SW No.	Dip switch	Operating details	SW502-4		<ul style="list-style-type: none"> • OFF: It behaves as described in the "Behavior" section in this chart. • ON : <ul style="list-style-type: none"> • Switch 1 <ul style="list-style-type: none"> · When it opens, the air conditioner operates. · When it closes, the air conditioner stops. • Switch 2 <ul style="list-style-type: none"> · When it opens, the ON/OFF operation with the paired remote controller is disabled. · When it closes, the ON/OFF operation with the paired remote controller is enabled. 	SW No.	Dip switch	Operating details	SW502-5		<ul style="list-style-type: none"> • OFF: <ul style="list-style-type: none"> • Switch 1* <ul style="list-style-type: none"> · It behaves as described in the "Behavior" section in this chart. • Switch 2* <ul style="list-style-type: none"> · When it opens, the ON/OFF operation with the paired remote controller is enabled. · When it closes, the ON/OFF operation with the paired remote controller is disabled, and the state of the air conditioner will not change. • ON: <ul style="list-style-type: none"> • Switch 1* <ul style="list-style-type: none"> · It behaves as described in the "Behavior" section in this chart. • Switch 2* <ul style="list-style-type: none"> · When it opens, the ON/OFF operation with the paired remote controller is enabled. · When it closes, the ON/OFF operation with the paired remote controller is disabled. The air conditioner stops. 	SW No.	Dip switch	Operating details	SW502-6		<ul style="list-style-type: none"> • OFF: <ul style="list-style-type: none"> • Switch 1* <ul style="list-style-type: none"> · It behaves as described in the "Behavior" section in this chart. • Switch 2* <ul style="list-style-type: none"> · When it opens, the ON/OFF operation with the paired remote controller is enabled, and the state of the air conditioner will not change. · When it closes, the ON/OFF operation with the paired remote controller is prohibited. • ON: <ul style="list-style-type: none"> • Switch 1* <ul style="list-style-type: none"> · It behaves as described in the "Behavior" section in this chart. • Switch 2* <ul style="list-style-type: none"> · When it opens, the ON/OFF operation with the paired remote controller is enabled, and the air conditioner operates. · When it closes, the ON/OFF operation with the paired remote controller is prohibited.
SW No.	Dip switch	Operating details																											
SW500		· SW500-6,8: OFF																											
SW502		· SW502-2,3: OFF																											
SW No.	Dip switch	Operating details																											
SW502-4		<ul style="list-style-type: none"> • OFF: It behaves as described in the "Behavior" section in this chart. • ON : <ul style="list-style-type: none"> • Switch 1 <ul style="list-style-type: none"> · When it opens, the air conditioner operates. · When it closes, the air conditioner stops. • Switch 2 <ul style="list-style-type: none"> · When it opens, the ON/OFF operation with the paired remote controller is disabled. · When it closes, the ON/OFF operation with the paired remote controller is enabled. 																											
SW No.	Dip switch	Operating details																											
SW502-5		<ul style="list-style-type: none"> • OFF: <ul style="list-style-type: none"> • Switch 1* <ul style="list-style-type: none"> · It behaves as described in the "Behavior" section in this chart. • Switch 2* <ul style="list-style-type: none"> · When it opens, the ON/OFF operation with the paired remote controller is enabled. · When it closes, the ON/OFF operation with the paired remote controller is disabled, and the state of the air conditioner will not change. • ON: <ul style="list-style-type: none"> • Switch 1* <ul style="list-style-type: none"> · It behaves as described in the "Behavior" section in this chart. • Switch 2* <ul style="list-style-type: none"> · When it opens, the ON/OFF operation with the paired remote controller is enabled. · When it closes, the ON/OFF operation with the paired remote controller is disabled. The air conditioner stops. 																											
SW No.	Dip switch	Operating details																											
SW502-6		<ul style="list-style-type: none"> • OFF: <ul style="list-style-type: none"> • Switch 1* <ul style="list-style-type: none"> · It behaves as described in the "Behavior" section in this chart. • Switch 2* <ul style="list-style-type: none"> · When it opens, the ON/OFF operation with the paired remote controller is enabled, and the state of the air conditioner will not change. · When it closes, the ON/OFF operation with the paired remote controller is prohibited. • ON: <ul style="list-style-type: none"> • Switch 1* <ul style="list-style-type: none"> · It behaves as described in the "Behavior" section in this chart. • Switch 2* <ul style="list-style-type: none"> · When it opens, the ON/OFF operation with the paired remote controller is enabled, and the air conditioner operates. · When it closes, the ON/OFF operation with the paired remote controller is prohibited. 																											
Specifications of communication cable	<ul style="list-style-type: none"> • Cable type a: Sheathed cable, size 0.3 mm² or more • Cable length a: Cable size is 0.3 mm²: 50 m or less / Cable size is 0.5 mm²: 100 m or less 																												
Note	<ul style="list-style-type: none"> · The operation of the paired remote controller prohibited by the Switch 2 is the ON/OFF operation only. Other operations, such as setting the temperature, are enabled. · When the interface is connected to the M-NET system, even if Switch 2 prohibits the operation with the paired remote controller, the ON/OFF operation with the system controller is enabled. · When the interface is connected to the M-NET system, if the system controller prohibits the manual ON/OFF operation, the ON/OFF operation with the Switch 1 and 2 is prohibited. To enable the Switch 1 and 2, do not disable the manual operation prohibition on the system controller. · When the group setting is made with the M-NET system or the MA remote controller, connect Switch 1 and 2 to the interface with the lowest M-NET address or refrigerant address. The wireless remote controller cannot be used together. 																												

(6) Details of remote control (for giving priority to operation performed by continuous contact switch)

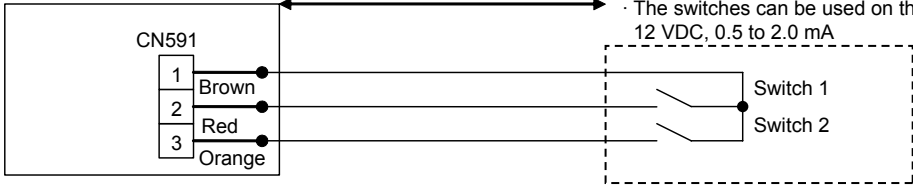
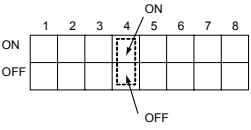
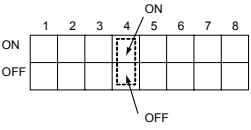
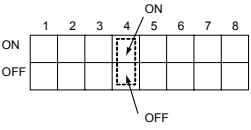
Function summary	The operation can be started/stopped or enabled/disabled according to the operation by continuous contact switches.																																																																																								
System configuration	<p>SYSTEM CONTROL Interface MAC333IF-E</p>  <p>· The switches can be used on the following condition: 12 VDC, 0.5 to 2.0 mA</p>																																																																																								
Behavior	<ul style="list-style-type: none"> · Switch 1 <ul style="list-style-type: none"> · When Switch 2 is closed, opening Switch 1 stops the air conditioner. · When Switch 2 is closed, closing Switch 1 operates the air conditioner. · Switch 2 <ul style="list-style-type: none"> · When it opens, the ON/OFF operation with the paired remote controller and the M-NET system controller is enabled, and the operation from Switch 1 is prohibited. · When it closes, the ON/OFF operation with the paired remote controller and the M-NET system controller is prohibited, and the operation from Switch 1 is enabled. <p>* "Paired remote controller" includes the wireless remote controller that comes with the room air conditioner, the MA remote controller, and the ME remote controller.</p>																																																																																								
Switch setting	<p>· Input mode (continuous contact) Make settings for the continuous contact switches.</p> <table border="1" data-bbox="240 763 1433 958"> <thead> <tr> <th>SW No.</th> <th>Dip switch</th> <th>Operating details</th> </tr> </thead> <tbody> <tr> <td>SW500</td> <td> <table border="1"> <tr><td>1</td><td>2</td><td>3</td><td>4</td><td>5</td><td>6</td><td>7</td><td>8</td></tr> <tr><td>ON</td><td></td><td></td><td></td><td></td><td></td><td></td><td></td></tr> <tr><td>OFF</td><td></td><td></td><td></td><td></td><td>■</td><td></td><td>■</td></tr> </table> </td> <td>· SW500-6,8: OFF</td> </tr> <tr> <td>SW502</td> <td> <table border="1"> <tr><td>1</td><td>2</td><td>3</td><td>4</td><td>5</td><td>6</td><td>7</td><td>8</td></tr> <tr><td>ON</td><td></td><td>■</td><td></td><td></td><td></td><td></td><td></td></tr> <tr><td>OFF</td><td>■</td><td></td><td></td><td></td><td></td><td></td><td></td></tr> </table> </td> <td>· SW502-2: OFF · SW502-3: ON</td> </tr> </tbody> </table> <p>· Input change Change the input logic.</p> <table border="1" data-bbox="240 1025 1433 1361"> <thead> <tr> <th>SW No.</th> <th>Dip switch</th> <th>Operating details</th> </tr> </thead> <tbody> <tr> <td>SW502-4</td> <td> <table border="1"> <tr><td>1</td><td>2</td><td>3</td><td>4</td><td>5</td><td>6</td><td>7</td><td>8</td></tr> <tr><td>ON</td><td></td><td></td><td></td><td></td><td></td><td></td><td></td></tr> <tr><td>OFF</td><td></td><td></td><td></td><td></td><td></td><td></td><td></td></tr> </table>  </td> <td> <ul style="list-style-type: none"> · OFF: <ul style="list-style-type: none"> · It behaves as described in the "Behavior" section in this chart. · ON: <ul style="list-style-type: none"> · Switch 1 <ul style="list-style-type: none"> · When Switch 2 is open, opening Switch 1 operates the air conditioner. · When Switch 2 is open, closing Switch 1 stops the air conditioner. · Switch 2 <ul style="list-style-type: none"> · When Switch 2 opens, the ON/OFF operation with the paired remote controller and the M-NET system controller is prohibited, and the operation from Switch 1 is enabled. · When Switch 2 closes, the ON/OFF operation with the paired remote controller and the M-NET system controller is enabled, and the operation from Switch 1 is prohibited. </td> </tr> </tbody> </table>		SW No.	Dip switch	Operating details	SW500	<table border="1"> <tr><td>1</td><td>2</td><td>3</td><td>4</td><td>5</td><td>6</td><td>7</td><td>8</td></tr> <tr><td>ON</td><td></td><td></td><td></td><td></td><td></td><td></td><td></td></tr> <tr><td>OFF</td><td></td><td></td><td></td><td></td><td>■</td><td></td><td>■</td></tr> </table>	1	2	3	4	5	6	7	8	ON								OFF					■		■	· SW500-6,8: OFF	SW502	<table border="1"> <tr><td>1</td><td>2</td><td>3</td><td>4</td><td>5</td><td>6</td><td>7</td><td>8</td></tr> <tr><td>ON</td><td></td><td>■</td><td></td><td></td><td></td><td></td><td></td></tr> <tr><td>OFF</td><td>■</td><td></td><td></td><td></td><td></td><td></td><td></td></tr> </table>	1	2	3	4	5	6	7	8	ON		■						OFF	■							· SW502-2: OFF · SW502-3: ON	SW No.	Dip switch	Operating details	SW502-4	<table border="1"> <tr><td>1</td><td>2</td><td>3</td><td>4</td><td>5</td><td>6</td><td>7</td><td>8</td></tr> <tr><td>ON</td><td></td><td></td><td></td><td></td><td></td><td></td><td></td></tr> <tr><td>OFF</td><td></td><td></td><td></td><td></td><td></td><td></td><td></td></tr> </table> 	1	2	3	4	5	6	7	8	ON								OFF								<ul style="list-style-type: none"> · OFF: <ul style="list-style-type: none"> · It behaves as described in the "Behavior" section in this chart. · ON: <ul style="list-style-type: none"> · Switch 1 <ul style="list-style-type: none"> · When Switch 2 is open, opening Switch 1 operates the air conditioner. · When Switch 2 is open, closing Switch 1 stops the air conditioner. · Switch 2 <ul style="list-style-type: none"> · When Switch 2 opens, the ON/OFF operation with the paired remote controller and the M-NET system controller is prohibited, and the operation from Switch 1 is enabled. · When Switch 2 closes, the ON/OFF operation with the paired remote controller and the M-NET system controller is enabled, and the operation from Switch 1 is prohibited.
SW No.	Dip switch	Operating details																																																																																							
SW500	<table border="1"> <tr><td>1</td><td>2</td><td>3</td><td>4</td><td>5</td><td>6</td><td>7</td><td>8</td></tr> <tr><td>ON</td><td></td><td></td><td></td><td></td><td></td><td></td><td></td></tr> <tr><td>OFF</td><td></td><td></td><td></td><td></td><td>■</td><td></td><td>■</td></tr> </table>	1	2	3	4	5	6	7	8	ON								OFF					■		■	· SW500-6,8: OFF																																																															
1	2	3	4	5	6	7	8																																																																																		
ON																																																																																									
OFF					■		■																																																																																		
SW502	<table border="1"> <tr><td>1</td><td>2</td><td>3</td><td>4</td><td>5</td><td>6</td><td>7</td><td>8</td></tr> <tr><td>ON</td><td></td><td>■</td><td></td><td></td><td></td><td></td><td></td></tr> <tr><td>OFF</td><td>■</td><td></td><td></td><td></td><td></td><td></td><td></td></tr> </table>	1	2	3	4	5	6	7	8	ON		■						OFF	■							· SW502-2: OFF · SW502-3: ON																																																															
1	2	3	4	5	6	7	8																																																																																		
ON		■																																																																																							
OFF	■																																																																																								
SW No.	Dip switch	Operating details																																																																																							
SW502-4	<table border="1"> <tr><td>1</td><td>2</td><td>3</td><td>4</td><td>5</td><td>6</td><td>7</td><td>8</td></tr> <tr><td>ON</td><td></td><td></td><td></td><td></td><td></td><td></td><td></td></tr> <tr><td>OFF</td><td></td><td></td><td></td><td></td><td></td><td></td><td></td></tr> </table> 	1	2	3	4	5	6	7	8	ON								OFF								<ul style="list-style-type: none"> · OFF: <ul style="list-style-type: none"> · It behaves as described in the "Behavior" section in this chart. · ON: <ul style="list-style-type: none"> · Switch 1 <ul style="list-style-type: none"> · When Switch 2 is open, opening Switch 1 operates the air conditioner. · When Switch 2 is open, closing Switch 1 stops the air conditioner. · Switch 2 <ul style="list-style-type: none"> · When Switch 2 opens, the ON/OFF operation with the paired remote controller and the M-NET system controller is prohibited, and the operation from Switch 1 is enabled. · When Switch 2 closes, the ON/OFF operation with the paired remote controller and the M-NET system controller is enabled, and the operation from Switch 1 is prohibited. 																																																															
1	2	3	4	5	6	7	8																																																																																		
ON																																																																																									
OFF																																																																																									
Specifications of communication cable	<ul style="list-style-type: none"> · Cable type a: Sheathed cable, size 0.3 mm² or more · Cable length a: Cable size is 0.3 mm²: 50 m or less / Cable size is 0.5 mm²: 100 m or less 																																																																																								
Note	<ul style="list-style-type: none"> · The operation of the paired remote controller prohibited by Switch 2 is the ON/OFF operation only. Other operations, such as setting the temperature, are enabled. · When the interface is connected to the M-NET system, if Switch 2 prohibits the operation with the paired remote controller, the ON/OFF operation with the system controller is disabled. · When the interface is connected to the M-NET system, even if the system controller prohibits the manual ON/OFF operation, the state of Switch 1, when the operation with Switch 2 is prohibited, is prioritized. To enable the Switch 1 and 2, do not disable the manual operation prohibition on the system controller. · When the group setting is made with the M-NET system or the MA remote controller, connect Switch 1 and 2 to the interface with the lowest M-NET address or refrigerant address. The wireless remote controller cannot be used together. 																																																																																								

(7) Details of remote control

(Operations using instantaneous contact switches: ON/OFF operation, disabling/enabling manual operation)

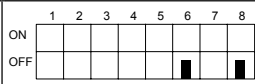
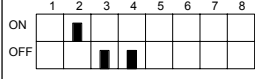
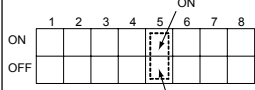
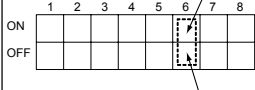
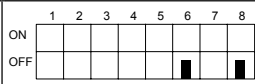
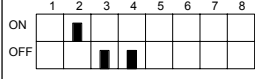
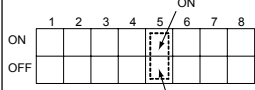
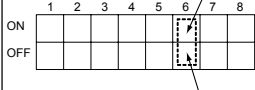
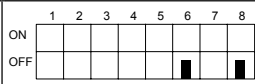
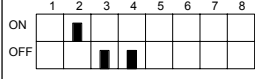
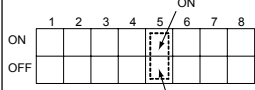
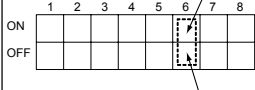
Function summary	Using instantaneous contact switches, operation can be switched between the ON/OFF and disabling/enabling the manual operation.																						
System configuration	<p>SYSTEM CONTROL Interface MAC333IF-E</p> 																						
Behavior	<ul style="list-style-type: none"> • Switch 1 <ul style="list-style-type: none"> · Every time it closes instantaneously, the air conditioner repeats ON and OFF operations. * The system control interface will process the last command among those sent by switch 1, the paired remote controller, and the M-NET system controller. • Switch 2 <ul style="list-style-type: none"> · Every time it closes instantaneously, the ON/OFF operation with the paired remote controller is disabled/enabled. <p>* “Paired remote controller” includes the wireless remote controller that comes with the room air conditioner, the MA remote controller, and the ME remote controller.</p>																						
Switch setting	<p>• Settings for the input mode and the input change Make settings for the inverted operation using instantaneous contact switches</p> <table border="1" data-bbox="316 763 1508 996"> <thead> <tr> <th>SW No.</th> <th>Dip switch</th> <th>Operating details</th> </tr> </thead> <tbody> <tr> <td>SW500</td> <td>  </td> <td>· SW500-6,8: OFF</td> </tr> <tr> <td>SW502</td> <td>  </td> <td>· SW502-2: ON · SW502-3,4: OFF</td> </tr> </tbody> </table> <p>• Behavior setting when the operation is prohibited by the contact switches The air conditioner can be stopped when the operation is prohibited by the contact switch.</p> <table border="1" data-bbox="316 1048 1508 1384"> <thead> <tr> <th>SW No.</th> <th>Dip switch</th> <th>Operating details</th> </tr> </thead> <tbody> <tr> <td>SW502-5</td> <td>  </td> <td> <ul style="list-style-type: none"> • OFF: <ul style="list-style-type: none"> • Switch 1 <ul style="list-style-type: none"> · It behaves as described in the “Behavior” section in this chart. • Switch 2 <ul style="list-style-type: none"> · When the ON/OFF operation with the paired remote controller is prohibited, the state of the air conditioner does not change. • ON: <ul style="list-style-type: none"> • Switch 1 <ul style="list-style-type: none"> · It behaves as described in the “Behavior” section in this chart. • Switch 2 <ul style="list-style-type: none"> · When the ON/OFF operation with the paired remote controller is prohibited, the air conditioner stops. </td> </tr> </tbody> </table> <p>• Behavior setting when the manual operation prohibition is cancelled The air conditioner can be started to work when the operation prohibition is cancelled by the contact switch.</p> <table border="1" data-bbox="316 1444 1508 1780"> <thead> <tr> <th>SW No.</th> <th>Dip switch</th> <th>Operating details</th> </tr> </thead> <tbody> <tr> <td>SW502-6</td> <td>  </td> <td> <ul style="list-style-type: none"> • OFF: <ul style="list-style-type: none"> • Switch 1 <ul style="list-style-type: none"> · It behaves as described in the “Behavior” section in this chart. • Switch 2 <ul style="list-style-type: none"> · When the ON/OFF operation with the paired remote controller is enabled, the state of the air conditioner does not change. • ON: <ul style="list-style-type: none"> • Switch 1 <ul style="list-style-type: none"> · It behaves as described in the “Behavior” section in this chart. • Switch 2 <ul style="list-style-type: none"> · When the ON/OFF operation with the paired remote controller is enabled, the air conditioner operates. </td> </tr> </tbody> </table>		SW No.	Dip switch	Operating details	SW500		· SW500-6,8: OFF	SW502		· SW502-2: ON · SW502-3,4: OFF	SW No.	Dip switch	Operating details	SW502-5		<ul style="list-style-type: none"> • OFF: <ul style="list-style-type: none"> • Switch 1 <ul style="list-style-type: none"> · It behaves as described in the “Behavior” section in this chart. • Switch 2 <ul style="list-style-type: none"> · When the ON/OFF operation with the paired remote controller is prohibited, the state of the air conditioner does not change. • ON: <ul style="list-style-type: none"> • Switch 1 <ul style="list-style-type: none"> · It behaves as described in the “Behavior” section in this chart. • Switch 2 <ul style="list-style-type: none"> · When the ON/OFF operation with the paired remote controller is prohibited, the air conditioner stops. 	SW No.	Dip switch	Operating details	SW502-6		<ul style="list-style-type: none"> • OFF: <ul style="list-style-type: none"> • Switch 1 <ul style="list-style-type: none"> · It behaves as described in the “Behavior” section in this chart. • Switch 2 <ul style="list-style-type: none"> · When the ON/OFF operation with the paired remote controller is enabled, the state of the air conditioner does not change. • ON: <ul style="list-style-type: none"> • Switch 1 <ul style="list-style-type: none"> · It behaves as described in the “Behavior” section in this chart. • Switch 2 <ul style="list-style-type: none"> · When the ON/OFF operation with the paired remote controller is enabled, the air conditioner operates.
SW No.	Dip switch	Operating details																					
SW500		· SW500-6,8: OFF																					
SW502		· SW502-2: ON · SW502-3,4: OFF																					
SW No.	Dip switch	Operating details																					
SW502-5		<ul style="list-style-type: none"> • OFF: <ul style="list-style-type: none"> • Switch 1 <ul style="list-style-type: none"> · It behaves as described in the “Behavior” section in this chart. • Switch 2 <ul style="list-style-type: none"> · When the ON/OFF operation with the paired remote controller is prohibited, the state of the air conditioner does not change. • ON: <ul style="list-style-type: none"> • Switch 1 <ul style="list-style-type: none"> · It behaves as described in the “Behavior” section in this chart. • Switch 2 <ul style="list-style-type: none"> · When the ON/OFF operation with the paired remote controller is prohibited, the air conditioner stops. 																					
SW No.	Dip switch	Operating details																					
SW502-6		<ul style="list-style-type: none"> • OFF: <ul style="list-style-type: none"> • Switch 1 <ul style="list-style-type: none"> · It behaves as described in the “Behavior” section in this chart. • Switch 2 <ul style="list-style-type: none"> · When the ON/OFF operation with the paired remote controller is enabled, the state of the air conditioner does not change. • ON: <ul style="list-style-type: none"> • Switch 1 <ul style="list-style-type: none"> · It behaves as described in the “Behavior” section in this chart. • Switch 2 <ul style="list-style-type: none"> · When the ON/OFF operation with the paired remote controller is enabled, the air conditioner operates. 																					
Specifications of communication cable	<ul style="list-style-type: none"> • Cable type a: Sheathed cable, size: 0.3 mm² or more • Cable length a: Cable size is 0.3 mm²: 50 m or less / Cable size is 0.5 mm²: 100 m or less 																						
Note	<ul style="list-style-type: none"> · The operation of the paired remote controller prohibited by Switch 2 is the ON/OFF operation only. Other operations, such as setting the temperature, are enabled. · Switch 1 and 2 operate when the input signal is 200 ms or more. They may not detect the signal of less than 200 ms. · When the interface is connected to the M-NET system, even if Switch 2 prohibits the operation with the paired remote controller, the ON/OFF operation from the system controller is enabled. · When the interface is connected to the M-NET system, if the system controller prohibits the manual ON/OFF operation, the ON/OFF operation with the Switch 1 and 2 is prohibited. To enable the Switch 1 and 2, do not disable the manual operation on the system controller. · When the group setting is made with the M-NET system or the MA remote controller, connect Switch 1 and 2 to the interface with the lowest M-NET address or refrigerant address. The wireless remote controller cannot be used together. 																						

(8) Details of remote control (ON/OFF operation with instantaneous contact)

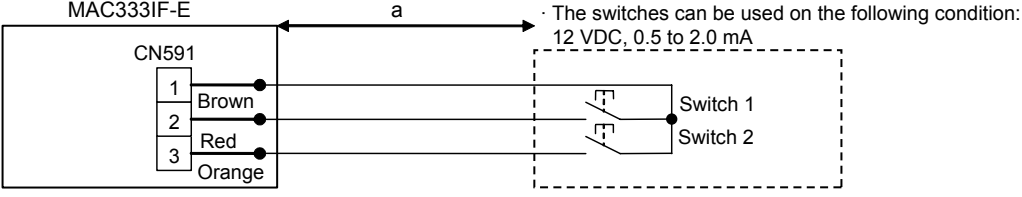



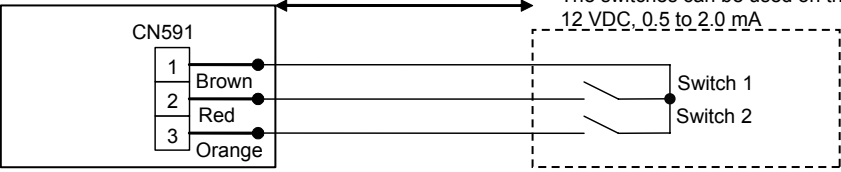

Function summary	Using instantaneous contact switches, the room air conditioner can be turned On and OFF.											
System configuration	<p>SYSTEM CONTROL Interface MAC333IF-E</p>  <p>· The switches can be used on the following condition: 12 VDC, 0.5 to 2.0 mA</p>											
Behavior	<ul style="list-style-type: none"> · Switch 1 <ul style="list-style-type: none"> · Every time it closes instantaneously, the air conditioner turns ON. (Unless other controllers are operated, regardless of how often it closes instantaneously, the air conditioner continues to be in operating state.) · Switch 2 <ul style="list-style-type: none"> · Every time it closes instantaneously, the air conditioner turns OFF. (Unless other controllers are operated, regardless of how often it closes instantaneously, the air conditioner continues to be in stopped state.) <p>* The system control interface will process the last command among those sent by Switch 1, Switch 2, the paired remote controller, and the M-NET system controller.</p>											
Switch setting	<ul style="list-style-type: none"> · Settings for the input mode and the input change · Set the state-fixed operation using instantaneous contact switches. <table border="1" data-bbox="236 745 1431 947"> <thead> <tr> <th>SW No.</th> <th>Dip switch</th> <th>Operating details</th> </tr> </thead> <tbody> <tr> <td rowspan="2">SW500</td> <td>ON</td> <td rowspan="2">· SW500-6,8: OFF</td> </tr> <tr> <td>OFF</td> </tr> <tr> <td rowspan="2">SW502</td> <td>ON</td> <td rowspan="2">· SW502-2,4: ON · SW502-3: OFF</td> </tr> <tr> <td>OFF</td> </tr> </tbody> </table>	SW No.	Dip switch	Operating details	SW500	ON	· SW500-6,8: OFF	OFF	SW502	ON	· SW502-2,4: ON · SW502-3: OFF	OFF
SW No.	Dip switch	Operating details										
SW500	ON	· SW500-6,8: OFF										
	OFF											
SW502	ON	· SW502-2,4: ON · SW502-3: OFF										
	OFF											
Specifications of communication cable	<ul style="list-style-type: none"> · Cable type a: Sheathed cable, size 0.3 mm² or more · Cable length a: Cable size is 0.3 mm²: 50 m or less / Cable size is 0.5 mm²: 100 m or less 											
Note	<ul style="list-style-type: none"> · The operation with the paired remote controller is always enabled. · Switch 1 and 2 operate when the input signal is 200 ms or more. They may not detect the signal of less than 200 ms. · When the interface is connected to the M-NET system, if the system controller prohibits the manual ON/OFF operation, the ON/OFF operation from the Switch 1 and 2 is prohibited. · When the group setting is made with the M-NET system or the MA remote controller, connect Switch 1 and 2 to the interface with the lowest M-NET address or refrigerant address. The wireless remote controller cannot be used together. 											

(9) Details of remote control (HEAT/COOL input)

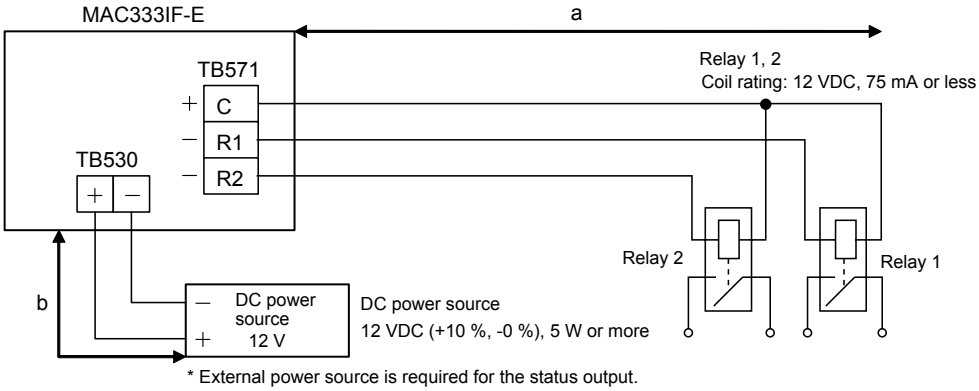
Function summary	The operation can be switched between ON/OFF and HEAT/COOL according to the last operation performed by continuous contact switches.																		
System configuration	<p>SYSTEM CONTROL Interface MAC333IF-E</p>  <p>The switches can be used on the following condition: 12 VDC, 0.5 to 2.0 mA</p>																		
Behavior	<ul style="list-style-type: none"> • Switch 1 <ul style="list-style-type: none"> · When it opens, the air conditioner stops. · When it closes, the air conditioner operates. • Switch 2 <ul style="list-style-type: none"> · When it opens, the air conditioner operates in the COOL mode. · When it closes, the air conditioner operates in the HEAT mode. <p>* The system control interface will process the last command among those sent by switch 1, the paired remote controller, and the M-NET system controller.</p> <p>* "Paired remote controller" includes the wireless remote controller that comes with the room air conditioner, the MA remote controller, and the ME remote controller.</p>																		
Switch setting	<p>• Input mode (continuous contact) Make settings for the continuous contact switches.</p> <table border="1" data-bbox="311 763 1505 965"> <thead> <tr> <th>SW No.</th> <th>Dip switch</th> <th>Operating details</th> </tr> </thead> <tbody> <tr> <td rowspan="2">SW500</td> <td>ON</td> <td rowspan="2"> <ul style="list-style-type: none"> · SW500-6: ON · SW500-8: OFF </td> </tr> <tr> <td>OFF</td> </tr> <tr> <td rowspan="2">SW502</td> <td>ON</td> <td rowspan="2"> <ul style="list-style-type: none"> · SW502-2,3,5,6: OFF </td> </tr> <tr> <td>OFF</td> </tr> </tbody> </table> <p>• Input change Change the input logic.</p> <table border="1" data-bbox="311 1014 1505 1301"> <thead> <tr> <th>SW No.</th> <th>Dip switch</th> <th>Operating details</th> </tr> </thead> <tbody> <tr> <td rowspan="2">SW502-4</td> <td>ON</td> <td rowspan="2"> <ul style="list-style-type: none"> • OFF: <ul style="list-style-type: none"> · It behaves as described in the "Behavior" section in this chart. • ON: <ul style="list-style-type: none"> • Switch 1 <ul style="list-style-type: none"> · When it opens, the air conditioner operates. · When it closes, the air conditioner stops. • Switch 2 <ul style="list-style-type: none"> · When it opens, the air conditioner operates in the HEAT mode. · When it closes, the air conditioner operates in the COOL mode. </td> </tr> <tr> <td>OFF</td> </tr> </tbody> </table>	SW No.	Dip switch	Operating details	SW500	ON	<ul style="list-style-type: none"> · SW500-6: ON · SW500-8: OFF 	OFF	SW502	ON	<ul style="list-style-type: none"> · SW502-2,3,5,6: OFF 	OFF	SW No.	Dip switch	Operating details	SW502-4	ON	<ul style="list-style-type: none"> • OFF: <ul style="list-style-type: none"> · It behaves as described in the "Behavior" section in this chart. • ON: <ul style="list-style-type: none"> • Switch 1 <ul style="list-style-type: none"> · When it opens, the air conditioner operates. · When it closes, the air conditioner stops. • Switch 2 <ul style="list-style-type: none"> · When it opens, the air conditioner operates in the HEAT mode. · When it closes, the air conditioner operates in the COOL mode. 	OFF
SW No.	Dip switch	Operating details																	
SW500	ON	<ul style="list-style-type: none"> · SW500-6: ON · SW500-8: OFF 																	
	OFF																		
SW502	ON	<ul style="list-style-type: none"> · SW502-2,3,5,6: OFF 																	
	OFF																		
SW No.	Dip switch	Operating details																	
SW502-4	ON	<ul style="list-style-type: none"> • OFF: <ul style="list-style-type: none"> · It behaves as described in the "Behavior" section in this chart. • ON: <ul style="list-style-type: none"> • Switch 1 <ul style="list-style-type: none"> · When it opens, the air conditioner operates. · When it closes, the air conditioner stops. • Switch 2 <ul style="list-style-type: none"> · When it opens, the air conditioner operates in the HEAT mode. · When it closes, the air conditioner operates in the COOL mode. 																	
	OFF																		
Specifications of communication cable	<ul style="list-style-type: none"> • Cable type a: Sheathed cable, size 0.3 mm² or more • Cable length a: Cable size is 0.3 mm²: 50 m or less / Cable size is 0.5 mm²: 100 m or less 																		
Note	<ul style="list-style-type: none"> · When the interface is connected to the M-NET system, if the system controller prohibits the manual ON/OFF operation, the ON/OFF operation from the Switch 1 is prohibited. · When the interface is connected to the M-NET system, if the system controller prohibits the manual mode operation, the HEAT/COOL operation from Switch 2 is prohibited. · When the group setting is made with the M-NET system or the MA remote controller, connect Switch 1 and 2 to the interface with the lowest M-NET address or refrigerant address. The wireless remote controller cannot be used together. 																		

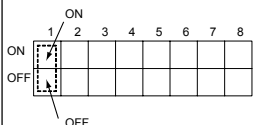
5.4 STATUS SIGNAL OUTPUT

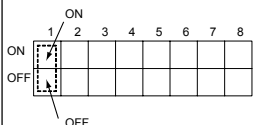
(1) Relay outputs of ON/OFF operation signal and normal/abnormal signal

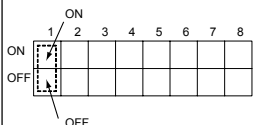
Function summary	ON/OFF signal and normal/abnormal signal of the room air conditioner can be output to the relay.													
System configuration														
Behavior	<ul style="list-style-type: none"> · Relay 1 <ul style="list-style-type: none"> · Relay 1 is ON when the air conditioner is on. · Relay 1 is OFF when the air conditioner is off. · Relay 2 <ul style="list-style-type: none"> · Relay 2 is ON when the air conditioner operates abnormally. · Relay 2 is OFF when the air conditioner operates normally. 													
Switch setting	<p>· Output settings Make settings for the outputs of ON/OFF and normal/abnormal.</p> <table border="1" data-bbox="244 1032 1441 1189"> <thead> <tr> <th>SW No.</th> <th>Dip switch</th> <th>Operating details</th> </tr> </thead> <tbody> <tr> <td>SW500</td> <td>  </td> <td>· SW500-4,5,8: OFF</td> </tr> </tbody> </table> <p>· Output change Change the output logic.</p> <table border="1" data-bbox="244 1272 1441 1597"> <thead> <tr> <th>SW No.</th> <th>Dip switch</th> <th>Operating details</th> </tr> </thead> <tbody> <tr> <td>SW502-1</td> <td>  </td> <td> <ul style="list-style-type: none"> · OFF: <ul style="list-style-type: none"> · It behaves as described in the "Behavior" section in this chart · ON: <ul style="list-style-type: none"> · Relay 1 <ul style="list-style-type: none"> · Relay 1 is OFF when the air conditioner is on. · Relay 1 is ON when the air conditioner is off. · Relay 2 <ul style="list-style-type: none"> · Relay 2 is OFF when the air conditioner operates abnormally. · Relay 2 is ON when the air conditioner operates normally. </td> </tr> </tbody> </table>		SW No.	Dip switch	Operating details	SW500		· SW500-4,5,8: OFF	SW No.	Dip switch	Operating details	SW502-1		<ul style="list-style-type: none"> · OFF: <ul style="list-style-type: none"> · It behaves as described in the "Behavior" section in this chart · ON: <ul style="list-style-type: none"> · Relay 1 <ul style="list-style-type: none"> · Relay 1 is OFF when the air conditioner is on. · Relay 1 is ON when the air conditioner is off. · Relay 2 <ul style="list-style-type: none"> · Relay 2 is OFF when the air conditioner operates abnormally. · Relay 2 is ON when the air conditioner operates normally.
SW No.	Dip switch	Operating details												
SW500		· SW500-4,5,8: OFF												
SW No.	Dip switch	Operating details												
SW502-1		<ul style="list-style-type: none"> · OFF: <ul style="list-style-type: none"> · It behaves as described in the "Behavior" section in this chart · ON: <ul style="list-style-type: none"> · Relay 1 <ul style="list-style-type: none"> · Relay 1 is OFF when the air conditioner is on. · Relay 1 is ON when the air conditioner is off. · Relay 2 <ul style="list-style-type: none"> · Relay 2 is OFF when the air conditioner operates abnormally. · Relay 2 is ON when the air conditioner operates normally. 												
Specifications of communication cable	<ul style="list-style-type: none"> · Cable type <ul style="list-style-type: none"> · a: Sheathed cable (Stranded cable), size 0.3 mm² to 1.25 mm² / Sheathed cable (Solid cable), ø0.4 mm to ø1.2 mm · b: Use the cable specified for the external power source. Its size must be from 0.3 mm² to 1.25 mm². · Cable length <ul style="list-style-type: none"> · a: Cable size is 0.3 mm²: 50 m or less / Cable size is 0.5 mm²: 100 m or less · b: Follow the requirement for the external power source. 													
Note	<ul style="list-style-type: none"> · External power source is required for the status output. · TB530 and TB571 have polarities, so check them before connection. · Do not connect DC power source to TB571. · When a relay with a built-in diode is used, take care to choose the correct polarity. TB571 C: + potential TB571 R1 and R2: - potential 													

(2) LED indications of ON/OFF operation signal and normal/abnormal signal

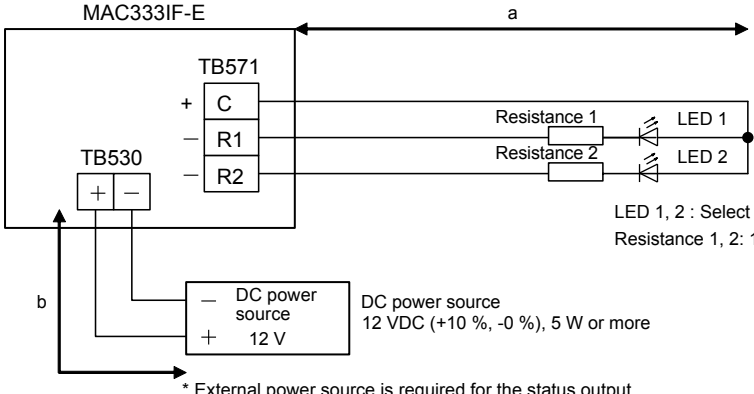
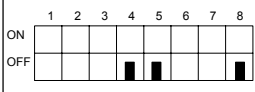
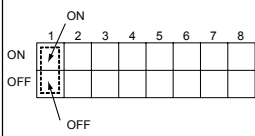
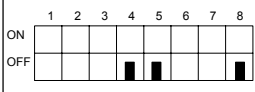
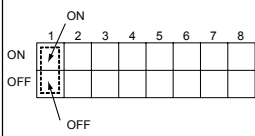
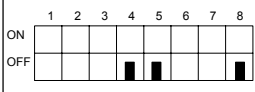
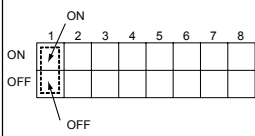
Function summary	ON/OFF signal and normal/abnormal signal of the room air conditioner can be indicated using LED.												
System configuration	<p>SYSTEM CONTROL interface MAC333IF-E</p>  <p>LED 1, 2 : Select LED which illuminates around 10 mA. Resistance 1, 2: 1.2 kΩ, 1/4 W</p> <p>DC power source 12 VDC (+10 %, -0 %), 5 W or more</p> <p>* External power source is required for the status output.</p>												
Behavior	<ul style="list-style-type: none"> · LED 1 <ul style="list-style-type: none"> · LED 1 is illuminated when the air conditioner is on. · LED 1 turns off when the air conditioner is off. · LED 2 <ul style="list-style-type: none"> · LED 2 is illuminated when the air conditioner operates abnormally. · LED 2 turns off when the air conditioner operates normally. 												
Switch setting	<ul style="list-style-type: none"> · Output setting Make settings for the outputs of ON/OFF and normal/abnormal. <table border="1" data-bbox="311 987 1511 1176"> <thead> <tr> <th>SW No.</th> <th>Dip switch</th> <th>Operating details</th> </tr> </thead> <tbody> <tr> <td>SW500</td> <td>  </td> <td>· SW500-4,5,8: OFF</td> </tr> </tbody> </table> <ul style="list-style-type: none"> · Output change Change the output logic. <table border="1" data-bbox="311 1243 1511 1579"> <thead> <tr> <th>SW No.</th> <th>Dip switch</th> <th>Operating details</th> </tr> </thead> <tbody> <tr> <td>SW502-1</td> <td>  </td> <td> <ul style="list-style-type: none"> · OFF: <ul style="list-style-type: none"> · It behaves as described in the "Behavior" section in this chart. · ON: <ul style="list-style-type: none"> · LED 1 <ul style="list-style-type: none"> · LED 1 turns off when the air conditioner is on. · LED 1 is illuminated when the air conditioner is off. · LED 2 <ul style="list-style-type: none"> · LED 2 turns off when the air conditioner operates abnormally. · LED 2 is illuminated when the air conditioner operates normally. </td> </tr> </tbody> </table>	SW No.	Dip switch	Operating details	SW500		· SW500-4,5,8: OFF	SW No.	Dip switch	Operating details	SW502-1		<ul style="list-style-type: none"> · OFF: <ul style="list-style-type: none"> · It behaves as described in the "Behavior" section in this chart. · ON: <ul style="list-style-type: none"> · LED 1 <ul style="list-style-type: none"> · LED 1 turns off when the air conditioner is on. · LED 1 is illuminated when the air conditioner is off. · LED 2 <ul style="list-style-type: none"> · LED 2 turns off when the air conditioner operates abnormally. · LED 2 is illuminated when the air conditioner operates normally.
SW No.	Dip switch	Operating details											
SW500		· SW500-4,5,8: OFF											
SW No.	Dip switch	Operating details											
SW502-1		<ul style="list-style-type: none"> · OFF: <ul style="list-style-type: none"> · It behaves as described in the "Behavior" section in this chart. · ON: <ul style="list-style-type: none"> · LED 1 <ul style="list-style-type: none"> · LED 1 turns off when the air conditioner is on. · LED 1 is illuminated when the air conditioner is off. · LED 2 <ul style="list-style-type: none"> · LED 2 turns off when the air conditioner operates abnormally. · LED 2 is illuminated when the air conditioner operates normally. 											
Specifications of communication cable	<ul style="list-style-type: none"> · Cable type <ul style="list-style-type: none"> · a: Sheathed cable (Stranded cable), size 0.3 mm² to 1.25 mm² / Sheathed cable (Solid cable), ø0.4 mm to ø1.2 mm · b: Use the cable specified for the external power source. Its size must be from 0.3 mm² to 1.25 mm². · Cable length <ul style="list-style-type: none"> · a: Cable size is 0.3 mm²: 50 m or less / Cable size is 0.5 mm²: 100 m or less · b: Follow the requirement for the external power source. 												
Note	<ul style="list-style-type: none"> · External power source is required for the status output. · TB530 and TB571 have polarities, so check them before connection. · Do not connect DC power source to TB571. 												







(3) Relay outputs of ON/OFF operation signal and heater control signal

Function summary	ON/OFF signal of the room air conditioner and heater control (ON/OFF) signal can be output to the relay.												
System configuration	<p>SYSTEM CONTROL interface MAC333IF-E</p> <p>* External power source is required for the status output and the control signal output.</p>												
Behavior	<ul style="list-style-type: none"> • Relay 1 <ul style="list-style-type: none"> • Relay 1 is ON when the air conditioner is on. • Relay 1 is OFF when the air conditioner is off. • Relay 2 <ul style="list-style-type: none"> • Relay 2 is ON when the conditions to operate the external heater are satisfied. Relay 2 remains ON until the condition for OFF are satisfied. (Conditions to operate the heater: The air conditioner is operating in the heating or the automatic heating mode, and the room temperature is 2.5 °C (4.5 °F) or less below the set temperature.) • Relay 2 is OFF when the conditions to stop the external heater are satisfied. (Conditions to stop the heater: The air conditioner is not operating or it is operating in a mode other than the heating or the automatic heating mode, or the room temperature is higher than the set temperature.) 												
Switch setting	<ul style="list-style-type: none"> • Output setting Make settings for the outputs of ON/OFF and external heater ON/OFF. <table border="1" data-bbox="231 974 1428 1115"> <thead> <tr> <th>SW No.</th> <th>Dip switch</th> <th>Operating details</th> </tr> </thead> <tbody> <tr> <td>SW500</td> <td> </td> <td> <ul style="list-style-type: none"> • SW500-4: ON • SW500-5,8: OFF </td> </tr> </tbody> </table> <ul style="list-style-type: none"> • Output change Change the output logic. <table border="1" data-bbox="231 1182 1428 1489"> <thead> <tr> <th>SW No.</th> <th>Dip switch</th> <th>Operating details</th> </tr> </thead> <tbody> <tr> <td>SW502</td> <td> </td> <td> <ul style="list-style-type: none"> • OFF: <ul style="list-style-type: none"> • It behaves as described in the “Behavior” section in this chart. • ON: <ul style="list-style-type: none"> • Relay 1 <ul style="list-style-type: none"> • Relay 1 is OFF when the air conditioner is on. • Relay 1 is ON when the air conditioner is off. • Relay 2 <ul style="list-style-type: none"> • Relay 2 is OFF when the conditions to operate the external heater are satisfied. • Relay 2 is ON when the conditions to stop the external heater are satisfied. </td> </tr> </tbody> </table>	SW No.	Dip switch	Operating details	SW500		<ul style="list-style-type: none"> • SW500-4: ON • SW500-5,8: OFF 	SW No.	Dip switch	Operating details	SW502		<ul style="list-style-type: none"> • OFF: <ul style="list-style-type: none"> • It behaves as described in the “Behavior” section in this chart. • ON: <ul style="list-style-type: none"> • Relay 1 <ul style="list-style-type: none"> • Relay 1 is OFF when the air conditioner is on. • Relay 1 is ON when the air conditioner is off. • Relay 2 <ul style="list-style-type: none"> • Relay 2 is OFF when the conditions to operate the external heater are satisfied. • Relay 2 is ON when the conditions to stop the external heater are satisfied.
SW No.	Dip switch	Operating details											
SW500		<ul style="list-style-type: none"> • SW500-4: ON • SW500-5,8: OFF 											
SW No.	Dip switch	Operating details											
SW502		<ul style="list-style-type: none"> • OFF: <ul style="list-style-type: none"> • It behaves as described in the “Behavior” section in this chart. • ON: <ul style="list-style-type: none"> • Relay 1 <ul style="list-style-type: none"> • Relay 1 is OFF when the air conditioner is on. • Relay 1 is ON when the air conditioner is off. • Relay 2 <ul style="list-style-type: none"> • Relay 2 is OFF when the conditions to operate the external heater are satisfied. • Relay 2 is ON when the conditions to stop the external heater are satisfied. 											
Specifications of communication cable	<ul style="list-style-type: none"> • Cable type <ul style="list-style-type: none"> • a: Sheathed cable (Stranded cable), size 0.3 mm² to 1.25 mm² / Sheathed cable (Solid cable), size ø0.4 mm to ø1.2 mm • b: Use the cable specified for the external power source. Its size must be from 0.3 mm² to 1.25 mm². • Cable length <ul style="list-style-type: none"> • a: Cable size is 0.3 mm²: 50 m or less / Cable size is 0.5 mm²: 100 m or less • b: Follow the requirement for the external power source. 												
Note	<ul style="list-style-type: none"> • External power source is required for the status output. • TB530 and TB571 have polarities, so check them before connection. • Do not connect DC power source to TB571. • When a relay with a built-in diode is used, take care to choose the correct polarity. TB571 C: + potential TB571 R1 and R2: - potential 												

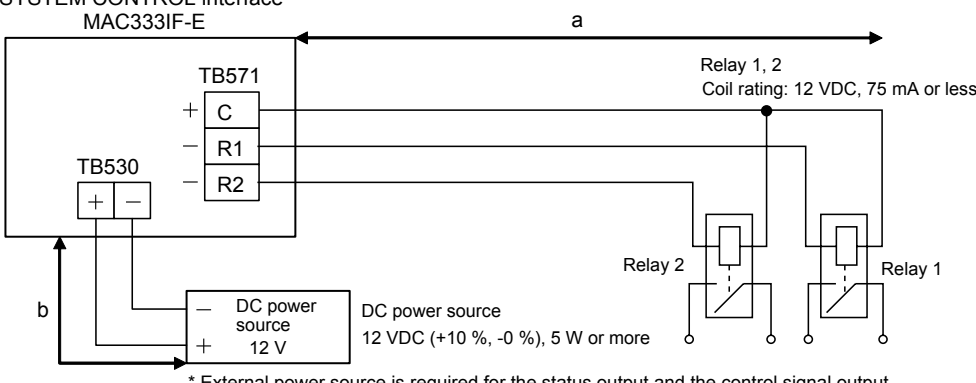
(4) Relay outputs of ON/OFF signal and humidifier control signal

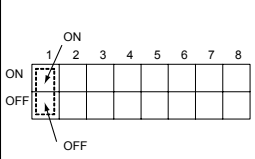
Function summary	<p>ON/OFF signal of the room air conditioner and humidifier control (ON/OFF) signal can be output to the relay.</p>												
System configuration	<p>SYSTEM CONTROL interface MAC333IF-E</p> <p>Relay 1, 2 Coil rating: 12 VDC, 75 mA or less</p> <p>DC power source 12 VDC (+10 %, -0 %), 5 W or more</p> <p>* External power source is required for the status output and the control signal output.</p>												
Behavior	<ul style="list-style-type: none"> • Relay 1 <ul style="list-style-type: none"> • Relay 1 is ON when the air conditioner is on. • Relay 1 is OFF when the air conditioner is off. • Relay 2 <ul style="list-style-type: none"> • Relay 2 is ON when the conditions to operate the external humidifier are satisfied. (Conditions to operate the humidifier: The air conditioner is operating in the heating or the automatic heating mode.) • Relay 2 is OFF when the conditions to stop the external humidifier are satisfied. (Conditions to stop the humidifier: The air conditioner is not operating or it is operating in a mode other than the heating or the automatic heating mode.) 												
Switch setting	<ul style="list-style-type: none"> • Output setting Make settings for outputs of ON/OFF and external humidifier <table border="1" data-bbox="308 949 1501 1093"> <thead> <tr> <th>SW No.</th> <th>Dip switch</th> <th>Operating details</th> </tr> </thead> <tbody> <tr> <td>SW500</td> <td> </td> <td> <ul style="list-style-type: none"> • SW500-5: ON • SW500-4,8: OFF </td> </tr> </tbody> </table> <ul style="list-style-type: none"> • Output change Change the output logic. <table border="1" data-bbox="308 1160 1501 1464"> <thead> <tr> <th>SW No.</th> <th>Dip switch</th> <th>Operating details</th> </tr> </thead> <tbody> <tr> <td>SW502</td> <td> </td> <td> <ul style="list-style-type: none"> • OFF: <ul style="list-style-type: none"> • It behaves as described in the "Behavior" section in this chart. • ON: <ul style="list-style-type: none"> • Relay 1 <ul style="list-style-type: none"> • Relay 1 is OFF when the air conditioner is on. • Relay 1 is ON when the air conditioner is off. • Relay 2 <ul style="list-style-type: none"> • Relay 2 is OFF when the conditions to operate the external humidifier are satisfied. • Relay 2 is ON when the conditions to stop the external humidifier are satisfied. </td> </tr> </tbody> </table>	SW No.	Dip switch	Operating details	SW500		<ul style="list-style-type: none"> • SW500-5: ON • SW500-4,8: OFF 	SW No.	Dip switch	Operating details	SW502		<ul style="list-style-type: none"> • OFF: <ul style="list-style-type: none"> • It behaves as described in the "Behavior" section in this chart. • ON: <ul style="list-style-type: none"> • Relay 1 <ul style="list-style-type: none"> • Relay 1 is OFF when the air conditioner is on. • Relay 1 is ON when the air conditioner is off. • Relay 2 <ul style="list-style-type: none"> • Relay 2 is OFF when the conditions to operate the external humidifier are satisfied. • Relay 2 is ON when the conditions to stop the external humidifier are satisfied.
SW No.	Dip switch	Operating details											
SW500		<ul style="list-style-type: none"> • SW500-5: ON • SW500-4,8: OFF 											
SW No.	Dip switch	Operating details											
SW502		<ul style="list-style-type: none"> • OFF: <ul style="list-style-type: none"> • It behaves as described in the "Behavior" section in this chart. • ON: <ul style="list-style-type: none"> • Relay 1 <ul style="list-style-type: none"> • Relay 1 is OFF when the air conditioner is on. • Relay 1 is ON when the air conditioner is off. • Relay 2 <ul style="list-style-type: none"> • Relay 2 is OFF when the conditions to operate the external humidifier are satisfied. • Relay 2 is ON when the conditions to stop the external humidifier are satisfied. 											
Specifications of communication cable	<ul style="list-style-type: none"> • Cable type <ul style="list-style-type: none"> • a: Sheathed cable (Stranded cable), size 0.3 mm² to 1.25 mm² / Sheathed cable (Solid cable), size ø0.4 mm to ø1.2 mm • b: Use the cable specified for the external power source. Its size must be from 0.3 mm² to 1.25 mm². • Cable length <ul style="list-style-type: none"> • a: Cable size is 0.3 mm²: 50 m or less / Cable size is 0.5 mm²: 100 m or less • b: Follow the requirement for the external power source. 												
Note	<ul style="list-style-type: none"> • External power source is required for the status output. • TB530 and TB571 have polarities, so check them before connection. • Do not connect DC power source to TB571. • When a relay with a built-in diode is used, take care to choose the correct polarity. TB571 C: + potential TB571 R1 and R2: - potential 												

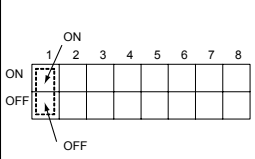
(5) Relay outputs of heater control signal and humidifier control signal

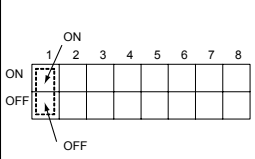
Function summary	Control (ON/OFF) signal of the external heater and the external humidifier can be output to the relay.													
System configuration	<p>SYSTEM CONTROL interface MAC333IF-E</p>  <p>* External power source is required for the status output and the control signal output.</p>													
Behavior	<ul style="list-style-type: none"> • Relay 1 <ul style="list-style-type: none"> • Relay 1 is ON when the conditions to operate the external heater are satisfied. Relay1 remains ON until the conditions for OFF are satisfied. (Conditions to operate the heater: The air conditioner is operating in the heating or the automatic heating mode, and the room temperature is 2.5 °C (4.5 °F) or less below the set temperature.) • Relay 1 is OFF when the conditions to stop the external heater are satisfied. (Conditions to stop the heater: The air conditioner is not operating or it is operating in a mode other than the heating or the automatic heating mode, or the room temperature is higher than the set temperature.) • Relay 2 <ul style="list-style-type: none"> • Relay 2 is ON when the conditions to operate the external humidifier are satisfied. (Conditions to operate the humidifier: The air conditioner is operating in the heating or the automatic heating mode.) • Relay 2 is OFF when the conditions to stop the external humidifier are satisfied. (Conditions to stop the humidifier: The air conditioner is not operating or it is operating in a mode other than the heating or the automatic heating mode.) 													
Switch setting	<ul style="list-style-type: none"> • Output setting Make settings for the output control signals of the heater and the humidifier. <table border="1" data-bbox="231 1030 1428 1176"> <thead> <tr> <th>SW No.</th> <th>Dip switch</th> <th>Operating details</th> </tr> </thead> <tbody> <tr> <td>SW500</td> <td>  </td> <td> <ul style="list-style-type: none"> • SW500-4,5: ON • SW500-8: OFF </td> </tr> </tbody> </table> <ul style="list-style-type: none"> • Output change Change the output logic. <table border="1" data-bbox="231 1243 1428 1556"> <thead> <tr> <th>SW No.</th> <th>Dip switch</th> <th>Operating details</th> </tr> </thead> <tbody> <tr> <td>SW502</td> <td>  </td> <td> <ul style="list-style-type: none"> • OFF: <ul style="list-style-type: none"> • It behaves as described in the “Behavior” section in this chart. • ON: <ul style="list-style-type: none"> • Relay 1 <ul style="list-style-type: none"> • Relay 1 is OFF when the conditions to operate the external heater are satisfied. • Relay 1 is ON when the conditions to stop the external heater are satisfied. • Relay 2 <ul style="list-style-type: none"> • Relay 2 is OFF when the conditions to operate the external humidifier are satisfied. • Relay 2 is ON when the conditions to stop the external humidifier are satisfied. </td> </tr> </tbody> </table>		SW No.	Dip switch	Operating details	SW500		<ul style="list-style-type: none"> • SW500-4,5: ON • SW500-8: OFF 	SW No.	Dip switch	Operating details	SW502		<ul style="list-style-type: none"> • OFF: <ul style="list-style-type: none"> • It behaves as described in the “Behavior” section in this chart. • ON: <ul style="list-style-type: none"> • Relay 1 <ul style="list-style-type: none"> • Relay 1 is OFF when the conditions to operate the external heater are satisfied. • Relay 1 is ON when the conditions to stop the external heater are satisfied. • Relay 2 <ul style="list-style-type: none"> • Relay 2 is OFF when the conditions to operate the external humidifier are satisfied. • Relay 2 is ON when the conditions to stop the external humidifier are satisfied.
SW No.	Dip switch	Operating details												
SW500		<ul style="list-style-type: none"> • SW500-4,5: ON • SW500-8: OFF 												
SW No.	Dip switch	Operating details												
SW502		<ul style="list-style-type: none"> • OFF: <ul style="list-style-type: none"> • It behaves as described in the “Behavior” section in this chart. • ON: <ul style="list-style-type: none"> • Relay 1 <ul style="list-style-type: none"> • Relay 1 is OFF when the conditions to operate the external heater are satisfied. • Relay 1 is ON when the conditions to stop the external heater are satisfied. • Relay 2 <ul style="list-style-type: none"> • Relay 2 is OFF when the conditions to operate the external humidifier are satisfied. • Relay 2 is ON when the conditions to stop the external humidifier are satisfied. 												
Specifications of communication cable	<ul style="list-style-type: none"> • Cable type <ul style="list-style-type: none"> • a: Sheathed cable (Stranded cable) size 0.3 mm² to 1.25 mm² / Sheathed cable (Solid cable) size ø0.4 mm to ø1.2 mm • b: Use the cable specified for the external power source. Its size must be from 0.3 mm² to 1.25 mm². • Cable length <ul style="list-style-type: none"> • a: Cable size is 0.3 mm²: 50 m or less / Cable size is 0.5 mm²: 100 m or less • b: Follow the requirement for the external power source. 													
Note	<ul style="list-style-type: none"> • External power source is required for the status output. • TB530 and TB571 have polarities, so check them before connection. • Do not connect DC power source to TB571. • When a relay with a built-in diode is used, take care to choose the correct polarity. • TB571 C: + potential • TB571 R1 and R2: - potential 													

5.5 ON/OFF CONTROL BY MAIN POWER SOURCE

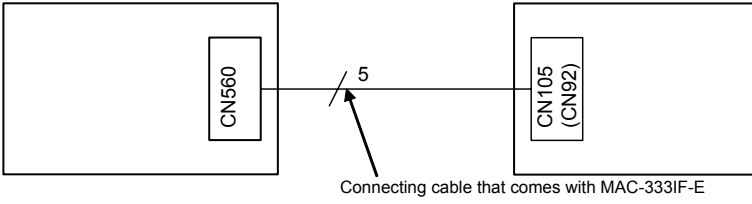
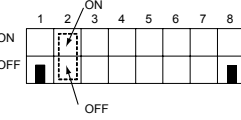
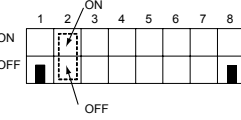
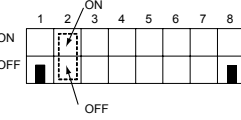
Function summary	The air conditioner turns on by its main power source being turned on.							
System configuration	<p>SYSTEM CONTROL interface MAC333IF-E</p>  <p>Indoor control board in the room air conditioner</p> <p>Connecting cable that comes with MAC-333IF-E</p>							
Behavior	The air conditioner turns on by its main power source being turned on.							
Switch setting	<p>· ON/OFF control by main power source Turning on the main power source turns on the air conditioner.</p> <table border="1" data-bbox="312 618 1509 853"> <thead> <tr> <th data-bbox="312 618 440 651">SW No.</th> <th data-bbox="445 618 703 651">Dip switch</th> <th data-bbox="708 618 1509 651">Operating details</th> </tr> </thead> <tbody> <tr> <td data-bbox="312 658 440 853">SW500-2</td> <td data-bbox="445 658 703 853">  </td> <td data-bbox="708 658 1509 853"> <ul style="list-style-type: none"> · OFF: <ul style="list-style-type: none"> · The air conditioner remains off when the main power is turned on. * When the "AUTO restart function" is enabled on the air conditioner, set this function to OFF on MAC-333IF-E, and the air conditioner operates according to the setting on the air conditioner. · ON: <ul style="list-style-type: none"> · The air conditioner turns on by its main power source being turned on. </td> </tr> </tbody> </table>		SW No.	Dip switch	Operating details	SW500-2		<ul style="list-style-type: none"> · OFF: <ul style="list-style-type: none"> · The air conditioner remains off when the main power is turned on. * When the "AUTO restart function" is enabled on the air conditioner, set this function to OFF on MAC-333IF-E, and the air conditioner operates according to the setting on the air conditioner. · ON: <ul style="list-style-type: none"> · The air conditioner turns on by its main power source being turned on.
SW No.	Dip switch	Operating details						
SW500-2		<ul style="list-style-type: none"> · OFF: <ul style="list-style-type: none"> · The air conditioner remains off when the main power is turned on. * When the "AUTO restart function" is enabled on the air conditioner, set this function to OFF on MAC-333IF-E, and the air conditioner operates according to the setting on the air conditioner. · ON: <ul style="list-style-type: none"> · The air conditioner turns on by its main power source being turned on. 						
Note	<ul style="list-style-type: none"> · The ON/OFF control by main power source is disabled when an indoor unit is connected to the MXZ-series outdoor unit. · Set up the system to prevent two or more room air conditioners from recovering simultaneously when starting the air conditioners using the ON/OFF control by main power source. (To avoid inrush current, start the operation sequentially) · This function cannot be used when the "Auto restart function" is enabled on the room air conditioner. · When using the air conditioner for the first time, set it to the desired operational status with the paired remote controller. (Run the air conditioner for 30 seconds or more.) The following operational status information will be stored: ON/OFF, operation mode, set temperature, air direction, and air speed. · When using the air conditioner that was not used for a long time, it is recommended to set it to the desired operational status again with the remote controller. 							

6 IMPORTANT NOTE

(1) Difference between display and operation

This Interface unit operates M-series air conditioner using the controls of City multi-series or P-series air conditioner, but there are several limitations as a result of the functional differences between M-series and City multi-series/P-series.

- ① When operating the system using the system controller, the MA remote controller, or the ME remote controller, details of those operations will not appear on the display of the wireless remote controller.
- ② The temperature range of the room air conditioner is broader than that on the system controller, the MA remote controller, or the ME remote controller. When the room air conditioners is set to lower than 17 °C (63 °F) or higher than 30 °C (87 °F), the temperature display on the the system controller, the MA remote controller, or the ME remote controller will show the minimum or maximum temperature that can be set. (For example, even if the room air conditioner is set to cool a room to 16 °C (61 °F) , the display on the system controller, MA remote controller, or the ME remote controller may read "17 °C (63 °F)".)
- ③ When the DRY mode is set with the wireless remote controller, the room air conditioner automatically set the optimum target temperature. The MA remote controller, the ME remote controller, or the system controller will display the target temperature as a set temperature.
- ④ When the DRY mode is set with the MA remote controller, the ME remote controller, or the system controller, the room air conditioner performs the DRY mode control operation according to the temperature set with the MA remote controller, the ME remote controller, or the system controller.
- ⑤ Indoor temperature display may be slightly different between the room air conditioner, the MA remote controller, the ME remote controller, and the system controller because of the differences in the timing of update process and in processing method of the indoor temperature information.

(2) Timer operation

- ① Timer operation should be set using only one controller from the remote controller that comes with the room air conditioner, the system controller, the MA remote controller, or the ME remote controller. If more than one controller is used to set the timer at the same time, the timer will not function properly.
- ② When the timer is set with the wireless remote controller; the MA remote controller, the ME remote controller, or the system controller will not show the timer display.
- ③ The timer set with the MA remote controller, the ME remote controller, or the system controller will not be cancelled with the wireless remote controller.

(3) Manual operation prohibition

- ① When the manual operation (ON/OFF, set temperature, or operation mode) is prohibited with the system controller, the command to perform the prohibited operation will not be accepted from the wireless remote controller that comes with the room air conditioner. The operation partially enabled by the system controller can be operated with the wireless remote controller. Regardless of whether the operation is disabled or enabled, three short beeps will sound when the signal is sent from the wireless remote controller.

(4) Trouble

- ① If the MA remote controller, the ME remote controller, or the system controller shows the abnormal indication, clear it by stopping the operation with one of the followings: the MA remote controller, the ME remote controller, the system controller, or the wireless remote controller.
(Abnormal indication of the air conditioner could be recovered automatically, but that of the MA remote controller, the ME remote controller, or the system controller cannot be recovered unless the operation is stopped.)
- ② If the main power to the power supply unit for M-NET system is lost because of construction work or the like, the air conditioner connected to the interface will not stop but continue the operation.

(5) Group operation

- ① When several air conditioners are set in the same group using the M-NET system controller, the wireless remote controller cannot be used. To use the wireless remote controller, do not make the group setting. (The signal from the wireless remote controller will not be transmitted to the other air conditioners, so the group operation will not be performed.)
- ② When several air conditioners are set in the same group using the M-NET system controller, and the MA remote controller is used together; setting for the group operation on the MA remote controller is also necessary.
- ③ When several air conditioners are set in the same group using the M-NET system controller, P-series and City multi-series can not be included in the group.
- ④ MAC-399IF-E and MAC-333IF-E can be set in the same group using the M-NET system controller, but the MA remote controller and the wireless remote controller cannot be used on MAC-333IF-E.

MEMO

A series of horizontal dotted lines for writing.

SYSTEM CONTROL INTERFACE

Model **MAC-333IF-E**

TECHNICAL MANUAL

